

de

**Sichere Diagnose. Zeitsparende Reparatur. Bosch-Diagnostics und Ersatzteile.**

Aus einer Hand: Diagnostics, Teile und Services. Bosch bietet der Werkstatt ein Komplettprogramm zur Steigerung von Effizienz und Qualität in der täglichen Arbeit. Vom weltweit aktiven Entwickler und führenden Hersteller von Kfz-Systemteilen in bekannter Original-Qualität. Kompetenz und Qualität – für die Zukunft Ihrer Werkstatt.

en

**Reliable diagnosis. Time-saving repairs. Bosch diagnostics and service parts.**

From a single source: Diagnostics, parts and services. Bosch has a complete program available which increases efficiency and quality in the workshop's daily work. The service parts from the globally active development expert and leading manufacturer of automotive system technology are in renowned Bosch OE quality. Competence and quality: Assuring your workshop's future success.

fr

**Diagnostic fiable. Réparation rapide. Diagnostics et pièces de rechange Bosch.**

À partir d'une source unique: diagnostic, pièces et services. Bosch propose aux réparateurs une gamme complète qui améliore au quotidien l'efficacité et la qualité du travail. En tant que concepteur présent dans le monde entier et leader dans la fabrication de systèmes pour automobiles, ses pièces de rechange sont reconnues pour offrir la qualité des pièces d'origine.

it

**Diagnosi sicure. Riparazioni rapide. Diagnostica, ricambi e formazione: tutto da un unico fornitore.**

Tutto da un unico fornitore: diagnostics, componenti e service. Bosch offre all'officina un programma completo per migliorare l'efficienza e la qualità nel lavoro quotidiano. Lo sviluppatore attivo a livello mondiale e costruttore leader di sistemi automobilistici offre ricambi di comprovata qualità originale. Competenza e qualità, quindi, per il futuro dell'officina.

es

**Diagnóstico seguro. Ahorro de tiempo en la reparación. Diagnosis Bosch y piezas de recambio.**

De un solo proveedor: diagnósticos, repuestos y servicios. Bosch ofrece al taller un programa completo para incrementar la eficiencia y la calidad del trabajo diario. De activos desarrolladores de todo el mundo y fabricantes de sistemas técnicos para el automóvil proceden los repuestos en la conocida calidad original. Competencia y calidad para el futuro de su taller.

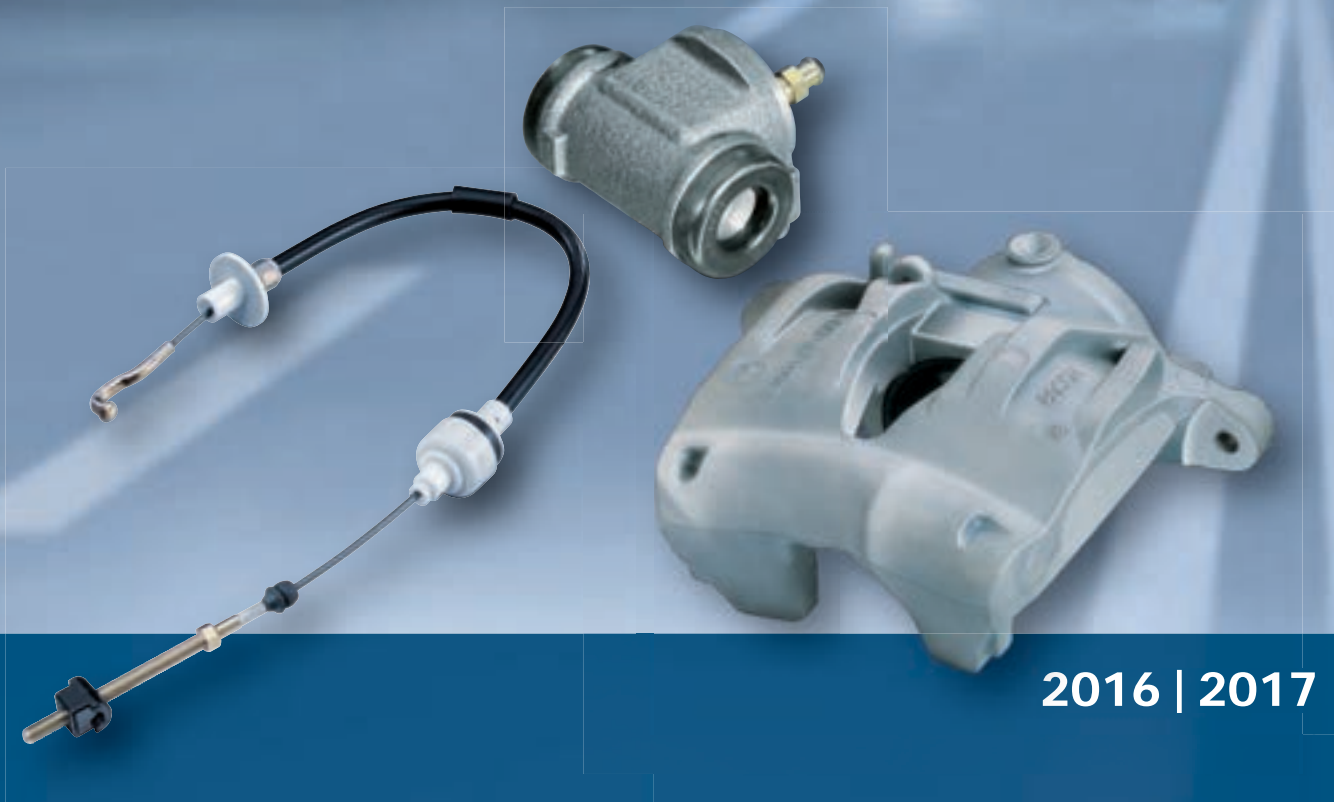

2016 | 2017



**Bosch parts fast and easy on:**  
[www.bosch-automotive-catalog.com](http://www.bosch-automotive-catalog.com)

2016 | 2017



**BOSCH**

☎ 1 987 720 411/201511

AA/MK12 – 11.2015 – Int

© 2015 Robert Bosch GmbH  
Automotive Aftermarket  
Postfach 41 09 60  
76225 Karlsruhe

Token fee: € 10,00

[www.bosch.de/aa](http://www.bosch.de/aa)

Editorial closing: 15. 09. 2015  
Subject to change without notice. Please direct questions and comments to our Authorized Representative in your country. This edition supersedes all previous editions.



**BOSCH**



**BOSCH**



# Inhalt / Contents / Sommaire / Indice / Índice Inhoud / Innehåll / Conteúdo Obsah / Содержание

Angebot / Offer / Offre / Offerta / Oferta  
Assortiment / Utbud / Proposta / Nabídka / Предложение

A2



A26



A38/45



A67



A90



Verwendung / Applications / Affectation / Impiego / Aplicación  
Toepassing / Användning / Utilização / Použití / Применение

B2





#### Häufigste Bauart: Faustsattel

Dieser Bremsattel wandelt den hydraulischen Druck um und erzeugt damit die Anpresskraft der Bremsbeläge an die Scheiben. In einem beweglich gelagerten Gehäuse presst der Kolben dabei den inneren Bremsbelag direkt auf die Scheibe. Die erzeugte Reaktionskraft verschiebt das Gehäuse und drückt indirekt auch den äußeren Belag gegen die Scheibe. An der Hinterachse wird häufig eine Faustsattelbremse mit integrierter Feststellbremse eingesetzt.

#### Most common design: Floating caliper

This brake caliper converts the hydraulic pressure and so generates the press force of the brake pads on the disks. Inside a flexibly mounted housing, the piston presses the inner brake pad directly onto the disk. The reaction force generated moves the housing and also indirectly presses the outer pad against the disk. A floating caliper with integrated parking brake is often used on the rear axle.

#### Type le plus fréquent: Etrier flottant

Cet étrier de frein convertit la pression hydraulique et produit la force de pression des garnitures de frein sur les disques. A l'intérieur d'un boîtier mobile, le piston pousse la garniture de frein intérieure directement contre le disque. La force de réaction produite déplace le boîtier et pousse indirectement la garniture extérieure également contre le disque. On utilise très souvent sur l'essieu arrière un frein à étrier flottant avec frein de stationnement intégré.

#### Tipo costruttivo più frequente: Pinza flottante

Questa pinza freno trasforma la pressione idraulica e genera in questo modo la forza di spinta delle pastiglie contro i dischi. All'interno di una scatola a supporto mobile il pistone spinge la pastiglia interna del freno direttamente sul disco. La forza di reazione generata sposta la scatola e spinge indirettamente anche la pastiglia esterna contro il disco. Sull'assale posteriore viene frequentemente impiegato un freno a pinza flottante con freno di stazionamento integrato.

#### Tipo de ejecución más frecuente Pinza flotante

Esta pinza de freno transforma la presión hidráulica y genera así la fuerza de apriete de las pastillas de freno en los discos. En una carcasa alojada en forma móvil, el émbolo apreta en ello la pastilla de freno interior directamente sobre el disco. La fuerza de reacción generada, desplaza la carcasa y apreta indirectamente también la pastilla exterior contra el disco. En el eje trasero se aplica frecuentemente un freno de pinza flotante con freno de estacionamiento integrado.

#### Bremsattel mit integrierter Feststellbremse

- ① Betätigung Handbremse
- ② Bremsattelgehäuse
- ③ Nachstelleinheit für Handbremsbetätigung
- ④ Kolben
- ⑤ Kolbendichtung
- ⑥ Staubschutzmanschette

#### Brake caliper with integrated parking brake

- ① Handbrake operation
- ② Brake-caliper housing
- ③ Adjuster unit for handbrake operation
- ④ Piston
- ⑤ Piston seal
- ⑥ Dust-guard sleeve

#### Etrier de frein avec frein de stationnement intégré

- ① Commande du frein à main
- ② Boîtier de l'étrier de frein
- ③ Unité de rattrapage du jeu de la commande du frein à main
- ④ Piston
- ⑤ Joint de piston
- ⑥ Pare-poussière

#### Pinza freno con freno di stazionamento integrato

- ① Azionamento freno a mano
- ② Scatola pinza freno
- ③ Unità di regolazione per azionamento freno a mano
- ④ Pistoncino
- ⑤ Guarnizione del pistoncino
- ⑥ Cuffia parapolvere

#### Pinza de freno con freno de estacionamiento integrado

- ① Accionamiento del freno
- ② Carcasa de la pinza de freno
- ③ Unidad de reajuste para el accionamiento de freno de mano
- ④ Émbolo
- ⑤ Junta de émbolo
- ⑥ Guardapolvo

nl

## Zwevend remzadel van schijfrem

sv

## Gaffelok

pt

## Pinça flutuante

cs

## Plovoucí třmen

ru

## Плавающий суппорт

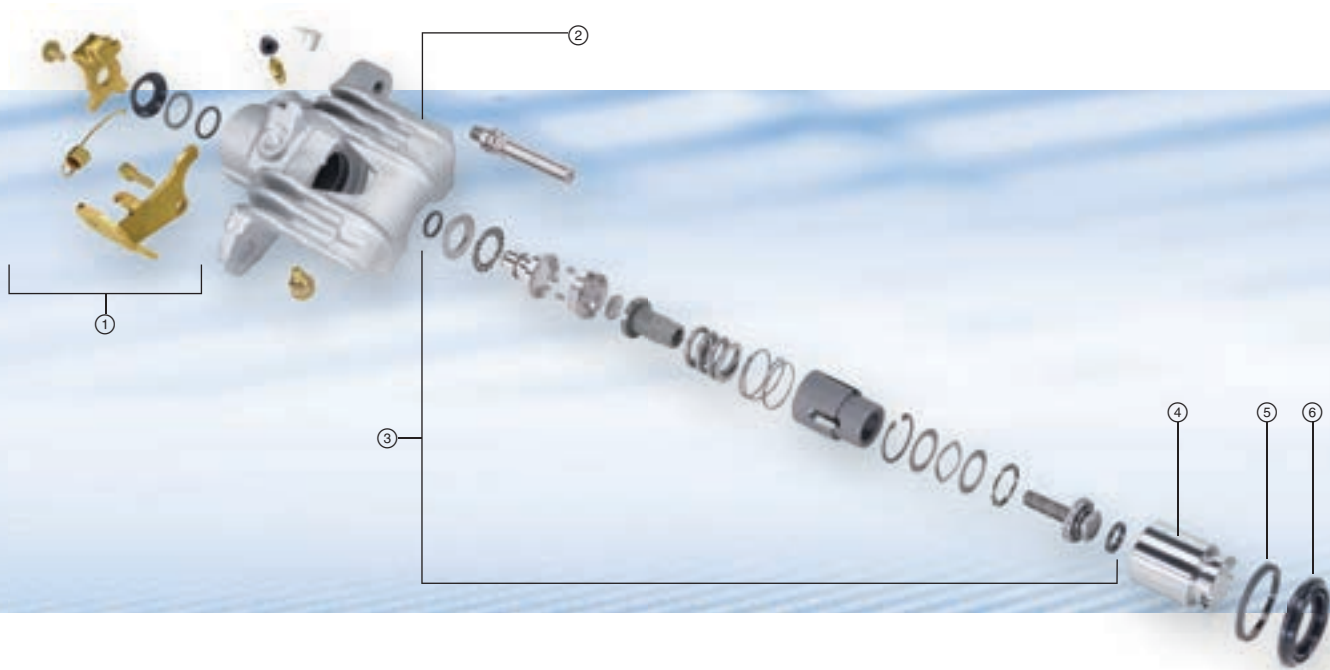

### Meest voorkomende bouwwijze: Zwevend remzadel van schijfrem

Dit remzadel verandert de hydraulische druk en genereert hiermee de aandrukkracht van de remvoeringen tegen de schijven. In een flexibel gelagerde behuizing perst de zuiger daarbij de inwendige remvoering rechtstreeks op de schijf. De gegenereerde reactiekracht verschuift de behuizing en drukt indirect ook de uitwendige remvoering tegen de schijf. Op de achteras wordt vaak een schijfrem met zwevend remzadel met geïntegreerde parkeerrem gebruikt.

### Remzadel met geïntegreerde parkeerrem

- ① Bediening van de parkeerrem
- ② Remzadelhuis
- ③ Afsteleenheid voor parkeerrembediening
- ④ Zuiger
- ⑤ Zuigerafdichting
- ⑥ Manchet voor stofbescherming

### Oftast förekommande konstruktion: Gaffelok

Detta bromsok omvandlar det hydrauliska trycket och alstrar bromsbeläggens anliggningskraft mot skivorna. I ett rörligt lagrat hus pressar kolven det inre bromsbelägget direkt mot skivan. Den alstrade reaktionskraften förskjuter huset och trycker indirekt även det yttre belägget mot skivan. På bakaxeln används ofta ett gaffelok med integrerad parkeringsbroms.

### Bromsok med integrerad parkeringsbroms

- ① Manövrering av handbroms
- ② Bromsokshus
- ③ Justerenhet för handbromsmanövrering
- ④ Kolvar
- ⑤ Kolvtätning
- ⑥ Dammskyddsschett

### Modelo mais comum: Pinça flutuante

Esta pinça do travão converte a pressão hidráulica, gerando, dessa forma, a força de pressão das pastilhas do travão nos discos. O pistão aperta a pastilha interior do travão directamente contra o disco numa carcaça com apoio móvel. A força de reacção gerada empurra a carcaça e também pressiona, de forma indirecta, a pastilha exterior contra o disco. No eixo traseiro, é usado com frequência um travão com pinça flutuante e travão de mão integrado.

### Pinça do travão com travão de mão integrado

- ① Accionamento do travão de mão
- ② Carcaça da pinça do travão
- ③ Afinador do accionamento do travão de mão
- ④ Pistão
- ⑤ Junta do pistão
- ⑥ Gaxeta guarda-pó

### Nejčastější konstrukce: Plovoucí třmen

Tento třmen brzdy převádí hydraulický tlak a vytváří přítlačnou sílu brzdových obložení ke kotoučům. U pohyblivě uloženého tělesa přímo přitlačuje píst vnitřní brzdové obložení přímo ke kotouči. Vytvořená síla reakce posunuje těleso a nepřímo přitlačuje ke kotouči také vnější obložení. Na zadní nápravě se často používá brzda s plovoucím třmenem s integrovanou parkovací brzdou.

### Třmen brzdy s integrovanou parkovací brzdou

- ① Aktivace ruční brzdy
- ② Těleso třmenu brzdy
- ③ Seřizovací jednotka pro aktivaci ruční brzdy
- ④ Píst
- ⑤ Těsnění pístu
- ⑥ Protiprachová manžeta

### Наиболее часто используемая конструкция: плавающий суппорт

Этот суппорт преобразует гидравлическое давление и создает тем самым усилие прижима тормозных накладок к диску. В подвижном корпусе поршень при этом прижимает внутреннюю тормозную накладку непосредственно к диску. Возникающее противоусилие перемещает корпус и прижимает также наружную тормозную накладку к диску. На заднем мосту часто используется дисковый тормоз с плавающим суппортом и интегрированным стояночным тормозом.

### Суппорт дискового тормоза с интегрированным стояночным тормозом

- ① Элементы управления ручным тормозом
- ② Корпус суппорта дискового тормоза
- ③ Узел регулировки элементов управления ручным тормозом
- ④ Поршень
- ⑤ Уплотнение поршня
- ⑥ Пылезащитная манжета

de

**Tandem-  
Hauptzylinder**

en

**Tandem  
master cylinder**

fr

**Maitre-cylindre  
tandem**

it

**Cilindro maestro  
a tandem**

es

**Cilindro principal  
tándem**

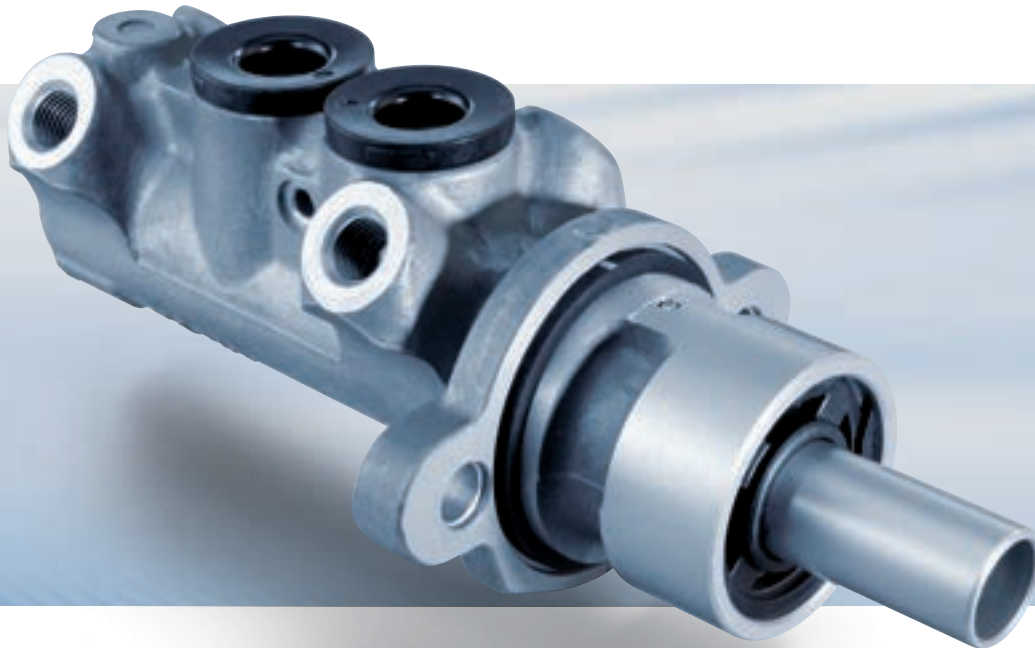

**Volle Bremskraft auf  
lange Sicht**

Der Hauptzylinder wandelt den Druck auf das Bremspedal in hydraulischen Druck für zwei getrennte Bremskreise.

**Full braking force over  
the long term**

The master cylinder converts the pressure on the brake pedal into hydraulic pressure for two separate brake circuits.

**Toute la force de  
freinage, longtemps**

Le maître-cylindre convertit la pression exercée sur la pédale de frein en une pression hydraulique pour deux circuits de freinage séparés.

**Piena forza frenante per  
molto tempo**

Il cilindro maestro del freno trasforma la pressione sul pedale del freno in pressione idraulica per due circuiti frenanti separati.

**Plena fuerza de frenado  
a largo plazo**

El cilindro principal de freno convierte la presión ejercida sobre el pedal de freno en presión hidráulica para dos circuitos de freno separados.

**Tandem-Hauptzylinder**

- ① Gehäuse
- ② Federn
- ③ Kolben
- ④ Manschetten

**Tandem master cylinder**

- ① Housing
- ② Springs
- ③ Piston
- ④ Sleeves

**Maitre-cylindre tandem**

- ① Boîtier
- ② Ressorts
- ③ Piston
- ④ Manchons

**Cilindro maestro  
a tandem**

- ① Scatola
- ② Molle
- ③ Pistoncino
- ④ Manicotti

**Cilindro principal  
tándem**

- ① Carcasa
- ② Resortes
- ③ Embolo
- ④ Manguitos

nl

**Tandem-  
hoofdcilinder**

sv

**Tandemhuvud-  
cylinder**

pt

**Cilindro  
principal tandem**

cs

**Tandemový  
hlavní válec**

ru

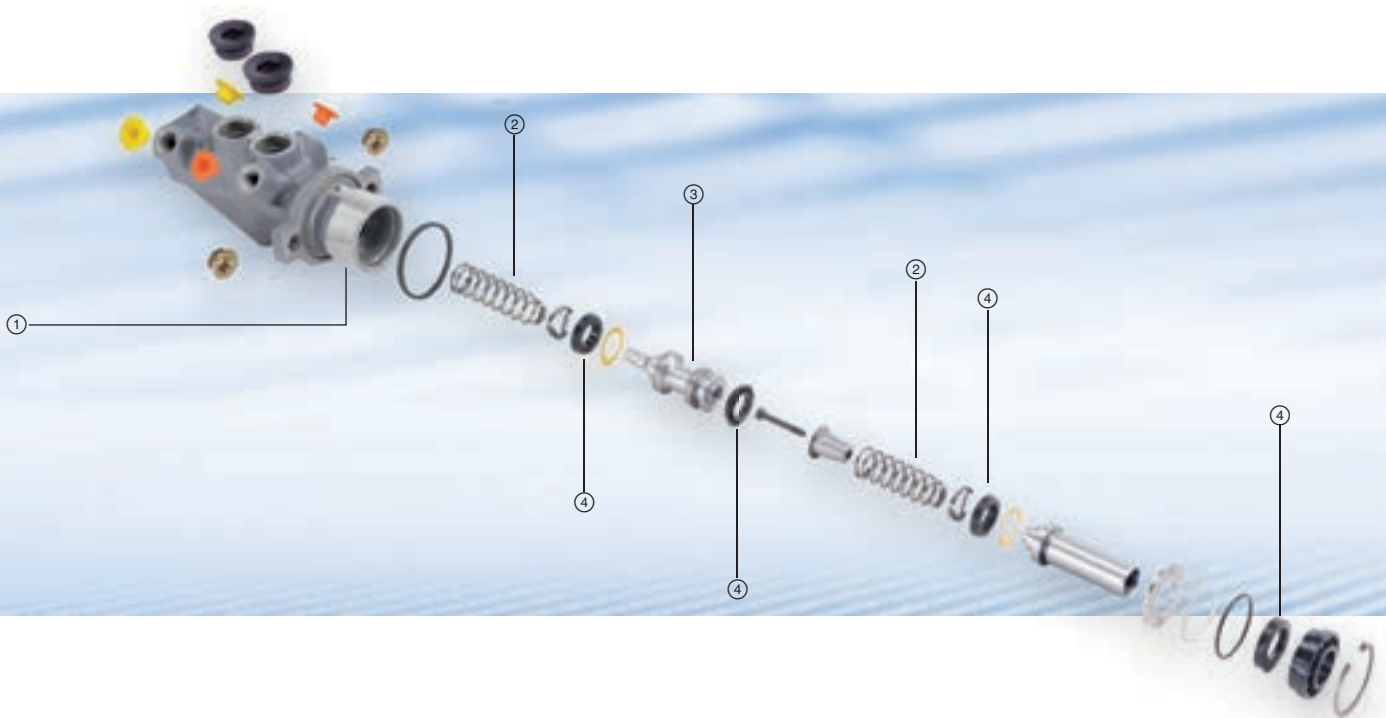
**Главный тормозной  
цилиндр tandemного  
типа****Volle remkracht op lange termijn.**

De hoofdcilinder verandert de druk op het rempedaal in hydraulische druk voor twee afzonderlijke remcircuits.

**Full bromskraft på lång sikt**

Huvudcylindern omvandlar trycket mot bromspedalen till ett hydrauliskt tryck för två separata bromskretsar.

**Força de travagem total a longo prazo**

O cilindro principal converte a pressão do pedal do travão em pressão hidráulica para os dois circuitos do travão separados.

**Plná brzdná síla dlouhodobě**

Hlavní válec převádí sílu na brzdovém pedálu na hydraulický tlak pro dva samostatné brzdové okruhy.

**Полное тормозное усилие надолго**

Главный тормозной цилиндр преобразует давление на педаль тормоза в гидравлическое давление для двух отдельных контуров тормозного привода.

**Tandem-hoofdcilinder**

- ① Behuizing
- ② Veren
- ③ Zuiger
- ④ Manchetten

**Tandemhuvudcylinder**

- ① Hus
- ② Fjädrar
- ③ Kolvar
- ④ Manschetter

**Cilindro principal tandem**

- ① Carcaça
- ② Molas
- ③ Pistão
- ④ Gaxetas

**Tandemový hlavní válec**

- ① Těleso
- ② Pružiny
- ③ Píst
- ④ Manžety

**Главный тормозной цилиндр tandemного типа**

- ① Корпус
- ② Пружины
- ③ Поршень
- ④ Манжеты

de

**Radbremszylinder mit integriertem Regler (CRCI)**

en

**Wheel-brake cylinder with integrated regulator (CRCI)**

fr

**Cylindre de roue correcteur intégré (CRCI)**

it

**Cilindretto del freno con regolatore integrato (CRCI)**

es

**Cilindros de rueda con regulador integrado (CRCI)**

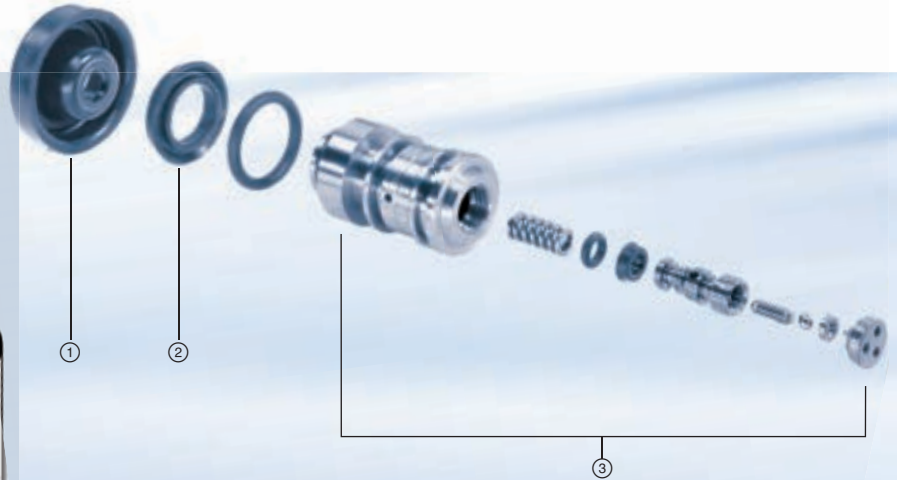
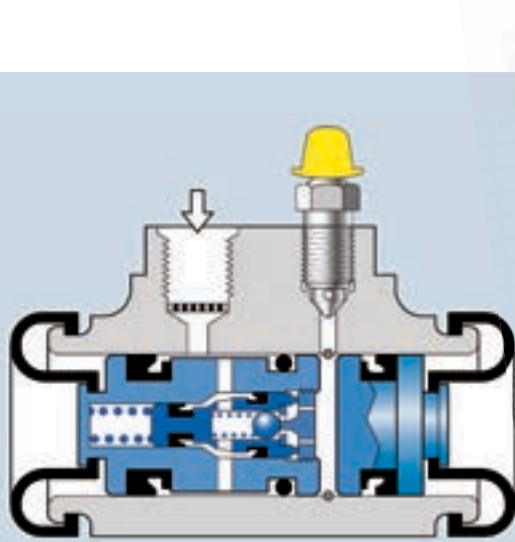

Beim CRCI-Radbremszylinder sitzt die Entlüftungsschraube asymmetrisch zur Achse. CRCI-Radbremszylinder ersparen einen externen Bremskraftregler, reduzieren das Fahrzeuggewicht und ermöglichen eine radselektive Drucksteuerung. Ohne Druckverlust.

CRCI type – the bleeder screw is located asymmetrically to the wheel-brake cylinder axis. With CRCI wheel-brake cylinders, the external braking-force regulator and the wear involved become a thing of the past. The vehicle's weight is reduced, and wheel-selective pressure control becomes possible. All with no loss of pressure.

La vis de purge d'air du cylindre de frein de roue CRCI est excentré par rapport à l'axe. Avec un cylindre de roue CRCI, il n'y a pas de compensateur dans le circuit de freinage – ce qui réduit le poids du véhicule. La correction de l'effort de freinage se fait indépendamment et sans perte sur chaque roue de l'axe arrière.

Nel cilindretto del freno CRCI la vite di spurgo è asimmetrica rispetto all'asse. I cilindretti del freno CRCI non necessitano un correttore di frenata esterno, evitando così una loro usura. Si riduce il peso del veicolo e viene reso possibile un controllo della pressione frenante su ogni singola ruota, senza calo di pressione.

En el cilindro de rueda CRCI el tornillo de purga se asienta asimétricamente respecto al eje. Los cilindros de rueda CRCI no necesitan un regulador de fuerza de frenado externo y evitan su desgaste. Reducen el peso del vehículo y permiten el control de la presión de frenado selectivo por rueda, sin pérdida de presión.

- ① Staubschutzmanschette
- ② Kolbendichtung
- ③ Integrierter Ventilmechanismus zur präzisen Steuerung des Bremsdruckes
- ④ Entlüftungsschraube
- ⑤ Kolben

- ① Dust sleeve
- ② Piston seal
- ③ Incorporated valve mechanism for the precise braking-pressure control
- ④ Bleeder screw
- ⑤ Piston

- ① Pare-poussière
- ② Joint de piston
- ③ Mécanisme de soupape intégré pour un pilotage précis de la pression de freinage
- ④ Vis de purge d'air
- ⑤ Piston

- ① Cuffia parapolvere
- ② Guarnizione del pistoncino
- ③ Meccanismo integrato a valvola per una gestione precisa della pressione frenante
- ④ Vite di spurgo d'aria
- ⑤ Pistoncino

- ① Guardapolvo
- ② Guarnición del émbolo
- ③ Mecanismo de válvulas integrado para un control preciso de la presión de frenado
- ④ Tornillo de purga de aire
- ⑤ Pistón

nl

### Wielremcilinder met geïntegreerde regelaar (CRCI)

sv

### Hjulbromscylin- der med integrerad regulator (CRCI)

pt

### Cilindro do travão da roda com regulador integrado (CRCI)

cs

### Brzdový válec kola s integrovaným regulátorem (CRCI)

ru

### Колесный тормозной цилиндр с интегрированным регулятором (CRCI)

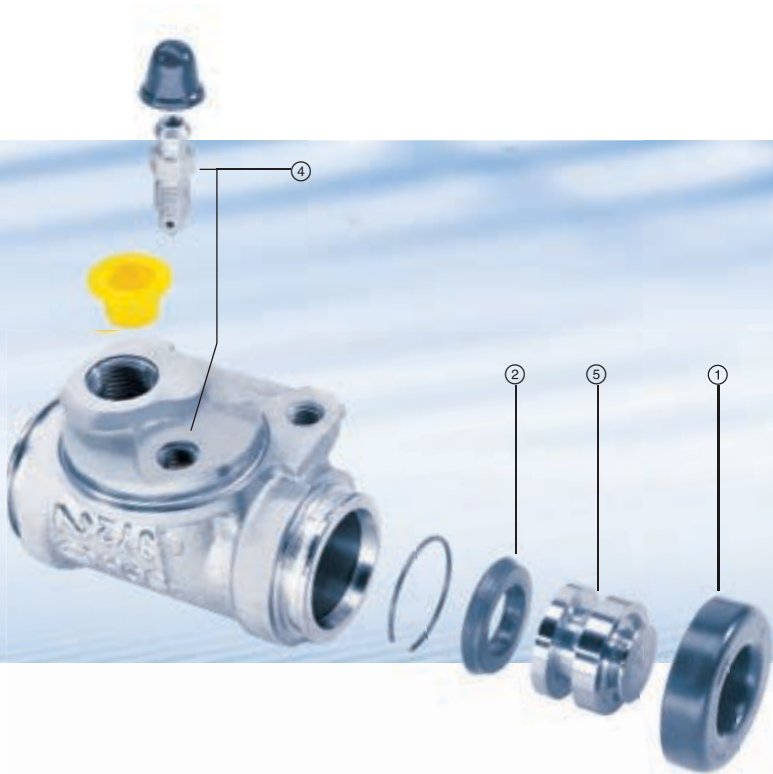

Bij de CRCI-wielremcilinder is de ontluuchtingschroef t.o.v. de as asymmetrisch geplaatst. CRCI-wielremcilinders maken een externe remkrachtregelaar overbodig, verlagen het voertuiggewicht en maken een drukregeling per afzonderlijk wiel mogelijk. Zonder drukverlies.

På CRCI-hjulbromscylin-  
dern sitter luftningsskru-  
ven asymmetriskt mot  
axeln.  
CRCI-hjulbromscylin-  
dern kräver ingen extern  
bromskraftregulator, red-  
ucerar fordonets vikt och  
möjliggör en hjulsektiv  
tryckstyrning. Utan tryck-  
förlust.

No cilindro do travão da  
roda CRCI existe  
um parafuso de sangria  
colocado de forma  
assimétrica ao eixo.  
Os cilindros do travão da  
roda CRCI permitem pres-  
cindir da utilização de um  
regulador da pressão do  
travão externo, reduzir  
o peso do veículo e um  
comando da pressão  
exclusivo de cada roda.  
Sem perda de pressão.

U brzdového válce kola  
CRCI je odvzdušňovací  
šroub umístěn  
asymetricky k ose.  
Brzdové válce kola  
CRCI nevyžadují externí  
regulátor brzdné síly,  
snižují hmotnost vozidla a  
umožňují selektivní řízení  
tlaku u jednotlivých kol.  
Bez tlakové ztráty.

У колесного тормозного  
цилиндра CRCI  
резьбовая пробка  
отверстия для удаления  
воздуха расположена  
асимметрично к оси.  
Благодаря колесным  
тормозным цилиндрам  
CRCI отпадает  
необходимость в  
установке отдельного  
регулятора тормозных  
сил, уменьшается вес  
автомобиля и  
обеспечивается  
индивидуальная  
регулировка давления  
для каждого колеса. Без  
потери давления.

- ① Manchet voor  
stofbescherming
- ② Zuigerafdichting
- ③ Geïntegreerde klep-  
mechanisme voor een  
nauwkeurige regeling  
van de remdruk
- ④ Ontluuchtingschroef
- ⑤ Zuiger

- ① Dammskyddsman-  
schett
- ② Kolvtätning
- ③ Integrerad ventilmeka-  
nism för exakt styrning  
av bromstrycket
- ④ Luftningsskruv
- ⑤ Kolvar

- ① Gaxeta guarda-pó
- ② Junta do pistão
- ③ Mecanismo da válvula  
integrado para um con-  
trole preciso da pres-  
são de travagem
- ④ Parafuso de sangria
- ⑤ Pistão

- ① Protiprachová manžeta
- ② Těsnění pístu
- ③ Integrovaný me-  
chanismus ventilu  
k přesnému řízení  
brzdného tlaku
- ④ Odvzdušňovací šroub
- ⑤ Píst

- ① Пылезащитная  
манжета
- ② Уплотнение поршня
- ③ Интегрированный  
клапанный механизм  
для точной  
регулировки давления  
в тормозном приводе
- ④ Резьбовая пробка  
отверстия для  
удаления воздуха
- ⑤ Поршень



de

Klassischer Radbremszylinder

en

Classic wheel-brake cylinder

fr

Cylindre de roue classique

it

Cilindretto del freno classico

es

Cilindro de rueda clásico

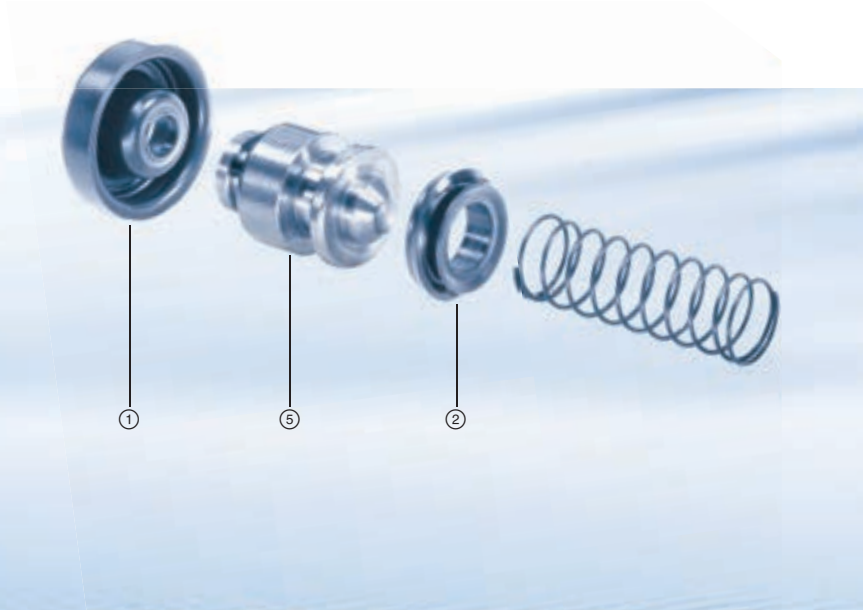
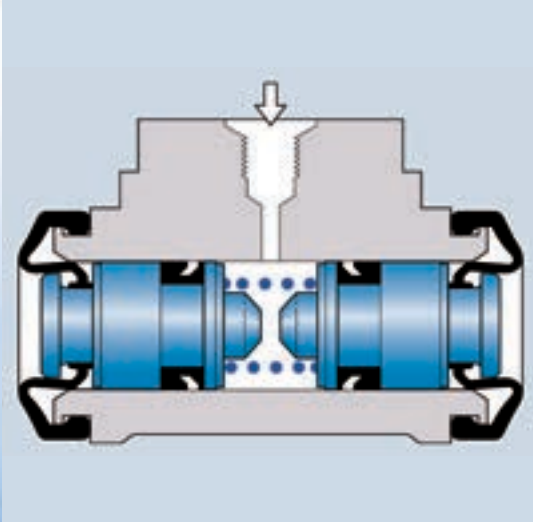

Beim klassischen Radbremszylinder sitzt die Entlüftungsschraube mittig zur Achse des Radbremszylinders.

Classic type – the bleeder screw is located centrally referred to the axis of the wheel-brake cylinder.

La vis de purge d'air du cylindre de roue classique est au centre de l'axe du cylindre de roue.

Nel cilindretto del freno classico la vite di spurgo è situata centralmente rispetto all'asse del cilindretto stesso.

En los cilindros de rueda clásicos se asienta el tornillo de purga centrado respecto al eje del cilindro de rueda.

- ① Staubschutzmanschette
- ② Kolbendichtung
- ④ Entlüftungsschraube
- ⑤ Kolben

- ① Dust sleeve
- ② Piston seal
- ④ Bleeder screw
- ⑤ Piston

- ① Pare-poussière
- ② Kolbendichtung
- ④ Vis de purge d'air
- ⑤ Piston

- ① Cuffia parapolvere
- ② Guarnizione del pistoncino
- ④ Vite di spurgo d'aria
- ⑤ Pistoncino

- ① Guardapolvo
- ② Guarnición del émbolo
- ④ Tornillo de purga de aire
- ⑤ Pistón

nl

Klassieke wielremcilinder

sv

Klassisk hjulbromscylander

pt

Cilindro do travão da roda clássica

cs

Klasický brzdový válec kola

ru

Классический колесный тормозной цилиндр

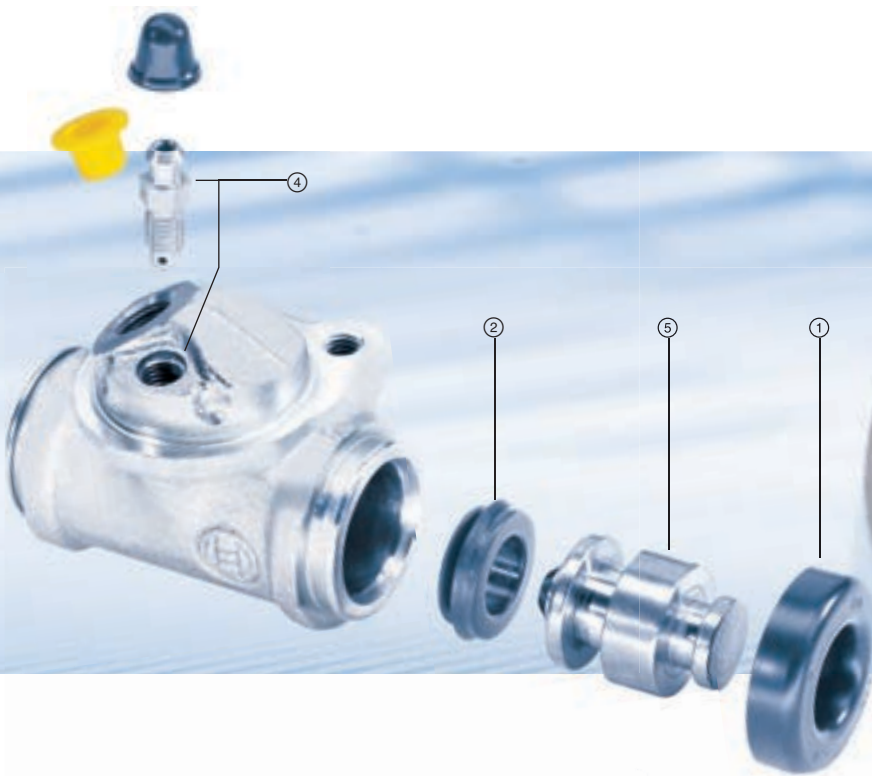

Bij de klassieke wielremcilinder is de ontluhtingsschroef centrisc geplaatst t.o.v. de as van de wielremcilinder.

På den klassiska hjulbromscylandern sitter luftningsskruven centriskt mot hjulbromscylanderns axel.

No cilindro do travão da roda clássica, o parafuso de sangria está colocado a meio do eixo daquele.

U klasického brzdového válce kola je odvzdušňovací šroub umístěn v ose brzdového válce kola.

У классического колесного тормозного цилиндра резьбовая пробка отверстия для удаления воздуха расположена по оси цилиндра.

- ① Manchet voor stofbescherming
- ② Zuigerafdichting
- ④ Ontluchtingsschroef
- ⑤ Zuiger

- ① Dammskyddsman-schett
- ② Kolvtätning
- ④ Luftningsskruv
- ⑤ Kolvar

- ① Gaxeta guarda-pó
- ② Junta do pistão
- ④ Parafuso de sangria
- ⑤ Pistão

- ① Protiprachová manžeta
- ② Těsnění pístu
- ④ Odvzdušňovací šroub
- ⑤ Píst

- ① Пылезащитная манжета
- ② Уплотнение поршня
- ④ Резьбовая пробка отверстия для удаления воздуха
- ⑤ Поршень

# Bosch-Electronic Repair Service

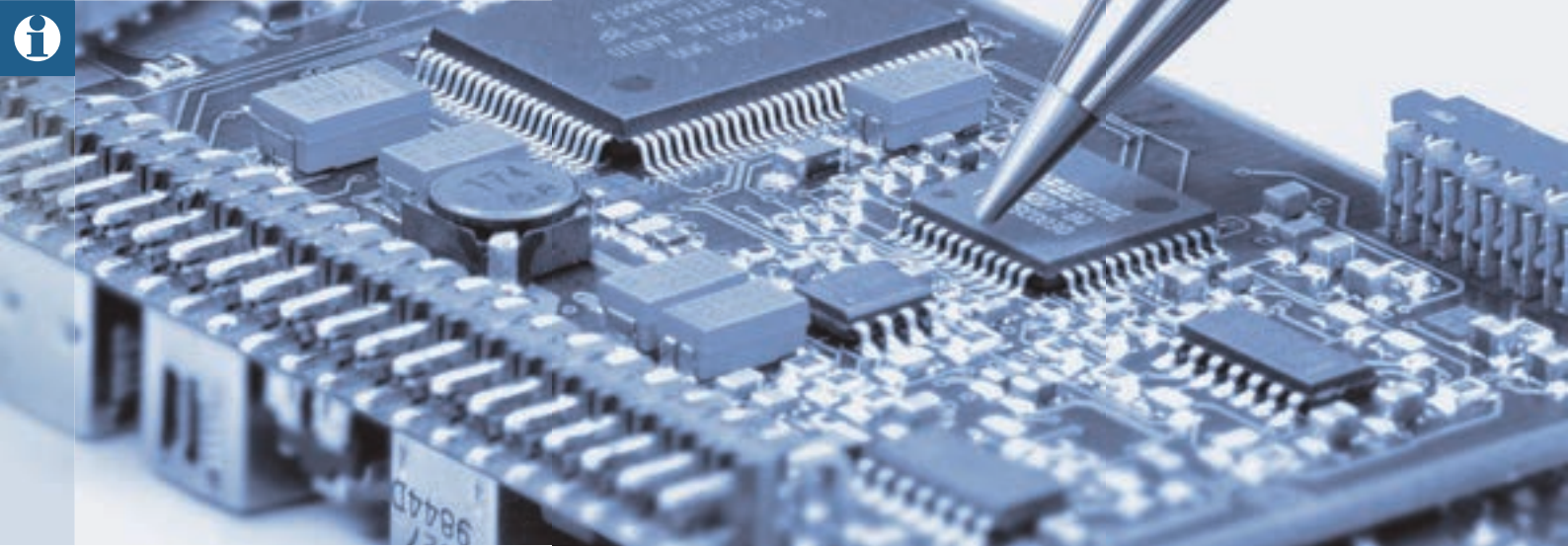
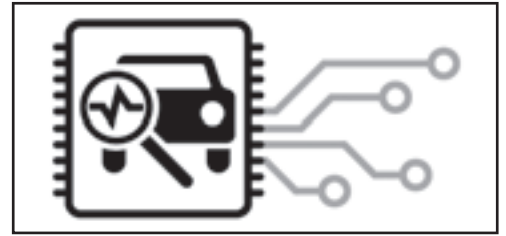

de

## Profi-Lösung für Kfz-Werkstätten

Profi-Service für Ihre Kunden

en

## Solution for workshops

Professional service for your customers

fr

## Solutions professionnelles pour ateliers

Un service de pro pour vos clients

it

## La soluzione professionale per le officine

Assistenza professionale per i vostri clienti

es

## Soluciones profesionales para talleres

Asistencia profesional para sus clientes

### Ihre Vorteile:

- ▶ **Fair Repair:**  
Die Reparatur von elektronischen Komponenten als zeitwertgerechte Lösung
- ▶ **Mehr Service:**  
Zufriedene Kunden kommen wieder!
- ▶ **Zuverlässig und schnell:**  
Versand der reparierten Komponente in der Regel innerhalb von 48 Stunden nach Anlieferung beim Bosch-Electronic Repair Service
- ▶ **Qualität bleibt Qualität:**  
Dafür steht Bosch, weltweit führender Erstausrüster und Entwickler von elektronischen Fahrzeugsystemen

### Your benefits at a glance:

- ▶ **Fair repair:**  
The repair of electronic components as a value-driven solution
- ▶ **Better service:**  
Satisfied customers come back!
- ▶ **Reliable and fast:**  
Repaired components are usually dispatched within 48 hours of arriving at the Bosch Electronic Repair Service
- ▶ **Quality is quality:**  
That is what Bosch, the world's leading original equipment manufacturer and developer of electronic vehicle systems, stands for

### Les avantages :

- ▶ **Fair Repair :**  
la réparation des composants électroniques adaptée à leur valeur marchande
- ▶ **Davantage de service :**  
les clients satisfaits sont des clients fidèles !
- ▶ **Fiable et rapide :**  
réexpédition du composant réparé en général 48 heures après son arrivée au Bosch Electronic Repair Service
- ▶ **Des experts de la qualité :**  
Bosch, premier équipementier et leader mondial de la conception de systèmes électroniques pour l'automobile

### I vantaggi:

- ▶ **Riparazioni a un giusto prezzo:**  
la riparazione di un componente difettoso viene effettuata solo se risulta una soluzione adeguata rispetto al valore attuale del componente
- ▶ **Assistenza al top:**  
i clienti soddisfatti ritornano!
- ▶ **Affidabilità e velocità:**  
spedizione dei componenti riparati di regola entro 48 ore dalla consegna presso il Bosch Electronic Repair Service
- ▶ **La qualità resta qualità:**  
è la missione principale di Bosch, fornitore OEM leader mondiale e sviluppatore di sistemi elettronici per autoveicoli

### Todas las ventajas:

- ▶ **Reparación fiable:**  
una reparación de componentes electrónicos como solución adaptada al valor actual del mercado.
- ▶ **Más servicios:**  
los clientes satisfechos vuelven al taller.
- ▶ **Eficacia y rapidez:**  
el componente reparado se envía, como norma general, 48 horas después de su llegada al Bosch Electronic Repair Service.
- ▶ **Calidad significa verdadera calidad:**  
calidad es sinónimo de Bosch, líder mundial en el desarrollo y fabricación de sistemas electrónicos para vehículos.

Robert Bosch Car Multimedia GmbH  
AA-ES/MFR1  
Robert-Bosch-Strasse 200  
DE-31139 Hildesheim  
Telefon 0180 5000 535



[www.bosch-repair-service.com](http://www.bosch-repair-service.com)



nl

#### Professionele oplossing voor werkplaatsen

Professionele service voor uw klanten

#### Uw voordelen in één oogopslag:

- ▶ **Fair Repair:** reparatie van elektronische componenten als oplossing die past bij de restwaarde
- ▶ **Meer service:** tevreden klanten komen terug!
- ▶ **Betrouwbaar en snel:** verzending van gerepareerde componenten doorgaans binnen 48 uur na ontvangst bij Bosch Electronic Repair Service
- ▶ **Kwaliteit blijft kwaliteit:** dat garandeert Bosch, de wereldwijd toonaangevende OEM-fabrikant en ontwikkelaar van elektronische voertuigsystemen

sv

#### Profffslösning för fordonverkstäder

Profsservice för dina kunder

#### Dina fördelar:

- ▶ **Ärlig reparation:** Reparation av elektroniska komponenter som marknadsvärdesanpassad lösning
- ▶ **Mer service:** Nöjda kunder kommer tillbaka!
- ▶ **Tillförlitligt och snabbt:** Den reparerade komponenten sänds i regel tillbaka inom 48 timmar efter inleverans hos Bosch Electronic Repair Service
- ▶ **Kvalitet består kvalitet:** Det står Bosch för, globalt ledande leverantör av originalutrustning och utvecklare av elektroniska fordonssystem

pt

#### Solução profissional para oficinas

Serviço profissional para os seus clientes

#### As suas vantagens:

- ▶ **Reparação justa:** A reparação de componentes electrónicos como uma solução ajustada ao valor actual
- ▶ **Mais serviço:** Os clientes satisfeitos acabam por voltar!
- ▶ **Seguro e rápido:** Envio dos componentes reparados normalmente no espaço de 48 horas após chegada ao Bosch Electronic Repair Service
- ▶ **Qualidade é sempre qualidade:** Este é o lema da Bosch, fabricante de equipamento de origem e criador líder a nível mundial de sistemas electrónicos para veículos

cs

#### Profesionální řešení pro servisní dílny osobních vozidel

Profesionální řešení pro vaše zákazníky

#### Vaše výhody:

- ▶ **Poctivá oprava:** Oprava elektronických komponent jako řešení odpovídající aktuální hodnotě
- ▶ **Více služeb:** Spokojený zákazník přijde opět!
- ▶ **Spolehlivě a rychle:** Expedice opravených komponent zpravidla během 48 hodin po dodání u Bosch Electronic Repair Service
- ▶ **Kvalita zůstává kvalitou:** Za ní stojí Bosch, přední přímá dodavatelská a vývojová společnost elektronických systémů vozidel ve světě

ru

#### Профессиональное решение для станций техобслуживания автомобилей

Профессиональный сервис для Ваших клиентов

#### Ваши преимущества:

- ▶ **Корректный ремонт:** Ремонт электронных компонентов как современное решение
- ▶ **Больше сервиса:** Удовлетворенные клиенты придут еще раз!
- ▶ **Надежность и быстрота:** Отправка отремонтированных компонентов, как правило, в течение 48 часов после доставки в Bosch Electronic Repair Service
- ▶ **Качество остается качеством:** Это олицетворяет собой Bosch, ведущий в мире производитель первичной комплектации и разработчик электронных автомобильных систем

de

**Der Reparaturprozess**

en

**The repair process**

fr

**Le processus de réparation**

it

**Il processo di riparazione**

es

**Proceso de reparación****① Diagnose**

Eine elektronische Fahrzeugkomponente ist defekt.

**② Produktsuche**

Suchen Sie die entsprechende elektronische Komponente über die Suchfunktion. Halten Sie dafür am Besten gleich die Bosch-Nummer oder Gerätenummer bereit.

**③ Reparaturauftrag**

Wir reparieren je nach Gerät zum Festpreis oder erstellen Ihnen einen Kostenvoranschlag.

**④ Abholung in Ihrer Werkstatt**

Wir beauftragen einen Kurier, der die defekte Komponente kurz darauf bei Ihnen in der Werkstatt abholt.

**⑤ Reparatur durch die Profis**

Die Elektronik-Spezialisten von Bosch führen die Reparatur durch.

**⑥ Auslieferung an die Werkstatt**

In der Regel ist die reparierte elektronische Komponente 48 Stunden nach Eingang bei uns wieder auf dem Weg in Ihre Werkstatt.

**① Diagnosis**

An electronic vehicle component is faulty.

**② Product search**

Search for the corresponding electronic component using the search function. When doing so, have the Bosch number or device number to hand.

**③ Repair order**

Depending on the unit, we repair it at a fixed price or create a cost estimate for you.

**④ Collection from your workshop**

We arrange for a courier to quickly collect the faulty component from your workshop.

**⑤ Repair by the professionals**

The electronics specialists at Bosch perform the repair.

**⑥ Delivery to the workshop**

The repaired electronic component is usually on its way back to your workshop 48 hours after we receive it.

**① Diagnostic**

Un composant électronique d'un véhicule est défectueux.

**② Recherche de produit**

Recherchez le composant électronique correspondant à l'aide de la fonction de recherche. Ayez la référence Bosch ou la référence de l'appareil à portée de main.

**③ Ordre de réparation**

Selon l'appareil, nous effectuons la réparation à prix fixe ou nous vous établissons un devis.

**④ Enlèvement à votre garage**

Nous envoyons un coursier chercher peu de temps après le composant défectueux à votre garage.

**⑤ Réparation par des professionnels**

Les spécialistes de l'électronique de Bosch effectuent la réparation.

**⑥ Livraison au garage**

En règle générale, le composant électronique réparé reprend le chemin de votre garage 48 heures après être arrivé chez nous.

**① Diagnosi**

Un componente elettronico del veicolo è difettoso.

**② Ricerca prodotto**

Va effettuata la ricerca del corrispondente componente elettronico tramite la funzione di ricerca. A tale scopo è opportuno tenere a portata di mano il numero Bosch o il numero del dispositivo.

**③ Ordine di riparazione**

A seconda del relativo dispositivo, eseguiamo la riparazione a un prezzo fisso oppure vi forniamo un preventivo dei costi.

**④ Ritiro in officina**

Incarichiamo un corriere che entro pochissimo tempo provvede a ritirare il componente difettoso nella vostra officina.

**⑤ Riparazione da parte di esperti**

Gli specialisti in elettronica di Bosch eseguono la riparazione.

**⑥ Consegna all'officina**

In genere il componente elettronico riparato 48 ore dopo l'arrivo nei nostri laboratori è già di nuovo sul viaggio di ritorno verso l'officina.

**① Diagnóstico**

Un componente electrónico del vehículo está averiado.

**② Búsqueda de producto**

Buscar el componente electrónico correspondiente mediante la función de búsqueda. Para ello es conveniente tener a mano el número Bosch o el número del equipo.

**③ Orden de reparación**

Hacemos reparaciones a un precio fijo según el equipo o elaboramos para usted un presupuesto de gastos.

**④ Recogida en su taller**

Encargamos a un servicio de paquetería para que pase inmediatamente por su taller a recoger el componente averiado.

**⑤ Reparación por profesionales**

Los especialistas en sistemas electrónicos de Bosch efectúan la reparación.

**⑥ Entrega en el taller**

Como norma general, el componente electrónico reparado se encuentra en camino de regreso a su taller sólo 48 horas después de haberlo recepcionado.

nl

**Het reparatieproces**

sv

**Reparationsprocessen**

pt

**O processo de reparação**

cs

**Proces opravy**

ru

**Процесс ремонта**

**1 Diagnose**  
Een elektronische voertuigcomponent is defect.

**2 Product zoeken**  
Zoek de desbetreffende elektronische component via de zoekfunctie. Houd hiervoor direct het Bosch-nummer of apparaatnummer bij de hand.

**3 Reparatie-opdracht**  
Wij repareren naar gelang het apparaat voor een vaste prijs of maken een kostenraming.

**4 Afhalen in de werkplaats**  
Wij geven een koerier de opdracht de defecte component korte tijd daarna bij u in de werkplaats op te halen.

**5 Reparatie door de expert**  
De elektronica-specialisten van Bosch voeren de reparatie uit.

**6 Levering aan de werkplaats**  
Over het algemeen is de gerepareerde elektronische component 48 uur na aankomst bij ons weer onderweg naar uw werkplaats.

**1 Diagnos**  
En elektronisk fordonskomponent är defekt.

**2 Produktsökning**  
Sök upp motsvarande elektroniska komponent med sökfunktionen. Bäst är det om du redan håller Bosch-numret eller apparatens nummer i beredskap.

**3 Reparationsorder**  
Beroende på apparat reparerar vi till fast pris eller ger dig en offert.

**4 Hämtning i din verkstad**  
Vi ger en kurir i uppdrag att kort därefter hämta den defekta komponenten hos dig i verkstaden.

**5 Reparationer genom proffs**  
Elektronikspecialisterna hos Bosch utför reparationer.

**6 Utleverans till verkstaden**  
I regel är den reparerade elektroniska komponenten på väg tillbaka till din verkstad inom 48 timmar efter att den kommit fram till oss.

**1 Diagnóstico**  
Um componente eletrônico do veículo está defeituoso.

**2 Pesquisa do produto**  
Procure o respetivo componente eletrónico através da função de busca. Para o efeito, convém ter à mão o número Bosch ou número do aparelho.

**3 Ordem de reparação**  
Consoante o aparelho, efetuamos reparações a preço fixo ou elaboramos um orçamento para si.

**4 Recolha na sua oficina**  
Encarregamos um estafeta de recolher o componente defeituoso pouco depois na sua oficina.

**5 Reparação por profissionais**  
Os peritos em eletrónica da Bosch executam a reparação.

**6 Entrega na oficina**  
Normalmente, devolvemos o componente eletrónico reparado à sua oficina 48 horas após a receção.

**1 Diagnostika**  
Některá elektronická komponenta vozidla je vadná.

**2 Vyhledávání produktu**  
Vyhledání příslušné elektronické komponenty pomocí vyhledávací funkce. Nejlépe je, máte-li k tomu připraveno číslo Bosch nebo číslo přístroje.

**3 Zakázka opravy**  
Podle druhu přístroje opravujeme za pevnou cenu nebo vám zpracujeme cenovou nabídku.

**4 Odběr ve vašem servisu**  
Pověříme kurýra, který krátce poté odebere vadnou komponentu ve vašem servisu.

**5 Opravu provádějí profesionálové**  
Opravu provedou specialisté na elektroniku firmy Bosch.

**6 Expedice do servisu**  
Zpravidla je opravená elektronická komponenta již za 48 hodin od dodání k nám opět na cestě do vašeho servisu.

**1 Диагностика**  
Электронный компонент автомобиля неисправен.

**2 Поиск продукта**  
Найдите соответствующий электронный компонент с помощью функции поиска. Лучше всего, сразу же приготовьте для этого номер Bosch или номер устройства.

**3 Заказ на ремонт**  
В зависимости от устройства мы ремонтируем за фиксированную цену или составляем предварительную смету.

**4 Заезд на Вашу СТО**  
Мы заказываем курьера, который через короткое время забирает неисправный компонент на Вашей СТО.

**5 Ремонт профессионалами**  
Специалисты по электронике компании Bosch проводят ремонт.

**6 Доставка на СТО**  
Как правило, через 48 часов после получения нами отремонтированный электронный компонент уже будет в пути на Вашу СТО.

**ALFA ROMEO**

Brera [939]	B2
GT [937]	B2
GTV [916]	B3
MiTo [955]	B5
Spider [916]	B5
Spider [939]	B7
33 Berlina [907A]	B8
33 Sportwagon [907B]	B9
145 [930 MY95]	B9
145 [930 MY97]	B11
145 [930 MY99]	B12
146 [930 MY95]	B13
146 [930 MY97]	B15
146 [930 MY99]	B16
147 [937]	B17
155 [167 MY92]	B19
155 [167 MY96]	B21
156 Berlina [932]	B21
156 Sport Wagon Q4 [932]	B25
156 Sport Wagon [932]	B25
156 Sportwagon [932]	B29
159 Berlina Q4 [939]	B29
159 Berlina [939]	B29
159 Sport Wagon Q4 [939]	B30
159 Sport Wagon [939]	B30
159 Sportwagon [939]	B31
164 [164]	B31
166 [936]	B32

**ALPINA  
(B. BOVENSIEPEN KG)**

B7 [E65/66]	B33
Roadster [Z8]	B33

**ASTON MARTIN**

Virage Coupé	B33
--------------	-----

**AUDI**

A1 Sportback [8X]	B33
A1 [8X]	B35
A2 [8Z0]	B37
A3 Cabriolet	B38
A3 Cabriolet [8P7]	B38
A3 Cabriolet [8V7]	B40
A3 Limousine [8VS]	B40
A3 Sportback [8PA]	B41
A3 Sportback [8VA]	B46
A3 Sportsback [8VA]	B47
A3 [8L1]	B47
A3 [8P1]	B50
A3 [8V1]	B56
A4 Allroad [8KH]	B57
A4 Avant [8D5; B5]	B58



A4 Avant [8ED; B7]	B67
A4 Avant [8E5; B6]	B70
A4 Avant [8K5; B8]	B74
A4 Cabriolet [8HE; B7]	B76
A4 Cabriolet [8H7; B6]	B77
A4 Sportback [8TA]	B80
A4 [8D2; B5]	B80
A4 [8EC; B7]	B89
A4 [8E2; B6]	B93
A4 [8K2; B4]	B97
A4 [8K2; B8]	B97
A5 Cabriolet [8F7]	B100
A5 Coupé [8T3]	B102
A5 Sportback [8TA]	B104
A6 Allroad [4BH; C5]	B107
A6 Allroad [4FH; C6]	B108
A6 Allroad [4GH; C7]	B108
A6 Allroad [4GH; C7]	B109
A6 Avant [4A5; C4]	B109
A6 Avant [4B; C5]	B110
A6 Avant [4B5; C5]	B111
A6 Avant [4B5; C5]	B119
A6 Avant [4B6; C5]	B119
A6 Avant [4F5; C6]	B120
A6 Avant [4F5; C6]	B120
A6 Avant [4G; C7]	B122
A6 [4A2; C4]	B123
A6 [4B2; C5]	B125
A6 [4B4; C5]	B133
A6 [4F2; C6]	B134
A6 [4F2; C6]	B134
A6 [4G; C7]	B136
A7 Sportback [4G]	B137
A8 [4D2; D2]	B137
A8 [4E; D3]	B140
A8 [4H; D4]	B142
Cabriolet [8G7; B4]	B142
Coupé S2 [89; B3]	B143
Coupé [89; B3]	B143
Maxxum	B144
Q3 RS [8U]	B144
Q3 [8U]	B144
Q5 [8RB]	B146
Q7 [4LB]	B147
RS3 Sportback [8PA]	B148
RS4 Avant [8D5; B5]	B148
RS4 Avant [8ED; B7]	B148
RS4 Avant [8K5; B8]	B148
RS4 Cabriolet [8HE; B7]	B149
RS4 [8EC; B7]	B149
RS5 Cabriolet [8F7]	B149
RS5 Coupé [8T3]	B149
RS6 Avant [4B6]	B149
RS6 Avant [4F5; C6]	B149
RS6 Avant [4G; C7]	B150



RS6 [4B4]	B150
RS6 [4F2; C6]	B150
RS7 Sportback [4G]	B150
R8 Spyder GT [427]	B150
R8 Spyder [429]	B150
R8 [422]	B150
R8 [423]	B151
SQ5 [8RB]	B151
S1 Sportback [8X]	B151
S1 [8X]	B152
S3 Cabriolet [8V7]	B152
S3 Limousine [8VS]	B152
S3 Sportback [8PA]	B152
S3 Sportback [8VA]	B152
S3 [8L1]	B153
S3 [8P1]	B153
S3 [8V1]	B153
S4 Avant [4A5; C4]	B153
S4 Avant [8D5; B5]	B154
S4 Avant [8ED; B7]	B154
S4 Avant [8E5; B6]	B154
S4 Avant [8K5; B8]	B154
S4 Cabriolet [8HE; B7]	B155
S4 Cabriolet [8H7; B7]	B155
S4 [4A2; C4]	B155
S4 [8D2; B5]	B155
S4 [8EC; B7]	B156
S4 [8E2; B6]	B156
S4 [8K2; B8]	B156
S5 Cabriolet [8F7]	B156
S5 Coupé [8T3]	B157
S5 Sportback [8TA]	B157
S6 Avant [4A5; C4]	B157
S6 Avant [4B; C5]	B157
S6 Avant [4B6; C5]	B158
S6 Avant [4F5; C6]	B158
S6 Avant [4G; C7]	B158
S6 [4A2; C4]	B158
S6 [4B4; C5]	B159
S6 [4F2; C6]	B159
S6 [4G; C7]	B159
S7 Sportback [4G]	B160
S8 [4D2]	B160
S8 [4E2]	B160
S8 [4H; D4]	B160
TT Coupé [FV3]	B161
TT Coupé [8J3]	B161
TT Coupé [8N3]	B162
TT Roadster [FV9]	B165
TT Roadster [8J9]	B165
TT Roadster [8N9]	B166
TT RS Coupé [8J3]	B169
TT RS Roadster [8J9]	B169
TTS Coupé [FV3]	B169
TTS Coupé [8J3]	B169



TTS Roadster [FV9]	B169
TTS Roadster [8J9]	B169
80 Avant [8C5; B4]	B169
80 [8C2; B4]	B171
100 Avant [4A5; C4]	B173
100 [4A2; C4]	B174

**AUTOBIANCHI**

Y 10 [R.92]	B175
-------------	------

**BENTLEY**

Continental Flying Spur	B176
Continental Flying Spur Speed	B176
Continental GT	B176
Continental GT Speed	B176
Continental GTC	B176
Continental GTC Speed	B177
Continental GT3 R	B177
Continental Supersport	B177
Continental Supersports	B177
Continental Supersports Cabrio	B177
Continental Supersports ISR	B178
Cabrio	
Flying Spur	B178
Mulsanne	B178
Mulsanne Speed	B178

**BMW**

Serie X [E 53]	B178
Serie X [E 83]	B179
Serie X [E 84]	B180
Serie Z Coupé [E 36/8]	B181
Serie Z Coupé [E 86]	B181
Serie Z [E 36/7]	B181
Serie Z [E 52]	B182
Serie Z [E 85]	B182
Serie Z [E 89]	B183
Serie 1 Cabrio [E 88]	B183
Serie 1 Coupé [E 82]	B184
Serie 1 [E 81]	B185
Serie 1 [E 87]	B186
Serie 1 [F 20]	B187
Serie 1 [F 21]	B188
Serie 1 [F20]	B188
Serie 2 Cabrio [F 23]	B189
Serie 2 Coupé [F 22]	B189
Serie 3 Cabrio [E 36]	B189
Serie 3 Cabrio [E 46]	B190
Serie 3 Cabrio [E 93]	B191
Serie 3 Compact [E 36]	B193
Serie 3 Compact [E 46]	B194
Serie 3 Coupé [E 36]	B194
Serie 3 Coupé [E 46]	B195
Serie 3 Coupé [E 92]	B197
Serie 3 [E 36]	B199

nl

## Inhoudsopgave

sv

## Innehållsöversikt

pt

Vista geral  
do conteúdo

cs

## Přehled obsahu

ru

## Оглавление

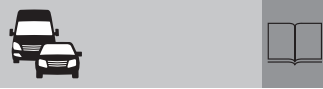

Serie 3 [E 46]	B201
Serie 3 [E 90]	B203
Serie 3 [F 30]	B207
Serie 3 GT [F 34]	B208
Serie 3 Touring [E 30]	B208
Serie 3 Touring [E 36]	B208
Serie 3 Touring [E 46]	B209
Serie 3 Touring [E 91]	B211
Serie 3 Touring [F 31]	B215
Serie 4 Cabrio [F 33]	B215
Serie 4 Coupé [F 32]	B216
Serie 4 GC [E 36]	B216
Serie 4 GC [F 36]	B216
Serie 5 [E 34]	B216
Serie 5 [E 39]	B217
Serie 5 [E 60]	B219
Serie 5 [F 10]	B221
Serie 5 GT [F 07]	B222
Serie 5 Touring [E 34]	B222
Serie 5 Touring [E 39]	B223
Serie 5 Touring [E 61]	B224
Serie 5 Touring [F 11]	B225
Serie 6 Cabrio [E 64]	B226
Serie 6 Cabrio [F 12]	B226
Serie 6 Coupé [F 13]	B227
Serie 6 [E 63]	B227
Serie 6 GC [F 06]	B227
Serie 7 [E 32]	B227
Serie 7 [E 38]	B228
Serie 7 [E 65]	B229
Serie 7 [E 66]	B229
Serie 7 [F 01]	B230
Serie 7 [F 02]	B230
Serie 7 [F 04]	B231

**BOGDAN**

2110	B231
2111	B231
2310	B231

**CHEVROLET**

Aveo	B231
Aveo Hatchback	B231
Aveo Hatchback [T255]	B232
Aveo Hatchback [T300]	B232
Aveo [T250]	B232
Aveo [T255]	B233
Aveo [T300]	B233
Blazer	B233
Calibra	B233
Captiva [C100]	B234
Corsa Wagon	B234
Corvette Cabrio	B234
Corvette Coupé	B234
Cruze Hatchback [J305]	B234

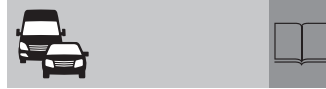

Cruze [J300]	B235
Cruze Station Wagon [J308]	B235
Epica [V250]	B236
Evanda [V200]	B236
Ipanema	B236
Kalos Hatchback [T200]	B236
Kalos [T200]	B236
Lacetti [J200]	B237
Lanos	B237
Matiz [M200]	B237
Niva	B238
Niva [212300]	B238
Niva [212360]	B238
Nubira [J200]	B238
Nubira Wagon [J200]	B238
Optra Hatchback [J200]	B239
Rezzo [U100]	B239
Sens [TF698]	B239
Serie D	B239
Spark	B240
Spark [M200]	B240
Spark [M300]	B240
S10	B240
Tavera	B241

**CHRYSLER**

Concorde [LH]	B241
Intrepid [LH]	B241
LHS [LH]	B241
PT Cruiser Cabrio [PT]	B241
PT Cruiser [PT]	B241
Sebring Convertible [JR]	B242
Sebring Convertible [JS]	B242
Sebring [JS]	B242
Voyager [GS]	B242
Voyager [NS]	B243
Voyager [RS]	B243
300M [LH]	B243

**CITROEN**

AX	B243
Berlingo	B244
Berlingo [B9]	B244
Berlingo [M49]	B245
Berlingo [M59]	B247
BX [X56]	B249
C 15	B250
C 25	B250
C-Crosser [I4]	B251
C-Elysee	B251
C1 [B0]	B252
C1 [B4]	B252
C2 [A6]	B252
C3	B253
C3 [A8]	B254



C3 [A31]	B254
C3 [A51]	B255
C3 Picasso [A58]	B257
C3-Pluriel [A42]	B258
C4 [B5]	B258
C4 [B71]	B260
C4 Cactus [E3]	B261
C4 Coupé [B5]	B261
C4 Grand Picasso [B58]	B262
C4 Picasso [B58]	B264
C4 Sedan [B5]	B265
C5 Break [X3]	B266
C5 Break [X4]	B267
C5 Tourer [X7]	B268
C5 [X3]	B269
C5 [X4]	B270
C5 [X7]	B270
C6 [X6]	B271
C8 [V3]	B272
DS3 [A5]	B273
DS3 [A55]	B273
DS3 Cabrio [A56]	B274
DS4 [B75]	B275
DS5 [B81]	B275
Evasion [U60]	B275
Jumper	B277
Jumper [U5]	B277
Jumper [U6]	B278
Jumper [U9]	B278
Jumper [23]	B279
Jumpy [G9]	B281
Jumpy [U64]	B281
Nemo [A9]	B283
Picasso	B283
Saxo [S8]	B283
Xantia Break [X1]	B285
Xantia Break [X2]	B287
Xantia [X1]	B289
Xantia [X2]	B291
XM [Y3]	B292
XM [Y4]	B293
Xsara Break [N6]	B294
Xsara Break [N7]	B296
Xsara Coupé [N6]	B297
Xsara Coupé [N7]	B298
Xsara [N6]	B299
Xsara [N7]	B301
Xsara Picasso	B302
Xsara Picasso [N68]	B303
ZX	B306
ZX [N20/N21]	B306

**DACIA**

Dokker [FE/FK]	B310
Dokker [FE/KE]	B310



Duster [HS]	B311
Lodgy [JS]	B312
Logan [LS]	B312
Logan [L8]	B313
Logan MCV [KS/FS]	B313
Logan MCV [K8]	B314
Logan Pick-Up [US]	B314
Nova	B315
Sandero [BS]	B315
Sandero [B8]	B316
Serie 1300	B316
Solenza	B316

**DAEWOO**

Cielo	B316
Espero	B316
Espero [KLEJ]	B316
Evanda	B317
Kalos Hatchback [T200]	B317
Kalos [T200]	B317
Korando [KJ]	B317
Lacetti [J200]	B317
Lacetti [T200]	B318
Lanos Hatchback [T100]	B318
Lanos [T100]	B318
Leganza [V100]	B319
Matiz	B319
Matiz II	B319
Matiz [M100]	B319
Musso [FJ]	B320
New Matiz	B320
New Prince	B320
Nexia	B320
Nexia Hatchback [KLETN]	B321
Nexia [KLETN]	B321
Nubira Hatchback [J100]	B322
Nubira [J100]	B322
Nubira [J150]	B323
Nubira [J200]	B323
Nubira Station Wagon [J100]	B323
Nubira Station Wagon [J150]	B324
Nubira Station Wagon [J200]	B324
Prince	B324
Rezzo [U100]	B324
Sens [TF698]	B325
Super Salon	B325
Tico [KLY3]	B325
Tico [Y3S11]	B325

**DAIHATSU**

Applause	B325
Charade	B325
Charade [G2]	B326
Charade Hatchback [G2]	B326
Cuore [L2]	B326



de

## Inhaltsübersicht (Fortsetzung)

en

## Contents overview (continued)

fr

## Sommaire (suite)

it

## Indice (seguito)

es

## Índice (continuación)



Feroza	B326
Materia	B326
Rocky	B326
Sirion II [M3]	B327
Terios [J1]	B327
Terios [J2]	B327

### DODGE

Avenger [JS]	B327
Caliber [PM]	B327
Caliber [P3]	B327
Caravan [AS]	B327
Caravan [NS]	B327
Caravan [RS]	B328
Dakota [AN]	B328
Durango [DN]	B328
Grand Caravan [AS]	B328
Intrepid [LH]	B328
Stratus [JS]	B329

### FERRARI

456	B329
512	B329

### FIAT

Albea [172]	B329
Barchetta [183]	B330
Brava	B331
Brava [182 MY 95]	B331
Brava [182 MY 98]	B333
Bravo [182 MY95]	B334
Bravo [182 MY98]	B336
Bravo [198]	B338
Bravo [198 MY07]	B338
Bravo [198 MY10]	B339
Cinquecento [170]	B340
Coupé [175 MY93]	B341
Coupé [175 MY96]	B342
Croma [154 MY90]	B342
Croma [194 MY05]	B344
Doblo	B344
Doblo Cargo [223..]	B344
Doblo Cargo [223]	B346
Doblo Cargo [263]	B346
Doblo [Fase I]	B347
Doblo [223 MY00]	B347
Doblo [223 MY05]	B348
Doblo [263]	B348
Ducato	B349
Ducato Cargo	B349
Ducato Minibus	B350
Ducato 10 [230]	B350
Ducato 10 [290]	B352
Ducato 11 [244]	B353
Ducato 11 [250]	B354



Ducato 12 [290]	B355
Ducato 14 [230]	B356
Ducato 14 [290]	B358
Ducato 15 [244]	B359
Ducato 15 [250]	B361
Ducato 17 [250]	B362
Ducato 18 [230]	B363
Ducato 18 [244]	B365
Ducato 18 [290]	B366
Ducato 20 [250]	B366
Ducato 110 [250]	B368
Ducato 115 [250]	B368
Ducato 130 [250]	B368
Ducato 140 [290]	B368
Ducato 150 [250]	B369
Ducato 180 [250..]	B369
Ducato [290]	B369
Fiorino Furgao	B370
Fiorino [146..]	B370
Fiorino [225..]	B371
Freemont [JC]	B371
Grande Punto [199]	B371
Idea [350]	B372
Linea [110]	B373
Linea [323]	B373
Marea	B374
Marea Weekend	B375
Marea [185]	B375
Marengo [259..]	B380
Marengo [285..]	B381
Multipla [186..]	B382
Palio	B384
Palio [Fase I]	B384
Palio [Fase II]	B385
Palio Weekend [Fase I]	B385
Palio Weekend [178..]	B386
Palio [178..]	B389
Panda Cross [312]	B390
Panda [141..]	B391
Panda [169..]	B392
Panda [169]	B395
Panda [312..]	B396
Petra [172..]	B396
Punto Cabrio [176]	B396
Punto Evo [199]	B398
Punto Grande Abarth SS [199]	B399
Punto Grande Abarth [199]	B399
Punto Grande [199]	B399
Punto GT [176]	B401
Punto Van [276]	B402
Punto Van [288]	B402
Punto [176]	B404
Punto [188]	B408
Punto [199]	B412
Qubo [300..]	B413



Scudo [222..]	B413
Scudo [270]	B414
Scudo [272..]	B415
Sedici [189]	B415
Seicento [187..]	B415
Siena	B416
Siena [Fase I]	B417
Siena [172..]	B417
Siena [178..]	B417
Stilo	B418
Stilo Multi Wagon [192..]	B419
Stilo [192..]	B421
Strada	B423
Strada [Fase I]	B424
Strada [Fase II]	B424
Strada [278]	B424
Talento	B425
Tempra	B425
Tempra SW [159]	B426
Tempra [159]	B428
Tipo	B430
Tipo [160..]	B431
Ulysse [179..]	B433
Ulysse [220..]	B434
Uno [Fase I]	B435
Uno Furgoneta	B436
Uno Furgoneta [Fase I]	B436
Uno Mille [Fase I]	B436
Uno Van [246..]	B436
Uno [146..]	B437
Uno [158..]	B439
500 [312]	B439
500C [312]	B440
500L [199]	B441

### FORD



B-Max [12]	B441
C-MAX [07]	B442
C-MAX [11]	B443
Cougar	B443
Courier	B443
Econovan	B444
EcoSport	B444
Escort	B444
Escort [Fase I]	B444
Escort [Fase II]	B444
Escort Hobby	B444
Escort Sedan [Fase II]	B444
Escort SW	B445
Escort VII Cabrio [95]	B445
Escort VII Express [95]	B446
Escort VII RS Cosworth [95]	B446
Escort VII RS [95]	B446
Escort VII Turnier [95]	B447
Escort VII XR3i Cabrio [95]	B448



Escort VII [95]	B449
Escort V/VI Cabrio [91]	B450
Escort V/VI Express [91]	B451
Escort V/VI RS [91]	B451
Escort V/VI Turnier [91]	B452
Escort V/VI XR3i Cabrio [91]	B453
Escort V/VI XR3i [91]	B453
Escort V/VI [91]	B454
Fairlane [NC II]	B455
Fairlane [NL]	B455
Falcon	B455
Falcon [EF]	B455
Falcon Utility [XG]	B455
Fiesta	B456
Fiesta [Fase II]	B456
Fiesta [Fase III]	B456
Fiesta III Courier [89]	B456
Fiesta III [89]	B456
Fiesta IV Courier [96]	B459
Fiesta IV [96]	B459
Fiesta V [02]	B460
Fiesta VI [08]	B461
Fiesta VII [13]	B462
Focus C-MAX [04]	B463
Focus ECO IV [15]	B463
Focus [Fase I]	B464
Focus [Fase II]	B464
Focus [GA]	B464
Focus I Turnier [99]	B464
Focus I [99]	B466
Focus II Cabriolet [06]	B468
Focus II Turnier [04]	B468
Focus II Turnier [08]	B470
Focus II [04]	B471
Focus II [08]	B472
Focus III Turnier [11]	B473
Focus III [11]	B474
Focus IV Turnier [15]	B475
Focus IV [15]	B475
Focus Sedan [Fase I]	B475
Focus Sedan [Fase II]	B476
Focus Turnier [15]	B476
Focus [15]	B476
Fusion [02]	B477
Galaxy [00]	B477
Galaxy [06]	B478
Galaxy [95]	B479
Granada III Estate [92]	B479
Granada III [92]	B480
Ka [Fase I]	B480
Ka [08]	B480
Ka [97]	B481
Kuga [DM2]	B481
Kuga [08]	B481
Kuga [13]	B482



nl

**Inhoudsopgave**  
(vervolg)

	
Maverick [UDS, UNS]	B482
Mondeo	B482
Mondeo I Turnier [93]	B482
Mondeo I [93]	B483
Mondeo I [97]	B485
Mondeo II Turnier [97]	B485
Mondeo II [97]	B486
Mondeo III Turnier [01]	B487
Mondeo III [01]	B488
Mondeo IV Turnier [07]	B490
Mondeo IV [07]	B491
Orion	B493
Probe	B493
Puma [ECT]	B493
Ranger	B493
Ranger [06]	B493
Scorpio I Turnier [92]	B494
Scorpio I [92]	B494
Scorpio II Turnier [95]	B494
Scorpio II [95]	B495
Serie F	B495
S-MAX [06]	B496
Streetka	B497
Tourneo Connect [02]	B497
Tourneo Connect [13]	B497
Tourneo Courier	B498
Transit	B498
Transit Connect	B498
Transit Connect [02]	B498
Transit Connect [13]	B499
Transit Courier	B499
Transit Custom [13]	B499
Transit Euroline [00]	B499
Transit Euroline [06]	B499
Transit Euroline [12]	B500
Transit Euroline [95]	B500
Transit Nugget [00]	B501
Transit Nugget [06]	B501
Transit Nugget [12]	B502
Transit Nugget [95]	B502
Transit Tourneo Custom [13]	B502
Transit Tourneo [00]	B503
Transit Tourneo [06]	B503
Transit Tourneo [12]	B504
Transit Tourneo [95]	B504
Transit [00]	B504
Transit [06]	B527
Transit [12]	B530
Transit [14]	B533
Transit [92]	B533
Transit [95]	B534
<b>GAZ</b>	
Volga [311]	B535



sv

**Innehållsöversikt**  
(fortsättning)

	
<b>HOLDEN</b>	
Astra [G]	B535
<b>HONDA</b>	
Accord	B536
Accord Aerodeck [CB/CC/CD/CE]	B536
Accord [CF]	B536
Accord [CG]	B536
Accord [CM]	B536
Accord Coupé [CB/CC/CD/CE]	B536
Accord Sedan [CC]	B536
Accord Sedan [CE/CF]	B537
Accord Tourer [CL/CN/CM]	B537
City	B537
City [GM]	B537
City New [MN]	B537
Civic	B538
Civic Aerodeck [MB/MC]	B538
Civic Coupé	B538
Civic Coupé [EJ]	B539
Civic Coupé [EK]	B539
Civic CRX [EG/EH]	B539
Civic [EJ/EK]	B539
Civic [ES]	B539
Civic Fastback [MA]	B539
Civic Fastback [MB/MC]	B540
Civic Hatchback [EG/EH]	B540
Civic Hatchback [EJ/EK]	B541
Civic Hatchback [EU/EP]	B541
Civic Hatchback [FK/FN]	B541
Civic Hybrid [ES]	B542
Civic Sedan	B542
Civic Sedan [EG/EH]	B542
Civic Sedan [EJ/EK]	B542
Civic Sedan [ES]	B543
Civic Shuttle [EC/ED/EE]	B543
Civiv Sedan [EJ/EK]	B543
Concerto Hatchback	B543
Concerto Sedan	B544
CR-V	B544
CR-V [RD]	B544
Fit	B545
Fit [GD]	B545
HR-V [GH]	B545
Jazz	B545
Jazz [GD]	B546
Jazz [GE/GG]	B546
Legend	B546
Legend Coupé	B546
Logo	B546
Prelude [BB]	B546
Shuttle	B547
Vigor	B547

pt

**Vista geral**  
**do conteúdo**  
(continuação)



	
<b>HYUNDAI</b>	
Accent	B547
Accent blue [RB]	B547
Accent Hatchback [LC]	B547
Accent Hatchback [MC]	B548
Accent Hatchback [X3]	B548
Accent [LC]	B549
Accent [MC, MCT]	B549
Accent [RB]	B550
Accent [X3]	B550
Atos [MX]	B550
Atos Prime [MX]	B551
Avante [J2]	B551
Azera	B551
Coupé [GK]	B552
Coupé [RD]	B552
Elantra Hatchback [XD]	B552
Elantra [HD]	B553
Elantra [J1]	B553
Elantra [J2]	B553
Elantra VI	B554
Elantra [XD]	B554
Excel Hatchback [X2]	B555
Excel Hatchback [X3]	B555
Excel [X2]	B555
Excel [X3]	B555
Getz [BT/BU]	B556
Getz [TB]	B556
Grace	B557
Grandeur [TG]	B557
H 100	B557
H-1	B558
i10 [PA]	B558
i20 [GB]	B558
i20 [PB, PBT]	B558
i20 [PB/PBT]	B559
i30 CW [FD/FDH]	B559
i30 [FD/FDH]	B560
Lantra [J1]	B560
Lantra [J2]	B560
Lantra Kombi [J2]	B561
Matrix [FC]	B562
Pony [X2]	B562
Pony [X3]	B563
Santa Fe [SM]	B563
Santro [MX]	B563
Satellite	B564
Satnta Fe [DM]	B564
Scoupe	B564
Solaris Hatchback [RB]	B564
Solaris [RB]	B564
Sonata [EF]	B564
Sonata [NF]	B565
Sonata V [EF]	B565

cs

**Přehled obsahu**  
(pokračování)

ru

**Оглавление**  
(продолжение)

	
Sonata [Y3]	B565
Starex	B565
Tiburón [RD]	B565
Trajet [FO]	B566
Trajet XG	B566
Tucson [JM]	B566
Verna [LC]	B566
XG [F]	B566
<b>INFINITI</b>	
EX [J50]	B567
FX [S51]	B567
FX50 [S51]	B567
G Cabrio [HV36]	B567
G Coupé [CV36]	B568
G [V36]	B568
M [Y50]	B568
M [Y51]	B568
QX50	B569
QX70 [S51]	B569
Q60 Cabrio	B569
Q60 Coupé	B569
Q70 [Y51]	B569
<b>INNOCENTI</b> <b>(NUOVA INNOCENTI)</b>	
Elba	B569
Mille	B570
<b>ISUZU</b>	
Trooper [UB]	B570
<b>IVECO</b>	
Daily	B570
Daily Chassi	B570
Daily Furgao	B571
Daily MaxiVan	B571
Daily [00]	B571
Daily [06]	B572
Daily [09]	B573
Daily [12]	B575
Daily [14]	B575
Scudato	B575
<b>JAGUAR</b>	
Daimler	B576
XJ 6	B576
XJ 12	B576
X-Type	B576
X-Type Estate	B577
<b>JEEP</b>	
Cherokee	B578
Cherokee [XJ]	B578
Compass [MK]	B578

de

**Inhaltsübersicht**  
(Fortsetzung)

en

**Contents overview**  
(continued)

fr

**Sommaire**  
(suite)

it

**Indice**  
(seguito)

es

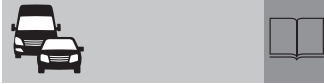
**Índice**  
(continuación)

Compass [PK]	B578
Grand Cherokee	B578
Grand Cherokee [WG]	B579
Patriot [MK]	B579
Wagoneer [SJ]	B579
Wrangler [TJ]	B579

**KIA**

Avella	B579
Cee'd [ED/FF2]	B579
Cee'd Sporty Wagon [ED/FF2]	B580
Cerato [FE]	B580
Cerato Hatchback [FE]	B581
Clarus [GC]	B581
Clarus Kombi [GC]	B581
Forte	B581
K 2500	B581
K 2900	B581
Mentor II [FX]	B582
Mentor II Hatchback [FX]	B582
Picanto	B582
Picanto [BA]	B582
Picanto [TA]	B582
Pregio [TB]	B583
Pro Cee'd [ED]	B583
Rio [DC]	B583
Rio Hatchback [JB, DE]	B583
Rio Hatchback [UB]	B584
Rio [JB, DE]	B584
Rio Kombi [DC]	B584
Rio [UB]	B584
Sephia I [FA]	B584
Shuma II [FB]	B584
Shuma II Hatchback [FB]	B584
Sorento [JC]	B585
Spectra [FB]	B585
Spectra Hatchback	B585
Sportage [JA]	B585
Sportage [JE]	B586

**LADA**

Forma	B586
Granta	B586
Kalina	B586
Kalina Hatchback	B586
Kalina Kombi	B586
Niva	B587
Priora	B587
Priora Hatchback	B587
Priora Kombi	B587
Samara	B587
Samara Fun	B588
Samara Hatchback	B588
Serie 110	B588
Serie 111	B588

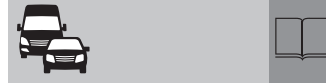

Serie 112	B588
Serie 114	B588
Serie 115	B589
Serie 2100	B589
Serie 2114	B589
Serie 21000	B589
Toscana	B589
4x4	B590

**LANCIA**

Dedra Berlina [835]	B590
Dedra Station Wagon [835]	B592
Delta [831]	B593
Delta [836]	B594
Delta [844]	B595
Kappa Berlina [838]	B596
Kappa Coupé [838]	B597
Kappa Station Wagon [838]	B597
Lybra Berlina [839]	B598
Lybra Station Wagon [839]	B600
Musa [350]	B602
Phedra [179]	B603
Thema Berlina [104]	B603
Thema Station Wagon [104]	B604
Thesis [841]	B604
Y 10 [156]	B604
Y [840]	B605
Ypsilon [312]	B606
Ypsilon [843]	B606
Zeta [122]	B607

**LAND ROVER GROUP**

Defender 90	B608
Defender 110	B608
Defender 130	B608
Discovery I	B609
Discovery II	B609
Discovery II [LT, LJ]	B609
Discovery II [LT, LJ]	B610
Discovery III [TAA]	B610
Discovery IV [LA]	B610
Freelander II	B610
Freelander [LN]	B610
Freelander 2 [LF]	B611
Range Rover I	B611
Range Rover II [LP]	B611
Range Rover III [LM L322]	B612
Range Rover IV [LG]	B612
Range Rover [LW L494]	B612
Range Rover Sport [LS L320]	B612
Range Rover Sport [LW L494]	B612

**LEXUS**

GX [J1]	B613
LX [J1]	B613

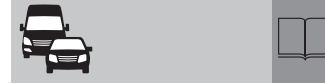

LX [J2]	B613
LX [J8]	B613
RX [U1]	B613

**MARUTI**

Omni	B614
Zen	B614
800 [MB 308]	B614

**MAZDA**

BT-50 [UN]	B614
Demio [DW]	B614
E-Serie	B614
Marathon	B615
MPV [LV]	B615
MPV [LW]	B615
MX-3 [EC]	B616
MX-5 [NA]	B616
MX-5 [NB]	B616
MX-5 [NC]	B617
MX-6 [GE]	B617
Premacy [CP]	B617
RX-7 Coupé [FD]	B618
RX-8 [FE]	B618
RX-8 [SE]	B618
Serie B [UF]	B618
Serie B [UN]	B618
Serie E	B619
Tribute	B619
Tribute [EP]	B619
Xedos-6 [CA]	B619
2 [DE]	B620
2 [DY]	B620
3 [BK]	B621
3 [BL]	B621
3 Hatchback [BK]	B621
3 Hatchback [BL]	B622
5 [CR]	B623
5 [CW]	B623
6 Fastback [GG/GY]	B623
6 Fastback [GH]	B623
6 [GG/GY]	B624
6 [GH]	B624
6 Sedan [GG/GY]	B624
6 Wagon [GG/GY]	B624
6 Wagon [GH]	B625
121 [DB]	B625
121 [JA/JB]	B625
121 [Soho]	B626
323 Astina [BA]	B626
323 [BA]	B626
323 [BG]	B626
323 [BJ]	B626
323 F Hatchback [BA]	B627
323 Hatchback [BA]	B627

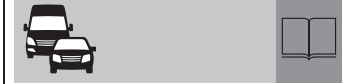

323 Hatchback [BF]	B628
323 Hatchback [BG]	B628
323 Hatchback [BJ]	B629
323 Sedan [BA]	B630
323 Sedan [BF]	B630
323 Sedan [BG]	B630
323 Wagon [BW]	B631
626 Fastback [GF]	B631
626 [GE]	B631
626 [GF]	B632
626 Hatchback [GE]	B633
626 Hatchback [GF]	B634
626 Wagon [GV]	B635
626 Wagon [GW]	B635

**MERCEDES-BENZ**

Citan [415]	B636
Classe A [168]	B636
MB	B636
Serie A [168]	B637
Serie A [169]	B638
Serie B [245]	B640
Serie C (Coupé) [204]	B641
Serie C (Sportcoupe) [203]	B642
Serie C (T-Modell) [202]	B644
Serie C (T-Modell) [203]	B646
Serie C (T-Modell) [204]	B649
Serie C (T-Modell) [205]	B652
Serie C [202]	B652
Serie C [203]	B659
Serie C [204]	B663
Serie C [205]	B666
Serie CL (Coupé) [140]	B667
Serie CL (Coupé) [215]	B667
Serie CL (Coupé) [216]	B668
Serie CLC [203]	B668
Serie CLK (Cabrio) [208]	B669
Serie CLK (Cabrio) [209]	B670
Serie CLK (Coupé) [208]	B672
Serie CLK (Coupé) [209]	B673
Serie CLS (Coupé) [218]	B676
Serie CLS (Shooting Brake) [218]	B677
Serie CLS [219]	B677
Serie E (Cabrio) [124]	B678
Serie E (Cabrio) [207]	B679
Serie E (Coupé) [124]	B680
Serie E (Coupe) [207]	B681
Serie E (Coupé) [207]	B682
Serie E (T-Model) [212]	B683
Serie E (T-Modell) [124]	B683
Serie E (T-Modell) [210]	B686
Serie E (T-Modell) [211]	B690
Serie E (T-Modell) [212]	B694
Serie E [124]	B695

nl

**Inhoudsopgave**  
(vervolg)

sv

**Innehållsöversikt**  
(fortsättning)

pt

**Vista geral**  
**do conteúdo**  
(continuação)

cs

**Přehled obsahu**  
(pokračování)

ru

**Оглавление**  
(продолжение)

Serie E [210]	B698
Serie E [211]	B703
Serie E [212]	B707
Serie G [461]	B708
Serie G [463]	B709
Serie GL [164]	B711
Serie GLK [204]	B711
Serie ML [163]	B711
Serie ML [164]	B712
Serie R [251]	B713
Serie S (Coupé) [140]	B713
Serie S [140]	B714
Serie S [220]	B716
Serie S [221]	B718
Serie SL [129]	B719
Serie SL [230]	B721
Serie SLK [170]	B722
Serie SLK [171]	B722
Serie SLR (Coupé) [199]	B724
Serie SLR (Roadster) [199]	B724
Serie V [447]	B724
Serie V [638]	B724
Serie 190 [201]	B725
Sprinter	B726
Sprinter [NCV3]	B727
Sprinter [T1N]	B736
Vaneo [414]	B748
Viano [639]	B749
Vito [638]	B751
Vito [639]	B753
2t [T1]	B756
3t [T1]	B757
4t [T1]	B757
311 Sprinter [909]	B758
411 Sprinter [909]	B758

**MG**

MG TF	B759
MGF	B759
ZR	B759
ZS	B760
ZT	B761
ZT-Tourer	B761

**MINI (BMW)**

Cooper Cabrio [R 52]	B762
Cooper Cabrio [R 57]	B762
Cooper Cabrio [R 58]	B762
Cooper Clubman [R 55]	B763
Cooper Clubvan [R 55]	B763
Cooper Countryman [R 60]	B763
Cooper Coupé [R 58]	B764
Cooper One Cabrio [R 52]	B764
Cooper One Cabrio [R 57]	B764
Cooper One Clubman [R 55]	B765



Cooper One Countryman [R 60]	B765
Cooper One [R 50]	B765
Cooper One [R 56]	B766
Cooper Paceman [R 61]	B766
Cooper [R 50]	B766
Cooper [R 56]	B767
Cooper Roadster [R 59]	B767
Cooper S [R 53]	B767
John Cooper Works Cabrio [R 52]	B768
John Cooper Works Cabrio [R 57]	B768
John Cooper Works Clubman [R 55]	B768
John Cooper Works Countryman [R 60]	B768
John Cooper Works Coupé [R 58]	B768
John Cooper Works Paceman [R 61]	B769
John Cooper Works [R 53]	B769
John Cooper Works [R 56]	B769
John Cooper Works Roadster [R 59]	B769

**MITSUBISHI**

ASX [GA]	B769
Canter	B770
Canter [FE]	B770
Carisma [DA]	B770
Carisma Hatchback [DA]	B771
Colt Cabrio [CZ]	B773
Colt [CA/CC]	B773
Colt [CJ]	B774
Colt [CZ]	B774
Colt Plus	B775
Eclipse [D2/3]	B775
Galant	B775
Galant [EA]	B776
Galant [E5...8]	B776
Galant Hatchback [E5...8]	B777
Galant Station Wagon	B777
Galant Station Wagon [EA]	B777
Grandis	B778
i-MiEV	B778
L 200	B778
L 200 Endeavor	B778
L 200 Forte [K7]	B778
L 200 [KA]	B779
L 200 [KB]	B779
L 200 [KL]	B779
L 200 [K0-K3]	B780
L 200 [K6/K7]	B780
L 300 Truck [L]	B781
L 300 Truck [P]	B781



L 300 Van [P]	B782
L 300 Wagon [P]	B782
L 400	B783
Lancer	B783
Lancer [CA/CB/CD]	B783
Lancer [CC]	B784
Lancer [CK/CP/CN]	B784
Lancer [CS/CT]	B785
Lancer [CY/CZ]	B785
Lancer [C1/C3]	B785
Lancer [C6/C7]	B785
Lancer Evo4 [CK/CP/CN]	B785
Lancer Evo5/6 [CK/CP/CN]	B786
Lancer Evo7 [CS/CT]	B786
Lancer Evo8 [CS/CT]	B786
Lancer Hatchback [C6/C7]	B786
Lancer [MG21/41]	B787
Lancer Ralliart [CY/CZ]	B787
Lancer Sedan [CA/CB/CD]	B787
Lancer Sedan [CK/CP/CN]	B787
Lancer Sedan [C1/C3]	B788
Lancer Sportback [CX]	B788
Lancer Sportback Ralliart [CX]	B788
Lancer Station Wagon [CA/CB/CD]	B788
Lancer Station Wagon [CS/CT]	B788
Outlander	B789
Outlander [CU]	B789
Outlander [CW]	B789
Outlander [GF]	B790
Pajero Cabrio [V]	B790
Pajero [NH/NJ/NK]	B790
Pajero [NM]	B790
Pajero Pinin [H]	B791
Pajero Sport [K]	B791
Pajero Sport [KH]	B791
Pajero [V]	B791
Pajero [V60; V70]	B792
Pajero [V80; V90]	B793
Space Gear	B793
Space Runner	B794
Space Star [A0]	B794
Space Wagon [N]	B794
Spacestar [DG]	B795
Triton	B796
Triton [MJ]	B796
Triton [MK]	B796
3000 GT	B796

**NISSAN**

AD Van	B796
Almera Hatchback [N15]	B797
Almera Hatchback [N16E]	B798
Almera [H14/15/17]	B799
Almera Sedan [N15]	B799



Almera Sedan [N16]	B801
Almera Sedan [N16E]	B801
Almera Tino [V10M]	B802
Altima [L31]	B803
Altima [U13]	B803
Bluebird	B803
Bluebird Sylphy	B803
Cabstar	B803
Cabstar E [TLO]	B804
Cabstar [F 24]	B804
Cabstar [F23]	B804
Cabstar [F24]	B804
Cabstar ZZ	B804
Cabstar 20	B804
Cedric Sedan [Y30]	B804
Cedric Wagon [Y30]	B805
Cube [Z12]	B805
Evalia [M20M]	B805
E20	B805
Frontier	B805
Hardbody [D21]	B806
Hardbody [D22]	B806
Interstar [X70]	B806
Kubistar [X76]	B807
March	B807
Maxima [A34]	B808
Maxima [J30]	B808
Maxima QX [A32]	B808
Maxima QX [CA33]	B808
Micra CC [K12E]	B808
Micra [K11E]	B809
Micra [K12E]	B810
Micra [K13K]	B811
Navara [D40]	B811
Note [E11]	B811
Note [E11E]	B811
Note [E12]	B812
NP300 [D22SS]	B812
NV200 [M20]	B812
NV200 [M20M]	B813
Pathfinder	B813
Pathfinder [D21]	B813
Pathfinder [R50]	B813
Patrol GR [Y60]	B814
Patrol GR [Y61]	B814
Patrol [260]	B815
Pickup [D21]	B815
Pickup [D22]	B815
Pixo Hatchback [UA0]	B816
Prairie Pro [M11]	B817
Primaster [X83]	B817
Primera Hatchback [P10E]	B817
Primera Hatchback [P11E]	B818
Primera Hatchback [P12E]	B821
Primera [P11E]	B822

de

**Inhaltsübersicht**  
(Fortsetzung)

en

**Contents overview**  
(continued)

fr

**Sommaire**  
(suite)

it

**Indice**  
(seguito)

es

**Índice**  
(continuación)

Primera [P12E]	B822
Primera Sedan [P10E]	B823
Primera Sedan [P11E]	B824
Primera Wagon [P12E]	B827
Primera Wagon [WP11E]	B828
Primera Wagon [W10]	B829
Pulsar	B830
Pulsar [C13]	B830
Pulsar Hatchback [N14]	B830
Pulsar Hatchback [N15]	B830
Pulsar [N14]	B831
Pulsar [N16]	B831
Pulsar Sedan [N15]	B831
Qashqai [J10]	B832
Qashqai+2 [JJ10]	B833
Quest [V40]	B833
Safari	B833
Sentra	B834
Sentra [B17R]	B834
Serena [C23M]	B834
Sunny	B834
Sunny Hatchback [N14]	B835
Sunny Neo [N16]	B836
Sunny [N17K]	B836
Sunny Sedan [N14]	B836
Sunny Wagon [Y10]	B837
Teana	B837
Teana [J31]	B838
Teana [J32]	B838
Teana [J32R]	B838
Terrano I [WD21]	B838
Terrano II [R20]	B838
Tiida	B840
Tiida [C11]	B840
Tiida Hatchback [C11]	B840
Tiida Hatchback [C11X]	B841
Tiida Latio	B841
Tiida Latio [SC11]	B841
Trade	B841
Urvan [E24]	B841
Vanette Cargo [C23M]	B842
Vanette [C220]	B842
Xterra	B842
X-Trail	B842
X-Trail [T30]	B843
X-Trail [T31]	B843
X-Trail [T31R]	B844
100 NX [B13]	B844
300 ZX [Z32]	B844
350 Z Cabriolet [Z33]	B845
370 Z Coupé [Z34]	B845
370 Z Roadster [Z34]	B845
370Z Coupé [Z34]	B845

**OPEL**

Adam	B845
Agila [A]	B846
Agila [B]	B847
Antara	B847
Arena	B847
Astra Cabrio [F]	B848
Astra Cabrio [G]	B849
Astra Caravan [F]	B851
Astra Caravan [G]	B852
Astra Caravan [H]	B856
Astra Classic Caravan [F]	B859
Astra Classic [F]	B860
Astra Coupé [G]	B860
Astra [F]	B861
Astra [G]	B863
Astra GTC [H]	B868
Astra GTC [J]	B870
Astra [H]	B870
Astra [J]	B873
Astra Limousine [J]	B874
Astra Sporte Tourer [J]	B874
Astra Sports Tourer [J]	B874
Astra TwinTop [H]	B875
Calibra	B876
Campo Pick-Up [TF0]	B877
Campo Pick-Up [TF1]	B877
Cascada	B877
Combo	B878
Combo [D]	B879
Combo [Tour]	B879
Corsa [A]	B880
Corsa [B]	B883
Corsa [C]	B884
Corsa [D]	B886
Corsa [E]	B889
Corsa Hatchback [C]	B889
Frontera [A]	B889
Frontera [B]	B890
Insignia Sports Tourer [35]	B891
Insignia [68]	B891
Insignia [69]	B892
Meriva [A]	B892
Meriva [B]	B893
Monterey [A]	B894
Monterey [B]	B894
Movano [A]	B894
Omega [A]	B896
Omega [B]	B899
Signum	B900
Sintra	B901
Tigra [A]	B901
Tigra TwinTop [B]	B902
Vectra [A]	B902



Vectra [B]	B905
Vectra [C]	B906
Vectra Caravan [B]	B908
Vectra Caravan [C]	B909
Vivaro	B911
Zafira [A]	B912
Zafira [B]	B914
Zafira [C]	B914

**PEUGEOT**

Bipper [A9]	B915
Boxer	B915
Boxer [U3]	B915
Boxer [U5]	B917
Boxer [U9]	B918
Expert [G9]	B920
Expert [U64]	B920
Partner	B922
Partner [B9]	B922
Partner [M4]	B923
Partner [M5]	B925
Ranch [M4]	B927
RCZ R [T75]	B928
RCZ [T75]	B928
106 [S1]	B928
106 [S2]	B931
107 [B0]	B932
108 [B3]	B933
205	B933
205 Pickup	B937
206	B938
206 CC [T1]	B939
206 Sedan [T1]	B940
206 SW	B940
206 SW [T1]	B941
206 [T1]	B942
206+ [T3E]	B946
207+	B947
207 [A7]	B947
207 CC [A7]	B949
207 SW [A7]	B950
208	B951
301 [M3]	B952
306	B953
306 Break [N5]	B953
306 Cabriolet [N3]	B955
306 Cabriolet [N5]	B956
306 [N3]	B958
306 [N5]	B962
307 Break/SW [T5]	B965
307 Break/SW [T6]	B967
307 CC [T5]	B968
307 CC [T6]	B968
307 Sedan [T6]	B969
307 [T5]	B970



307 [T6]	B971
308 CC [T7]	B973
308 SW [T7]	B973
308 [T7]	B974
405 Break [4]	B975
405 [4]	B976
405 [15]	B978
406 Break [D8]	B978
406 Break [D9]	B979
406 Coupé [D8]	B981
406 Coupé [D9]	B981
406 [D8]	B982
406 [D9]	B984
407 Coupé [D2]	B985
407 [D2]	B986
407 SW [D2]	B987
508 SW [W2]	B989
508 [W2]	B989
605 [Y30]	B989
607 [Z8]	B990
607 [Z9]	B991
806 [U60]	B991
807 [V2]	B992
1007 [A8]	B993
2008 [A94]	B994
3008 [T8]	B994
4007 [I3]	B995
5008 [T8]	B995

**PORSCHE**

Boxster [986]	B995
Boxster [987]	B996
Carrera GT Convertible [980]	B996
Carrera GT [980]	B996
Cayenne [9PA]	B996
Cayman [987C]	B997
911 Cabriolet [996]	B997
911 Cabriolet [997]	B997
911 Carrera Cabriolet [996]	B997
911 Speedster [997]	B998
911 Targa [993]	B998
911 Targa [996]	B998
911 Targa [997]	B998
911 [993]	B998
911 [996]	B998
911 [997]	B999
918 Spyder [918]	B999
928	B999
968	B999

**PROTON**

Arena Pickup	B999
GEN2	B999
Persona [C90 CC0]	B1000
Persona [C90 CC1]	B1000

nl

**Inhoudsopgave**  
(vervolg)

sv

**Innehållsöversikt**  
(fortsättning)

pt

**Vista geral**  
**do conteúdo**  
(continuação)

cs

**Přehled obsahu**  
(pokračování)

ru

**Оглавление**  
(продолжение)

Wira Aeroback	B1000
<b>RENAULT</b>	
Alpine [D503]	B1000
Avantime [XE0]	B1000
Captur [J5]	B1001
Clio I	B1001
Clio I [X57]	B1001
Clio II	B1005
Clio II [BB/CB/SB]	B1006
Clio II [BB07]	B1010
Clio II [CB01]	B1010
Clio II [LB02]	B1010
Clio II Sedan	B1010
Clio III [BR/CR]	B1010
Clio III Grandtour [KR]	B1012
Clio IV [BH]	B1013
Clio IV Grandtour [KH]	B1014
Duster [HS]	B1014
Espace II [J63]	B1015
Espace III [JE0]	B1016
Espace IV [JK]	B1017
Express	B1018
Express, Extra, Rapid [F40]	B1018
Fluence [L3]	B1019
Grand Scenic II [JM]	B1020
Grand Scenic III [JZ]	B1021
Kangoo I	B1021
Kangoo I [FC./KC.]	B1021
Kangoo II [Fase II]	B1025
Kangoo II [FW/KW]	B1025
Laguna I [B56]	B1026
Laguna I Grandtour [A56]	B1028
Laguna I Grandtour [K56]	B1028
Laguna I Grandtour [S56]	B1030
Laguna I [556]	B1030
Laguna II [BG.]	B1031
Laguna II Grandtour [KG.]	B1032
Laguna III [BT]	B1033
Laguna III Coupé [DT]	B1033
Laguna III Grandtour [KT]	B1033
Logan [LS]	B1033
Logan MCV [KS/FS]	B1035
Master [ADCU]	B1035
Master I	B1035
Master II	B1035
Megane	B1039
Megane [BA10]	B1039
Megane I Cabrio [X64]	B1039
Megane I Classic [X64]	B1041
Megane I Coupé [X64]	B1043
Megane I Grandtour [X64]	B1045
Megane I [X64]	B1045
Megane II Cabrio [EM]	B1048
Megane II Grandtour [KM.]	B1049



Megane II Hatchback [BM./CM./GM./SM.]	B1050
Megane II [LM]	B1051
Megane III CC [EZ]	B1052
Megane III Coupé [DZ]	B1052
Megane III Grandtour [KZ]	B1053
Megane III Hatchback [BZ]	B1053
Megane [L/BA00]	B1054
Megane III Hatchback [BZ]	B1054
Modus [FP/JP]	B1054
Safrane [B54]	B1056
Sandero [BS]	B1057
Scenic	B1058
Scenic [Fase I]	B1058
Scenic I [JA]	B1058
Scenic II [JM]	B1060
Scenic III [JZ]	B1061
Sport Spider	B1062
Symbol [L8]	B1062
Thalia [LB]	B1062
Thalia [LU]	B1064
Trafic	B1065
Trafic II [EL/FL/JL]	B1067
Twingo I [CO./SO.]	B1068
Twingo II [CN/GN]	B1070
Vel Satis [BJ]	B1070
Wind [E4]	B1070
Zoe [BF]	B1071
5	B1071
9 [L42]	B1073
11 [B37]	B1074
19 Cabrio [X53]	B1074
19 Sedan	B1075
19 [X53]	B1075
21 [L48]	B1078
21 Nevada [K48]	B1080
<b>ROLLS-ROYCE</b>	
Ghost [RR4]	B1081
Wraith [RR5]	B1081
<b>ROVER</b>	
Mini	B1082
Mini Cabrio	B1082
Mini Cooper	B1082
Mini Cooper Cabrio	B1082
Mini De Ville	B1082
Mini De Ville Cabrio	B1083
Mini Margrave	B1083
Mini Retro Rally	B1083
Serie 200	B1083
Serie 400	B1087
Serie 400 Coupé	B1090
Serie 400 Tourer	B1091
Serie 600	B1092



Serie 800	B1093
25	B1094
45	B1095
75	B1097
75 Tourer	B1097
100 Metro	B1097
100 Metro Cabrio	B1098
<b>SAAB (SAAB AUTOMOBILE AB)</b>	
9-3 Cabriolet [9400]	B1098
9-3 Cabriolet [9440]	B1098
9-3 Coupé [9400]	B1099
9-3 Kombi [9440]	B1100
9-3 [9400]	B1100
9-3 [9440]	B1101
9-3X [9440]	B1102
9-5 Kombi [9600]	B1103
9-5 [9600]	B1104
900 I Cabriolet	B1105
900 I Hatchback	B1106
900 II	B1106
900 II Cabriolet	B1107
900 II Coupé	B1108
9000	B1108
<b>SAIPA</b>	
Saipa 141	B1109
<b>SEAT</b>	
Alhambra [7V8]	B1109
Alhambra [7V9]	B1110
Alhambra [710]	B1111
Altea Freetrack [5P5, 5P8]	B1112
Altea Freetrack [5P5/5P8]	B1112
Altea XL [5P5]	B1114
Altea [5P1]	B1117
Arosa [6H1]	B1121
Cordoba Vario [6K5]	B1122
Cordoba [6K2]	B1124
Cordoba [6L2]	B1129
Exeo ST [3R5]	B1132
Exeo [3R2]	B1133
Ibiza SC [6J1]	B1134
Ibiza ST [6J8]	B1136
Ibiza [6J5]	B1136
Ibiza [6K1]	B1138
Ibiza [6L1]	B1145
Inca [6K9]	B1149
Leon Cupra R [1M1]	B1149
Leon Cupra SC [5F5]	B1150
Leon Cupra [1M1]	B1150
Leon Cupra [1P1]	B1151
Leon Cupra [5F1]	B1151
Leon SC [5F5]	B1151



Leon ST Cupra [5F8]	B1153
Leon ST [5F8]	B1153
Leon [1M1]	B1155
Leon [1P1]	B1159
Leon [5F1]	B1163
Marbella	B1165
Mii [KF1]	B1165
Terra	B1166
Toledo [KG3]	B1166
Toledo [1L2]	B1167
Toledo [1M2]	B1168
Toledo [5P2]	B1172
<b>SKODA</b>	
Citigo [NF1]	B1174
Fabia Combi [NJ5]	B1174
Fabia Combi [5J5]	B1175
Fabia Combi [6Y5]	B1178
Fabia [NJ3]	B1180
Fabia RS [5J2]	B1181
Fabia Schrägheck [6Y2]	B1181
Fabia [5J2]	B1183
Fabia [6Y3]	B1186
Favorit	B1187
Felicia Combi [6U5]	B1188
Felicia Fun [6UF]	B1188
Felicia [6U1]	B1189
Forman	B1189
Octavia Combi	B1189
Octavia Combi [1U5]	B1190
Octavia Combi [1Z5]	B1192
Octavia Combi [5E5]	B1197
Octavia RS Combi [5E5]	B1198
Octavia [1U2]	B1198
Octavia [1Z3]	B1201
Octavia [5E3]	B1205
Pick-Up [6U7]	B1206
Praktik [5J7]	B1206
Rapid [NA2]	B1208
Rapid [NH3]	B1208
Rapid Spaceback [NH1]	B1209
Roomster [5J7]	B1210
Superb Combi [3T5]	B1212
Superb [3T4]	B1214
Superb [3U4]	B1216
Superb [3V3]	B1217
Yeti	B1218
Yeti [5L7]	B1218
<b>SMART (MCC)</b>	
Forfour [454]	B1220
Fortwo Cabrio [450]	B1221
Fortwo Cabrio [451]	B1221
Fortwo Coupé [450]	B1221
Fortwo Coupé [451]	B1222

de

## Inhaltsübersicht (Fortsetzung)

en

## Contents overview (continued)

fr

## Sommaire (suite)

it

## Indice (seguito)

es

## Índice (continuación)



Fortwo ED Cabrio [451]	B1222
Fortwo ED Coupé [451]	B1222
Roadster Coupé [452]	B1223
Roadster [452]	B1223
Smart Cabrio [450]	B1223
Smart Coupé [450]	B1224
Smart Crossblade [450]	B1224

### SSANGYONG

Istana	B1225
Istana [L]	B1225
Korando [KJ]	B1225
Musso [MJ]	B1225

### STEYR (STEYR-DAIMLER-PUCH AG)

G	B1225
---	-------

### SUBARU

BRZ [Z10]	B1226
Forester [SF]	B1226
Forester [SG]	B1226
Forester [S12]	B1227
Forester [S13]	B1227
Impreza [G12]	B1227
Impreza [G23]	B1228
Impreza Kombi [GC, GF]	B1228
Impreza Kombi [GD, GG]	B1229
Impreza Outback [GD, GG]	B1230
Impreza Sedan [GC, GF]	B1230
Impreza Sedan [GD, GG]	B1231
Impreza Sedan [G12]	B1231
Impreza Sedan [G13]	B1232
Impreza WRX [G22]	B1232
Impreza WRX Hatchback [G12]	B1232
Impreza WRX Hatchback [G22]	B1233
Impreza WRX STI [G22]	B1233
Impreza WRX STI Hatchback [G22]	B1233
Impreza WRX STI 320R [G22]	B1233
Impreza WRX Wagon [G22]	B1233
Justy [G3X]	B1233
Justy [MA]	B1234
Justy [MS]	B1234
Justy [M3]	B1234
Legacy [BL/BP]	B1234
Legacy [B14]	B1235
Legacy Kombi [BE/BH]	B1235
Legacy Kombi [BL/BP]	B1236
Legacy Kombi [B14]	B1236
Legacy Outback [BE/BH]	B1237
Legacy Outback [BL/BP]	B1237
Legacy Sedan [BE/BH]	B1238
Legacy Station Wagon [B14]	B1238
Legacy Station Wagoni [B14]	B1239



Outback [B14]	B1239
SVX	B1239
Trezia [NLP]	B1239
Trezia [NSP]	B1239
WRX [V10]	B1239
XV [G33]	B1239

### SUZUKI

Alto Hatchback [AMF]	B1240
Alto Hatchback [EF]	B1240
Alto [MA]	B1240
Baleno Hatchback	B1240
Baleno Sedan	B1241
Baleno Wagon	B1241
Carry [ED]	B1241
Carry [FD]	B1241
Escudo	B1241
Grand Vitara	B1242
Grand Vitara Cabrio	B1242
Ignis Hatchback	B1242
Jimny	B1243
Jimny [FJ]	B1243
Kizashi	B1243
Liana Hatchback	B1243
Liana Sedan	B1244
Samurai	B1244
Samurai Cabrio	B1245
Splash [A5B]	B1245
Swift Cabrio [EA]	B1245
Swift Hatchback [EA]	B1245
Swift Hatchback [MA]	B1246
Swift Hatchback [MZ/EZ]	B1246
Swift [MA]	B1246
Swift [MZ/EZ]	B1247
Swift Sedan [EA]	B1247
SX4	B1247
SX4 Hatchback	B1247
Vitara Cabrio [ET]	B1248
Vitara Cabrio [OS]	B1248
Vitara [ET]	B1248
Vitara [SV]	B1249
Wagon R+ [EM]	B1249
Wagon R+ [MM]	B1249
X-90	B1250

### TATA (TELCO)

ACE	B1250
-----	-------

### TOFAS

Sahin [131]	B1250
-------------	-------

### TOYOTA

Auris [E15]	B1250
Auris [E15, JTN]	B1251
Auris [E15, NMT, SB1]	B1251





Auris [E18]	B1252
Auris Touring Sports [E18]	B1252
Avanza	B1253
Avensis Liftback [T22]	B1253
Avensis Liftback [T25]	B1255
Avensis [T22]	B1256
Avensis [T25]	B1257
Avensis [T27]	B1258
Avensis Verso [M2]	B1259
Avensis Wagon [T22]	B1259
Avensis Wagon [T25]	B1261
Avensis Wagon [T27]	B1262
Aygo	B1262
Aygo [B4]	B1263
bB	B1263
Camry	B1263
Camry Sedan	B1263
Camry [V1]	B1263
Camry [V2]	B1264
Camry [V3]	B1264
Camry Wagon [V1]	B1264
Camry [XV30]	B1264
Carina	B1264
Carina E Liftback [T19]	B1265
Carina E Sedan [T19]	B1266
Carina E Wagon [T19]	B1268
Celica Cabrio [T20]	B1269
Celica Coupé [T23]	B1269
Celica Liftback [T20]	B1269
Condor	B1270
Condor Estate	B1270
Conquest	B1270
Conquest [Carri]	B1270
Corolla Altis	B1270
Corolla [E9]	B1271
Corolla [E10]	B1271
Corolla [E11]	B1271
Corolla [E12]	B1272
Corolla [E14/E15]	B1274
Corolla [E15]	B1274
Corolla [E18]	B1274
Corolla Fielder	B1275
Corolla Hatchback [E10]	B1275
Corolla Hatchback [E11]	B1276
Corolla Hatchback [E12]	B1277
Corolla Liftback [E10]	B1277
Corolla Liftback [E11]	B1278
Corolla RunX [E12]	B1279
Corolla Sedan	B1279
Corolla Sedan [E10]	B1279
Corolla Sedan [E11]	B1280
Corolla Sedan [E12]	B1280
Corolla Station Wagon [E9]	B1281
Corolla Verso [E12]	B1281
Corolla Verso [R1]	B1281



Corolla Verso [R2]	B1282
Corolla Verso [R10/11]	B1282
Corolla Verso [R11]	B1283
Corolla Wagon	B1283
Corolla Wagon [E10]	B1283
Corolla Wagon [E11]	B1284
Corolla Wagon [E12]	B1285
Corona	B1286
Corona Sedan [T14]	B1286
Dyna	B1286
Dyna 100	B1287
Dyna 100 [Y2]	B1287
Dyna [150]	B1288
Dyna 150	B1288
Dyna 150 [Y2]	B1288
Echo	B1288
Estima	B1289
Fortuner	B1289
Funcargo	B1289
Hiace	B1289
Hiace Commuter	B1289
Hiace [H2]	B1289
Hiace [KLH]	B1290
Hiace [LXH]	B1290
Hiace [RCH]	B1290
Hiace Van [LH]	B1290
Hiace Van [LXH]	B1291
Hiace Van [ZH]	B1291
Hiace Wagon	B1291
Hiace Wagon [LH]	B1291
Hiace Wagon [ZH]	B1292
Hilux	B1292
Hilux [Africa]	B1292
Hilux [N5/N6]	B1292
Hilux [N14/N15]	B1293
Hilux [N15]	B1293
Hilux [N25]	B1293
Hilux [N26]	B1293
Hilux [N35]	B1294
Hilux Pickup [N8]	B1294
Hilux Pickup [N8...13]	B1294
Hilux Pickup [N14...19]	B1294
Hilux [Raider]	B1295
Hilux Vigo	B1295
Hilux Wagon [N8...13]	B1295
iQ	B1295
Isis	B1295
Ist	B1296
Kluger	B1296
Land Cruiser	B1296
Land Cruiser [J2]	B1296
Land Cruiser [J6/7/10]	B1297
Land Cruiser [J7]	B1297
Land Cruiser [J7/10]	B1297
Land Cruiser [J8]	B1298

nl

**Inhoudsopgave**  
(vervolg)

	
Land Cruiser [J9]	B1298
Land Cruiser [J10]	B1299
Land Cruiser [J12]	B1299
Land Cruiser [J15]	B1299
Land Cruiser [J20]	B1299
Land Cruiser Prado	B1300
Land Cruiser Prado [J9]	B1300
Land Cruiser Prado [J12]	B1300
Land Cruiser [105]	B1300
Limo	B1301
MR2 Cabrio [W3]	B1301
Paseo Coupé [L5]	B1301
Picnic	B1301
Porte	B1301
Previa	B1301
Previda	B1302
Prius	B1302
Prius [W20]	B1302
Prius [W30]	B1302
Prius [W35]	B1302
Probox Van	B1303
Quantum	B1303
Ractis	B1303
RAV4	B1303
RAV4 [A1]	B1303
RAV4 [A2]	B1304
RAV4 [A3]	B1304
RAV4 Cabrio [A1]	B1304
Rush	B1305
Sequoia	B1305
Starlet [P8]	B1305
Starlet [P9]	B1305
Succeed Van	B1306
Tarago	B1306
Tercel [L5]	B1306
Urban Cruiser [P1]	B1306
Verso-S	B1306
Vitz	B1307
Wish	B1307
Yaris [P1]	B1307
Yaris [P9]	B1309
Yaris [P9, JTD]	B1310
Yaris [P9, VNK]	B1310
Yaris [P12, VNK]	B1311
Yaris [P13, JTD]	B1311
Yaris [P13, VNK]	B1311
Yaris Verso [P2]	B1311
4-Runner [N13]	B1312
4-Runner [N18]	B1312
4-Runner [N21]	B1312
<b>UAZ</b>	
Hunter	B1313
Patriot	B1313
Pickup	B1313



sv

**Innehållsöversikt**  
(fortsättning)

	
<b>VAUXHALL</b>	
Adam	B1313
Agila [A]	B1314
Agila [B]	B1315
Antara	B1315
Arena	B1315
Astra	B1315
Astra Convertible [F]	B1316
Astra Convertible [G]	B1316
Astra Coupé [G]	B1316
Astra Estate [F]	B1317
Astra Estate [G]	B1318
Astra Estate [H]	B1320
Astra [F]	B1322
Astra [G]	B1323
Astra GTC [H]	B1325
Astra GTC [J]	B1327
Astra [H]	B1327
Astra [J]	B1329
Astra Sport Tourer	B1330
Astra Sports Tourer	B1330
Astra Sports Tourer [J]	B1330
Astra TwinTop [H]	B1331
Astra Van [F]	B1331
Astra Van [G]	B1332
Brava Pick-Up [TFO]	B1333
Brava Pick-Up [TF1]	B1333
Calibra	B1333
Carlton III	B1334
Cascada	B1336
Cavalier III	B1336
Combo	B1339
Combo [D]	B1340
Combo [Tour]	B1340
Corsa [B]	B1341
Corsa [C]	B1342
Corsa [D]	B1344
Corsa [E]	B1347
Frontera [A]	B1347
Frontera [B]	B1348
Insignia Sports Tourer [35]	B1348
Insignia [68]	B1349
Insignia [69]	B1350
Meriva [A]	B1350
Meriva [B]	B1351
Monterey [A]	B1352
Monterey [B]	B1352
Movano [A]	B1352
Nova	B1354
Omega [B]	B1356
Signum	B1357
Sintra	B1358
Tigra [A]	B1358
Tigra TwinTop [B]	B1358

pt

**Vista geral**  
**do conteúdo**  
(continuação)



	
Vectra [B]	B1359
Vectra [C]	B1361
Vectra Estate [B]	B1363
Vectra Estate [C]	B1365
Vivaro	B1366
Zafira [A]	B1368
Zafira [B]	B1369
Zafira [C]	B1370
<b>VOLVO</b>	
C30 [P14]	B1371
C70 Coupé	B1371
C70 I Cabrio	B1372
C70 II Cabrio	B1372
S40 I	B1373
S40 II [P11]	B1375
S60 I	B1376
S60 II	B1378
S70	B1378
S80 I	B1379
S80 II	B1381
S90	B1381
V40 Cross Country	B1381
V40 I	B1381
V40 II	B1383
V50 [P12]	B1384
V60	B1384
V70 I	B1385
V70 II	B1386
V70 III	B1388
V90	B1388
XC70 I	B1388
XC70 II	B1388
XC90	B1389
XC90 I	B1389
440	B1390
460	B1391
480	B1393
740	B1393
850	B1394
850 Kombi	B1395
940	B1396
960	B1397
<b>VW (VOLKSWAGEN)</b>	
Amarok [2H, S1]	B1398
Beetle Cabriolet [5C7]	B1398
Beetle [5C1]	B1400
Bora Variant [1J6]	B1401
Nova [1J2]	B1406
Bora [9D, 152]	B1412
Bora [9M2]	B1412
Caddy Panel Van [2K]	B1413
Caddy Pickup [9U7]	B1413
Caddy [SA]	B1413

cs

**Přehled obsahu**  
(pokračování)

ru

**Оглавление**  
(продолжение)

	
Caddy [2C]	B1414
Caddy [2K]	B1416
Caddy [9K9]	B1417
California T4 [70, 7D]	B1418
California T5 [7E]	B1423
California T5 [7H]	B1423
California T6 [SG]	B1424
Caravelle T4 [70, 7D]	B1425
Caravelle T5 [7E]	B1429
Caravelle T5 [7H]	B1429
Caravelle T6 [SG]	B1431
CC [358]	B1431
Corrado [50]	B1432
Crafter 30 [2E, 2F]	B1433
Crafter 30 [2E, 2F]	B1433
Crafter 35 [2E, 2F]	B1433
Crafter 35 [2E, 2F]	B1434
Crafter 50 [2E, 2F]	B1434
Crafter 50 [2E, 2F]	B1434
e-Golf [BE1]	B1434
Eos [1F7]	B1434
Eos [1F8]	B1438
e-up! [BL1]	B1439
Eurovan [70]	B1439
Fox	B1440
Fox [Fase I]	B1440
Fox [5Z1]	B1440
Gol III [5X]	B1441
Golf	B1441
Golf Alltrack [BA5]	B1441
Golf Cabriolet [1E, 1V]	B1442
Golf I Bakkie [15, 16]	B1442
Golf I [15, 16]	B1442
Golf I [17]	B1443
Golf III	B1443
Golf III Cabriolet [1E7]	B1444
Golf III Variant [1H5]	B1446
Golf III [1H1]	B1449
Golf III [1H1/1W1]	B1453
Golf III [1H4]	B1454
Golf IV	B1454
Golf IV Cabriolet [1E7]	B1455
Golf IV Station Wagon [1J5]	B1457
Golf IV Variant [1J5]	B1457
Golf IV [1J1]	B1462
Golf IV [9B1]	B1473
Golf Plus [5M1]	B1473
Golf Plus [5Z1]	B1476
Golf Sportsvan [AM1]	B1479
Golf V Variant [1K5]	B1479
Golf V [1K1]	B1480
Golf VI Cabriolet [517]	B1486
Golf VI Variant [AJ5]	B1487
Golf VI [5K1]	B1489
Golf VII Variant [BA5]	B1495



de

**Inhaltsübersicht**  
 (Fortsetzung)

en

**Contents overview**  
 (continued)

fr

**Sommaire**  
 (suite)

it

**Indice**  
 (seguito)

es

**Índice**  
 (continuación)

Golf VII [5G1]	B1496
Jetta	B1497
Jetta [AV2]	B1497
Jetta [AV3]	B1498
Jetta I	B1498
Jetta IV [1J2]	B1499
Jetta V [1K6]	B1500
Jetta [1H2/1W2]	B1500
Jetta [1K2]	B1500
Jetta [9M2]	B1504
Jetta [162]	B1505
Jetta [163]	B1508
Käfer [1]	B1509
Kombi	B1509
LT [2D, 2H]	B1510
LT [28, 29, 21]	B1512
Lupo [6X1]	B1513
Multivan T4 [70, 7D]	B1514
Multivan T5 [7E]	B1518
Multivan T5 [7H]	B1519
Multivan T6 [SG]	B1520
Multivan T6 [SSG]	B1520
New Beetle Cabriolet [1Y7]	B1521
New Beetle [1C1/9C1]	B1522
Pasat [3G2]	B1525
Passat Alltrack [3G5]	B1525
Passat Alltrack [365]	B1526
Passat [A32]	B1526
Passat [B5]	B1526
Passat CC [357]	B1527
Passat Variant [3B5]	B1529
Passat Variant [3B6]	B1532
Passat Variant [3C5]	B1537
Passat Variant [3G5]	B1543
Passat Variant [315/351/3A5]	B1543
Passat Variant [365]	B1545
Passat [3B2]	B1546
Passat [3B3]	B1550
Passat [3C2]	B1555
Passat [3G2]	B1560
Passat [312/351/3A2]	B1561
Passat [362]	B1563
Phaeton [3D]	B1564
Pointer [55]	B1565
Polo	B1565
Polo Classic	B1565
Polo Classic [6V2]	B1566
Polo Classic [9V8]	B1573
Polo Classic [9V8 2C4]	B1573
Polo Classic [80]	B1574
Polo Coupé [80]	B1574
Polo Hatchback	B1575
Polo Limousine [9N2]	B1575
Polo Playa [9V4]	B1575
Polo Sedan	B1576



Polo Sedan [612]	B1576
Polo Sedan [614]	B1577
Polo Variant [6V5]	B1577
Polo Vivo [6S1]	B1582
Polo [6C1]	B1583
Polo [6N1]	B1584
Polo [6N2]	B1589
Polo [6R1]	B1591
Polo [9N1]	B1593
Polo [9N2]	B1595
Polo [9N3]	B1595
Polo [9N4]	B1598
Polo [9V4]	B1598
Polo [80]	B1598
Scirocco R [138]	B1599
Scirocco [137]	B1600
Scirocco [138]	B1601
Sharan [7M8]	B1603
Sharan [7M9, 7M6]	B1603
Sharan [7N1]	B1605
Sharan [7N2]	B1605
Taro [7A]	B1605
Tiguan [5N1]	B1606
Tiguan [5N2]	B1606
Touareg [7LA]	B1607
Touareg [7L6]	B1608
Touran [1T1]	B1609
Touran [1T2]	B1610
Touran [1T3]	B1612
Touuran [1T3]	B1613
Transporter T4 [70, 7D]	B1613
Transporter T5 [7E]	B1617
Transporter T5 [7F]	B1618
Transporter T5 [7H]	B1618
Transporter T5 [7J]	B1620
Transporter T6 [SF]	B1620
Transporter T6 [SG]	B1621
up! [121]	B1621
Vento	B1621
Vento [1H2]	B1622

**ZAZ**

Sens [TF698]	B1626
--------------	-------





de

Radbremss-  
zylinder

en

Wheel-brake  
cylinders

fr

Cylindres de freins  
de roues

it

Cilindretti  
freno

es

Cilindros  
de rueda**0 204 011 ...**

<b>0 204 011 241</b>	23,8	NISSAN	Terrano II
<b>0 204 011 273</b>	25,4	NISSAN	Patrol

**0 204 062 ...**

<b>0 204 062 034</b>		FORD	Serie F
<b>0 204 062 035</b>		FORD	Serie F

**0 204 116 ...**

<b>0 204 116 124</b>	19	ALFA ROMEO	33 Berlina
<b>0 204 116 125</b>	19	ALFA ROMEO	33 Berlina
<b>0 204 116 159</b>	22,2	RENAULT	21 Nevada
<b>0 204 116 179</b>	20,6	PEUGEOT	306, 306 Break, 306 Cabriolet
<b>0 204 116 226</b>	20,6	PEUGEOT	206
<b>0 204 116 402</b>	22,2	SEAT	Terra
<b>0 204 116 403</b>	19,05	SEAT	Marbella

**0 204 716 ...**

<b>0 204 716 708</b>		NISSAN	Micra, Note, Sunny
----------------------	--	--------	--------------------

**0 986 AB8 ...**

<b>0 986 AB8 039</b>	20,64	PEUGEOT	206, 206 SW
<b>0 986 AB8 040</b>	20,64	PEUGEOT	206, 206 SW
<b>0 986 AB8 084</b>	20,64	TOYOTA	Avanza
<b>0 986 AB8 101</b>	15,88	MARUTI	800
<b>0 986 AB8 102</b>	25,4	MARUTI	Omni
<b>0 986 AB8 103</b>	25,4	MARUTI	Omni
<b>0 986 AB8 104</b>	25,4	MARUTI	Omni
<b>0 986 AB8 105</b>	25,4	MARUTI	Omni
<b>0 986 AB8 112</b>	15,88	TATA (TELCO)	ACE
<b>0 986 AB8 113</b>	15,88	TATA (TELCO)	ACE
<b>0 986 AB8 125</b>	22,23	CHEVROLET	Tavera
<b>0 986 AB8 126</b>	15,88	HYUNDAI	i10
<b>0 986 AB8 127</b>	15,88	HYUNDAI	i10
<b>0 986 AB8 130</b>	22,23	TOYOTA	Hilux
<b>0 986 AB8 134</b>	23,81	TOYOTA	Hilux Vigo
<b>0 986 AB8 135</b>	22,23	NISSAN	Triton
<b>0 986 AB8 136</b>	22,23	MITSUBISHI	Triton
<b>0 986 AB8 140</b>	22,23	TOYOTA	Hiace Commuter
<b>0 986 AB8 142</b>	22,23	TOYOTA	Hilux
<b>0 986 AB8 147</b>	17,46	HONDA	City, City New
<b>0 986 AB8 148</b>	15,88	HONDA	Fit, Jazz
<b>0 986 AB8 153</b>	15,88	NISSAN	Pulsar, Sunny Neo
<b>0 986 AB8 154</b>	15,88	NISSAN	Tiida, Tiida Hatchback, Tiida Latio
<b>0 986 AB8 156</b>	17,46	NISSAN	Bluebird
<b>0 986 AB8 157</b>	15,88	NISSAN	March
<b>0 986 AB8 163</b>	20,64	KIA	K 2900
<b>0 986 AB8 164</b>	20,64	KIA	K 2900
<b>0 986 AB8 171</b>	20,64	HYUNDAI	Grace, H 100
<b>0 986 AB8 172</b>	20,64	HYUNDAI	Grace, H 100
<b>0 986 AB8 190</b>	22,23	MITSUBISHI	Pajero

<b>0 986 AB8 191</b>	22,23	MITSUBISHI	Pajero
<b>0 986 AB8 411</b>		CHEVROLET	Ipanema
<b>0 986 AB8 412</b>		CHEVROLET	Ipanema
<b>0 986 AB8 417</b>		CHEVROLET	Ipanema
<b>0 986 AB8 418</b>		CHEVROLET	Ipanema
<b>0 986 AB8 424</b>		FORD	Escort, Escort Hobby, Escort Sedan
<b>0 986 AB8 425</b>		FORD	Escort, Escort Hobby, Escort Sedan
<b>0 986 AB8 426</b>		FORD	Serie F
<b>0 986 AB8 443</b>		FORD	Escort, Escort SW, Orion
		VW (VOLKSWAGEN)	Pointer
<b>0 986 AB8 444</b>		FORD	Escort, Escort SW, Orion
		VW (VOLKSWAGEN)	Pointer
<b>0 986 AB8 445</b>		FIAT	Brava, Fiorino Furgao, Palio Weekend, Stilo, Strada, Tempra
<b>0 986 AB8 446</b>		FORD	Serie F
<b>0 986 AB8 449</b>		CHEVROLET	Corsa Wagon
<b>0 986 AB8 450</b>		CHEVROLET	Serie D
<b>0 986 AB8 451</b>		CHEVROLET	Serie D
<b>0 986 AB8 452</b>		CHEVROLET	Blazer, S10
<b>0 986 AB8 453</b>		CHEVROLET	Blazer, S10
<b>0 986 AB8 454</b>		FORD	Serie F
<b>0 986 AB8 458</b>		FORD	Ranger
<b>0 986 AB8 459</b>		FORD	Ranger
<b>0 986 AB8 461</b>		RENAULT	Scenic
<b>0 986 AB8 488</b>		FIAT	Palio
<b>0 986 AB8 491</b>		FORD	Fiesta, Ka
<b>0 986 AB8 494</b>		CITROEN	Xsara Picasso
<b>0 986 AB8 495</b>		CHEVROLET	S10
<b>0 986 AB8 496</b>		CHEVROLET	S10

**0 986 BB3 ...**

<b>0 986 BB3 003</b>		TOYOTA	Hilux
<b>0 986 BB3 004</b>		KIA	Pregio
<b>0 986 BB3 005</b>		KIA	Pregio
<b>0 986 BB3 009</b>		FIAT	Palio, Siena
<b>0 986 BB3 011</b>		FIAT	Palio, Siena
		FORD	Fiesta
<b>0 986 BB3 012</b>		HONDA	Fit
<b>0 986 BB3 013</b>		RENAULT	Clio I, Clio II, Clio II Sedan
<b>0 986 BB3 014</b>		FORD	Courier
<b>0 986 BB3 035</b>		VW (VOLKSWAGEN)	Fox, Polo Classic

**0 986 J03 ...**

<b>0 986 J03 701</b>		NISSAN	Cedric Sedan, Cedric Wagon
----------------------	--	--------	-------------------------------

nl

Wielrem-  
cilinders

sv

Hjulbroms-  
cylindrar

pt



Cilindros do travão  
da roda



cs

Brzdové  
válce kol

ru

Колесный  
тормозной цилиндр

			
<b>0 986 J03 738</b>		NISSAN	Cedric Sedan, Cedric Wagon
<b>0 986 J03 764</b>		NISSAN	Cedric Sedan, Cedric Wagon
<b>0 986 J03 789</b>		NISSAN	Cedric Sedan, Cedric Wagon
<b>0 986 J04 ...</b>			
<b>0 986 J04 012</b>		NISSAN	Pickup
<b>0 986 J04 037</b>		NISSAN	Pickup, Urvan
<b>0 986 475 ...</b>			
<b>0 986 475 022</b>	14,29	OPEL	Corsa
		VAUXHALL	Nova
<b>0 986 475 023</b>	15	MERCEDES-BENZ	2t, 3t
<b>0 986 475 029</b>	19,05	OPEL	Combo
<b>0 986 475 032</b>	17,46	CHEVROLET	Lanos, Sens
		DAEWOO	Cielo, Lanos, Lanos Hatchback, Nexia, Nexia Hatchback, Sens
		OPEL	Astra, Corsa
		VAUXHALL	Nova
		ZAZ	Sens
<b>0 986 475 033</b>	17,46	MERCEDES-BENZ	Serie G
		STEYR (STEYR- DAIMLER-PUCH AG)	G
<b>0 986 475 039</b>	20,64	AUDI	80, 80 Avant, 100, 100 Avant
		SEAT	Inca
		SKODA	Octavia, Octavia Combi
		VW (VOLKSWAGEN)	Caddy, Golf III, Golf III Variant, Passat, Passat Variant
<b>0 986 475 042</b>	22,2	MERCEDES-BENZ	4t
<b>0 986 475 044</b>	22,22	MERCEDES-BENZ	Serie G
<b>0 986 475 045</b>	22,2	DAEWOO	Prince, Super Salon
		VAUXHALL	Combo
<b>0 986 475 051</b>	25,4	RENAULT	Trafic
<b>0 986 475 053</b>	22,2	RENAULT	21, 21 Nevada
<b>0 986 475 054</b>	22,2	RENAULT	21, 21 Nevada
<b>0 986 475 056</b>	22,2	FIAT	Talento
<b>0 986 475 143</b>	19,05	CHEVROLET	Lanos, Sens
		DAEWOO	Espero, Lanos, Lanos Hatchback, Nexia, Nexia Hatchback, Sens

			
<b>0 986 475 143</b>		OPEL	Astra, Astra Cabrio, Astra Caravan, Astra Classic, Astra Classic Caravan, Combo, Corsa, Corsa Hatchback, Tigra, Tigra TwinTop, Vectra, Zafira
		VAUXHALL	Astra, Astra Convertible, Astra Estate, Astra Van, Cavalier III, Combo, Corsa, Tigra, Tigra TwinTop, Vectra
		ZAZ	Sens
<b>0 986 475 233</b>	22,2	RENAULT	Express, Extra, Rapid
<b>0 986 475 234</b>	22,2	RENAULT	Express, Extra, Rapid
<b>0 986 475 260</b>	17,46	AUDI	A2, 80, 100
		SEAT	Arosa, Cordoba, Cordoba Vario, Ibiza, Mii, Toledo
		SKODA	Citigo
		VW (VOLKSWAGEN)	Fox, Golf I, Golf I Bakkie, Golf III, Golf III Cabriolet, Golf III Variant, Jetta, Jetta I, Lupo, Polo, Polo Classic, Polo Playa, Polo Sedan, Polo Variant, Polo Vivo, up!, Vento
<b>0 986 475 264</b>	17,46	VW (VOLKSWAGEN)	Käfer
<b>0 986 475 265</b>	22,2	VW (VOLKSWAGEN)	Käfer
<b>0 986 475 290</b>	14,29	VW (VOLKSWAGEN)	Fox, Golf I, Jetta, Jetta I, Polo
<b>0 986 475 420</b>	25,4	CITROEN	C 25
		FIAT	Ducato 10, Ducato 12, Ducato 14
		RENAULT	Master I
<b>0 986 475 428</b>	20,6	PEUGEOT	205, 205 Pickup, 306, 306 Cabriolet
<b>0 986 475 433</b>	19,05	SEAT	Cordoba, Cordoba Vario, Ibiza, Ibiza SC, Ibiza ST
		SKODA	Fabia, Fabia Combi, Fabia Schrägheck, Octavia, Octavia Combi, Praktik, Roomster

de

**Radbremss-  
zylinder**  
(Fortsetzung)

en

**Wheel-brake  
cylinders**  
(continued)

fr



























**Cylindres de freins  
de roues**  
(suite)





















it

**Cilindretti  
freno**  
(seguito)

es

**Cilindros  
de rueda**  
(continuación)

				
<b>0 986 475 433</b>				VW (VOLKSWAGEN) e-up!, Golf Cabriolet, Golf III, Golf III Cabriolet, Golf III Variant, Jetta, Polo, Polo Classic, Polo Coupé, Polo Playa, Polo Sedan, Polo Variant, Polo Vivo, Vento
<b>0 986 475 438</b>	15,87			AUDI A2 SEAT Arosa, Cordoba, Cordoba Vario, Ibiza VW (VOLKSWAGEN) Golf III, Jetta, Lupo, Polo, Polo Classic, Polo Coupé
<b>0 986 475 453</b>	14,29			OPEL Corsa VAUXHALL Nova
<b>0 986 475 476</b>	25,4			VW (VOLKSWAGEN) LT
<b>0 986 475 513</b>	19,05			PEUGEOT 205
<b>0 986 475 558</b>	20,63			NISSAN Primera Wagon, Vanette
<b>0 986 475 574</b>	20,63			TOYOTA Corona Sedan
<b>0 986 475 612</b>	27			CITROEN C 25 FIAT Ducato 18
<b>0 986 475 614</b>	26,99			VW (VOLKSWAGEN) LT
<b>0 986 475 619</b>	20,6			CITROEN ZX
<b>0 986 475 620</b>	20,6			CITROEN ZX
<b>0 986 475 635</b>	20,6			CITROEN Xsara, Xsara Coupé, ZX PEUGEOT 306, 306 Cabriolet
<b>0 986 475 636</b>	20,6			CITROEN Xsara, Xsara Coupé, ZX PEUGEOT 306, 306 Cabriolet
<b>0 986 475 641</b>	20,6			RENAULT 19, 19 Cabrio, 19 Sedan
<b>0 986 475 642</b>	20,6			RENAULT 19, 19 Cabrio, 19 Sedan
<b>0 986 475 643</b>	20,6			RENAULT Clio I, 5
<b>0 986 475 644</b>	20,6			RENAULT Clio I, 5
<b>0 986 475 653</b>	23,8			BMW Serie 3, Serie 3 Coupé
<b>0 986 475 657</b>	23,8			TOYOTA Dyna 100, Hiace Van, Hiace Wagon
<b>0 986 475 660</b>	17,4			MAZDA 323 Hatchback, 323 Sedan, 323 Wagon
<b>0 986 475 661</b>	17,4			MAZDA MX-6, 323 Hatchback, 323 Sedan, 626, 626 Hatchback
<b>0 986 475 662</b>	25,4			MERCEDES-BENZ MB
<b>0 986 475 663</b>	19			MITSUBISHI Lancer Station Wagon, Space Runner, Space Wagon

				
<b>0 986 475 665</b>	17,4			MITSUBISHI Colt
<b>0 986 475 668</b>	19			MAZDA 2 MITSUBISHI Colt, Lancer, Lancer Hatchback, Lancer Station Wagon, Space Runner PROTON Arena Pickup, Persona, Wira Aeroback
<b>0 986 475 669</b>	25,4			NISSAN Cabstar, Patrol GR, Safari
<b>0 986 475 670</b>	15,8			NISSAN Almera Hatchback, Almera Sedan, Pulsar, Pulsar Hatchback, Pulsar Sedan, Sentra, Sunny, Sunny Hatchback, Sunny Sedan, 100 NX
<b>0 986 475 674</b>	17,46			NISSAN Micra
<b>0 986 475 675</b>	17,4			NISSAN Prairie Pro, Sunny Wagon
<b>0 986 475 677</b>	22,2			RENAULT Clio I, Espace II, Espace III, Express, Express, Extra, Rapid, Safrane
<b>0 986 475 680</b>	15,87			SUZUKI Swift Cabrio, Swift Hatchback
<b>0 986 475 687</b>	17,5			DAIHATSU Charade, Charade Hatchback
<b>0 986 475 688</b>	17,5			DAIHATSU Charade, Charade Hatchback
<b>0 986 475 699</b>	17,48			DAIHATSU Applause
<b>0 986 475 700</b>	17,48			DAIHATSU Applause
<b>0 986 475 709</b>	19			HONDA City, Civic, Civic Coupé, Civic CRX, Civic Hatchback, Civic Sedan, Civic Sedan, HR-V
<b>0 986 475 710</b>	19			HONDA City, Civic, Civic Coupé, Civic CRX, Civic Hatchback, Civic Sedan, Civic Sedan, HR-V
<b>0 986 475 718</b>	20,6			MITSUBISHI L 300 Truck, L 300 Van, L 300 Wagon
<b>0 986 475 719</b>	20,6			MITSUBISHI L 300 Truck, L 300 Van, L 300 Wagon
<b>0 986 475 726</b>	23,81			SUZUKI Vitara, Vitara Cabrio
<b>0 986 475 727</b>	23,81			SUZUKI Vitara, Vitara Cabrio TOYOTA Hiace Van, Hiace Wagon

nl

**Wielrem-  
cilinders**  
(vervolg)

sv

**Hjulbroms-  
cylindrar**  
(fortsättning)

pt



**Cilindros do travão  
da roda**  
(continuação)

cs

**Brzdové  
válce kol**  
(pokračování)

ru

**Колесный  
тормозной цилиндр**  
(продолжение)

	 mm		
<b>0 986 475 730</b>	17,5	TOYOTA	Starlet
<b>0 986 475 731</b>	17,5	TOYOTA	Starlet
<b>0 986 475 732</b>	20,6	VOLVO	440, 460
<b>0 986 475 733</b>	20,6	VOLVO	440, 460
<b>0 986 475 734</b>	19	TOYOTA	Carina, Carina E Liftback, Carina E Sedan, Carina E Wagon, Corolla, Corolla Hatchback, Corolla Liftback, Corolla Sedan, Corolla Wagon
<b>0 986 475 735</b>	19	TOYOTA	Carina, Carina E Liftback, Carina E Sedan, Carina E Wagon, Corolla, Corolla Hatchback, Corolla Liftback, Corolla Sedan, Corolla Wagon
<b>0 986 475 736</b>	22,2	BMW	Serie 3 Compact
<b>0 986 475 739</b>	22,2	FORD	Escort VII, Escort VII Cabrio, Escort VII Express, Escort VII RS, Escort VII Turnier, Escort VII XR3i Cabrio, Escort V/VI, Escort V/VI Cabrio, Escort V/VI Express, Escort V/VI Turnier, Escort V/VI XR3i, Escort V/VI XR3i Cabrio, Fiesta III Courier, Fiesta IV Courier, Focus I Turnier
<b>0 986 475 744</b>	20,6	LADA	Niva, Serie 2100, Serie 21000
<b>0 986 475 750</b>	20,6	FORD	Mondeo, Mondeo I, Mondeo II
<b>0 986 475 751</b>	22,2	FORD	Mondeo I Turnier, Mondeo II Turnier
<b>0 986 475 752</b>	22,2	FORD	Mondeo, Mondeo I, Mondeo II
<b>0 986 475 758</b>	23,8	NISSAN	Frontier, Pathfinder, Pickup
<b>0 986 475 759</b>	23,8	FORD NISSAN	Maverick Serena, Terrano II, Vanette Cargo
<b>0 986 475 765</b>	19	RENAULT	Laguna I

	 mm		
<b>0 986 475 769</b>	19	SKODA	Favorit, Felicia, Felicia Combi, Felicia Fun, Forman, Pick-Up
<b>0 986 475 776</b>	19	FORD	Escort VII, Escort VII Cabrio, Escort VII Turnier, Escort VII XR3i Cabrio, Escort V/VI, Escort V/VI Cabrio, Escort V/VI Turnier, Escort V/VI XR3i, Escort V/VI XR3i Cabrio, Fiesta IV, Focus I, Ka
<b>0 986 475 790</b>	17,46	ROVER	100 Metro, 100 Metro Cabrio
<b>0 986 475 793</b>	19,05	ROVER	Mini, Mini Cabrio, Mini Cooper, Mini Cooper Cabrio, Mini De Ville, Mini De Ville Cabrio, Mini Margrave, Mini Retro Rally
<b>0 986 475 795</b>	20,6	BOGDAN CHEVROLET LADA	2110, 2111, 2310 Niva Forma, Granta, Kalina, Kalina Hatchback, Kalina Kombi, Niva, Priora, Priora Hatchback, Priora Kombi, Samara, Samara Fun, Samara Hatchback, Serie 110, Serie 111, Serie 112, Serie 114, Serie 115, Serie 2100, Serie 2114, Serie 21000, Toscana, 4x4
<b>0 986 475 796</b>	20,6	PEUGEOT	405, 405 Break
<b>0 986 475 797</b>	20,6	CITROEN PEUGEOT	Saxo, Xsara, Xsara Coupé, ZX 106, 306, 306 Cabriolet
		RENAULT	Laguna I, Laguna I Grandtour, Megane, Megane I Grandtour, Scenic, Scenic I
<b>0 986 475 801</b>	25,4	CITROEN FIAT PEUGEOT	Jumper Ducato 10, Ducato 14 Boxer

de

**Radbremssylinder**  
(Fortsetzung)

en

**Wheel-brake cylinders**  
(continued)

fr

**Cylindres de freins de roues**  
(suite)

it

**Cilindretti freno**  
(seguito)

es

**Cilindros de rueda**  
(continuación)



		mm		
<b>0 986 475 802</b>		27	CITROEN	Jumper
			FIAT	Ducato, Ducato 10, Ducato 14
			PEUGEOT	Boxer
<b>0 986 475 803</b>		28,6	CITROEN	Jumper
			FIAT	Ducato Cargo, Ducato 18
			PEUGEOT	Boxer
<b>0 986 475 807</b>		25,4	OPEL	Campo Pick-Up, Frontera
			VAUXHALL	Brava Pick-Up, Frontera
<b>0 986 475 808</b>		19,05	HONDA	Civic Fastback, Concerto Hatchback, Concerto Sedan
			MG	ZS
			ROVER	Serie 200, Serie 400, Serie 400 Coupé, Serie 400 Tourer, 45
<b>0 986 475 809</b>		19,05	HONDA	Civic Fastback, Concerto Hatchback, Concerto Sedan
			MG	ZS
			ROVER	Serie 200, Serie 400, Serie 400 Coupé, Serie 400 Tourer, 45
<b>0 986 475 814</b>		22,2	SUZUKI	Vitara, Vitara Cabrio
<b>0 986 475 816</b>		20,64	FIAT	Doblo, Doblo Cargo, Idea, Panda, Punto, Punto Cabrio, Punto Van
			LANCIA	Musa, Y
			IVECO	Daily
<b>0 986 475 826</b>		15,9	IVECO	Daily
<b>0 986 475 827</b>		22,2	FIAT	Brava, Bravo, Marea
<b>0 986 475 833</b>		20,6	CITROEN	C2, C3, C3-Pluriel, Saxo, Xsara, Xsara Coupé
			PEUGEOT	106, 206, 206+, 206 Sedan, 206 SW, 306, 1007
<b>0 986 475 834</b>		20,6	RENAULT	Clio I
<b>0 986 475 835</b>		20,6	RENAULT	Clio I
<b>0 986 475 836</b>		22,2	CITROEN	Berlingo, Picasso, Xsara Picasso
			PEUGEOT	Partner, Ranch
<b>0 986 475 837</b>		17,46	DACIA	Logan, Sandero
			RENAULT	Clio II, Logan, Sandero, Thalia, Twingo I
<b>0 986 475 838</b>		20,6	LAND ROVER GROUP	Freelander
<b>0 986 475 839</b>		20,6	HYUNDAI	Excel, Excel Hatchback, Pony, Scoupe

		mm		
<b>0 986 475 840</b>		15,9	MAZDA	121
			SAIPA	Saipa 141
<b>0 986 475 845</b>		20,6	TOYOTA	Dyna 100
<b>0 986 475 846</b>		19,05	HYUNDAI	Accent, Accent Hatchback, Excel, Excel Hatchback, Pony
			HYUNDAI	Avante, Coupé, Elantra, Lantra, Lantra Kombi, Sonata, Tiburon
<b>0 986 475 848</b>		19,05	HYUNDAI	Accent, Accent Hatchback, Avante, Coupé, Elantra, Excel, Excel Hatchback, Lantra, Lantra Kombi, Pony, Sonata, Tiburon
			HYUNDAI	Excel, Excel Hatchback, Pony, Scoupe
<b>0 986 475 854</b>		19,05	HONDA	Civic Aerodeck, Civic Fastback
			HYUNDAI	Accent, Accent Hatchback, Elantra, Elantra Hatchback, Matrix, Verna
			MG	ZS
<b>0 986 475 855</b>		19,05	HONDA	Civic Aerodeck, Civic Fastback
			HYUNDAI	Accent, Accent Hatchback, Elantra, Elantra Hatchback, Matrix, Verna
<b>0 986 475 856</b>		17,5	MG	ZS
			ROVER	Serie 200, Serie 400, Serie 400 Coupé, Serie 400 Tourer, 25, 45
<b>0 986 475 856</b>		17,5	SUBARU	Justy
			SUZUKI	Baleno Hatchback, Baleno Sedan, Baleno Wagon, Liana Hatchback, Liana Sedan, Swift, Swift Hatchback, Swift Sedan

nl

**Wielrem-  
cilinders**  
(vervolg)

sv

**Hjulbroms-  
cylindrar**  
(fortsättning)

pt

**Cilindros do travão  
da roda**  
(continuação)



cs

**Brzdové  
válce kol**  
(pokračování)

ru

**Колесный  
тормозной цилиндр**  
(продолжение)

	 mm		
<b>0 986 475 857</b>	17,5	SUBARU	Justy
		SUZUKI	Baleno Hatchback, Baleno Sedan, Baleno Wagon, Liana Hatchback, Liana Sedan, Swift, Swift Hatchback, Swift Sedan
<b>0 986 475 858</b>	22,2	SUZUKI	Jimny
<b>0 986 475 859</b>	22,2	SUZUKI	Jimny
<b>0 986 475 860</b>	23,8	SUZUKI	Vitara, Vitara Cabrio
<b>0 986 475 861</b>	23,8	SUZUKI	Vitara, Vitara Cabrio
<b>0 986 475 862</b>	20,6	TOYOTA	Carina E Liftback, Carina E Sedan, Carina E Wagon
<b>0 986 475 863</b>	20,6	TOYOTA	Carina E Liftback, Carina E Sedan, Carina E Wagon
<b>0 986 475 864</b>	20,6	SKODA	Felicia, Felicia Combi
<b>0 986 475 865</b>	22,2	SKODA	Felicia, Felicia Combi, Felicia Fun, Forman, Pick-Up
		VW (VOLKSWAGEN)	Caddy Pickup, Golf III, Golf III Variant, Jetta
<b>0 986 475 866</b>	19	MAZDA	MX-3, 323 F Hatchback, 323 Hatchback, 323 Sedan
<b>0 986 475 867</b>	20,64	FIAT	Fiorino, Palio Weekend, Strada
<b>0 986 475 868</b>	22,2	RENAULT	Laguna I Grandtour
<b>0 986 475 869</b>	20,64	OPEL	Astra, Astra Caravan, Astra GTC, Astra TwinTop, Combo, Corsa, Vectra, Zafira
		VAUXHALL	Astra, Astra Estate, Astra GTC, Astra TwinTop, Combo, Corsa, Vectra, Zafira
<b>0 986 475 870</b>	19,05	MERCEDES-BENZ	Serie A
<b>0 986 475 871</b>	20,64	FIAT	Marea, Marea Weekend, Marengo, Multipla, Palio Weekend
<b>0 986 475 872</b>	22,2	DODGE	Durango
		JEEP	Cherokee, Wagoneer
<b>0 986 475 873</b>	22,2	DODGE	Durango
		JEEP	Cherokee, Wagoneer
<b>0 986 475 874</b>	20,6	FIAT	Punto, Punto Van
<b>0 986 475 875</b>	17,8	MERCEDES-BENZ	Serie A
<b>0 986 475 876</b>	22,2	TOYOTA	Dyna 100, Hilux Pickup

	 mm		
<b>0 986 475 876</b>		VW (VOLKSWAGEN)	Taro
<b>0 986 475 877</b>	25,4	TOYOTA	Land Cruiser
<b>0 986 475 878</b>	19,05	CHRYSLER	Voyager
		DODGE	Caravan
<b>0 986 475 881</b>	17,46	DAIHATSU	Cuore, Materia, Sirion II
		SUBARU	Justy
		TOYOTA	bB, Corolla, Corolla Altis, Corolla Fielder, Corolla Wagon, Echo, Funcargo, iQ, Ist, Limo, Vitz, Yaris
<b>0 986 475 882</b>	17,46	DAIHATSU	Cuore, Materia, Sirion II
		SUBARU	Justy
		TOYOTA	bB, Corolla, Corolla Altis, Corolla Fielder, Corolla Wagon, Echo, Funcargo, iQ, Ist, Limo, Vitz, Yaris
<b>0 986 475 883</b>	20,64	TOYOTA	Avensis, Avensis Liftback, Avensis Wagon
<b>0 986 475 884</b>	20,64	TOYOTA	Avensis, Avensis Liftback, Avensis Wagon
<b>0 986 475 885</b>	22	FIAT	Punto, Punto Van
<b>0 986 475 886</b>	15,87	OPEL	Agila
		VAUXHALL	Agila
<b>0 986 475 889</b>	17,5	CHEVROLET	Matiz, Spark
		DAEWOO	Matiz, Matiz II, New Matiz
<b>0 986 475 890</b>	17,46	CHEVROLET	Lanos, Spark
		DAEWOO	Lanos, Lanos Hatchback, Nubira, Nubira Hatchback, Nubira Station Wagon
<b>0 986 475 891</b>	19,05	SUBARU	Forester, Impreza Kombi, Impreza Sedan
<b>0 986 475 894</b>	22,2	TOYOTA	Hilux Pickup
<b>0 986 475 895</b>	17,46	TOYOTA	Corolla, Corolla Hatchback, Corolla Liftback, Corolla Wagon, Paseo Coupé, Starlet, Tercel



de

**Radbremssylinder**  
(Fortsetzung)

en

**Wheel-brake cylinders**  
(continued)

fr

**Cylindres de freins de roues**  
(suite)

it

**Cilindretti freno**  
(seguito)

es

**Cilindros de rueda**  
(continuación)



<b>0 986 475 896</b>	17,46	TOYOTA	Corolla, Corolla Hatchback, Corolla Liftback, Corolla Wagon, Paseo Coupé, Starlet, Tercel	
<b>0 986 475 897</b>	19,05	TOYOTA	Porte, Prius, Vitz, Yaris, Yaris Verso	
<b>0 986 475 898</b>	19,05	TOYOTA	Porte, Prius, Vitz, Yaris, Yaris Verso	
<b>0 986 475 900</b>	17,46	SUBARU	Impreza Kombi, Impreza Sedan	
<b>0 986 475 901</b>	20,64	FIAT	Doblo, Doblo Cargo, Strada	
<b>0 986 475 902</b>	17,46	TOYOTA	Yaris	
<b>0 986 475 903</b>	17,46	TOYOTA	Yaris	
<b>0 986 475 904</b>	22	FIAT	Brava, Bravo, Marea	
<b>0 986 475 905</b>	19,05	FORD	Fiesta IV, Ka, Puma	
<b>0 986 475 906</b>	26,99	CITROEN	Jumper	
		FIAT	Ducato 11, Ducato 15, Ducato 18	
		PEUGEOT	Boxer	
<b>0 986 475 907</b>	19,05	CITROEN	C3, C3-Pluriel	
<b>0 986 475 908</b>	19,05	CITROEN	C3, C3-Pluriel	
<b>0 986 475 909</b>	20,64	CITROEN	C3	
<b>0 986 475 912</b>	15,87	TOYOTA	Starlet	
<b>0 986 475 913</b>	15,87	TOYOTA	Starlet	
<b>0 986 475 914</b>	17,46	MITSUBISHI	Colt, Lancer, Lancer Sedan	
<b>0 986 475 915</b>	25,4	NISSAN	Serena, Terrano II, Vanette Cargo	
<b>0 986 475 916</b>	20,64	JEEP	Cherokee, Wrangler	
<b>0 986 475 918</b>	17,5	TOYOTA	RAV4, RAV4 Cabrio	
<b>0 986 475 919</b>	23,8	MITSUBISHI	L 200, L 200 Endeavor, L 200 Forte, L 400, Pajero, Pajero Cabrio	
<b>0 986 475 920</b>	23,8	MITSUBISHI	L 200, L 200 Endeavor, L 200 Forte, Pajero, Pajero Cabrio	
<b>0 986 475 921</b>	22,2	MITSUBISHI	L 200, L 300 Truck, L 400, Space Gear	
<b>0 986 475 922</b>	22,2	MITSUBISHI	L 200, L 300 Truck	
<b>0 986 475 925</b>	20,64	FIAT	Punto	
<b>0 986 475 926</b>	19,05	FORD	Fiesta V, Fusion, Ka, Streetka	
		MAZDA	2	
<b>0 986 475 927</b>	20,64	FORD	Focus II, Focus II Turnier, Tourneo Connect, Transit Connect	

<b>0 986 475 928</b>	17,46	HYUNDAI	Accent, Accent Hatchback, Atos, Atos Prime, Getz, Santro, Verna	
		KIA	Cerato, Cerato Hatchback, Forte	
<b>0 986 475 929</b>	17,46	HYUNDAI	Accent, Accent Hatchback, Atos, Atos Prime, Getz, Santro, Verna	
<b>0 986 475 931</b>	19,05	DAIHATSU	Terios	
		TOYOTA	Probox Van, RAV4, Rush, Succeed Van	
<b>0 986 475 933</b>	19,05	NISSAN	Micra, Micra CC, Note, Teana	
<b>0 986 475 934</b>	19,05	RENAULT	Clio III, Clio III Grandtour, Fluence, Modus	
<b>0 986 475 935</b>	20,64	VW (VOLKSWAGEN)	California T4, Caravelle T4, Eurovan, Multivan T4, Transporter T4	
<b>0 986 475 936</b>	20,64	CITROEN	Nemo	
		DAIHATSU	Charade	
		FIAT	Albea, Doblo, Doblo Cargo, Fiorino, Grande Punto, Idea, Linea, Panda, Punto, Punto Evo, Punto Grande, Qubo	
		LANCIA	Musa, Ypsilon	
		PEUGEOT	Bipper	
		TOYOTA	Yaris	
<b>0 986 475 937</b>	22,2	FIAT	Idea	
		LANCIA	Musa	
<b>0 986 475 938</b>	17,46	NISSAN	Almera Hatchback, Almera Sedan, Primera Hatchback, Primera Sedan, Pulsar	
<b>0 986 475 939</b>	19,05	CHEVROLET	Aveo, Aveo Hatchback, Kalos, Kalos Hatchback	
		DAEWOO	Kalos, Kalos Hatchback	
<b>0 986 475 940</b>	19,05	FIAT	Doblo, Doblo Cargo, Idea	
<b>0 986 475 941</b>	20,6	FIAT	Albea	
<b>0 986 475 942</b>	20,6	HONDA	CR-V, HR-V	
<b>0 986 475 943</b>	20,6	HONDA	CR-V, HR-V	
<b>0 986 475 944</b>	20,6	HYUNDAI	H-1, Santa Fe, Santa Fe, Starex, Trajet, Trajet XG	
<b>0 986 475 945</b>	20,6	HYUNDAI	Santa Fe, Santa Fe, Trajet, Trajet XG	

nl

**Wielrem-  
cilinders**  
(vervolg)

sv

**Hjulbroms-  
cylindrar**  
(fortsättning)

pt











**Cilindros do travão  
da roda**  
(continuação)





















cs

**Brzdové  
válce kol**  
(pokračování)

ru

**Колесный  
тормозной цилиндр**  
(продолжение)

	 mm		
<b>0 986 475 946</b>	17,5		HYUNDAI Accent, Accent Hatchback
			KIA Rio, Rio Hatchback, Rio Kombi, Spectra, Spectra Hatchback
<b>0 986 475 947</b>	17,46		MAZDA MX-6, 323, 323 Hatchback, 323 Sedan, 626, 626 Hatchback
<b>0 986 475 948</b>	19		MITSUBISHI Carisma, Carisma Hatchback, Colt, Colt Plus, i-MiEV, Lancer, Space Star, Spacestar
<b>0 986 475 949</b>	19,05		OPEL Adam, Astra, Astra Caravan, Astra GTC, Astra TwinTop, Corsa
			VAUXHALL Adam, Astra, Astra GTC, Astra TwinTop, Corsa
<b>0 986 475 950</b>	22		CITROEN Jumpy
			FIAT Scudo
			PEUGEOT Expert
<b>0 986 475 951</b>	19,05		FIAT Sedici
			OPEL Agila
			SUZUKI Splash, Swift Hatchback, SX4, SX4 Hatchback
			VAUXHALL Agila
<b>0 986 475 952</b>	17,5		SUZUKI Alto Hatchback
<b>0 986 475 953</b>	17,5		SUZUKI Alto Hatchback
<b>0 986 475 954</b>	15,87		SUBARU Justy
			SUZUKI Ignis Hatchback, Wagon R+
<b>0 986 475 955</b>	19		LAND ROVER GROUP Freelander
<b>0 986 475 956</b>	19		MITSUBISHI Colt
			SMART (MCC) Forfour
<b>0 986 475 957</b>	19		HYUNDAI H 100
<b>0 986 475 958</b>	19		HYUNDAI H 100
<b>0 986 475 959</b>	22,2		HYUNDAI H-1, Satellite, Starex
<b>0 986 475 960</b>	22,2		HYUNDAI H-1, Satellite, Starex
<b>0 986 475 961</b>	17,46		HONDA Fit, Jazz
<b>0 986 475 962</b>	22,2		SUZUKI Escudo, Grand Vitara, Grand Vitara Cabrio
<b>0 986 475 963</b>	22,2		SUZUKI Escudo, Grand Vitara, Grand Vitara Cabrio
<b>0 986 475 964</b>	19		SUZUKI Carry, Jimny
<b>0 986 475 965</b>	19		SUZUKI Carry, Jimny
<b>0 986 475 966</b>	19		FIAT Palio, Siena
<b>0 986 475 967</b>	22,2		SUZUKI Samurai, Samurai Cabrio, Vitara
<b>0 986 475 969</b>	17,46		RENAULT Clio II, Twingo II
<b>0 986 475 970</b>	19		FORD Fiesta VI, Fiesta VII

	 mm		
<b>0 986 475 971</b>	25,4		FIAT Doblo, Doblo Cargo
			OPEL Combo
			VAUXHALL Combo
<b>0 986 475 972</b>	19,05		CITROEN C2, C3, C3-Pluriel
<b>0 986 475 973</b>	19,05		CITROEN C2, C3, C3-Pluriel
<b>0 986 475 974</b>	20,64		FIAT Panda, 500, 500C
			FORD Ka
<b>0 986 475 976</b>	27		LAND ROVER GROUP Defender 110, Defender 130
<b>0 986 475 977</b>	27		LAND ROVER GROUP Defender 110, Defender 130
<b>0 986 475 978</b>	19,05		HONDA Civic Sedan
<b>0 986 475 979</b>	19,05		HONDA Civic Sedan
<b>0 986 475 980</b>	20,6		SMART (MCC) Fortwo Cabrio, Fortwo Coupé, Fortwo ED Cabrio, Fortwo ED Coupé
			SMART (MCC) Fortwo Cabrio, Fortwo Coupé, Fortwo ED Cabrio, Fortwo ED Coupé
<b>0 986 475 982</b>	20,64		DAIHATSU Terios
<b>0 986 475 983</b>	20,64		DAIHATSU Terios
<b>0 986 475 984</b>	22,2		FORD Maverick
<b>0 986 475 985</b>	17,5		HYUNDAI Accent, Accent blue, i20, Solaris, Solaris Hatchback
			KIA Rio, Rio Hatchback
<b>0 986 475 986</b>	17,5		HYUNDAI i20
<b>0 986 475 987</b>	19,05		DACIA Duster
			RENAULT Duster
<b>0 986 475 988</b>	19,05		DACIA Duster
			RENAULT Duster
<b>0 986 475 989</b>	20,6		FORD B-Max, Focus, Focus ECO IV, Focus III, Focus III Turnier, Focus IV, Focus IV Turnier, Focus Turnier
			KIA Picanto
			KIA Picanto
			TOYOTA Yaris
<b>F 01G 09G ...</b>			
<b>F 01G 09G 0DG</b>		NISSAN	Cabstar ZZ
<b>F 01G 09G 0DH</b>		NISSAN	Cabstar ZZ
<b>F 01G 09G 0DT</b>		NISSAN	Cabstar
<b>F 01G 09G 0DW</b>		NISSAN	Cabstar ZZ
<b>F 01G 09G 00K</b>		NISSAN	E20
<b>F 01G 09G 00R</b>		NISSAN	E20
<b>F 01G 09G 00T</b>		NISSAN	Cabstar
<b>F 01G 09G 00U</b>		NISSAN	Cabstar ZZ
<b>F 01G 09G 01C</b>		NISSAN	E20
<b>F 01G 09G 01J</b>		NISSAN	E20

de

**Radbremss-  
zylinder**  
(Fortsetzung)

en

**Wheel-brake  
cylinders**  
(continued)

fr

**Cylindres de freins  
de roues**  
(suite)

it

**Cilindretti  
freno**  
(seguito)

es

**Cilindros  
de rueda**  
(continuación)



<b>F 01G 09G 06A</b>		NISSAN	Pathfinder, Pickup
<b>F 01G 09G 06V</b>		SUZUKI	Wagon R+
<b>F 01G 09G 008</b>		NISSAN	Cabstar
<b>F 01G 09G 08N</b>		NISSAN	Cabstar
<b>F 01G 09G 08R</b>		NISSAN	Cabstar ZZ
<b>F 01G 09G 009</b>		NISSAN	Cabstar ZZ
<b>F 01G 09G 09N</b>		NISSAN	Cabstar ZZ
<b>F 01G 09G 066</b>		NISSAN	Pathfinder
<b>F 01G 060 ...</b>			
<b>F 01G 060 12G</b>		SUZUKI	Alto
<b>F 026 A02 ...</b>			
<b>F 026 A02 082</b>		TOYOTA	Hilux
<b>F 026 A02 083</b>		TOYOTA	Hilux
<b>F 026 A02 084</b>		TOYOTA	Hiace Van, Hiace Wagon
<b>F 026 A02 133</b>		NISSAN	Pickup
<b>F 026 A02 136</b>		NISSAN	E20
<b>F 026 A02 137</b>		NISSAN	E20
<b>F 026 A02 213</b>		FORD	Econovan
		MAZDA	Serie E
<b>F 026 A02 214</b>		FORD	Econovan
		MAZDA	Marathon, Serie E
<b>F 026 A02 215</b>		MAZDA	E-Serie, Serie E
<b>F 026 A02 216</b>		MAZDA	E-Serie, Serie E
<b>F 026 A02 218</b>		SUZUKI	Jimny
<b>F 026 A02 219</b>		SUZUKI	Jimny
<b>F 026 A02 220</b>		SUZUKI	Jimny
<b>F 026 A02 221</b>		SUZUKI	Jimny
<b>F 026 A02 232</b>		SUZUKI	Carry
<b>F 026 A02 238</b>		NISSAN	Urvan
<b>F 026 A02 239</b>		MAZDA	E-Serie
<b>F 026 A02 240</b>		MAZDA	E-Serie
<b>F 026 A02 242</b>		NISSAN	Terrano I, Urvan
<b>F 026 A02 256</b>		TOYOTA	Dyna, Dyna 100, Hiace Wagon, Hilux Wagon, 4-Runner
<b>F 026 A02 295</b>		HYUNDAI	Accent, Elantra
<b>F 026 A02 296</b>		HYUNDAI	Accent, Elantra
<b>F 026 A02 325</b>		MAZDA	E-Serie
<b>F 026 A02 326</b>		MAZDA	E-Serie
<b>F 026 A02 327</b>		MAZDA	Serie B
<b>F 026 A02 328</b>		MAZDA	Serie B
<b>F 026 A02 331</b>		SUZUKI	Swift Hatchback, Swift Sedan
<b>F 026 A02 332</b>		SUZUKI	Swift Hatchback, Swift Sedan
<b>F 026 A02 337</b>		SUZUKI	Samurai, Samurai Cabrio
<b>F 026 A02 338</b>		SUZUKI	Samurai, Samurai Cabrio
<b>F 026 A02 346</b>		HYUNDAI	Accent
<b>F 026 A02 353</b>		TOYOTA	Starlet
<b>F 026 A02 354</b>		TOYOTA	Starlet

<b>F 026 A02 355</b>		MAZDA	Tribute
<b>F 026 A02 356</b>		DAIHATSU	Charade
<b>F 026 A02 357</b>		DAIHATSU	Charade
<b>F 026 A02 358</b>		TOYOTA	Dyna
<b>F 026 A02 360</b>		TOYOTA	Dyna
<b>F 026 A02 378</b>		TOYOTA	Dyna
<b>F 026 A02 380</b>		TOYOTA	Dyna
<b>F 026 A02 382</b>		TOYOTA	Dyna
<b>F 026 A02 383</b>		TOYOTA	Dyna
<b>F 026 A02 388</b>		MAZDA	E-Serie, Serie E
<b>F 026 A02 389</b>		FORD	Ranger
		MAZDA	Serie B
<b>F 026 A02 396</b>		SUZUKI	Vitara, X-90
<b>F 026 A02 397</b>		SUZUKI	Vitara, X-90
<b>F 026 A02 403</b>		DODGE	Caravan
<b>F 026 A02 404</b>		NISSAN	Almera, Sunny
<b>F 026 A05 ...</b>			
<b>F 026 A05 985</b>		MITSUBISHI	L 200, L 200 Forte
<b>F 026 A05 986</b>		MITSUBISHI	L 200, L 200 Forte
<b>F 026 A05 988</b>		DAEWOO	Rezzo
<b>F 026 A05 989</b>		TOYOTA	Dyna 150
<b>F 026 A05 990</b>		TOYOTA	Dyna 150
<b>F 026 A05 991</b>		TOYOTA	Dyna 150
<b>F 026 A05 992</b>		TOYOTA	Dyna 150
<b>F 026 A05 993</b>		TOYOTA	Dyna, Dyna 150
<b>F 026 A05 995</b>		TOYOTA	Dyna, Dyna 150
<b>F 026 A05 997</b>		TOYOTA	Dyna
<b>F 026 A05 998</b>		TOYOTA	Dyna
<b>F 026 A05 999</b>		TOYOTA	Dyna
<b>F 026 A06 ...</b>			
<b>F 026 A06 000</b>		TOYOTA	Dyna
<b>F 026 A06 001</b>		MITSUBISHI	Canter
<b>F 026 A06 002</b>		MITSUBISHI	Canter
<b>F 026 A06 003</b>		MITSUBISHI	Canter
<b>F 026 A06 004</b>		MITSUBISHI	Canter
<b>F 026 A06 011</b>		TOYOTA	Hilux, Hilux Vigo
<b>F 026 A06 012</b>		TOYOTA	Fortuner, Hilux
<b>F 026 A06 516</b>		KIA	Mentor II, Mentor II Hatchback, Shuma II, Shuma II Hatchback, Spectra
<b>F 026 A06 524</b>		TOYOTA	Dyna
<b>F 026 A06 525</b>		TOYOTA	Dyna
<b>F 026 A06 526</b>		TOYOTA	Dyna
<b>F 026 A06 527</b>		TOYOTA	Dyna
<b>F 026 A06 528</b>		TOYOTA	Dyna
<b>F 026 A06 529</b>		TOYOTA	Dyna
<b>F 026 A06 530</b>		TOYOTA	Dyna
<b>F 026 A06 531</b>		TOYOTA	Dyna
<b>F 026 A06 538</b>		TOYOTA	Land Cruiser, Land Cruiser Prado, 4-Runner

nl

**Wielrem-  
cilinders**  
(vervolg)

sv

**Hjulbroms-  
cylindrar**  
(fortsättning)

pt

**Cilindros do travão  
da roda**  
(continuação)



cs

**Brzdové  
válce kol**  
(pokračování)

ru

**Колесный  
тормозной цилиндр**  
(продолжение)

			
<b>F 026 A06 710</b>		CHEVROLET	Aveo, Optra Hatchback
<b>F 026 A06 937</b>		TOYOTA	Hiace, Hiace Commuter, Quantum
<b>F 026 A06 938</b>		NISSAN	Note
<b>F 026 A06 939</b>		NISSAN	NP300, Pickup
<b>F 026 A06 944</b>		MITSUBISHI	L 200
<b>F 026 A06 945</b>		MITSUBISHI	L 200, Pajero Sport
<b>F 026 A07 ...</b>			
<b>F 026 A07 635</b>		NISSAN	Hardbody, NP300, Pathfinder, Pickup
<b>F 026 A07 680</b>		MITSUBISHI	Canter
<b>F 026 A07 681</b>		NISSAN	Pickup
<b>F 026 A09 ...</b>			
<b>F 026 A09 605</b>		MAZDA	MPV
<b>F 026 A09 606</b>		MITSUBISHI	Outlander, Pajero Pinin, Space Wagon
<b>F 026 A09 607</b>		CHRYSLER	Sebring, Sebring Convertible
		DODGE	Avenger, Caliber, Stratus
		JEEP	Compass, Patriot
<b>F 026 002 ...</b>			
<b>F 026 002 000</b>	20,64	CHEVROLET	Aveo, Aveo Hatchback, Cruze
<b>F 026 002 005</b>	22,2	NISSAN	Navara
<b>F 026 002 006</b>	20,6	NISSAN	Primera Hatchback, Primera Sedan
<b>F 026 002 007</b>	17,46	SUZUKI	Swift Hatchback
<b>F 026 002 009</b>	19,05	NISSAN	Pixo Hatchback
		SUZUKI	Alto Hatchback
<b>F 026 002 010</b>	15,87	HYUNDAI	i10
<b>F 026 002 011</b>	15,87	HYUNDAI	i10
<b>F 026 002 014</b>		SMART (MCC)	Smart Coupé
<b>F 026 002 015</b>	17,5	SMART (MCC)	Smart Coupé
<b>F 026 002 028</b>	20,6	CITROEN	C-Elysee
		PEUGEOT	208, 301
<b>F 026 002 073</b>	22	DACIA	Serie 1300
<b>F 026 002 080</b>	22,2	CITROEN	C 15
		DACIA	Nova, Solenza
		TOFAS	Sahin
<b>F 026 002 123</b>	17,5	OPEL	Corsa
		VAUXHALL	Nova
<b>F 026 002 128</b>	19,05	CITROEN	AX
<b>F 026 002 131</b>	19	CITROEN	AX
		RENAULT	19, 19 Cabrio
<b>F 026 002 132</b>	19	CITROEN	AX
		RENAULT	19, 19 Cabrio
<b>F 026 002 133</b>	20,6	RENAULT	Express, Extra, Rapid
<b>F 026 002 134</b>	20,6	RENAULT	Express, Extra, Rapid

			
<b>F 026 002 137</b>	17,5	ALFA ROMEO	33 Berlina, 33 Sportwagon
<b>F 026 002 138</b>	17,5	ALFA ROMEO	33 Berlina, 33 Sportwagon
<b>F 026 002 139</b>	22	RENAULT	Express, Extra, Rapid
<b>F 026 002 140</b>	22	RENAULT	Express, Extra, Rapid
<b>F 026 002 157</b>	20,6	FIAT	Punto, Punto Cabrio, Punto Van
		LANCIA	Y
<b>F 026 002 158</b>	20,6	ALFA ROMEO	145, 146
		FIAT	Marea, Marengo, Tempra, Tempra SW, Tipo
<b>F 026 002 163</b>	22	RENAULT	Trafic
<b>F 026 002 164</b>	23,8	RENAULT	Trafic
<b>F 026 002 171</b>	20,6	FORD	Transit, Transit Euroline, Transit Nugget, Transit Tourneo
		NISSAN	Terrano II
		FORD	Transit, Transit Euroline, Transit Nugget, Transit Tourneo
<b>F 026 002 172</b>	22,2	NISSAN	Terrano II
		FORD	Transit, Transit Euroline, Transit Nugget, Transit Tourneo
<b>F 026 002 173</b>	25,4	FORD	Transit
<b>F 026 002 175</b>	19	CITROEN	Saxo
		PEUGEOT	106, 206, 206+, 206 Sedan
<b>F 026 002 176</b>	22,2	RENAULT	Express, Extra, Rapid, 5, 9, 11, 21
<b>F 026 002 177</b>	22,2	RENAULT	Express, Extra, Rapid, 5, 9, 11, 21
<b>F 026 002 178</b>	22,2	FIAT	Tempra, Tipo
<b>F 026 002 180</b>	20,6	CITROEN	AX
		RENAULT	Twingo I
<b>F 026 002 181</b>	19,05	CITROEN	Evasion, Jumpy
		FIAT	Scudo, Ulysse
		LANCIA	Zeta
<b>F 026 002 182</b>	17,46	PEUGEOT	Expert, 806
		RENAULT	Megane, Megane I, Megane I Cabrio, Megane I Classic, Megane I Coupé
<b>F 026 002 183</b>	20,6	PEUGEOT	406, 406 Break
<b>F 026 002 184</b>	20,6	PEUGEOT	406, 406 Break
<b>F 026 002 204</b>	19	PEUGEOT	205, 205 Pickup
<b>F 026 002 205</b>	19	PEUGEOT	205, 205 Pickup
<b>F 026 002 206</b>	19	CITROEN	AX
<b>F 026 002 207</b>	19	CITROEN	AX
<b>F 026 002 208</b>	20,6	PEUGEOT	207, 207 SW, 405
<b>F 026 002 209</b>	20,6	PEUGEOT	207, 207 SW, 405
<b>F 026 002 216</b>	20,6	PEUGEOT	205, 205 Pickup
<b>F 026 002 217</b>	20,6	PEUGEOT	205, 205 Pickup

de

**Radbremss-  
zylinder**  
(Fortsetzung)

en

**Wheel-brake  
cylinders**  
(continued)

fr



**Cylindres de freins  
de roues**  
(suite)



it

**Cilindretti  
freno**  
(seguito)

es

**Cilindros  
de rueda**  
(continuación)

			
	mm		
<b>F 026 002 220</b>	20,6	NISSAN	Primera Hatchback, Primera Sedan
<b>F 026 002 221</b>	20,6	NISSAN	Primera Hatchback, Primera Sedan
<b>F 026 002 222</b>	19	CITROEN	AX, Saxo
		PEUGEOT	106
<b>F 026 002 223</b>	19	CITROEN	AX, Saxo
		PEUGEOT	106
<b>F 026 002 228</b>	19	CITROEN	Saxo
		PEUGEOT	106
<b>F 026 002 229</b>	19	CITROEN	Saxo
		PEUGEOT	106
<b>F 026 002 230</b>	20,6	CITROEN	ZX
<b>F 026 002 231</b>	20,6	CITROEN	ZX
<b>F 026 002 232</b>	22	RENAULT	21
<b>F 026 002 233</b>	22	RENAULT	21
<b>F 026 002 234</b>	20,6	CITROEN	C-Elysee, Xsara, Xsara Coupé, ZX
		PEUGEOT	206, 206+, 206 Sedan, 206 SW, 301, 306, 306 Cabriolet
		RENAULT	19, 19 Cabrio
<b>F 026 002 235</b>	20,6	CITROEN	C-Elysee, Xsara, Xsara Coupé, ZX
		PEUGEOT	206, 206+, 206 Sedan, 206 SW, 301, 306, 306 Cabriolet
		RENAULT	19, 19 Cabrio
<b>F 026 002 236</b>	20,64	RENAULT	Clio I, 5
<b>F 026 002 237</b>	20,64	RENAULT	Clio I, 5
<b>F 026 002 238</b>	20,6	RENAULT	Twingo I
<b>F 026 002 239</b>	20,6	RENAULT	Twingo I
<b>F 026 002 241</b>	23,81	NISSAN	Terrano II
<b>F 026 002 244</b>	20,6	PEUGEOT	406, 406 Break
<b>F 026 002 245</b>	20,6	PEUGEOT	406, 406 Break
<b>F 026 002 249</b>	17,5	DACIA	Logan, Sandero
		RENAULT	Clio II, Clio IV, Clio IV Grandtour, Logan, Sandero, Symbol, Thalia
<b>F 026 002 282</b>	20,64	CITROEN	C3, DS3, DS3 Cabrio
		PEUGEOT	207, 207+, 207 SW
<b>F 026 002 344</b>	20,64	CHRYSLER	Voyager
		DODGE	Caravan
<b>F 026 002 345</b>	17,46	DAEWOO	Matiz, Tico
<b>F 026 002 346</b>	17,46	DAEWOO	Tico
<b>F 026 002 348</b>	23,81	TOYOTA	Hiace Wagon, Land Cruiser, 4-Runner
<b>F 026 002 349</b>	20,64	KIA	Sportage
<b>F 026 002 350</b>	20,64	KIA	Sportage
<b>F 026 002 371</b>	19,05	TOYOTA	Conquest, Corolla, Corolla Station Wagon

			
	mm		
<b>F 026 002 372</b>	19,5	DODGE	Caravan, Dakota, Grand Caravan
		JEEP	Cherokee, Wrangler
<b>F 026 002 382</b>	19,05	KIA	K 2500, Pregio
<b>F 026 002 383</b>	19,05	KIA	K 2500, Pregio
<b>F 026 002 384</b>	15,87	SUZUKI	Ignis Hatchback, Wagon R+
<b>F 026 002 385</b>	25,4	TOYOTA	Hiace, Hiace Van, Hilux, Hilux Pickup
<b>F 026 002 387</b>	20,64	MAZDA	Premacy, 626, 626 Hatchback
<b>F 026 002 388</b>	15,87	KIA	Picanto
<b>F 026 002 392</b>	22,22	NISSAN	Pathfinder
<b>F 026 002 393</b>	20,64	TOYOTA	Yaris
<b>F 026 002 394</b>	20,64	TOYOTA	Yaris
<b>F 026 002 396</b>	17,5	FORD	Fiesta III
<b>F 026 002 397</b>	19,05	FORD	Fiesta III
<b>F 026 002 398</b>	19	FORD	Fiesta III
<b>F 026 002 401</b>	22	FORD	Fiesta III, Fiesta III Courier
<b>F 026 002 434</b>	22	ALFA ROMEO	145, 146
		FIAT	Brava, Bravo, Marea
		LANCIA	Delta
<b>F 026 002 454</b>	19,05	AUTOBIANCHI	Y 10
		FIAT	Cinquecento, Panda, Seicento, Uno, Uno Furgoneta, Uno Mille, Uno Van
		INNOCENTI (NU- OVA INNOCENTI)	Elba
		LANCIA	Y 10
<b>F 026 002 458</b>	19,05	LANCIA	Dedra Berlina
<b>F 026 002 462</b>	20,6	NISSAN	Primera Hatchback, Primera Sedan
<b>F 026 002 463</b>	20,6	CITROEN	C2, C3, C3-Pluriel
		PEUGEOT	1007
<b>F 026 002 464</b>	20,6	NISSAN	Primera Hatchback, Primera Sedan
<b>F 026 002 470</b>	17,46	SEAT	Marbella
<b>F 026 002 471</b>	22	CITROEN	Xsara Break
		PEUGEOT	306 Break
<b>F 026 002 474</b>	20,64	FIAT	Panda, 500, 500C
		FORD	Ka
<b>F 026 002 480</b>	19,05	DACIA	Logan, Sandero
		RENAULT	Clio II, Logan, Sandero, Thalia
<b>F 026 002 482</b>	22	NISSAN	Kubistar
		RENAULT	Kangoo I
<b>F 026 002 483</b>	22,2	NISSAN	Kubistar
		RENAULT	Kangoo I, Kangoo II
<b>F 026 002 502</b>	17,5	FORD	Fiesta IV, Puma
		MAZDA	121
<b>F 026 002 520</b>	19,05	PEUGEOT	205, 205 Pickup
<b>F 026 002 521</b>	19,05	PEUGEOT	205, 205 Pickup



de

Scheibenbrems-  
sättel

en

Disc-brake  
calipers

fr

Etriers de freins  
à disques

it

Pinze freno  
a disco

es

Pinzas de freno  
de disco**0 204 B08 ...**

<b>0 204 B08 425</b>	<b>0 204 B08 428</b>		FORD	Fairlane, Falcon
----------------------	----------------------	--	------	------------------

**0 204 001 ...**

<b>0 204 001 393</b>	<b>0 204 001 394</b>	48	SUZUKI	Swift, Swift Hatchback
<b>0 204 001 441</b>	<b>0 204 001 442</b>	57	ALFA ROMEO	166
<b>0 204 001 935</b>	<b>0 204 001 936</b>	54	RENAULT	Kangoo I
<b>0 204 001 937</b>	<b>0 204 001 938</b>	48	NISSAN	Cabstar E
<b>0 204 001 957</b>	<b>0 204 001 958</b>	57	FORD	Mondeo III, Mondeo III Turnier
			JAGUAR	X-Type, X-Type Estate
<b>0 204 001 965</b>	<b>0 204 001 966</b>	54	FIAT	Bravo, Idea, Stilo
			LANCIA	Musa
<b>0 204 001 967</b>	<b>0 204 001 968</b>	54	FIAT	Bravo, Stilo, Stilo Multi Wagon
<b>0 204 001 969</b>	<b>0 204 001 970</b>	57	FIAT	Bravo, Stilo, Stilo Multi Wagon
			LANCIA	Lybra Berlina
<b>0 204 001 971</b>	<b>0 204 001 972</b>	38	FIAT	Multipla, Stilo, Stilo Multi Wagon

**0 204 004 ...**

<b>0 204 004 175</b>	<b>0 204 004 176</b>	38	RENAULT	Kangoo I
<b>0 204 004 237</b>	<b>0 204 004 238</b>	45	RENAULT	Master II
<b>0 204 004 238</b>	<b>0 204 004 237</b>	45	RENAULT	Master II
<b>0 204 004 320</b>	<b>0 204 004 321</b>	42	NISSAN	Interstar
			OPEL	Movano
			RENAULT	Master II
			VAUXHALL	Movano
<b>0 204 004 330</b>	<b>0 204 004 331</b>	48	CITROEN	C1
			PEUGEOT	107, 108
			TOYOTA	Aygo
<b>0 204 004 338</b>	<b>0 204 004 339</b>	54	FIAT	Idea, Multipla
			LANCIA	Musa
<b>0 204 004 342</b>	<b>0 204 004 343</b>	54	RENAULT	Grand Scenic II, Megane II, Megane II Cabrio, Megane II Grandtour, Megane II Hatchback, Scenic II
<b>0 204 004 346</b>	<b>0 204 004 347</b>	54	RENAULT	Megane II, Megane II Hatchback
<b>0 204 004 378</b>	<b>0 204 004 379</b>	38	FORD	Mondeo III
<b>0 204 004 380</b>	<b>0 204 004 381</b>	38	FORD	Mondeo III Turnier
<b>0 204 004 437</b>	<b>0 204 004 438</b>	38	FIAT	Bravo, Multipla, Stilo, Stilo Multi Wagon
<b>0 204 004 449</b>	<b>0 204 004 450</b>	54	CITROEN	C3
			PEUGEOT	207, 207 CC, 207 SW, 1007
<b>0 204 004 451</b>	<b>0 204 004 452</b>	54	CITROEN	Berlingo, C-Elysee, C2, C3, C3 Picasso, C4, C4 Cactus, C4 Coupé, DS3, DS3 Cabrio, Picasso, Xsara, Xsara Break, Xsara Coupé, Xsara Picasso
			PEUGEOT	Partner, 206, 206+, 206 CC, 206 Sedan, 207, 207+, 207 SW, 208, 301, 307, 1007, 2008
<b>0 204 004 513</b>	<b>0 204 004 514</b>	48	MERCEDES-BENZ	Viano, Vito
<b>0 204 004 515</b>	<b>0 204 004 516</b>	38	MERCEDES-BENZ	Viano, Vito
<b>0 204 004 519</b>	<b>0 204 004 520</b>	51	MERCEDES-BENZ	Sprinter
			VW (VOLKSWAGEN)	Crafter 30, Crafter 35
<b>0 204 004 523</b>	<b>0 204 004 524</b>	48	MERCEDES-BENZ	Sprinter
<b>0 204 004 550</b>	<b>0 204 004 551</b>	38	FORD	Mondeo III
<b>0 204 004 552</b>	<b>0 204 004 553</b>	38	FORD	Mondeo III Turnier
<b>0 204 004 564</b>	<b>0 204 004 565</b>	54	FIAT	Doblo, Doblo Cargo, Linea, Panda
<b>0 204 004 565</b>	<b>0 204 004 564</b>	54	OPEL	Corsa
			VAUXHALL	Corsa

nl

Schijfremzadels

sv

Skivbromsok

pt





Pinça do travão  
de disco

cs

Třmeny  
kotoučových brzd

ru

Суппорты дисковых  
тормозных  
механизмов

				
0 204 004 566	0 204 004 567	54	FIAT	Doblo, Doblo Cargo, Fiorino, Grande Punto, Linea, Punto, Punto Evo, Punto Grande, Qubo, 500, 500C, 500L
			OPEL	Corsa
			VAUXHALL	Corsa
0 204 004 568	0 204 004 569	36	FIAT	Punto Grande, Punto Grande Abarth, Punto Grande Abarth SS
0 204 004 607	0 204 004 608	54	FIAT	Palio
0 204 004 615	0 204 004 616	48	FORD	Transit
0 204 004 660	0 204 004 661	38	JAGUAR	X-Type, X-Type Estate
<b>0 204 102 ...</b>				
0 204 102 036	0 204 102 037	50	CITROEN	BX
0 204 102 039	0 204 102 041	36	RENAULT	Espace II
0 204 102 052	0 204 102 054	45	RENAULT	Trafic, Trafic I
			VAUXHALL	Arena
0 204 102 065	0 204 102 067	48	RENAULT	5, 9, 11, 21, 21 Nevada
0 204 102 075	0 204 102 077	30	CITROEN	Saxo, ZX
			PEUGEOT	106, 205, 206, 206 CC, 206 Sedan, 206 SW, 306, 306 Cabriolet
			RENAULT	Clio I, 5, 19, 19 Cabrio
0 204 102 083	0 204 102 085	45	RENAULT	5
0 204 102 087	0 204 102 089	54	RENAULT	Trafic I
0 204 102 182	0 204 102 184	48	RENAULT	Clio II, Megane I, Megane I Cabrio, Megane I Classic, Megane I Coupé, Thalia
0 204 102 186	0 204 102 188	57	CITROEN	Xantia Break
0 204 102 190	0 204 102 192	57	CITROEN	Xantia, Xantia Break
0 204 102 194	0 204 102 196	54	CITROEN	Xantia, Xantia Break
0 204 102 224	0 204 102 225	48	PEUGEOT	106, 205
0 204 102 226	0 204 102 227	48	PEUGEOT	205, 205 Pickup
0 204 102 228	0 204 102 229	48	PEUGEOT	106, 205
0 204 102 243	0 204 102 244	36	RENAULT	21, 21 Nevada
0 204 102 247	0 204 102 248	36	RENAULT	Espace II
0 204 102 249	0 204 102 250	48	RENAULT	Clio I, Express, Extra, Rapid, 5, 19
0 204 102 251	0 204 102 252	54	RENAULT	21, 21 Nevada
0 204 102 261	0 204 102 262	36	RENAULT	Safrane
0 204 102 267	0 204 102 268	57	PEUGEOT	605
0 204 102 269	0 204 102 270	57	CITROEN	Xantia, XM
0 204 102 277	0 204 102 278	32	CITROEN	Xsara, Xsara Break, Xsara Coupé, ZX
			PEUGEOT	206, 306, 306 Break, 306 Cabriolet
0 204 102 279	0 204 102 280	54	CITROEN	Xantia, Xantia Break
0 204 102 281	0 204 102 282	48	PEUGEOT	306, 306 Cabriolet, 405, 405 Break
0 204 102 285	0 204 102 286	45	RENAULT	Twingo I
0 204 102 287	0 204 102 288	57	PEUGEOT	605
0 204 102 289	0 204 102 290	48	CITROEN	AX, C 15, Saxo, ZX
			PEUGEOT	106, 205, 205 Pickup
0 204 102 295	0 204 102 296	52	NISSAN	Trade
0 204 102 322	0 204 102 323	52	MERCEDES-BENZ	MB
0 204 102 370	0 204 102 745	54	NISSAN	Primera Hatchback, Primera Sedan
0 204 102 371	0 204 102 372	48	MERCEDES-BENZ	MB
0 204 102 373	0 204 102 374	48	SEAT	Cordoba, Cordoba Vario, Ibiza
			VW (VOLKSWAGEN)	Polo, Polo Classic, Polo Coupé, Polo Variant
0 204 102 440	0 204 102 441	36	FIAT	Croma
0 204 102 447	0 204 102 448	48	AUTOBIANCHI	Y 10
			FIAT	Panda, Uno, Uno Van
			LANCIA	Y 10



de

**Scheibenbrems-  
sättel**  
(Fortsetzung)

en

**Disc-brake  
calipers**  
(continued)

fr

**Etriers de freins  
à disques**  
(suite)

it

**Pinze freno  
a disco**  
(seguito)

es

**Pinzas de freno  
de disco**  
(continuación)



<b>0 204 102 452</b>	<b>0 204 102 453</b>	36	FIAT	Croma
<b>0 204 102 460</b>	<b>0 204 102 461</b>	48	LANCIA	Dedra Berlina
<b>0 204 102 469</b>	<b>0 204 102 470</b>	54	FIAT	Croma
<b>0 204 102 471</b>	<b>0 204 102 472</b>	54	FIAT	Croma
<b>0 204 102 473</b>	<b>0 204 102 474</b>	36	LANCIA	Dedra Berlina
<b>0 204 102 475</b>	<b>0 204 102 476</b>	36	FIAT	Tempra, Tempra SW
<b>0 204 102 492</b>	<b>0 204 102 493</b>	48	FIAT	Punto, Punto Cabrio, Punto Van, Seicento
			LANCIA	Y
<b>0 204 102 494</b>	<b>0 204 102 495</b>	48	FIAT	Panda, Punto, Punto Cabrio, Punto Van, Seicento
			LANCIA	Y
<b>0 204 102 506</b>	<b>0 204 102 507</b>	54	ALFA ROMEO	GTV, Spider, 145, 146, 155
			FIAT	Bravo, Coupé, Marea, Multipla
			LANCIA	Dedra Station Wagon, Delta, Lybra Berlina, Lybra Station Wagon
<b>0 204 102 521</b>	<b>0 204 102 523</b>	57	CITROEN	Evasion, Jumpy
			FIAT	Scudo, Ulysse
			PEUGEOT	Expert, 806
<b>0 204 102 524</b>	<b>0 204 102 525</b>	48	AUTOBIANCHI	Y 10
			FIAT	Panda, Punto, Punto Cabrio, Uno, Uno Van
			LANCIA	Dedra Berlina, Y, Y 10
<b>0 204 102 526</b>	<b>0 204 102 527</b>	48	ALFA ROMEO	164
<b>0 204 102 528</b>	<b>0 204 102 529</b>	48	ALFA ROMEO	155
		48	FIAT	Uno
<b>0 204 102 530</b>	<b>0 204 102 531</b>	54	ALFA ROMEO	145, 146, 155
			FIAT	Marengo, Seicento, Tempra, Tempra SW, Tipo
			LANCIA	Dedra Berlina, Delta
<b>0 204 102 531</b>	<b>0 204 102 530</b>	54	LANCIA	Dedra Berlina, Dedra Station Wagon
<b>0 204 102 532</b>	<b>0 204 102 533</b>	54	ALFA ROMEO	Spider, 145, 146, 155
			FIAT	Barchetta, Marengo, Punto GT, Tempra SW, Tipo
			LANCIA	Dedra Berlina, Dedra Station Wagon
<b>0 204 102 540</b>	<b>0 204 102 541</b>	54	FIAT	Croma
<b>0 204 102 541</b>	<b>0 204 102 540</b>	54	FIAT	Croma
<b>0 204 102 544</b>	<b>0 204 102 545</b>	54	FIAT	Barchetta, Punto GT
<b>0 204 102 548</b>	<b>0 204 102 549</b>	48	FIAT	Panda
<b>0 204 102 550</b>	<b>0 204 102 551</b>	48	FIAT	Punto, Punto Cabrio
<b>0 204 102 556</b>	<b>0 204 102 557</b>	48	ALFA ROMEO	33 Berlina, 33 Sportwagon
<b>0 204 102 561</b>	<b>0 204 102 560</b>	54	FIAT	Croma
<b>0 204 102 564</b>	<b>0 204 102 565</b>	54	ALFA ROMEO	155
			FIAT	Tipo
<b>0 204 102 570</b>	<b>0 204 102 571</b>	54	FIAT	Barchetta, Brava, Bravo, Marea, Marea Weekend, Marengo, Punto, Punto GT, Punto Van
<b>0 204 102 572</b>	<b>0 204 102 573</b>	54	FIAT	Bravo, Coupé, Marea, Multipla
<b>0 204 102 575</b>	<b>0 204 102 576</b>	54	ALFA ROMEO	GTV, Spider, 145, 146
<b>0 204 102 580</b>	<b>0 204 102 581</b>	48	SEAT	Arosa
			SKODA	Fabia, Fabia Combi, Fabia Schrägheck
			VW (VOLKSWAGEN)	Fox, Lupo, Polo
<b>0 204 102 594</b>	<b>0 204 102 595</b>	60	CITROEN	Xantia, Xantia Break, XM
<b>0 204 102 609</b>	<b>0 204 102 610</b>	48	CITROEN	Xsara, Xsara Coupé
			PEUGEOT	206, 306
<b>0 204 102 647</b>	<b>0 204 102 648</b>	57	PEUGEOT	605
<b>0 204 102 730</b>	<b>0 204 102 731</b>	45	OPEL	Movano
			RENAULT	Master II
			VAUXHALL	Movano
<b>0 204 102 751</b>	<b>0 204 102 752</b>	48	PEUGEOT	206
<b>0 204 102 759</b>	<b>0 204 102 760</b>	48	PEUGEOT	206

nl

Schijfremzadels  
(vervolg)

sv

Skivbromsok  
(fortsättning)

pt





Pinça do travão  
de disco  
(continuação)

cs

Třmeny  
kotoučových brzd  
(pokračování)

ru

Суппорты дисковых  
тормозных  
механизмов  
(продолжение)

				
<b>0 204 102 763</b>	<b>0 204 102 764</b>	54		CITROEN PEUGEOT
				Xsara, Xsara Break, Xsara Coupé 206, 206 CC, 306, 306 Break, 306 Cabriolet
<b>0 204 102 824</b>	<b>0 204 102 825</b>	48		FIAT
				Cinquecento, Seicento
<b>0 204 102 834</b>	<b>0 204 102 835</b>	48		STEYR (STEYR- DAIMLER-PUCH AG)
				G
<b>0 204 102 847</b>	<b>0 204 102 848</b>	54		ALFA ROMEO
				147, 156 Berlina, 156 Sport Wagon
<b>0 204 102 854</b>	<b>0 204 102 855</b>	54		ALFA ROMEO
				GT, 147, 156 Berlina, 156 Sport Wagon, 156 Sportwagon
				FIAT
				Punto
<b>0 204 102 859</b>	<b>0 204 102 860</b>	36		FORD
				Cougar, Mondeo, Mondeo I, Mondeo II
<b>0 204 102 864</b>	<b>0 204 102 865</b>	36		FORD
				Mondeo I Turnier, Mondeo II Turnier
<b>0 204 102 871</b>	<b>0 204 102 872</b>	57		ALFA ROMEO
				166
				LANCIA
				Kappa Berlina, Kappa Coupé, Kappa Station Wagon
<b>0 204 102 910</b>	<b>0 204 102 911</b>	48		MERCEDES-BENZ
				Serie G
				STEYR (STEYR- DAIMLER-PUCH AG)
				G
<b>0 204 102 912</b>	<b>0 204 102 913</b>			MERCEDES-BENZ
				Sprinter, 311 Sprinter, 411 Sprinter
<b>0 204 102 914</b>	<b>0 204 102 915</b>	60		MERCEDES-BENZ
				Serie V, Vito
<b>0 204 102 916</b>	<b>0 204 102 917</b>	33		MERCEDES-BENZ
				Serie V, Vito
<b>0 204 102 918</b>	<b>0 204 102 919</b>	52		MERCEDES-BENZ
				Sprinter, 311 Sprinter, 411 Sprinter
				VW (VOLKSWAGEN)
				LT
<b>0 204 102 920</b>	<b>0 204 102 921</b>	48		SEAT
				Arosa
<b>0 204 102 922</b>	<b>0 204 102 923</b>	54		FORD
				Escort VII, Escort VII Cabrio, Escort VII Express, Escort VII Turnier, Escort VII XR3i Cabrio, Escort V/VI, Escort V/VI Cabrio, Escort V/VI Express, Escort V/VI Turnier, Escort V/VI XR3i, Escort V/VI XR3i Cabrio
<b>0 204 102 926</b>	<b>0 204 102 925</b>	42		FORD
				Transit, Transit Euroline, Transit Nugget, Transit Tourneo
<b>0 204 102 935</b>	<b>0 204 102 934</b>	42		FORD
				Transit, Transit Euroline, Transit Nugget, Transit Tourneo
<b>0 204 102 950</b>	<b>0 204 102 951</b>	48		OPEL
				Agila
				VAUXHALL
				Agila
<b>0 204 102 961</b>	<b>0 204 102 962</b>	54		CITROEN
				C5
<b>0 204 102 963</b>	<b>0 204 102 964</b>	57		CITROEN
				C5, C5 Break
<b>0 204 102 965</b>	<b>0 204 102 966</b>	57		CITROEN
				C5, C5 Break
<b>0 204 102 969</b>	<b>0 204 102 970</b>	45		RENAULT
				Master II
<b>0 204 102 971</b>	<b>0 204 102 972</b>	54		PEUGEOT
				Partner, Ranch, 206, 206 CC, 206 SW, 307, 307 Break/SW
<b>0 204 102 985</b>	<b>0 204 102 986</b>	51		TOYOTA
				Yaris
<b>0 204 102 989</b>	<b>0 204 102 990</b>	48		PEUGEOT
				206, 206+, 206 Sedan, 206 SW
<b>0 204 102 991</b>	<b>0 204 102 992</b>	48		PEUGEOT
				206, 206+, 206 Sedan, 206 SW
<b>0 204 102 993</b>	<b>0 204 102 994</b>	54		PEUGEOT
				206, 206 CC
<b>0 204 102 995</b>	<b>0 204 102 996</b>	54		RENAULT
				Kangoo I
<b>0 204 204 ...</b>				
<b>0 204 204 673</b>	<b>0 204 204 674</b>	48		MERCEDES-BENZ
				Viano, Vito
<b>0 204 204 711</b>	<b>0 204 204 712</b>	48		OPEL
				Agila
				SUZUKI
				Ignis Hatchback, Wagon R+
				VAUXHALL
				Agila
<b>0 204 204 787</b>	<b>0 204 204 788</b>	60		MERCEDES-BENZ
				Serie E, Serie E (T-Modell), Serie G
<b>0 204 204 871</b>	<b>0 204 204 872</b>			CITROEN
				C4, C4 Sedan
				PEUGEOT
				307 CC

de

**Scheibenbrems-  
sättel**  
(Fortsetzung)

en

**Disc-brake  
calipers**  
(continued)

fr

**Etriers de freins  
à disques**  
(suite)

it

**Pinze freno  
a disco**  
(seguito)

es

**Pinzas de freno  
de disco**  
(continuación)



<b>0 204 204 988</b>	<b>0 204 204 989</b>	42	SMART (MCC)	Fortwo Cabrio, Fortwo Coupé, Roadster, Roadster Coupé, Smart Cabrio, Smart Coupé, Smart Crossblade
<b>0 204 204 992</b>	<b>0 204 204 993</b>	48	FORD	Transit, Transit Euroline, Transit Nugget, Transit Tourneo
<b>0 204 205 ...</b>				
<b>0 204 205 113</b>	<b>0 204 205 114</b>	38	CITROEN	C4, C4 Coupé
			PEUGEOT	307, 307 Break/SW, 307 CC, 307 Sedan
<b>0 204 205 117</b>	<b>0 204 205 118</b>	54	PROTON	GEN2
<b>0 204 205 119</b>	<b>0 204 205 120</b>	38	JAGUAR	X-Type, X-Type Estate
<b>0 204 205 740</b>	<b>0 204 205 741</b>	38	PEUGEOT	207, 207 CC, 207 SW
<b>0 204 207 ...</b>				
<b>0 204 207 082</b>	<b>0 204 207 083</b>	38	CITROEN	C4 Grand Picasso, C4 Picasso
<b>0 204 772 ...</b>				
<b>0 204 772 021</b>	<b>0 204 772 022</b>		MAZDA	BT-50, Serie B
<b>0 204 776 ...</b>				
<b>0 204 776 785</b>	<b>0 204 776 786</b>		MAZDA	Serie B
<b>0 204 902 ...</b>				
<b>0 204 902 000</b>	<b>0 204 902 001</b>	48	FIAT	Ducato 11, Ducato 15, Ducato 17, Ducato 20, Ducato 110, Ducato 115, Ducato 130, Ducato 150, Ducato 180
<b>0 204 902 004</b>	<b>0 204 902 005</b>	36	OPEL	Corsa
			VAUXHALL	Corsa
<b>0 204 902 018</b>	<b>0 204 902 019</b>		FIAT	Panda
<b>0 204 902 026</b>	<b>0 204 902 027</b>	48	FORD	Transit, Transit Euroline, Transit Nugget, Transit Tourneo
<b>0 204 902 030</b>	<b>0 204 902 031</b>		FIAT	Punto Grande
			OPEL	Corsa
			VAUXHALL	Corsa
<b>0 204 902 032</b>	<b>0 204 902 033</b>		FIAT	Linea
			OPEL	Adam, Corsa
			VAUXHALL	Adam, Corsa
			FIAT	Fiorino, Panda, Qubo
<b>0 204 902 040</b>	<b>0 204 902 041</b>		FIAT	Albea, Palio
<b>0 204 902 044</b>	<b>0 204 902 045</b>		PEUGEOT	308, 308 CC, 308 SW, 3008
<b>0 204 902 064</b>	<b>0 204 902 065</b>		FIAT	Panda, 500, 500C
<b>0 204 902 070</b>	<b>0 204 902 071</b>		FIAT	Punto Grande Abarth, Punto Grande Abarth SS
<b>0 204 902 079</b>	<b>0 204 902 080</b>		TOYOTA	Corolla Verso
<b>0 204 902 101</b>	<b>0 204 902 102</b>		FIAT	Brava, Bravo, Marea, Marengo, Punto
			LANCIA	Delta
<b>0 204 902 105</b>	<b>0 204 902 106</b>		ALFA ROMEO	GT, 147, 156 Berlina
<b>0 204 902 119</b>	<b>0 204 717 876</b>		ALFA ROMEO	MiTo
<b>0 204 902 127</b>	<b>0 204 902 128</b>		TOYOTA	Auris, Corolla
<b>0 986 471 ...</b>				
<b>0 986 471 004</b>	<b>0 986 472 004</b>	54	OPEL	Omega
			VAUXHALL	Carlton III
<b>0 986 471 005</b>	<b>0 986 472 005</b>	54	OPEL	Omega
			VAUXHALL	Carlton III
<b>0 986 471 010</b>	<b>0 986 471 009</b>	34	FIAT	Barchetta, Marengo, Punto GT, Tempra, Tempra SW, Tipo
			LANCIA	Dedra Berlina, Dedra Station Wagon, Delta

nl

Schijfremzadels  
(vervolg)

sv

Skivbromsok  
(fortsättning)

pt





Pinça do travão  
de disco  
(continuação)

cs

Třmeny  
kotoučových brzd  
(pokračování)

ru

Суппорты дисковых  
тормозных  
механизмов  
(продолжение)

				
0 986 471 462	0 986 472 462	48	OPEL VAUXHALL	Corsa Nova
0 986 471 463	0 986 472 463	48	OPEL VAUXHALL	Corsa Nova
0 986 471 464	0 986 472 464	52	OPEL VAUXHALL	Corsa Nova
0 986 471 669	0 986 472 669	54	SEAT VW (VOLKSWAGEN)	Cordoba, Cordoba Vario, Ibiza, Inca, Toledo Caddy, Corrado, Golf Cabriolet, Golf III, Golf III Cabriolet, Golf III Variant, Golf IV Cabriolet, Jetta, Passat, Passat Variant, Polo Classic, Polo Playa, Polo Variant, Vento
0 986 471 672	0 986 472 672	48	CITROEN PEUGEOT	C 15 205, 205 Pickup
0 986 471 810	0 986 471 811	54	AUDI	A4, A4 Avant
0 986 471 856	0 986 471 857	33	AUDI	A4, A4 Avant
0 986 471 875	0 986 471 876	34	BMW	Serie 3, Serie 3 Coupé
0 986 471 879	0 986 471 880	38	BMW	Serie 7
0 986 471 883	0 986 471 884	40	BMW	Serie 5 Touring
0 986 471 885	0 986 471 886	45	CITROEN PEUGEOT	AX, Saxo 106
0 986 471 895	0 986 471 896	48	OPEL	Astra, Astra Cabrio, Astra Caravan, Astra Classic, Astra Classic Caravan, Corsa
0 986 471 899	0 986 471 900	48	DAEWOO OPEL VAUXHALL	Nexia, Nexia Hatchback Astra, Astra Cabrio, Astra Caravan, Astra Classic, Astra Classic Caravan, Combo, Corsa, Vectra Cavalier III, Combo, Corsa, Nova
0 986 471 901	0 986 471 902	48	OPEL VAUXHALL	Astra, Astra Cabrio, Astra Caravan, Corsa, Tigra, Vectra Cavalier III, Corsa, Tigra
0 986 471 919	0 986 471 920	54	BMW	Serie Z, Serie 3, Serie 3 Cabrio, Serie 3 Compact, Serie 3 Coupé, Serie 3 Touring
0 986 471 923	0 986 471 924	54	AUDI SEAT SKODA VW (VOLKSWAGEN)	A3 Leon, Leon Cupra, Toledo Octavia, Octavia Combi Bora, Bora Variant, Golf, Golf III, Golf III Variant, Golf IV, Golf IV Station Wagon, Golf IV Variant, Jetta, Jetta IV, New Beetle, New Beetle Cabriolet, Passat, Passat Variant

de

**Scheibenbrems-  
sättel**  
(Fortsetzung)

en

**Disc-brake  
calipers**  
(continued)

fr

**Etriers de freins  
à disques**  
(suite)

it

**Pinze freno  
a disco**  
(seguito)

es

**Pinzas de freno  
de disco**  
(continuación)



<b>0 986 471 935</b>	<b>0 986 471 936</b>	60	FORD	Mondeo I, Mondeo I Turnier, Mondeo II, Mondeo II Turnier
<b>0 986 471 936</b>	<b>0 986 471 935</b>	60	FORD	Mondeo, Scorpio II, Scorpio II Turnier
<b>0 986 471 951</b>	<b>0 986 471 952</b>	35	MERCEDES-BENZ	Serie C, Serie E, Serie E (Coupé), Serie E (T-Modell), Serie 190
<b>0 986 471 979</b>	<b>0 986 471 980</b>	44	MERCEDES-BENZ	Serie G, 2t, 3t, 4t
<b>0 986 472 ...</b>				
<b>0 986 472 826</b>	<b>0 986 472 827</b>	34	ALFA ROMEO	145, 146
<b>0 986 472 828</b>	<b>0 986 472 829</b>	34	FIAT	Tipo
<b>0 986 472 830</b>	<b>0 986 472 831</b>	38	AUDI	A4, A4 Avant, A6, A6 Avant
			VW (VOLKSWAGEN)	Passat, Passat Variant
<b>0 986 472 832</b>	<b>0 986 472 833</b>	38	SEAT	Alhambra
<b>0 986 473 ...</b>				
<b>0 986 473 909</b>	<b>0 986 473 910</b>	54	FORD	Fiesta
<b>F 01G 260 ...</b>				
<b>F 01G 260 046</b>	<b>F 01G 260 045</b>		TOYOTA	Estima, Previda
<b>F 01G 260 048</b>	<b>F 01G 260 047</b>		TOYOTA	Estima, Previda
<b>F 026 A03 ...</b>				
<b>F 026 A03 265</b>	<b>F 026 A03 264</b>		LEXUS	LX
			TOYOTA	Land Cruiser
<b>F 026 A03 327</b>	<b>F 026 A03 326</b>		LEXUS	LX
			TOYOTA	Land Cruiser, Land Cruiser Prado
<b>F 026 A03 331</b>	<b>F 026 A03 330</b>		TOYOTA	Hilux, Hilux Pickup, Land Cruiser
<b>F 026 A03 332</b>	<b>F 026 A03 333</b>		TOYOTA	Land Cruiser
<b>F 026 A03 337</b>	<b>F 026 A03 339</b>		TOYOTA	Land Cruiser
<b>F 026 A03 338</b>	<b>F 026 A03 335</b>		LEXUS	LX
			TOYOTA	Land Cruiser
<b>F 026 A07 ...</b>				
<b>F 026 A07 971</b>	<b>F 026 A07 970</b>		TOYOTA	Land Cruiser
<b>F 026 700 ...</b>				
<b>F 026 700 012</b>	<b>F 026 700 013</b>		FIAT	Bravo
<b>F 026 700 014</b>	<b>F 026 700 015</b>		AUDI	A1, A1 Sportback

<b>de</b> Scheibenbrems- sättel	<b>en</b> Disc-brake calipers	<b>fr</b> Etriers de freins à disques	<b>it</b> Pinze freno a disco	<b>es</b> Pinzas de freno de disco
<b>nl</b> Schijfremzadels	<b>sv</b> Skivbromsok	<b>pt</b> Pinça do travão de disco	<b>cs</b> Třmeny kotoučových brzd	<b>ru</b> Суппорты дисковых тормозных механизмов



## 0 204 103 ...

<b>0 204 103 036</b>	<b>0 204 103 037</b>	50	CITROEN	BX
<b>0 204 103 039</b>	<b>0 204 103 041</b>	36	RENAULT	Espace II
<b>0 204 103 052</b>	<b>0 204 103 054</b>	45	RENAULT	Trafic, Trafic I
			VAUXHALL	Arena
<b>0 204 103 065</b>	<b>0 204 103 067</b>	48	RENAULT	5, 9, 11, 21, 21 Nevada
<b>0 204 103 083</b>	<b>0 204 103 085</b>	45	RENAULT	5
<b>0 204 103 087</b>	<b>0 204 103 089</b>	54	RENAULT	Trafic I
<b>0 204 103 224</b>	<b>0 204 103 225</b>	48	PEUGEOT	106, 205
<b>0 204 103 243</b>	<b>0 204 103 244</b>	36	RENAULT	21, 21 Nevada
<b>0 204 103 247</b>	<b>0 204 103 248</b>	36	RENAULT	Espace II
<b>0 204 103 251</b>	<b>0 204 103 252</b>	54	RENAULT	21, 21 Nevada
<b>0 204 103 267</b>	<b>0 204 103 268</b>	57	PEUGEOT	605
<b>0 204 103 269</b>	<b>0 204 103 270</b>	57	CITROEN	Xantia, XM
<b>0 204 103 277</b>	<b>0 204 103 278</b>	32	CITROEN	Xsara, Xsara Break, Xsara Coupé, ZX
			PEUGEOT	206, 306, 306 Break, 306 Cabriolet
<b>0 204 103 281</b>	<b>0 204 103 282</b>	48	PEUGEOT	306, 306 Cabriolet, 405, 405 Break
<b>0 204 103 285</b>	<b>0 204 103 286</b>	45	RENAULT	Twingo I
<b>0 204 103 370</b>	<b>0 204 103 745</b>	54	NISSAN	Primera Hatchback, Primera Sedan
<b>0 204 103 371</b>	<b>0 204 103 372</b>	48	MERCEDES-BENZ	MB
<b>0 204 103 373</b>	<b>0 204 103 374</b>	48	SEAT	Cordoba, Cordoba Vario, Ibiza
			VW (VOLKSWAGEN)	Polo, Polo Classic, Polo Coupé, Polo Variant
<b>0 204 103 375</b>	<b>0 204 103 376</b>	48	VW (VOLKSWAGEN)	Polo
<b>0 204 103 440</b>	<b>0 204 103 441</b>	36	FIAT	Croma
<b>0 204 103 452</b>	<b>0 204 103 453</b>	36	FIAT	Croma
<b>0 204 103 460</b>	<b>0 204 103 461</b>	48	LANCIA	Dedra Berlina
<b>0 204 103 469</b>	<b>0 204 103 470</b>	54	FIAT	Croma
<b>0 204 103 471</b>	<b>0 204 103 472</b>	54	FIAT	Croma
<b>0 204 103 475</b>	<b>0 204 103 476</b>	36	FIAT	Tempra, Tempra SW
<b>0 204 103 494</b>	<b>0 204 103 495</b>	48	FIAT	Cinquecento, Punto, Punto Cabrio, Punto Van, Seicento
			LANCIA	Y
<b>0 204 103 499</b>	<b>0 204 103 500</b>	54	FIAT	Brava, Bravo, Marea, Marengo, Punto
			LANCIA	Delta
<b>0 204 103 506</b>	<b>0 204 103 507</b>	54	ALFA ROMEO	GTV, Spider, 145, 146, 155
			FIAT	Bravo, Coupé, Marea, Multipla
			LANCIA	Dedra Station Wagon, Delta, Lybra Berlina, Lybra Station Wagon
<b>0 204 103 521</b>	<b>0 204 103 523</b>	57	CITROEN	Evasion, Jumpy
			FIAT	Scudo, Ulysse
			PEUGEOT	Expert, 806
<b>0 204 103 524</b>	<b>0 204 103 525</b>	48	AUTOBIANCHI	Y 10
			FIAT	Panda, Punto, Punto Cabrio, Uno, Uno Van
			LANCIA	Dedra Berlina, Y, Y 10
<b>0 204 103 526</b>	<b>0 204 103 527</b>	48	ALFA ROMEO	164
<b>0 204 103 530</b>	<b>0 204 103 531</b>	54	ALFA ROMEO	145, 146, 155
			FIAT	Marengo, Seicento, Tempra, Tempra SW, Tipo
			LANCIA	Dedra Berlina, Delta
<b>0 204 103 531</b>	<b>0 204 103 530</b>	54	LANCIA	Dedra Berlina, Dedra Station Wagon
<b>0 204 103 532</b>	<b>0 204 103 533</b>	54	ALFA ROMEO	Spider, 145, 146, 155
			FIAT	Barchetta, Marengo, Punto GT, Tempra SW, Tipo
			LANCIA	Dedra Berlina, Dedra Station Wagon
<b>0 204 103 556</b>	<b>0 204 103 557</b>	48	ALFA ROMEO	33 Berlina, 33 Sportwagon
<b>0 204 103 594</b>	<b>0 204 103 595</b>	60	CITROEN	Xantia, Xantia Break, XM

de

**Scheibenbrems-  
sättel**  
(Fortsetzung)

en

**Disc-brake  
calipers**  
(continued)

fr

**Etriers de freins  
à disques**  
(suite)

it

**Pinze freno  
a disco**  
(seguito)

es

**Pinzas de freno  
de disco**  
(continuación)



<b>0 204 103 609</b>	<b>0 204 103 610</b>	48	CITROEN	Xsara, Xsara Coupé
			PEUGEOT	206, 306
<b>0 204 103 647</b>	<b>0 204 103 648</b>	57	PEUGEOT	605
<b>0 204 103 730</b>	<b>0 204 103 731</b>	45	OPEL	Movano
			RENAULT	Master II
			VAUXHALL	Movano
<b>0 204 103 854</b>	<b>0 204 103 855</b>	54	ALFA ROMEO	GT, 147, 156 Berlina, 156 Sport Wagon, 156 Sportwagon
			FIAT	Punto
<b>0 204 103 864</b>	<b>0 204 103 865</b>	36	FORD	Mondeo I Turnier, Mondeo II Turnier
<b>0 204 103 926</b>	<b>0 204 103 925</b>	42	FORD	Transit, Transit Euroline, Transit Nugget, Transit Tourneo
<b>0 204 103 931</b>	<b>0 204 103 924</b>	54	FORD	Escort VII, Escort VII Cabrio, Escort VII Express, Escort VII Turnier, Escort VII XR3i Cabrio, Escort V/VI, Escort V/VI Cabrio, Escort V/VI Express, Escort V/VI Turnier, Escort V/VI XR3i, Escort V/VI XR3i Cabrio
<b>0 204 103 965</b>	<b>0 204 103 966</b>	57	CITROEN	C5, C5 Break
<b>0 204 103 969</b>	<b>0 204 103 970</b>	45	NISSAN	Interstar
<b>0 204 103 969</b>	<b>0 204 103 970</b>	45	RENAULT	Master II
<b>0 204 103 971</b>	<b>0 204 103 972</b>	53,97	CITROEN	Berlingo, C-Elysee, C2, C3, C3 Picasso, C4, C4 Cactus, C4 Coupé, DS3, DS3 Cabrio, Picasso, Xsara, Xsara Break, Xsara Coupé, Xsara Picasso
			PEUGEOT	Partner, Ranch, 206, 206+, 206 CC, 206 Sedan, 206 SW, 207, 207+, 207 SW, 208, 301, 307, 307 Break/SW, 1007, 2008
<b>0 204 103 977</b>	<b>0 204 103 978</b>	37,97	FORD	Mondeo III
<b>0 204 103 989</b>	<b>0 204 103 990</b>	47,96	PEUGEOT	206, 206+, 206 Sedan, 206 SW
<b>0 204 103 991</b>	<b>0 204 103 992</b>	47,96	PEUGEOT	206, 206+, 206 Sedan, 206 SW
<b>0 204 103 993</b>	<b>0 204 103 994</b>	54	PEUGEOT	206, 206 CC
<b>0 986 134 ...</b>				
<b>0 986 134 000</b>	<b>0 986 135 000</b>	38	CITROEN	C4 Grand Picasso, C4 Picasso
<b>0 986 134 002</b>	<b>0 986 135 002</b>	57	VOLVO	C70 II Cabrio, S40 II, V40 Cross Country, V40 II, V50
<b>0 986 134 003</b>	<b>0 986 135 003</b>	54	CITROEN	C2, C3, C3-Pluriel
<b>0 986 134 004</b>	<b>0 986 135 004</b>	41	VW (VOLKSWAGEN)	California T5, California T6, Caravelle T5, Caravelle T6, Multivan T5, Multivan T6, Transporter T5, Transporter T6
<b>0 986 134 005</b>	<b>0 986 135 005</b>	54	ALFA ROMEO	GTV, Spider, 145, 146
<b>0 986 134 006</b>	<b>0 986 135 006</b>	38	FIAT	Bravo, Multipla, Stilo, Stilo Multi Wagon
<b>0 986 134 007</b>	<b>0 986 135 007</b>	48	FIAT	Cinquecento, Panda, Punto, Punto Cabrio, Punto Van, Seicento, 500
			LANCIA	Y
<b>0 986 134 009</b>	<b>0 986 135 009</b>	45	MITSUBISHI	Pajero
<b>0 986 134 010</b>	<b>0 986 135 010</b>	38	PEUGEOT	207, 207 CC, 207 SW
<b>0 986 134 011</b>	<b>0 986 135 011</b>	34	RENAULT	Clio III, Clio III Grandtour, Modus
<b>0 986 134 013</b>	<b>0 986 135 013</b>	60	MERCEDES-BENZ	Serie E, Serie E (T-Modell), Serie G
<b>0 986 134 014</b>	<b>0 986 135 014</b>	44	IVECO	Scudato
<b>0 986 134 016</b>	<b>0 986 135 016</b>	44	CITROEN	Jumper
			FIAT	Ducato, Ducato Cargo, Ducato Minibus, Ducato 11, Ducato 15
			PEUGEOT	Boxer
<b>0 986 134 017</b>	<b>0 986 135 017</b>	57	MERCEDES-BENZ	Serie A, Serie B

nl

**Schijfremzadels**  
(vervolg)

sv

**Skivbromsok**  
(fortsättning)

pt





**Pinça do travão  
de disco**  
(continuação)

cs

**Třmeny  
kotoučových brzd**  
(pokračování)

ru

**Суппорты дисковых  
тормозных  
механизмов**  
(продолжение)

 eXchange		 eXchange				
0 986 134 018	0 986 135 018	57	FIAT	Croma		
			OPEL	Signum, Vectra, Vectra Caravan		
			SAAB (SAAB AUTOMOBILE AB)	9-3, 9-3 Cabriolet, 9-3 Kombi, 9-3X		
			VAUXHALL	Signum, Vectra, Vectra Estate		
0 986 134 019	0 986 135 019	48	MERCEDES-BENZ	Sprinter		
0 986 134 020	0 986 135 020	48	SEAT	Arosa		
			SKODA	Fabia, Fabia Combi, Fabia Schrägheck		
			VW (VOLKSWAGEN)	Fox, Lupo, Polo		
0 986 134 021	0 986 135 021	38	FORD	Mondeo III Turnier		
0 986 134 022	0 986 135 022	44	IVECO	Scudato		
0 986 134 023	0 986 135 023	43	KIA	Sorento		
0 986 134 024	0 986 135 024	45	MITSUBISHI	Pajero		
0 986 134 027	0 986 135 027	48	FORD	Transit, Transit Euroline, Transit Nugget, Transit Tourneo		
				FORD	Transit	
0 986 134 029	0 986 135 029	30	MERCEDES-BENZ	Vaneo		
0 986 134 031	0 986 135 031	46	KIA	Sorento		
0 986 134 032	0 986 135 032	48	MERCEDES-BENZ	Viano, Vito		
0 986 134 033	0 986 135 033	28	MERCEDES-BENZ	Serie A		
0 986 134 035	0 986 135 035	52	MERCEDES-BENZ	Sprinter		
			VW (VOLKSWAGEN)	Crafter 50		
0 986 134 036	0 986 135 036	61	TOYOTA	RAV4		
0 986 134 037	0 986 135 037	60	VOLVO	XC90 I		
0 986 134 038	0 986 135 038	38	CITROEN	Berlingo, Xsara Picasso		
			PEUGEOT	Partner		
0 986 134 039	0 986 135 039	36	MERCEDES-BENZ	Serie C, Serie C (Sportcoupe), Serie CLC, Serie CLK (Cabrio), Serie CLK (Coupé), Serie SLK		
0 986 134 040	0 986 135 040	35	NISSAN	X-Trail		
0 986 134 041	0 986 135 041	42	OPEL	Omega		
			VAUXHALL	Omega		
0 986 134 042	0 986 135 042	46	PEUGEOT	Boxer		
0 986 134 043	0 986 135 043	48	NISSAN	Micra		
0 986 134 044	0 986 135 044	34	RENAULT	Scenic II		
0 986 134 045	0 986 135 045	40	MERCEDES-BENZ	Serie ML		
0 986 134 046	0 986 135 046	51	MERCEDES-BENZ	Sprinter		
			VW (VOLKSWAGEN)	Crafter 30, Crafter 35		
0 986 134 047	0 986 135 047	60	VOLVO	S60 II, S80 II, V60, V70 III, XC70 II		
0 986 134 048	0 986 135 048	38	AUDI	A3, A3 Cabriolet, A3 Sportback, TT Coupé, TT Roadster		
			SEAT	Altea, Altea Freetrack, Altea XL, Leon, Leon Cupra, Toledo		
			VW (VOLKSWAGEN)	Eos, Golf Plus, Golf V, Golf VI		
0 986 134 049	0 986 135 049	41	VW (VOLKSWAGEN)	Caddy, Caddy Panel Van		
0 986 134 050	0 986 135 050	41	OPEL	Zafira		
			VAUXHALL	Zafira		
0 986 134 051	0 986 135 051	38	RENAULT	Kangoo I		
0 986 134 052	0 986 135 052	48	CITROEN	Jumper		
			FIAT	Ducato 11, Ducato 15, Ducato 17, Ducato 20, Ducato 110, Ducato 115, Ducato 130, Ducato 150, Ducato 180		
			PEUGEOT	Boxer		
			TOYOTA	Auris, Auris Touring Sports		
0 986 134 054	0 986 135 054	36	TOYOTA	Auris, Auris Touring Sports		
0 986 134 055	0 986 135 055	42	MERCEDES-BENZ	Serie CLS, Serie E, Serie E (T-Modell), Serie S, Serie SL		



de

**Scheibenbrems-  
sättel**  
(Fortsetzung)

en

**Disc-brake  
calipers**  
(continued)

fr

**Etriers de freins  
à disques**  
(suite)

it

**Pinze freno  
a disco**  
(seguito)

es

**Pinzas de freno  
de disco**  
(continuación)



<b>0 986 134 058</b>	<b>0 986 135 058</b>	35	OPEL VAUXHALL	Vectra, Vectra Caravan Vectra, Vectra Estate
<b>0 986 134 060</b>	<b>0 986 135 060</b>	32	MAZDA	MX-5
<b>0 986 134 061</b>	<b>0 986 135 061</b>	36	MERCEDES-BENZ	Serie C, Serie C (Sportcoupe), Serie C (T-Modell), Serie CLC, Serie CLK (Cabrio), Serie CLK (Coupé), Serie SLK
<b>0 986 134 062</b>	<b>0 986 135 062</b>	51	MERCEDES-BENZ	Sprinter
<b>0 986 134 063</b>	<b>0 986 135 063</b>	57	BMW	Serie X, Serie Z, Serie 3, Serie 3 Cabrio, Serie 3 Coupé, Serie 3 Touring
<b>0 986 134 064</b>	<b>0 986 135 064</b>	54	FIAT	Fiorino, Fiorino Furgao
<b>0 986 134 065</b>	<b>0 986 135 065</b>	43	MAZDA	MPV
<b>0 986 134 067</b>	<b>0 986 135 067</b>	40	VOLVO	S70, V70 I
<b>0 986 134 068</b>	<b>0 986 135 068</b>	43	AUDI	A4, A4 Avant, S4, S4 Avant
<b>0 986 134 070</b>	<b>0 986 135 070</b>	40	OPEL VAUXHALL	Signum, Vectra Caravan Signum, Vectra Estate
<b>0 986 134 074</b>	<b>0 986 135 074</b>	43	AUDI  VW (VOLKSWAGEN)	A6, A6 Allroad, A6 Avant, A8, S4, S4 Avant, S6, S6 Avant, S8 Passat, Passat Variant
<b>0 986 134 076</b>	<b>0 986 135 076</b>	57	MERCEDES-BENZ	Serie C, Serie C (T-Modell), Serie CLC, Serie CLK (Cabrio), Serie CLK (Coupé), Serie SLK
<b>0 986 134 077</b>	<b>0 986 135 077</b>	54	FIAT  OPEL VAUXHALL	Doblo, Doblo Cargo, Fiorino, Grande Punto, Linea, Punto, Punto Evo, Qubo, 500, 500C, 500L Corsa Corsa
<b>0 986 134 078</b>	<b>0 986 135 078</b>	60	AUDI	A6, A6 Allroad, A6 Avant, S6, S6 Avant
<b>0 986 134 080</b>	<b>0 986 135 080</b>	36	MINI (BMW)	Cooper, Cooper Cabrio, Cooper Clubman, Cooper Clubvan, Cooper Coupé, Cooper One, Cooper One Cabrio, Cooper One Clubman, Cooper Roadster
<b>0 986 134 081</b>	<b>0 986 135 081</b>	57	OPEL SAAB (SAAB AUTOMOBILE AB) VAUXHALL	Signum, Vectra, Vectra Caravan 9-3, 9-3 Cabriolet, 9-3 Kombi, 9-3X Signum, Vectra, Vectra Estate
<b>0 986 134 082</b>	<b>0 986 135 082</b>	38	RENAULT	Kangoo II
<b>0 986 134 083</b>	<b>0 986 135 083</b>	38	PEUGEOT	308 SW
<b>0 986 134 084</b>	<b>0 986 135 084</b>	44	BMW	Serie X, Serie 3, Serie 3 Cabrio, Serie 3 Coupé, Serie 3 Touring
<b>0 986 134 085</b>	<b>0 986 135 085</b>	57	HONDA	CR-V
<b>0 986 134 086</b>	<b>0 986 135 086</b>	42	MERCEDES-BENZ	Serie E, Serie E (T-Modell), Serie SL
<b>0 986 134 087</b>	<b>0 986 135 087</b>	34	FORD	Fiesta V
<b>0 986 134 093</b>	<b>0 986 135 093</b>	48	CITROEN PEUGEOT TOYOTA	C1 107, 108 Aygo
<b>0 986 134 094</b>	<b>0 986 135 094</b>	37,97	FORD	Mondeo III
<b>0 986 134 095</b>	<b>0 986 135 095</b>	54	FORD	Escort VII, Escort VII Cabrio, Escort VII Express, Escort VII Turnier, Escort VII XR3i Cabrio, Escort V/VI, Escort V/VI Cabrio, Escort V/VI Express, Escort V/VI Turnier, Escort V/VI XR3i, Escort V/VI XR3i Cabrio
<b>0 986 134 096</b>	<b>0 986 135 096</b>	48	MERCEDES-BENZ	MB
<b>0 986 134 098</b>	<b>0 986 135 098</b>	30	CITROEN PEUGEOT RENAULT	Saxo, ZX 106, 205, 206, 206 CC, 206 Sedan, 206 SW, 306, 306 Cabriolet Clio I, 5, 19, 19 Cabrio

nl

**Schijfremzadels**  
(vervolg)

sv

**Skivbromsok**  
(fortsättning)

pt





**Pinça do travão  
de disco**  
(continuação)

cs

**Třmeny  
kotoučových brzd**  
(pokračování)

ru

**Суппорты дисковых  
тормозных  
механизмов**  
(продолжение)

						
0 986 134 200	0 986 135 200				AUDI	Q7
					VW (VOLKSWAGEN)	Touareg
0 986 134 203	0 986 135 203	38			SEAT	Altea, Altea Freetrack, Altea XL, Leon
					SKODA	Octavia, Octavia Combi, Superb, Superb Combi, Yeti
					VW (VOLKSWAGEN)	Beetle, Beetle Cabriolet, Eos, Golf VI, Golf VI Cabriolet, Golf VI Variant, Jetta, Passat, Scirocco, Scirocco R, Touran, Touuran
0 986 134 204	0 986 135 204	38			VW (VOLKSWAGEN)	Caddy
0 986 134 217	0 986 135 217				VW (VOLKSWAGEN)	Caddy, Caddy Panel Van
0 986 134 218	0 986 135 218				KIA	Picanto
0 986 134 220	0 986 135 220				HONDA	Jazz
0 986 134 221	0 986 135 221				TOYOTA	Vitz, Yaris
0 986 134 222	0 986 135 222				HYUNDAI	i10
0 986 134 223	0 986 135 223				MITSUBISHI	Colt, Colt Cabrio
0 986 134 225	0 986 135 225				HYUNDAI	Accent, Accent Hatchback
0 986 134 227	0 986 135 227				PEUGEOT	407, 407 Coupé, 407 SW
0 986 134 229	0 986 135 229				VW (VOLKSWAGEN)	Polo
0 986 134 230	0 986 135 230				PEUGEOT	RCZ, RCZ R, 308, 308 CC, 3008
0 986 134 231	0 986 135 231				FIAT	Croma
0 986 134 235	0 986 135 235	41			FIAT	Croma
0 986 134 237	0 986 135 237				TOYOTA	iQ, Ractis, Urban Cruiser, Verso-S, Vitz, Yaris
0 986 134 239	0 986 135 239				HONDA	Civic Hatchback
0 986 134 243	0 986 135 243				LAND ROVER GROUP	Freelander II, Freelander 2
0 986 134 244	0 986 135 244				SEAT	Leon
					SKODA	Octavia, Octavia Combi
					VW (VOLKSWAGEN)	Golf V, Golf VI, Jetta
0 986 134 246	0 986 135 246				TOYOTA	Yaris
0 986 134 248	0 986 135 248				HYUNDAI	i20
0 986 134 249	0 986 135 249				KIA	Cee'd, Cee'd Sporty Wagon, Pro Cee'd
0 986 134 250	0 986 135 250				LEXUS	GX
					TOYOTA	Land Cruiser, Land Cruiser Prado, Sequoia
0 986 134 251	0 986 135 251				NISSAN	Cube, Qashqai, Tiida, Tiida Hatchback
0 986 134 253	0 986 135 253				NISSAN	X-Trail
0 986 134 256	0 986 135 256	54			RENAULT	Kangoo II
0 986 134 257	0 986 135 257				AUDI	A3, A3 Cabriolet, A3 Sportback
					SEAT	Leon
					SKODA	Superb, Superb Combi
					VW (VOLKSWAGEN)	Eos, Golf V, Golf VI, Passat, Passat CC, Passat Variant
0 986 134 259	0 986 135 259	60			CITROEN	C4 Grand Picasso, C4 Picasso
0 986 134 260	0 986 135 260				VOLVO	S60 I, V70 II, XC90 I
0 986 134 262	0 986 135 262	51			HONDA	Fit, Jazz
0 986 134 264	0 986 135 264	57			MERCEDES-BENZ	Serie A, Serie B
0 986 134 266	0 986 135 266				AUDI	A4, A4 Allroad, A4 Avant, A5 Cabriolet, A5 Coupé, A5 Sportback
0 986 134 267	0 986 135 267	57			AUDI	A4, A4 Allroad, A4 Avant, A4 Sportback, A5 Cabriolet, A5 Coupé, A5 Sportback, S4, S4 Avant
0 986 134 269	0 986 135 269				PEUGEOT	407, 407 Coupé, 407 SW
0 986 134 273	0 986 135 273	51			HYUNDAI	Atos, Atos Prime
0 986 134 274	0 986 135 274				HONDA	CR-V
0 986 134 276	0 986 135 276	54			FORD	Fiesta VI, Fiesta VII
0 986 134 282	0 986 135 282	54			RENAULT	Grand Scenic II, Scenic II
0 986 134 284	0 986 135 284	54			HONDA	Civic Hatchback
0 986 134 286	0 986 135 286	48			FORD	Fiesta, Fiesta IV, Fiesta IV Courier, Ka

de

**Scheibenbrems-  
sätze**  
(Fortsetzung)

en

**Disc-brake  
calipers**  
(continued)

fr

**Etriers de freins  
à disques**  
(suite)

it

**Pinze freno  
a disco**  
(seguito)

es

**Pinzas de freno  
de disco**  
(continuación)



<b>0 986 134 287</b>	<b>0 986 135 287</b>		AUDI	S3, S3 Sportback, TT Coupé, TT Roadster, TTS Coupé, TTS Roadster
			SEAT	Leon, Leon Cupra
			VW (VOLKSWAGEN)	Golf VI, Golf VI Cabriolet, Scirocco, Scirocco R
			AUDI	TT Coupé, TT Roadster
<b>0 986 134 288</b>	<b>0 986 135 288</b>	54	TOYOTA	Yaris
<b>0 986 134 289</b>	<b>0 986 135 289</b>	54	MINI (BMW)	Cooper, Cooper Cabrio, Cooper Clubman, Cooper Clubvan, Cooper Coupé, Cooper One, Cooper One Cabrio, Cooper One Clubman, Cooper Roadster
<b>0 986 134 291</b>	<b>0 986 135 291</b>	48	LANCIA	Ypsilon
<b>0 986 134 294</b>	<b>0 986 135 294</b>	54	HYUNDAI	i20
<b>0 986 134 295</b>	<b>0 986 135 295</b>	57	HYUNDAI	i30, i30 CW
<b>0 986 134 297</b>	<b>0 986 135 297</b>		KIA	Cee'd, Cee'd Sporty Wagon, Pro Cee'd
			AUDI	A3, A3 Sportback, S3, S3 Sportback, TT Coupé, TT Roadster
			SKODA	Superb, Superb Combi
<b>0 986 134 299</b>	<b>0 986 135 299</b>	60	VW (VOLKSWAGEN)	Eos
<b>0 986 134 301</b>	<b>0 986 135 301</b>		NISSAN	Qashqai, Qashqai+2, X-Trail
			PEUGEOT	Boxer
<b>0 986 134 302</b>	<b>0 986 135 302</b>		PEUGEOT	Boxer
			PEUGEOT	Boxer
<b>0 986 134 303</b>	<b>0 986 135 303</b>		PEUGEOT	Boxer
			PEUGEOT	Boxer
<b>0 986 134 304</b>	<b>0 986 135 304</b>		PEUGEOT	Boxer
			PEUGEOT	Boxer
<b>0 986 134 306</b>	<b>0 986 135 306</b>		MERCEDES-BENZ	Serie V, Viano, Vito
<b>0 986 134 307</b>	<b>0 986 135 307</b>		NISSAN	Serena, Terrano II, Vanette Cargo
<b>0 986 134 309</b>	<b>0 986 135 309</b>	57	CHRYSLER	PT Cruiser, PT Cruiser Cabrio
<b>0 986 134 310</b>	<b>0 986 135 310</b>		BMW	Serie 1, Serie 1 Cabrio, Serie 1 Coupé, Serie 6 Cabrio
<b>0 986 134 311</b>	<b>0 986 135 311</b>		BMW	Serie X, Serie 1, Serie 1 Cabrio, Serie 1 Coupé, Serie 3, Serie 3 Cabrio, Serie 3 Coupé, Serie 3 Touring
<b>0 986 134 312</b>	<b>0 986 135 312</b>		LEXUS	GX
			TOYOTA	Land Cruiser, Land Cruiser Prado, 4-Runner
<b>0 986 134 313</b>	<b>0 986 135 313</b>		HOLDEN	Astra
			OPEL	Astra, Astra Caravan
			VAUXHALL	Astra, Astra Estate
<b>0 986 134 315</b>	<b>0 986 135 315</b>	54	RENAULT	Clio II, Laguna I, Laguna I Grandtour, Megane I, Megane I Cabrio, Megane I Classic, Megane I Coupé, Megane I Grandtour, Safrane, Scenic I
<b>0 986 134 316</b>	<b>0 986 135 316</b>	30	RENAULT	Clio II, Megane I, Megane I Cabrio, Megane I Classic, Megane I Coupé, Thalia
<b>0 986 134 317</b>	<b>0 986 135 317</b>	54	FIAT	Brava, Bravo, Marea, Marengo, Punto
			LANCIA	Delta
<b>0 986 134 318</b>	<b>0 986 135 318</b>	57	PEUGEOT	308, 308 CC, 308 SW, 3008
<b>0 986 134 319</b>	<b>0 986 135 319</b>	60	OPEL	Astra, Astra GTC, Astra Limousine, Astra Sporte Tourer, Astra Sports Tourer, Cascada, Insignia, Insignia Sports Tourer, Zafira
			VAUXHALL	Astra, Astra GTC, Astra Sport Tourer, Astra Sports Tourer, Cascada, Insignia, Insignia Sports Tourer, Zafira
<b>0 986 134 320</b>	<b>0 986 135 320</b>	57	VOLVO	S60 I, S80 I, V70 II, XC70 I
<b>0 986 134 321</b>	<b>0 986 135 321</b>	38	MERCEDES-BENZ	Serie C, Serie C (T-Modell), Serie E (Cabrio), Serie E (Coupé)

nl

Schijfremzadels  
(vervolg)

sv

Skivbromsok  
(fortsättning)

pt

Pinça do travão  
de disco  
(continuação)

cs

Třmeny  
kotoučových brzd  
(pokračování)

ru

Суппорты дисковых  
тормозных  
механизмов  
(продолжение)

0 986 134 322	0 986 135 322	60	MERCEDES-BENZ	Serie C, Serie C (Coupé), Serie C (T-Modell)
0 986 134 323	0 986 135 323	57	AUDI	Q3
			SEAT	Alhambra
			VW (VOLKSWAGEN)	Passat, Sharan, Tiguan
0 986 134 324	0 986 135 324	57	BMW	Serie X, Serie Z, Serie 3, Serie 3 Cabrio, Serie 3 Coupé, Serie 3 Touring
0 986 134 325	0 986 135 325	54	SUZUKI	Splash, Swift Hatchback
0 986 134 328	0 986 135 328	60	RENAULT	Espace IV, Laguna II, Laguna II Grandtour, Vel Satis
0 986 134 329	0 986 135 329	54	DACIA	Dokker, Duster, Lodgy, Logan Pick-Up
			RENAULT	Clio III, Clio III Grandtour, Clio IV, Clio IV Grandtour, Duster, Kangoo II, Modus, Zoe
0 986 134 330	0 986 135 330	52	CHEVROLET	Aveo, Aveo Hatchback
0 986 134 331	0 986 135 331	44	IVECO	Daily, Daily Chassi, Daily Furgao, Daily MaxiVan
0 986 134 332	0 986 135 332	38	CITROEN	Berlingo
			PEUGEOT	Partner
0 986 134 333	0 986 135 333	38	MERCEDES-BENZ	Serie C, Serie C (Coupé), Serie C (T-Modell), Serie E (Cabrio), Serie E (Coupé)
0 986 134 334	0 986 135 334	57	TOYOTA	Auris, Auris Touring Sports, Avensis, Avensis Wagon, Corolla Verso
0 986 134 336	0 986 135 336		MERCEDES-BENZ	Serie V, Viano, Vito
0 986 134 337	0 986 135 337	41	OPEL	Insignia, Insignia Sports Tourer
			VAUXHALL	Insignia, Insignia Sports Tourer
0 986 134 338	0 986 135 338	54	MITSUBISHI	Colt, Colt Cabrio
0 986 134 339	0 986 135 339	54	FIAT	Idea, Multipla
			LANCIA	Musa
0 986 134 340	0 986 135 340	51	KIA	Picanto
0 986 134 341	0 986 135 341	34	KIA	Picanto
0 986 134 342	0 986 135 342	36	FIAT	Punto Grande, Punto Grande Abarth, Punto Grande Abarth SS
			OPEL	Corsa
			VAUXHALL	Corsa
0 986 134 343	0 986 135 343	54	TOYOTA	Yaris
0 986 134 344	0 986 135 344	54	BMW	Serie 1, Serie 1 Cabrio, Serie 1 Coupé, Serie 3, Serie 3 Cabrio, Serie 3 Coupé, Serie 3 Touring
0 986 134 345	0 986 135 345	48	CITROEN	Jumpy
			PEUGEOT	Expert
0 986 134 346	0 986 135 346	41	CITROEN	Jumpy
			FIAT	Scudo
			PEUGEOT	Expert
0 986 134 347	0 986 135 347	60	TOYOTA	Auris, Corolla, Corolla Sedan, Urban Cruiser, Verso-S
0 986 134 430	0 986 135 430	38	FORD	Focus II, Galaxy, Kuga, Mondeo IV, Mondeo IV Turnier, S-MAX
<b>0 986 135 ...</b>				
0 986 135 040	0 986 134 040	35	NISSAN	X-Trail
0 986 135 056	0 986 134 056	60	OPEL	Signum, Vectra, Vectra Caravan
			SAAB (SAAB AUTOMOBILE AB)	9-3, 9-3 Cabriolet, 9-3 Kombi, 9-3X
			VAUXHALL	Signum, Vectra, Vectra Estate
0 986 135 079	0 986 134 079	44	MERCEDES-BENZ	Serie E, Serie E (T-Modell), Serie G, Serie ML
0 986 135 484	0 986 134 484	45	RENAULT	Master II
<b>0 986 473 ...</b>				
0 986 473 001	0 986 474 001	48	NISSAN	Micra
		54	NISSAN	Micra

de

**Scheibenbrems-  
sättel**  
(Fortsetzung)

en

**Disc-brake  
calipers**  
(continued)

fr

**Etriers de freins  
à disques**  
(suite)

it

**Pinze freno  
a disco**  
(seguito)

es

**Pinzas de freno  
de disco**  
(continuación)



<b>0 986 473 004</b>	<b>0 986 474 004</b>	54	OPEL VAUXHALL	Omega Carlton III
<b>0 986 473 005</b>	<b>0 986 474 005</b>	54	OPEL VAUXHALL	Omega Carlton III
<b>0 986 473 014</b>	<b>0 986 473 013</b>		FIAT	Uno
<b>0 986 473 020</b>	<b>0 986 473 019</b>		BMW	Serie 3, Serie 3 Cabrio, Serie 3 Coupé
<b>0 986 473 025</b>	<b>0 986 474 025</b>	54	CITROEN PEUGEOT	Berlingo Partner, Ranch
<b>0 986 473 026</b>	<b>0 986 474 026</b>	54	CITROEN PEUGEOT	Berlingo, Picasso, Xsara, Xsara Break, Xsara Coupé, Xsara Picasso Partner, Ranch, 306, 306 Break, 306 Cabriolet
<b>0 986 473 027</b>	<b>0 986 474 027</b>	38	ALFA ROMEO FIAT LANCIA	164 Croma Thema Berlina, Thema Station Wagon
<b>0 986 473 029</b>	<b>0 986 474 029</b>	41	AUDI SEAT SKODA VW (VOLKSWAGEN)	A3, TT Coupé, TT Roadster Leon, Toledo Octavia, Octavia Combi Bora, Bora Variant, Golf IV, Golf IV Variant, Jetta
<b>0 986 473 030</b>	<b>0 986 474 030</b>	54	HONDA	Civic Shuttle
<b>0 986 473 033</b>	<b>0 986 474 033</b>	30,2	HONDA	Civic, Civic Coupé, Civic CRX, Civic Hatchback, Civic Sedan
<b>0 986 473 035</b>	<b>0 986 474 035</b>	38,1	HYUNDAI	Sonata
<b>0 986 473 037</b>	<b>0 986 474 037</b>	51	MAZDA	323 Wagon
<b>0 986 473 039</b>	<b>0 986 474 039</b>	54	MAZDA	323 Hatchback, 323 Sedan
<b>0 986 473 040</b>	<b>0 986 474 040</b>	30,2	MAZDA	323 Hatchback
<b>0 986 473 041</b>	<b>0 986 474 041</b>	30,2	MAZDA	MX-6, Xedos-6, 626, 626 Hatchback
<b>0 986 473 042</b>	<b>0 986 474 042</b>	57,1	MAZDA	MX-6, Premacy, 323, 323 Hatchback, 626, 626 Fastback, 626 Hatchback, 626 Wagon
<b>0 986 473 044</b>	<b>0 986 474 044</b>	54	MITSUBISHI	Carisma, Carisma Hatchback
<b>0 986 473 045</b>	<b>0 986 474 045</b>	35	MITSUBISHI	Carisma, Carisma Hatchback
<b>0 986 473 046</b>	<b>0 986 474 046</b>	57	MITSUBISHI	L 200, L 300 Van, L 300 Wagon
<b>0 986 473 047</b>	<b>0 986 474 047</b>	34,8	MITSUBISHI	Eclipse, Lancer Hatchback
<b>0 986 473 048</b>	<b>0 986 474 048</b>	57	MITSUBISHI	L 200, L 300 Van, L 300 Wagon
<b>0 986 473 049</b>	<b>0 986 474 049</b>	53,9	MITSUBISHI	Eclipse, Lancer Hatchback, Space Runner, Space Wagon
<b>0 986 473 050</b>	<b>0 986 474 050</b>	34	NISSAN	Primera Hatchback, Primera Sedan
<b>0 986 473 051</b>	<b>0 986 474 051</b>	54	NISSAN	Almera Hatchback, Almera Sedan, Pulsar, Pulsar Hatchback, Pulsar Sedan, Sentra, Sunny
<b>0 986 473 053</b>	<b>0 986 474 053</b>	48,1	NISSAN	Sentra, Sunny Hatchback, Sunny Sedan, 100 NX
<b>0 986 473 054</b>	<b>0 986 474 054</b>	57,2	NISSAN	Almera, Almera Hatchback, Almera Sedan, Primera, Primera Hatchback, Primera Sedan
<b>0 986 473 055</b>	<b>0 986 474 055</b>	34	NISSAN	Almera Hatchback, Primera Hatchback, Primera Sedan, Primera Wagon
<b>0 986 473 056</b>	<b>0 986 474 056</b>	57	OPEL SAAB (SAAB AUTOMOBILE AB) VAUXHALL	Calibra, Vectra, Vectra Caravan 9-3, 9-3 Cabriolet, 9-3 Coupé, 9-5, 9-5 Kombi, 900 I Cabriolet, 900 I Hatchback Calibra, Vectra, Vectra Estate
<b>0 986 473 057</b>	<b>0 986 474 057</b>	52	HOLDEN VAUXHALL	Astra Astra, Astra Convertible, Astra Estate, Astra Van
<b>0 986 473 058</b>	<b>0 986 474 058</b>	48	OPEL VAUXHALL	Astra, Astra Caravan Astra, Astra Estate
<b>0 986 473 059</b>	<b>0 986 474 059</b>	41,2	OPEL VAUXHALL	Frontera, Monterey Frontera, Monterey
<b>0 986 473 060</b>	<b>0 986 474 060</b>	60,2	OPEL VAUXHALL	Frontera, Monterey Frontera, Monterey

nl

**Schijfremzadels**  
(vervolg)

sv

**Skivbromsok**  
(fortsättning)

pt





**Pinça do travão  
de disco**  
(continuação)

cs

**Třmeny  
kotoučových brzd**  
(pokračování)

ru

**Суппорты дисковых  
тормозных  
механизмов**  
(продолжение)

 eXchange		 eXchange				
<b>0 986 473 061</b>	<b>0 986 474 061</b>	35	VAUXHALL	Vectra, Vectra Estate		
<b>0 986 473 062</b>	<b>0 986 474 062</b>	57	HOLDEN	Astra		
			SAAB (SAAB AUTOMOBILE AB)	9-3, 9-3 Cabriolet, 9-3 Coupé, 9-5, 9-5 Kombi		
			VAUXHALL	Astra, Astra Convertible, Astra Coupé, Astra Estate, Astra Van, Zafira		
<b>0 986 473 064</b>	<b>0 986 474 064</b>	54	TOYOTA	Corolla, Corolla Hatchback, Corolla Liftback, Corolla Sedan, Corolla Wagon		
<b>0 986 473 065</b>	<b>0 986 474 065</b>	53,8	DAIHATSU	Feroza		
<b>0 986 473 066</b>	<b>0 986 474 066</b>	53,8	DAIHATSU	Feroza, Rocky		
<b>0 986 473 067</b>	<b>0 986 474 067</b>	42,8	TOYOTA	Hilux, Hilux Pickup, Land Cruiser		
			VW (VOLKSWAGEN)	Taro		
<b>0 986 473 068</b>	<b>0 986 474 068</b>	38	VOLVO	S40 I, V40 I		
<b>0 986 473 069</b>	<b>0 986 474 069</b>	40,45	VOLVO	740		
<b>0 986 473 070</b>	<b>0 986 474 070</b>	56,93	AUDI	A4, A4 Avant, A4 Cabriolet, A6, A6 Avant, S6, S6 Avant		
			SEAT	Exeo, Exeo ST		
			SKODA	Superb		
			VW (VOLKSWAGEN)	Passat, Passat Variant		
<b>0 986 473 071</b>	<b>0 986 474 071</b>	54	AUDI	A1, A1 Sportback, A2, A3, A3 Cabriolet, A3 Sportback		
			SEAT	Altea, Altea Freetrack, Altea XL, Cordoba, Ibiza, Ibiza SC, Ibiza ST, Leon, Mii, Toledo		
			SKODA	Citigo, Fabia, Fabia Combi, Fabia Schrägheck, Octavia, Octavia Combi, Praktik, Rapid, Rapid Spaceback, Roomster, Yeti		
			VW (VOLKSWAGEN)	Beetle, Beetle Cabriolet, Bora, Bora Variant, Caddy, Caddy Panel Van, Eos, e-up!, Fox, Golf, Golf IV, Golf IV Station Wagon, Golf IV Variant, Golf Plus, Golf V, Golf V Variant, Golf VI, Golf VI Variant, Jetta, Jetta IV, New Beetle, New Beetle Cabriolet, Polo, Polo Hatchback, Polo Limousine, Polo Sedan, Polo Vivo, up!		
<b>0 986 473 072</b>	<b>0 986 474 072</b>	38	AUDI	A3, TT Coupé, TT Roadster		
			SEAT	Cordoba, Ibiza, Leon, Toledo		
			SKODA	Octavia, Octavia Combi		
			VW (VOLKSWAGEN)	Golf Cabriolet, Golf IV, Golf IV Cabriolet, New Beetle, Polo Classic, Polo Variant		
<b>0 986 473 073</b>	<b>0 986 474 073</b>	38	FORD	Galaxy		
			SEAT	Alhambra		
			VW (VOLKSWAGEN)	California T4, Caravelle T4, Eurovan, Kombi, Multivan T4, Sharan, Transporter T4		
<b>0 986 473 074</b>	<b>0 986 474 074</b>	34,8	MAZDA	Premacy, 323, 323 Hatchback, 626, 626 Wagon		
<b>0 986 473 075</b>	<b>0 986 474 075</b>	33,94	BMW	Serie 3 Compact		
<b>0 986 473 076</b>	<b>0 986 473 076</b>	29,94	CITROEN	BX		
<b>0 986 473 077</b>	<b>0 986 474 077</b>	33,9	ALFA ROMEO	GTV, 145, 146, 155		
			FIAT	Barchetta, Coupé, Marengo, Punto GT, Tempra, Tempra SW, Tipo		
			LANCIA	Dedra Berlina, Dedra Station Wagon, Delta		
<b>0 986 473 078</b>	<b>0 986 474 078</b>	59,93	FORD	Mondeo I, Mondeo I Turnier, Scorpio II, Scorpio II Turnier		
<b>0 986 473 079</b>	<b>0 986 474 079</b>	53,94	FORD	Focus, Focus I, Focus I Turnier		
<b>0 986 473 080</b>	<b>0 986 474 080</b>	33,9	FORD	Focus, Focus I, Focus I Turnier, Focus Sedan		
<b>0 986 473 082</b>	<b>0 986 474 082</b>	51,04	HONDA	Civic, Civic Coupé, Civic Hatchback, Civic Sedan, Civic Sedan		
<b>0 986 473 083</b>	<b>0 986 474 083</b>	33,9	HYUNDAI	Avante, Coupé, Elantra, Lantra, Lantra Kombi, Tiburon		
			KIA	Cerato, Cerato Hatchback		

de

**Scheibenbrems-  
sättel**  
(Fortsetzung)

en

**Disc-brake  
calipers**  
(continued)

fr

**Etriers de freins  
à disques**  
(suite)

it

**Pinze freno  
a disco**  
(seguito)

es

**Pinzas de freno  
de disco**  
(continuación)



<b>0 986 473 084</b>	<b>0 986 474 084</b>	51,04	HYUNDAI	Atos, Atos Prime
<b>0 986 473 085</b>	<b>0 986 474 085</b>	57,11	PEUGEOT	406, 406 Break, 406 Coupé
<b>0 986 473 086</b>	<b>0 986 474 086</b>	57,11	PEUGEOT	406, 406 Break, 406 Coupé
<b>0 986 473 088</b>	<b>0 986 474 088</b>	54	MG	ZS
			ROVER	Serie 200, Serie 400, Serie 400 Coupé, Serie 400 Tourer, 25, 45
<b>0 986 473 089</b>	<b>0 986 474 089</b>	51,04	TOYOTA	Conquest, Corolla, Corolla Hatchback, Corolla Liftback, Corolla Station Wagon, Corolla Wagon
<b>0 986 473 090</b>	<b>0 986 474 090</b>	59,93	BMW	Serie 5, Serie 5 Touring
<b>0 986 473 091</b>	<b>0 986 474 091</b>	30,1	NISSAN	Pulsar, Pulsar Hatchback, Sunny Hatchback, Sunny Sedan, 100 NX
<b>0 986 473 092</b>	<b>0 986 474 092</b>	30,15	NISSAN	Almera Hatchback, Almera Sedan, Pulsar Hatchback, Pulsar Sedan
<b>0 986 473 093</b>	<b>0 986 474 093</b>	33,9	NISSAN	Almera, Almera Hatchback, Almera Sedan, Pulsar Hatchback
<b>0 986 473 094</b>	<b>0 986 474 094</b>	32,95	FORD	Escort VII, Escort VII Cabrio, Escort VII RS, Escort VII Turnier, Escort VII XR3i Cabrio, Escort V/VI, Escort V/VI Cabrio, Escort V/VI Express, Escort V/VI RS, Escort V/VI Turnier, Escort V/VI XR3i, Escort V/VI XR3i Cabrio
<b>0 986 473 095</b>	<b>0 986 474 095</b>	34,96	MERCEDES-BENZ	Serie C
<b>0 986 473 096</b>	<b>0 986 474 096</b>	56,93	MERCEDES-BENZ	Serie C, Serie C (T-Modell), Serie CLK (Cabrio), Serie CLK (Coupé), Serie E, Serie E (T-Modell), Serie SLK
<b>0 986 473 097</b>	<b>0 986 474 097</b>	54	MERCEDES-BENZ	Serie A
<b>0 986 473 098</b>	<b>0 986 474 098</b>	54	MERCEDES-BENZ	Serie A
<b>0 986 473 099</b>	<b>0 986 474 099</b>	38,1	AUDI	A3, TT Coupé, TT Roadster
			SEAT	Cordoba, Ibiza, Ibiza SC, Leon, Toledo
			SKODA	Fabia, Fabia Combi, Fabia Schrägheck, Praktik, Roomster
			VW (VOLKSWAGEN)	Golf, Golf IV, Golf IV Station Wagon, Golf IV Variant, New Beetle, New Beetle Cabriolet, Polo, Polo Sedan
<b>0 986 473 100</b>	<b>0 986 474 100</b>	48	PEUGEOT	205, 205 Pickup
<b>0 986 473 101</b>	<b>0 986 474 101</b>	48	RENAULT	Clio I, Express, Extra, Rapid, 5, 19
<b>0 986 473 103</b>	<b>0 986 474 103</b>	48	CITROEN	AX, C 15, Saxo, ZX
			PEUGEOT	106, 205, 205 Pickup
<b>0 986 473 104</b>	<b>0 986 474 104</b>	48	AUTOBIANCHI	Y 10
			FIAT	Panda, Uno, Uno Van
			LANCIA	Y 10
			SEAT	Marbella, Terra
<b>0 986 473 106</b>	<b>0 986 474 106</b>	41	SEAT	Leon, Toledo
			SKODA	Octavia, Octavia Combi
			VW (VOLKSWAGEN)	Bora, Bora Variant, Golf IV Variant, Jetta
<b>0 986 473 107</b>	<b>0 986 474 107</b>	48	CITROEN	C2, C3
<b>0 986 473 108</b>	<b>0 986 474 108</b>	32,94	PEUGEOT	406, 406 Break, 406 Coupé
<b>0 986 473 109</b>	<b>0 986 474 109</b>	38,1	AUDI	A4, A4 Avant, A4 Cabriolet
			SEAT	Exeo, Exeo ST
<b>0 986 473 110</b>	<b>0 986 474 110</b>	51,04	TOYOTA	Echo, Vitz, Yaris
<b>0 986 473 111</b>	<b>0 986 474 111</b>	56,93	FORD	Galaxy
			SEAT	Alhambra
			VW (VOLKSWAGEN)	Sharan
<b>0 986 473 112</b>	<b>0 986 474 112</b>	53,95	SKODA	Favorit, Felicia, Felicia Combi, Felicia Fun, Forman, Pick-Up
			VW (VOLKSWAGEN)	Caddy Pickup
<b>0 986 473 113</b>	<b>0 986 474 113</b>	41,95	VOLVO	S60 I, S80 I, V70 II, XC70 I
<b>0 986 473 114</b>	<b>0 986 474 114</b>	59,95	VOLVO	S60 I, S80 I, V70 II, XC70 I

nl

**Schijfremzadels**  
(vervolg)

sv

**Skivbromsok**  
(fortsättning)

pt





**Pinça do travão  
de disco**  
(continuação)

cs

**Třmeny  
kotoučových brzd**  
(pokračování)

ru

**Суппорты дисковых  
тормозных  
механизмов**  
(продолжение)

						
<b>0 986 473 115</b>	<b>0 986 474 115</b>	57,11	CITROEN	Evasion, Jumpy		
			FIAT	Scudo, Ulysse		
			LANCIA	Zeta		
			PEUGEOT	Expert, 806		
<b>0 986 473 116</b>	<b>0 986 474 116</b>	56,93	TOYOTA	Avensis, Avensis Liftback, Avensis Wagon		
<b>0 986 473 117</b>	<b>0 986 474 117</b>	39,93	BMW	Serie 5		
<b>0 986 473 119</b>	<b>0 986 474 119</b>	39,93	OPEL	Omega		
			VAUXHALL	Omega		
<b>0 986 473 120</b>	<b>0 986 474 120</b>	53,9	HYUNDAI	Coupé, Elantra, Elantra Hatchback, Lantra, Lantra Kombi, Matrix		
<b>0 986 473 121</b>	<b>0 986 474 121</b>	33,9	ALFA ROMEO	GTV, Spider, 145, 146, 155		
			FIAT	Barchetta, Bravo, Coupé, Marea, Punto GT, Tempra, Tempra SW		
			LANCIA	Dedra Berlina, Dedra Station Wagon		
<b>0 986 473 122</b>	<b>0 986 474 122</b>	53,95	VOLVO	440, 460, 480		
<b>0 986 473 124</b>	<b>0 986 474 124</b>	39,93	BMW	Serie 5		
<b>0 986 473 125</b>	<b>0 986 474 125</b>	54	FIAT	Doblo, Doblo Cargo, Palio, Palio Weekend, Siena, Strada		
<b>0 986 473 126</b>	<b>0 986 474 126</b>	57,15	TOYOTA	Carina E Liftback, Carina E Sedan, Carina E Wagon, Celica Liftback		
<b>0 986 473 127</b>	<b>0 986 474 127</b>	53,93	MAZDA	323, 323 Hatchback, 323 Sedan		
<b>0 986 473 129</b>	<b>0 986 474 129</b>	60,23	TOYOTA	Dyna 100, Hiace, Hilux, Hilux Pickup		
<b>0 986 473 131</b>	<b>0 986 474 131</b>	37,94	SAAB (SAAB AUTOMOBILE AB)	9-5, 9-5 Kombi		
<b>0 986 473 132</b>	<b>0 986 474 132</b>	42,78	NISSAN	Serena, Vanette Cargo		
<b>0 986 473 133</b>	<b>0 986 474 133</b>	51,05	MAZDA	MX-5		
<b>0 986 473 134</b>	<b>0 986 474 134</b>	37,94	BMW	Serie 3 Cabrio, Serie 3 Touring		
<b>0 986 473 135</b>	<b>0 986 474 135</b>	37,94	BMW	Serie 3, Serie 3 Cabrio, Serie 3 Coupé, Serie 3 Touring		
<b>0 986 473 136</b>	<b>0 986 474 136</b>	57,1	NISSAN	Primera Hatchback, Primera Sedan		
<b>0 986 473 137</b>	<b>0 986 474 137</b>	48,04	SUZUKI	Vitara, Vitara Cabrio		
<b>0 986 473 138</b>	<b>0 986 474 138</b>	47,96	PEUGEOT	206		
<b>0 986 473 139</b>	<b>0 986 474 139</b>	38,1	AUDI	S3, TT Coupé, TT Roadster		
			SEAT	Leon, Leon Cupra, Toledo		
			VW (VOLKSWAGEN)	Bora, Bora Variant, Golf, Golf IV, Golf IV Variant, Jetta IV, New Beetle		
<b>0 986 473 140</b>	<b>0 986 474 140</b>	42,72	MITSUBISHI	Pajero, Pajero Cabrio		
<b>0 986 473 141</b>	<b>0 986 474 141</b>	53,95	VOLVO	440, 460, 480		
<b>0 986 473 143</b>	<b>0 986 474 143</b>	53,94	VOLVO	440, 460, 480		
<b>0 986 473 145</b>	<b>0 986 474 145</b>	39,94	VOLVO	960		
<b>0 986 473 147</b>	<b>0 986 474 147</b>	38	AUDI	TT Coupé, TT Roadster		
			SEAT	Leon, Leon Cupra, Leon Cupra R		
			VW (VOLKSWAGEN)	Golf IV, Golf IV Variant		
<b>0 986 473 148</b>	<b>0 986 474 148</b>	54	VW (VOLKSWAGEN)	Lupo, Polo		
<b>0 986 473 149</b>	<b>0 986 474 149</b>	54	SEAT	Arosa		
			VW (VOLKSWAGEN)	Lupo, Polo		
			SEAT	Cordoba, Cordoba Vario, Ibiza		
<b>0 986 473 150</b>	<b>0 986 474 150</b>	38,1	VW (VOLKSWAGEN)	Polo, Polo Classic, Polo Variant		
<b>0 986 473 151</b>	<b>0 986 474 151</b>	53,93	AUDI	Cabriolet, Coupé		
<b>0 986 473 153</b>	<b>0 986 474 153</b>	42,73	MITSUBISHI	L 200, L 200 Forte, L 400, Pajero, Pajero Cabrio, Pajero Sport, Space Gear		
			VW (VOLKSWAGEN)	Polo		
<b>0 986 473 155</b>	<b>0 986 474 155</b>	38,1	VW (VOLKSWAGEN)	Polo		
<b>0 986 473 156</b>	<b>0 986 474 156</b>	38	LANCIA	Kappa Berlina		
<b>0 986 473 157</b>	<b>0 986 474 157</b>	53,92	ALFA ROMEO	147, 156 Berlina, 156 Sport Wagon		
<b>0 986 473 159</b>	<b>0 986 474 159</b>	39,94	BMW	Serie Z, Serie Z Coupé, Serie 3, Serie 3 Cabrio, Serie 3 Compact, Serie 3 Coupé, Serie 3 Touring		



de

**Scheibenbrems-  
sättel**  
(Fortsetzung)

en

**Disc-brake  
calipers**  
(continued)

fr

**Etriers de freins  
à disques**  
(suite)

it

**Pinze freno  
a disco**  
(seguito)

es

**Pinzas de freno  
de disco**  
(continuación)



0 986 473 161	0 986 474 161	40,4	CITROEN	Jumper
			FIAT	Ducato 10, Ducato 14
			PEUGEOT	Boxer
0 986 473 162	0 986 474 162	40,4	CITROEN	Jumper
			FIAT	Ducato 10, Ducato 14, Ducato 18
			PEUGEOT	Boxer
0 986 473 163	0 986 474 163	48	CITROEN	Jumper
			FIAT	Ducato 18
			PEUGEOT	Boxer
0 986 473 164	0 986 474 164	56,97	CITROEN	C5, C5 Break
0 986 473 165	0 986 474 165	31,96	CITROEN	C5, C5 Break
0 986 473 166	0 986 474 166	51,95	IVECO	Daily
0 986 473 167	0 986 474 167	56,96	FORD	Mondeo III, Mondeo III Turnier
0 986 473 169	0 986 474 169	60,21	MITSUBISHI	L 200, L 200 Forte, L 400, Pajero, Pajero Cabrio, Space Gear
0 986 473 170	0 986 474 170	51,05	MAZDA	MX-5
0 986 473 171	0 986 474 171	53,9	HYUNDAI	Accent, Avante, Elantra, Excel, Excel Hatchback, Getz, Lantra, Pony, Scoupe, Verna
0 986 473 172	0 986 474 172	37,93	OPEL	Signum, Vectra Caravan
			VAUXHALL	Signum, Vectra, Vectra Estate
0 986 473 173	0 986 474 173	37,93	FORD	C-MAX, Focus C-MAX, Focus II, Focus II Cabriolet, Focus II Turnier
			MAZDA	3, 3 Hatchback
			VOLVO	S40 II
0 986 473 174	0 986 474 174	35,96	MERCEDES-BENZ	Serie C, Serie C (T-Modell), Serie CLK (Cabrio), Serie CLK (Coupé), Serie E, Serie SLK
0 986 473 175	0 986 474 175	35,92	RENAULT	Espace III, Laguna I, Laguna I Grandtour
0 986 473 176	0 986 474 176	54	VOLVO	S40 I, V40 I
0 986 473 177	0 986 474 177	53,94	VW (VOLKSWAGEN)	California T4, Caravelle T4, Eurovan, Kombi, Multivan T4, Transporter T4
0 986 473 179	0 986 474 179	42	FORD	Transit
0 986 473 180	0 986 474 180	34	AUDI	A2
			SEAT	Cordoba, Ibiza
			VW (VOLKSWAGEN)	Polo, Polo Hatchback, Polo Limousine, Polo Sedan
0 986 473 182	0 986 474 182	37,96	SAAB (SAAB AUTOMOBILE AB)	9-5, 9-5 Kombi
0 986 473 183	0 986 474 183	53,96	VOLVO	S40 I, V40 I
0 986 473 184	0 986 474 184	57	FORD	Galaxy
			SEAT	Alhambra
			VW (VOLKSWAGEN)	California T4, Caravelle T4, Eurovan, Multivan T4, Sharan, Transporter T4
0 986 473 185	0 986 474 185	43	AUDI	A6, A6 Allroad, A6 Avant, S6, S6 Avant
			VW (VOLKSWAGEN)	Passat, Passat Variant
0 986 473 188	0 986 474 188	44	VW (VOLKSWAGEN)	California T5, Caravelle T5, Multivan T5, Transporter T5
0 986 473 189	0 986 473 189	40	VOLVO	S70, S70 R, V70 I, 850, 850 Kombi, 960
0 986 473 191	0 986 474 191	48	VW (VOLKSWAGEN)	Polo
0 986 473 192	0 986 474 192	54	SEAT	Cordoba, Ibiza
			SKODA	Fabia, Fabia Combi, Fabia Schrägheck, Praktik, Roomster
			VW (VOLKSWAGEN)	Polo
0 986 473 194	0 986 474 194	60	CHRYSLER	Concorde, Intrepid, LHS, Voyager, 300M
			DODGE	Caravan, Intrepid
0 986 473 196	0 986 474 196	57	TOYOTA	Celica Coupé, Corolla, Corolla Altis, Corolla Verso, Corolla Wagon

nl

**Schijfremzadels**  
(vervolg)

sv

**Skivbromsok**  
(fortsättning)

pt

**Pinça do travão  
de disco**  
(continuação)

cs

**Třmeny  
kotoučových brzd**  
(pokračování)

ru

**Суппорты дисковых  
тормозных  
механизмов**  
(продолжение)



0 986 473 198	0 986 474 198	32	TOYOTA	Celica Liftback
0 986 473 199	0 986 474 199	52	MERCEDES-BENZ	MB
0 986 473 200	0 986 474 200	57	TOYOTA	Corolla, Corolla Hatchback, Corolla Wagon
0 986 473 201	0 986 474 201	38	TOYOTA	Avensis, Avensis Liftback, Avensis Wagon, Corolla Verso
0 986 473 202	0 986 474 202	54	TOYOTA	RAV4, RAV4 Cabrio
0 986 473 203	0 986 474 203	51	HYUNDAI	Accent, Accent Hatchback, Excel, Excel Hatchback, Pony
0 986 473 205	0 986 474 205	35	MITSUBISHI	Galant, Galant Hatchback, Galant Station Wagon
0 986 473 206	0 986 473 206	36	CITROEN	Xantia Break
0 986 473 207	0 986 474 207	35	MAZDA	6, 6 Fastback, 6 Sedan, 6 Wagon
0 986 473 210	0 986 474 210	30	TOYOTA	Limo, Yaris
0 986 473 211	0 986 474 211	51	TOYOTA	Echo, Funcargo, Ist, Vitz, Yaris, Yaris Verso
0 986 473 212	0 986 474 212	51	TOYOTA	Yaris
0 986 473 213	0 986 474 213	36	TOYOTA	Corolla, Corolla Sedan, Corolla Verso, Corolla Wagon
0 986 473 214	0 986 474 214	35	TOYOTA	Corolla, Corolla Hatchback, Corolla Liftback, Corolla Sedan, Corolla Wagon
0 986 473 215	0 986 474 215	30	TOYOTA	Yaris Verso
0 986 473 216	0 986 474 216	38	LEXUS	ES
			TOYOTA	Avensis, Avensis Liftback, Avensis Wagon, Camry, Camry Sedan, Camry Wagon
0 986 473 217	0 986 474 217	40	TOYOTA	Avensis, Avensis Liftback, Avensis Wagon
0 986 473 218	0 986 474 218	53	TOYOTA	Avensis, Avensis Liftback, Avensis Wagon, Corolla Verso
0 986 473 219	0 986 474 219	42	BMW	Serie X
0 986 473 220	0 986 474 220	57	MERCEDES-BENZ	Serie C, Serie C (Sportcoupe), Serie C (T-Modell), Serie CLC, Serie CLK (Coupé), Serie SLK
0 986 473 221	0 986 474 221		MERCEDES-BENZ	Serie ML
0 986 473 222	0 986 474 222		MERCEDES-BENZ	Serie E
0 986 473 223	0 986 474 223	38,1	OPEL	Astra, Astra Cabrio, Astra Caravan, Astra Coupé, Meriva, Zafira
			VAUXHALL	Astra, Astra Convertible, Astra Coupé, Astra Estate, Meriva, Zafira
0 986 473 224	0 986 474 224	67	TOYOTA	Hiace, Hiace Van, Hiace Wagon, Quantum
0 986 473 225	0 986 474 225	38,1	AUDI	A6, A6 Allroad, A6 Avant
			VW (VOLKSWAGEN)	Passat, Passat Variant
0 986 473 226	0 986 474 226	37,93	RENAULT	Espace IV, Laguna II, Laguna II Grandtour, Megane II Hatchback, Vel Satis
0 986 473 227	0 986 474 227	30	MITSUBISHI	Colt, Lancer
0 986 473 228	0 986 474 228	38,1	CITROEN	C4, C4 Coupé, C4 Sedan, DS4
			PEUGEOT	307, 307 Break/SW, 307 CC, 307 Sedan, 308, 308 CC, 308 SW
0 986 473 229	0 986 474 229	60	AUDI	A4, A4 Avant, A4 Cabriolet, A6, A6 Allroad, A6 Avant, A8
			SEAT	Exeo, Exeo ST
0 986 473 231	0 986 474 231	45	MERCEDES-BENZ	Sprinter, 311 Sprinter, 411 Sprinter
			VW (VOLKSWAGEN)	LT
0 986 473 235	0 986 474 235	60	MERCEDES-BENZ	Serie V, Vito
0 986 473 235	0 986 474 235	60	MERCEDES-BENZ	Serie V, Vito
0 986 473 236	0 986 474 236	57	VW (VOLKSWAGEN)	LT
0 986 473 238	0 986 474 238	40	VOLVO	740
0 986 473 239	0 986 474 239	38	VOLVO	960
0 986 473 241	0 986 474 241	40	BMW	Serie 5 Touring
0 986 473 242	0 986 474 242	57	ROVER	Serie 600
0 986 473 243	0 986 474 243	34	NISSAN	Primera Hatchback, Primera Sedan

de

**Scheibenbrems-  
sättel**  
(Fortsetzung)

en

**Disc-brake  
calipers**  
(continued)

fr

**Etriers de freins  
à disques**  
(suite)

it

**Pinze freno  
a disco**  
(seguito)

es

**Pinzas de freno  
de disco**  
(continuación)



<b>0 986 473 249</b>	<b>0 986 474 249</b>	60	MERCEDES-BENZ VW (VOLKSWAGEN)	Sprinter, 311 Sprinter LT
<b>0 986 473 250</b>	<b>0 986 474 250</b>	44	MERCEDES-BENZ VW (VOLKSWAGEN)	Sprinter, 311 Sprinter, 411 Sprinter LT
<b>0 986 473 251</b>	<b>0 986 474 251</b>	38	ALFA ROMEO FIAT LANCIA	GT, 147, 156 Berlina, 156 Sport Wagon Linea Lybra Berlina, Lybra Station Wagon
<b>0 986 473 252</b>	<b>0 986 474 252</b>	34	HOLDEN OPEL VAUXHALL	Astra Astra, Astra Caravan Astra, Astra Estate, Astra Van
<b>0 986 473 254</b>	<b>0 986 474 254</b>	38	CITROEN PEUGEOT	C4, C4 Coupé 307, 307 Break/SW, 307 CC, 307 Sedan
<b>0 986 473 256</b>	<b>0 986 474 256</b>		OPEL VAUXHALL	Corsa, Tigra TwinTop Combo, Corsa, Tigra TwinTop
<b>0 986 473 257</b>	<b>0 986 474 257</b>	48	OPEL VAUXHALL	Corsa Corsa
<b>0 986 473 258</b>	<b>0 986 474 258</b>	38	OPEL VAUXHALL	Astra, Astra Caravan, Astra Coupé, Astra GTC, Astra TwinTop, Combo, Meriva, Zafira Astra, Astra Coupé, Astra Estate, Astra GTC, Astra TwinTop, Combo, Meriva
<b>0 986 473 259</b>	<b>0 986 474 259</b>	57	FORD SEAT VW (VOLKSWAGEN)	Galaxy Alhambra California T4, Caravelle T4, Multivan T4, Sharan, Transporter T4
<b>0 986 473 260</b>	<b>0 986 474 260</b>	42	NISSAN OPEL RENAULT VAUXHALL	Interstar Movano Master II Movano
<b>0 986 473 261</b>	<b>0 986 474 261</b>	36	OPEL VAUXHALL	Astra, Astra Caravan, Meriva Meriva
<b>0 986 473 262</b>	<b>0 986 474 262</b>	60	BMW	Serie X, Serie 5, Serie 5 Touring, Serie 7
<b>0 986 473 264</b>	<b>0 986 474 264</b>	54	NISSAN	Almera Hatchback, Almera Sedan, Pulsar Hatchback
<b>0 986 473 266</b>	<b>0 986 474 266</b>	48	PEUGEOT	405, 405 Break
<b>0 986 473 267</b>	<b>0 986 474 267</b>	36	RENAULT	Laguna I, Laguna I Grandtour
<b>0 986 473 268</b>	<b>0 986 474 268</b>	42	SMART (MCC)	Fortwo Cabrio, Fortwo Coupé, Roadster, Roadster Coupé, Smart Cabrio, Smart Coupé, Smart Crossblade
<b>0 986 473 270</b>	<b>0 986 474 270</b>	57	AUDI	A4, A4 Avant
<b>0 986 473 271</b>	<b>0 986 474 271</b>	48	OPEL VAUXHALL	Corsa Corsa
<b>0 986 473 272</b>	<b>0 986 474 272</b>	48	FORD NISSAN	Transit, Transit Euroline, Transit Nugget, Transit Tourneo Cabstar E
<b>0 986 473 273</b>	<b>0 986 474 273</b>	34	MINI (BMW)	Cooper, Cooper One, Cooper S
<b>0 986 473 274</b>	<b>0 986 474 274</b>	54	MITSUBISHI	Carisma, Carisma Hatchback, Spacestar
<b>0 986 473 275</b>	<b>0 986 474 275</b>	54	FORD MAZDA	Fiesta IV, Fiesta IV Courier, Fiesta V, Fusion, Ka, Puma, Streetka 2
<b>0 986 473 276</b>	<b>0 986 474 276</b>	36	MERCEDES-BENZ	Serie C, Serie CLK (Cabrio), Serie CLK (Coupé), Serie E, Serie SL
<b>0 986 473 279</b>	<b>0 986 474 279</b>	36	RENAULT	Safrane
<b>0 986 473 280</b>	<b>0 986 474 280</b>	34	RENAULT	Megane II, Megane II Cabrio, Megane II Grandtour, Megane II Hatchback, Scenic II, Twingo II, Wind
<b>0 986 473 281</b>	<b>0 986 474 281</b>	36	FORD	Cougar, Mondeo, Mondeo I, Mondeo II
<b>0 986 473 282</b>	<b>0 986 474 282</b>	36	MERCEDES-BENZ	Serie C, Serie C (Sportcoupe), Serie CLC, Serie CLK (Coupé), Serie SLK

nl

**Schijfremzadels**  
(vervolg)

sv

**Skivbromsok**  
(fortsättning)

pt





**Pinça do travão de disco**  
(continuação)

cs

**Třmeny kotoučových brzd**  
(pokračování)

ru

**Суппорты дисковых тормозных механизмов**  
(продолжение)

 eXchange		 eXchange				
<b>0 986 473 284</b>	<b>0 986 474 284</b>	38	FORD	Mondeo III Turnier		
			JAGUAR	X-Type, X-Type Estate		
<b>0 986 473 286</b>	<b>0 986 474 286</b>	48	PEUGEOT	106, 205		
<b>0 986 473 288</b>	<b>0 986 474 288</b>	48	PEUGEOT	206		
<b>0 986 473 289</b>	<b>0 986 474 289</b>	54	CITROEN	Xantia, Xantia Break		
<b>0 986 473 293</b>	<b>0 986 474 293</b>	40	VOLVO	740		
<b>0 986 473 294</b>	<b>0 986 474 294</b>	57	SAAB (SAAB AUTOMOBILE AB)	9-3		
			VAUXHALL	Signum, Vectra, Vectra Estate		
<b>0 986 473 295</b>	<b>0 986 474 295</b>	36	CITROEN	Evasion		
<b>0 986 473 296</b>	<b>0 986 474 296</b>	41	LAND ROVER GROUP	Defender 90, Discovery I, Range Rover I, Range Rover II		
<b>0 986 473 297</b>	<b>0 986 474 297</b>	54	OPEL	Omega		
			VAUXHALL	Omega		
<b>0 986 473 300</b>	<b>0 986 474 300</b>	38	FORD	Mondeo III		
<b>0 986 473 302</b>	<b>0 986 474 302</b>	57	LAND ROVER GROUP	Freelander		
<b>0 986 473 303</b>	<b>0 986 474 303</b>	57	LAND ROVER GROUP	Freelander		
<b>0 986 473 304</b>	<b>0 986 474 304</b>	41	LAND ROVER GROUP	Discovery I		
<b>0 986 473 306</b>	<b>0 986 474 306</b>	60	OPEL	Campo Pick-Up, Frontera		
			VAUXHALL	Brava Pick-Up, Frontera		
<b>0 986 473 307</b>	<b>0 986 474 307</b>	40	OPEL	Omega		
			VAUXHALL	Carlton III		
<b>0 986 473 308</b>	<b>0 986 474 308</b>	60	OPEL	Signum, Vectra, Vectra Caravan		
			SAAB (SAAB AUTOMOBILE AB)	9-3		
			VAUXHALL	Signum, Vectra, Vectra Estate		
<b>0 986 473 310</b>	<b>0 986 474 310</b>	38	FIAT	Multipla, Stilo, Stilo Multi Wagon		
<b>0 986 473 313</b>	<b>0 986 474 313</b>	57	CITROEN	Xantia, Xantia Break		
<b>0 986 473 315</b>	<b>0 986 474 315</b>	57	CITROEN	Xantia Break		
<b>0 986 473 324</b>	<b>0 986 474 324</b>	34	OPEL	Astra, Astra Cabrio, Astra Caravan		
			VAUXHALL	Astra, Astra Estate, Astra Van		
<b>0 986 473 325</b>	<b>0 986 474 325</b>	36	HOLDEN	Astra		
			OPEL	Astra, Astra Cabrio, Astra Caravan		
			VAUXHALL	Astra, Astra Convertible, Astra Estate, Astra Van		
<b>0 986 473 326</b>	<b>0 986 474 326</b>	38	OPEL	Astra, Astra Cabrio, Astra Caravan, Astra Coupé, Zafira		
			VAUXHALL	Astra, Astra Estate, Zafira		
<b>0 986 473 328</b>	<b>0 986 474 328</b>	45	OPEL	Movano		
			RENAULT	Master II		
			VAUXHALL	Movano		
<b>0 986 473 329</b>	<b>0 986 474 329</b>	57	MERCEDES-BENZ	Serie CLK (Cabrio), Serie CLK (Coupé), Serie E, Serie E (T-Modell), Serie SLK		
<b>0 986 473 330</b>	<b>0 986 474 330</b>	54	SAAB (SAAB AUTOMOBILE AB)	900 I Cabriolet, 900 I Hatchback, 900 II, 900 II Cabriolet, 900 II Coupé		
<b>0 986 473 331</b>	<b>0 986 474 331</b>	54	HYUNDAI	Avante, Coupé, Elantra, Lantra, Lantra Kombi, Tiburon		
<b>0 986 473 333</b>	<b>0 986 474 333</b>	35	TOYOTA	Camry, Camry Sedan, Carina E Liftback, Carina E Sedan, Carina E Wagon		
<b>0 986 473 334</b>	<b>0 986 474 334</b>	54	RENAULT	Grand Scenic II, Megane II, Megane II Cabrio, Megane II Grandtour, Megane II Hatchback, Scenic II		
<b>0 986 473 335</b>	<b>0 986 474 335</b>	54	RENAULT	Clio III, Grand Scenic II, Megane II, Megane II Cabrio, Megane II Grandtour, Megane II Hatchback, Scenic II		
<b>0 986 473 338</b>	<b>0 986 474 338</b>	38	MERCEDES-BENZ	Viano, Vito		
<b>0 986 473 341</b>	<b>0 986 474 341</b>	57	RENAULT	Laguna II, Laguna II Grandtour, Scenic I		
<b>0 986 473 343</b>	<b>0 986 474 343</b>	48	OPEL	Agila		
			VAUXHALL	Agila		

de

**Scheibenbrems-  
sättel**  
(Fortsetzung)

en

**Disc-brake  
calipers**  
(continued)

fr

**Etriers de freins  
à disques**  
(suite)

it

**Pinze freno  
a disco**  
(seguito)

es

**Pinzas de freno  
de disco**  
(continuación)



<b>0 986 473 344</b>	<b>0 986 474 344</b>	48	OPEL SUZUKI VAUXHALL	Agila Wagon R+ Agila
<b>0 986 473 346</b>	<b>0 986 474 346</b>	38	NISSAN	Almera Hatchback, Almera Sedan, Almera Tino
<b>0 986 473 348</b>	<b>0 986 474 348</b>	48	LAND ROVER GROUP	Discovery II, Range Rover II
<b>0 986 473 352</b>	<b>0 986 474 352</b>	33,9	SEAT VW (VOLKSWAGEN)	Arosa, Cordoba, Cordoba Vario, Ibiza Lupo, Polo, Polo Classic, Polo Variant
<b>0 986 473 353</b>	<b>0 986 474 353</b>	51,92	MERCEDES-BENZ VW (VOLKSWAGEN)	Sprinter, 311 Sprinter, 411 Sprinter LT
<b>0 986 473 354</b>	<b>0 986 474 354</b>	38,1	MITSUBISHI VOLVO	Carisma, Carisma Hatchback, Spacestar S40 I, V40 I
<b>0 986 473 357</b>	<b>0 986 474 357</b>	53,95	RENAULT	Kangoo I
<b>0 986 473 359</b>	<b>0 986 474 359</b>	52	MERCEDES-BENZ VW (VOLKSWAGEN)	Sprinter, 311 Sprinter, 411 Sprinter LT
<b>0 986 473 360</b>	<b>0 986 474 360</b>	32,96	MERCEDES-BENZ	Serie V, Vito
<b>0 986 473 361</b>	<b>0 986 474 361</b>	56,93	VW (VOLKSWAGEN)	California T4, Caravelle T4, Eurovan, Kombi, Multivan T4, Transporter T4
<b>0 986 473 362</b>	<b>0 986 474 362</b>	60	MERCEDES-BENZ	Serie V, Vito
<b>0 986 473 363</b>	<b>0 986 474 363</b>	44,93	MERCEDES-BENZ VW (VOLKSWAGEN)	Sprinter LT
<b>0 986 473 365</b>	<b>0 986 474 365</b>	45	LAND ROVER GROUP	Discovery II, Range Rover II
<b>0 986 473 367</b>	<b>0 986 474 367</b>	40	BMW	Serie 7
<b>0 986 473 368</b>	<b>0 986 474 368</b>	60	BMW	Serie 5, Serie 5 Touring
<b>0 986 473 369</b>	<b>0 986 474 369</b>	38	TOYOTA	Carina E Liftback, Carina E Sedan, Carina E Wagon
<b>0 986 473 370</b>	<b>0 986 474 370</b>	51	ROVER	Mini, Mini Cabrio, Mini Cooper, Mini Cooper Cabrio, Mini De Ville, Mini De Ville Cabrio, Mini Margrave, Mini Retro Rally
<b>0 986 473 371</b>	<b>0 986 474 371</b>		BMW	Serie 7
<b>0 986 473 374</b>	<b>0 986 474 374</b>	60	BMW	Serie 5, Serie 5 Touring, Serie 6, Serie 6 Cabrio, Serie 7
<b>0 986 473 379</b>	<b>0 986 474 379</b>	34,94	OPEL SAAB (SAAB AUTOMOBILE AB) VAUXHALL	Vectra, Vectra Caravan 9-3, 9-3 Cabriolet, 9-3 Coupé, 900 I Cabriolet, 900 I Hatchback, 900 II, 900 II Cabriolet, 900 II Coupé Vectra, Vectra Estate
<b>0 986 473 380</b>	<b>0 986 474 380</b>	53,95	MITSUBISHI	Colt, Lancer, Lancer Sedan, Lancer Station Wagon
<b>0 986 473 381</b>	<b>0 986 474 381</b>	38,1	AUDI SEAT SKODA VW (VOLKSWAGEN)	A3, A3 Cabriolet, A3 Sportback Altea, Altea Freetrack, Altea XL, Leon, Toledo Octavia, Octavia Combi, Yeti Beetle, Beetle Cabriolet, Eos, Golf Plus, Golf V, Golf VI, Golf VI Cabriolet, Jetta, Scirocco, Scirocco R
<b>0 986 473 382</b>	<b>0 986 474 382</b>	57,15	TOYOTA	Carina E Liftback, Carina E Sedan, Carina E Wagon
<b>0 986 473 383</b>	<b>0 986 474 383</b>	38,1	NISSAN	Primera Wagon
<b>0 986 473 384</b>	<b>0 986 474 384</b>	53,94	AUDI SEAT SKODA VW (VOLKSWAGEN)	A1, A1 Sportback, A3, A3 Cabriolet, A3 Sportback, S1, S1 Sportback, TT Coupé, TT Roadster Altea, Altea Freetrack, Altea XL, Ibiza, Ibiza SC, Ibiza ST, Leon, Toledo Fabia, Fabia Combi, Fabia RS, Octavia, Octavia Combi, Praktik, Rapid, Rapid Spaceback, Roomster, Superb, Superb Combi, Yeti Beetle, Beetle Cabriolet, Caddy, Caddy Panel Van, CC, Eos, Golf I Bakkie, Golf Plus, Golf V, Golf V Variant, Golf VI, Golf VI Cabriolet, Golf VI Variant, Jetta, Jetta V, Passat, Passat Alltrack, Passat CC, Passat Variant, Polo, Scirocco, Scirocco R, Touran, Touvan

nl

**Schijfremzadels**  
(vervolg)

sv

**Skivbromsok**  
(fortsättning)

pt





**Pinça do travão  
de disco**  
(continuação)

cs

**Třmeny  
kotoučových brzd**  
(pokračování)

ru

**Суппорты дисковых  
тормозных  
механизмов**  
(продолжение)

						
0 986 473 385	0 986 474 385	56,95	FORD	C-MAX, Focus, Focus C-MAX, Focus ECO IV, Focus II, Focus II Cabriolet, Focus II Turnier, Focus III, Focus III Turnier, Focus IV, Focus IV Turnier, Focus Sedan, Focus Turnier, Kuga, Tourneo Connect, Transit Connect		
			MAZDA	3, 3 Hatchback, 5		
			VOLVO	C30, C70 II Cabrio, S40 II, V40 Cross Country, V40 II, V50		
0 986 473 391	0 986 474 391	60,21	mitsubishi	Eclipse, Galant, Galant Hatchback, Galant Station Wagon		
0 986 473 396	0 986 474 396	60,21	mitsubishi	Eclipse, Space Wagon		
0 986 473 399	0 986 473 399	51	suzuki	Samurai, Samurai Cabrio		
0 986 473 400	0 986 474 400	44,33	toyota	Previa		
0 986 473 402	0 986 474 402	42,78	toyota	Previa, Tarago		
0 986 473 405	0 986 474 405	33,85	kia	Clarus, Clarus Kombi		
0 986 473 410	0 986 474 410	53,95	citroen	Xsara, Xsara Break, Xsara Coupé		
			peugeot	206, 206 CC, 306, 306 Break, 306 Cabriolet		
0 986 473 411	0 986 474 411	56,95	peugeot	605		
0 986 473 412	0 986 474 412	38	renault	Clio III, Grand Scenic II, Megane II Hatchback		
0 986 473 413	0 986 474 413	38	renault	Grand Scenic II		
0 986 473 414	0 986 474 414	34	mini (bmw)	Cooper, Cooper Cabrio, Cooper One, Cooper One Cabrio, Cooper S, John Cooper Works, John Cooper Works Cabrio		
			0 986 473 415	0 986 474 415	48	mini (bmw)
0 986 473 416	0 986 474 416		mercedes-benz	Serie A, Serie B		
0 986 473 418	0 986 474 418	36	ford	Tourneo Connect, Transit Connect		
0 986 473 420	0 986 474 420	54	nissan	Micra, Micra CC, Note		
0 986 473 421	0 986 474 421	38	citroen	C2, C3, C3-Pluriel		
			peugeot	207, 207 CC, 207 SW, 208, 2008		
0 986 473 422	0 986 474 422	57	renault	Alpine, Laguna II, Laguna II Grandtour		
0 986 473 424	0 986 474 424	45	vauxhall	Vivaro		
0 986 473 429	0 986 474 429	48	fiat	Panda		
0 986 473 433	0 986 474 433	57	mercedes-benz	Serie A		
0 986 473 437	0 986 474 437	44	volvo	XC90 I		
0 986 473 442	0 986 474 442	38	audi	80, 80 Avant		
0 986 473 443	0 986 474 443	42	bmw	Serie 5, Serie 6, Serie 6 Cabrio		
0 986 473 445	0 986 474 445	54	honda	Civic CRX, Civic Hatchback, Civic Sedan, Logo		
0 986 473 448	0 986 474 448	41	audi	A3, A3 Sportback, TT Coupé, TT Roadster		
			seat	Altea, Altea Freetrack, Altea XL, Toledo		
			skoda	Octavia, Octavia Combi, Superb, Superb Combi, Yeti		
			vw (volkswagen)	Eos, Golf Plus, Golf V, Golf V Variant, Golf VI, Golf VI Variant, Jetta, Jetta V, Scirocco, Touran		
0 986 473 450	0 986 474 450	48	chevrolet	Matiz, Spark		
			daewoo	Matiz		
0 986 473 451	0 986 474 451	57	citroen	C4, C4 Coupé		
			peugeot	207, 207 SW, 307, 307 Break/SW, 307 CC, 308, 308 SW		
0 986 473 452	0 986 474 452	54	citroen	C5		
0 986 473 454	0 986 474 454	60	hyundai	Grace, H 100		
0 986 473 455	0 986 474 455	38	vw (volkswagen)	Passat, Passat Variant		
0 986 473 462	0 986 474 462	48	opel	Corsa		
			vauxhall	Nova		
0 986 473 463	0 986 474 463	48	opel	Corsa		
			vauxhall	Nova		

de

**Scheibenbrems-  
sättel**  
(Fortsetzung)

en

**Disc-brake  
calipers**  
(continued)

fr

**Etriers de freins  
à disques**  
(suite)

it

**Pinze freno  
a disco**  
(seguito)

es

**Pinzas de freno  
de disco**  
(continuación)



<b>0 986 473 464</b>	<b>0 986 474 464</b>	52	OPEL VAUXHALL	Corsa Nova
<b>0 986 473 468</b>	<b>0 986 474 468</b>	40	VOLVO	740, 940
<b>0 986 473 470</b>	<b>0 986 474 470</b>	40	BMW	Serie Z, Serie 3, Serie 3 Compact, Serie 3 Coupé
<b>0 986 473 471</b>	<b>0 986 474 471</b>	33,9	RENAULT	Megane I Grandtour, Scenic I
<b>0 986 473 472</b>	<b>0 986 474 472</b>	57	PEUGEOT	407, 407 SW
<b>0 986 473 474</b>	<b>0 986 474 474</b>	36	OPEL VAUXHALL	Astra, Astra Cabrio, Astra Caravan, Astra GTC, Astra TwinTop, Meriva Astra, Astra Convertible, Astra Estate, Astra GTC, Astra TwinTop, Meriva
<b>0 986 473 478</b>	<b>0 986 474 478</b>	32	TOYOTA	RAV4
<b>0 986 473 480</b>	<b>0 986 474 480</b>	41	OPEL RENAULT VAUXHALL	Vivaro Trafic II Vivaro
<b>0 986 473 485</b>	<b>0 986 474 485</b>	57	NISSAN	Almera Tino, Primera, Primera Hatchback, Primera Wagon
<b>0 986 473 487</b>	<b>0 986 474 487</b>	54	ALFA ROMEO FIAT OPEL VAUXHALL	MiTo Doblo, Doblo Cargo, Fiorino, Grande Punto, Linea, Panda, Punto, Punto Evo, Punto Grande, Qubo, 500, 500C Adam, Corsa Adam, Corsa
<b>0 986 473 488</b>	<b>0 986 474 488</b>	44	NISSAN	X-Trail
<b>0 986 473 489</b>	<b>0 986 474 489</b>	30	TOYOTA	Conquest, Corolla, Corolla Hatchback, Corolla Liftback, Corolla Sedan, Corolla Station Wagon, Corolla Wagon
<b>0 986 473 490</b>	<b>0 986 474 490</b>	57	MERCEDES-BENZ	Serie C, Serie C (Sportcoupe), Serie C (T-Modell), Serie CLC, Serie CLK (Cabrio), Serie CLK (Coupé), Serie SLK
<b>0 986 473 494</b>	<b>0 986 474 494</b>	43	HYUNDAI	H-1, Satellite, Starex
<b>0 986 473 495</b>	<b>0 986 474 495</b>	38	RENAULT	Avantime, Espace III
<b>0 986 473 496</b>	<b>0 986 474 496</b>	57	ALFA ROMEO LANCIA	166 Kappa Berlina, Kappa Coupé, Kappa Station Wagon
<b>0 986 473 505</b>	<b>0 986 474 505</b>	57	CITROEN PEUGEOT	Xsara, Xsara Break, Xsara Coupé, ZX 306
<b>0 986 473 506</b>	<b>0 986 474 506</b>	48	CHEVROLET DAEWOO	Matiz, Spark Matiz
<b>0 986 473 507</b>	<b>0 986 474 507</b>	43	MITSUBISHI	L 400, Space Gear
<b>0 986 473 508</b>	<b>0 986 474 508</b>	38	HONDA	Accord Tourer, CR-V, Legend, Legend Coupé, Shuttle
<b>0 986 473 510</b>	<b>0 986 474 510</b>	57	SUZUKI	Grand Vitara
<b>0 986 473 523</b>	<b>0 986 474 523</b>	43	AUDI	A8, S8
<b>0 986 473 524</b>	<b>0 986 474 524</b>	57	MERCEDES-BENZ	Serie C, Serie C (T-Modell)
<b>0 986 473 655</b>	<b>0 986 474 655</b>	54	MERCEDES-BENZ	Serie 190
<b>0 986 473 656</b>	<b>0 986 474 656</b>	54	MERCEDES-BENZ	Serie E, Serie E (T-Modell)
<b>0 986 473 662</b>	<b>0 986 474 662</b>	48	BMW	Serie 3 Touring
<b>0 986 473 663</b>	<b>0 986 474 663</b>	48	VW (VOLKSWAGEN)	Jetta, Jetta I, Polo Coupé
<b>0 986 473 665</b>	<b>0 986 474 665</b>	54	RENAULT	Espace II, 21
<b>0 986 473 666</b>	<b>0 986 474 666</b>	38	PEUGEOT	405, 405 Break
<b>0 986 473 669</b>	<b>0 986 474 669</b>	54	SEAT VW (VOLKSWAGEN)	Cordoba, Cordoba Vario, Ibiza, Inca, Toledo Caddy, Corrado, Golf Cabriolet, Golf III, Golf III Cabriolet, Golf III Variant, Golf IV Cabriolet, Jetta, Passat, Passat Variant, Polo Classic, Polo Playa, Polo Variant, Vento

nl

**Schijfremzadels**  
(vervolg)

sv

**Skivbromsok**  
(fortsättning)

pt





**Pinça do travão  
de disco**  
(continuação)

cs

**Třmeny  
kotoučových brzd**  
(pokračování)

ru

**Суппорты дисковых  
тормозных  
механизмов**  
(продолжение)

						
<b>0 986 473 671</b>	<b>0 986 474 671</b>	48			DACIA	Logan, Sandero
					RENAULT	Clio I, Clio II, Express, Extra, Rapid, Logan, Megane I, Megane I Classic, Sandero, Thalia, Twingo I, 5, 9, 11, 19
<b>0 986 473 672</b>	<b>0 986 474 672</b>	48			CITROEN	C 15
					PEUGEOT	205, 205 Pickup
<b>0 986 473 673</b>	<b>0 986 474 673</b>	38			PEUGEOT	405, 405 Break
					SEAT	Ibiza, Toledo
<b>0 986 473 677</b>	<b>0 986 474 677</b>	48			CITROEN	ZX
					DACIA	Logan, Logan MCV, Sandero
					PEUGEOT	205
					RENAULT	Clio I, Clio II, Logan, Logan MCV, Megane I, Megane I Cabrio, Megane I Classic, Megane I Coupé, Megane I Grandtour, Sandero, Scenic I, Thalia, Twingo I, Twingo II, 5, 19, 19 Cabrio, 21, 21 Nevada
<b>0 986 473 678</b>	<b>0 986 474 678</b>	54			MERCEDES-BENZ	Serie E, Serie E (Cabrio), Serie E (Coupé), Serie E (T-Modell)
<b>0 986 473 680</b>	<b>0 986 474 680</b>	54			MERCEDES-BENZ	Serie C
<b>0 986 473 681</b>	<b>0 986 474 681</b>	54			MERCEDES-BENZ	Serie C
<b>0 986 473 687</b>	<b>0 986 474 687</b>	54			SEAT	Cordoba, Cordoba Vario, Ibiza, Toledo
					VW (VOLKSWAGEN)	Corrado, Golf III, Golf III Variant, Jetta, Passat, Passat Variant, Vento
<b>0 986 473 691</b>	<b>0 986 474 691</b>	54			PEUGEOT	405, 405 Break
<b>0 986 473 695</b>	<b>0 986 474 695</b>	38			AUDI	A6, A6 Avant, Cabriolet, Coupé, 100, 100 Avant
<b>0 986 473 698</b>	<b>0 986 474 698</b>	38			AUDI	A8, Coupé, 100
<b>0 986 473 748</b>	<b>0 986 473 749</b>	40			MERCEDES-BENZ	Serie CL (Coupé), Serie E, Serie S, Serie S (Coupé), Serie SL
<b>0 986 473 776</b>	<b>0 986 473 777</b>	38			CITROEN	C 25
					FIAT	Ducato 10, Ducato 12, Ducato 14, Ducato 18, Talento
<b>0 986 473 784</b>	<b>0 986 473 785</b>	60			RENAULT	Espace II
<b>0 986 473 786</b>	<b>0 986 473 787</b>	54			RENAULT	Espace III, Laguna I, Laguna I Grandtour, Megane I, Megane I Cabrio, Megane I Coupé, Safrane, Scenic I
<b>0 986 473 788</b>	<b>0 986 473 789</b>	60			RENAULT	Espace III, Laguna I, Laguna I Grandtour, Megane I Cabrio, Megane I Coupé, Safrane
<b>0 986 473 790</b>	<b>0 986 473 791</b>	48			RENAULT	Laguna I
<b>0 986 473 800</b>	<b>0 986 473 801</b>	57			VOLVO	S90, V90, 940, 960
<b>0 986 473 806</b>	<b>0 986 473 807</b>	54			VW (VOLKSWAGEN)	California T4, Caravelle T4, Eurovan, Kombi, Multivan T4, Transporter T4
<b>0 986 473 808</b>	<b>0 986 473 809</b>	54			AUDI	80, 80 Avant
<b>0 986 473 810</b>	<b>0 986 473 811</b>				AUDI	A4, A4 Avant
<b>0 986 473 816</b>	<b>0 986 473 817</b>	54			MERCEDES-BENZ	Serie C, Serie C (T-Modell)
<b>0 986 473 818</b>	<b>0 986 473 819</b>	54			MERCEDES-BENZ	Serie C
<b>0 986 473 820</b>	<b>0 986 473 821</b>	57			OPEL	Omega
					VAUXHALL	Carlton III, Omega
<b>0 986 473 846</b>	<b>0 986 473 847</b>	38			FORD	Galaxy
					SEAT	Alhambra
					VW (VOLKSWAGEN)	Sharan
<b>0 986 473 854</b>	<b>0 986 473 855</b>	38			AUDI	80, 80 Avant
<b>0 986 473 856</b>	<b>0 986 473 857</b>	38			AUDI	A4, A4 Avant
<b>0 986 473 869</b>	<b>0 986 473 870</b>	33			PEUGEOT	605
<b>0 986 473 873</b>	<b>0 986 473 874</b>	33			SAAB (SAAB AUTOMOBILE AB)	9000, 9000 Griffin
<b>0 986 473 877</b>	<b>0 986 473 878</b>	35			BMW	Serie 3 Touring
<b>0 986 473 881</b>	<b>0 986 473 882</b>	38			BMW	Serie 5, Serie 7
<b>0 986 473 885</b>	<b>0 986 473 886</b>	45			CITROEN	AX, Saxo
					PEUGEOT	106



de

**Scheibenbrems-  
sättel**  
(Fortsetzung)

en

**Disc-brake  
calipers**  
(continued)

fr

**Etriers de freins  
à disques**  
(suite)

it

**Pinze freno  
a disco**  
(seguito)

es

**Pinzas de freno  
de disco**  
(continuación)



<b>0 986 473 887</b>	<b>0 986 473 888</b>	48	CITROEN PEUGEOT	Saxo, Xsara, Xsara Break, Xsara Coupé 106, 205, 306, 306 Break, 306 Cabriolet
<b>0 986 473 889</b>	<b>0 986 473 890</b>	48	OPEL VAUXHALL	Vectra Cavalier III
<b>0 986 473 895</b>	<b>0 986 473 896</b>	48	OPEL VAUXHALL	Astra, Astra Cabrio, Astra Caravan, Astra Classic, Astra Classic Caravan, Corsa Corsa, Nova
<b>0 986 473 897</b>	<b>0 986 473 898</b>	48	FORD MAZDA	Fiesta, Fiesta III, Fiesta IV, Ka 121
<b>0 986 473 899</b>	<b>0 986 473 900</b>	48	DAEWOO OPEL VAUXHALL	Nexia, Nexia Hatchback Astra, Astra Cabrio, Astra Caravan, Astra Classic, Astra Classic Caravan, Combo, Corsa, Vectra Cavalier III, Combo, Corsa, Nova
<b>0 986 473 901</b>	<b>0 986 473 902</b>	48	DAEWOO OPEL VAUXHALL	Nexia, Nexia Hatchback Astra, Astra Cabrio, Astra Caravan, Astra Classic, Astra Classic Caravan, Combo, Corsa, Vectra Cavalier III, Combo, Corsa, Nova, Tigra
<b>0 986 473 905</b>	<b>0 986 473 906</b>	52	CHEVROLET DAEWOO OPEL VAUXHALL	Lanos Espero, Lanos, Lanos Hatchback, Nexia, Nexia Hatchback Astra, Astra Cabrio, Astra Caravan, Astra Classic, Astra Classic Caravan, Calibra, Vectra, Vectra Caravan Astra, Calibra, Cavalier III, Vectra, Vectra Estate
<b>0 986 473 909</b>	<b>0 986 473 910</b>	54	FORD MAZDA	Fiesta, Fiesta III, Fiesta III Courier, Fiesta IV, Fiesta IV Courier, Puma 121
<b>0 986 473 913</b>	<b>0 986 473 914</b>	54	OPEL VAUXHALL	Calibra, Omega, Vectra Calibra, Carlton III, Cavalier III
<b>0 986 473 917</b>	<b>0 986 473 918</b>	54	BMW	Serie Z, Serie Z Coupé, Serie 3, Serie 3 Cabrio, Serie 3 Compact, Serie 3 Coupé, Serie 3 Touring
<b>0 986 473 919</b>	<b>0 986 473 920</b>	54	BMW	Serie Z, Serie 3, Serie 3 Cabrio, Serie 3 Compact, Serie 3 Coupé, Serie 3 Touring
<b>0 986 473 923</b>	<b>0 986 473 924</b>	54	AUDI SEAT SKODA VW (VOLKSWAGEN)	A3, S3, TT Coupé, TT Roadster Ibiza, Leon, Leon Cupra, Toledo Octavia, Octavia Combi Bora, Bora Variant, Golf, Golf III, Golf III Variant, Golf IV, Golf IV Station Wagon, Golf IV Variant, Jetta, Jetta IV, New Beetle, New Beetle Cabriolet, Passat, Passat Variant, Polo
<b>0 986 473 929</b>	<b>0 986 473 930</b>	57	AUDI	A6, A6 Avant, 100, 100 Avant
<b>0 986 473 937</b>	<b>0 986 473 938</b>	60	BMW	Serie 5, Serie 5 Touring, Serie 7
<b>0 986 473 939</b>	<b>0 986 473 940</b>	60	BMW	Serie 5, Serie 5 Touring, Serie 7
<b>0 986 473 943</b>	<b>0 986 473 944</b>	33	OPEL VAUXHALL	Calibra, Vectra Calibra, Cavalier III
<b>0 986 473 945</b>	<b>0 986 473 946</b>	35	OPEL VAUXHALL	Omega Carlton III
<b>0 986 473 947</b>	<b>0 986 473 948</b>	35	OPEL SAAB (SAAB AUTOMOBILE AB) VAUXHALL	Astra, Astra Cabrio, Astra Caravan, Astra Classic Caravan, Calibra, Omega, Vectra 900 I Cabriolet, 900 I Hatchback, 900 II, 900 II Cabriolet, 900 II Coupé Astra, Calibra, Carlton III, Cavalier III
<b>0 986 473 949</b>	<b>0 986 473 950</b>	35	OPEL VAUXHALL	Calibra, Omega Calibra, Carlton III

nl

Schijfremzadels  
(vervolg)

sv

Skivbromsok  
(fortsättning)

pt

Pinça do travão  
de disco  
(continuação)

cs

Třmeny  
kotoučových brzd  
(pokračování)

ru

Суппорты дисковых  
тормозных  
механизмов  
(продолжение)

0 986 473 951	0 986 473 952	35	MERCEDES-BENZ	Serie C, Serie E, Serie E (Coupé), Serie E (T-Modell), Serie 190
0 986 473 957	0 986 473 958	38	OPEL VAUXHALL	Omega Carlton III
0 986 473 963	0 986 473 964	38	MERCEDES-BENZ	Serie C, Serie C (T-Modell), Serie E, Serie E (Cabrio), Serie E (Coupé), Serie E (T-Modell), Serie SL, Serie SLK
0 986 473 967	0 986 473 968	40	MERCEDES-BENZ	Serie E, Serie E (T-Modell), Serie S
0 986 473 971	0 986 473 972	42	MERCEDES-BENZ	Serie E, Serie E (T-Modell)
0 986 473 979	0 986 473 980	44	MERCEDES-BENZ	Serie G
0 986 473 981	0 986 473 982	44	MERCEDES-BENZ	Serie G, 2t, 3t
0 986 473 983	0 986 474 983	32	CITROEN PEUGEOT	Xsara, Xsara Break, Xsara Coupé, ZX 206, 306, 306 Break, 306 Cabriolet
0 986 473 984	0 986 474 984	45	CITROEN FIAT PEUGEOT	Jumper Ducato 18 Boxer
0 986 473 985	0 986 474 985	48	CITROEN FIAT PEUGEOT	Jumper Ducato 10, Ducato 14 Boxer
0 986 473 987	0 986 474 987	40	CITROEN FIAT PEUGEOT	Jumper Ducato 10, Ducato 14 Boxer
0 986 473 990	0 986 474 990	57	BMW MG ROVER	Serie X, Serie Z, Serie Z Coupé, Serie 3, Serie 3 Cabrio, Serie 3 Coupé, Serie 3 Tourer ZT, ZT-Tourer 75, 75 Tourer
0 986 473 991	0 986 474 991	54	OPEL VAUXHALL	Combo, Corsa, Meriva, Tigra TwinTop Combo, Corsa, Meriva, Tigra TwinTop
0 986 473 992	0 986 474 992	38	OPEL SAAB (SAAB AUTOMOBILE AB) VAUXHALL	Vectra 9-3, 9-3 Cabriolet, 9-3 Kombi, 9-3X Vectra
0 986 473 993	0 986 474 993	38	TOYOTA	Avensis, Avensis Liftback, Avensis Wagon
0 986 473 994	0 986 474 994	34	HONDA	Civic, Civic Coupé, Civic Hatchback, Civic Hybrid
0 986 473 995	0 986 474 995	44	CITROEN FIAT PEUGEOT	Jumper Ducato, Ducato Cargo, Ducato Minibus, Ducato 11, Ducato 15 Boxer, 205, 205 Pickup
0 986 473 996	0 986 474 996	46	CITROEN PEUGEOT	Jumper Boxer
0 986 473 997	0 986 474 997	54	FIAT	Bravo, Stilo, Stilo Multi Wagon
<b>0 986 474 ...</b>				
0 986 474 066	0 986 473 066	53,8	DAIHATSU	Feroza
0 986 474 076	0 986 474 076	29,94	CITROEN	BX
0 986 474 189	0 986 474 189	40	VOLVO	S70, S70 R, V70 I, 850, 850 Kombi, 960
0 986 474 206	0 986 474 206	36	CITROEN	Xantia Break
0 986 474 208	0 986 473 208	43	AUDI	S4, S4 Avant, S6, S6 Avant, V8
0 986 474 399	0 986 474 399	51	SUZUKI	Samurai, Samurai Cabrio
0 986 474 445	0 986 473 445	54	HONDA	Civic CRX
0 986 474 487	0 986 473 487	54	OPEL VAUXHALL	Corsa Corsa
0 986 474 698	0 986 473 698	38	AUDI	A6, A6 Avant, 100, 100 Avant
0 986 474 712	0 986 473 712	54	AUDI	Cabriolet, Coupé, 80, 80 Avant

de

**Scheibenbrems-  
sättel**  
(Fortsetzung)

en

**Disc-brake  
calipers**  
(continued)

fr

**Etriers de freins  
à disques**  
(suite)

it

**Pinze freno  
a disco**  
(seguito)



es



**Pinzas de freno  
de disco**  
(continuación)



<b>0 986 474 762</b>	<b>0 986 474 763</b>	40	VOLVO	740, 940, 960
<b>0 986 474 770</b>	<b>0 986 474 771</b>	48	ROVER	100 Metro, 100 Metro Cabrio
<b>0 986 474 772</b>	<b>0 986 474 773</b>	48	MG	MG TF, MGF
			ROVER	100 Metro, 100 Metro Cabrio
<b>0 986 474 776</b>	<b>0 986 474 777</b>	54	ROVER	Serie 200, Serie 400, Serie 400 Tourer
<b>0 986 474 778</b>	<b>0 986 474 779</b>	54	HONDA	Civic Aerodeck, Civic Fastback, Concerto Hatchback, Concerto Sedan
			MG	ZS
			ROVER	Serie 200, Serie 400, Serie 400 Coupé, Serie 400 Tourer, 25, 45
<b>0 986 474 780</b>	<b>0 986 474 781</b>	30,2	HONDA	Civic Aerodeck, Civic Fastback, Concerto Hatchback, Concerto Sedan
			MG	ZS
			ROVER	Serie 200, Serie 400, Serie 400 Coupé, Serie 400 Tourer, 25, 45
<b>0 986 474 784</b>	<b>0 986 474 785</b>	57,15	ROVER	Serie 600
<b>0 986 474 787</b>	<b>0 986 474 786</b>	34	HONDA	Accord Aerodeck, Accord Coupé, Accord Sedan
			ROVER	Serie 600
<b>0 986 474 788</b>	<b>0 986 474 789</b>	57	ROVER	Serie 800
<b>0 986 474 790</b>	<b>0 986 474 791</b>	38	ROVER	Serie 800
<b>0 986 474 792</b>	<b>0 986 474 793</b>	57	ROVER	Serie 800
<b>0 986 474 814</b>	<b>0 986 474 815</b>	30,2	MITSUBISHI	Lancer Hatchback
<b>0 986 474 830</b>	<b>0 986 474 831</b>	38	AUDI	A4, A4 Avant, A6, A6 Avant
			SKODA	Superb
			VW (VOLKSWAGEN)	Passat, Passat Variant
<b>0 986 474 841</b>	<b>0 986 474 842</b>	38	AUDI	A4, A4 Avant
<b>0 986 474 853</b>	<b>0 986 474 854</b>	33	VOLVO	440, 460, 480
<b>0 986 474 860</b>	<b>0 986 474 861</b>	60	OPEL	Omega
			VAUXHALL	Carlton III
<b>0 986 474 862</b>	<b>0 986 474 863</b>	60	BMW	Serie 5, Serie 5 Touring
<b>0 986 474 875</b>	<b>0 986 474 876</b>	38	SEAT	Cordoba, Ibiza, Toledo
			VW (VOLKSWAGEN)	Corrado, Golf III, Golf III Cabriolet, Golf III Variant, Golf IV Cabriolet, Passat, Passat Variant, Polo, Vento
<b>0 986 474 877</b>	<b>0 986 474 878</b>	57	VOLVO	C70 Coupé, C70 I Cabrio, S70, S70 R, V70 I, 850, 850 Kombi
<b>0 986 474 880</b>	<b>0 986 474 879</b>	54	VW (VOLKSWAGEN)	Golf III, Golf III Cabriolet, Golf III Variant, Golf IV Cabriolet, Vento
<b>0 986 474 882</b>	<b>0 986 474 884</b>	57	AUDI	A6, A6 Avant, 100, 100 Avant
<b>0 986 474 885</b>	<b>0 986 474 886</b>	38	VOLVO	C70 Coupé, C70 I Cabrio, S70, S70 R, V70 I, 850, 850 Kombi
<b>0 986 474 897</b>	<b>0 986 474 898</b>	54	AUDI	A4, A4 Avant, A4 Cabriolet
			VW (VOLKSWAGEN)	Passat, Passat Variant
<b>0 986 474 953</b>	<b>0 986 474 954</b>	38	MERCEDES-BENZ	Serie E, Serie SL
<b>0 986 474 955</b>	<b>0 986 474 956</b>	44	MERCEDES-BENZ	4t
<b>0 986 474 988</b>	<b>0 986 473 988</b>	54	HONDA	Civic Hatchback, Civic Sedan
<b>0 986 474 999</b>	<b>0 986 473 999</b>	48	FIAT	Panda

<b>de</b>	<b>en</b>	<b>fr</b>	<b>it</b>	<b>es</b>
<b>Bremseile</b>	<b>Brake cables</b>	<b>Câbles de frein de stationnement</b>	<b>Cavi del freno di stazionamento</b>	<b>Cables de freno de mano</b>
<b>nl</b>	<b>sv</b>	<b>pt</b>	<b>cs</b>	<b>ru</b>
<b>Remkabels</b>	<b>Bromsvajrar</b>	<b>Cabos do travão</b>	<b>Brzdová lana</b>	<b>Тросы тормозного привода</b>

			
<b>0 204 080 ...</b>			
<b>0 204 080 066</b>		CITROEN	C4 Grand Picasso, C4 Picasso
<b>1 987 477 0..</b>			
<b>1 987 477 042</b>	1594	VW (VOLKSWAGEN)	Polo, Polo Classic, Polo Coupé
<b>1 987 477 043</b>	633	VW (VOLKSWAGEN)	Polo, Polo Classic, Polo Coupé
<b>1 987 477 047</b>	1060	MERCEDES-BENZ	Serie E, Serie E (Cabrio), Serie E (Coupé), Serie E (T-Modell)
<b>1 987 477 055</b>	1493	HYUNDAI	Accent, Accent Hatchback, Verna
<b>1 987 477 063</b>	1420	AUDI	100, 100 Avant
<b>1 987 477 065</b>	1725	BMW	Serie 3 Touring
<b>1 987 477 066</b>	1493	HYUNDAI	Accent, Accent Hatchback, Verna
<b>1 987 477 067</b>	1631	BMW	Serie 3, Serie 3 Cabrio, Serie 3 Coupé, Serie 3 Touring
<b>1 987 477 070</b>	1678	DAIHATSU TOYOTA	Charade Yaris
<b>1 987 477 071</b>	1755	BMW	Serie 5, Serie 5 Touring
<b>1 987 477 074</b>	1855	BMW	Serie 7
<b>1 987 477 077</b>	1651	CITROEN	BX
<b>1 987 477 079</b>	1585	CITROEN	ZX
<b>1 987 477 086</b>	2668	PEUGEOT AUTOBIANCHI FIAT LANCIA SEAT	306 Cabriolet Y 10 Panda Y 10 Marbella
<b>1 987 477 087</b>	1415	FIAT LANCIA	Tempra, Tipo Dedra Berlina, Delta
<b>1 987 477 088</b>	1375	FIAT LANCIA	Tempra, Tipo Dedra Berlina, Delta
<b>1 987 477 089</b>	1405	FIAT	Marengo, Tempra, Tempra SW, Tipo
<b>1 987 477 090</b>	1600	DAIHATSU TOYOTA	Charade Yaris
<b>1 987 477 091</b>	521	FIAT	Uno, Uno Van
<b>1 987 477 1..</b>			
<b>1 987 477 111</b>	1755	ALFA ROMEO	159 Berlina, 159 Berlina Q4, 159 Sport Wagon, 159 Sport Wagon Q4, 159 Sportwagon

			
<b>1 987 477 112</b>	1735	ALFA ROMEO	159 Berlina, 159 Berlina Q4, 159 Sport Wagon, 159 Sport Wagon Q4, 159 Sportwagon
<b>1 987 477 113</b>	3025	CITROEN FIAT PEUGEOT	Jumper Ducato 10, Ducato 14, Ducato 18 Boxer
<b>1 987 477 114</b>	1059	CITROEN FIAT PEUGEOT	Jumper Ducato, Ducato Cargo, Ducato 10, Ducato 14, Ducato 18 Boxer
<b>1 987 477 115</b>	3045	CITROEN FIAT PEUGEOT	Jumper Ducato 10, Ducato 14, Ducato 18 Boxer
<b>1 987 477 116</b>	1603	OPEL RENAULT VAUXHALL	Vivaro Trafic II Vivaro
<b>1 987 477 117</b>	1438	MERCEDES-BENZ	MB
<b>1 987 477 118</b>	1845	MERCEDES-BENZ	Sprinter, 2t, 3t
<b>1 987 477 119</b>	1845	MERCEDES-BENZ	Sprinter, 2t, 3t
<b>1 987 477 121</b>	1744	MERCEDES-BENZ	4t
<b>1 987 477 122</b>	1744	MERCEDES-BENZ	4t
<b>1 987 477 129</b>	1690	OPEL VAUXHALL	Astra, Astra Cabrio, Astra Classic Astra, Astra Convertible, Astra Estate, Astra Van
<b>1 987 477 130</b>	1498	CHEVROLET OPEL VAUXHALL	Calibra Calibra, Vectra Calibra, Cavalier III
<b>1 987 477 131</b>	822	OPEL VAUXHALL	Corsa Nova
<b>1 987 477 132</b>	1435	OPEL VAUXHALL	Corsa Nova
<b>1 987 477 133</b>	960	OPEL VAUXHALL	Corsa Nova
<b>1 987 477 134</b>	1400	OPEL VAUXHALL	Corsa Nova
<b>1 987 477 136</b>	1272	DAEWOO	Cielo, Nexia, Nexia Hatchback
<b>1 987 477 137</b>	1503	OPEL RENAULT VAUXHALL	Vivaro Trafic II Vivaro
<b>1 987 477 140</b>	750	OPEL VAUXHALL	Vectra Cavalier III
<b>1 987 477 141</b>	2079	OPEL VAUXHALL	Vectra Cavalier III
<b>1 987 477 142</b>	665	OPEL VAUXHALL	Vectra Cavalier III

de

**Bremsseile**  
(Fortsetzung)

en

**Brake cables**  
(continued)

fr

**Câbles de frein  
de stationnement**  
(suite)

it

**Cavi del freno  
di stazionamento**  
(seguito)

es

**Cables de freno  
de mano**  
(continuación)



<b>1 987 477 143</b>	2022	OPEL	Vectra	
		VAUXHALL	Cavalier III	
<b>1 987 477 144</b>	1372	PEUGEOT	205, 205 Pickup	
<b>1 987 477 145</b>	1386	PEUGEOT	205, 205 Pickup	
<b>1 987 477 147</b>	550	PEUGEOT	405, 405 Break	
<b>1 987 477 148</b>	855	PEUGEOT	405, 405 Break	
<b>1 987 477 149</b>	872	PEUGEOT	405, 405 Break	
<b>1 987 477 150</b>	558	PEUGEOT	405, 405 Break	
<b>1 987 477 152</b>	1430	RENAULT	Clio I	
<b>1 987 477 153</b>	1480	RENAULT	Clio I	
<b>1 987 477 154</b>	1891	RENAULT	Espace II	
<b>1 987 477 155</b>	1285	RENAULT	Espace II	
<b>1 987 477 156</b>	1330	RENAULT	Express, Extra, Rapid, 5	
<b>1 987 477 162</b>	1613	VW (VOLKSWAGEN)	Corrado, Golf III, Golf III Variant, Vento	
<b>1 987 477 163</b>	1774	OPEL VAUXHALL	Zafira Zafira	
<b>1 987 477 164</b>	1527	SEAT	Toledo	
<b>1 987 477 167</b>	1622	SEAT	Toledo	
<b>1 987 477 168</b>	1500	VW (VOLKSWAGEN)	Golf III, Golf III Cabriolet, Golf III Variant, Vento	
<b>1 987 477 169</b>	1628	VW (VOLKSWAGEN)	Passat	
<b>1 987 477 171</b>	844	VW (VOLKSWAGEN)	California T4, Caravelle T4, Kombi, Multivan T4, Transporter T4	
<b>1 987 477 174</b>	1547	FORD	Transit, Transit Euroline, Transit Nugget, Transit Tourneo	
<b>1 987 477 175</b>	1590	FORD	Transit	
<b>1 987 477 177</b>	1334	FORD	Transit	
<b>1 987 477 178</b>	1528	FORD	Transit	
<b>1 987 477 180</b>	1608	FORD	Transit	
<b>1 987 477 181</b>	1764	BMW	Serie 3, Serie 3 Coupé	
<b>1 987 477 185</b>	1386	FORD	Transit	
<b>1 987 477 186</b>	1052	FORD	Transit, Transit Euroline, Transit Nugget, Transit Tourneo	
<b>1 987 477 190</b>	910	FORD	Transit, Transit Euroline, Transit Nugget, Transit Tourneo	
<b>1 987 477 197</b>	2799	MERCEDES-BENZ	Viano, Vito	
<b>1 987 477 198</b>	2432	MERCEDES-BENZ	Viano, Vito	
<b>1 987 477 199</b>	1167	MERCEDES-BENZ	Serie V, Vito	
<b>1 987 477 2..</b>				
<b>1 987 477 202</b>	1876	VOLVO	S40 II, V50	
<b>1 987 477 204</b>	1625	SEAT	Cordoba, Ibiza	

<b>1 987 477 208</b>	830	MERCEDES-BENZ	2t, 3t	
<b>1 987 477 209</b>	1130	MERCEDES-BENZ	2t, 3t	
<b>1 987 477 210</b>	1480	MERCEDES-BENZ	2t, 3t	
<b>1 987 477 211</b>	1798	MERCEDES-BENZ	2t, 3t	
<b>1 987 477 215</b>	1532	SEAT	Cordoba, Ibiza	
<b>1 987 477 216</b>	1830	FORD	Focus C-MAX, Focus II, Focus II Cabriolet, Focus II Turnier	
<b>1 987 477 219</b>	960	MERCEDES-BENZ	Serie C, Serie C (T-Modell), Serie CLK (Cabrio), Serie CLK (Coupé)	
<b>1 987 477 220</b>	925	MERCEDES-BENZ	Serie C, Serie C (T-Modell), Serie CLK (Cabrio), Serie CLK (Coupé)	
<b>1 987 477 222</b>	1450	FORD	Focus II, Focus II Turnier	
<b>1 987 477 223</b>	1307	MERCEDES-BENZ	Serie B	
<b>1 987 477 224</b>	587	MERCEDES-BENZ	Serie A, Serie B	
<b>1 987 477 225</b>	1215	MERCEDES-BENZ	Serie A, Serie B	
<b>1 987 477 226</b>	236	NISSAN	Almera Sedan, Primera, Primera Hatchback, Primera Wagon, X-Trail	
<b>1 987 477 231</b>	1660	NISSAN	Primera Hatchback, Primera Sedan, Primera Wagon	
<b>1 987 477 232</b>	1602	FORD	Escort V/VI, Escort V/VI Cabrio, Escort V/VI Turnier, Escort V/VI XR3i, Escort V/VI XR3i Cabrio	
<b>1 987 477 233</b>	3930	FORD	Fiesta III, Fiesta III Courier	
<b>1 987 477 234</b>	3400	FORD	Escort V/VI Express	
<b>1 987 477 235</b>	1796	PEUGEOT	207, 207+, 207 SW	
<b>1 987 477 237</b>	1905	PEUGEOT	207, 207 CC, 207 SW	
<b>1 987 477 238</b>	1610	CITROEN	C2	
		PEUGEOT	1007	
<b>1 987 477 239</b>	1702	CITROEN	C2	
		PEUGEOT	1007	
<b>1 987 477 240</b>	276	TOYOTA	Corolla Verso	
<b>1 987 477 242</b>	1989	SKODA	Superb	
<b>1 987 477 244</b>	1989	SKODA	Superb	
<b>1 987 477 245</b>	1410	SAAB (SAAB AUTOMOBILE AB)	9-5, 9-5 Kombi	
<b>1 987 477 248</b>	2180	VOLVO	XC90, XC90 I	
<b>1 987 477 249</b>	1665	AUDI	TT Coupé, TT Roadster	
<b>1 987 477 250</b>	1550	OPEL	Omega	
		VAUXHALL	Carlton III, Omega	

nl

Remkabels  
(vervolg)

sv

Bromsvajrar  
(fortsättning)

pt



Cabos do travão  
(continuação)



cs

Brzdová lana  
(pokračování)

ru

Тросы тормозного  
привода  
(продолжение)

				
<b>1 987 477 255</b>	1617	AUDI	TT Coupé, TT Roadster	
<b>1 987 477 257</b>	1736	AUDI	A4, A4 Avant, A4 Cabriolet	
<b>1 987 477 258</b>	1398	OPEL	Astra Caravan, Astra Classic Caravan	
		VAUXHALL	Astra, Astra Convertible, Astra Estate, Astra Van	
<b>1 987 477 259</b>	1727	AUDI	A4, A4 Avant	
<b>1 987 477 260</b>	1303	VW (VOLKSWAGEN)	California T5, California T6, Caravelle T5, Caravelle T6, Multivan T5, Multivan T6, Transporter T5, Transporter T6	
<b>1 987 477 261</b>	1737	NISSAN	Interstar	
		OPEL	Movano	
		RENAULT	Master II	
		VAUXHALL	Movano	
<b>1 987 477 262</b>	2806	CITROEN	Jumper	
		FIAT	Ducato 10, Ducato 14, Ducato 18	
		PEUGEOT	Boxer	
<b>1 987 477 263</b>	2827	CITROEN	Jumper	
		FIAT	Ducato 10, Ducato 11, Ducato 14, Ducato 15, Ducato 18	
		PEUGEOT	Boxer	
<b>1 987 477 272</b>	1432	PEUGEOT	205	
<b>1 987 477 273</b>	1417	PEUGEOT	205	
<b>1 987 477 280</b>	1487	RENAULT	9, 11	
<b>1 987 477 284</b>	1511	SEAT	Cordoba, Cordoba Vario, Ibiza	
		VW (VOLKSWAGEN)	Polo, Polo Classic, Polo Playa, Polo Variant	
<b>1 987 477 289</b>	2018	FIAT	Uno, Uno Van	
<b>1 987 477 296</b>	2833	FIAT	Uno, Uno Mille	
		INNOCENTI (NUOVA INNO- CENTI)	Elba, Mille	
<b>1 987 477 3..</b>				
<b>1 987 477 301</b>	1627	FORD	Fiesta IV, Ka, Puma, Streetka	
<b>1 987 477 306</b>	2496	MERCEDES-BENZ	Serie E, Serie E (T-Modell)	
<b>1 987 477 307</b>	1035	OPEL	Corsa	
		VAUXHALL	Nova	
<b>1 987 477 308</b>	1260	OPEL	Corsa	
		VAUXHALL	Nova	

				
<b>1 987 477 309</b>	1373	CHEVROLET	Corsa Wagon	
		OPEL	Corsa, Corsa Hatchback, Tigra	
		VAUXHALL	Corsa, Tigra	
<b>1 987 477 310</b>	1078	CHEVROLET	Corsa Wagon	
		OPEL	Corsa, Corsa Hatchback, Tigra	
		VAUXHALL	Corsa, Tigra	
<b>1 987 477 311</b>	1564	RENAULT	19, 19 Cabrio	
<b>1 987 477 323</b>	1493	CITROEN	ZX	
		PEUGEOT	306 Cabriolet	
<b>1 987 477 324</b>	1044	MERCEDES-BENZ	Serie 190	
<b>1 987 477 326</b>	1416	MERCEDES-BENZ	MB	
<b>1 987 477 327</b>	1647	MERCEDES-BENZ	MB	
<b>1 987 477 331</b>	2385	FIAT	Panda	
<b>1 987 477 332</b>	1467	RENAULT	21	
<b>1 987 477 334</b>	1045	RENAULT	Espace II	
<b>1 987 477 335</b>	1984	RENAULT	Espace II	
<b>1 987 477 338</b>	1498	VW (VOLKSWAGEN)	Golf Cabriolet, Golf III, Golf III Cabriolet, Golf III Variant, Vento	
		FORD	Ka, Streetka	
<b>1 987 477 345</b>	1640	MAZDA	121	
<b>1 987 477 347</b>	830	VOLVO	740	
<b>1 987 477 349</b>	902	VOLVO	740, 940	
<b>1 987 477 353</b>	1428	VOLVO	440, 460, 480	
<b>1 987 477 354</b>	1365	VOLVO	440, 460	
<b>1 987 477 356</b>	1338	VOLVO	440, 460	
<b>1 987 477 357</b>	1670	VOLVO	S70, V70 I, 850, 850 Kombi	
		VOLVO	850, 850 Kombi	
<b>1 987 477 358</b>	1607	VOLVO	850, 850 Kombi	
<b>1 987 477 367</b>	151	FORD	Escort V/VI, Escort V/VI Cabrio, Escort V/VI Express, Escort V/VI RS, Escort V/VI Turnier, Escort V/VI XR3i, Escort V/VI XR3i Cabrio, Fiesta III, Fiesta III Courier	
		FORD	Transit, Transit Euroline, Transit Nugget, Transit Tourneo	
		FORD	Transit, Transit Euroline, Transit Nugget, Transit Tourneo	
		FORD	Transit, Transit Euroline, Transit Nugget, Transit Tourneo	
		FORD	Transit, Transit Euroline, Transit Nugget, Transit Tourneo	
		FORD	Transit, Transit Euroline, Transit Nugget, Transit Tourneo	
		FORD	Transit, Transit Euroline, Transit Nugget, Transit Tourneo	
		FORD	Transit, Transit Euroline, Transit Nugget, Transit Tourneo	
		FORD	Transit, Transit Euroline, Transit Nugget, Transit Tourneo	
		FORD	Transit, Transit Euroline, Transit Nugget, Transit Tourneo	
		FORD	Transit, Transit Euroline, Transit Nugget, Transit Tourneo	
		FORD	Transit, Transit Euroline, Transit Nugget, Transit Tourneo	

de

**Bremssseile**  
(Fortsetzung)

en

**Brake cables**  
(continued)

fr

**Câbles de frein  
de stationnement**  
(suite)

it

**Cavi del freno  
di stazionamento**  
(seguito)

es

**Cables de freno  
de mano**  
(continuación)



<b>1 987 477 375</b>	1460	ALFA ROMEO	145, 146, 155	
		FIAT	Marengo, Tempra, Tempra SW, Tipo	
		LANCIA	Dedra Berlina, Dedra Station Wagon, Delta	
<b>1 987 477 376</b>	1495	FIAT	Tempra, Tempra SW	
		LANCIA	Dedra Berlina	
<b>1 987 477 377</b>	2016	FIAT	Uno, Uno Van	
<b>1 987 477 381</b>	2988	FIAT	Cinquecento	
<b>1 987 477 382</b>	1517	ALFA ROMEO	145, 146, 155	
		FIAT	Coupé, Marengo, Tempra, Tempra SW, Tipo	
		LANCIA	Dedra Berlina, Dedra Station Wagon, Delta	
<b>1 987 477 383</b>	1469	FIAT	Punto, Punto Cabrio, Punto Van	
<b>1 987 477 384</b>	1456	FIAT	Punto, Punto Cabrio, Punto Van	
<b>1 987 477 385</b>	385	FIAT	Brava, Bravo, Marea, Marengo	
<b>1 987 477 390</b>	2950	ALFA ROMEO	164	
		FIAT	Croma	
		LANCIA	Thema Berlina, Thema Station Wagon	
<b>1 987 477 391</b>	1455	OPEL	Vectra, Vectra Caravan	
		VAUXHALL	Vectra, Vectra Estate	
<b>1 987 477 393</b>	1616	VW (VOLKSWAGEN)	Golf Cabriolet, Golf III, Golf III Cabriolet, Golf III Variant, Golf IV Cabriolet, Vento	
<b>1 987 477 394</b>	1433	NISSAN	Micra	
<b>1 987 477 397</b>	1412	NISSAN	Pulsar, Sunny Hatchback, Sunny Sedan, 100 NX	
<b>1 987 477 398</b>	1311	NISSAN	Pulsar, Pulsar Hatchback, Sunny Hatchback, Sunny Sedan, 100 NX	
<b>1 987 477 399</b>	1603	NISSAN	Primera Hatchback, Primera Sedan	
<b>1 987 477 4..</b>				
<b>1 987 477 403</b>	1412	NISSAN	Pulsar, Sunny Hatchback, Sunny Sedan, 100 NX	
<b>1 987 477 404</b>	1311	NISSAN	Pulsar, Pulsar Hatchback, Sunny Hatchback, Sunny Sedan, 100 NX	

<b>1 987 477 405</b>	1623	NISSAN	Primera Hatchback, Primera Sedan	
<b>1 987 477 406</b>	1721	VW (VOLKSWAGEN)	Passat, Passat Variant	
<b>1 987 477 407</b>	1624	VW (VOLKSWAGEN)	Passat, Passat Variant	
<b>1 987 477 409</b>	1603	TOYOTA	Corolla, Corolla Hatchback, Corolla Liftback, Corolla Sedan, Corolla Wagon	
<b>1 987 477 410</b>	1727	TOYOTA	Carina E Liftback, Carina E Sedan, Carina E Wagon, Corona	
<b>1 987 477 413</b>	1585	TOYOTA	Corolla, Corolla Hatchback, Corolla Liftback, Corolla Sedan, Corolla Wagon	
<b>1 987 477 414</b>	1780	TOYOTA	Carina E Liftback, Carina E Sedan, Carina E Wagon, Corona	
<b>1 987 477 417</b>	1608	CITROEN	C 25	
		FIAT	Ducato 10, Ducato 12, Ducato 14, Ducato 18	
<b>1 987 477 419</b>	2338	CITROEN	C 25	
		FIAT	Ducato 10, Ducato 14, Ducato 18	
<b>1 987 477 420</b>	1888	FIAT	Ducato 10, Ducato 12, Ducato 14, Ducato 18	
<b>1 987 477 421</b>	2620	FIAT	Ducato 10, Ducato 14, Ducato 18	
<b>1 987 477 422</b>	1842	PEUGEOT	405, 405 Break	
<b>1 987 477 427</b>	1292	PEUGEOT	106	
<b>1 987 477 429</b>	1656	PEUGEOT	306	
<b>1 987 477 430</b>	1561	PEUGEOT	306	
<b>1 987 477 431</b>	1696	PEUGEOT	306, 306 Break	
<b>1 987 477 432</b>	1614	PEUGEOT	306, 306 Break	
<b>1 987 477 434</b>	1692	PEUGEOT	306, 306 Break	
<b>1 987 477 435</b>	1604	PEUGEOT	306, 306 Break	
<b>1 987 477 436</b>	1621	CITROEN	ZX	
<b>1 987 477 437</b>	1621	PEUGEOT	306 Cabriolet	
<b>1 987 477 438</b>	1531	PEUGEOT	306 Cabriolet	
<b>1 987 477 439</b>	1262	CITROEN	Xantia, Xantia Break	
<b>1 987 477 440</b>	1333	CITROEN	Xantia, Xantia Break	
<b>1 987 477 441</b>	1313	CITROEN	Xantia, Xantia Break	
<b>1 987 477 442</b>	1442	CITROEN	Saxo	
		PEUGEOT	106	
<b>1 987 477 443</b>	1582	CITROEN	ZX	
<b>1 987 477 445</b>	1520	CITROEN	ZX	
<b>1 987 477 446</b>	1610	CITROEN	ZX	
<b>1 987 477 447</b>	1480	HONDA	Civic Hatchback	
<b>1 987 477 448</b>	1478	HONDA	Civic Hatchback	

nl

**Remkabels**  
(vervolg)

sv

**Bromsvajrar**  
(fortsättning)

pt



**Cabos do travão**  
(continuação)



cs

**Brzdová lana**  
(pokračování)

ru

**Тросы тормозного привода**  
(продолжение)

			
<b>1 987 477 461</b>	1469	RENAULT	Express, Extra, Rapid
<b>1 987 477 462</b>	1465	RENAULT	Express, Extra, Rapid
<b>1 987 477 469</b>	1646	RENAULT	21 Nevada
<b>1 987 477 471</b>	1564	RENAULT	19, 19 Cabrio
<b>1 987 477 472</b>	1187	RENAULT	Laguna I
<b>1 987 477 473</b>	1247	RENAULT	Laguna I, Laguna I Grandtour
<b>1 987 477 475</b>	1440	RENAULT	Megane I, Megane I Classic
<b>1 987 477 483</b>	1420	CITROEN	AX
<b>1 987 477 485</b>	1395	CITROEN	AX
<b>1 987 477 486</b>	1780	CITROEN	C 15
<b>1 987 477 488</b>	1408	CITROEN	XM
<b>1 987 477 489</b>	963	CITROEN	XM
<b>1 987 477 490</b>	1230	CITROEN	XM
<b>1 987 477 491</b>	1030	CITROEN	XM
<b>1 987 477 492</b>	1466	MAZDA	323 Hatchback, 323 Sedan
<b>1 987 477 493</b>	1503	MAZDA	323 Hatchback, 323 Sedan
<b>1 987 477 494</b>	1498	MAZDA	323 Hatchback
<b>1 987 477 495</b>	1468	MAZDA	323 Hatchback
<b>1 987 477 5..</b>			
<b>1 987 477 501</b>	1657	MAZDA	MX-6, Xedos-6, 626, 626 Hatchback
<b>1 987 477 502</b>	1657	MAZDA	MX-6, Xedos-6, 626, 626 Hatchback
<b>1 987 477 503</b>	252	MAZDA	MX-6, Premacy, 323, 323 Hatchback, 626, 626 Fastback, 626 Hatchback, 626 Wagon
<b>1 987 477 512</b>	1485	MG	ZS
		ROVER	Serie 400, Serie 400 Coupé, Serie 400 Tourer, 45
<b>1 987 477 513</b>	1510	MG	ZS
		ROVER	Serie 400, Serie 400 Coupé, Serie 400 Tourer, 45
<b>1 987 477 515</b>	2566	CITROEN	C 25
		FIAT	Ducato 10, Ducato 14, Ducato 18
<b>1 987 477 517</b>	312	FORD	Fiesta IV, Fiesta IV Courier, Ka, Puma
		MAZDA	121
<b>1 987 477 519</b>	1664	ALFA ROMEO	33 Berlina, 33 Sportwagon
<b>1 987 477 521</b>	1611	FORD	Mondeo I, Mondeo I Turnier, Mondeo II, Mondeo II Turnier

			
<b>1 987 477 522</b>	281	FORD	Escort VII, Escort VII Cabrio, Escort VII Express, Escort VII RS, Escort VII Turnier, Escort VII XR3i Cabrio
<b>1 987 477 524</b>	2205	CITROEN	Evasion
		FIAT	Ulysse
		LANCIA	Zeta
		PEUGEOT	806
<b>1 987 477 525</b>	1255	CITROEN	Evasion
		FIAT	Ulysse
		LANCIA	Zeta
		PEUGEOT	806
<b>1 987 477 527</b>	1593	OPEL	Astra, Astra Cabrio, Astra Caravan, Astra Coupé
		VAUXHALL	Astra, Astra Convertible, Astra Coupé, Astra Estate, Astra Van
<b>1 987 477 528</b>	1680	OPEL	Zafira
		VAUXHALL	Zafira
<b>1 987 477 529</b>	1106	OPEL	Corsa
		VAUXHALL	Corsa
<b>1 987 477 530</b>	1590	VOLVO	S40 I, V40 I
<b>1 987 477 531</b>	1708	BMW	Serie 3, Serie 3 Cabrio, Serie 3 Compact, Serie 3 Coupé, Serie 3 Touring
<b>1 987 477 532</b>	1693	BMW	Serie 3, Serie 3 Cabrio, Serie 3 Compact, Serie 3 Coupé, Serie 3 Touring
<b>1 987 477 533</b>	1265	BMW	Serie 7
<b>1 987 477 534</b>	250	NISSAN	Almera Hatchback, Almera Sedan, Altima, Bluebird, Micra, Pulsar, Sunny
<b>1 987 477 535</b>	1662	NISSAN	Almera Hatchback, Almera Sedan, Pulsar, Pulsar Hatchback, Pulsar Sedan, Sunny
<b>1 987 477 536</b>	1677	NISSAN	Almera Hatchback, Almera Sedan, Pulsar, Sunny
<b>1 987 477 537</b>	1660	NISSAN	Almera Hatchback, Almera Sedan, Pulsar, Pulsar Hatchback, Pulsar Sedan, Sunny



de

**Bremsseile**  
(Fortsetzung)

en

**Brake cables**  
(continued)

fr

**Câbles de frein  
de stationnement**  
(suite)

it

**Cavi del freno  
di stazionamento**  
(seguito)

es

**Cables de freno  
de mano**  
(continuación)



<b>1 987 477 538</b>	1676	NISSAN	Almera Hatchback, Almera Sedan, Pulsar, Sunny	
<b>1 987 477 539</b>	330	TOYOTA	Avensis, Avensis Liftback, Avensis Wagon	
<b>1 987 477 540</b>	1789	TOYOTA	Avensis, Avensis Liftback, Avensis Wagon	
<b>1 987 477 541</b>	1760	TOYOTA	Avensis, Avensis Liftback, Avensis Wagon	
<b>1 987 477 542</b>	1335	TOYOTA	RAV4, RAV4 Cabrio	
<b>1 987 477 543</b>	1503	TOYOTA	Echo, Ist, Yaris	
<b>1 987 477 544</b>	1623	TOYOTA	Yaris Verso	
<b>1 987 477 545</b>	1829	TOYOTA	Avensis, Avensis Liftback, Avensis Wagon	
<b>1 987 477 546</b>	1805	TOYOTA	Avensis, Avensis Liftback, Avensis Wagon	
<b>1 987 477 547</b>	1345	TOYOTA	RAV4, RAV4 Cabrio	
<b>1 987 477 548</b>	1548	TOYOTA	Echo, Ist, Yaris	
<b>1 987 477 549</b>	1686	TOYOTA	Yaris Verso	
<b>1 987 477 550</b>	1515	FIAT	Palio Weekend	
<b>1 987 477 551</b>	1465	FIAT	Palio Weekend	
<b>1 987 477 552</b>	1428	ALFA ROMEO	146	
		FIAT	Brava, Bravo, Marea	
<b>1 987 477 553</b>	2670	FIAT	Cinquecento, Seicento	
<b>1 987 477 554</b>	1170	ALFA ROMEO	147	
<b>1 987 477 555</b>	1222	LANCIA	Lybra Berlina, Lybra Station Wagon	
<b>1 987 477 556</b>	1266	LANCIA	Lybra Berlina, Lybra Station Wagon	
<b>1 987 477 557</b>	2014	FIAT	Multipla	
<b>1 987 477 558</b>	1211	FIAT	Multipla	
<b>1 987 477 559</b>	2266	FIAT	Multipla	
<b>1 987 477 561</b>	1456	FIAT	Punto, Punto Van	
<b>1 987 477 562</b>	1165	FIAT	Multipla	
<b>1 987 477 565</b>	500	CITROEN	C8, Evasion, Jumpy	
		FIAT	Scudo, Ulysse	
		PEUGEOT	Expert, 806, 807	
<b>1 987 477 566</b>	743	PEUGEOT	605	
<b>1 987 477 567</b>	635	PEUGEOT	605	
<b>1 987 477 568</b>	1063	CITROEN	Evasion, Jumpy	
		PEUGEOT	Expert, 806	
<b>1 987 477 569</b>	2286	CITROEN	Evasion, Jumpy	
		FIAT	Scudo, Ulysse	
		LANCIA	Zeta	
		PEUGEOT	Expert, 806	
<b>1 987 477 571</b>	750	PEUGEOT	406, 406 Break	
<b>1 987 477 572</b>	695	PEUGEOT	406, 406 Break	
<b>1 987 477 573</b>	642	PEUGEOT	406, 406 Break	
<b>1 987 477 574</b>	1505	CITROEN	Saxo	

<b>1 987 477 575</b>	1700	PEUGEOT	406, 406 Break, 406 Coupé	
<b>1 987 477 576</b>	1745	CITROEN	Berlingo	
		PEUGEOT	Partner, Ranch	
<b>1 987 477 577</b>	1818	CITROEN	Berlingo	
		PEUGEOT	Partner, Ranch	
<b>1 987 477 578</b>	706	PEUGEOT	406 Coupé	
<b>1 987 477 579</b>	652	PEUGEOT	406 Coupé	
<b>1 987 477 580</b>	1591	CITROEN	Xsara, Xsara Coupé	
<b>1 987 477 581</b>	1500	CITROEN	Xsara, Xsara Coupé	
<b>1 987 477 582</b>	1635	CITROEN	Xsara, Xsara Break, Xsara Coupé	
<b>1 987 477 583</b>	1545	CITROEN	Xsara, Xsara Break, Xsara Coupé	
<b>1 987 477 584</b>	1610	CITROEN	Xsara Break	
<b>1 987 477 585</b>	1520	CITROEN	Xsara Break	
<b>1 987 477 586</b>	1638	PEUGEOT	206, 206+, 206 CC, 206 Sedan, 206 SW	
<b>1 987 477 587</b>	1707	PEUGEOT	206, 206 CC, 206 SW	
<b>1 987 477 590</b>	1773	CITROEN	Picasso, Xsara Picasso	
<b>1 987 477 591</b>	1864	CITROEN	Picasso, Xsara Picasso	
<b>1 987 477 592</b>	2145	PEUGEOT	607	
<b>1 987 477 593</b>	724	PEUGEOT	607	
<b>1 987 477 594</b>	713	PEUGEOT	607	
<b>1 987 477 595</b>	1850	CITROEN	Berlingo	
		PEUGEOT	Partner, Ranch	
<b>1 987 477 598</b>	2035	CITROEN	C4, C4 Coupé	
		PEUGEOT	307, 307 CC	
<b>1 987 477 599</b>	1716	CITROEN	C3, C3-Pluriel	
<b>1 987 477 6..</b>				
<b>1 987 477 600</b>	1812	CITROEN	C3, C3-Pluriel	
<b>1 987 477 602</b>	1870	HONDA	Accord Sedan	
		ROVER	Serie 600	
<b>1 987 477 603</b>	1958	AUDI	A6, A6 Avant	
<b>1 987 477 604</b>	1958	AUDI	A6, A6 Avant	
<b>1 987 477 607</b>	1572	SUZUKI	Baleno Hatchback, Baleno Sedan, Baleno Wagon	
<b>1 987 477 608</b>	1475	SUZUKI	Baleno Hatchback, Baleno Sedan, Baleno Wagon	
<b>1 987 477 609</b>	1557	SUZUKI	Baleno Hatchback, Baleno Sedan, Baleno Wagon	
<b>1 987 477 610</b>	1656	SUZUKI	Baleno Hatchback, Baleno Sedan, Baleno Wagon	
<b>1 987 477 611</b>	1504	HYUNDAI	Atos, Atos Prime, Santro	
<b>1 987 477 612</b>	1485	HYUNDAI	Accent, Accent Hatchback, Excel, Pony	

nl

Remkabels  
(vervolg)

sv

Bromsvajrar  
(fortsättning)

pt



Cabos do travão  
(continuação)



cs

Brzdová lana  
(pokračování)

ru

Тросы тормозного  
привода  
(продолжение)

			
<b>1 987 477 613</b>	1520	HYUNDAI	Atos, Atos Prime, Santro
<b>1 987 477 614</b>	1485	HYUNDAI	Accent, Accent Hatchback, Excel, Pony, Verna
<b>1 987 477 615</b>	1635	RENAULT	Espace III
<b>1 987 477 616</b>	1583	RENAULT	Espace III
<b>1 987 477 618</b>	1713	ALFA ROMEO	33 Berlina, 33 Sportwagon
<b>1 987 477 620</b>	1589	ALFA ROMEO	33 Berlina, 33 Sportwagon
<b>1 987 477 621</b>	1196	ALFA ROMEO	GT, 156 Berlina, 156 Sport Wagon, 156 Sportwagon
<b>1 987 477 622</b>	1256	ALFA ROMEO	GT, 156 Berlina, 156 Sport Wagon
<b>1 987 477 623</b>	1445	ALFA ROMEO	166
<b>1 987 477 624</b>	1427	ALFA ROMEO	166
<b>1 987 477 626</b>	1671	SEAT	Inca
		VW (VOLKSWAGEN)	Caddy
<b>1 987 477 627</b>	1641	SEAT	Cordoba, Cordoba Vario, Ibiza
		VW (VOLKSWAGEN)	Polo, Polo Classic, Polo Variant
<b>1 987 477 628</b>	1005	MERCEDES-BENZ	Serie SLK
<b>1 987 477 629</b>	994	MERCEDES-BENZ	Serie SLK
<b>1 987 477 630</b>	1293	FORD	Galaxy
		SEAT	Alhambra
		VW (VOLKSWAGEN)	Sharan
<b>1 987 477 631</b>	270	FORD	Cougar, Mondeo I, Mondeo I Turnier, Mondeo II, Mondeo II Turnier
<b>1 987 477 632</b>	1423	NISSAN	Kubistar
		RENAULT	Kangoo I
<b>1 987 477 633</b>	1421	NISSAN	Kubistar
		RENAULT	Kangoo I
<b>1 987 477 634</b>	1438	RENAULT	Kangoo I
<b>1 987 477 635</b>	1442	RENAULT	Kangoo I
<b>1 987 477 636</b>	1473	RENAULT	Megane I, Megane I Classic
<b>1 987 477 637</b>	1456	RENAULT	Megane I Grandtour
<b>1 987 477 638</b>	1183	RENAULT	Laguna I, Laguna I Grandtour
<b>1 987 477 639</b>	1476	RENAULT	Scenic I
<b>1 987 477 640</b>	1367	RENAULT	Megane I Cabrio, Megane I Coupé
<b>1 987 477 641</b>	1343	RENAULT	Clio II
<b>1 987 477 642</b>	1263	RENAULT	Clio II
<b>1 987 477 643</b>	1442	RENAULT	Twingo I
<b>1 987 477 644</b>	1355	RENAULT	Clio II

			
<b>1 987 477 645</b>	1277	RENAULT	Clio II
<b>1 987 477 646</b>	1460	RENAULT	Twingo I
<b>1 987 477 647</b>	1479	RENAULT	Scenic I
<b>1 987 477 648</b>	850	RENAULT	Safrane
<b>1 987 477 649</b>	1091	RENAULT	Safrane
<b>1 987 477 650</b>	1190	RENAULT	Laguna I Grandtour
<b>1 987 477 651</b>	2385	AUTOBIANCHI	Y 10
		FIAT	Panda
		LANCIA	Y 10
<b>1 987 477 652</b>	2220	RENAULT	Laguna II, Laguna II Grandtour
<b>1 987 477 653</b>	1480	RENAULT	Megane I Grandtour
<b>1 987 477 654</b>	1519	RENAULT	Megane I Grandtour
<b>1 987 477 655</b>	1414	LANCIA	Y
<b>1 987 477 656</b>	1392	LANCIA	Y
<b>1 987 477 657</b>	1345	LANCIA	Kappa Berlina, Kappa Coupé, Kappa Station Wagon
<b>1 987 477 658</b>	311	ALFA ROMEO	166
<b>1 987 477 659</b>	1812	AUDI	A4, A4 Avant
<b>1 987 477 660</b>	1095	OPEL	Corsa, Tigra TwinTop
		VAUXHALL	Corsa, Tigra TwinTop
<b>1 987 477 661</b>	832	OPEL	Corsa, Tigra TwinTop
		VAUXHALL	Corsa, Tigra TwinTop
<b>1 987 477 662</b>	747	OPEL	Arena
		RENAULT	Trafic
		VAUXHALL	Arena
<b>1 987 477 663</b>	1330	OPEL	Arena
		RENAULT	Trafic
		VAUXHALL	Arena
<b>1 987 477 664</b>	1295	OPEL	Arena
		RENAULT	Trafic
		VAUXHALL	Arena
<b>1 987 477 665</b>	1424	OPEL	Arena
		RENAULT	Trafic
		VAUXHALL	Arena
<b>1 987 477 666</b>	1390	OPEL	Arena
		RENAULT	Trafic
		VAUXHALL	Arena
<b>1 987 477 667</b>	330	OPEL	Corsa
		VAUXHALL	Corsa
<b>1 987 477 669</b>	1143	OPEL	Corsa
		VAUXHALL	Corsa
<b>1 987 477 670</b>	1426	OPEL	Corsa
		VAUXHALL	Corsa
<b>1 987 477 672</b>	1815	ROVER	Serie 800
<b>1 987 477 673</b>	1870	ROVER	Serie 600
<b>1 987 477 674</b>	1485	MITSUBISHI	Lancer, Lancer Hatchback
<b>1 987 477 675</b>	1490	MITSUBISHI	Lancer, Lancer Hatchback
<b>1 987 477 676</b>	1511	MITSUBISHI	Carisma, Carisma Hatchback
<b>1 987 477 677</b>	1511	MITSUBISHI	Carisma, Carisma Hatchback

de

**Bremseile**  
(Fortsetzung)

en

**Brake cables**  
(continued)

fr

**Câbles de frein  
de stationnement**  
(suite)

it

**Cavi del freno  
di stazionamento**  
(seguito)

es

**Cables de freno  
de mano**  
(continuación)



<b>1 987 477 679</b>	1512		SEAT	Cordoba, Cordoba Vario, Ibiza
			VW (VOLKSWAGEN)	Polo, Polo Classic, Polo Variant
<b>1 987 477 680</b>	1392		SEAT	Arosa
			SKODA	Pick-Up
			VW (VOLKSWAGEN)	Lupo
<b>1 987 477 681</b>	776		SAAB (SAAB AUTOMOBILE AB)	900 II, 900 II Cabriolet, 900 II Coupé
<b>1 987 477 682</b>	2104		SAAB (SAAB AUTOMOBILE AB)	900 II, 900 II Cabriolet, 900 II Coupé
<b>1 987 477 683</b>	1119		BMW	Serie 7
<b>1 987 477 684</b>	1620		SKODA	Octavia, Octavia Combi
<b>1 987 477 686</b>	1723		AUDI	A3, S3
			SKODA	Octavia, Octavia Combi
			VW (VOLKSWAGEN)	Bora, Bora Variant, Golf IV, Golf IV Variant, New Beetle
<b>1 987 477 687</b>	1491		AUDI	A6, A6 Avant, 100, 100 Avant
<b>1 987 477 688</b>	1638		PEUGEOT	605
<b>1 987 477 689</b>	1740		BMW	Serie 3 Compact
<b>1 987 477 690</b>	1752		SKODA	Favorit, Felicia, Felicia Combi, Felicia Fun, Forman
			VW (VOLKSWAGEN)	Caddy Pickup
<b>1 987 477 691</b>	739		MERCEDES-BENZ	Classe A, Serie A
<b>1 987 477 692</b>	1056		MERCEDES-BENZ	Serie A
<b>1 987 477 693</b>	1924		BMW	Serie 5, Serie 5 Touring
<b>1 987 477 694</b>	1877		BMW	Serie 5, Serie 5 Touring
<b>1 987 477 695</b>	1514		SEAT	Cordoba, Cordoba Vario, Ibiza
			SKODA	Superb, Superb Combi
			VW (VOLKSWAGEN)	Polo, Polo Classic, Polo Variant
			AUDI	A3
<b>1 987 477 696</b>	1688		SEAT	Toledo
			SKODA	Octavia, Octavia Combi
			VW (VOLKSWAGEN)	Bora, Bora Variant, Golf IV, Golf IV Variant, Jetta, New Beetle

<b>1 987 477 698</b>	1693		AUDI	A3
			SEAT	Leon, Leon Cupra R, Toledo
			SKODA	Octavia, Octavia Combi
			VW (VOLKSWAGEN)	Bora, Bora Variant, Golf, Golf IV, Golf IV Station Wagon, Golf IV Variant, Jetta, New Beetle, New Beetle Cabriolet
			<b>1 987 477 699</b>	2554
<b>1 987 477 7..</b>				
<b>1 987 477 700</b>	2067		MERCEDES-BENZ	Serie C, Serie C (T-Modell), Serie CLK (Cabrio), Serie CLK (Coupé)
<b>1 987 477 701</b>	2613		MERCEDES-BENZ	Serie E, Serie E (T-Modell)
<b>1 987 477 702</b>	1680		MERCEDES-BENZ	Sprinter
<b>1 987 477 703</b>	1680		MERCEDES-BENZ	Sprinter
<b>1 987 477 704</b>	1620		SKODA	Octavia, Octavia Combi
<b>1 987 477 705</b>	1496		SEAT	Arosa
			VW (VOLKSWAGEN)	Lupo
<b>1 987 477 706</b>	949		VW (VOLKSWAGEN)	California T4, Caravelle T4, Multivan T4, Transporter T4
<b>1 987 477 707</b>	953		VW (VOLKSWAGEN)	California T4, Caravelle T4, Eurovan, Kombi, Multivan T4, Transporter T4
<b>1 987 477 708</b>	1422		AUDI	Cabriolet, Coupé
<b>1 987 477 709</b>	1255		BMW	Serie Z
<b>1 987 477 710</b>	1283		BMW	Serie Z, Serie Z Coupé
<b>1 987 477 712</b>	1840		CITROEN	C5, C5 Break
<b>1 987 477 713</b>	1068		CITROEN	C8
			FIAT	Ulysse
			LANCIA	Phedra
			PEUGEOT	807
<b>1 987 477 714</b>	2360		CITROEN	C8
			FIAT	Ulysse
			LANCIA	Phedra
			PEUGEOT	807
<b>1 987 477 717</b>	1587		CHEVROLET	Lanos, Sens
			DAEWOO	Lanos, Lanos Hatchback, Sens
			ZAZ	Sens

nl

Remkabels  
(vervolg)

sv

Bromsvajrar  
(fortsättning)

pt



Cabos do travão  
(continuação)

cs

Brzdová lana  
(pokračování)

ru

Тросы тормозного  
привода  
(продолжение)

				
<b>1 987 477 718</b>	2825	CHEVROLET	Matiz, Spark	
		DAEWOO	Matiz	
<b>1 987 477 722</b>	1588	FIAT	Punto	
<b>1 987 477 723</b>	1810	FIAT	Doblo, Doblo Cargo	
<b>1 987 477 724</b>	1400	FIAT	Palio, Palio Weekend, Petra, Siena	
<b>1 987 477 725</b>	1581	ALFA ROMEO	GTV, Spider	
<b>1 987 477 726</b>	1298	LANCIA	Kappa Berlina, Kappa Coupé, Kappa Station Wagon	
<b>1 987 477 728</b>	1143	FIAT	Multipla	
<b>1 987 477 729</b>	2063	FIAT	Multipla	
<b>1 987 477 730</b>	1527	FIAT	Punto GT	
<b>1 987 477 731</b>	3800	FORD	Scorpio II, Scorpio II Turnier	
<b>1 987 477 732</b>	1445	FORD	Fiesta V, Fusion	
		MAZDA	2	
<b>1 987 477 733</b>	1722	FORD	Mondeo III Turnier	
<b>1 987 477 734</b>	1735	FORD	Mondeo, Mondeo III	
<b>1 987 477 735</b>	3760	FORD	Granada III, Granada III Estate, Scorpio I, Scorpio I Turnier, Scorpio II, Scorpio II Turnier	
<b>1 987 477 736</b>	1678	HONDA	Concerto Hatchback, Concerto Sedan	
		ROVER	Serie 200, Serie 400, Serie 400 Tourer	
<b>1 987 477 737</b>	1619	HONDA	Civic Hatchback	
<b>1 987 477 738</b>	1653	HONDA	Concerto Hatchback, Concerto Sedan	
		ROVER	Serie 200, Serie 400, Serie 400 Tourer	
<b>1 987 477 740</b>	1614	HONDA	Civic Hatchback	
<b>1 987 477 741</b>	1520	HYUNDAI	Coupé	
<b>1 987 477 742</b>	1512	HYUNDAI	Coupé	
<b>1 987 477 743</b>	1370	HYUNDAI	Coupé	
<b>1 987 477 747</b>	1702	MAZDA	626 Wagon	
<b>1 987 477 749</b>	1134	MERCEDES-BENZ	Serie CL (Coupé), Serie S, Serie S (Coupé)	
<b>1 987 477 750</b>	1109	MERCEDES-BENZ	Serie CL (Coupé), Serie S, Serie S (Coupé)	
<b>1 987 477 751</b>	990	SMART (MCC)	Fortwo Cabrio, Fortwo Coupé, Roadster, Smart Cabrio, Smart Coupé, Smart Crossblade	
<b>1 987 477 752</b>	1640	NISSAN	Primera Hatchback, Primera Sedan	
<b>1 987 477 753</b>	1657	NISSAN	Primera Hatchback, Primera Sedan	

				
<b>1 987 477 754</b>	1491	NISSAN	Primera Hatchback, Primera Sedan	
<b>1 987 477 755</b>	1668	NISSAN	Primera Hatchback, Primera Sedan, Primera Wagon	
<b>1 987 477 756</b>	1324	FORD	Maverick	
		NISSAN	Terrano II	
<b>1 987 477 757</b>	1470	FORD	Maverick	
		NISSAN	Terrano II	
<b>1 987 477 758</b>	1620	NISSAN	Primera Hatchback, Primera Sedan	
<b>1 987 477 759</b>	1516	NISSAN	Primera Hatchback, Primera Sedan	
<b>1 987 477 761</b>	799	OPEL	Sintra	
		VAUXHALL	Sintra	
<b>1 987 477 762</b>	2583	OPEL	Sintra	
		VAUXHALL	Sintra	
<b>1 987 477 763</b>	1630	OPEL	Vectra	
		VAUXHALL	Vectra	
<b>1 987 477 764</b>	1254	HOLDEN	Astra	
		OPEL	Astra, Astra Cabrio, Astra Caravan, Astra Coupé	
		VAUXHALL	Astra, Astra Convertible, Astra Coupé, Astra Estate, Astra Van	
<b>1 987 477 766</b>	1575	OPEL	Astra, Astra Cabrio	
<b>1 987 477 767</b>	1577	OPEL	Astra, Astra Caravan	
		VAUXHALL	Astra, Astra Estate, Astra Van	
<b>1 987 477 769</b>	1659	OPEL	Combo	
		VAUXHALL	Combo	
<b>1 987 477 771</b>	1518	OPEL	Agila	
		VAUXHALL	Agila	
<b>1 987 477 772</b>	1498	OPEL	Agila	
		VAUXHALL	Agila	
<b>1 987 477 773</b>	2368	CITROEN	Evasion, Jumpy	
		PEUGEOT	Expert, 806	
<b>1 987 477 774</b>	903	CITROEN	Jumpy	
		FIAT	Scudo	
		PEUGEOT	Expert	
<b>1 987 477 775</b>	2115	CITROEN	C4 Sedan	
		PEUGEOT	307 Break/SW	
<b>1 987 477 776</b>	1380	RENAULT	Clio II	
<b>1 987 477 777</b>	1310	RENAULT	Clio II	
<b>1 987 477 781</b>	1332	RENAULT	Megane I Coupé	
<b>1 987 477 782</b>	1415	RENAULT	Clio II, Thalia	
<b>1 987 477 783</b>	1335	RENAULT	Clio II, Thalia	
<b>1 987 477 784</b>	1402	RENAULT	Clio II, Thalia	
<b>1 987 477 785</b>	1321	RENAULT	Clio II, Thalia	
<b>1 987 477 786</b>	2023	RENAULT	Megane II Hatchback	

de

**Bremsseile**  
(Fortsetzung)

en

**Brake cables**  
(continued)

fr

**Câbles de frein  
de stationnement**  
(suite)

it

**Cavi del freno  
di stazionamento**  
(seguito)

es

**Cables de freno  
de mano**  
(continuación)



<b>1 987 477 787</b>	2080	RENAULT	Grand Scenic II, Megane II, Megane II Grandtour, Scenic II	
<b>1 987 477 788</b>	1531	HONDA	Concerto Hatchback, Concerto Sedan	
		ROVER	Serie 200, Serie 400, Serie 400 Tourer	
<b>1 987 477 789</b>	1506	HONDA	Concerto Hatchback, Concerto Sedan	
		ROVER	Serie 200, Serie 400, Serie 400 Tourer	
<b>1 987 477 790</b>	1568	LAND ROVER GROUP	Freelander	
<b>1 987 477 791</b>	1568	LAND ROVER GROUP	Freelander	
<b>1 987 477 792</b>	3170	SEAT	Terra	
<b>1 987 477 793</b>	1499	SUZUKI	Baleno Hatchback	
<b>1 987 477 794</b>	408	TOYOTA	RAV4	
<b>1 987 477 795</b>	1627	TOYOTA	Celica Cabrio, Celica Liftback	
<b>1 987 477 797</b>	1718	TOYOTA	Camry, Camry Wagon	
<b>1 987 477 8..</b>				
<b>1 987 477 801</b>	1038	MERCEDES-BENZ	Serie A, Vaneo	
<b>1 987 477 803</b>	1890	VW (VOLKSWAGEN)	Passat, Passat Variant	
<b>1 987 477 804</b>	1890	VW (VOLKSWAGEN)	Passat, Passat Variant	
<b>1 987 477 806</b>	1580	SEAT	Cordoba, Ibiza	
		SKODA	Fabia, Fabia Combi, Fabia Schrägheck	
		VW (VOLKSWAGEN)	Polo, Polo Sedan	
<b>1 987 477 807</b>	1640	SEAT	Cordoba, Ibiza	
		SKODA	Fabia, Fabia Combi, Fabia RS, Fabia Schrägheck	
		VW (VOLKSWAGEN)	Polo, Polo Sedan	
<b>1 987 477 808</b>	1075	AUDI	A2	
<b>1 987 477 809</b>	1046	MERCEDES-BENZ	Serie A	
<b>1 987 477 810</b>	685	MERCEDES-BENZ	Serie A, Vaneo	
<b>1 987 477 811</b>	2297	MERCEDES-BENZ	Serie SL	
<b>1 987 477 812</b>	1044	MERCEDES-BENZ	Serie SL	
<b>1 987 477 813</b>	1692	AUDI	A6, A6 Avant, S4, S6, S6 Avant, 100, 100 Avant	
<b>1 987 477 814</b>	1014	MERCEDES-BENZ	Serie SL	
<b>1 987 477 815</b>	1676	AUDI	A6, A6 Avant, S4, S6, S6 Avant, 100, 100 Avant	

<b>1 987 477 816</b>	1234	NISSAN	Serena, Vanette Cargo	
<b>1 987 477 817</b>	1700	SEAT	Toledo	
		SKODA	Octavia, Octavia Combi	
<b>1 987 477 819</b>	1993	VOLVO	S80 I, V70 II, XC70 I	
<b>1 987 477 820</b>	1942	BMW	Serie X	
<b>1 987 477 821</b>	1930	BMW	Serie X	
<b>1 987 477 824</b>	1502	FIAT	Bravo, Marea	
<b>1 987 477 825</b>	1404	FIAT	Brava, Marea, Marea Weekend, Marengo	
<b>1 987 477 826</b>	1383	ALFA ROMEO	146	
		FIAT	Brava, Bravo, Marea	
<b>1 987 477 827</b>	1370	FIAT	Brava, Bravo	
<b>1 987 477 828</b>	1424	FIAT	Brava, Bravo	
<b>1 987 477 829</b>	1710	FIAT	Strada	
<b>1 987 477 830</b>	1710	FIAT	Strada	
<b>1 987 477 831</b>	1235	ALFA ROMEO	147	
<b>1 987 477 832</b>	406	FIAT	Tempra, Tempra SW	
<b>1 987 477 833</b>	654	FORD	Galaxy	
		SEAT	Alhambra	
		VW (VOLKSWAGEN)	Sharan	
<b>1 987 477 834</b>	1705	FORD	Escort, Escort Sedan, Escort SW, Escort VII, Escort VII Cabrio, Escort VII RS, Escort VII Turnier, Escort VII XR3i Cabrio	
<b>1 987 477 835</b>	1650	FORD	Escort VII, Escort VII Cabrio, Escort VII RS, Escort VII Turnier, Escort VII XR3i Cabrio	
<b>1 987 477 836</b>	1462	FORD	Cougar, Mondeo I, Mondeo I Turnier, Mondeo II	
<b>1 987 477 842</b>	1377	HYUNDAI	Coupé	
<b>1 987 477 843</b>	1617	LADA	Forma, Samara, Samara Fun, Samara Hatchback, Serie 115, Serie 21000	
<b>1 987 477 844</b>	2265	MERCEDES-BENZ	Serie S	
<b>1 987 477 845</b>	2735	MERCEDES-BENZ	Serie C, Serie C (Sportcoupe), Serie C (T-Modell), Serie CLC, Serie CLK (Cabrio), Serie CLK (Coupé)	
<b>1 987 477 846</b>	925	MERCEDES-BENZ	Serie C, Serie C (Sportcoupe), Serie C (T-Modell), Serie CLC, Serie CLK (Cabrio), Serie CLK (Coupé)	

nl

Remkabels  
(vervolg)

sv

Bromsvajrar  
(fortsättning)

pt



Cabos do travão  
(continuação)



cs

Brzdová lana  
(pokračování)

ru

Тросы тормозного  
привода  
(продолжение)

				
<b>1 987 477 847</b>	900	MERCEDES-BENZ	Serie C, Serie C (Sportcoupe), Serie C (T-Modell), Serie CLC, Serie CLK (Cabrio), Serie CLK (Coupé)	
<b>1 987 477 848</b>	2160	MERCEDES-BENZ	Serie C, Serie C (Sportcoupe), Serie C (T-Modell), Serie CLC, Serie CLK (Cabrio), Serie CLK (Coupé)	
<b>1 987 477 849</b>	1058	MERCEDES-BENZ	Serie E, Serie E (T-Modell)	
<b>1 987 477 850</b>	1031	MERCEDES-BENZ	Serie E, Serie E (T-Modell)	
<b>1 987 477 851</b>	1952	MERCEDES-BENZ	Serie CLS, Serie E, Serie E (T-Modell)	
<b>1 987 477 852</b>	1513	MERCEDES-BENZ	Sprinter, 311 Sprinter, 411 Sprinter	
		STEYR (STEYR-DAIMLER- PUCH AG)	G	
		VW (VOLKSWAGEN)	LT	
<b>1 987 477 853</b>	1435	MERCEDES-BENZ	Sprinter	
		VW (VOLKSWAGEN)	LT	
<b>1 987 477 854</b>	1990	MERCEDES-BENZ	Sprinter, 311 Sprinter	
		VW (VOLKSWAGEN)	LT	
<b>1 987 477 855</b>	2460	MERCEDES-BENZ	Sprinter, 311 Sprinter	
		VW (VOLKSWAGEN)	LT	
<b>1 987 477 856</b>	1415	MERCEDES-BENZ	Sprinter	
<b>1 987 477 857</b>	1545	MERCEDES-BENZ	Sprinter, 311 Sprinter, 411 Sprinter	
<b>1 987 477 858</b>	1525	MERCEDES-BENZ	Sprinter	
		VW (VOLKSWAGEN)	LT	
<b>1 987 477 859</b>	1526	MERCEDES-BENZ	Sprinter	
		VW (VOLKSWAGEN)	LT	
<b>1 987 477 860</b>	1570	MERCEDES-BENZ	Sprinter	
<b>1 987 477 861</b>	1565	MERCEDES-BENZ	Sprinter	
<b>1 987 477 862</b>	1851	MITSUBISHI	Galant, Galant Station Wagon	
<b>1 987 477 864</b>	1917	MITSUBISHI	Space Wagon	
<b>1 987 477 868</b>	1355	OPEL	Zafira	
		VAUXHALL	Zafira	
<b>1 987 477 869</b>	1235	OPEL	Combo	
		VAUXHALL	Combo, Corsa	
<b>1 987 477 870</b>	1756	PEUGEOT	406, 406 Break, 406 Coupé	

				
<b>1 987 477 871</b>	1656	PEUGEOT	406, 406 Break, 406 Coupé	
<b>1 987 477 872</b>	2183	ROVER	100 Metro, 100 Metro Cabrio	
<b>1 987 477 873</b>	1193	LAND ROVER GROUP	Discovery I	
<b>1 987 477 874</b>	1630	SUZUKI	Vitara	
<b>1 987 477 875</b>	1570	SUZUKI	Jimny	
<b>1 987 477 878</b>	1590	VOLVO	S40 I, V40 I	
<b>1 987 477 879</b>	2188	VOLVO	740, 940	
<b>1 987 477 880</b>	2440	MERCEDES-BENZ	Sprinter, 411 Sprinter	
		VW (VOLKSWAGEN)	LT	
<b>1 987 477 881</b>	1657	AUDI	A8, S8	
<b>1 987 477 882</b>	1720	AUDI	A8, S8	
<b>1 987 477 883</b>	1395	SEAT	Arosa	
<b>1 987 477 885</b>	1570	MG	ZT, ZT-Tourer	
		ROVER	75, 75 Tourer	
<b>1 987 477 886</b>	1713	MG	ZR	
		ROVER	Serie 200, 25	
<b>1 987 477 887</b>	1743	MG	ZR	
		ROVER	Serie 200, 25	
<b>1 987 477 888</b>	1812	MG	ZR	
		ROVER	Serie 200, 25	
<b>1 987 477 889</b>	1782	MG	ZR	
		ROVER	Serie 200, 25	
<b>1 987 477 890</b>	1508	RENAULT	Scenic I	
<b>1 987 477 893</b>	1620	VOLVO	S40 I, V40 I	
<b>1 987 477 894</b>	1620	VOLVO	S40 I, V40 I	
<b>1 987 477 895</b>	2180	SAAB (SAAB AUTOMOBILE AB)	9-3, 9-3 Cabriolet, 9-3 Coupé, 900 II, 900 II Cabriolet, 900 II Coupé	
<b>1 987 477 896</b>	2557	MERCEDES-BENZ	Serie C, Serie C (T-Modell), Serie CLK (Cabrio), Serie CLK (Coupé)	
<b>1 987 477 897</b>	1726	MERCEDES-BENZ	Serie CLS, Serie E, Serie E (T-Modell)	
<b>1 987 477 898</b>	1433	MERCEDES-BENZ	Serie CLS, Serie E, Serie E (T-Modell)	
<b>1 987 477 899</b>	992	MERCEDES-BENZ	Serie CL (Coupé), Serie S	
<b>1 987 477 9..</b>				
<b>1 987 477 900</b>	978	MERCEDES-BENZ	Serie CL (Coupé), Serie S	
<b>1 987 477 901</b>	2760	MERCEDES-BENZ	Serie S	
<b>1 987 477 902</b>	1780	MERCEDES-BENZ	Serie ML	
<b>1 987 477 903</b>	2025	MERCEDES-BENZ	Serie ML	
<b>1 987 477 904</b>	1932	MERCEDES-BENZ	Serie ML	
<b>1 987 477 905</b>	1445	MERCEDES-BENZ	Serie ML	

de

**Bremsseile**  
(Fortsetzung)

en

**Brake cables**  
(continued)

fr

**Câbles de frein  
de stationnement**  
(suite)

it

**Cavi del freno  
di stazionamento**  
(seguito)

es

**Cables de freno  
de mano**  
(continuación)



<b>1 987 477 906</b>	175		FORD	Fiesta V, Focus I, Focus I Turnier, Focus Sedan, Fusion
			MAZDA	2
<b>1 987 477 907</b>	1805		OPEL	Signum, Vectra, Vectra Caravan
			VAUXHALL	Signum, Vectra, Vectra Estate
<b>1 987 477 908</b>	1326		OPEL	Astra, Astra Caravan, Astra GTC, Astra TwinTop
			VAUXHALL	Astra, Astra Estate, Astra GTC, Astra TwinTop
<b>1 987 477 909</b>	1665		OPEL	Astra, Astra Caravan, Astra GTC, Astra TwinTop
			VAUXHALL	Astra, Astra Estate, Astra GTC, Astra TwinTop
<b>1 987 477 910</b>	1786		FIAT	Bravo, Stilo, Stilo Multi Wagon
<b>1 987 477 911</b>	1668		FIAT	Bravo, Stilo, Stilo Multi Wagon
<b>1 987 477 912</b>	1425		LANCIA	Ypsilon
<b>1 987 477 913</b>	221		NISSAN	Almera Hatchback, Almera Sedan, Almera Tino
<b>1 987 477 914</b>	1661		NISSAN	Almera Hatchback, Almera Sedan
<b>1 987 477 915</b>	1650		NISSAN	Almera Hatchback, Almera Sedan
<b>1 987 477 916</b>	1715		MAZDA	323, 323 Hatchback, 626, 626 Fastback, 626 Hatchback
<b>1 987 477 917</b>	1693		MAZDA	323, 323 Hatchback, 626, 626 Fastback, 626 Hatchback
<b>1 987 477 918</b>	1520		TOYOTA	Vitz, Yaris
<b>1 987 477 919</b>	1481		TOYOTA	Vitz, Yaris
<b>1 987 477 920</b>	1655		CHEVROLET	Lanos, Sens
			DAEWOO	Lanos, Lanos Hatchback, Sens
			ZAZ	Sens
<b>1 987 477 922</b>	1928		AUDI	A4, A4 Avant, A4 Cabriolet
			SEAT	Exeo, Exeo ST
<b>1 987 477 923</b>	2005		AUDI	A4, A4 Avant, A4 Cabriolet
			SEAT	Exeo, Exeo ST
<b>1 987 477 924</b>	1680		BMW	Serie 3 Compact
<b>1 987 477 925</b>	1557		FIAT	Idea
			LANCIA	Musa

<b>1 987 477 926</b>	1435		FIAT	Panda
<b>1 987 477 927</b>	1405		FIAT	Panda
<b>1 987 477 928</b>	1535		FIAT	Idea, Ulysse
			LANCIA	Musa
<b>1 987 477 929</b>	326		FORD	Focus I, Focus I Turnier, Tourneo Connect, Transit Connect
<b>1 987 477 930</b>	1480		FORD	Focus I, Focus I Turnier
<b>1 987 477 931</b>	1770		FORD	Focus I, Focus I Turnier
<b>1 987 477 932</b>	1483		FORD	Focus I, Focus I Turnier
<b>1 987 477 933</b>	1770		FORD	Focus I, Focus I Turnier
<b>1 987 477 934</b>	1760		OPEL	Astra, Astra Caravan
			VAUXHALL	Astra Estate
<b>1 987 477 935</b>	1615		OPEL	Meriva
			VAUXHALL	Meriva
<b>1 987 477 936</b>	1610		OPEL	Meriva
			VAUXHALL	Meriva
<b>1 987 477 937</b>	1467		RENAULT	Scenic I
<b>1 987 477 938</b>	1276		RENAULT	Modus
<b>1 987 477 939</b>	1497		RENAULT	Modus
<b>1 987 477 940</b>	1387		RENAULT	Modus
<b>1 987 477 941</b>	1962		VOLVO	V70 II
<b>1 987 477 942</b>	1561		VW (VOLKSWAGEN)	Touran
<b>1 987 477 943</b>	1670		NISSAN	Almera Tino
<b>1 987 477 944</b>	1660		NISSAN	Almera Tino
<b>1 987 477 946</b>	1434		BMW	Serie 1, Serie 1 Cabrio, Serie 1 Coupé
<b>1 987 477 947</b>	1673		BMW	Serie 5, Serie 5 Touring
<b>1 987 477 948</b>	1681		BMW	Serie 5, Serie 5 Touring
<b>1 987 477 949</b>	1090		BMW	Serie Z, Serie Z Coupé
<b>1 987 477 950</b>	1533		BMW	Serie 3, Serie 3 Cabrio, Serie 3 Coupé, Serie 3 Touring
<b>1 987 477 951</b>	1478		CITROEN	C1
			PEUGEOT	107
			TOYOTA	Aygo
<b>1 987 477 952</b>	1487		CITROEN	C1
			PEUGEOT	107
			TOYOTA	Aygo
<b>1 987 477 953</b>	2308		CITROEN	C8
			FIAT	Ulysse
			LANCIA	Phedra
			PEUGEOT	807

nl

Remkabels  
(vervolg)

sv

Bromsvajrar  
(fortsättning)

pt









Cabos do travão  
(continuação)





cs

Brzdová lana  
(pokračování)

ru

Тросы тормозного  
привода  
(продолжение)

			
<b>1 987 477 954</b>	1041		CITROEN C8
			FIAT Ulysse
			LANCIA Phedra
			PEUGEOT 807
<b>1 987 477 955</b>	1680		DACIA Logan
			RENAULT Logan, Symbol
<b>1 987 477 956</b>	1667		DACIA Logan
			RENAULT Logan
<b>1 987 477 957</b>	1447		SEAT Altea, Altea Freetrack, Altea XL, Toledo
<b>1 987 477 958</b>	1447		AUDI A3, A3 Sportback, RS3 Sportback, S3, S3 Sportback
			SEAT Altea, Altea Freetrack, Altea XL, Leon, Leon Cupra, Toledo
			SKODA Octavia, Octavia Combi, Yeti
			VW (VOLKSWAGEN) Eos, Golf Plus, Golf V, Golf V Variant, Golf VI, Golf VI Cabriolet, Golf VI Variant, Jetta, Scirocco, Scirocco R
<b>1 987 477 959</b>	1925		AUDI A6, A6 Allroad, A6 Avant, S6, S6 Avant
<b>1 987 477 960</b>	987		MERCEDES-BENZ Serie A
<b>1 987 477 961</b>	1170		MERCEDES-BENZ Serie A
<b>1 987 477 962</b>	987		MERCEDES-BENZ Serie A
<b>1 987 477 965</b>	1587		RENAULT Clio III, Clio III Grandtour
			RENAULT Clio III, Clio III Grandtour
<b>1 987 477 966</b>	1451		RENAULT Clio III, Clio III Grandtour
<b>1 987 477 967</b>	1375		RENAULT Modus
<b>1 987 477 968</b>	1511		FIAT Albea
<b>1 987 477 969</b>	1501		FIAT Albea
<b>1 987 477 970</b>	1471		FIAT Panda
<b>1 987 477 971</b>	1485		FIAT Panda
<b>1 987 477 972</b>	1465		FIAT Punto
<b>1 987 477 973</b>	1660		FIAT Punto, Punto Evo, Punto Grande
			FIAT Punto, Punto Evo, Punto Grande
<b>1 987 477 974</b>	1642		FIAT Punto, Punto Evo, Punto Grande
			FIAT Grande Punto, Punto, Punto Evo, Punto Grande
<b>1 987 477 975</b>	1689		FIAT Grande Punto, Punto, Punto Evo, Punto Grande
			FIAT Grande Punto, Punto, Punto Evo, Punto Grande
<b>1 987 477 976</b>	1674		FIAT Grande Punto, Punto, Punto Evo, Punto Grande
			FIAT Grande Punto, Punto, Punto Evo, Punto Grande
<b>1 987 477 977</b>	1673		ALFA ROMEO MiTo
			FIAT Punto, Punto Evo, Punto Grande, Punto Grande Abarth, Punto Grande Abarth SS

			
<b>1 987 477 978</b>	1654		ALFA ROMEO MiTo
			FIAT Punto, Punto Evo, Punto Grande, Punto Grande Abarth, Punto Grande Abarth SS
<b>1 987 477 979</b>	200		NISSAN Micra, Micra CC, Note
<b>1 987 477 980</b>	1604		NISSAN Micra, Micra CC
<b>1 987 477 981</b>	1642		NISSAN Primera Hatchback, Primera Sedan, Primera Wagon
<b>1 987 477 982</b>	303		NISSAN Primera Hatchback, Primera Sedan, Terrano II
<b>1 987 477 983</b>	292		TOYOTA Corolla, Corolla Hatchback, Corolla Liftback, Corolla Sedan, Corolla Wagon
<b>1 987 477 984</b>	296		TOYOTA Corolla, Corolla Hatchback, Corolla Liftback, Corolla Sedan, Corolla Wagon
<b>1 987 477 985</b>	398		TOYOTA Avensis, Avensis Liftback, Avensis Wagon, Corolla, Corolla Fielder, Corolla Hatchback, Corolla RunX, Corolla Sedan, Corolla Verso, Corolla Wagon
<b>1 987 477 986</b>	346		TOYOTA Carina E Liftback, Carina E Sedan, Carina E Wagon
<b>1 987 477 987</b>	1613		BMW Serie X
<b>1 987 477 988</b>	1634		BMW Serie X
<b>1 987 477 989</b>	3105		FIAT Fiorino, Fiorino Furgao
<b>1 987 477 990</b>	306		FORD Mondeo III, Mondeo III Turnier
<b>1 987 477 992</b>	1540		NISSAN Micra, Micra CC
<b>1 987 477 993</b>	1693		CITROEN C3, C3-Pluriel
<b>1 987 477 994</b>	2155		PEUGEOT 407, 407 Coupé, 407 SW
<b>1 987 477 995</b>	1507		OPEL Agila
			SUZUKI Wagon R+
			VAUXHALL Agila
<b>1 987 477 996</b>	258		TOYOTA RAV4, RAV4 Cabrio, Starlet
<b>1 987 477 997</b>	1518		TOYOTA Starlet
<b>1 987 477 998</b>	1485		TOYOTA Starlet
<b>1 987 477 999</b>	1923		VOLVO S60 I, V70 II



de

**Bremssseile**  
(Fortsetzung)

en

**Brake cables**  
(continued)

fr

**Câbles de frein  
de stationnement**  
(suite)

it

**Cavi del freno  
di stazionamento**  
(seguito)

es

**Cables de freno  
de mano**  
(continuación)

**1 987 482 0..**

<b>1 987 482 000</b>	928	CITROEN	C4 Grand Picasso, C4 Picasso
<b>1 987 482 001</b>	959	CITROEN	C4 Grand Picasso, C4 Picasso
<b>1 987 482 002</b>	1078	FIAT	Ducato, Ducato Cargo, Ducato 10, Ducato 11, Ducato 14, Ducato 15, Ducato 18
		PEUGEOT	Boxer
<b>1 987 482 003</b>	2715	CITROEN	Jumper
		FIAT	Ducato Cargo, Ducato Minibus, Ducato 10, Ducato 11, Ducato 14, Ducato 15, Ducato 18
		PEUGEOT	Boxer
<b>1 987 482 004</b>	1170	CITROEN	Jumper
		FIAT	Ducato 10, Ducato 14, Ducato 18
		PEUGEOT	Boxer
<b>1 987 482 005</b>	4095	CITROEN	Jumper
		PEUGEOT	Boxer
<b>1 987 482 006</b>	2827	CITROEN	Jumper
		FIAT	Ducato 10, Ducato 14, Ducato 18
		PEUGEOT	Boxer
<b>1 987 482 007</b>	1614	CITROEN	Jumpy
		FIAT	Scudo
		PEUGEOT	Expert
<b>1 987 482 008</b>	1737	CITROEN	Jumpy
		FIAT	Scudo
		PEUGEOT	Expert
<b>1 987 482 009</b>	2503	LADA	Serie 2100, Serie 21000, Toscana
<b>1 987 482 010</b>	2122	LADA	Niva
<b>1 987 482 011</b>	1940	RENAULT	Megane II Cabrio
<b>1 987 482 012</b>	1175	NISSAN	Interstar
		OPEL	Movano
		VAUXHALL	Movano
<b>1 987 482 013</b>	1420	NISSAN	Interstar
		OPEL	Movano
		RENAULT	Master II
		VAUXHALL	Movano
<b>1 987 482 014</b>	1270	VW (VOLKSWAGEN)	California T5, Caravelle T5, Multivan T5, Transporter T5
<b>1 987 482 015</b>	2015	VW (VOLKSWAGEN)	Transporter T5
<b>1 987 482 016</b>	1650	VW (VOLKSWAGEN)	California T5, Caravelle T5, Multivan T5, Transporter T5

<b>1 987 482 017</b>	2015	VW (VOLKSWAGEN)	California T5, Caravelle T5, Multivan T5, Transporter T5
<b>1 987 482 018</b>	1750	PORSCHE VW (VOLKSWAGEN)	Cayenne Touareg
<b>1 987 482 019</b>	1816	VOLVO	C30, C70 II Cabrio, S40 II, V50
<b>1 987 482 020</b>	342	SAAB (SAAB AUTOMOBILE AB)	9-5, 9-5 Kombi
<b>1 987 482 021</b>	1932	SAAB (SAAB AUTOMOBILE AB)	9-3, 9-3 Cabriolet, 9-3 Kombi, 9-3X
<b>1 987 482 022</b>	760	MERCEDES-BENZ	Serie SLK
<b>1 987 482 023</b>	1004	MERCEDES-BENZ	Serie SLK
<b>1 987 482 024</b>	817	MERCEDES-BENZ	Serie GL, Serie ML
<b>1 987 482 025</b>	1152	MERCEDES-BENZ	Viano, Vito
<b>1 987 482 026</b>	1285	MERCEDES-BENZ	Viano, Vito
<b>1 987 482 027</b>	1468	VW (VOLKSWAGEN)	Crafter 30, Crafter 35, Crafter 50
<b>1 987 482 028</b>	1867	MERCEDES-BENZ VW (VOLKSWAGEN)	Sprinter Crafter 30, Crafter 35, Crafter 50
<b>1 987 482 029</b>	2522	MERCEDES-BENZ VW (VOLKSWAGEN)	Sprinter Crafter 30, Crafter 35, Crafter 50
<b>1 987 482 030</b>	1771	MERCEDES-BENZ VW (VOLKSWAGEN)	Sprinter Crafter 30, Crafter 35, Crafter 50
<b>1 987 482 031</b>	2425	VW (VOLKSWAGEN)	Crafter 30, Crafter 35, Crafter 50
<b>1 987 482 032</b>	1666	MERCEDES-BENZ VW (VOLKSWAGEN)	Sprinter Crafter 30, Crafter 35
<b>1 987 482 033</b>	1394	VW (VOLKSWAGEN)	Crafter 50
<b>1 987 482 034</b>	1432	VW (VOLKSWAGEN)	Crafter 50
<b>1 987 482 035</b>	1648	FORD	Transit
<b>1 987 482 036</b>	1283	FORD	Transit, Transit Euroline, Transit Nugget, Transit Tourneo
<b>1 987 482 038</b>	1477	OPEL VAUXHALL	Corsa Corsa
<b>1 987 482 039</b>	1475	OPEL VAUXHALL	Corsa Corsa
<b>1 987 482 040</b>	1450	RENAULT	Clio II
<b>1 987 482 041</b>	1378	RENAULT	Clio II
<b>1 987 482 042</b>	508	NISSAN OPEL RENAULT VAUXHALL	Primastar Vivaro Trafic II Vivaro

nl

Remkabels  
(vervolg)

sv

Bromsvajrar  
(fortsättning)

pt



Cabos do travão  
(continuação)



cs

Brzdová lana  
(pokračování)

ru

Тросы тормозного  
привода  
(продолжение)

				
<b>1 987 482 043</b>		1190	NISSAN	Primastar
			OPEL	Vivaro
			RENAULT	Trafic II
			VAUXHALL	Vivaro
<b>1 987 482 044</b>		1752	RENAULT	Master I
<b>1 987 482 045</b>		1778	RENAULT	Master I
<b>1 987 482 046</b>		1137	CITROEN	Jumper
			FIAT	Ducato 10, Ducato 14, Ducato 18
			PEUGEOT	Boxer
<b>1 987 482 048</b>		1365	NISSAN	Terrano II
<b>1 987 482 049</b>		1394	NISSAN	Terrano II
<b>1 987 482 050</b>		1510	NISSAN	Terrano II
<b>1 987 482 051</b>		1520	NISSAN	Terrano II
<b>1 987 482 052</b>		1810	MAZDA	5
<b>1 987 482 053</b>		1828	MAZDA	5
<b>1 987 482 054</b>		1640	MAZDA	6, 6 Fastback, 6 Sedan, 6 Wagon
<b>1 987 482 055</b>		1143	MAZDA	MX-5
<b>1 987 482 056</b>		1143	MAZDA	MX-5
<b>1 987 482 057</b>		1875	MAZDA	3, 3 Hatchback
<b>1 987 482 058</b>		1831	MAZDA	3, 3 Hatchback
<b>1 987 482 060</b>		1390	TOYOTA	Picnic
<b>1 987 482 061</b>		1305	TOYOTA	Picnic
<b>1 987 482 062</b>		1395	MITSUBISHI	Colt
<b>1 987 482 063</b>		1350	MITSUBISHI	Colt
<b>1 987 482 064</b>		1563	MITSUBISHI	Spacestar
<b>1 987 482 065</b>		1540	MITSUBISHI	Spacestar
<b>1 987 482 066</b>		1888	MITSUBISHI	L 200
<b>1 987 482 067</b>		2350	MITSUBISHI	L 200
<b>1 987 482 068</b>		1995	MITSUBISHI	L 200, L 200 Forte
			MITSUBISHI	L 200, L 200 Forte
<b>1 987 482 069</b>		1995	MITSUBISHI	L 200, L 200 Forte
<b>1 987 482 070</b>		1610	HYUNDAI	Getz
<b>1 987 482 071</b>		1620	HYUNDAI	Getz
<b>1 987 482 072</b>		1598	HYUNDAI	Getz
<b>1 987 482 073</b>		1607	HYUNDAI	Getz
<b>1 987 482 074</b>		1650	HYUNDAI	Matrix
<b>1 987 482 075</b>		1718	HYUNDAI	Matrix
<b>1 987 482 076</b>		1741	HYUNDAI	Santa Fe, Satnta Fe
<b>1 987 482 077</b>		1775	HYUNDAI	Santa Fe, Satnta Fe
<b>1 987 482 078</b>		1590	SUBARU	Impreza Sedan
<b>1 987 482 079</b>		1610	SUBARU	Impreza Sedan
<b>1 987 482 080</b>		1603	SUBARU	Forester, Impreza Sedan
<b>1 987 482 081</b>		1625	SUBARU	Forester, Impreza Sedan
			SUBARU	Forester, Impreza Sedan
<b>1 987 482 082</b>		1384	CHEVROLET	Aveo, Aveo Hatchback, Kalos, Kalos Hatchback
			DAEWOO	Kalos, Kalos Hatchback

				
<b>1 987 482 083</b>		1396	CHEVROLET	Aveo, Aveo Hatchback, Kalos, Kalos Hatchback
			DAEWOO	Kalos, Kalos Hatchback
<b>1 987 482 084</b>		1542	HONDA	Civic, Civic Hatchback, Civic Sedan, Civiv Sedan
			HONDA	Civic, Civic Hatchback, Civic Sedan, Civiv Sedan
<b>1 987 482 085</b>		1535	HONDA	Civic, Civic Hatchback, Civic Sedan, Civiv Sedan
			HONDA	Civic, Civic Hatchback, Civic Sedan, Civiv Sedan
<b>1 987 482 086</b>		1715	HONDA	CR-V
<b>1 987 482 087</b>		1678	HONDA	CR-V
<b>1 987 482 088</b>		3135	MARUTI	Zen
			SUZUKI	Alto Hatchback
<b>1 987 482 089</b>		1395	SUZUKI	Vitara, Vitara Cabrio, X-90
<b>1 987 482 090</b>		1390	SUZUKI	Grand Vitara, Grand Vitara Cabrio
<b>1 987 482 091</b>		1336	SUZUKI	Grand Vitara, Grand Vitara Cabrio
<b>1 987 482 092</b>		1523	SUZUKI	Ignis Hatchback
<b>1 987 482 093</b>		1532	SUZUKI	Ignis Hatchback
<b>1 987 482 094</b>		1625	SUZUKI	Grand Vitara
<b>1 987 482 095</b>		1575	SUZUKI	Grand Vitara
<b>1 987 482 096</b>		1478	SUZUKI	Alto
<b>1 987 482 097</b>		1515	KIA	Picanto
<b>1 987 482 098</b>		1515	KIA	Picanto
<b>1 987 482 099</b>		1584	KIA	Rio, Rio Kombi
<b>1 987 482 1..</b>				
<b>1 987 482 100</b>		1658	KIA	Sephia I, Spectra Hatchback
<b>1 987 482 102</b>		1592	OPEL	Astra, Astra Cabrio, Astra Caravan, Astra Coupé
			VAUXHALL	Astra, Astra Coupé, Astra Estate, Astra Van
<b>1 987 482 103</b>		1488	CITROEN	ZX
<b>1 987 482 105</b>		2165	VOLVO	S70, V70 I
<b>1 987 482 106</b>		1892	SAAB (SAAB AUTOMOBILE AB)	9000
			OPEL	Zafira
<b>1 987 482 107</b>		1680	SAAB (SAAB AUTOMOBILE AB)	9000
			VAUXHALL	Zafira
			FIAT	Uno, Uno Van
<b>1 987 482 108</b>		523	FIAT	Uno, Uno Van
<b>1 987 482 109</b>		1521	FIAT	Barchetta
<b>1 987 482 110</b>		1936	OPEL	Frontera
			VAUXHALL	Frontera
<b>1 987 482 111</b>		1936	OPEL	Frontera
			VAUXHALL	Frontera

de

**Bremseile**  
(Fortsetzung)

en

**Brake cables**  
(continued)

fr

**Câbles de frein  
de stationnement**  
(suite)

it

**Cavi del freno  
di stazionamento**  
(seguito)

es

**Cables de freno  
de mano**  
(continuación)



<b>1 987 482 112</b>	1790	CITROEN	C3, C3-Pluriel	
<b>1 987 482 113</b>	1606	CITROEN	ZX	
<b>1 987 482 114</b>	1530	CITROEN	ZX	
<b>1 987 482 115</b>	1285	CITROEN	Xantia, Xantia Break	
<b>1 987 482 116</b>	1820	CITROEN PEUGEOT	Berlingo Partner	
<b>1 987 482 117</b>	1922	CITROEN PEUGEOT	Berlingo Partner	
<b>1 987 482 118</b>	1495	CITROEN FIAT PEUGEOT	Jumpy Scudo Expert	
<b>1 987 482 119</b>	1655	MG ROVER	ZS Serie 400, Serie 400 Coupé, Serie 400 Tourer, 45	
<b>1 987 482 120</b>	1636	MG ROVER	ZS Serie 400, Serie 400 Coupé, Serie 400 Tourer, 45	
<b>1 987 482 121</b>	330	FORD	Focus I, Focus I Turnier	
<b>1 987 482 122</b>	228	FORD	Focus II, Focus II Turnier	
<b>1 987 482 123</b>	1751	FORD	Escort VII Express	
<b>1 987 482 124</b>	1582	VW (VOLKSWAGEN)	Golf III, Golf III Variant	
<b>1 987 482 125</b>	1057	AUDI	A2	
<b>1 987 482 126</b>	1776	AUDI	A8, S8	
<b>1 987 482 127</b>	2198	VOLVO	740	
<b>1 987 482 128</b>	1985	VOLVO	XC90, XC90 I	
<b>1 987 482 129</b>	1620	SKODA	Octavia, Octavia Combi	
<b>1 987 482 130</b>	1463	MERCEDES-BENZ	Vaneo	
<b>1 987 482 131</b>	1970	MERCEDES-BENZ VW (VOLKSWAGEN)	Sprinter LT	
<b>1 987 482 132</b>	300	FORD	Fiesta V, Fusion	
<b>1 987 482 133</b>	2070	FORD	Galaxy, S-MAX	
<b>1 987 482 134</b>	2067	FORD	Galaxy, S-MAX	
<b>1 987 482 135</b>	1352	FORD	Transit	
<b>1 987 482 136</b>	1530	OPEL VAUXHALL	Agila Agila	
<b>1 987 482 137</b>	1536	OPEL VAUXHALL	Agila Agila	
<b>1 987 482 138</b>	1582	OPEL VAUXHALL	Combo Combo, Corsa	
<b>1 987 482 139</b>	1143	OPEL VAUXHALL	Tigra TwinTop Tigra TwinTop	
<b>1 987 482 140</b>	1426	OPEL VAUXHALL	Tigra TwinTop Tigra TwinTop	
<b>1 987 482 141</b>	1677	OPEL VAUXHALL	Zafira Zafira	
<b>1 987 482 142</b>	1525	RENAULT	Kangoo I	
<b>1 987 482 144</b>	1740	RENAULT	Espace III	

<b>1 987 482 145</b>	1585	NISSAN OPEL RENAULT VAUXHALL	Primastar Vivaro Trafic II Vivaro	
<b>1 987 482 146</b>	600	OPEL RENAULT VAUXHALL	Vivaro Trafic II Vivaro	
<b>1 987 482 147</b>	1627	FIAT	Croma	
<b>1 987 482 148</b>	2674	IVECO	Daily Chassi, Daily Furgao, Daily MaxiVan	
<b>1 987 482 149</b>	1445	FIAT	Tempra, Tempra SW, Tipo	
<b>1 987 482 150</b>	1287	NISSAN	Micra	
<b>1 987 482 151</b>	1310	NISSAN	Micra	
<b>1 987 482 152</b>	1355	FORD NISSAN	Maverick Terrano II	
<b>1 987 482 153</b>	1660	MAZDA	323, 323 Hatchback	
<b>1 987 482 154</b>	1640	MAZDA	323, 323 Hatchback	
<b>1 987 482 155</b>	1580	TOYOTA	Yaris	
<b>1 987 482 156</b>	1553	TOYOTA	Yaris	
<b>1 987 482 157</b>	319	TOYOTA	Avensis Verso, Picnic	
<b>1 987 482 158</b>	1868	TOYOTA	Avensis, Avensis Liftback, Avensis Wagon	
<b>1 987 482 159</b>	1824	TOYOTA	Avensis, Avensis Liftback, Avensis Wagon	
<b>1 987 482 160</b>	1735	TOYOTA	Camry, Camry Wagon	
<b>1 987 482 161</b>	1513	TOYOTA	Previa	
<b>1 987 482 162</b>	956	TOYOTA	Previa	
<b>1 987 482 163</b>	1510	MITSUBISHI PROTON	Lancer, Lancer Sedan Arena Pickup, Wira Aeroback	
<b>1 987 482 164</b>	1503	HYUNDAI	Accent, Accent Hatchback, Excel, Pony	
<b>1 987 482 165</b>	1503	HYUNDAI	Accent, Accent Hatchback, Excel, Pony	
<b>1 987 482 166</b>	1593	HYUNDAI	Elantra, Elantra Hatchback	
<b>1 987 482 167</b>	1578	HYUNDAI	Elantra, Elantra Hatchback	
<b>1 987 482 168</b>	1578	HYUNDAI	Avante, Elantra, Lantra, Lantra Kombi	
<b>1 987 482 169</b>	1571	HYUNDAI	Avante, Elantra, Lantra, Lantra Kombi	
<b>1 987 482 170</b>	1500	OPEL VAUXHALL	Frontera Frontera	
<b>1 987 482 171</b>	1500	OPEL VAUXHALL	Frontera Frontera	
<b>1 987 482 172</b>	1654	DAEWOO	Nubira, Nubira Hatchback, Nubira Station Wagon	

nl

Remkabels  
(vervolg)

sv

Bromsvajrar  
(fortsättning)

pt

Cabos do travão  
(continuação)



cs

Brzdová lana  
(pokračování)

ru

Тросы тормозного  
привода  
(продолжение)

				
<b>1 987 482 173</b>	1578	DAEWOO	Nubira, Nubira Hatchback, Nubira Station Wagon	
<b>1 987 482 174</b>	1603	DAEWOO	Nubira, Nubira Hatchback, Nubira Station Wagon	
<b>1 987 482 176</b>	1512	SUZUKI	Ignis Hatchback	
<b>1 987 482 177</b>	1461	ALFA ROMEO	145, 146	
<b>1 987 482 178</b>	1419	ALFA ROMEO	145, 146	
<b>1 987 482 179</b>	1454	FIAT	Bravo, Marea	
<b>1 987 482 180</b>	1459	FIAT	Brava, Marea, Marea Weekend, Marengo	
<b>1 987 482 181</b>	2081	FIAT	Multipla	
<b>1 987 482 182</b>	1220	FIAT	Multipla	
<b>1 987 482 183</b>	1876	MITSUBISHI	Galant, Galant Station Wagon	
<b>1 987 482 184</b>	1340	SUZUKI	Vitara, Vitara Cabrio, X-90	
<b>1 987 482 185</b>	2326	FIAT	Multipla	
<b>1 987 482 186</b>	1271	FIAT	Multipla	
<b>1 987 482 187</b>	1630	AUDI VW (VOLKSWAGEN)	Maxxum, Q7 Touareg	
<b>1 987 482 188</b>	337	FORD	C-MAX, Focus C-MAX, Focus II, Focus II Cabriolet, Focus II Turnier	
		VOLVO	C30, C70 II Cabrio, S40 II, V50	
<b>1 987 482 189</b>	1860	FORD	C-MAX, Focus, Focus II, Focus II Turnier, Focus Sedan	
<b>1 987 482 190</b>	2033	CITROEN PEUGEOT	C4, DS4 308, 308 CC	
<b>1 987 482 191</b>	1645	SEAT SKODA VW (VOLKSWAGEN)	Cordoba, Ibiza Fabia, Fabia Combi, Fabia Schrägheck Polo, Polo Limousine	
<b>1 987 482 193</b>	1882	SKODA	Praktik, Roomster	
<b>1 987 482 194</b>	1083	FORD	Transit	
<b>1 987 482 195</b>	1534	FORD	Transit	
<b>1 987 482 198</b>	1460	OPEL VAUXHALL	Corsa Corsa	
<b>1 987 482 199</b>	1450	FIAT	Panda, 500, 500C	
<b>1 987 482 2..</b>				
<b>1 987 482 200</b>	1425	FIAT	Panda, 500, 500C	
<b>1 987 482 201</b>	1506	FIAT	Panda, 500, 500C	
<b>1 987 482 202</b>	1491	FIAT	Panda, 500, 500C	

				
<b>1 987 482 203</b>	1725	FIAT	Linea	
<b>1 987 482 204</b>	1712	FIAT	Linea	
<b>1 987 482 205</b>	1695	CITROEN FIAT PEUGEOT	Nemo Fiorino, Qubo Bipper	
<b>1 987 482 206</b>	1662	CITROEN FIAT PEUGEOT	Nemo Fiorino, Qubo Bipper	
<b>1 987 482 207</b>	1710	CITROEN FIAT PEUGEOT	Nemo Fiorino, Qubo Bipper	
<b>1 987 482 208</b>	1677	CITROEN FIAT PEUGEOT	Nemo Fiorino, Qubo Bipper	
<b>1 987 482 209</b>	1718	HYUNDAI	Matrix	
<b>1 987 482 210</b>	1650	HYUNDAI	Matrix	
<b>1 987 482 211</b>	1475	SUZUKI	Alto	
<b>1 987 482 213</b>	1390	CITROEN FIAT	Jumper Ducato, Ducato 11, Ducato 15, Ducato 17, Ducato 20, Ducato 110, Ducato 115, Ducato 130, Ducato 150, Ducato 180	
<b>1 987 482 214</b>	1485	CITROEN FIAT PEUGEOT	Jumper Ducato 11, Ducato 15, Ducato 17, Ducato 20, Ducato 110, Ducato 115, Ducato 130, Ducato 150, Ducato 180 Boxer	
<b>1 987 482 219</b>	1664	TOYOTA	Limo, Yaris Verso	
<b>1 987 482 220</b>	1604	TOYOTA	Limo, Yaris Verso	
<b>1 987 482 221</b>	1556	DAIHATSU TOYOTA	Charade Yaris	
<b>1 987 482 222</b>	1634	DAIHATSU TOYOTA	Charade Yaris	
<b>1 987 482 223</b>	1584	HYUNDAI	Getz	
<b>1 987 482 224</b>	1593	HYUNDAI	Getz	
<b>1 987 482 225</b>	335	KIA	Sportage	

de

**Bremsseile**  
(Fortsetzung)

en

**Brake cables**  
(continued)

fr

**Câbles de frein  
de stationnement**  
(suite)

it

**Cavi del freno  
di stazionamento**  
(seguito)

es

**Cables de freno  
de mano**  
(continuación)



<b>1 987 482 226</b>	1402	MINI (BMW)	Cooper, Cooper Cabrio, Cooper Coupé, Cooper One, Cooper One Cabrio, Cooper Roadster, John Cooper Works, John Cooper Works Cabrio, John Cooper Works Coupé, John Cooper Works Roadster	
<b>1 987 482 227</b>	1393	MINI (BMW)	Cooper, Cooper Cabrio, Cooper Coupé, Cooper One, Cooper One Cabrio, Cooper Roadster, John Cooper Works, John Cooper Works Cabrio, John Cooper Works Coupé, John Cooper Works Roadster	
<b>1 987 482 228</b>	1483	MINI (BMW)	Cooper Clubman, Cooper Clubvan, Cooper One Clubman, John Cooper Works Clubman	
<b>1 987 482 229</b>	1474	MINI (BMW)	Cooper Clubman, Cooper Clubvan, Cooper One Clubman, John Cooper Works Clubman	
<b>1 987 482 230</b>	1435	MINI (BMW)	Cooper, Cooper Cabrio, Cooper One, Cooper One Cabrio, Cooper S, John Cooper Works, John Cooper Works Cabrio	
<b>1 987 482 231</b>	1433	MINI (BMW)	Cooper, Cooper Cabrio, Cooper One, Cooper One Cabrio, Cooper S, John Cooper Works, John Cooper Works Cabrio	
<b>1 987 482 233</b>	1993	DACIA	Logan, Logan MCV, Logan Pick-Up	
		TOYOTA	Rush	

<b>1 987 482 234</b>	1658	DACIA	Sandero	
		RENAULT	Logan, Logan MCV, Sandero	
<b>1 987 482 235</b>	1255	CITROEN	C8	
		FIAT	Ulysse	
		LANCIA	Phedra	
		PEUGEOT	807	
<b>1 987 482 236</b>	1457	FIAT	Panda	
<b>1 987 482 237</b>	1437	FIAT	Panda	
<b>1 987 482 238</b>	1618	FIAT	Idea	
<b>1 987 482 239</b>	408	LANCIA	Delta, Musa	
<b>1 987 482 240</b>	1430	FORD	Fiesta VI	
<b>1 987 482 241</b>	2071	FORD	Ka	
<b>1 987 482 242</b>	2071	FORD	Galaxy, Mondeo IV, Mondeo IV Turnier, S-MAX	
<b>1 987 482 245</b>	1588	MITSUBISHI	Carisma, Carisma Hatchback	
<b>1 987 482 246</b>	1525	MITSUBISHI	Carisma, Carisma Hatchback	
<b>1 987 482 247</b>	1525	MITSUBISHI	Colt	
<b>1 987 482 251</b>	217	OPEL	Corsa	
		VAUXHALL	Corsa	
<b>1 987 482 253</b>	1970	RENAULT	Kangoo II	
<b>1 987 482 254</b>	1825	LAND ROVER GROUP	Range Rover III	
<b>1 987 482 255</b>	1850	LAND ROVER GROUP	Range Rover III	
<b>1 987 482 256</b>	2025	SAAB (SAAB AUTOMOBILE AB)	9000	
<b>1 987 482 257</b>	1585	SUZUKI	Liana Hatchback, Liana Sedan	
<b>1 987 482 258</b>	1635	SUZUKI	Liana Hatchback, Liana Sedan	
<b>1 987 482 259</b>	388	TOYOTA	Celica Coupé	
<b>1 987 482 260</b>	1707	TOYOTA	Celica Coupé	
<b>1 987 482 261</b>	1672	TOYOTA	Celica Coupé	
<b>1 987 482 262</b>	1695	VOLVO	C70 Coupé, C70 I Cabrio	
<b>1 987 482 264</b>	1561	VW (VOLKSWAGEN)	Touran, Touuran	
<b>1 987 482 265</b>	1590	SKODA	Superb	
<b>1 987 482 266</b>	1588	SEAT	Ibiza, Ibiza SC, Ibiza ST	
		SKODA	Fabia, Fabia Combi	
		VW (VOLKSWAGEN)	Polo	
<b>1 987 482 267</b>	1642	AUDI	A1, A1 Sportback	
		SEAT	Ibiza, Ibiza SC, Ibiza ST	
		VW (VOLKSWAGEN)	Polo	

nl

Remkabels  
(vervolg)

sv

Bromsvajrar  
(fortsättning)

pt

Cabos do travão  
(continuação)



cs

Brzdová lana  
(pokračování)

ru

Тросы тормозного  
привода  
(продолжение)

				
<b>1 987 482 268</b>	1723	AUDI	80, 80 Avant	
<b>1 987 482 269</b>	1723	AUDI	80, 80 Avant	
<b>1 987 482 270</b>	1576	KIA	Cerato, Cerato Hatchback	
<b>1 987 482 271</b>	1540	MITSUBISHI	Colt, Colt Cabrio	
		SMART (MCC)	Forfour	
<b>1 987 482 272</b>	1570	MITSUBISHI	Colt, Colt Cabrio	
		SMART (MCC)	Forfour	
<b>1 987 482 273</b>	336	TOYOTA	Auris	
<b>1 987 482 274</b>	1627	CITROEN	C-Crosser	
		MITSUBISHI	Outlander	
		PEUGEOT	4007	
<b>1 987 482 275</b>	1645	CITROEN	C-Crosser	
		MITSUBISHI	Outlander	
		PEUGEOT	4007	
<b>1 987 482 276</b>	2402	CITROEN	Berlingo	
		PEUGEOT	Partner	
<b>1 987 482 277</b>	1532	FORD	Transit, Transit Euroline, Transit Nugget, Transit Tourneo	
<b>1 987 482 278</b>	162	FORD	Fiesta VI	
		MAZDA	2	
<b>1 987 482 279</b>	360	FORD	C-MAX, Kuga	
<b>1 987 482 280</b>	1848	FORD	Focus II, Kuga	
<b>1 987 482 281</b>	1266	FORD	Transit, Transit Euroline, Transit Nugget, Transit Tourneo	
<b>1 987 482 282</b>	1478	OPEL	Corsa	
		VAUXHALL	Corsa	
<b>1 987 482 283</b>	1463	OPEL	Corsa	
		VAUXHALL	Corsa	
<b>1 987 482 284</b>	2160	VOLVO	XC90, XC90 I	
<b>1 987 482 285</b>	1662	ALFA ROMEO	Brera, Spider	
<b>1 987 482 286</b>	1577	ALFA ROMEO	Brera, Spider	
<b>1 987 482 287</b>	2140	FIAT	Doblo Cargo	
<b>1 987 482 288</b>	2140	FIAT	Doblo Cargo	
<b>1 987 482 289</b>	1528	FIAT	Linea	
<b>1 987 482 290</b>	1520	FIAT	Linea	
<b>1 987 482 291</b>	1800	VAUXHALL	Vectra Estate	
<b>1 987 482 292</b>	1887	OPEL	Vivaro	
		VAUXHALL	Vivaro	
<b>1 987 482 293</b>	1431	CHEVROLET	Captiva	
		OPEL	Antara	
		VAUXHALL	Antara	
<b>1 987 482 294</b>	1454	CHEVROLET	Captiva	
		OPEL	Antara	
		VAUXHALL	Antara	
<b>1 987 482 296</b>	1583	TOYOTA	MR2 Cabrio	
<b>1 987 482 297</b>	1823	TOYOTA	Avensis, Avensis Liftback, Avensis Wagon	
<b>1 987 482 299</b>	1575	TOYOTA	MR2 Cabrio	

				
<b>1 987 482 3..</b>				
<b>1 987 482 300</b>	1770	TOYOTA	Avensis, Avensis Liftback, Avensis Wagon	
<b>1 987 482 301</b>	728	MERCEDES-BENZ	Serie C, Serie C (Coupé), Serie C (T-Modell), Serie E (Cabrio), Serie E (Coupe), Serie E (Coupé)	
<b>1 987 482 302</b>	1883	RENAULT	Megane III Coupé, Megane III Hatchback, Megane III Hatchback	
<b>1 987 482 303</b>	2224	NISSAN	Primera, Primera Hatchback, Primera Wagon	
		RENAULT	Laguna III, Laguna III Coupé, Laguna III Grandtour	
<b>1 987 482 304</b>	1778	NISSAN	Primera, Primera Hatchback, Primera Wagon	
<b>1 987 482 306</b>	1688	TOYOTA	Corolla, Corolla Altis, Corolla Sedan, Corolla Verso, Corolla Wagon, Starlet	
<b>1 987 482 307</b>	1616	TOYOTA	Corolla, Corolla Altis, Corolla Sedan, Corolla Verso, Corolla Wagon, Starlet	
<b>1 987 482 308</b>	1273	RENAULT	Twingo II	
<b>1 987 482 309</b>	1355	RENAULT	Twingo II	
<b>1 987 482 310</b>	1152	AUDI	A2	
<b>1 987 482 312</b>	1374	MERCEDES-BENZ	Sprinter	
<b>1 987 482 313</b>	1573	LAND ROVER GROUP	Freelander II, Freelander 2	
<b>1 987 482 314</b>	1578	LAND ROVER GROUP	Freelander II, Freelander 2	
<b>1 987 482 315</b>	1703	CITROEN	C3, DS3, DS3 Cabrio	
<b>1 987 482 316</b>	1706	CITROEN	C3, DS3, DS3 Cabrio	
<b>1 987 482 317</b>	1803	CITROEN	C3, DS3, DS3 Cabrio	
<b>1 987 482 318</b>	1910	CITROEN	C3 Picasso	
<b>1 987 482 319</b>	1860	CITROEN	Xsara Picasso	
<b>1 987 482 320</b>	1950	CITROEN	Xsara Picasso	
<b>1 987 482 323</b>	1907	PEUGEOT	207, 207 CC, 207 SW, 208, 2008	
<b>1 987 482 324</b>	2128	PEUGEOT	308 SW	
<b>1 987 482 325</b>	1940	RENAULT	Megane III Grandtour	
<b>1 987 482 326</b>	1610	VW (VOLKSWAGEN)	Touran	
<b>1 987 482 328</b>	1615	VW (VOLKSWAGEN)	Caddy	

de

**Bremseile**  
(Fortsetzung)

en

**Brake cables**  
(continued)

fr

**Câbles de frein  
de stationnement**  
(suite)

it

**Cavi del freno  
di stazionamento**  
(seguito)

es

**Cables de freno  
de mano**  
(continuación)



<b>1 987 482 329</b>	743	MERCEDES-BENZ	Serie C (Coupé), Serie CLS (Coupé), Serie CLS (Shooting Brake), Serie E, Serie E (T-Modell), Serie E (T-Modell)	
<b>1 987 482 330</b>	1637	MERCEDES-BENZ	Serie C, Serie C (Coupé), Serie C (T-Modell), Serie E (Cabrio), Serie E (Coupe), Serie E (Coupé)	
<b>1 987 482 331</b>	2057	MERCEDES-BENZ	Serie C, Serie C (Coupé), Serie C (T-Modell), Serie E (Cabrio), Serie E (Coupe), Serie E (Coupé)	
<b>1 987 482 332</b>	1152	MERCEDES-BENZ	Serie C, Serie C (Coupé), Serie C (T-Modell), Serie E (Cabrio), Serie E (Coupe), Serie E (Coupé)	
<b>1 987 482 333</b>	2005	OPEL VAUXHALL	Insignia, Insignia Sports Tourer Insignia, Insignia Sports Tourer	
<b>1 987 482 334</b>	1596	RENAULT	Clio III	
<b>1 987 482 335</b>	1458	RENAULT	Clio III	
<b>1 987 482 337</b>	262	NISSAN	Qashqai, Qashqai+2	
<b>1 987 482 338</b>	1703	NISSAN	Qashqai	
<b>1 987 482 339</b>	1705	NISSAN	Qashqai	
<b>1 987 482 340</b>	1833	NISSAN	Qashqai+2	
<b>1 987 482 341</b>	1835	NISSAN	Qashqai+2	
<b>1 987 482 342</b>	317	NISSAN	X-Trail	
<b>1 987 482 343</b>	2250	NISSAN	Hardbody, NP300, Pickup	
<b>1 987 482 344</b>	1730	NISSAN	Hardbody, NP300, Pickup	
<b>1 987 482 346</b>	1698	TOYOTA	iQ	
<b>1 987 482 347</b>	1775	TOYOTA	Prius	
<b>1 987 482 348</b>	1715	TOYOTA	Prius	
<b>1 987 482 349</b>	1615	HYUNDAI	i20	
<b>1 987 482 350</b>	1648	HYUNDAI	i20	
<b>1 987 482 351</b>	1750	SUBARU	Legacy, Legacy Kombi, Legacy Outback, Legacy Station Wagon, Legacy Station Wagoni, Outback	
<b>1 987 482 352</b>	1750	SUBARU	Legacy, Legacy Kombi, Legacy Outback	

<b>1 987 482 353</b>	1615	CHEVROLET DAEWOO	Lacetti, Nubira, Nubira Wagon, Optra Hatchback Lacetti, Nubira, Nubira Station Wagon	
<b>1 987 482 354</b>	1567	CHEVROLET DAEWOO	Lacetti, Nubira, Nubira Wagon, Optra Hatchback Lacetti, Nubira, Nubira Station Wagon	
<b>1 987 482 356</b>	1810	SUZUKI	Swift Hatchback	
<b>1 987 482 357</b>	1814	SUZUKI	Swift Hatchback	
<b>1 987 482 358</b>	1588	HYUNDAI KIA	Accent, Accent Hatchback Rio, Rio Hatchback	
<b>1 987 482 359</b>	1588	HYUNDAI KIA	Accent, Accent Hatchback Rio, Rio Hatchback	
<b>1 987 482 360</b>	1560	KIA	Cerato, Cerato Hatchback	
<b>1 987 482 361</b>	1673	KIA	Cee'd, Cee'd Sporty Wagon, Pro Cee'd	
<b>1 987 482 362</b>	1673	KIA	Cee'd, Cee'd Sporty Wagon, Pro Cee'd	
<b>1 987 482 363</b>	1128	JEEP	Grand Cherokee	
<b>1 987 482 364</b>	1104	JEEP	Grand Cherokee	
<b>1 987 482 365</b>	894	JEEP	Cherokee	
<b>1 987 482 366</b>	1274	TOYOTA	RAV4	
<b>1 987 482 367</b>	1274	TOYOTA	RAV4	
<b>1 987 482 368</b>	1558	BMW	Serie X	
<b>1 987 482 369</b>	306	FORD	Focus III, Focus III Turnier	
<b>1 987 482 370</b>	230	FORD	Focus, Focus ECO IV, Focus III, Focus III Turnier, Focus IV, Focus IV Turnier, Focus Turnier	
<b>1 987 482 371</b>	367	FORD	C-MAX	
<b>1 987 482 372</b>	829	CITROEN PEUGEOT	C4, DS4 3008	
<b>1 987 482 373</b>	2238	PEUGEOT	508, 508 SW	
<b>1 987 482 374</b>	1528	SEAT SKODA	Mii Citigo	
<b>1 987 482 375</b>	1518	SEAT SKODA VW (VOLKSWAGEN)	Mii Citigo up!	
<b>1 987 482 376</b>	1631	VW (VOLKSWAGEN)	California T5, Caravelle T5, Multivan T5, Transporter T5	
<b>1 987 482 377</b>	1705	VW (VOLKSWAGEN)	Caddy	

nl

Remkabels  
(vervolg)

sv

Bromsvajrar  
(fortsättning)

pt

Cabos do travão  
(continuação)



cs

Brzdová lana  
(pokračování)

ru

Тросы тормозного  
привода  
(продолжение)

				
<b>1 987 482 378</b>	1718	VW (VOLKSWAGEN)	Caddy, Caddy Panel Van	
<b>1 987 482 379</b>	1598	VW (VOLKSWAGEN)	Jetta	
<b>1 987 482 380</b>	1805	MERCEDES-BENZ	Sprinter	
<b>1 987 482 381</b>	2462	MERCEDES-BENZ	Sprinter	
<b>1 987 482 382</b>	187	OPEL	Astra, Astra Caravan, Astra GTC, Astra TwinTop	
		VAUXHALL	Astra, Astra GTC	
<b>1 987 482 383</b>	1440	RENAULT	Clio III, Clio III Grandtour, Modus	
<b>1 987 482 384</b>	1572	RENAULT	Clio III, Clio III Grandtour, Modus	
<b>1 987 482 385</b>	1322	RENAULT	Clio III, Clio III Grandtour, Modus	
<b>1 987 482 386</b>	1448	RENAULT	Clio III, Clio III Grandtour, Modus	
<b>1 987 482 387</b>	1498	NISSAN	Primastar	
<b>1 987 482 389</b>	1430	FIAT	Panda	
<b>1 987 482 390</b>	1403	FIAT	Panda	
<b>1 987 482 391</b>	1437	FIAT	Panda	
<b>1 987 482 392</b>	1427	FIAT	Panda	
<b>1 987 482 393</b>	1535	LANCIA	Ypsilon	
<b>1 987 482 394</b>	1535	LANCIA	Ypsilon	
<b>1 987 482 395</b>	985	NISSAN	Cabstar	
<b>1 987 482 397</b>	898	NISSAN	Cabstar	
<b>1 987 482 398</b>	898	NISSAN	Cabstar	
<b>1 987 482 399</b>	1573	MINI	Spacestar	
<b>1 987 482 4..</b>				
<b>1 987 482 400</b>	1551	MINI	Spacestar	
<b>1 987 482 401</b>	1720	MINI	L 200	
<b>1 987 482 402</b>	2360	MINI	L 200	
<b>1 987 482 403</b>	2302	FIAT	Freemont	
<b>1 987 482 404</b>	1177	FIAT	Freemont	
<b>1 987 482 407</b>	1775	CITROEN	Xsara Picasso	
<b>1 987 482 408</b>	1864	CITROEN	Xsara Picasso	
<b>1 987 482 409</b>	2268	CITROEN	C5, C5 Tourer	
<b>1 987 482 410</b>	1787	DACIA	Duster	
		RENAULT	Duster	
<b>1 987 482 411</b>	1720	DACIA	Duster	
		RENAULT	Duster	
<b>1 987 482 420</b>	1910	MAZDA	3, 3 Hatchback	
<b>1 987 482 421</b>	408	MAZDA	2	
<b>1 987 482 422</b>	1360	MAZDA	2	
<b>1 987 482 423</b>	1028	SMART (MCC)	Fortwo Cabrio, Fortwo Coupé, Fortwo ED Cabrio, Fortwo ED Coupé	
<b>1 987 482 424</b>	2211	NISSAN	Navara	

				
<b>1 987 482 425</b>	2440	NISSAN	Navara	
<b>1 987 482 427</b>	1600	OPEL	Agila	
		SUZUKI	Splash	
		VAUXHALL	Agila	
<b>1 987 482 428</b>	1600	OPEL	Agila	
		SUZUKI	Splash	
		VAUXHALL	Agila	
<b>1 987 482 429</b>	970	CITROEN	DS5	
		PEUGEOT	3008, 5008	
<b>1 987 482 430</b>	935	CITROEN	DS5	
		PEUGEOT	3008, 5008	
<b>1 987 482 431</b>	1304	PORSCHE	911, 911 Cabriolet, 911 Speedster, 911 Targa	
<b>1 987 482 432</b>	1960	RENAULT	Grand Scenic III	
<b>1 987 482 433</b>	1897	RENAULT	Scenic III	
<b>1 987 482 434</b>	1797	FIAT	Sedici	
		SUZUKI	SX4 Hatchback	
<b>1 987 482 435</b>	1787	FIAT	Sedici	
		SUZUKI	SX4 Hatchback	
<b>1 987 482 438</b>	1920	TOYOTA	Auris, Auris Touring Sports	
<b>1 987 482 439</b>	1665	TOYOTA	Auris, Auris Touring Sports	
<b>1 987 482 440</b>	1892	TOYOTA	Urban Cruiser, Yaris	
<b>1 987 482 441</b>	1617	TOYOTA	Urban Cruiser, Yaris	
<b>1 987 482 442</b>	1648	TOYOTA	Yaris	
<b>1 987 482 443</b>	1690	TOYOTA	Yaris	
<b>1 987 482 444</b>	1890	AUDI	Maxxum, Q7	
		VW (VOLKSWAGEN)	Touareg	
<b>1 987 482 445</b>	1447	AUDI	A3, A3 Sportback	
		SEAT	Altea, Leon, Leon Cupra, Toledo	
		SKODA	Octavia, Octavia Combi	
		VW (VOLKSWAGEN)	Golf Plus, Golf V, Jetta	
<b>1 987 482 446</b>	1580	SEAT	Cordoba, Ibiza	
		SKODA	Fabia, Fabia Combi, Fabia Schrägheck	
		VW (VOLKSWAGEN)	Fox, Polo, Polo Vivo	
<b>1 987 482 447</b>	2910	CITROEN	Jumper	
		FIAT	Ducato, Ducato 11, Ducato 15, Ducato 17, Ducato 20, Ducato 110, Ducato 115, Ducato 130, Ducato 150, Ducato 180	
		PEUGEOT	Boxer	



de

**Bremseile**  
(Fortsetzung)

en

**Brake cables**  
(continued)

fr

**Câbles de frein  
de stationnement**  
(suite)

it

**Cavi del freno  
di stazionamento**  
(seguito)

es

**Cables de freno  
de mano**  
(continuación)



<b>1 987 482 449</b>	182	OPEL	Astra, Astra Caravan, Astra GTC, Astra TwinTop, Combo, Zafira	
			VAUXHALL	Astra GTC, Combo, Corsa
<b>1 987 482 450</b>	1908	CITROEN	Jumper	
		FIAT	Ducato, Ducato 11, Ducato 15, Ducato 17, Ducato 20, Ducato 110, Ducato 115, Ducato 130, Ducato 150, Ducato 180	
		PEUGEOT	Boxer	
<b>1 987 482 451</b>	1645	SKODA	Fabia, Fabia Combi, Fabia RS	
<b>1 987 482 453</b>	1362	FORD	B-Max, Fiesta VI, Fiesta VII	
<b>1 987 482 454</b>	1482	VW (VOLKSWAGEN)	Beetle	
<b>1 987 482 455</b>	1498	VW (VOLKSWAGEN)	Beetle, Beetle Cabriolet	
<b>1 987 482 456</b>	1463	SEAT	Leon, Leon Cupra, Leon Cupra SC, Leon SC, Leon ST, Leon ST Cupra	
<b>1 987 482 457</b>	1707	SEAT	Toledo	
		SKODA	Rapid, Rapid Spaceback	
<b>1 987 482 458</b>	1780	SEAT	Toledo	
		SKODA	Rapid, Rapid Spaceback	
<b>1 987 482 459</b>	1390	CHEVROLET	Aveo, Aveo Hatchback	
<b>1 987 482 461</b>	217	OPEL	Corsa	
		VAUXHALL	Corsa	
<b>1 987 482 463</b>	1657	SUBARU	Trezia	
		TOYOTA	Verso-S	
<b>1 987 482 464</b>	1695	SUBARU	Trezia	
		TOYOTA	Verso-S	
<b>1 987 482 465</b>	1638	FIAT	Sedici	
		SUZUKI	SX4 Hatchback	
<b>1 987 482 466</b>	1638	FIAT	Sedici	
		SUZUKI	SX4 Hatchback	
<b>1 987 482 490</b>	1130	MERCEDES-BENZ	Serie A	
<b>1 987 482 491</b>	1584	BMW	Serie 3, Serie 3 GT, Serie 3 Touring, Serie 4 Cabrio, Serie 4 Coupé, Serie 4 GC	
			Serie 1, Serie 2 Cabrio, Serie 2 Coupé	

<b>1 987 482 493</b>	1558	BMW	Serie X	
<b>1 987 482 494</b>	1992	FORD	C-MAX	
<b>1 987 482 495</b>	1790	PEUGEOT	208	
<b>1 987 482 497</b>	1883	MERCEDES-BENZ	Serie E, Serie E (T-Modell)	
			Serie G	
<b>1 987 482 499</b>	2374	MERCEDES-BENZ	Serie G	
<b>1 987 482 5..</b>				
<b>1 987 482 500</b>	2230	MERCEDES-BENZ	Serie G	
<b>1 987 482 501</b>	1270	MERCEDES-BENZ	Serie V, Vito	
<b>1 987 482 502</b>	1814	OPEL	Astra, Astra Limousine, Astra Sporte Tourer, Astra Sports Tourer	
		VAUXHALL	Astra, Astra Sport Tourer, Astra Sports Tourer	
<b>1 987 482 503</b>	1812	CHEVROLET	Cruze, Cruze Hatchback	
		OPEL	Astra, Astra Limousine, Astra Sporte Tourer, Astra Sports Tourer	
		VAUXHALL	Astra, Astra Sport Tourer, Astra Sports Tourer	
<b>1 987 482 504</b>	1460	CHEVROLET	Cruze	
<b>1 987 482 506</b>	206	CHEVROLET	Cruze	
<b>1 987 482 507</b>	1810	CHEVROLET	Cruze, Cruze Hatchback, Cruze Station Wagon	
			Cruze, Cruze Hatchback, Cruze Station Wagon	
<b>1 987 482 508</b>	1803	CHEVROLET	Cruze, Cruze Hatchback, Cruze Station Wagon	
<b>1 987 482 509</b>	1778	FIAT	500L	
<b>1 987 482 512</b>	1558	TOYOTA	Vitz, Yaris	
<b>1 987 482 513</b>	1600	TOYOTA	Vitz, Yaris	
<b>1 987 482 514</b>	244	MITSUBISHI	L 200, Pajero Sport	
<b>1 987 482 515</b>	2023	MITSUBISHI	L 200	
<b>1 987 482 516</b>	2018	MITSUBISHI	L 200	
<b>1 987 482 517</b>	1645	MITSUBISHI	ASX, Outlander	
<b>1 987 482 518</b>	1627	MITSUBISHI	ASX, Outlander	
<b>1 987 482 519</b>	1632	MITSUBISHI	ASX, Outlander	
<b>1 987 482 520</b>	1596	MITSUBISHI	Lancer, Lancer Ralliart, Lancer Sportback	
			Lancer, Lancer Ralliart, Lancer Sportback	
<b>1 987 482 521</b>	1620	MITSUBISHI	Lancer, Lancer Ralliart, Lancer Sportback	
<b>1 987 482 522</b>	1403	CHEVROLET	Spark	
<b>1 987 482 523</b>	1445	CHEVROLET	Spark	
<b>1 987 482 524</b>	1245	OPEL	Vivaro	
		VAUXHALL	Vivaro	
<b>1 987 482 525</b>	1643	OPEL	Vivaro	
		VAUXHALL	Vivaro	



**0 265 001 ...**

<b>0 265 001 057</b>	BMW	Serie 3 Touring
<b>0 265 001 058</b>	BMW	Serie 3 Touring
<b>0 265 001 059</b>	BMW	Serie 3 Touring
<b>0 265 001 068</b>	RENAULT	Espace II
<b>0 265 001 069</b>	RENAULT	Espace II
<b>0 265 001 094</b>	JAGUAR	XJ 6
<b>0 265 001 095</b>	JAGUAR	XJ 6
<b>0 265 001 096</b>	JAGUAR	XJ 6
<b>0 265 001 118</b>	PORSCHE	928
<b>0 265 001 126</b>	MERCEDES-BENZ	Serie E, 2t
<b>0 265 001 128</b>	MERCEDES-BENZ	Serie E
<b>0 265 001 134</b>	OPEL VAUXHALL	Omega Carlton III
<b>0 265 001 143</b>	OPEL VAUXHALL	Omega Carlton III
<b>0 265 001 165</b>	CHEVROLET	Corvette Cabrio, Corvette Coupé
<b>0 265 001 166</b>	CHEVROLET	Corvette Cabrio, Corvette Coupé
<b>0 265 001 184</b>	VOLVO	740
<b>0 265 001 206</b>	OPEL VAUXHALL	Calibra, Vectra Calibra, Cavalier III
<b>0 265 001 207</b>	OPEL VAUXHALL	Vectra Cavalier III
<b>0 265 001 208</b>	OPEL VAUXHALL	Vectra Cavalier III
<b>0 265 001 215</b>	FIAT LANCIA	Marengo, Tempra, Tempra SW, Tipo Dedra Berlina, Dedra Station Wagon
<b>0 265 001 216</b>	FIAT LANCIA	Marengo, Tempra, Tempra SW, Tipo Dedra Berlina, Dedra Station Wagon
<b>0 265 001 217</b>	FIAT LANCIA	Marengo, Tempra, Tempra SW, Tipo Dedra Berlina, Dedra Station Wagon
<b>0 265 001 220</b>	OPEL VAUXHALL	Omega Carlton III
<b>0 265 001 226</b>	OPEL VAUXHALL	Calibra, Vectra Calibra, Cavalier III
<b>0 265 001 231</b>	VOLVO	740, 940, 960
<b>0 265 001 232</b>	OPEL VAUXHALL	Calibra, Vectra Calibra, Cavalier III
<b>0 265 001 233</b>	OPEL VAUXHALL	Calibra, Vectra Calibra, Cavalier III
<b>0 265 001 242</b>	RENAULT	Espace II
<b>0 265 001 246</b>	LANCIA	Delta
<b>0 265 001 247</b>	LANCIA	Delta
<b>0 265 001 248</b>	LANCIA	Delta
<b>0 265 001 249</b>	LANCIA	Delta
<b>0 265 001 267</b>	ALFA ROMEO	33 Berlina, 33 Sportwagon

<b>0 265 001 268</b>	ALFA ROMEO	33 Berlina, 33 Sportwagon
<b>0 265 001 269</b>	JAGUAR	XJ 12
<b>0 265 001 270</b>	JAGUAR	XJ 12
<b>0 265 001 271</b>	JAGUAR	XJ 12
<b>0 265 001 272</b>	JAGUAR	XJ 12
<b>0 265 001 273</b>	NISSAN	Primera Hatchback, Primera Sedan, Primera Wagon
<b>0 265 001 274</b>	NISSAN	Primera Hatchback, Primera Sedan, Primera Wagon
<b>0 265 001 275</b>	NISSAN	Primera Hatchback, Primera Sedan, Primera Wagon
<b>0 265 001 276</b>	NISSAN	Primera Hatchback, Primera Sedan, Primera Wagon
<b>0 265 001 282</b>	MERCEDES-BENZ	Serie E, Serie E (Coupé), Serie E (T-Modell)
<b>0 265 001 284</b>	MERCEDES-BENZ	Serie E, Serie E (Coupé), Serie E (T-Modell)
<b>0 265 001 286</b>	MERCEDES-BENZ	Serie 190
<b>0 265 001 288</b>	MERCEDES-BENZ	Serie 190
<b>0 265 001 290</b>	MERCEDES-BENZ	Serie G
<b>0 265 001 292</b>	MERCEDES-BENZ	Serie G
<b>0 265 001 296</b>	MERCEDES-BENZ	Serie CL (Coupé), Serie S, Serie S (Coupé)
<b>0 265 001 298</b>	MERCEDES-BENZ	Serie E, Serie E (T-Modell)
<b>0 265 001 300</b>	MERCEDES-BENZ	Serie E, Serie E (T-Modell)
<b>0 265 001 304</b>	ALFA ROMEO FIAT LANCIA	155 Tempra SW Dedra Berlina
<b>0 265 001 311</b>	RENAULT	Alpine
<b>0 265 001 312</b>	NISSAN	Primera Hatchback, Primera Sedan
<b>0 265 001 313</b>	NISSAN	Primera Hatchback, Primera Sedan
<b>0 265 001 317</b>	NISSAN	Quest
<b>0 265 001 318</b>	NISSAN	Quest
<b>0 265 001 319</b>	NISSAN	Quest
<b>0 265 001 339</b>	BMW	Serie 5, Serie 5 Touring, Serie 7
<b>0 265 001 340</b>	BMW	Serie 5, Serie 5 Touring
<b>0 265 001 348</b>	MERCEDES-BENZ	Serie CL (Coupé), Serie S, Serie S (Coupé)
<b>0 265 001 350</b>	MERCEDES-BENZ	Serie CL (Coupé), Serie S, Serie S (Coupé)
<b>0 265 001 355</b>	ALFA ROMEO	155
<b>0 265 001 380</b>	VOLVO	960
<b>0 265 001 387</b>	FIAT	Punto, Punto Cabrio, Punto GT, Punto Van
<b>0 265 001 398</b>	MERCEDES-BENZ	Serie E, Serie E (T-Modell)

nl

Toerentalsensor

sv

Varvtalssensor

pt



Sensor de velocidade



cs

Snímač otáček

ru

Датчик числа оборотов

		
<b>0 265 001 400</b>	MERCEDES-BENZ	Serie E, Serie E (T-Modell)
<b>0 265 001 402</b>	MERCEDES-BENZ	Serie CL (Coupé), Serie S, Serie S (Coupé)
<b>0 265 001 406</b>	MERCEDES-BENZ	Serie CL (Coupé), Serie S, Serie S (Coupé)
<b>0 265 001 415</b>	NISSAN	Quest
<b>0 265 001 416</b>	TOYOTA	Carina E Liftback, Carina E Sedan, Carina E Wagon
<b>0 265 001 417</b>	TOYOTA	Carina E Liftback, Carina E Sedan, Carina E Wagon
<b>0 265 001 418</b>	TOYOTA	Carina E Liftback, Carina E Sedan, Carina E Wagon
<b>0 265 001 419</b>	TOYOTA	Carina E Liftback, Carina E Sedan, Carina E Wagon
<b>0 265 002 ...</b>		
<b>0 265 002 011</b>	MERCEDES-BENZ	Serie E, Serie E (T-Modell)
<b>0 265 002 108</b>	MERCEDES-BENZ	Serie E
<b>0 265 002 112</b>	MERCEDES-BENZ	Serie SL
<b>0 265 002 114</b>	MERCEDES-BENZ	Serie SL
<b>0 265 002 204</b>	MERCEDES-BENZ	Serie E, Serie E (Cabrio), Serie E (Coupé), Serie E (T-Modell)
<b>0 265 002 206</b>	MERCEDES-BENZ	Serie E, Serie E (Cabrio), Serie E (Coupé), Serie E (T-Modell)
<b>0 265 002 208</b>	MERCEDES-BENZ	Serie E, Serie E (Coupé), Serie E (T-Modell)
<b>0 265 002 210</b>	MERCEDES-BENZ	Serie E, Serie E (Coupé), Serie E (T-Modell)
<b>0 265 002 212</b>	MERCEDES-BENZ	Serie C
<b>0 265 002 214</b>	MERCEDES-BENZ	Serie SL
<b>0 265 002 216</b>	MERCEDES-BENZ	Serie CL (Coupé), Serie S, Serie S (Coupé)
<b>0 265 002 218</b>	MERCEDES-BENZ	Serie CL (Coupé), Serie S, Serie S (Coupé)
<b>0 265 002 220</b>	MERCEDES-BENZ	Serie CL (Coupé), Serie S, Serie S (Coupé)
<b>0 265 002 222</b>	MERCEDES-BENZ	Serie SL
<b>0 265 002 230</b>	MERCEDES-BENZ	Serie 190
<b>0 265 002 232</b>	MERCEDES-BENZ	Serie 190
<b>0 265 002 234</b>	MERCEDES-BENZ	Serie S
<b>0 265 002 238</b>	MERCEDES-BENZ	Serie E

		
<b>0 265 002 244</b>	MERCEDES-BENZ	Serie E (Cabrio)
<b>0 265 002 248</b>	MERCEDES-BENZ	Serie S
<b>0 265 002 254</b>	MERCEDES-BENZ	Serie E (Cabrio)
<b>0 265 002 262</b>	MERCEDES-BENZ	Serie G
	STEYR (STEYR-DAIMLER-PUCH AG)	G
<b>0 265 002 276</b>	LADA	Serie 110
<b>0 265 003 ...</b>		
<b>0 265 003 061</b>	ALFA ROMEO	33 Berlina, 33 Sportwagon
<b>0 265 003 062</b>	ALFA ROMEO	33 Berlina
<b>0 265 003 066</b>	ALFA ROMEO	33 Berlina
<b>0 265 003 075</b>	ALFA ROMEO	164
	FIAT	Croma
	LANCIA	Thema Berlina, Thema Station Wagon
<b>0 265 003 081</b>	PEUGEOT	405, 405 Break
<b>0 265 003 093</b>	CHEVROLET	Calibra
	OPEL	Calibra, Vectra
	VAUXHALL	Calibra, Cavalier III
<b>0 265 003 094</b>	CHEVROLET	Calibra
	OPEL	Calibra, Vectra
	VAUXHALL	Calibra, Cavalier III
<b>0 265 004 ...</b>		
<b>0 265 004 009</b>	MERCEDES-BENZ	Sprinter
	VW (VOLKSWAGEN)	LT
<b>0 265 004 010</b>	MERCEDES-BENZ	Sprinter
	VW (VOLKSWAGEN)	LT
<b>0 265 004 025</b>	IVECO	Daily
<b>0 265 004 042</b>	LAND ROVER GROUP	Defender 90, Defender 110, Defender 130
<b>0 265 004 043</b>	LAND ROVER GROUP	Defender 90, Defender 110
<b>0 265 004 136</b>	ALFA ROMEO	MiTo
	FIAT	Grande Punto, Punto, Punto Evo, Punto Grande, Punto Grande Abarth, Punto Grande Abarth SS
<b>0 265 006 ...</b>		
<b>0 265 006 101</b>	PORSCHE	911
<b>0 265 006 103</b>	ROVER	Serie 800
<b>0 265 006 104</b>	ROVER	Serie 800

de

**Drehzahlsensor**  
(Fortsetzung)

en

**Rotational-speed sensor**  
(continued)

fr

**Capteur de vitesse de rotation**  
(suite)



it

**Sensore giri**  
(seguito)

es

**Sensor de revoluciones**  
(continuación)

		
<b>0 265 006 105</b>	ROVER	Serie 800
<b>0 265 006 106</b>	ROVER	Serie 800
<b>0 265 006 107</b>	PORSCHE	911, 911 Targa
<b>0 265 006 109</b>	MERCEDES-BENZ	Serie E, Serie E (Cabrio), Serie E (Coupé), Serie E (T-Modell)
<b>0 265 006 111</b>	MERCEDES-BENZ	Serie E, Serie E (Cabrio), Serie E (Coupé), Serie E (T-Modell)
<b>0 265 006 116</b>	FERRARI	512
<b>0 265 006 117</b>	FERRARI	512
<b>0 265 006 118</b>	ALFA ROMEO	164
<b>0 265 006 119</b>	ALFA ROMEO	164
<b>0 265 006 120</b>	ALFA ROMEO	164
<b>0 265 006 124</b>	FIAT	Coupé
<b>0 265 006 130</b>	MERCEDES-BENZ	Serie SL
<b>0 265 006 132</b>	MERCEDES-BENZ	Serie SL
<b>0 265 006 133</b>	HYUNDAI	H 100
<b>0 265 006 135</b>	DAEWOO	Musso
	SSANGYONG	Musso
<b>0 265 006 136</b>	DAEWOO	New Prince, Prince, Super Salon
<b>0 265 006 137</b>	DAEWOO	Prince, Super Salon
<b>0 265 006 138</b>	FIAT	Barchetta
	LANCIA	Y
<b>0 265 006 139</b>	FIAT	Punto, Punto Cabrio, Punto GT, Punto Van
	LANCIA	Y
<b>0 265 006 140</b>	FIAT	Punto, Punto Cabrio, Punto GT, Punto Van
	LANCIA	Y
<b>0 265 006 141</b>	PORSCHE	928, 968
<b>0 265 006 142</b>	PORSCHE	968
<b>0 265 006 154</b>	RENAULT	Trafic
<b>0 265 006 155</b>	RENAULT	Trafic
<b>0 265 006 156</b>	RENAULT	Trafic
<b>0 265 006 157</b>	RENAULT	Trafic
<b>0 265 006 160</b>	LANCIA	Kappa Berlina, Kappa Coupé, Kappa Station Wagon
<b>0 265 006 162</b>	ALFA ROMEO	GTV, Spider, 145, 146, 155
	FIAT	Coupé
	LANCIA	Delta
<b>0 265 006 163</b>	FIAT	Palio, Palio Weekend, Siena
<b>0 265 006 164</b>	FIAT	Palio, Palio Weekend, Siena
<b>0 265 006 167</b>	ROVER	Serie 600
<b>0 265 006 168</b>	ROVER	Serie 600
<b>0 265 006 169</b>	ROVER	Serie 600
<b>0 265 006 170</b>	ROVER	Serie 600
<b>0 265 006 172</b>	MERCEDES-BENZ	Serie C, Serie C (T-Modell), Serie CLK (Cabrio), Serie CLK (Coupé)

		
<b>0 265 006 178</b>	MERCEDES-BENZ	Serie E, Serie E (T-Modell)
<b>0 265 006 180</b>	MERCEDES-BENZ	Serie CL (Coupé), Serie S, Serie S (Coupé)
<b>0 265 006 182</b>	MERCEDES-BENZ	Serie CL (Coupé), Serie S, Serie S (Coupé)
<b>0 265 006 184</b>	MERCEDES-BENZ	Serie SL
<b>0 265 006 186</b>	MERCEDES-BENZ	Serie SL
<b>0 265 006 188</b>	MERCEDES-BENZ	Serie E, Serie E (T-Modell)
<b>0 265 006 190</b>	MERCEDES-BENZ	Serie E, Serie E (T-Modell)
<b>0 265 006 192</b>	MERCEDES-BENZ	Serie C, Serie C (T-Modell), Serie CLK (Cabrio), Serie CLK (Coupé)
<b>0 265 006 194</b>	MERCEDES-BENZ	Serie E, Serie E (T-Modell)
<b>0 265 006 197</b>	ALFA ROMEO	145, 146, 155
	FIAT	Coupé, Tempra, Tempra SW
	LANCIA	Dedra Berlina, Dedra Station Wagon, Delta
<b>0 265 006 199</b>	CITROEN	ZX
<b>0 265 006 200</b>	CITROEN	Berlingo
	PEUGEOT	Partner, Ranch, 306, 306 Break, 306 Cabriolet
<b>0 265 006 201</b>	PEUGEOT	Partner, 306, 306 Break, 306 Cabriolet
<b>0 265 006 202</b>	CITROEN	Xsara, Xsara Break, Xsara Coupé, ZX
	PEUGEOT	Partner, 306, 306 Break, 306 Cabriolet
<b>0 265 006 203</b>	CITROEN	Xsara, Xsara Coupé, ZX
	PEUGEOT	306, 306 Cabriolet
<b>0 265 006 204</b>	CITROEN	ZX
	PEUGEOT	306, 306 Cabriolet
<b>0 265 006 205</b>	PEUGEOT	406, 406 Break, 406 Coupé
<b>0 265 006 206</b>	PEUGEOT	406, 406 Break, 406 Coupé
<b>0 265 006 207</b>	PEUGEOT	605
<b>0 265 006 208</b>	PEUGEOT	605
<b>0 265 006 209</b>	CITROEN	Berlingo
	PEUGEOT	Partner, Ranch
<b>0 265 006 210</b>	FIAT	Barchetta
<b>0 265 006 211</b>	FIAT	Barchetta
<b>0 265 006 212</b>	ALFA ROMEO	GTV, Spider, 145, 146, 155
	FIAT	Coupé, Tempra, Tempra SW
	LANCIA	Dedra Berlina, Dedra Station Wagon, Delta
<b>0 265 006 214</b>	MERCEDES-BENZ	Serie V, Vito
<b>0 265 006 215</b>	MERCEDES-BENZ	Serie V, Vito
<b>0 265 006 216</b>	ASTON MARTIN	Virage Coupé

nl

**Toerentalsensor**  
(vervolg)

sv

**Varvtalssensor**  
(fortsättning)

pt

**Sensor de velocidade**  
(continuação)



cs

**Snímač otáček**  
(pokračování)

ru

**Датчик числа оборотов**  
(продолжение)

		
<b>0 265 006 218</b>	VW (VOLKSWAGEN)	Gol III
<b>0 265 006 221</b>	VW (VOLKSWAGEN)	Gol III
<b>0 265 006 222</b>	VW (VOLKSWAGEN)	Gol III
<b>0 265 006 223</b>	MITSUBISHI	Carisma, Carisma Hatchback, Spacestar
	VOLVO	S40 I, V40 I
<b>0 265 006 224</b>	MITSUBISHI	Carisma, Carisma Hatchback, Spacestar
	VOLVO	S40 I, V40 I
<b>0 265 006 225</b>	MITSUBISHI	Carisma Hatchback
<b>0 265 006 230</b>	FORD	Fairlane
<b>0 265 006 232</b>	NISSAN	Primera Hatchback, Primera Sedan, Primera Wagon
<b>0 265 006 233</b>	NISSAN	Primera Hatchback, Primera Sedan, Primera Wagon
<b>0 265 006 236</b>	NISSAN	Primera Hatchback, Primera Sedan, Primera Wagon
<b>0 265 006 237</b>	NISSAN	Primera Hatchback, Primera Sedan, Primera Wagon
<b>0 265 006 238</b>	FIAT	Croma
	LANCIA	Thema Berlina, Thema Station Wagon
<b>0 265 006 242</b>	MERCEDES- BENZ	Serie C
<b>0 265 006 248</b>	MERCEDES- BENZ	Serie C
<b>0 265 006 249</b>	FIAT	Palio, Palio Weekend, Siena
<b>0 265 006 252</b>	FERRARI	456
<b>0 265 006 253</b>	FERRARI	456
<b>0 265 006 254</b>	NISSAN	Micra
<b>0 265 006 255</b>	NISSAN	Micra
<b>0 265 006 256</b>	NISSAN	Micra
<b>0 265 006 258</b>	HONDA	Civic Aerodeck, Civic Fastback
	MG	ZS
	ROVER	Serie 400, Serie 400 Coupé, Serie 400 Tourer, 45
<b>0 265 006 259</b>	HONDA	Civic Aerodeck, Civic Fastback
	MG	ZS
	ROVER	Serie 400, Serie 400 Coupé, Serie 400 Tourer, 45
<b>0 265 006 260</b>	ALFA ROMEO	GTV, Spider
<b>0 265 006 261</b>	ALFA ROMEO	GTV, Spider
<b>0 265 006 262</b>	FIAT	Croma
	LANCIA	Thema Berlina, Thema Station Wagon
<b>0 265 006 264</b>	MERCEDES- BENZ	Serie C, Serie C (T-Modell), Serie CLK (Cabrio), Serie CLK (Coupé)
<b>0 265 006 266</b>	MERCEDES- BENZ	Serie C, Serie C (T-Modell), Serie CLK (Cabrio), Serie CLK (Coupé)

		
<b>0 265 006 267</b>	HONDA	Civic Aerodeck, Civic Fastback
	MG	ZS
	ROVER	Serie 200, Serie 400, Serie 400 Coupé, Serie 400 Tourer, 45
<b>0 265 006 268</b>	HONDA	Civic Aerodeck, Civic Fastback
	MG	ZS
	ROVER	Serie 200, Serie 400, Serie 400 Coupé, Serie 400 Tourer, 45
<b>0 265 006 269</b>	MG	MG TF, MGF
<b>0 265 006 270</b>	MG	MG TF, MGF
<b>0 265 006 271</b>	MG	MG TF, MGF
<b>0 265 006 274</b>	MERCEDES- BENZ	Serie CL (Coupé), Serie S, Serie S (Coupé)
<b>0 265 006 276</b>	MERCEDES- BENZ	Serie CL (Coupé), Serie S, Serie S (Coupé)
<b>0 265 006 280</b>	MERCEDES- BENZ	Serie SL
<b>0 265 006 281</b>	NISSAN	Terrano II
<b>0 265 006 282</b>	RENAULT	Avantime, Espace III
<b>0 265 006 283</b>	RENAULT	Avantime, Espace III
<b>0 265 006 284</b>	RENAULT	Avantime, Espace III
<b>0 265 006 285</b>	NISSAN	Terrano II
<b>0 265 006 292</b>	MERCEDES- BENZ	Serie SL
<b>0 265 006 293</b>	DAEWOO	New Prince
<b>0 265 006 294</b>	MITSUBISHI	Carisma, Carisma Hatchback, Spacestar
<b>0 265 006 296</b>	KIA	Avella
<b>0 265 006 297</b>	KIA	Avella
<b>0 265 006 298</b>	KIA	Avella
<b>0 265 006 300</b>	LANCIA	Kappa Berlina, Kappa Coupé, Kappa Station Wagon
<b>0 265 006 305</b>	MG	ZR
	ROVER	Serie 200, Serie 400, Serie 400 Tourer, 25
<b>0 265 006 306</b>	MG	ZR
	ROVER	Serie 200, Serie 400, Serie 400 Tourer, 25
<b>0 265 006 307</b>	MG	ZR
	ROVER	Serie 200, 25
<b>0 265 006 314</b>	PEUGEOT	405, 405 Break
<b>0 265 006 315</b>	PEUGEOT	405, 405 Break
<b>0 265 006 325</b>	ALFA ROMEO	145, 146
<b>0 265 006 326</b>	ALFA ROMEO	145, 146
<b>0 265 006 327</b>	MITSUBISHI	Carisma, Carisma Hatchback, Spacestar
<b>0 265 006 328</b>	MITSUBISHI	Carisma Hatchback
<b>0 265 006 329</b>	MITSUBISHI	Carisma Hatchback
<b>0 265 006 330</b>	LADA	Serie 110
<b>0 265 006 331</b>	SAAB (SAAB AU- TOMOBILE AB)	9-3, 9-3 Cabriolet, 9-3 Coupé, 900 II, 900 II Cabriolet, 900 II Coupé

de

**Drehzahlsensor**  
(Fortsetzung)

en

**Rotational-speed sensor**  
(continued)

fr

**Capteur de vitesse de rotation**  
(suite)

it

**Sensore giri**  
(seguito)

es

**Sensor de revoluciones**  
(continuación)

<b>0 265 006 337</b>	SAAB (SAAB AUTOMOBILE AB)	9-5, 9-5 Kombi
<b>0 265 006 341</b>	SSANGYONG	Istana
<b>0 265 006 343</b>	DAEWOO	Korando
	SSANGYONG	Korando
<b>0 265 006 344</b>	PORSCHE	Boxster, 911, 911 Cabriolet, 911 Carrera Cabriolet, 911 Targa
<b>0 265 006 356</b>	MERCEDES-BENZ	Serie E, Serie E (T-Modell)
<b>0 265 006 358</b>	MERCEDES-BENZ	Serie E, Serie E (T-Modell)
<b>0 265 006 360</b>	MITSUBISHI	Carisma Hatchback
<b>0 265 006 361</b>	RENAULT	Safrane
<b>0 265 006 362</b>	RENAULT	Safrane
<b>0 265 006 363</b>	RENAULT	Safrane
<b>0 265 006 364</b>	FIAT	Palio Weekend
<b>0 265 006 365</b>	FIAT	Palio Weekend
<b>0 265 006 366</b>	VOLVO	S40 I, V40 I
<b>0 265 006 368</b>	MERCEDES-BENZ	Classe A, Serie A, Vaneo
<b>0 265 006 370</b>	MERCEDES-BENZ	Classe A, Serie A, Vaneo
<b>0 265 006 372</b>	MERCEDES-BENZ	Classe A, Serie A, Vaneo
<b>0 265 006 378</b>	NISSAN	Primera Hatchback, Primera Sedan, Primera Wagon
<b>0 265 006 379</b>	NISSAN	Primera Hatchback, Primera Sedan, Primera Wagon
<b>0 265 006 382</b>	NISSAN	Micra
<b>0 265 006 383</b>	RENAULT	Clio I, Clio II, Thalia
<b>0 265 006 384</b>	RENAULT	Clio I, Clio II, Clio II Sedan, Thalia
<b>0 265 006 385</b>	RENAULT	Clio I, Clio II, Clio II Sedan, Thalia
<b>0 265 006 386</b>	RENAULT	Kangoo I
<b>0 265 006 387</b>	RENAULT	Kangoo I
<b>0 265 006 388</b>	CITROEN	Evasion, Jumpy
	FIAT	Scudo, Ulysse
	LANCIA	Zeta
	PEUGEOT	Expert, 806
<b>0 265 006 389</b>	CITROEN	Picasso, Xsara, Xsara Break, Xsara Coupé, Xsara Picasso
<b>0 265 006 400</b>	RENAULT	Kangoo I
<b>0 265 006 401</b>	RENAULT	Kangoo I
<b>0 265 006 402</b>	FIAT	Tempra
<b>0 265 006 403</b>	FIAT	Tempra
<b>0 265 006 405</b>	CITROEN	Jumper
	FIAT	Ducato 10, Ducato 14, Ducato 18
	PEUGEOT	Boxer
<b>0 265 006 406</b>	CITROEN	Jumper
	FIAT	Ducato 10, Ducato 14, Ducato 18
	LANCIA	Zeta
	PEUGEOT	Boxer

<b>0 265 006 407</b>	VW (VOLKSWAGEN)	California T4, Caravelle T4, Eurovan, Kombi, Multivan T4, Transporter T4
<b>0 265 006 408</b>	VW (VOLKSWAGEN)	California T4, Caravelle T4, Eurovan, Kombi, Multivan T4, Transporter T4
<b>0 265 006 409</b>	VW (VOLKSWAGEN)	California T4, Caravelle T4, Eurovan, Kombi, Multivan T4, Transporter T4
<b>0 265 006 410</b>	VW (VOLKSWAGEN)	Gol III
<b>0 265 006 411</b>	VW (VOLKSWAGEN)	Gol III
<b>0 265 006 414</b>	DAEWOO	Leganza
<b>0 265 006 415</b>	DAEWOO	Leganza
<b>0 265 006 425</b>	VOLVO	S40 I, V40 I
<b>0 265 006 426</b>	CITROEN	Evasion, Jumpy
	FIAT	Scudo, Ulysse
	LANCIA	Zeta
	PEUGEOT	Expert, 806
<b>0 265 006 427</b>	CITROEN	Jumper
	FIAT	Ducato 10, Ducato 14, Ducato 18
	PEUGEOT	Boxer
<b>0 265 006 441</b>	CITROEN	Xsara Break
	PEUGEOT	306, 306 Break
<b>0 265 006 442</b>	RENAULT	Clio I
<b>0 265 006 443</b>	RENAULT	Clio I
<b>0 265 006 444</b>	RENAULT	Clio I
<b>0 265 006 458</b>	FORD	Transit, Transit Euroline, Transit Nugget, Transit Tourneo
<b>0 265 006 460</b>	FORD	Transit, Transit Euroline, Transit Nugget, Transit Tourneo
<b>0 265 006 461</b>	FORD	Transit
<b>0 265 006 473</b>	ROVER	Serie 200, Serie 400, Serie 400 Tourer
<b>0 265 006 474</b>	ROVER	Serie 200, Serie 400, Serie 400 Tourer
<b>0 265 006 475</b>	ROVER	Serie 200, Serie 400, Serie 400 Tourer
<b>0 265 006 476</b>	ROVER	Serie 200, Serie 400, Serie 400 Tourer
<b>0 265 006 482</b>	FORD	Falcon
<b>0 265 006 486</b>	OPEL	Calibra, Vectra
	VAUXHALL	Calibra, Cavalier III
<b>0 265 006 487</b>	OPEL	Calibra, Vectra
	VAUXHALL	Calibra, Cavalier III
<b>0 265 006 504</b>	CITROEN	Evasion, Jumpy
	FIAT	Scudo, Ulysse
	LANCIA	Zeta
	PEUGEOT	Expert, 806
<b>0 265 006 508</b>	VW (VOLKSWAGEN)	California T4, Caravelle T4, Eurovan, Kombi, Multivan T4, Transporter T4

nl

**Toerentalsensor**  
(vervolg)

sv

**Varvtalssensor**  
(fortsättning)

pt



**Sensor de velocidade**  
(continuação)

cs

**Snímač otáček**  
(pokračování)

ru

**Датчик числа оборотов**  
(продолжение)

		
<b>0 265 006 510</b>	VW (VOLKSWAGEN)	California T4, Caravelle T4, Eurovan, Kombi, Multivan T4, Transporter T4
<b>0 265 006 528</b>	RENAULT	Kangoo I
<b>0 265 006 537</b>	FIAT	Fiorino
<b>0 265 006 538</b>	FIAT	Fiorino
<b>0 265 006 539</b>	FIAT	Fiorino
<b>0 265 006 540</b>	FIAT	Fiorino
<b>0 265 006 544</b>	PEUGEOT	607
<b>0 265 006 545</b>	PEUGEOT	607
<b>0 265 006 556</b>	SMART (MCC)	Fortwo Cabrio, Fortwo Coupé, Roadster, Roadster Coupé, Smart Cabrio, Smart Coupé, Smart Crossblade
<b>0 265 006 557</b>	SMART (MCC)	Fortwo Cabrio, Fortwo Coupé, Roadster, Roadster Coupé, Smart Cabrio, Smart Coupé, Smart Crossblade
<b>0 265 006 565</b>	AUDI	A6, A6 Avant, S6, S6 Avant
<b>0 265 006 567</b>	AUDI	A6, A6 Avant
<b>0 265 006 569</b>	AUDI	A4, A4 Avant, S4, S4 Avant
<b>0 265 006 571</b>	AUDI	A4, A4 Avant, S4, S4 Avant
<b>0 265 006 573</b>	VW (VOLKSWAGEN)	Passat, Passat Variant
<b>0 265 006 575</b>	VW (VOLKSWAGEN)	Passat, Passat Variant
<b>0 265 006 578</b>	AUDI	A4, A4 Avant, A6, A6 Avant, RS4 Avant, S4, S4 Avant, S6, S6 Avant
	VW (VOLKSWAGEN)	Passat, Passat Variant
<b>0 265 006 580</b>	AUDI	A8, S8
<b>0 265 006 584</b>	AUDI	A6, A6 Avant
<b>0 265 006 586</b>	AUDI	A6, A6 Avant
<b>0 265 006 588</b>	AUDI	A8, S8
<b>0 265 006 593</b>	DAEWOO	Nubira, Nubira Hatchback, Nubira Station Wagon
<b>0 265 006 594</b>	DAEWOO	Nubira, Nubira Hatchback, Nubira Station Wagon
<b>0 265 006 595</b>	DAEWOO	Nubira, Nubira Station Wagon
<b>0 265 006 596</b>	DAEWOO	Nubira, Nubira Station Wagon
<b>0 265 006 605</b>	NISSAN	Almera Hatchback
<b>0 265 006 606</b>	NISSAN	Almera Hatchback
<b>0 265 006 638</b>	GAZ	Volga
<b>0 265 006 639</b>	GAZ	Volga
<b>0 265 006 655</b>	AUDI	A6 Allroad
<b>0 265 006 657</b>	AUDI	A6 Allroad
<b>0 265 006 658</b>	NISSAN	Micra
<b>0 265 006 659</b>	CITROEN	Berlingo, Picasso, Xsara Picasso
	PEUGEOT	Partner, Ranch
<b>0 265 006 662</b>	AUDI	A8, S8
<b>0 265 006 664</b>	AUDI	S6, S6 Avant
<b>0 265 006 665</b>	TOYOTA	Avensis, Avensis Liftback, Avensis Wagon

		
<b>0 265 006 666</b>	TOYOTA	Avensis, Avensis Liftback, Avensis Wagon
<b>0 265 006 667</b>	TOYOTA	Avensis, Avensis Liftback, Avensis Wagon
<b>0 265 006 668</b>	TOYOTA	Avensis, Avensis Liftback, Avensis Wagon
<b>0 265 006 670</b>	NISSAN	Terrano II
<b>0 265 006 671</b>	NISSAN	Terrano II
<b>0 265 006 673</b>	FIAT	Ducato Cargo, Ducato Minibus, Ducato 10, Ducato 11, Ducato 14, Ducato 15, Ducato 18
<b>0 265 006 674</b>	TOYOTA	Yaris
<b>0 265 006 675</b>	TOYOTA	Yaris
<b>0 265 006 676</b>	TOYOTA	Avensis, Avensis Liftback, Avensis Wagon, Corolla, Corolla Hatchback, Corolla Sedan, Corolla Verso, Corolla Wagon
<b>0 265 006 677</b>	TOYOTA	Avensis, Avensis Liftback, Avensis Wagon, Corolla, Corolla Hatchback, Corolla Sedan, Corolla Verso, Corolla Wagon
<b>0 265 006 681</b>	AUDI	A4, A4 Avant, A4 Cabriolet, S4, S4 Avant, S4 Cabriolet
<b>0 265 006 683</b>	AUDI	A4, A4 Avant, A4 Cabriolet, S4, S4 Avant
<b>0 265 006 688</b>	FIAT	Ducato Cargo, Ducato Minibus, Ducato 10, Ducato 11, Ducato 14, Ducato 15, Ducato 18
<b>0 265 006 689</b>	FIAT	Ducato Cargo, Ducato Minibus, Ducato 10, Ducato 11, Ducato 14, Ducato 15, Ducato 18
<b>0 265 006 693</b>	AUDI	RS4 Avant
<b>0 265 006 695</b>	AUDI	RS4 Avant
<b>0 265 006 698</b>	VOLVO	S40 I, V40 I
<b>0 265 006 702</b>	NISSAN	Almera Hatchback, Almera Sedan
<b>0 265 006 703</b>	NISSAN	Almera Hatchback, Almera Sedan
<b>0 265 006 704</b>	NISSAN	Almera Tino
<b>0 265 006 705</b>	NISSAN	Almera Tino
<b>0 265 006 707</b>	AUDI	A4, A4 Avant, A4 Cabriolet, S4, S4 Avant, S4 Cabriolet
<b>0 265 006 708</b>	NISSAN	Primera Hatchback, Primera Sedan
<b>0 265 006 709</b>	NISSAN	Primera Hatchback, Primera Sedan
<b>0 265 006 710</b>	RENAULT	Kangoo I
<b>0 265 006 711</b>	RENAULT	Kangoo I
<b>0 265 006 712</b>	DAEWOO	Korando, Musso
	SSANGYONG	Korando, Musso
<b>0 265 006 714</b>	NISSAN	Micra
<b>0 265 006 715</b>	NISSAN	Micra
<b>0 265 006 730</b>	CITROEN	Jumpy
	PEUGEOT	Expert



de

**Drehzahlsensor**  
(Fortsetzung)

en

**Rotational-speed sensor**  
(continued)

fr

**Capteur de vitesse de rotation**  
(suite)

it

**Sensore giri**  
(seguito)

es

**Sensor de revoluciones**  
(continuación)

<b>0 265 006 731</b>	CITROEN PEUGEOT	Jumpy Expert
<b>0 265 006 732</b>	CITROEN PEUGEOT	Berlingo, Xsara Picasso Partner
<b>0 265 006 735</b>	RENAULT	19, 19 Cabrio
<b>0 265 006 736</b>	RENAULT	19, 19 Cabrio
<b>0 265 006 737</b>	RENAULT	19, 19 Cabrio
<b>0 265 006 751</b>	CHEVROLET DAEWOO	Lacetti, Nubira, Nubira Wagon, Optra Hatchback Lacetti, Nubira, Nubira Station Wagon
<b>0 265 006 752</b>	CHEVROLET DAEWOO	Lacetti, Nubira, Nubira Wagon, Optra Hatchback Lacetti, Nubira, Nubira Station Wagon
<b>0 265 006 753</b>	SMART (MCC)	Roadster, Roadster Coupé
<b>0 265 006 755</b>	NISSAN	Terrano II
<b>0 265 006 756</b>	NISSAN	Terrano II
<b>0 265 006 761</b>	AUDI	A6, A6 Avant
<b>0 265 006 763</b>	AUDI	A6, A6 Avant
<b>0 265 006 765</b>	AUDI	A6, A6 Avant, RS6, RS6 Avant, S6, S6 Avant
<b>0 265 006 767</b>	AUDI	A6, A6 Avant, RS6, RS6 Avant, S6, S6 Avant
<b>0 265 006 769</b>	AUDI	A6, A6 Avant, RS6, RS6 Avant
<b>0 265 006 771</b>	AUDI	RS6, RS6 Avant, S6, S6 Avant
<b>0 265 006 778</b>	NISSAN	Terrano II
<b>0 265 006 779</b>	NISSAN	Terrano II
<b>0 265 006 781</b>	AUDI	A6 Allroad
<b>0 265 006 783</b>	AUDI	A6 Allroad
<b>0 265 006 784</b>	FORD	Transit, Transit Euroline, Transit Nugget, Transit Tourneo
<b>0 265 006 793</b>	CITROEN PEUGEOT	Berlingo, Xsara Picasso Partner
<b>0 265 006 809</b>	AUDI SEAT	A4, A4 Avant, A4 Cabriolet, RS4, RS4 Avant, RS4 Cabriolet, S4, S4 Avant, S4 Cabriolet Exeo, Exeo ST
<b>0 265 006 811</b>	FORD	Transit, Transit Euroline, Transit Nugget, Transit Tourneo
<b>0 265 006 812</b>	FORD	Transit
<b>0 265 006 813</b>	FORD	Transit
<b>0 265 006 814</b>	FORD	Transit
<b>0 265 006 815</b>	FORD	Transit
<b>0 265 006 816</b>	FORD	Transit
<b>0 265 006 817</b>	FORD	Transit, Transit Euroline, Transit Nugget, Transit Tourneo
<b>0 265 006 818</b>	FORD	Transit, Transit Euroline, Transit Nugget, Transit Tourneo
<b>0 265 006 824</b>	AUDI SEAT	A4, A4 Avant, A4 Cabriolet, RS4, RS4 Avant, RS4 Cabriolet, S4, S4 Avant, S4 Cabriolet Exeo, Exeo ST
<b>0 265 006 826</b>	AUDI	A4, A4 Avant, A4 Cabriolet, S4, S4 Avant, S4 Cabriolet



<b>0 265 006 828</b>	AUDI	A4, A4 Avant, A4 Cabriolet, RS4, RS4 Avant, RS4 Cabriolet, S4, S4 Avant, S4 Cabriolet
----------------------	------	---

**0 265 007 ...**

<b>0 265 007 002</b>	MERCEDES-BENZ	Serie CL (Coupé), Serie S
<b>0 265 007 006</b>	MERCEDES-BENZ	Serie CL (Coupé), Serie S
<b>0 265 007 008</b>	MERCEDES-BENZ	Serie CL (Coupé), Serie S
<b>0 265 007 016</b>	ALFA ROMEO	156 Berlina, 156 Sport Wagon
<b>0 265 007 017</b>	ALFA ROMEO	156 Berlina, 156 Sport Wagon
<b>0 265 007 018</b>	ALFA ROMEO	156 Berlina, 156 Sport Wagon
<b>0 265 007 020</b>	ALFA ROMEO	166
<b>0 265 007 021</b>	ALFA ROMEO	166
<b>0 265 007 022</b>	ALFA ROMEO	166
<b>0 265 007 024</b>	FIAT LANCIA	Barchetta Y
<b>0 265 007 025</b>	FIAT LANCIA	Barchetta Y
<b>0 265 007 026</b>	FIAT LANCIA	Barchetta Y
<b>0 265 007 027</b>	FIAT LANCIA	Barchetta Y
<b>0 265 007 032</b>	FIAT	Brava, Marea, Marea Weekend, Marengo
<b>0 265 007 033</b>	FIAT	Brava, Marea, Marea Weekend, Marengo
<b>0 265 007 034</b>	FIAT	Brava, Marea, Marea Weekend, Marengo
<b>0 265 007 035</b>	FIAT	Brava, Marea, Marea Weekend, Marengo
<b>0 265 007 036</b>	FIAT	Multipla
<b>0 265 007 037</b>	FIAT	Multipla
<b>0 265 007 038</b>	FIAT	Multipla
<b>0 265 007 039</b>	FIAT	Multipla
<b>0 265 007 040</b>	LANCIA	Kappa Berlina, Kappa Coupé, Kappa Station Wagon
<b>0 265 007 041</b>	LANCIA	Kappa Berlina, Kappa Coupé, Kappa Station Wagon
<b>0 265 007 042</b>	LANCIA	Kappa Berlina, Kappa Coupé, Kappa Station Wagon
<b>0 265 007 043</b>	FIAT	Seicento
<b>0 265 007 044</b>	FIAT	Seicento
<b>0 265 007 045</b>	FIAT	Seicento
<b>0 265 007 046</b>	ALFA ROMEO	156 Berlina, 156 Sport Wagon, 156 Sportwagon
<b>0 265 007 047</b>	ALFA ROMEO	156 Berlina, 156 Sport Wagon, 156 Sportwagon
<b>0 265 007 048</b>	ALFA ROMEO	156 Berlina, 156 Sport Wagon, 156 Sportwagon
<b>0 265 007 049</b>	FIAT	Strada
<b>0 265 007 050</b>	FIAT	Strada
<b>0 265 007 051</b>	FIAT	Palio, Siena

nl

**Toerentalsensor**  
(vervolg)

sv

**Varvtalssensor**  
(fortsättning)

pt

**Sensor de velocidade**  
(continuação)



cs

**Snímač otáček**  
(pokračování)

ru

**Датчик числа оборотов**  
(продолжение)

		
<b>0 265 007 052</b>	FIAT	Palio Weekend
<b>0 265 007 053</b>	FIAT	Palio Weekend
<b>0 265 007 054</b>	FIAT	Strada
<b>0 265 007 055</b>	FIAT	Strada
<b>0 265 007 059</b>	LANCIA	Thesis
<b>0 265 007 063</b>	ALFA ROMEO	145, 146
<b>0 265 007 064</b>	ALFA ROMEO	145, 146
<b>0 265 007 065</b>	ALFA ROMEO	145, 146
<b>0 265 007 066</b>	ALFA ROMEO	145, 146
<b>0 265 007 069</b>	FIAT	Punto, Punto Van
<b>0 265 007 070</b>	FIAT	Punto, Punto Van
<b>0 265 007 071</b>	FIAT	Punto, Punto Van
<b>0 265 007 072</b>	FIAT	Punto, Punto Van
<b>0 265 007 073</b>	ALFA ROMEO	GTV, Spider
	FIAT	Marea, Marengo
	LANCIA	Lybra Berlina, Lybra Station Wagon
<b>0 265 007 074</b>	ALFA ROMEO	GTV, Spider
	FIAT	Marea, Marengo
	LANCIA	Lybra Berlina, Lybra Station Wagon
<b>0 265 007 075</b>	LANCIA	Lybra Berlina, Lybra Station Wagon
<b>0 265 007 076</b>	LANCIA	Lybra Berlina, Lybra Station Wagon
<b>0 265 007 083</b>	CITROEN	C8
	FIAT	Ulysse
	LANCIA	Phedra
	PEUGEOT	807
<b>0 265 007 084</b>	CITROEN	C8
	FIAT	Ulysse
	LANCIA	Phedra
	PEUGEOT	807
<b>0 265 007 085</b>	ALFA ROMEO	147
<b>0 265 007 086</b>	ALFA ROMEO	147
<b>0 265 007 089</b>	ALFA ROMEO	147
<b>0 265 007 098</b>	ALFA ROMEO	GTV, Spider
<b>0 265 007 099</b>	ALFA ROMEO	GTV, Spider
<b>0 265 007 100</b>	FIAT	Punto
<b>0 265 007 101</b>	FIAT	Punto
<b>0 265 007 102</b>	FIAT	Albea, Palio, Palio Weekend, Siena, Strada
<b>0 265 007 103</b>	FIAT	Albea, Palio, Palio Weekend, Siena, Strada
<b>0 265 007 111</b>	ALFA ROMEO	156 Berlina, 156 Sport Wagon, 156 Sportwagon
<b>0 265 007 112</b>	ALFA ROMEO	156 Berlina, 156 Sport Wagon, 156 Sportwagon
<b>0 265 007 113</b>	ALFA ROMEO	156 Berlina, 156 Sport Wagon, 156 Sportwagon
<b>0 265 007 121</b>	MERCEDES-BENZ	Serie CL (Coupé), Serie S
<b>0 265 007 123</b>	MERCEDES-BENZ	Serie CL (Coupé), Serie S
<b>0 265 007 126</b>	FIAT	Albea

		
<b>0 265 007 128</b>	MERCEDES-BENZ	Serie CL (Coupé), Serie S
<b>0 265 007 130</b>	CITROEN	C8
	FIAT	Ulysse
	LANCIA	Phedra
	PEUGEOT	807
<b>0 265 007 131</b>	CITROEN	C8
	FIAT	Ulysse
	LANCIA	Phedra
	PEUGEOT	807
<b>0 265 007 400</b>	FIAT	Stilo
<b>0 265 007 401</b>	FIAT	Stilo, Stilo Multi Wagon
<b>0 265 007 404</b>	JAGUAR	X-Type, X-Type Estate
<b>0 265 007 413</b>	NISSAN	Altima
<b>0 265 007 414</b>	NISSAN	Altima
<b>0 265 007 415</b>	NISSAN	Altima
<b>0 265 007 416</b>	NISSAN	Altima
<b>0 265 007 417</b>	JAGUAR	X-Type, X-Type Estate
<b>0 265 007 423</b>	PEUGEOT	307, 307 Break/SW, 307 CC
<b>0 265 007 424</b>	PEUGEOT	307, 307 Break/SW, 307 CC, 307 Sedan
<b>0 265 007 439</b>	PORSCHE	Boxster, 911, 911 Cabriolet, 911 Targa
<b>0 265 007 448</b>	FIAT	Panda
<b>0 265 007 461</b>	BMW	Serie 7
<b>0 265 007 462</b>	BMW	Serie 7
<b>0 265 007 463</b>	NISSAN	Primera, Primera Hatchback, Primera Wagon
<b>0 265 007 464</b>	NISSAN	Primera, Primera Hatchback, Primera Wagon
<b>0 265 007 465</b>	NISSAN	Primera, Primera Hatchback, Primera Wagon
<b>0 265 007 466</b>	NISSAN	Primera, Primera Hatchback, Primera Wagon
<b>0 265 007 467</b>	RENAULT	Grand Scenic II, Megane II, Megane II Cabrio, Megane II Grandtour, Megane II Hatchback, Scenic II
<b>0 265 007 468</b>	RENAULT	Megane II, Megane II Cabrio, Megane II Grandtour, Megane II Hatchback
<b>0 265 007 478</b>	MERCEDES-BENZ	Serie A, Serie B
<b>0 265 007 480</b>	MERCEDES-BENZ	Serie A, Serie B
<b>0 265 007 486</b>	ALFA ROMEO	GT, 147, 156 Berlina, 156 Sport Wagon, 156 Sportwagon
<b>0 265 007 487</b>	ALFA ROMEO	GT, 147, 156 Berlina, 156 Sport Wagon, 156 Sportwagon
<b>0 265 007 488</b>	ALFA ROMEO	GT, 156 Berlina, 156 Sport Wagon, 156 Sportwagon

de

**Drehzahlsensor**  
(Fortsetzung)

en

**Rotational-speed sensor**  
(continued)

fr

**Capteur de vitesse de rotation**  
(suite)

it

**Sensore giri**  
(seguito)

es

**Sensor de revoluciones**  
(continuación)

<b>0 265 007 500</b>	MERCEDES-BENZ	Serie E, Serie E (T-Modell)
<b>0 265 007 503</b>	FIAT LANCIA	Idea Musa
<b>0 265 007 510</b>	FIAT	Punto, Punto Van
<b>0 265 007 511</b>	FIAT	Punto, Punto Van
<b>0 265 007 512</b>	FIAT	Punto, Punto Van
<b>0 265 007 513</b>	FIAT	Punto, Punto Van
<b>0 265 007 518</b>	FIAT	Punto, Punto Van
<b>0 265 007 519</b>	FIAT	Punto, Punto Van
<b>0 265 007 520</b>	FIAT	Punto
<b>0 265 007 521</b>	FIAT	Punto
<b>0 265 007 527</b>	RENAULT	Clio II, Clio II Sedan, Kangoo I, Thalia, Twingo I
<b>0 265 007 529</b>	RENAULT	Clio II, Thalia
<b>0 265 007 531</b>	RENAULT	Kangoo I
<b>0 265 007 532</b>	RENAULT	Kangoo I
<b>0 265 007 533</b>	RENAULT	Kangoo I
<b>0 265 007 534</b>	RENAULT	Kangoo I
<b>0 265 007 537</b>	NISSAN	Micra, Micra CC, Note
<b>0 265 007 542</b>	ALFA ROMEO	147
<b>0 265 007 543</b>	ALFA ROMEO	147
<b>0 265 007 550</b>	FIAT	Multipla
<b>0 265 007 551</b>	FIAT	Multipla
<b>0 265 007 552</b>	NISSAN	Almera Hatchback, Almera Sedan
<b>0 265 007 553</b>	NISSAN	Almera Hatchback, Almera Sedan
<b>0 265 007 554</b>	NISSAN	Almera Hatchback, Almera Sedan
<b>0 265 007 555</b>	NISSAN	Almera Hatchback, Almera Sedan
<b>0 265 007 556</b>	NISSAN	Almera Tino
<b>0 265 007 557</b>	NISSAN	Almera Tino
<b>0 265 007 558</b>	NISSAN	Almera Tino
<b>0 265 007 559</b>	NISSAN	Almera Tino
<b>0 265 007 560</b>	FIAT	Multipla
<b>0 265 007 561</b>	FIAT	Multipla
<b>0 265 007 562</b>	FIAT	Multipla
<b>0 265 007 563</b>	FIAT	Multipla
<b>0 265 007 564</b>	LANCIA	Lybra Berlina, Lybra Station Wagon
<b>0 265 007 565</b>	LANCIA	Lybra Berlina, Lybra Station Wagon
<b>0 265 007 566</b>	LANCIA	Lybra Berlina, Lybra Station Wagon
<b>0 265 007 567</b>	LANCIA	Lybra Berlina, Lybra Station Wagon
<b>0 265 007 582</b>	DACIA RENAULT	Logan, Logan MCV Logan, Logan MCV, Twingo I
<b>0 265 007 583</b>	DACIA RENAULT	Logan, Logan MCV Logan, Logan MCV, Twingo I
<b>0 265 007 592</b>	ALPINA (B. BOVEN-SIEPEN KG) BMW	B7 Serie 7
<b>0 265 007 606</b>	RENAULT	Clio III, Clio III Grandtour, Modus
<b>0 265 007 610</b>	FIAT	Punto, Punto Van
<b>0 265 007 622</b>	BMW	Serie X

<b>0 265 007 624</b>	PORSCHE	Boxster, Cayman, 911, 911 Cabriolet, 911 Speedster, 911 Targa
<b>0 265 007 632</b>	NISSAN	Primera, Primera Hatchback, Primera Wagon
<b>0 265 007 633</b>	NISSAN	Primera, Primera Hatchback, Primera Wagon
<b>0 265 007 635</b>	MERCEDES-BENZ	Serie SL
<b>0 265 007 637</b>	MITSUBISHI SMART (MCC)	Colt, Colt Cabrio Forfour
<b>0 265 007 638</b>	MITSUBISHI SMART (MCC)	Colt, Colt Cabrio Forfour
<b>0 265 007 639</b>	FIAT	Panda
<b>0 265 007 664</b>	CITROEN PEUGEOT	C4 Sedan 307, 307 Break/SW, 307 CC, 307 Sedan
<b>0 265 007 665</b>	CITROEN	Xsara Picasso
<b>0 265 007 666</b>	CITROEN PEUGEOT	Berlingo Partner
<b>0 265 007 667</b>	CITROEN PEUGEOT	Berlingo, Xsara Picasso Partner
<b>0 265 007 668</b>	CITROEN PEUGEOT	Berlingo, Xsara Picasso Partner
<b>0 265 007 669</b>	BMW	Serie 3, Serie 3 Coupé, Serie 3 Touring
<b>0 265 007 671</b>	VAUXHALL	Corsa
<b>0 265 007 683</b>	MITSUBISHI	Colt, Colt Cabrio
<b>0 265 007 685</b>	FIAT	Ducato, Ducato 11, Ducato 15, Ducato 17, Ducato 20, Ducato 110, Ducato 115, Ducato 130, Ducato 140, Ducato 150, Ducato 180
<b>0 265 007 687</b>	CITROEN PEUGEOT TOYOTA	C1 107 Aygo
<b>0 265 007 688</b>	CITROEN PEUGEOT TOYOTA	C1 107 Aygo
<b>0 265 007 690</b>	INFINITI	M
<b>0 265 007 691</b>	ALFA ROMEO	156 Sport Wagon, 156 Sport Wagon Q4
<b>0 265 007 694</b>	MERCEDES-BENZ	Serie SL
<b>0 265 007 696</b>	MERCEDES-BENZ	Serie SL, Serie SLR (Coupé), Serie SLR (Roadster)
<b>0 265 007 707</b>	CITROEN PEUGEOT	C3 Picasso 207, 207 CC, 207 SW
<b>0 265 007 711</b>	FIAT	Panda
<b>0 265 007 714</b>	INFINITI	G, M
<b>0 265 007 742</b>	RENAULT	Logan, Logan MCV, Sandero
<b>0 265 007 762</b>	NISSAN	Altima
<b>0 265 007 763</b>	NISSAN	Altima

nl

**Toerentalsensor**  
(vervolg)

sv

**Varvtalssensor**  
(fortsättning)

pt

**Sensor de velocidade**  
(continuação)



cs

**Snímač otáček**  
(pokračování)

ru

**Датчик числа оборотов**  
(продолжение)

		
<b>0 265 007 769</b>	ALFA ROMEO	MiTo
	FIAT	Punto, Punto Evo, Punto Grande, Punto Grande Abarth, Punto Grande Abarth SS
	OPEL	Corsa
	VAUXHALL	Corsa
<b>0 265 007 779</b>	CITROEN	C4, C4 Coupé, C4 Sedan
	PEUGEOT	307, 307 Break/SW, 307 CC, 307 Sedan
<b>0 265 007 780</b>	PEUGEOT	307, 307 Break/SW, 307 CC
<b>0 265 007 788</b>	CITROEN	Berlingo, C4 Grand Picasso, C4 Picasso
	PEUGEOT	Partner
<b>0 265 007 789</b>	CITROEN	Berlingo, C4 Grand Picasso, C4 Picasso
	PEUGEOT	Partner, 3008, 5008
<b>0 265 007 790</b>	CITROEN	Jumpy
	FIAT	Scudo
	PEUGEOT	Expert
<b>0 265 007 791</b>	CITROEN	Jumpy
	FIAT	Scudo
	PEUGEOT	Expert
<b>0 265 007 795</b>	ALFA ROMEO	156 Sport Wagon, 156 Sport Wagon Q4
<b>0 265 007 796</b>	ALFA ROMEO	156 Sport Wagon, 156 Sport Wagon Q4
<b>0 265 007 799</b>	UAZ	Hunter, Patriot, Pickup
<b>0 265 007 800</b>	UAZ	Hunter, Patriot, Pickup
<b>0 265 007 802</b>	TOYOTA	Auris
<b>0 265 007 805</b>	TOYOTA	Auris, Auris Touring Sports, Avensis, Avensis Wagon, Corolla, Corolla Verso
<b>0 265 007 806</b>	TOYOTA	Auris, Auris Touring Sports, Avensis, Avensis Wagon, Corolla, Corolla Verso
<b>0 265 007 807</b>	MINI (BMW)	Cooper, Cooper Cabrio, Cooper Clubman, Cooper Clubvan, Cooper Coupé, Cooper One, Cooper One Cabrio, Cooper One Clubman, Cooper Roadster, John Cooper Works, John Cooper Works Cabrio, John Cooper Works Clubman, John Cooper Works Coupé, John Cooper Works Roadster

		
<b>0 265 007 808</b>	MINI (BMW)	Cooper, Cooper Cabrio, Cooper Clubman, Cooper Clubvan, Cooper Coupé, Cooper One, Cooper One Cabrio, Cooper One Clubman, Cooper Roadster, John Cooper Works, John Cooper Works Cabrio, John Cooper Works Clubman, John Cooper Works Coupé, John Cooper Works Roadster
<b>0 265 007 809</b>	RENAULT	Clio III
<b>0 265 007 830</b>	FIAT	Idea
	LANCIA	Musa, Ypsilon
<b>0 265 007 831</b>	FIAT	Punto, Punto Van
<b>0 265 007 832</b>	FIAT	Punto
<b>0 265 007 833</b>	FIAT	Ducato, Ducato 11, Ducato 15, Ducato 17, Ducato 20, Ducato 110, Ducato 115, Ducato 130, Ducato 140, Ducato 150, Ducato 180
<b>0 265 007 845</b>	ALPINA (B. BOVEN- SIEPEN KG)	B7
	BMW	Serie 7
<b>0 265 007 851</b>	BMW	Serie 5 Touring
<b>0 265 007 852</b>	BMW	Serie X
<b>0 265 007 853</b>	BMW	Serie X
<b>0 265 007 854</b>	BMW	Serie X
<b>0 265 007 855</b>	BMW	Serie X
<b>0 265 007 878</b>	FORD	Transit, Transit Euroline, Transit Nugget, Transit Tourneo
<b>0 265 007 879</b>	FORD	Mondeo, Mondeo III, Mondeo III Turnier
	JAGUAR	X-Type, X-Type Estate
<b>0 265 007 883</b>	CITROEN	Berlingo, Xsara Picasso
	PEUGEOT	Partner
<b>0 265 007 885</b>	LADA	Kalina, Kalina Hatchback, Kalina Kombi, Priora, Priora Hatchback, Priora Kombi
<b>0 265 007 886</b>	LADA	Kalina, Kalina Hatchback, Kalina Kombi, Priora, Priora Hatchback, Priora Kombi
<b>0 265 007 890</b>	RENAULT	Twingo II, Wind
<b>0 265 007 891</b>	RENAULT	Twingo II
<b>0 265 007 892</b>	RENAULT	Twingo II
<b>0 265 007 896</b>	FIAT	Grande Punto, Punto, Punto Evo, Punto Grande
	OPEL	Corsa
	VAUXHALL	Corsa
<b>0 265 007 905</b>	NISSAN	Qashqai, Qashqai+2
<b>0 265 007 908</b>	NISSAN	Qashqai, Qashqai+2
<b>0 265 007 909</b>	NISSAN	Qashqai, Qashqai+2
<b>0 265 007 922</b>	LAND ROVER GROUP	Discovery III, Discovery IV, Range Rover Sport

de

**Drehzahlsensor**  
(Fortsetzung)

en

**Rotational-speed  
sensor**  
(continued)

fr

**Capteur de vitesse  
de rotation**  
(suite)

it

**Sensore giri**  
(seguito)

es

**Sensor  
de revoluciones**  
(continuación)



<b>0 265 007 923</b>	LAND ROVER GROUP	Discovery III
<b>0 265 007 924</b>	LAND ROVER GROUP	Range Rover Sport
<b>0 265 007 928</b>	AUDI	A4, A4 Allroad, A4 Avant, A4 Sportback, A5 Cabriolet, A5 Coupé, A5 Sportback, A6, A6 Allroad, A6 Avant, A7 Sportback, A8, Q5, RS4 Avant, RS5 Cabriolet, RS5 Coupé, RS6, RS6 Avant, RS7 Sportback, R8, R8 Spyder, R8 Spyder GT, SQ5, S4, S4 Avant, S5 Cabriolet, S5 Coupé, S5 Sportback, S6, S6 Avant, S7 Sportback, S8
	BENTLEY	Continental Flying Spur, Continental Flying Spur Speed, Continental GT, Continental GT Speed, Continental GTC, Continental GTC Speed, Continental GT3 R, Continental Supersport, Continental Supersports, Continental Supersports Cabrio, Continental Supersports ISR Cabrio, Flying Spur, Mulsanne, Mulsanne Speed
	PORSCHE	918 Spyder
	VW (VOLKSWAGEN)	Phaeton
<b>0 265 007 930</b>	AUDI	A4, A4 Allroad, A4 Avant, A4 Sportback, A5 Cabriolet, A5 Coupé, A5 Sportback, A6, A6 Allroad, A6 Avant, A7 Sportback, A8, Q5, RS4 Avant, RS5 Cabriolet, RS5 Coupé, RS6, RS6 Avant, RS7 Sportback, R8, R8 Spyder, R8 Spyder GT, SQ5, S4, S4 Avant, S5 Cabriolet, S5 Coupé, S5 Sportback, S6, S6 Avant, S7 Sportback, S8
	BENTLEY	Continental Flying Spur, Continental Flying Spur Speed, Continental GT, Continental GT Speed, Continental GTC, Continental GTC Speed, Continental GT3 R, Continental Supersport, Continental Supersports, Continental Supersports Cabrio, Continental Supersports ISR Cabrio, Flying Spur, Mulsanne, Mulsanne Speed
	VW (VOLKSWAGEN)	Phaeton



<b>0 265 007 944</b>	SUBARU	Legacy, Legacy Kombi, Legacy Outback
<b>0 265 007 945</b>	SUBARU	Legacy, Legacy Kombi, Legacy Outback
<b>0 265 007 946</b>	TOYOTA	Auris, Corolla
<b>0 265 007 947</b>	TOYOTA	Auris, Corolla
<b>0 265 007 954</b>	SUZUKI	SX4, SX4 Hatchback
<b>0 265 007 955</b>	SUZUKI	SX4, SX4 Hatchback
<b>0 265 007 956</b>	SUZUKI	SX4, SX4 Hatchback
<b>0 265 007 957</b>	SUZUKI	SX4, SX4 Hatchback
<b>0 265 007 980</b>	FIAT	Ducato, Ducato 11, Ducato 15, Ducato 17, Ducato 20, Ducato 110, Ducato 115, Ducato 130, Ducato 140, Ducato 150, Ducato 180
<b>0 265 007 981</b>	BMW	Serie 5, Serie 5 GT, Serie 5 Touring, Serie 6 Cabrio, Serie 7
	ROLLS-ROYCE	Ghost
<b>0 265 007 982</b>	BMW	Serie 5, Serie 5 GT, Serie 5 Touring, Serie 6 Cabrio, Serie 6 Coupé, Serie 6 GC, Serie 7
<b>0 265 007 983</b>	BMW	Serie 5, Serie 6, Serie 6 Cabrio, Serie 7
	ROLLS-ROYCE	Ghost, Wraith
<b>0 265 007 992</b>	MAZDA	2
<b>0 265 007 994</b>	MAZDA	2
<b>0 265 008 ...</b>		
<b>0 265 008 002</b>	FIAT	Bravo
	LANCIA	Delta
<b>0 265 008 003</b>	FIAT	Bravo, Stilo, Stilo Multi Wagon
	LANCIA	Delta
<b>0 265 008 005</b>	FIAT	Panda
<b>0 265 008 006</b>	FIAT	Panda
<b>0 265 008 007</b>	ALFA ROMEO	147
<b>0 265 008 017</b>	CITROEN	C4, C4 Coupé, C4 Sedan
	PEUGEOT	307, 307 Break/SW, 307 CC, 307 Sedan
<b>0 265 008 018</b>	CITROEN	C4, C4 Sedan
	PEUGEOT	307 CC
<b>0 265 008 024</b>	INFINITI	G
<b>0 265 008 025</b>	INFINITI	G, G Cabrio, G Coupé
	NISSAN	370 Z Coupé, 370 Z Roadster
<b>0 265 008 035</b>	FIAT	Panda
<b>0 265 008 036</b>	BMW	Serie 5, Serie 5 GT, Serie 5 Touring
<b>0 265 008 041</b>	OPEL	Vivaro
	RENAULT	Trafic II
	VAUXHALL	Vivaro
<b>0 265 008 049</b>	LANCIA	Ypsilon

nl

**Toerentalsensor**  
(vervolg)

sv

**Varvtalssensor**  
(fortsättning)

pt

**Sensor de velocidade**  
(continuação)

cs

**Snímač otáček**  
(pokračování)

ru

**Датчик числа оборотов**  
(продолжение)

		
<b>0 265 008 055</b>	ALFA ROMEO	Brera, Spider, 159 Berlina, 159 Berlina Q4, 159 Sport Wagon, 159 Sport Wagon Q4, 159 Sportwagon
<b>0 265 008 056</b>	ALFA ROMEO	Brera, Spider, 159 Berlina, 159 Berlina Q4, 159 Sport Wagon, 159 Sport Wagon Q4, 159 Sportwagon
<b>0 265 008 077</b>	OPEL	Vivaro
	RENAULT	Trafic II
	VAUXHALL	Vivaro
<b>0 265 008 078</b>	OPEL	Vivaro
	RENAULT	Trafic II
	VAUXHALL	Vivaro
<b>0 265 008 089</b>	OPEL	Adam, Corsa
	VAUXHALL	Adam, Corsa
<b>0 265 008 097</b>	MERCEDES-BENZ	Serie CLS, Serie E, Serie E (T-Modell), Serie SL
<b>0 265 008 135</b>	MERCEDES-BENZ	Serie CLS (Coupé), Serie CLS (Shooting Brake), Serie E, Serie E (T-Modell)
<b>0 265 008 138</b>	MERCEDES-BENZ	Serie E (Cabrio), Serie E (Coupé)
<b>0 265 008 140</b>	MERCEDES-BENZ	Serie C (Coupé), Serie E (Cabrio), Serie E (Coupé)
<b>0 265 008 145</b>	RENAULT	Twingo II, Wind
<b>0 265 008 146</b>	RENAULT	Twingo II, Wind
<b>0 265 008 161</b>	BMW	Serie Z
<b>0 265 008 162</b>	BMW	Serie Z
<b>0 265 008 173</b>	RENAULT	Fluence, Grand Scenic III, Megane III CC, Megane III Coupé, Megane III Grandtour, Megane III Hatchback, Meganelll Hatchback, Scenic III
<b>0 265 008 188</b>	LANCIA	Ypsilon
<b>0 265 008 190</b>	INFINITI	EX, G Coupé
	NISSAN	370 Z Coupé
<b>0 265 008 191</b>	INFINITI	EX, G Coupé
	NISSAN	370 Z Coupé
<b>0 265 008 218</b>	ALFA ROMEO	159 Berlina, 159 Sport Wagon, 159 Sportwagon
<b>0 265 008 219</b>	INFINITI	EX
<b>0 265 008 238</b>	BMW	Serie X
<b>0 265 008 245</b>	INFINITI	FX
<b>0 265 008 250</b>	NISSAN	Teana
<b>0 265 008 266</b>	LAND ROVER GROUP	Discovery IV
<b>0 265 008 288</b>	LANCIA	Delta
<b>0 265 008 297</b>	DACIA	Logan
	RENAULT	Logan, Sandero

		
<b>0 265 008 311</b>	NISSAN	Micra, Note, Sunny
<b>0 265 008 312</b>	NISSAN	Micra, Note, Sunny
<b>0 265 008 313</b>	NISSAN	Micra, Note, Sunny
<b>0 265 008 323</b>	NISSAN	Micra, Micra CC, Note
<b>0 265 008 324</b>	NISSAN	Micra, Micra CC, Note
<b>0 265 008 331</b>	OPEL	Meriva
	VAUXHALL	Meriva
<b>0 265 008 338</b>	SUBARU	Forester, Impreza, Impreza Sedan, Impreza WRX, Impreza WRX Hatchback, Impreza WRX STI, Impreza WRX STI Hatchback, Impreza WRX STI 320R, Impreza WRX Wagon, Legacy, Legacy Kombi, Legacy Outback
<b>0 265 008 339</b>	SUBARU	Forester, Impreza, Impreza Sedan, Impreza WRX, Impreza WRX Hatchback, Impreza WRX STI, Impreza WRX STI Hatchback, Impreza WRX STI 320R, Impreza WRX Wagon, Legacy, Legacy Kombi, Legacy Outback
<b>0 265 008 340</b>	SUBARU	Legacy, Legacy Kombi, Legacy Outback
<b>0 265 008 341</b>	SUBARU	Legacy, Legacy Kombi, Legacy Outback
<b>0 265 008 344</b>	SUBARU	Impreza, Impreza Sedan, Impreza WRX, Impreza WRX Hatchback, Impreza WRX STI, Impreza WRX STI Hatchback, Impreza WRX STI 320R, Impreza WRX Wagon
<b>0 265 008 345</b>	SUBARU	Impreza, Impreza Sedan, Impreza WRX, Impreza WRX Hatchback, Impreza WRX STI, Impreza WRX STI Hatchback, Impreza WRX STI 320R, Impreza WRX Wagon
<b>0 265 008 346</b>	SUBARU	Forester
<b>0 265 008 347</b>	SUBARU	Forester
<b>0 265 008 357</b>	SUBARU	Legacy, Legacy Kombi, Legacy Outback
<b>0 265 008 358</b>	SUBARU	Legacy, Legacy Kombi, Legacy Outback
<b>0 265 008 370</b>	MITSUBISHI	i-MiEV
<b>0 265 008 373</b>	NISSAN	Bluebird Sylphy, Cube, Tiida, Tiida Latio
<b>0 265 008 374</b>	NISSAN	Teana
<b>0 265 008 375</b>	NISSAN	Teana
<b>0 265 008 376</b>	NISSAN	Teana
<b>0 265 008 378</b>	NISSAN	Teana
<b>0 265 008 380</b>	INFINITI	G

de

**Drehzahlsensor**  
(Fortsetzung)

en

**Rotational-speed  
sensor**  
(continued)

fr

**Capteur de vitesse  
de rotation**  
(suite)

it

**Sensore giri**  
(seguito)

es

**Sensor  
de revoluciones**  
(continuación)



<b>0 265 008 381</b>	INFINITI	G, G Cabrio, G Coupé, Q60 Cabrio, Q60 Coupé
	NISSAN	370 Z Coupé, 370 Z Roadster, 370Z Coupé
<b>0 265 008 382</b>	INFINITI	EX
<b>0 265 008 383</b>	INFINITI	FX, FX50, QX70
<b>0 265 008 396</b>	NISSAN	Evalia, NV200
<b>0 265 008 422</b>	SUZUKI	Kizashi
<b>0 265 008 423</b>	SUZUKI	Kizashi
<b>0 265 008 424</b>	SUZUKI	Kizashi
<b>0 265 008 429</b>	IVECO	Daily
<b>0 265 008 430</b>	IVECO	Daily
<b>0 265 008 485</b>	CITROEN	C-Elysee, C3 Picasso
	PEUGEOT	207, 207+, 207 CC, 207 SW, 208, 301
<b>0 265 008 506</b>	NISSAN	NP300, Pickup
<b>0 265 008 507</b>	NISSAN	NP300, Pickup
<b>0 265 008 508</b>	NISSAN	NP300, Pickup
<b>0 265 008 509</b>	NISSAN	NP300, Pickup
<b>0 265 008 510</b>	NISSAN	NP300, Pickup
<b>0 265 008 511</b>	NISSAN	NP300, Pickup
<b>0 265 008 516</b>	INFINITI	M, Q70
<b>0 265 008 519</b>	NISSAN	Bluebird Sylphy, Cube, Tiida, Tiida Latio
<b>0 265 008 520</b>	NISSAN	Bluebird Sylphy, Cube, Tiida, Tiida Latio
<b>0 265 008 525</b>	MINI (BMW)	Cooper Countryman, Cooper One Countryman, Cooper Paceman, John Cooper Works Countryman, John Cooper Works Paceman
<b>0 265 008 526</b>	MINI (BMW)	Cooper Countryman, Cooper One Countryman, Cooper Paceman, John Cooper Works Countryman, John Cooper Works Paceman
<b>0 265 008 529</b>	INFINITI	EX, M, QX50, Q70
<b>0 265 008 530</b>	INFINITI	EX, M, QX50, Q70
	NISSAN	370 Z Coupé, 370 Z Roadster, 370Z Coupé
<b>0 265 008 531</b>	INFINITI	EX, FX, FX50, M, QX50, QX70, Q70
<b>0 265 008 563</b>	INFINITI	EX, G Cabrio, G Coupé, QX50, Q60 Cabrio, Q60 Coupé
	NISSAN	370 Z Coupé, 370 Z Roadster, 370Z Coupé
<b>0 265 008 564</b>	INFINITI	EX, G Cabrio, G Coupé, Q60 Cabrio, Q60 Coupé
	NISSAN	370 Z Coupé, 370 Z Roadster
<b>0 265 008 565</b>	NISSAN	Patrol GR
<b>0 265 008 566</b>	NISSAN	Patrol GR
<b>0 265 008 567</b>	NISSAN	Patrol GR
<b>0 265 008 568</b>	NISSAN	Patrol GR
<b>0 265 008 577</b>	INFINITI	EX, FX
<b>0 265 008 587</b>	NISSAN	NP300



<b>0 265 008 588</b>	NISSAN	NP300, Pickup
<b>0 265 008 600</b>	NISSAN	Evalia, NV200
<b>0 265 008 601</b>	NISSAN	Evalia, NV200
<b>0 265 008 620</b>	NISSAN	Qashqai, Qashqai+2
<b>0 265 008 633</b>	PEUGEOT	107, 108
	TOYOTA	Aygo
<b>0 265 008 662</b>	FORD	Transit
<b>0 265 008 665</b>	FORD	Transit
<b>0 265 008 668</b>	MITSUBISHI	i-MiEV
<b>0 265 008 669</b>	MITSUBISHI	i-MiEV
<b>0 265 008 755</b>	SUBARU	Impreza, Impreza Sedan, XV
<b>0 265 008 916</b>	OPEL	Vivaro
	RENAULT	Trafic II
	VAUXHALL	Vivaro
<b>0 265 008 917</b>	RENAULT	Kangoo II
<b>0 265 008 918</b>	RENAULT	Kangoo II
<b>0 265 008 919</b>	RENAULT	Kangoo II
<b>0 265 008 920</b>	RENAULT	Kangoo II
<b>0 265 008 921</b>	RENAULT	Kangoo II
<b>0 265 008 922</b>	DACIA	Logan, Logan MCV, Logan Pick-Up, Sandero
	RENAULT	Clio III, Clio III Grandtour, Logan, Modus, Sandero
<b>0 265 008 923</b>	RENAULT	Clio III, Clio III Grandtour, Modus
<b>0 265 008 925</b>	RENAULT	Clio III, Clio III Grandtour, Modus
<b>0 265 008 928</b>	RENAULT	Clio III
<b>0 265 008 936</b>	DACIA	Duster
	RENAULT	Duster
<b>0 265 008 937</b>	DACIA	Duster
	RENAULT	Duster
<b>0 265 008 939</b>	RENAULT	Megane III Coupé
<b>0 265 008 940</b>	RENAULT	Megane III Coupé
<b>0 265 008 941</b>	DACIA	Duster
	RENAULT	Duster, Fluence, Grand Scenic III, Megane III CC, Megane III Coupé, Megane III Grandtour, Megane III Hatchback, Meganell Hatchback, Scenic III
<b>0 265 008 942</b>	DACIA	Duster
	RENAULT	Duster
<b>0 265 008 944</b>	RENAULT	Clio II, Thalia
<b>0 265 008 945</b>	RENAULT	Clio II, Thalia
<b>0 265 008 946</b>	DACIA	Logan, Logan MCV, Sandero
	RENAULT	Logan, Sandero
<b>0 265 008 947</b>	DACIA	Logan, Logan MCV, Sandero
	RENAULT	Logan, Sandero
<b>0 265 009 ...</b>		
<b>0 265 009 227</b>	BMW	Serie 5, Serie 5 GT, Serie 5 Touring, Serie 6 Cabrio, Serie 6 Coupé, Serie 6 GC, Serie 7
	ROLLS-ROYCE	Ghost, Wraith
<b>0 265 009 270</b>	FORD	B-Max, Fiesta VI, Fiesta VII
<b>0 265 009 271</b>	FORD	EcoSport, Fiesta VI, Fiesta VII

nl

**Toerentalsensor**  
(vervolg)

sv

**Varvtalssensor**  
(fortsättning)

pt



**Sensor de velocidade**  
(continuação)



cs

**Snímač otáček**  
(pokračování)

ru

**Датчик числа оборотов**  
(продолжение)

		
<b>0 265 009 325</b>	LAND ROVER GROUP	Range Rover, Range Rover IV, Range Rover Sport
<b>0 265 009 326</b>	LAND ROVER GROUP	Range Rover, Range Rover IV, Range Rover Sport
<b>0 265 009 338</b>	MERCEDES-BENZ	Sprinter
<b>0 265 009 339</b>	MERCEDES-BENZ	Sprinter
<b>0 265 009 340</b>	MERCEDES-BENZ	Sprinter
<b>0 265 009 341</b>	MERCEDES-BENZ	Sprinter
<b>0 265 009 534</b>	FORD	B-Max, Fiesta VII, Tourneo Courier, Transit Courier
<b>0 265 009 588</b>	MERCEDES-BENZ	Sprinter
	VW (VOLKSWAGEN)	Crafter 30, Crafter 35, Crafter 50
<b>0 265 050 ...</b>		
<b>0 265 050 012</b>	IVECO	Daily
<b>0 265 050 026</b>	IVECO	Daily
<b>0 265 050 029</b>	IVECO	Daily
<b>0 986 594 ...</b>		
<b>0 986 594 000</b>	AUDI	A3, S3, TT Coupé, TT Roadster
	SEAT	Arosa, Cordoba, Cordoba Vario, Ibiza, Inca, Leon, Leon Cupra, Leon Cupra R, Toledo
	SKODA	Octavia, Octavia Combi
	VW (VOLKSWAGEN)	Bora, Bora Variant, Caddy, Golf, Golf Cabriolet, Golf III, Golf III Cabriolet, Golf III Variant, Golf IV, Golf IV Cabriolet, Golf IV Station Wagon, Golf IV Variant, Jetta, Jetta IV, Lupo, New Beetle, New Beetle Cabriolet, Passat, Passat Variant, Polo, Polo Classic, Polo Variant, Vento
<b>0 986 594 001</b>	AUDI	A3, S3, TT Coupé, TT Roadster
	SEAT	Arosa, Cordoba, Cordoba Vario, Ibiza, Inca, Leon, Leon Cupra, Leon Cupra R, Toledo
	SKODA	Octavia, Octavia Combi
	VW (VOLKSWAGEN)	Bora, Bora Variant, Caddy, Golf, Golf Cabriolet, Golf III, Golf III Cabriolet, Golf III Variant, Golf IV, Golf IV Cabriolet, Golf IV Station Wagon, Golf IV Variant, Jetta, Jetta IV, Lupo, New Beetle, New Beetle Cabriolet, Passat, Passat Variant, Polo, Polo Classic, Polo Variant, Vento

		
<b>0 986 594 002</b>	AUDI	A4, A4 Avant, S4, S4 Avant
	SKODA	Superb
	VW (VOLKSWAGEN)	Passat, Passat Variant
<b>0 986 594 003</b>	VW (VOLKSWAGEN)	Golf Cabriolet, Golf III, Golf III Cabriolet, Golf III Variant, Golf IV Cabriolet, Jetta, Vento
<b>0 986 594 004</b>	AUDI	A3, TT Coupé, TT Roadster
	SEAT	Arosa, Leon, Leon Cupra R, Toledo
	SKODA	Felicia Fun, Octavia, Octavia Combi
	VW (VOLKSWAGEN)	Bora, Bora Variant, Caddy Pickup, Golf, Golf IV, Golf IV Station Wagon, Golf IV Variant, Jetta, Jetta IV, Lupo, New Beetle, New Beetle Cabriolet
<b>0 986 594 005</b>	AUDI	A4, A4 Avant
<b>0 986 594 006</b>	AUDI	A6, A6 Avant
<b>0 986 594 007</b>	AUDI	A6, A6 Avant
<b>0 986 594 008</b>	AUDI	A3, S3, TT Coupé, TT Roadster
	SEAT	Leon, Leon Cupra
	SKODA	Octavia, Octavia Combi
	VW (VOLKSWAGEN)	Bora, Bora Variant, Golf IV, Golf IV Variant
<b>0 986 594 009</b>	SEAT	Cordoba, Cordoba Vario, Ibiza
	VW (VOLKSWAGEN)	Polo, Polo Classic, Polo Variant
<b>0 986 594 010</b>	FORD	Galaxy
	SEAT	Alhambra
	VW (VOLKSWAGEN)	Sharan
<b>0 986 594 011</b>	FORD	Galaxy
	SEAT	Alhambra
	VW (VOLKSWAGEN)	Sharan
<b>0 986 594 013</b>	VW (VOLKSWAGEN)	California T4, Caravelle T4, Eurovan, Kombi, Multivan T4, Transporter T4
<b>0 986 594 014</b>	AUDI	A4, A4 Avant, S4, S4 Avant
	VW (VOLKSWAGEN)	Passat, Passat Variant
<b>0 986 594 015</b>	BMW	Serie Z, Serie Z Coupé, Serie 3, Serie 3 Cabrio, Serie 3 Compact, Serie 3 Coupé, Serie 3 Touring
<b>0 986 594 016</b>	BMW	Serie 3, Serie 3 Cabrio, Serie 3 Coupé, Serie 3 Touring
<b>0 986 594 017</b>	BMW	Serie 3, Serie 3 Cabrio, Serie 3 Coupé, Serie 3 Touring
<b>0 986 594 018</b>	BMW	Serie 3, Serie 3 Cabrio, Serie 3 Coupé, Serie 3 Touring
<b>0 986 594 019</b>	CITROEN	Xantia, Xantia Break
<b>0 986 594 020</b>	CITROEN	Saxo
	PEUGEOT	106



de

**Drehzahlsensor**  
(Fortsetzung)

en

**Rotational-speed sensor**  
(continued)

fr

**Capteur de vitesse de rotation**  
(suite)

it

**Sensore giri**  
(seguito)

es

**Sensor de revoluciones**  
(continuación)

<b>0 986 594 021</b>	CITROEN	Xantia, Xantia Break
<b>0 986 594 022</b>	PEUGEOT	206, 206 CC, 206 SW
<b>0 986 594 023</b>	FORD	Fiesta IV, Fiesta IV Courier, Puma
	MAZDA	121
<b>0 986 594 024</b>	FORD	Ka, Streetka
<b>0 986 594 025</b>	OPEL	Combo, Corsa, Tigra
	VAUXHALL	Combo, Corsa, Tigra
<b>0 986 594 026</b>	OPEL	Astra, Astra Cabrio, Astra Caravan, Astra Classic, Astra Classic Caravan
	VAUXHALL	Astra, Astra Convertible, Astra Estate, Astra Van
<b>0 986 594 027</b>	OPEL	Combo, Corsa, Meriva, Tigra TwinTop
	VAUXHALL	Combo, Corsa, Meriva, Tigra TwinTop
<b>0 986 594 028</b>	OPEL	Combo, Corsa, Tigra
	VAUXHALL	Combo, Corsa, Tigra
<b>0 986 594 029</b>	FORD	Escort VII, Escort VII Cabrio, Escort VII Express, Escort VII RS, Escort VII Turnier, Escort VII XR3i Cabrio
<b>0 986 594 030</b>	RENAULT	Megane, Megane I, Megane I Cabrio, Megane I Classic, Megane I Coupé, Megane I Grandtour, Scenic, Scenic I
<b>0 986 594 031</b>	RENAULT	Twingo I
<b>0 986 594 500</b>	AUDI	A2
	SEAT	Cordoba, Ibiza, Ibiza SC, Ibiza ST, Leon, Leon Cupra, Leon Cupra SC, Leon SC, Leon ST, Leon ST Cupra, Mii, Toledo
	SKODA	Citigo, Fabia, Fabia Combi, Fabia RS, Fabia Schrägheck, Octavia, Octavia Combi, Octavia RS Combi, Praktik, Rapid, Rapid Spaceback, Roomster
	VW (VOLKSWAGEN)	e-Golf, e-up!, Fox, Golf Alltrack, Golf Sportsvan, Golf VII, Golf VII Variant, Passat, Passat, Passat Alltrack, Passat Variant, Polo, Polo Hatchback, Polo Limousine, Polo Sedan, Polo Vivo, up!



<b>0 986 594 501</b>	AUDI	A2
	SEAT	Cordoba, Ibiza, Ibiza SC, Ibiza ST, Leon, Leon Cupra, Leon Cupra SC, Leon SC, Leon ST, Leon ST Cupra, Mii, Toledo
	SKODA	Citigo, Fabia, Fabia Combi, Fabia RS, Fabia Schrägheck, Octavia, Octavia Combi, Octavia RS Combi, Praktik, Rapid, Rapid Spaceback, Roomster
	VW (VOLKSWAGEN)	e-Golf, e-up!, Fox, Golf Alltrack, Golf Sportsvan, Golf VII, Golf VII Variant, Passat, Passat, Passat Alltrack, Passat Variant, Polo, Polo Hatchback, Polo Limousine, Polo Sedan, Polo Vivo, up!
<b>0 986 594 502</b>	AUDI	A2
	SEAT	Cordoba, Ibiza, Ibiza SC
	SKODA	Citigo, Fabia, Fabia Combi, Fabia RS, Fabia Schrägheck, Praktik, Rapid, Rapid Spaceback, Roomster
	VW (VOLKSWAGEN)	e-up!, Fox, Polo, Polo Hatchback, Polo Limousine, Polo Sedan, Polo Vivo, up!
<b>0 986 594 503</b>	AUDI	A2
	SEAT	Cordoba, Ibiza, Ibiza SC
	SKODA	Citigo, Fabia, Fabia Combi, Fabia RS, Fabia Schrägheck, Praktik, Rapid, Rapid Spaceback, Roomster
	VW (VOLKSWAGEN)	e-up!, Fox, Polo, Polo Hatchback, Polo Limousine, Polo Sedan, Polo Vivo, up!
<b>0 986 594 504</b>	AUDI	A1, A1 Sportback, A3, A3 Cabriolet, A3 Limousine, A3 Sportback, Q3, Q3 RS, RS3 Sportback, S1, S1 Sportback, S3, S3 Cabriolet, S3 Limousine, S3 Sportback, TT Coupé, TT Roadster, TT RS Coupé, TT RS Roadster, TTS Coupé, TTS Roadster
	PORSCHE	Carrera GT, Carrera GT Convertible
	SEAT	Alhambra, Altea, Altea Freetrack, Altea XL, Leon, Leon Cupra, Leon ST, Toledo
	SKODA	Octavia, Octavia Combi, Superb, Superb Combi, Yeti

nl

**Toerentalsensor**  
(vervolg)

sv

**Varvtalssensor**  
(fortsättning)

pt





**Sensor de velocidade**  
(continuação)

cs

**Snímač otáček**  
(pokračování)

ru

**Датчик числа оборотов**  
(продолжение)

						
<b>0 986 594 504</b>	VW (VOLKSWAGEN)	Amarok, Beetle, Beetle Cabriolet, Caddy, Caddy Panel Van, California T5, California T6, Caravelle T5, Caravelle T6, CC, Eos, Golf Alltrack, Golf Plus, Golf V, Golf V Variant, Golf VI, Golf VI Cabriolet, Golf VI Variant, Golf VII, Golf VII Variant, Jetta, Jetta V, Multivan T5, Multivan T6, Passat, Passat Alltrack, Passat CC, Passat Variant, Scirocco, Scirocco R, Sharan, Tiguan, Touran, Touuran, Transporter T5, Transporter T6		<b>0 986 594 507</b>	AUDI	A1, A1 Sportback, A3, A3 Cabriolet, A3 Sportback, Q3, S1, S1 Sportback, TT Coupé, TT Roadster, TT RS Coupé, TT RS Roadster
<b>0 986 594 505</b>	AUDI	A3, A3 Cabriolet, A3 Limousine, A3 Sportback, Q3, Q3 RS, RS3 Sportback, S3, S3 Cabriolet, S3 Limousine, S3 Sportback, TT Coupé, TT Roadster, TT RS Coupé, TT RS Roadster, TTS Coupé, TTS Roadster			SEAT	Altea, Altea Freetrack, Altea XL, Leon, Leon Cupra, Leon Cupra, Toledo
	PORSCHE	Carrera GT, Carrera GT Convertible			SKODA	Octavia, Octavia Combi, Superb, Superb Combi, Yeti
	SEAT	Alhambra, Altea, Altea Freetrack, Altea XL, Leon, Leon Cupra, Leon ST, Toledo			VW (VOLKSWAGEN)	Beetle, Beetle Cabriolet, Eos, Golf Plus, Golf V, Golf V Variant, Golf VI, Golf VI Cabriolet, Golf VI Variant, Jetta, Jetta V, Passat, Passat CC, Passat Variant, Scirocco, Scirocco R, Sharan, Tiguan, Touran, Touuran
	SKODA	Octavia, Octavia Combi, Superb, Superb Combi, Yeti		<b>0 986 594 508</b>	BMW	Serie 5, Serie 5 Touring
	VW (VOLKSWAGEN)	Amarok, Beetle, Beetle Cabriolet, Caddy, Caddy Panel Van, California T5, California T6, Caravelle T5, Caravelle T6, CC, Eos, Golf Alltrack, Golf Plus, Golf V, Golf V Variant, Golf VI, Golf VI Cabriolet, Golf VI Variant, Golf VII, Golf VII Variant, Jetta, Jetta V, Multivan T5, Multivan T6, Passat, Passat Alltrack, Passat CC, Passat Variant, Scirocco, Scirocco R, Sharan, Tiguan, Touran, Touuran, Transporter T5, Transporter T6		<b>0 986 594 509</b>	BMW	Serie 5
<b>0 986 594 506</b>	AUDI	A3, A3 Cabriolet, A3 Sportback, Q3, TT Coupé, TT Roadster		<b>0 986 594 510</b>	BMW	Serie 5, Serie 5 Touring
	SEAT	Altea, Altea Freetrack, Altea XL, Leon, Leon Cupra, Toledo		<b>0 986 594 511</b>	BMW	Serie 5
	SKODA	Octavia, Octavia Combi, Superb, Superb Combi, Yeti		<b>0 986 594 512</b>	BMW	Serie 5 Touring
	VW (VOLKSWAGEN)	Beetle, Beetle Cabriolet, Eos, Golf Plus, Golf V, Golf V Variant, Golf VI, Golf VI Cabriolet, Golf VI Variant, Jetta, Jetta V, Passat, Passat CC, Passat Variant, Scirocco, Scirocco R, Sharan, Tiguan, Touran, Touuran		<b>0 986 594 513</b>	BMW	Serie 3, Serie 3 Cabrio, Serie 3 Compact, Serie 3 Coupé, Serie 3 Touring
	AUDI	A3, A3 Cabriolet, A3 Sportback, Q3, TT Coupé, TT Roadster		<b>0 986 594 514</b>	BMW	Serie 1, Serie 1 Cabrio, Serie 1 Coupé, Serie 3, Serie 3 Cabrio, Serie 3 Coupé, Serie 3 Touring
	SEAT	Altea, Altea Freetrack, Altea XL, Leon, Leon Cupra, Toledo		<b>0 986 594 515</b>	FORD	Focus I, Focus I Turnier
	SKODA	Octavia, Octavia Combi, Superb, Superb Combi, Yeti		<b>0 986 594 516</b>	FORD	Fiesta V
	VW (VOLKSWAGEN)	Beetle, Beetle Cabriolet, Eos, Golf Plus, Golf V, Golf V Variant, Golf VI, Golf VI Cabriolet, Golf VI Variant, Jetta, Jetta V, Passat, Passat CC, Passat Variant, Scirocco, Scirocco R, Sharan, Tiguan, Touran, Touuran		<b>0 986 594 517</b>	FORD	Focus I, Focus I Turnier
	AUDI	A3, A3 Cabriolet, A3 Sportback, Q3, TT Coupé, TT Roadster		<b>0 986 594 518</b>	FORD	Focus, Focus I, Focus I Turnier
	SEAT	Altea, Altea Freetrack, Altea XL, Leon, Leon Cupra, Toledo		<b>0 986 594 519</b>	BMW	Serie 1, Serie 1 Cabrio, Serie 1 Coupé, Serie 3, Serie 3 Cabrio, Serie 3 Coupé, Serie 3 Touring
	SKODA	Octavia, Octavia Combi, Superb, Superb Combi, Yeti		<b>0 986 594 520</b>	CITROEN	C6
	VW (VOLKSWAGEN)	Beetle, Beetle Cabriolet, Eos, Golf Plus, Golf V, Golf V Variant, Golf VI, Golf VI Cabriolet, Golf VI Variant, Jetta, Jetta V, Passat, Passat CC, Passat Variant, Scirocco, Scirocco R, Sharan, Tiguan, Touran, Touuran			PEUGEOT	407, 407 Coupé, 407 SW
	AUDI	A3, A3 Cabriolet, A3 Sportback, Q3, TT Coupé, TT Roadster		<b>0 986 594 521</b>	CITROEN	C6
	SEAT	Altea, Altea Freetrack, Altea XL, Leon, Leon Cupra, Toledo			PEUGEOT	407, 407 Coupé, 407 SW
	SKODA	Octavia, Octavia Combi, Superb, Superb Combi, Yeti		<b>0 986 594 522</b>	CITROEN	C5, C5 Tourer, C6
	VW (VOLKSWAGEN)	Beetle, Beetle Cabriolet, Eos, Golf Plus, Golf V, Golf V Variant, Golf VI, Golf VI Cabriolet, Golf VI Variant, Jetta, Jetta V, Passat, Passat CC, Passat Variant, Scirocco, Scirocco R, Sharan, Tiguan, Touran, Touuran			PEUGEOT	407, 407 Coupé, 407 SW
	AUDI	A3, A3 Cabriolet, A3 Sportback, Q3, TT Coupé, TT Roadster		<b>0 986 594 523</b>	CITROEN	C5, C5 Tourer, C6
	SEAT	Altea, Altea Freetrack, Altea XL, Leon, Leon Cupra, Toledo			PEUGEOT	407, 407 Coupé, 407 SW
	SKODA	Octavia, Octavia Combi, Superb, Superb Combi, Yeti				

de

**Drehzahlsensor**  
(Fortsetzung)

en

**Rotational-speed  
sensor**  
(continued)

fr

**Capteur de vitesse  
de rotation**  
(suite)

it

**Sensore giri**  
(seguito)

es

**Sensor  
de revoluciones**  
(continuación)



<b>0 986 594 524</b>	AUDI	A3, A3 Cabriolet, A3 Limousine, A3 Sportback, Maxxum, Q3, Q7, S3, S3 Cabriolet, S3 Limousine, S3 Sportback, TT Coupé, TT Roadster, TTS Coupé, TTS Roadster
	PORSCHE	Cayenne
	SEAT	Alhambra
	VW (VOLKSWAGEN)	Caddy, CC, Golf Alltrack, Golf VII, Golf VII Variant, Passat, Passat, Passat Alltrack, Passat Variant, Tiguan, Touareg, Transporter T5
<b>0 986 594 525</b>	AUDI	A3, A3 Cabriolet, A3 Limousine, A3 Sportback, Maxxum, Q3, Q7, S3, S3 Cabriolet, S3 Limousine, S3 Sportback, TT Coupé, TT Roadster, TTS Coupé, TTS Roadster
	PORSCHE	Cayenne
	SEAT	Alhambra
	VW (VOLKSWAGEN)	Caddy, CC, Golf Alltrack, Golf VII, Golf VII Variant, Passat, Passat, Passat Alltrack, Passat Variant, Tiguan, Touareg
<b>0 986 594 526</b>	AUDI	A3, A3 Cabriolet, A3 Limousine, A3 Sportback, A3 Sportsback
	SEAT	Leon, Leon Cupra, Leon Cupra SC, Leon SC, Leon ST, Leon ST Cupra
	SKODA	Octavia, Octavia Combi, Octavia RS Combi
	VW (VOLKSWAGEN)	Caddy, Caddy Panel Van, e-Golf, Golf Alltrack, Golf Sportsvan, Golf VII, Golf VII Variant
<b>0 986 594 527</b>	BMW	Serie Z, Serie Z Coupé, Serie 3, Serie 3 Cabrio, Serie 3 Compact, Serie 3 Coupé, Serie 3 Touring
<b>0 986 594 528</b>	BMW	Serie Z, Serie Z Coupé, Serie 3, Serie 3 Cabrio, Serie 3 Compact, Serie 3 Coupé, Serie 3 Touring
<b>0 986 594 529</b>	BMW	Serie X
<b>0 986 594 530</b>	BMW	Serie X
<b>0 986 594 531</b>	ALPINA (B. BOVEN-SIEPEN KG)	Roadster
	BMW	Serie Z, Serie 7
<b>0 986 594 532</b>	BMW	Serie Z, Serie Z Coupé
<b>0 986 594 533</b>	BMW	Serie 5 Touring
<b>0 986 594 534</b>	FORD	Tourneo Connect, Transit Connect
<b>0 986 594 535</b>	FORD	Tourneo Connect, Transit Connect
<b>0 986 594 536</b>	MINI (BMW)	Cooper, Cooper Cabrio, Cooper One, Cooper One Cabrio, Cooper S, John Cooper Works, John Cooper Works Cabrio



<b>0 986 594 537</b>	MINI (BMW)	Cooper, Cooper Cabrio, Cooper One, Cooper One Cabrio, Cooper S, John Cooper Works, John Cooper Works Cabrio
	MG	ZT, ZT-Tourer
<b>0 986 594 538</b>	ROVER	75, 75 Tourer
	MG	ZT, ZT-Tourer
<b>0 986 594 539</b>	ROVER	75, 75 Tourer
	BMW	Serie 1, Serie 1 Cabrio, Serie 1 Coupé, Serie 3, Serie 3 Cabrio, Serie 3 Coupé, Serie 3 Touring
<b>0 986 594 541</b>	MERCEDES-BENZ	Serie C, Serie C (Sportcoupe), Serie C (T-Modell), Serie CLC, Serie CLK (Cabrio), Serie CLK (Coupé)
	MERCEDES-BENZ	Serie C, Serie C (Sportcoupe), Serie C (T-Modell), Serie CLC, Serie CLK (Cabrio), Serie CLK (Coupé)
<b>0 986 594 542</b>	MERCEDES-BENZ	Serie C, Serie C (Sportcoupe), Serie C (T-Modell), Serie CLC, Serie CLK (Cabrio), Serie CLK (Coupé), Serie SLK
	MERCEDES-BENZ	Serie C, Serie C (T-Modell)
<b>0 986 594 543</b>	MERCEDES-BENZ	Serie C, Serie C (Coupé), Serie C (T-Modell)
<b>0 986 594 544</b>	MERCEDES-BENZ	Serie GLK
<b>0 986 594 545</b>	MERCEDES-BENZ	Serie C, Serie C (Coupé), Serie C (T-Modell)
<b>0 986 594 546</b>	MERCEDES-BENZ	Serie C, Serie C (Coupé), Serie C (T-Modell)
<b>0 986 594 547</b>	MERCEDES-BENZ	Serie C, Serie C (Coupé), Serie C (T-Modell)
<b>0 986 594 548</b>	MERCEDES-BENZ	Serie C, Serie C (Coupé), Serie C (T-Modell)
<b>0 986 594 549</b>	MERCEDES-BENZ	Serie SLK
<b>0 986 594 550</b>	MERCEDES-BENZ	Serie SLK
<b>0 986 594 551</b>	CITROEN	C2, C3, C3-Pluriel
<b>0 986 594 552</b>	CITROEN	C2, C3, C3-Pluriel
<b>0 986 594 553</b>	PEUGEOT	206, 206+, 206 CC, 206 Sedan, 206 SW
	FORD	C-MAX, Focus C-MAX, Focus II, Focus II Cabriolet, Focus II Turnier, Galaxy, Kuga, Mondeo IV, Mondeo IV Turnier, S-MAX, Tourneo Connect, Transit Connect
<b>0 986 594 554</b>	FORD	C-MAX, Focus C-MAX, Focus II, Focus II Cabriolet, Focus II Turnier, Galaxy, Kuga, Mondeo IV, Mondeo IV Turnier, S-MAX

nl

**Toerentalsensor**  
(vervolg)

sv

**Varvtalssensor**  
(fortsättning)

pt



**Sensor de velocidade**  
(continuação)

cs

**Snímač otáček**  
(pokračování)

ru

**Датчик числа оборотов**  
(продолжение)

		
<b>0 986 594 556</b>	FORD	C-MAX, Focus C-MAX, Focus II, Focus II Cabriolet, Focus II Turnier, Mondeo IV, Mondeo IV Turnier
<b>0 986 594 557</b>	FORD	Fusion
<b>0 986 594 558</b>	PEUGEOT	206, 206+, 206 CC, 206 Sedan, 206 SW
<b>0 986 594 559</b>	CITROEN	C4, C4 Coupé, C4 Sedan
	PEUGEOT	307, 307 Break/SW, 307 CC, 307 Sedan
<b>0 986 594 560</b>	AUDI	Q3
	SEAT	Alhambra
	SKODA	Superb, Superb Combi, Yeti
	VW (VOLKSWAGEN)	CC, Eos, Golf VI Cabriolet, Jetta, Passat, Passat Alltrack, Passat CC, Passat Variant, Scirocco, Scirocco R, Sharan, Tiguan, Touran, Touuran
<b>0 986 594 561</b>	AUDI	Q3
	SEAT	Alhambra
	SKODA	Superb, Superb Combi, Yeti
	VW (VOLKSWAGEN)	CC, Eos, Golf VI Cabriolet, Jetta, Passat, Passat Alltrack, Passat CC, Passat Variant, Scirocco, Scirocco R, Sharan, Tiguan, Touran, Touuran
<b>0 986 594 562</b>	CITROEN	C5, C5 Tourer, C6
	PEUGEOT	407, 407 Coupé, 407 SW
<b>0 986 594 563</b>	MERCEDES-BENZ	Serie CLS, Serie E, Serie E (T-Modell)
<b>0 986 594 564</b>	PEUGEOT	206, 206 CC, 206 Sedan, 206 SW
<b>0 986 594 565</b>	BMW	Serie 1, Serie 1 Cabrio, Serie 1 Coupé, Serie 3, Serie 3 Cabrio, Serie 3 Touring
<b>0 986 594 566</b>	CITROEN	C8
	FIAT	Ulysse
	LANCIA	Phedra
	PEUGEOT	807
<b>0 986 594 567</b>	CITROEN	C5, C5 Tourer, C6
	PEUGEOT	407, 407 Coupé, 407 SW
<b>0 986 594 568</b>	CITROEN	C5, C5 Break
<b>0 986 594 569</b>	FORD	Kuga
	VOLVO	S40 II, V50
<b>0 986 594 571</b>	BMW	Serie 1, Serie 1 Cabrio, Serie 1 Coupé, Serie 3, Serie 3 Coupé
<b>0 986 594 572</b>	BMW	Serie 1, Serie 1 Cabrio, Serie 1 Coupé, Serie 3, Serie 3 Cabrio, Serie 3 Coupé, Serie 3 Touring

		
<b>F 01G 09F ...</b>		
<b>F 01G 09F 0AF</b>	MAZDA	MX-5
<b>F 01G 09F 0AG</b>	MAZDA	MX-5
<b>F 01G 09F 0A2</b>	NISSAN	Maxima QX
<b>F 01G 09F 0A3</b>	NISSAN	Maxima QX
<b>F 01G 09F 0A4</b>	NISSAN	Frontier, Pickup
<b>F 01G 09F 0A5</b>	NISSAN	Frontier, Hardbody, Pickup
<b>F 01G 09F 0BY</b>	NISSAN	Pickup
<b>F 01G 09F 0BZ</b>	NISSAN	Pickup
<b>F 01G 09F 0B2</b>	MAZDA	E-Serie, Serie E
<b>F 01G 09F 0B3</b>	MAZDA	E-Serie, Serie E
<b>F 01G 09F 0DK</b>	NISSAN	Pathfinder
<b>F 01G 09F 0DL</b>	NISSAN	Pathfinder
<b>F 01G 09F 0DZ</b>	MAZDA	Colt, Lancer, Lancer Sedan
<b>F 01G 09F 0D9</b>	NISSAN	Hardbody, Pickup
<b>F 01G 09F 0EH</b>	MAZDA	MPV
<b>F 01G 09F 0EJ</b>	NISSAN	Colt, Lancer
<b>F 01G 09F 0EK</b>	NISSAN	Lancer
<b>F 01G 09F 0EL</b>	NISSAN	Maxima QX
<b>F 01G 09F 0EM</b>	NISSAN	Maxima QX
<b>F 01G 09F 0EN</b>	NISSAN	Lancer Evo4, Lancer Evo5/6
<b>F 01G 09F 0EP</b>	NISSAN	Lancer Evo4, Lancer Evo5/6
<b>F 01G 09F 0ER</b>	NISSAN	Lancer Evo4, Lancer Evo5/6
<b>F 01G 09F 0ES</b>	NISSAN	Lancer Evo4, Lancer Evo5/6
<b>F 01G 09F 0EU</b>	MAZDA	MPV
<b>F 01G 09F 0EX</b>	NISSAN	Hardbody, NP300, Pickup
<b>F 01G 09F 0EY</b>	NISSAN	Hardbody, NP300, Pickup
<b>F 01G 09F 0FJ</b>	NISSAN	Hardbody, Pickup
<b>F 01G 09F 0FK</b>	NISSAN	Hardbody, NP300, Pickup
<b>F 01G 09F 0FL</b>	NISSAN	Hardbody, NP300, Pickup
<b>F 01G 09F 0FY</b>	MAZDA	MX-5
<b>F 01G 09F 0FZ</b>	MAZDA	MX-5
<b>F 01G 09F 0F7</b>	NISSAN	Patrol GR, Safari
<b>F 01G 09F 0F8</b>	NISSAN	Patrol GR, Safari
<b>F 01G 09F 0GA</b>	NISSAN	AD Van, Almera Sedan, Pulsar
<b>F 01G 09F 0GB</b>	NISSAN	AD Van, Almera Sedan, Pulsar
<b>F 01G 09F 0GS</b>	MAZDA	E-Serie, Serie E
<b>F 01G 09F 0GT</b>	MAZDA	E-Serie, Serie E
<b>F 01G 09F 0HC</b>	MAZDA	MX-5
<b>F 01G 09F 0HD</b>	MAZDA	MX-5
<b>F 01G 09F 0HF</b>	NISSAN	Pathfinder
<b>F 01G 09F 0HG</b>	NISSAN	Pathfinder
<b>F 01G 09F 0HP</b>	NISSAN	Pickup
<b>F 01G 09F 0HR</b>	NISSAN	Pickup
<b>F 01G 09F 0HU</b>	NISSAN	Pickup
<b>F 01G 09F 0HV</b>	NISSAN	Pickup
<b>F 01G 09F 0HY</b>	NISSAN	Patrol GR, Safari
<b>F 01G 09F 0HZ</b>	NISSAN	Patrol GR, Safari
<b>F 01G 09F 0H6</b>	NISSAN	AD Van, Almera Sedan, Pulsar
<b>F 01G 09F 0H7</b>	NISSAN	Pathfinder
<b>F 01G 09F 0H8</b>	NISSAN	Pathfinder
<b>F 01G 09F 0J0</b>	NISSAN	Pickup
<b>F 01G 09F 0P2</b>	MAZDA	RX-7 Coupé
<b>F 01G 09F 0P3</b>	MAZDA	RX-7 Coupé

de

**Drehzahlsensor**  
(Fortsetzung)

en

**Rotational-speed sensor**  
(continued)

fr

**Capteur de vitesse de rotation**  
(suite)

it

**Sensore giri**  
(seguito)

es

**Sensor de revoluciones**  
(continuación)

nl

**Toerentalsensor**  
(vervolg)

sv

**Varvtalsensor**  
(fortsättning)

pt

**Sensor de velocidade**  
(continuação)

cs

**Snímač otáček**  
(pokračování)

ru

**Датчик числа оборотов**  
(продолжение)



<b>F 01G 09F 0P4</b>	NISSAN	AD Van, Almera Sedan, Pulsar
<b>F 01G 09F 00U</b>	MITSUBISHI	Lancer Hatchback
<b>F 01G 09F 00V</b>	MITSUBISHI	Lancer Hatchback
<b>F 01G 09F 00W</b>	NISSAN	Maxima
<b>F 01G 09F 00X</b>	NISSAN	Maxima
<b>F 01G 09F 01C</b>	NISSAN	Primera Wagon
<b>F 01G 09F 01D</b>	NISSAN	Primera Wagon
<b>F 01G 09F 01M</b>	MITSUBISHI	Space Runner, Space Wagon
<b>F 01G 09F 01N</b>	MITSUBISHI	Space Runner, Space Wagon
<b>F 01G 09F 01P</b>	MITSUBISHI	Pajero, Pajero Cabrio
<b>F 01G 09F 01R</b>	MITSUBISHI	Pajero, Pajero Cabrio
<b>F 01G 09F 02D</b>	MAZDA	RX-7 Coupé
<b>F 01G 09F 02E</b>	MAZDA	RX-7 Coupé
<b>F 01G 09F 02J</b>	MAZDA	RX-7 Coupé
<b>F 01G 09F 02K</b>	MAZDA	RX-7 Coupé
<b>F 01G 09F 04G</b>	NISSAN	Primera Wagon
<b>F 01G 09F 04S</b>	NISSAN	Maxima
<b>F 01G 09F 04V</b>	NISSAN	300 ZX
<b>F 01G 09F 04W</b>	NISSAN	300 ZX
<b>F 01G 09F 04Y</b>	NISSAN	300 ZX
<b>F 01G 09F 04Z</b>	NISSAN	Pulsar Hatchback, Sunny Hatchback, Sunny Sedan, 100 NX
<b>F 01G 09F 05A</b>	NISSAN	Sunny Sedan
<b>F 01G 09F 05C</b>	NISSAN	Primera Wagon
<b>F 01G 09F 05J</b>	MITSUBISHI	3000 GT
<b>F 01G 09F 05K</b>	MITSUBISHI	3000 GT
<b>F 01G 09F 05L</b>	MITSUBISHI	3000 GT
<b>F 01G 09F 05M</b>	MITSUBISHI	3000 GT
<b>F 01G 09F 05R</b>	NISSAN	Serena
<b>F 01G 09F 05S</b>	NISSAN	Serena
<b>F 01G 09F 05T</b>	MITSUBISHI	Space Runner, Space Wagon
<b>F 01G 09F 05U</b>	MITSUBISHI	Space Runner, Space Wagon
<b>F 01G 09F 06A</b>	NISSAN	Serena
<b>F 01G 09F 06U</b>	NISSAN	Pathfinder
<b>F 01G 09F 06V</b>	NISSAN	Pathfinder
<b>F 01G 09F 06W</b>	NISSAN	Serena
<b>F 01G 09F 06X</b>	NISSAN	Serena
<b>F 01G 09F 07F</b>	NISSAN	Patrol GR
<b>F 01G 09F 07G</b>	NISSAN	Patrol GR
<b>F 01G 09F 07Z</b>	NISSAN	Maxima QX
<b>F 01G 09F 08H</b>	NISSAN	Maxima QX
<b>F 01G 09F 08J</b>	NISSAN	Maxima QX
<b>F 01G 09F 09K</b>	MAZDA	MPV
<b>F 01G 09F 09L</b>	MAZDA	MPV
<b>F 01G 09F 09M</b>	MAZDA	MX-5
<b>F 01G 09F 09N</b>	MAZDA	MX-5
<b>F 01G 09F 09P</b>	MITSUBISHI	Pajero
<b>F 01G 09F 09R</b>	MITSUBISHI	Pajero
<b>F 01G 09F 09S</b>	MITSUBISHI	Pajero
<b>F 01G 09F 016</b>	NISSAN	Pulsar Hatchback, Sunny Hatchback, Sunny Sedan, 100 NX



<b>F 01G 09F 017</b>	NISSAN	Pulsar Hatchback, Sunny Hatchback, Sunny Sedan, 100 NX
<b>F 01G 09F 036</b>	MITSUBISHI	Pajero, Pajero Cabrio
<b>F 01G 09F 050</b>	NISSAN	Pulsar Hatchback, Sunny Hatchback, Sunny Sedan, 100 NX
<b>F 01G 09F 057</b>	NISSAN	Sunny Sedan
<b>F 01G 09F 058</b>	NISSAN	Sunny Sedan
<b>F 01G 09F 059</b>	NISSAN	Sunny Sedan
<b>F 01G 09F 069</b>	NISSAN	Serena
<b>F 01G 09F 080</b>	NISSAN	Maxima QX
<b>F 01G 09F 095</b>	MITSUBISHI	Space Runner, Space Wagon
<b>F 01G 09F 096</b>	MITSUBISHI	Space Runner, Space Wagon
<b>F 01G 065 ...</b>		
<b>F 01G 065 0AC</b>	SUBARU	SVX
<b>F 01G 065 0K0</b>	SUBARU	Impreza Kombi, Impreza Sedan
<b>F 01G 065 0K1</b>	SUBARU	Impreza Kombi, Impreza Sedan
<b>F 01G 065 0K2</b>	SUBARU	Impreza Kombi, Impreza Sedan
<b>F 01G 065 0K3</b>	SUBARU	Impreza Kombi, Impreza Sedan
<b>F 01G 065 0K6</b>	SUBARU	Forester
<b>F 01G 065 0K7</b>	SUBARU	Forester
<b>F 01G 065 0LK</b>	SUBARU	Legacy Kombi, Legacy Sedan
<b>F 01G 065 0LL</b>	SUBARU	Legacy Kombi, Legacy Sedan
<b>F 01G 065 0LM</b>	SUBARU	Legacy Outback
<b>F 01G 065 0LN</b>	SUBARU	Legacy Outback
<b>F 01G 065 0LR</b>	SUBARU	Impreza Kombi, Impreza Sedan
<b>F 01G 065 0LS</b>	SUBARU	Impreza Kombi, Impreza Sedan
<b>F 01G 065 0LT</b>	SUBARU	Forester
<b>F 01G 065 0LU</b>	SUBARU	Forester
<b>F 01G 065 0L7</b>	SUBARU	Forester
<b>F 01G 065 0L8</b>	SUBARU	Forester
<b>F 01G 065 0MR</b>	SUBARU	Impreza Kombi, Impreza Outback, Impreza Sedan
<b>F 01G 065 0MS</b>	SUBARU	Impreza Kombi, Impreza Outback, Impreza Sedan
<b>F 01G 065 0NX</b>	SUBARU	Forester
<b>F 01G 065 0NY</b>	SUBARU	Forester
<b>F 01G 065 0PE</b>	SUBARU	Impreza Kombi, Impreza Outback, Impreza Sedan, Legacy Kombi, Legacy Sedan
<b>F 01G 065 0PF</b>	SUBARU	Forester, Legacy Outback
<b>F 01G 065 0PG</b>	SUBARU	Legacy Kombi, Legacy Outback, Legacy Sedan
<b>F 01G 065 0PH</b>	SUBARU	Legacy Kombi, Legacy Outback, Legacy Sedan
<b>F 01G 065 0PJ</b>	SUBARU	Impreza Kombi, Impreza Sedan
<b>F 01G 065 0PK</b>	SUBARU	Impreza Kombi, Impreza Sedan
<b>F 01G 065 0PL</b>	SUBARU	Forester
<b>F 01G 065 0PM</b>	SUBARU	Forester

de

**Verwendungsteil****Benutzerhinweise**

In diesem Katalog sind die Daten von Fahrzeugen, Motoren und Geräten für den europäischen Markt von Baujahr 1994 bis einschließlich 2015 erfasst. Diese wurden aus Hersteller- und Importeurangaben, aus Fahrzeuguntersuchungen sowie aus Unterlagen von Bosch nach bestem Wissen sorgfältig zusammengestellt und geben den Stand zum Zeitpunkt der Drucklegung wieder.

Zwangsläufige Abweichungen durch länderspezifische technische Änderungen können nie ganz ausgeschlossen werden. Bosch kann daher insoweit nicht für die Vollständigkeit und Fehlerfreiheit der Daten haften. Für Irrtümer und Druckfehler, die zu Schäden am Eigentum oder Vermögen führen, haftet Bosch nur bei grob fahrlässiger Pflichtverletzung und bei Vorsatz für unmittelbare Schäden. Bei Personenschäden haftet Bosch auch bei leichter Fahrlässigkeit.

en

**Applications****Notes for users**

This catalog contains the data from the vehicles, engines, and equipment for the European market from year of manufacture 1994 up to and including the year 2015. This data has been assembled from information provided by manufacturers and importers, and taken from Bosch documentation, as well as from investigations made on vehicles. It has been compiled to the best of our knowledge and belief, and reflects the status at the date of going to print.

Inevitable deviations due to country-specific technical changes can never be completely excluded. Therefore, Bosch in this respect cannot be responsible for the completeness and accuracy of the data. For mistakes and misprint, which lead to damage of property or fortune, Bosch is also liable only in case of grossly negligent violation of duties and in case of intention for direct damage. In case of personal injury, Bosch is also liable concerning slight negligence.

fr

**Affectations****A l'attention de l'utilisateur**

Le présent catalogue mentionne les données spécifiques de véhicules, moteurs et appareils pour le marché européen depuis l'année de fabrication 1994 jusqu'au millésime 2015 inclus. Ces informations ont été rassemblées soigneusement et en toute impartialité à partir des indications des constructeurs et importateurs, des contrôles techniques des véhicules et de la documentation Bosch, et matérialisent le stade des connaissances au moment de la mise sous presse.

Des écarts inévitables ne peuvent jamais être complètement exclus en raison des différences spécifiques à chaque pays. Bosch ne peut donc pas à cet égard être tenu responsable de l'exactitude des données. Pour des erreurs et fautes d'impression, qui causeraient des dégâts matériels, Bosch est responsable seulement en cas de violation de ses obligations par faute lourde intentionnelle en ce qui concerne les dommages matériels. En cas de dommages corporels, Bosch peut être également tenu pour responsable dans les cas de faute légère.

it

**Impiego****Avvertenze per la consultazione**

Nella seguente parte di catalogo sono contemplati veicoli, motori ed apparecchi a partire dall'anno di costruzione 1994 fino all'anno 2015. Tali informazioni sono state rilevate dalle documentazioni di Case Auto, Importatori, da verifiche eseguite sui veicoli, così come da documentazione Bosch.

Eventuali discordanze, dovute a variazioni delle caratteristiche tecniche per specifici Paesi, non possono essere contemplate. Bosch non potrà quindi essere considerata responsabile per mancanze o inesattezze dei dati. Per eventuali danni a cose o danni patrimoniali, dovuti ad errori o refusi di stampa, Bosch è responsabile solo in caso di dolo o colpa grave. In caso di danni alla persona, Bosch è responsabile anche in caso di colpa meno grave.

es

**Aplicación****Instrucciones para el usuario**

Los datos de este catálogo para vehículos, motores y utensilios del mercado europeo comprenden los años de construcción desde 1994 hasta 2015 inclusive. Éstos son creados para la edición indicada sobre la base de documentos de Bosch, exámenes o inspecciones de vehículos así como datos de fabricantes e importadores.

Las diferentes especificaciones técnicas propias de cada país nunca pueden ser excluidas completamente. Por lo tanto, Bosch en este aspecto, no puede ser responsable de la absoluta exactitud de los datos. En el caso de errores, incluidos los de imprenta, que generen daños ó pérdidas de la propiedad o posesiones, Bosch es responsable únicamente en los casos de violación negligente de sus obligaciones y en el supuesto de intención o dolo para el daño directo. Bosch está también obligado a responder en casos de injurias personales por negligencia.

nl

**Gebruiksdeel****Gebruikersinstructies**

In deze catalogus zijn de gegevens van voertuigen, motoren en apparaten voor de Europese markt vanaf bouwjaar 1994 tot en met bouwjaar 2015 opgenomen. Deze zijn naar eer en geweten zorgvuldig samengesteld uit fabrikant- en importeursgegevens, voertuig-onderzoek alsmede informatie van Bosch en geven de stand op het tijdstip van publicatie weer.

Landspecifieke afwijkingen zijn echter onvermijdelijk en niet geheel uit te sluiten. Derhalve kan Bosch niet verantwoordelijk worden gehouden voor de volledigheid en het foutloos zijn van deze gegevens. Indien aperte onjuistheden of drukfouten leiden tot directe vermogensschade of directe schade aan eigendommen is Bosch slechts aansprakelijk in geval van grove nalatigheid of opzettelijk handelen. Indien aperte onjuistheden of drukfouten leiden tot letselschade is Bosch aansprakelijk in geval van toerekenbare tekortkoming, die zowel verwijtbaar is als voor haar risico komt.

sv

**Användningsdel****Användarvägledning**

I denna katalog finns data angivna för fordon, motorer och apparater för den europeiska marknaden från årsmodell 1994 till och med 2015. Uppgifterna kommer från tillverkarna och importörerna, från fordonsundersökningar och från underlag från Bosch och är omsorgsfullt sammanställda enligt tillgänglig kunskap och anger läget vid tryckningstidpunkten.

I vissa länder kan specifika avvikelser förekomma p. g. a. tekniska ändringar varför Bosch ej kan hållas ansvarig för ej komplett information. Vid fel som leder till direkt skada på egendom eller fordon, kan Bosch hållas ansvarig endast om grov oaktsamhet kan påvisas. Vid personskadorna kan Bosch hållas ansvarig om vårdslöshet kan påvisas.

pt

**Parte de utilização****Instruções para o utilizador**

Este catálogo abrange os dados de veículos, motores e aparelhos para o mercado europeu, fabricados entre 1994 e 2015, inclusive. Estes mesmos dados foram recolhidos conscienciosamente a partir de indicações de fabricantes e importadores, inspeções a veículos e documentos da Bosch e reflectem o estado da técnica por altura da ida para a tipografia.

Não é, de todo, possível excluir a existência de discrepâncias decorrentes de alterações técnicas específicas dos diversos países. Nesta medida, a Bosch não pode garantir que os dados sejam completos e isentos de erros. A Bosch não se responsabiliza por erros, omissões e erros de impressão, que conduzam a perdas e danos, excepto nos casos de danos resultantes directamente de negligência grave ou dolo. Em caso de danos pessoais, a Bosch responsabiliza-se também por danos resultantes de negligência simples.

cs

**Použití****Pokyny pro uživatele**

V tomto katalogu jsou obsaženy údaje vozidel, motorů a přístrojů pro evropský trh od roku výroby 1994 do roku 2015 včetně. Tyto údaje byly pečlivě sestaveny podle nejlepšího vědomí z údajů výrobců a dovozců automobilů a zachycují stav k datu předání do tisku.

Odchytky, způsobené technickými změnami specifickými pro některé země, není možné vyloučit. Proto nemůže firma Bosch ručit za úplnost a bezchybnost těchto údajů. Za omyly a chyby tisku, které by způsobily škodu na vlastnictví nebo majetku, ručí firma Bosch jen v případě hrubého a nedbalého porušení povinností a úmyslu bezprostřední škody. Pokud by měly za následek škody na zdraví osob, nese firma Bosch odpovědnost i v případě mírné nedbalosti.

ru

**Применение****Вниманию пользователей**

В настоящем каталоге приводятся данные по автомобилям, двигателям и прочему оборудованию на европейском рынке с 1994 по 2015 год выпуска включительно. Они были тщательно подобраны из информации, предоставленной производителями и импортерами, по результатам тестирования автомобилей, а также из документации компании Bosch и отражают состояние на момент подписания в печать. Неизбежные расхождения из-за специфических для каждой страны технических модификаций не могут быть полностью исключены. Поэтому компания Bosch не несет ответственность за полноту и точность предоставленных данных. В случае, если ошибки или опечатки привели к ущербу для собственности или повлекли материальные затраты, компания Bosch принимает на себя ответственность только если это является преднамеренным вредом или грубой небрежностью со стороны фирмы Bosch. Если пострадало физическое лицо, фирма Bosch несет ответственность даже при допущении незначительной небрежности.

de

Hinweise zur Benutzung

en

Instructions for use

fr

Conseils d'utilisation

it

Avvertenze per l'utilizzo

es

Indicaciones de uso

de

B2 | ALFA ROMEO



① ALFA ROMEO											
Brera [939]											
②		2.2 JTS	01.06→	136		1987 481 397	530				⑥
		2.4 JTDM 20V	04.06→	147/154		1987 481 399	638				
		3.2 JTS 24V, JTS 24V Q4	01.06→	191/195		1987 481 399	638				
		1.8 Tbi	05.09→	147		1987 481 398	425				⑦
		2.0 JTDM	05.09→	125		1987 481 398	425				
		2.2 JTS	01.06→	136		1987 481 398	425				
		2.4 JTDM 20V	04.06→	147/154		1987 481 398	425				
		3.2 JTS 24V, JTS 24V Q4	01.06→	191/195		1987 481 398	425				
		1.8 Tbi	05.09→	147		1987 482 285	1662				⑧
		2.0 JTDM	05.09→	125		1987 482 290	1520				
		2.2 JTS	01.06→	136		1987 482 285	1662				
		2.4 JTDM 20V	04.06→	147/154		1987 482 285	1520				
		3.2 JTS 24V	01.06→	191/195		1987 482 285	1662				
		3.2 JTS 24V Q4				1987 482 290	1520				
						0 265 008 055 <sup>3</sup>					
						0 265 008 056 <sup>4</sup>					
						0 265 008 055 <sup>3</sup>					
						0 265 008 056 <sup>4</sup>					
						0 265 008 055 <sup>3</sup>					
						0 265 008 056 <sup>4</sup>					
						0 265 008 055 <sup>3</sup>					
						0 265 008 056 <sup>4</sup>					
						0 265 008 055 <sup>3</sup>					
						0 265 008 056 <sup>4</sup>					
						0 265 008 055 <sup>3</sup>					
						0 265 008 056 <sup>4</sup>					
						0 265 008 055 <sup>3</sup>					
						0 265 008 056 <sup>4</sup>					
						0 265 008 055 <sup>3</sup>					
						0 265 008 056 <sup>4</sup>					
						0 265 008 055 <sup>3</sup>					
						0 265 008 056 <sup>4</sup>					
						0 265 008 055 <sup>3</sup>					
						0 265 008 056 <sup>4</sup>					
						0 265 008 055 <sup>3</sup>					
						0 265 008 056 <sup>4</sup>					
						0 265 008 055 <sup>3</sup>					
						0 265 008 056 <sup>4</sup>					
						0 265 008 055 <sup>3</sup>					
						0 265 008 056 <sup>4</sup>					
						0 265 008 055 <sup>3</sup>					
						0 265 008 056 <sup>4</sup>					
						0 265 008 055 <sup>3</sup>					
						0 265 008 056 <sup>4</sup>					
						0 265 008 055 <sup>3</sup>					
						0 265 008 056 <sup>4</sup>					
						0 265 008 055 <sup>3</sup>					
						0 265 008 056 <sup>4</sup>					
						0 265 008 055 <sup>3</sup>					
						0 265 008 056 <sup>4</sup>					
						0 265 008 055 <sup>3</sup>					
						0 265 008 056 <sup>4</sup>					
						0 265 008 055 <sup>3</sup>					
						0 265 008 056 <sup>4</sup>					
						0 265 008 055 <sup>3</sup>					
						0 265 008 056 <sup>4</sup>					
						0 265 008 055 <sup>3</sup>					
						0 265 008 056 <sup>4</sup>					
						0 265 008 055 <sup>3</sup>					
						0 265 008 056 <sup>4</sup>					
						0 265 008 055 <sup>3</sup>					
						0 265 008 056 <sup>4</sup>					
						0 265 008 055 <sup>3</sup>					
						0 265 008 056 <sup>4</sup>					
						0 265 008 055 <sup>3</sup>					
						0 265 008 056 <sup>4</sup>					
						0 265 008 055 <sup>3</sup>					
						0 265 008 056 <sup>4</sup>					
						0 265 008 055 <sup>3</sup>					
						0 265 008 056 <sup>4</sup>					
						0 265 008 055 <sup>3</sup>					
						0 265 008 056 <sup>4</sup>					
						0 265 008 055 <sup>3</sup>					
						0 265 008 056 <sup>4</sup>					
						0 265 008 055 <sup>3</sup>					
						0 265 008 056 <sup>4</sup>					
						0 265 008 055 <sup>3</sup>					
						0 265 008 056 <sup>4</sup>					
						0 265 008 055 <sup>3</sup>					
						0 265 008 056 <sup>4</sup>					
						0 265 008 055 <sup>3</sup>					
						0 265 008 056 <sup>4</sup>					
						0 265 008 055 <sup>3</sup>					
						0 265 008 056 <sup>4</sup>					
						0 265 008 055 <sup>3</sup>					
						0 265 008 056 <sup>4</sup>					
						0 265 008 055 <sup>3</sup>					
						0 265 008 056 <sup>4</sup>					
						0 265 008 055 <sup>3</sup>					
						0 265 008 056 <sup>4</sup>					
						0 265 008 055 <sup>3</sup>					
						0 265 008 056 <sup>4</sup>					
						0 265 008 055 <sup>3</sup>					
						0 265 008 056 <sup>4</sup>					
						0 265 008 055 <sup>3</sup>					
						0 265 008 056 <sup>4</sup>					
						0 265 008 055 <sup>3</sup>					
						0 265 008 056 <sup>4</sup>					
						0 265 008 055 <sup>3</sup>					
						0 265 008 056 <sup>4</sup>					
						0 265 008 055 <sup>3</sup>					
						0 265 008 056 <sup>4</sup>					
						0 265 008 055 <sup>3</sup>					
						0 265 008 056 <sup>4</sup>					
						0 265 008 055 <sup>3</sup>					
						0 265 008 056 <sup>4</sup>					
						0 265 008 055 <sup>3</sup>					
						0 265 008 056 <sup>4</sup>					
						0 265 008 055 <sup>3</sup>					
						0 265 008 056 <sup>4</sup>					
						0 265 008 055 <sup>3</sup>					
						0 265 008 056 <sup>4</sup>					
						0 265 008 055 <sup>3</sup>					
						0 265 008 056 <sup>4</sup>					
						0 265 008 055 <sup>3</sup>					
						0 265 008 056 <sup>4</sup>					
						0 265 008 055 <sup>3</sup>					
						0 265 008 056 <sup>4</sup>					
						0 265 008 055 <sup>3</sup>					
						0 265 008 056 <sup>4</sup>					
						0 265 008 055 <sup>3</sup>					
						0 265 008 056 <sup>4</sup>					
						0 265 008 055 <sup>3</sup>					
						0 265 008 056 <sup>4</sup>					
						0 265 008 055 <sup>3</sup>					
						0 265 008 056 <sup>4</sup>					
						0 265 008 055 <sup>3</sup>					
						0 265 008 056 <sup>4</sup>					
						0 265 008 055 <sup>3</sup>					
						0 265 008 056 <sup>4</sup>					
						0 265 008 055 <sup>3</sup>					
						0 265 008 056 <sup>4</sup>					

en

fr

it

es

① Vehicle brand	① Marque de véhicule	① Marca del veicolo	① Marca de vehículo
② Details of product using Pictogram symbols	② Présentation produit par pictogramme	② Descrizione prodotto con simboli	② Indicación de producto con pictogramas
③ Details of model	③ Spécification modèle	③ Applicazioni	③ Modelo
④ Engine power	④ Puissance moteur	④ Potenza	④ Potencia del motor
⑤ Mounting period	⑤ Période de montage	⑤ Data di produzione	⑤ Fecha de montaje
⑥ 10-digit part number	⑥ Référence à 10 chiffres	⑥ Codice di ordinazione a 10 cifre	⑥ Referencia de pedido de 10 cifras
⑦ Dimensions	⑦ Dimensions	⑦ Dimensioni	⑦ Dimensiones
⑧ Left-hand/Right-hand version	⑧ Version à droite/gauche	⑧ Riferimento sinistra/destra	⑧ Montaje derecha/izquierda
⑨ Factory exchange	⑨ Exchange standard	⑨ Revisionato garantito	⑨ Intercambio
⑩ Repair kit	⑩ Kit de remise en état	⑩ Set riparazione	⑩ Juego de reparación
⑪ Special cases and braking systems	⑪ Cas particuliers/ Systèmes de freinage	⑪ Casi particolari e sistemi frenanti	⑪ Sistema de frenos y casos especiales
⑫ Chassis number or engine type	⑫ Numéro de châssis (type de moteur)	⑫ N° di telaio o tipo di motore	⑫ Número de chasis o número de motor



B1.4

nl

Gebruiksaanwijzing

sv

Användnings-  
våglledning

pt

Notas sobre  
a utilização

cs

Pokyny pro  
použití

ru

Указания по  
применению

nl

B2 | ALFA ROMEO



1 ALFA ROMEO											
Brera [939]											
2											
2.2 JTS	01.06→	136		1987 481 397	530	6					
2.4 JTDM 20V	04.06→	147/154		1987 481 399	638						
3.2 JTS 24V, JTS 24V Q4	01.06→	191/195		1987 481 399	638						
7											
1.8 Tbi	05.09→	147		1987 481 398	425	7					
2.0 JTDM	05.09→	125		1987 481 398	425						
2.2 JTS	01.06→	136		1987 481 398	425						
2.4 JTDM 20V	04.06→	147/154		1987 481 398	425						
3.2 JTS 24V, JTS 24V Q4	01.06→	191/195		1987 481 398	425						
8											
1.8 Tbi	05.09→	147		1987 482 285	1662	8					
				1987 482 290	1520						
2.0 JTDM	05.09→	125		1987 482 285	1662						
				1987 482 290	1520						
2.2 JTS	01.06→	136		1987 482 285	1662						
				1987 482 290	1520						
2.4 JTDM 20V	04.06→	147/154		1987 482 285	1662						
				1987 482 290	1520						
3.2 JTS 24V	01.06→	191/195		1987 482 285	1662						
3.2 JTS 24V Q4				1987 482 290	1520						
9											
1.8 Tbi	05.09→	147		0 265 008 055 <sup>3</sup>		9					
				0 265 008 056 <sup>4</sup>							
2.0 JTDM	05.09→	125		0 265 008 055 <sup>3</sup>							
				0 265 008 056 <sup>4</sup>							
2.2 JTS	01.06→	136		0 265 008 055 <sup>3</sup>							
				0 265 008 056 <sup>4</sup>							
2.4 JTDM 20V	04.06→	147/154		0 265 008 055 <sup>3</sup>							
				0 265 008 056 <sup>4</sup>							
3.2 JTS 24V	01.06→	191/195		0 265 008 055 <sup>3</sup>							
3.2 JTS 24V Q4				0 265 008 056 <sup>4</sup>							
10											
3 GT [937]											
4											
1.8 TS	10.03→	106		1987 476 346	422	9					
1.9 JTD 16V	10.03→	110/125		1987 476 346	422						
2.0 JTS	10.03→	120/121		1987 476 346	422						
5											
1.8 TS	10.03.07.07	106		0 204 102 854	54	0 204 104 208	10				
				0 204 103 854	54						
				0 204 102 855	54						
				0 204 103 855	54						
	08.07→	106		0 204 902 105							
				0 204 902 106							
1.9 JTD 16V	10.03.07.07	110		0 204 102 854	54		11				
				0 204 103 854	54						
				0 204 102 855	54						
				0 204 103 855	54						
	08.07→	110		0 204 902 105							
				0 204 902 106							
	10.07→	125	Fg.Nr.5008407→	0 204 902 105							
				0 204 902 106			12				

Bosch Automotive Aftermarket

2016 | 2017

1 Voertuigfabrikant

2 Productweergave  
d.m.v. pictogrammen

3 Modelgegevens

4 Motorvermogen

5 Inbouwperiode  
van het product

6 10-cijferig bestelnummer

7 Afmetingen

8 Uitvoering voor links/rechts

9 Vervanging bij de fabrikant

10 Reparatieset

11 Speciale gevallen  
en remsystemen

12 Chassisnummer  
resp. motortype

sv

pt

cs

ru

① Biltillverkare	① Fabricante do veículo	① Výrobce vozidla	① Марка автомобиля
② Produktuppgifter med piktogram	② Indicação do produto com pictogramas	② Údaj o produktu formou piktogramu	② Изделия, обозначенные пиктограммой
③ Modelldata	③ Indicações do modelo	③ Údaje o modelu	③ Характеристики модели
④ Motoreffekt	④ Potência do motor	④ Výkon motoru	④ Мощность двигателя
⑤ Produktens användningsperiod	⑤ Período de montagem do produto	⑤ Časový interval montáže produktu	⑤ Время установки изделия
⑥ 10-siffrigt artikelnummer	⑥ Referência de 10 números	⑥ 10místné objednáací číslo	⑥ 10-значный номер для заказа
⑦ Mått	⑦ Indicações da medida	⑦ Rozměrový údaj	⑦ Размер
⑧ Vänster-/högerutförande	⑧ Montagem direita/esquerda	⑧ Provedení vlevo/vpravo	⑧ Левостороннее/правостороннее исполнение
⑨ Fabriksutbytesprodukt	⑨ Reconstruído	⑨ Servisní výměna	⑨ Заводская замена
⑩ Reparationssats	⑩ Jogo de reparação	⑩ Sada pro opravu	⑩ Ремонтный комплект
⑪ Specialfall och bromssystem	⑪ Casos especiais e sistemas de travões	⑪ Speciální případy a brzdové systémy	⑪ Особые случаи и тормозные системы
⑫ Chassinummer resp. motortyp	⑫ Número de chassis ou tipo de motor	⑫ Číslo podvozku příp. typ motoru	⑫ Номер шасси или тип двигателя



**ALFA ROMEO**

**Brera [939]**



































	1.8 TBI	05.09-12.10	147			1987 <b>482 285</b>	← 1662
						1987 <b>482 286</b>	→ 1577
	2.0 JTDM	02.09-12.10	120/125			1987 <b>482 285</b>	← 1662
						1987 <b>482 286</b>	→ 1577
	2.2 JTS	01.06-12.10	136			1987 <b>482 285</b>	← 1662
						1987 <b>482 286</b>	→ 1577
	2.4 JTDM 20V	04.06-12.10	147/154			1987 <b>482 285</b>	← 1662
						1987 <b>482 286</b>	→ 1577
	3.2 JTS 24V	01.06-12.10	191/195			1987 <b>482 285</b>	← 1662
						1987 <b>482 286</b>	→ 1577
	3.2 JTS 24V Q4					1987 <b>482 286</b>	→ 1577

	1.8 TBI	05.09-12.10	147			0265 <b>008 055</b> <sup>3</sup>	
						0265 <b>008 056</b> <sup>4</sup>	
	2.0 JTDM	02.09-12.10	120/125			0265 <b>008 055</b> <sup>3</sup>	
						0265 <b>008 056</b> <sup>4</sup>	
	2.2 JTS	01.06-12.10	136			0265 <b>008 055</b> <sup>3</sup>	
						0265 <b>008 056</b> <sup>4</sup>	
	2.4 JTDM 20V	04.06-12.10	147/154			0265 <b>008 055</b> <sup>3</sup>	
						0265 <b>008 056</b> <sup>4</sup>	
	3.2 JTS 24V	01.06-12.10	191/195			0265 <b>008 055</b> <sup>3</sup>	
						0265 <b>008 056</b> <sup>4</sup>	
	3.2 JTS 24V Q4					0265 <b>008 056</b> <sup>4</sup>	

**GT [937]**

	1.8 TS	10.03-07.07	103-106		⌘	0204 <b>102 854</b>	← 54
						0204 <b>103 854</b>	→ 54
		08.07-12.10	103-106		⌘	0204 <b>102 855</b>	→ 54
						0204 <b>103 855</b>	←
	1.9 JTD 16V	10.03-07.07	110		⌘	0204 <b>902 106</b>	→
						0204 <b>102 854</b>	← 54
		08.07-12.10	110		⌘	0204 <b>103 854</b>	→ 54
						0204 <b>102 855</b>	←
		10.07-12.10	125		⌘	0204 <b>902 105</b>	→
						0204 <b>902 106</b>	←
	2.0 JTS	10.03-07.07	119/121		⌘	0204 <b>102 854</b>	← 54
						0204 <b>103 854</b>	→ 54
		08.07-12.10	119/121		⌘	0204 <b>102 855</b>	→ 54
						0204 <b>103 855</b>	←
						0204 <b>902 105</b>	→
						0204 <b>902 106</b>	←



































	1.8 TS	10.03-12.10	103-106			0986 <b>473 251</b>	← 38
						0986 <b>474 251</b>	→ 38
	1.9 JTD 16V	10.03-12.10	110/125			0986 <b>473 251</b>	← 38
						0986 <b>474 251</b>	→ 38
	2.0 JTS	10.03-12.10	119/121			0986 <b>473 251</b>	← 38
						0986 <b>474 251</b>	→ 38

		S							
									
	1.8 TS	10.03-12.10	103-106				1 987 477 621	→ 1196	
							1 987 477 622	← 1256	
	1.9 JTD 16V	10.03-12.10	110/125				1 987 477 621	→ 1196	
							1 987 477 622	← 1256	
	2.0 JTS	10.03-12.10	119/121				1 987 477 621	→ 1196	
							1 987 477 622	← 1256	
	3.2 V6	10.03-12.10	176				1 987 477 621	→ 1196	
	1.8 TS	10.03-12.10	103-106				0 265 007 488 <sup>4</sup>		
						LAB	0 265 007 486 <sup>3</sup>		
						RAB	0 265 007 487 <sup>3</sup>		
	1.9 JTD 16V	10.03-12.10	110/125				0 265 007 488 <sup>4</sup>		
						LAB	0 265 007 486 <sup>3</sup>		
						RAB	0 265 007 487 <sup>3</sup>		
	2.0 JTS	10.03-12.10	119/121				0 265 007 488 <sup>4</sup>		
						LAB	0 265 007 486 <sup>3</sup>		
						RAB	0 265 007 487 <sup>3</sup>		
	3.2 V6	10.03-12.10	176				0 265 007 488 <sup>4</sup>		
						LAB	0 265 007 486 <sup>3</sup>		
						RAB	0 265 007 487 <sup>3</sup>		
<b>GTV [916]</b>									
									
	1.8 T.S. 16V	05.98-12.00	106				0 204 102 575	← 54	
							0 986 134 005		
							0 204 102 576	→ 54	
							0 986 135 005		
	2.0 JTS	04.03-12.05	121				0 204 102 575	← 54	
							0 986 134 005		
							0 204 102 576	→ 54	
							0 986 135 005		
	2.0 T.S. 16V	04.95-04.98	110	Ricam.Nr 6009487→			0 204 102 506	← 54	0 204 104 208 <sup>B</sup>
							0 204 103 506		
							0 986 134 005		
							0 204 102 507	→ 54	0 204 104 208 <sup>B</sup>
							0 204 103 507		
		05.98-07.00	114				0 204 102 575	← 54	
							0 986 134 005		
							0 204 102 576	→ 54	
							0 986 135 005		
		08.00-12.05	110				0 204 102 575	← 54	
						0 986 134 005			
						0 204 102 576	→ 54		
						0 986 135 005			
2.0 V6 Turbo	04.95-04.98	148	Ricam.Nr 6009487→			0 204 102 506	← 54	0 204 104 208 <sup>B</sup>	
						0 204 103 506			
						0 986 134 005			
						0 204 102 507	→ 54	0 204 104 208 <sup>B</sup>	
						0 204 103 507			
	05.98-07.00	148				0 204 102 575	← 54		
						0 986 134 005			
						0 204 102 576	→ 54		
						0 986 135 005			
									
	2.0 T.S. 16V	04.95-07.95	110/148				0 986 473 077	 ← 33,9	1 987 470 028 <sup>7</sup>
	2.0 V6 Turbo						0 986 474 077	 → 33,9	1 987 470 028 <sup>7</sup>
		08.95-02.98	110/148				0 986 473 121	 ← 33,9	1 987 470 028 <sup>7</sup>
							0 986 474 121	 → 33,9	1 987 470 028 <sup>7</sup>



		S									
	◀ ALFA ROMEO GTV [916]										
	3.0 V6 24V	11.96-02.98	162				0986 473 121		← 33,9		
							0986 474 121		→ 33,9		
		05.98-07.00	162				0986 473 121		← 33,9		
		08.00-06.03	160				0986 473 121		← 33,9		
	1.8 T.S. 16V	05.98-12.00	106				1987 477 725		1581		
		2.0 JTS, T.S. 16V, V6 Turbo	04.95-12.05	110/114/121/148				1987 477 725		1581	
		3.0 V6 24V	11.96-12.05	160/162				1987 477 725		1581	
		3.2 V6 24V	04.03-12.05	176				1987 477 725		1581	
	1.8 T.S. 16V	05.98-11.99	106				LAB	0265 006 260 <sup>4</sup>			
							RAB	0265 006 261 <sup>4</sup>			
		05.98-12.00	106					Ricam.Nr →6063041	0265 006 212 <sup>3</sup>		
								Ricam.Nr 6063042→	LAB	0265 007 073 <sup>3</sup>	
								RAB	0265 007 074 <sup>3</sup>		
								LAB	0265 007 098 <sup>4</sup>		
		12.99-12.00	106					RAB	0265 007 099 <sup>4</sup>		
								LAB	0265 007 073 <sup>3</sup>		
		2.0 JTS	04.03-12.05	121				LAB	0265 007 073 <sup>3</sup>		
								RAB	0265 007 098 <sup>4</sup>		
		2.0 T.S. 16V	04.95-04.98	110				RAB	0265 007 074 <sup>3</sup>		
								LAB	0265 007 099 <sup>4</sup>		
								LAB	0265 006 212 <sup>3</sup>		
								RAB	0265 006 260 <sup>4</sup>		
		05.98-11.99	114					RAB	0265 006 261 <sup>4</sup>		
								LAB	0265 006 260 <sup>4</sup>		
RAB	0265 006 261 <sup>4</sup>										
LAB	0265 006 260 <sup>4</sup>										
05.98-07.00	114					Ricam.Nr →6063041	0265 006 212 <sup>3</sup>				
						Ricam.Nr 6063042→	LAB	0265 007 073 <sup>3</sup>			
						RAB	0265 007 074 <sup>3</sup>				
						LAB	0265 007 073 <sup>3</sup>				
08.00-12.05	110					LAB	0265 007 073 <sup>3</sup>				
						RAB	0265 007 098 <sup>4</sup>				
						RAB	0265 007 074 <sup>3</sup>				
						LAB	0265 007 099 <sup>4</sup>				
2.0 V6 Turbo	04.95-11.99	148				LAB	0265 006 162 <sup>3</sup>				
						RAB	0265 006 260 <sup>4</sup>				
						RAB	0265 006 261 <sup>4</sup>				
						LAB	0265 007 073 <sup>3</sup>				
12.99-07.00	148					LAB	0265 007 098 <sup>4</sup>				
						RAB	0265 007 074 <sup>3</sup>				
						RAB	0265 007 099 <sup>4</sup>				
						LAB	0265 007 073 <sup>3</sup>				
3.0 V6 24V	11.96-11.99	162				LAB	0265 006 162 <sup>3</sup>				
						RAB	0265 006 260 <sup>4</sup>				
						RAB	0265 006 261 <sup>4</sup>				
						LAB	0265 007 073 <sup>3</sup>				
	12.99-07.00	162					LAB	0265 007 098 <sup>4</sup>			
							RAB	0265 007 074 <sup>3</sup>			
							RAB	0265 007 099 <sup>4</sup>			
							LAB	0265 007 073 <sup>3</sup>			
08.00-12.05	160					LAB	0265 007 073 <sup>3</sup>				
						RAB	0265 007 098 <sup>4</sup>				
						RAB	0265 007 074 <sup>3</sup>				
						LAB	0265 007 099 <sup>4</sup>				
3.2 V6 24V	04.03-12.05	176				LAB	0265 007 073 <sup>3</sup>				
						RAB	0265 007 098 <sup>4</sup>				
						RAB	0265 007 074 <sup>3</sup>				
						LAB	0265 007 099 <sup>4</sup>				













		S							
<b>MiTo [955]</b>									
									
	0.9 i.e.	07.11→	63/74/77		NFX	0 204 717 876	→ 54		
						0 986 474 487			
						0 204 902 119	← 54		
						0 986 473 487			
	1.4	10.09→	77		BSR	0 204 717 876	→ 54		
						0 986 474 487			
						0 204 902 119	← 54		
						0 986 473 487			
		05.11→	51			0 204 717 876	→ 54		
						0 986 474 487			
						0 204 902 119	← 54		
						0 986 473 487			
	1.4 i.e.	08.08→	57-58		NFX	0 204 717 876	→ 54		
	1.4 i.e. 16V					0 986 474 487			
						0 204 902 119	← 54		
						0 986 473 487			
									
	1.3 JTD	10.08-09.09	66/70			1 987 477 977	→ 1673		
						1 987 477 978	← 1654		
	1.4 i.e., i.e. Turbo, i.e. 16V	05.08-09.09	57-58/88/ 110/114			1 987 477 977	→ 1673		
						1 987 477 978	← 1654		
	1.6 JTD	08.08-09.09	85/88			1 987 477 977	→ 1673		
						1 987 477 978	← 1654		
		0.9 i.e.	07.11→	63/74/77		0 265 004 136 <sup>3</sup>			
						0 265 007 769 <sup>4</sup>			
	1.3 JTD	10.08→	59/62/66/			0 265 004 136 <sup>3</sup>			
	1.3 JTDM		70			0 265 007 769 <sup>4</sup>			
	1.4, BiFuel, i.e., i.e. Turbo, i.e. 16V, Turbo, 16V Turbo	05.08→	51/57-58/77/88/ 99-114/120/125			0 265 004 136 <sup>3</sup>			
						0 265 007 769 <sup>4</sup>			
	1.6 JTD	08.08→	85/88			0 265 004 136 <sup>3</sup>			
						0 265 007 769 <sup>4</sup>			
<b>Spider [916]</b>									
									
	1.8 T.S. 16V	05.98-07.00	106			0 204 102 575	← 54		
						0 986 134 005			
						0 204 102 576	→ 54		
						0 986 135 005			
	2.0 JTS	04.03-02.06	121			0 204 102 575	← 54		
						0 986 134 005			
						0 204 102 576	→ 54		
						0 986 135 005			
	2.0 T.S. 16V	04.95-04.98	110	Ricam.Nr 6009487→		0 204 102 506	← 54		
						0 204 103 506			
						0 986 134 005			
						0 204 102 507	→ 54		
						0 204 103 507			
		06.95-04.98	110	Ricam.Nr →6009486		0 204 102 532	← 54	0 204 104 234 <sup>7</sup>	
						0 204 103 532			
						0 204 102 533	→ 54	0 204 104 234 <sup>7</sup>	
						0 204 103 533			
		05.98-07.00	114			0 204 102 575	← 54		
						0 986 134 005			
						0 204 102 576	→ 54		
						0 986 135 005			



		S							
	◀ ALFA ROMEO Spider [916]								
	2.0 T.S. 16V	08.00-02.06	110				0 204 102 575	← 54	
							0 986 134 005		
							0 204 102 576	→ 54	
							0 986 135 005		
	2.0 V6 Turbo	04.98-12.00	147				0 204 102 575	← 54	
							0 986 134 005		
							0 204 102 576	→ 54	
							0 986 135 005		
	3.0 V6 12V	04.95-04.98	141	Ricam.Nr →6009487→			0 204 102 506	← 54	
							0 204 103 506		
							0 986 134 005		
							0 204 102 507	→ 54	
							0 204 103 507		
		05.98-08.00	141				0 204 102 575	← 54	
							0 986 134 005		
							0 204 102 576	→ 54	
							0 986 135 005		
	2.0 T.S. 16V	04.95-04.98	110	Ricam.Nr →6009486			0 986 473 121	← 33,9	1 987 470 028 <sup>7</sup>
							0 986 474 121	→ 33,9	1 987 470 028 <sup>7</sup>
	3.0 V6 12V	04.95-04.98	141	Ricam.Nr →6009486			0 986 473 121	← 33,9	1 987 470 028 <sup>7</sup>
							0 986 474 121	→ 33,9	1 987 470 028 <sup>7</sup>
	1.8 T.S. 16V	05.98-07.00	106				1 987 477 725		1581
	2.0 JTS, T.S. 16V, V6 Turbo	04.95-02.06	110/114/121/147				1 987 477 725		1581
	3.0 V6 12V, V6 24V	04.95-03.03	141/160				1 987 477 725		1581
	3.2 V6 24V	04.03-02.06	176				1 987 477 725		1581
	1.8 T.S. 16V	05.98-07.00	106	Ricam.Nr →6063041	LAB		0 265 006 212 <sup>3</sup>		
					RAB		0 265 006 260 <sup>4</sup>		
					RAB		0 265 006 162 <sup>3</sup>		
					RAB		0 265 006 261 <sup>4</sup>		
				Ricam.Nr 6063042→	LAB		0 265 007 073 <sup>3</sup>		
					RAB		0 265 007 098 <sup>4</sup>		
					RAB		0 265 007 074 <sup>3</sup>		
					RAB		0 265 007 099 <sup>4</sup>		
	2.0 JTS	04.03-02.06	121	Ricam.Nr →6063041	LAB		0 265 006 212 <sup>3</sup>		
					RAB		0 265 006 260 <sup>4</sup>		
					RAB		0 265 006 162 <sup>3</sup>		
					RAB		0 265 006 261 <sup>4</sup>		
				Ricam.Nr 6063042→	LAB		0 265 007 073 <sup>3</sup>		
					RAB		0 265 007 098 <sup>4</sup>		
					RAB		0 265 007 074 <sup>3</sup>		
					RAB		0 265 007 099 <sup>4</sup>		
	2.0 T.S. 16V	04.95-04.98	110				0 265 006 212 <sup>3</sup>		
					LAB		0 265 006 260 <sup>4</sup>		
					RAB		0 265 006 261 <sup>4</sup>		
		05.98-07.00	114	Ricam.Nr →6063041	LAB		0 265 006 212 <sup>3</sup>		
					RAB		0 265 006 260 <sup>4</sup>		
					RAB		0 265 006 162 <sup>3</sup>		
					RAB		0 265 006 261 <sup>4</sup>		
				Ricam.Nr 6063042→	LAB		0 265 007 073 <sup>3</sup>		
					RAB		0 265 007 098 <sup>4</sup>		
					RAB		0 265 007 074 <sup>3</sup>		
					RAB		0 265 007 099 <sup>4</sup>		
		08.00-02.06	110	Ricam.Nr →6063041	LAB		0 265 006 212 <sup>3</sup>		
					RAB		0 265 006 260 <sup>4</sup>		
					RAB		0 265 006 162 <sup>3</sup>		
					RAB		0 265 006 261 <sup>4</sup>		































		S										
<b>2.0 T.S. 16V</b>		08.00-02.06	110	Ricam.Nr 6063042→	LAB		0 265 007 073 <sup>3</sup>					
							0 265 007 098 <sup>4</sup>					
							RAB	0 265 007 074 <sup>3</sup>				
								0 265 007 099 <sup>4</sup>				
<b>2.0 V6 Turbo</b>		04.98-12.00	147	Ricam.Nr →6063041	LAB		0 265 006 212 <sup>3</sup>					
							0 265 006 260 <sup>4</sup>					
							RAB	0 265 006 162 <sup>3</sup>				
								0 265 006 261 <sup>4</sup>				
			05.98-08.00	141	Ricam.Nr 6063042→	LAB			0 265 007 073 <sup>3</sup>			
									0 265 007 098 <sup>4</sup>			
									RAB	0 265 007 074 <sup>3</sup>		
										0 265 007 099 <sup>4</sup>		
<b>3.0 V6 12V</b>		04.95-04.98	141		LAB		0 265 006 162 <sup>3</sup>					
							0 265 006 260 <sup>4</sup>					
							RAB	0 265 006 261 <sup>4</sup>				
								0 265 006 162 <sup>3</sup>				
			05.98-08.00	141	Ricam.Nr →6063041	LAB			0 265 006 212 <sup>3</sup>			
									0 265 006 260 <sup>4</sup>			
									RAB	0 265 006 162 <sup>3</sup>		
										0 265 006 261 <sup>4</sup>		
				Ricam.Nr 6063042→	LAB		0 265 007 073 <sup>3</sup>					
							0 265 007 098 <sup>4</sup>					
							RAB	0 265 007 074 <sup>3</sup>				
								0 265 007 099 <sup>4</sup>				
		<b>3.0 V6 24V</b>		08.00-03.03	160	Ricam.Nr →6063041	LAB		0 265 006 212 <sup>3</sup>			
									0 265 006 260 <sup>4</sup>			
									RAB	0 265 006 162 <sup>3</sup>		
										0 265 006 261 <sup>4</sup>		
				Ricam.Nr 6063042→	LAB		0 265 007 073 <sup>3</sup>					
							0 265 007 098 <sup>4</sup>					
							RAB	0 265 007 074 <sup>3</sup>				
								0 265 007 099 <sup>4</sup>				
		<b>3.2 V6 24V</b>		04.03-02.06	176	Ricam.Nr →6063041	LAB		0 265 006 212 <sup>3</sup>			
									0 265 006 260 <sup>4</sup>			
									RAB	0 265 006 162 <sup>3</sup>		
										0 265 006 261 <sup>4</sup>		
				Ricam.Nr 6063042→	LAB		0 265 007 073 <sup>3</sup>					
							0 265 007 098 <sup>4</sup>					
							RAB	0 265 007 074 <sup>3</sup>				
								0 265 007 099 <sup>4</sup>				
		<b>Spider [939]</b>										
												
				05.09-12.10	147				1 987 482 285	← 1662		
									1 987 482 286	→ 1577		
04.09-12.10	120/125							1 987 482 285	← 1662			
								1 987 482 286	→ 1577			
03.06-12.10	136							1 987 482 285	← 1662			
								1 987 482 286	→ 1577			
03.07-12.10	147/154							1 987 482 285	← 1662			
								1 987 482 286	→ 1577			
09.06-12.10	191							1 987 482 285	← 1662			
								1 987 482 286	→ 1577			
<b>Spider [939]</b>												
				05.09-12.10	147				0 265 008 055 <sup>3</sup>			
		0 265 008 056 <sup>4</sup>										
		04.09-12.10	120/125					0 265 008 055 <sup>3</sup>				
								0 265 008 056 <sup>4</sup>				
		03.06-12.10	136					0 265 008 055 <sup>3</sup>				
								0 265 008 056 <sup>4</sup>				
		03.07-12.10	147/154					0 265 008 055 <sup>3</sup>				
								0 265 008 056 <sup>4</sup>				





		S							
	◀ ALFA ROMEO Spider [939]								
	3.2 JTS 24V	09.06-12.10	191				0 265 008 055 <sup>3</sup>		
	3.2 JTS 24V Q4						0 265 008 056 <sup>4</sup>		
<b>33 Berlina [907A]</b>									
	1.4 I.E.	ABO 09.91-09.94	64				0 204 102 556	← 48	
							0 204 103 556		
							0 204 102 557	→ 48	
							0 204 103 557		
	1.5 I.E.	ABO 06.90-10.94	71/74				0 204 102 556	← 48	
	1.5 I.E. 4x4						0 204 103 556		
							0 204 102 557	→ 48	
							0 204 103 557		
	1.7 I.E.	ABO 04.92-10.94	77				0 204 102 556	← 48	
	1.7 I.E. 4x4						0 204 103 556		
							0 204 102 557	→ 48	
							0 204 103 557		
	1.3	02.90-10.94	65/66				F 026 002 137	→ 17,5	
	1.3 I.E.						F 026 002 138	← 17,5	
	1.4 I.E.	09.91-09.94	64				F 026 002 137	→ 17,5	
							F 026 002 138	← 17,5	
	1.5 I.E.	06.90-10.94	71/74				F 026 002 137	→ 17,5	
	1.5 I.E. 4x4						F 026 002 138	← 17,5	
	1.7 I.E., I.E. 4x4, I.E. 16V	01.90-10.94	77/95				F 026 002 137	→ 17,5	
							F 026 002 138	← 17,5	
	1.7 I.E. 16V 4x4	ABO 01.90-10.94	95-97				0 204 116 124	→ 19	
							0 204 116 125	← 19	
	1.8 D Turbo	02.90-10.94	62				F 026 002 137	→ 17,5	
							F 026 002 138	← 17,5	
	1.3	02.90-10.94	65/66				1 987 477 618	→ 1713	
	1.3 I.E.						1 987 477 620	← 1589	
	1.4 I.E.	09.91-09.94	64				1 987 477 618	→ 1713	
							1 987 477 620	← 1589	
	1.5 I.E.	06.90-10.94	74				1 987 477 618	→ 1713	
							1 987 477 620	← 1589	
	1.7 I.E. 16V	01.90-10.94	95				1 987 477 618	→ 1713	
							1 987 477 620	← 1589	
	1.8 D Turbo	02.90-10.94	62				1 987 477 519	→ 1664	
							1 987 477 620	← 1589	
	1.3 I.E.	09.91-10.94	65				0 265 003 061 <sup>3</sup>		
						LAB	0 265 003 066 <sup>4</sup>		
						RAB	0 265 003 062 <sup>4</sup>		
	1.4 I.E.	09.91-09.94	64				0 265 003 061 <sup>3</sup>		
						LAB	0 265 003 066 <sup>4</sup>		
						RAB	0 265 003 062 <sup>4</sup>		
	1.5 I.E.	06.90-10.94	74				0 265 003 061 <sup>3</sup>		
						LAB	0 265 003 066 <sup>4</sup>		
						RAB	0 265 003 062 <sup>4</sup>		
		04.92-10.94	71				0 265 003 066 <sup>4</sup>		
						LAB	0 265 003 066 <sup>4</sup>		
						RAB	0 265 003 062 <sup>4</sup>		
	1.5 I.E., I.E. 4x4	04.92-10.94	71				0 265 003 061 <sup>3</sup>		
	1.5 I.E. 4x4	04.92-10.94	71			LAB	0 265 001 267 <sup>4</sup>		
						RAB	0 265 001 268 <sup>4</sup>		
	1.7 I.E.	04.92-10.94	77			LAB	0 265 003 066 <sup>4</sup>		
						RAB	0 265 003 062 <sup>4</sup>		





































		S							
1.7 I.E., I.E. 4x4							0 265 003 061 <sup>3</sup>		
1.7 I.E. 4x4						LAB	0 265 001 267 <sup>4</sup>		
						RAB	0 265 001 268 <sup>4</sup>		
1.7 I.E. 16V							0 265 003 061 <sup>3</sup>		
						LAB	0 265 003 066 <sup>4</sup>		
						RAB	0 265 003 062 <sup>4</sup>		
1.7 I.E. 16V 4x4							0 265 003 061 <sup>3</sup>		
						LAB	0 265 001 267 <sup>4</sup>		
						RAB	0 265 001 268 <sup>4</sup>		
<b>33 Sportwagon [907B]</b>									
									
	1.3 1.3 4x4	ABO	01.90-10.94	66			0 204 102 556	← 48	
							0 204 103 556		
							0 204 102 557	→ 48	
							0 204 103 557		
	1.7 I.E. 4x4	ABO	03.92-10.94	77			0 204 102 556	← 48	
							0 204 103 556		
							0 204 102 557	→ 48	
							0 204 103 557		
									
	1.3 1.3 4x4		01.90-10.94	66			F 026 002 137	→ 17,5	
							F 026 002 138	← 17,5	
	1.7 I.E. 4x4		06.90-10.94	77/95-97			F 026 002 137	→ 17,5	
	1.7 I.E. 16V 4x4						F 026 002 138	← 17,5	
	1.8 TD		01.90-10.94	62			F 026 002 137	→ 17,5	
							F 026 002 138	← 17,5	
									
	1.3		01.90-10.94	66			1 987 477 618	→ 1713	
							1 987 477 620	← 1589	
	1.8 TD		01.90-10.94	62			1 987 477 519	→ 1664	
							1 987 477 620	← 1589	
									
	1.7 I.E. 4x4		06.90-10.94	77/95-97			0 265 003 061 <sup>3</sup>		
	1.7 I.E. 16V 4x4					LAB	0 265 001 267 <sup>4</sup>		
						RAB	0 265 001 268 <sup>4</sup>		
<b>145 [930 MY95]</b>									
									
	1.3 i.e.		04.94-11.96	68			0 204 102 530	← 54	0 204 104 237 <sup>7</sup>
							0 204 103 530		
							0 204 102 531	→ 54	0 204 104 237 <sup>7</sup>
							0 204 103 531		
	1.6 i.e.		04.94-11.96	78			0 204 102 530	← 54	0 204 104 237 <sup>7</sup>
							0 204 103 530		
							0 204 102 531	→ 54	0 204 104 237 <sup>7</sup>
							0 204 103 531		
	1.7 i.e. 16V		04.94-11.96	96			0 204 102 532	← 54	0 204 104 234 <sup>7</sup>
							0 204 103 532		
							0 204 102 533	→ 54	0 204 104 234 <sup>7</sup>
							0 204 103 533		
	1.9 TD		04.94-11.96	66			0 204 102 530	← 54	0 204 104 237 <sup>7</sup>
							0 204 103 530		
							0 204 102 531	→ 54	0 204 104 237 <sup>7</sup>
							0 204 103 531		



		S							
	◀ ALFA ROMEO 145 [930 MY95]								
	2.0 i.e. 16VT.S.	10.94-11.96	110			SP	0 204 102 575	← 54	
							0 986 134 005		
							0 204 102 576	→ 54	
							0 986 135 005		
		10.95-11.96	110				0 204 103 507	←	
							0 986 135 005	←	
							0 204 103 506	→	
							0 986 134 005	→	
	1.3 i.e.	ABO 04.94-11.96	68	Ricam.Nr →3102206			F 026 002 158	↔ 20,6	
				Ricam.Nr 3102207→			F 026 002 434	↔ 22	
	1.6 i.e.	ABO 04.94-11.96	78	Ricam.Nr →3102206			F 026 002 158	↔ 20,6	
				Ricam.Nr 3102207→			F 026 002 434	↔ 22	
	1.9 TD	ABO 04.94-11.96	66	Ricam.Nr →3102206			F 026 002 158	↔ 20,6	
				Ricam.Nr 3102207→			F 026 002 434	↔ 22	
	1.3 i.e.	ABS 04.94-11.96	68	Ricam.Nr →3056356			0 986 472 826	← 34	
							0 986 473 077		
							0 986 472 827	→ 34	
							0 986 474 077		
	1.6 i.e.	ABS 04.94-11.96	78	Ricam.Nr →3056356			0 986 472 826	← 34	
							0 986 473 077		
							0 986 472 827	→ 34	
							0 986 474 077		
	1.7 i.e. 16V	ABS 04.94-11.96	96	Ricam.Nr →3056356			0 986 472 826	← 34	
							0 986 473 077		
							0 986 472 827	→ 34	
							0 986 474 077		
	1.9 TD	ABS 04.94-11.96	66	Ricam.Nr →3056356			0 986 472 826	← 34	
							0 986 473 077		
							0 986 472 827	→ 34	
							0 986 474 077		
		10.94-11.96	66				0 986 473 121	← 33,9	
	2.0 i.e. 16VT.S.	10.94-11.96	110			VSP	0 986 473 121	← 33,9	
	1.3 i.e.	04.94-11.96	68			SBR	1 987 477 375	→ 1460	
							1 987 477 382	← 1517	
						TBR	1 987 482 177	← 1461	
							1 987 482 178	→ 1419	
	1.6 i.e.	04.94-11.96	78			SBR	1 987 477 375	→ 1460	
							1 987 477 382	← 1517	
						TBR	1 987 482 177	← 1461	
							1 987 482 178	→ 1419	
	1.7 i.e. 16V	04.94-11.96	96				1 987 477 375	→ 1460	
							1 987 477 382	← 1517	
	1.9 TD	04.94-11.96	66			SBR	1 987 477 375	→ 1460	
							1 987 477 382	← 1517	
						TBR	1 987 482 177	← 1461	
							1 987 482 178	→ 1419	
	2.0 i.e. 16VT.S.	10.94-11.96	110				1 987 477 375	→ 1460	
							1 987 477 382	← 1517	
	1.3 i.e.	04.94-11.96	68				0 265 006 162 <sup>3</sup>		
				Ricam.Nr →3076158			0 265 006 197 <sup>4</sup>		
				Ricam.Nr 3076159→		LAB	0 265 006 325 <sup>4</sup>		
						RAB	0 265 006 326 <sup>4</sup>		





























		S							
<b>1.6 i.e.</b>		04.94-11.96	78				0 265 <b>006 162</b> <sup>3</sup>		
						Ricam.Nr →3076158	0 265 <b>006 197</b> <sup>4</sup>		
						Ricam.Nr 3076159→	LAB 0 265 <b>006 325</b> <sup>4</sup>		
							RAB 0 265 <b>006 326</b> <sup>4</sup>		
<b>1.7 i.e. 16V</b>		04.94-11.96	96				0 265 <b>006 162</b> <sup>3</sup>		
						Ricam.Nr →3076158	0 265 <b>006 197</b> <sup>4</sup>		
						Ricam.Nr 3076159→	LAB 0 265 <b>006 325</b> <sup>4</sup>		
							RAB 0 265 <b>006 326</b> <sup>4</sup>		
<b>1.9 TD</b>		04.94-11.96	66				0 265 <b>006 162</b> <sup>3</sup>		
						Ricam.Nr →3076158	0 265 <b>006 197</b> <sup>4</sup>		
						Ricam.Nr 3076159→	LAB 0 265 <b>006 325</b> <sup>4</sup>		
							RAB 0 265 <b>006 326</b> <sup>4</sup>		
<b>2.0 i.e. 16V T.S.</b>		10.95-11.96	110				0 265 <b>006 162</b> <sup>3</sup>		
						Ricam.Nr →3076158	0 265 <b>006 197</b> <sup>4</sup>		
						Ricam.Nr 3076159→	LAB 0 265 <b>006 325</b> <sup>4</sup>		
							RAB 0 265 <b>006 326</b> <sup>4</sup>		
<b>145 [930 MY97]</b>									
									
	<b>1.4 i.e. 16V T.S.</b>	11.96-02.99	76				0 204 <b>902 103</b>	← 54	
							0 204 <b>103 502</b>		
							0 204 <b>902 104</b>	→ 54	
							0 204 <b>103 503</b>		
	<b>1.6 i.e. 16V T.S.</b>	11.96-02.99	88				0 204 <b>902 103</b>	← 54	
							0 204 <b>103 502</b>		
							0 204 <b>902 104</b>	→ 54	
							0 204 <b>103 503</b>		
	<b>1.8 i.e. 16V T.S.</b>	11.96-02.99	103				0 204 <b>102 506</b>	← 54	0 204 <b>104 208</b> <sup>B</sup>
							0 204 <b>103 506</b>		
							0 986 <b>134 005</b>		
							0 204 <b>102 507</b>	→ 54	0 204 <b>104 208</b> <sup>B</sup>
							0 204 <b>103 507</b>		
	<b>1.9 TD</b>	11.96-05.98	66				0 204 <b>902 103</b>	← 54	
							0 204 <b>103 502</b>		
							0 204 <b>902 104</b>	→ 54	
							0 204 <b>103 503</b>		
	<b>2.0 i.e. 16V T.S.</b>	11.96-04.98	110				0 204 <b>103 507</b>		←
							0 986 <b>135 005</b>		←
							0 204 <b>103 506</b>		→
							0 986 <b>134 005</b>		→
		11.96-02.99	110				0 204 <b>102 506</b>	← 54	0 204 <b>104 208</b> <sup>B</sup>
							0 204 <b>103 506</b>		
							0 986 <b>134 005</b>		
							0 204 <b>102 507</b>	→ 54	0 204 <b>104 208</b> <sup>B</sup>
							0 204 <b>103 507</b>		
		05.98-02.99	114				0 204 <b>102 575</b>	← 54	
							0 986 <b>134 005</b>		
							0 204 <b>102 576</b>	→ 54	
							0 986 <b>135 005</b>		
									
	<b>1.4 i.e. 16V T.S.</b>	11.96-02.99	76				F 026 <b>002 434</b>	↔ 22	
	<b>1.6 i.e. 16V T.S.</b>	11.96-02.99	88				F 026 <b>002 434</b>	↔ 22	
	<b>1.9 JTD, TD</b>	11.96-02.99	66/76				F 026 <b>002 434</b>	↔ 22	
	<b>1.4 i.e. 16V T.S.</b>	ABS	11.96-02.99	76			0 986 <b>473 121</b>	 ← 33,9	
	<b>1.6 i.e. 16V T.S.</b>	ABS	11.96-02.99	88			0 986 <b>473 121</b>	 ← 33,9	
	<b>1.8 i.e. 16V T.S.</b>		11.96-02.99	103			0 986 <b>473 121</b>	 ← 33,9	
	<b>1.9 TD</b>	ABS	11.96-05.98	66			0 986 <b>473 121</b>	 ← 33,9	



		S							
◀ ALFA ROMEO 145 [930 MY97]									
	1.4 i.e. 16VT.S.	11.96-02.99	76				1987 477 375	→ 1460	
							1987 477 382	← 1517	
	1.6 i.e. 16VT.S.	11.96-02.99	88				1987 477 375	→ 1460	
							1987 477 382	← 1517	
	1.8 i.e. 16VT.S.	11.96-02.99	103				1987 477 375	→ 1460	
							1987 477 382	← 1517	
	1.9 JTD	11.96-02.99	66/76				1987 477 375	→ 1460	
1.9 TD						1987 477 382	← 1517		
2.0 i.e. 16VT.S.	11.96-02.99	110/114				1987 477 375	→ 1460		
						1987 477 382	← 1517		
	1.4 i.e. 16VT.S.	11.96-02.99	76				0 265 006 162 <sup>3</sup>		
						LAB	0 265 006 325 <sup>4</sup>		
						RAB	0 265 006 326 <sup>4</sup>		
	1.6 i.e. 16VT.S.	11.96-02.99	88				0 265 006 162 <sup>3</sup>		
						LAB	0 265 006 325 <sup>4</sup>		
						RAB	0 265 006 326 <sup>4</sup>		
	1.8 i.e. 16VT.S.	11.96-04.98	103				0 265 006 162 <sup>3</sup>		
		11.96-02.99	103			LAB	0 265 006 325 <sup>4</sup>		
						RAB	0 265 006 326 <sup>4</sup>		
	1.9 JTD	05.98-02.99	76			LAB	0 265 007 063 <sup>3</sup>		
							0 265 007 065 <sup>4</sup>		
						RAB	0 265 007 064 <sup>3</sup>		
							0 265 007 066 <sup>4</sup>		
	1.9 TD	11.96-05.98	66				0 265 006 162 <sup>3</sup>		
					LAB	0 265 006 325 <sup>4</sup>			
					RAB	0 265 006 326 <sup>4</sup>			
2.0 i.e. 16VT.S.	11.96-02.99	110				0 265 006 212 <sup>3</sup>			
					LAB	0 265 006 325 <sup>4</sup>			
					RAB	0 265 006 326 <sup>4</sup>			
	05.98-02.99	114			LAB	0 265 006 325 <sup>4</sup>			
					RAB	0 265 006 326 <sup>4</sup>			
<b>145 [930 MY99]</b>									
	1.8 i.e. 16VT.S.	02.99-12.00	103				0 204 102 506	← 54	0 204 104 208 <sup>8</sup>
							0 204 103 506		
							0 986 134 005		
							0 204 102 507	→ 54	0 204 104 208 <sup>8</sup>
							0 204 103 507		
	2.0 i.e. 16VT.S.	02.99-12.00	110				0 204 102 506	← 54	0 204 104 208 <sup>8</sup>
						0 204 103 506			
						0 986 134 005			
						0 204 102 507	→ 54	0 204 104 208 <sup>8</sup>	
						0 204 103 507			
	1.4 i.e. 16VT.S.	02.99-12.00	76				F 026 002 434	↔ 22	
	1.6 i.e. 16VT.S.	02.99-12.00	82/88				F 026 002 434	↔ 22	
	1.8 i.e. 16VT.S.	02.99-12.00	103				F 026 002 434	↔ 22	
	1.9 JTD	02.99-12.00	76				F 026 002 434	↔ 22	
	2.0 i.e. 16VT.S.	02.99-12.00	110				F 026 002 434	↔ 22	
	1.4 i.e. 16VT.S.	02.99-12.00	76				1987 477 375	→ 1460	
							1987 477 382	← 1517	
	1.6 i.e. 16VT.S.	02.99-12.00	82/88				1987 477 375	→ 1460	
						1987 477 382	← 1517		



		S							
1.8 i.e. 16V T.S.		02.99-12.00	103				1 987 477 375	→ 1460	
							1 987 477 382	← 1517	
1.9 JTD		02.99-12.00	76				1 987 477 375	→ 1460	
							1 987 477 382	← 1517	
2.0 i.e. 16V T.S.		02.99-12.00	110				1 987 477 375	→ 1460	
							1 987 477 382	← 1517	
 1.4 i.e. 16V T.S.		02.99-12.00	76		LAB		0 265 007 063 <sup>3</sup>		
					RAB		0 265 007 065 <sup>4</sup>		
							0 265 007 064 <sup>3</sup>		
							0 265 007 066 <sup>4</sup>		
1.6 i.e. 16V T.S.		02.99-12.00	82/88		LAB		0 265 007 063 <sup>3</sup>		
					RAB		0 265 007 065 <sup>4</sup>		
							0 265 007 064 <sup>3</sup>		
							0 265 007 066 <sup>4</sup>		
1.8 i.e. 16V T.S.		02.99-12.00	103		LAB		0 265 007 063 <sup>3</sup>		
					RAB		0 265 007 065 <sup>4</sup>		
							0 265 007 064 <sup>3</sup>		
							0 265 007 066 <sup>4</sup>		
1.9 JTD		02.99-12.00	76		LAB		0 265 007 063 <sup>3</sup>		
					RAB		0 265 007 065 <sup>4</sup>		
							0 265 007 064 <sup>3</sup>		
							0 265 007 066 <sup>4</sup>		
2.0 i.e. 16V T.S.		02.99-12.00	110		LAB		0 265 007 063 <sup>3</sup>		
					RAB		0 265 007 065 <sup>4</sup>		
							0 265 007 064 <sup>3</sup>		
							0 265 007 066 <sup>4</sup>		
<b>146 [930 MY95]</b>									
									
 1.3 i.e.		12.94-11.96	68				0 204 102 530	← 54	0 204 104 237 <sup>7</sup>
							0 204 103 530		
							0 204 102 531	→ 54	0 204 104 237 <sup>7</sup>
							0 204 103 531		
1.6 i.e.		05.95-11.96	76-78				0 204 102 530	← 54	0 204 104 237 <sup>7</sup>
							0 204 103 530		
							0 204 102 531	→ 54	0 204 104 237 <sup>7</sup>
							0 204 103 531		
1.7 i.e. 16V		12.94-11.96	96				0 204 102 532	← 54	0 204 104 234 <sup>7</sup>
							0 204 103 532		
							0 204 102 533	→ 54	0 204 104 234 <sup>7</sup>
							0 204 103 533		
1.9 TD		12.94-11.96	66				0 204 102 532	← 54	0 204 104 234 <sup>7</sup>
							0 204 103 532		
							0 204 102 533	→ 54	0 204 104 234 <sup>7</sup>
							0 204 103 533		
						Fg.-Nr. →3022662	0 204 102 530	← 54	0 204 104 237 <sup>7</sup>
							0 204 103 530		
							0 204 102 531	→ 54	0 204 104 237 <sup>7</sup>
							0 204 103 531		
2.0 ti 16V T.S.		10.95-11.96	110				0 204 102 506	← 54	0 204 104 208 <sup>8</sup>
							0 204 103 506		
							0 986 134 005		
							0 204 102 507	→ 54	0 204 104 208 <sup>8</sup>
							0 204 103 507		
									
 1.3 i.e.		12.94-11.96	68				F 026 002 158	↔ 20,6	
1.6 i.e.		05.95-11.96	76-78				F 026 002 158	↔ 20,6	
1.9 TD		12.94-11.96	66				F 026 002 158	↔ 20,6	





































◀ ALFA ROMEO 146 [930 MY95]

	<b>1.3 i.e.</b>	ABS	12.94-11.96	68		0986 <b>472 826</b>	← 34
						0986 <b>473 077</b>	
						0986 <b>472 827</b>	→ 34
						0986 <b>474 077</b>	
	<b>1.6 i.e.</b>	ABS	05.95-11.96	76-78		0986 <b>472 826</b>	← 34
						0986 <b>473 077</b>	
						0986 <b>472 827</b>	→ 34
						0986 <b>474 077</b>	
	<b>1.7 i.e. 16V</b>		12.94-11.96	96		0986 <b>472 826</b>	← 34
						0986 <b>473 077</b>	
						0986 <b>472 827</b>	→ 34
						0986 <b>474 077</b>	
	<b>1.9 TD</b>	ABS	12.94-11.96	66		0986 <b>472 826</b>	← 34
						0986 <b>473 077</b>	
						0986 <b>472 827</b>	→ 34
						0986 <b>474 077</b>	



	<b>1.3 i.e.</b>	ABO	12.94-11.96	68	Ricam.Nr →78081	1987 <b>482 177</b>	← 1461				
						1987 <b>482 178</b>	→ 1419				
					Ricam.Nr 78082→	1987 <b>477 375</b>	→ 1460				
						1987 <b>477 382</b>	← 1517				
					ABS 12.94-11.96 68	1987 <b>477 375</b>	→ 1460				
						1987 <b>477 382</b>	← 1517				
					<b>1.6 i.e.</b>	ABO	05.95-11.96	76-78	Ricam.Nr →78081	1987 <b>482 177</b>	← 1461
										1987 <b>482 178</b>	→ 1419
									Ricam.Nr 78082→	1987 <b>477 375</b>	→ 1460
										1987 <b>477 382</b>	← 1517
									ABS 05.95-11.96 76-78	1987 <b>477 375</b>	→ 1460
										1987 <b>477 382</b>	← 1517
					<b>1.7 i.e. 16V</b>	ABO	12.94-11.96	96	Ricam.Nr →78081	1987 <b>482 177</b>	← 1461
										1987 <b>482 178</b>	→ 1419
									Ricam.Nr 78082→	1987 <b>477 375</b>	→ 1460
										1987 <b>477 382</b>	← 1517
ABS 12.94-11.96 96	1987 <b>477 375</b>	→ 1460									
	1987 <b>477 382</b>	← 1517									
<b>1.9 TD</b>	ABO	12.94-11.96	66	Ricam.Nr →78081	1987 <b>482 177</b>	← 1461					
					1987 <b>482 178</b>	→ 1419					
				Ricam.Nr 78082→	1987 <b>477 375</b>	→ 1460					
					1987 <b>477 382</b>	← 1517					
				ABS 12.94-11.96 66	1987 <b>477 375</b>	→ 1460					
					1987 <b>477 382</b>	← 1517					
<b>2.0 ti 16VT.S.</b>	ABO	10.95-11.96	110	Ricam.Nr →78081	1987 <b>482 177</b>	← 1461					
					1987 <b>482 178</b>	→ 1419					
				Ricam.Nr 78082→	1987 <b>477 375</b>	→ 1460					
					1987 <b>477 382</b>	← 1517					
				ABS 10.95-11.96 110	1987 <b>477 375</b>	→ 1460					
					1987 <b>477 382</b>	← 1517					

	<b>1.3 i.e.</b>	12.94-11.96	68		0265 <b>006 197</b> <sup>4</sup>	
					0265 <b>006 212</b> <sup>3</sup>	
	<b>1.6 i.e.</b>	05.95-11.96	76-78			0265 <b>006 197</b> <sup>4</sup>
						0265 <b>006 212</b> <sup>3</sup>
	<b>1.7 i.e. 16V</b>	12.94-11.96	96			0265 <b>006 197</b> <sup>4</sup>
						0265 <b>006 212</b> <sup>3</sup>
	<b>1.9 TD</b>	12.94-11.96	66			0265 <b>006 197</b> <sup>4</sup>
						0265 <b>006 212</b> <sup>3</sup>
	<b>2.0 ti 16VT.S.</b>	10.95-11.96	110			0265 <b>006 212</b> <sup>3</sup>
						LAB
RAB						0265 <b>006 326</b> <sup>4</sup>

		S							
<b>146 [930 MY97]</b>									
									
	1.4 i.e. 16V T.S.		11.96-02.99	76			0 204 902 103 0 204 103 502	← 54 	0 204 104 208 <sup>B</sup>
							0 204 902 104 0 204 103 503	→ 54 	0 204 104 208 <sup>B</sup>
	1.6 i.e. 16V T.S.		11.96-02.99	88			0 204 902 103 0 204 103 502	← 54 	0 204 104 208 <sup>B</sup>
							0 204 902 104 0 204 103 503	→ 54 	0 204 104 208 <sup>B</sup>
	1.8 i.e. 16V T.S.		11.96-02.99	103			0 204 102 506 0 204 103 506 0 986 134 005	← 54  	0 204 104 208 <sup>B</sup>
							0 204 102 507 0 204 103 507	→ 54 	0 204 104 208 <sup>B</sup>
	1.9 TD		11.96-05.98	66			0 204 902 103 0 204 103 502	← 54 	0 204 104 208 <sup>B</sup>
							0 204 902 104 0 204 103 503	→ 54 	0 204 104 208 <sup>B</sup>
	2.0 ti 16V T.S.		11.96-04.98	110			0 204 102 506 0 204 103 506 0 986 134 005	← 54  	0 204 104 208 <sup>B</sup>
							0 204 102 507 0 204 103 507	→ 54 	0 204 104 208 <sup>B</sup>
			05.98-02.99	110			0 204 102 575 0 986 134 005	← 54 	
							0 204 102 576 0 986 135 005	→ 54 	
									
	1.4 i.e. 16V T.S.		11.96-02.99	76			F 026 002 434	↔ 22	
	1.6 i.e. 16V T.S.		11.96-02.99	88			F 026 002 434	↔ 22	
	1.9 JTD, TD		11.96-02.99	66/77			F 026 002 434	↔ 22	
	1.4 i.e. 16V T.S.	ABS	11.96-02.99	76			0 986 473 121	 ← 33,9	
	1.6 i.e. 16V T.S.	ABS	11.96-02.99	88			0 986 473 121	 ← 33,9	
	1.8 i.e. 16V T.S.		11.96-02.99	103			0 986 473 121	 ← 33,9	
	1.9 TD	ABS	11.96-05.98	66			0 986 473 121	 ← 33,9	
									
	1.4 i.e. 16V T.S.	ABO	11.96-02.99	76			1 987 477 552 1 987 477 826	← 1428 → 1383	
		ABS	11.96-02.99	76			1 987 477 375 1 987 477 382	→ 1460 ← 1517	
	1.6 i.e. 16V T.S.	ABO	11.96-02.99	88			1 987 477 552 1 987 477 826	← 1428 → 1383	
		ABS	11.96-02.99	88			1 987 477 375 1 987 477 382	→ 1460 ← 1517	
	1.8 i.e. 16V T.S.	ABO	11.96-02.99	103			1 987 477 552 1 987 477 826	← 1428 → 1383	
		ABS	11.96-02.99	103			1 987 477 375 1 987 477 382	→ 1460 ← 1517	
	1.9 JTD	ABO	11.96-02.99	66/77			1 987 477 552 1 987 477 826	← 1428 → 1383	
	1.9 TD	ABS	11.96-02.99	66/77			1 987 477 375 1 987 477 382	→ 1460 ← 1517	
	2.0 ti 16V T.S.	ABO	11.96-02.99	110			1 987 477 552 1 987 477 826	← 1428 → 1383	
		ABS	11.96-02.99	110			1 987 477 375 1 987 477 382	→ 1460 ← 1517	





		S							
◀ ALFA ROMEO 146 [930 MY97]									
	1.4 i.e. 16VT.S.	11.96-02.99	76				0 265 006 162 <sup>3</sup>		
				LAB		0 265 006 325 <sup>4</sup>			
							RAB		0 265 006 326 <sup>4</sup>
	1.6 i.e. 16VT.S.	11.96-02.99	88				0 265 006 162 <sup>3</sup>		
				LAB		0 265 006 325 <sup>4</sup>			
							RAB		0 265 006 326 <sup>4</sup>
	1.8 i.e. 16VT.S.	11.96-02.99	103				0 265 006 162 <sup>3</sup>		
				LAB		0 265 006 325 <sup>4</sup>			
							RAB		0 265 006 326 <sup>4</sup>
	1.9 JTD	05.98-02.99	77				0 265 007 063 <sup>3</sup>		
						0 265 007 065 <sup>4</sup>			
							RAB		0 265 007 064 <sup>3</sup>
									0 265 007 066 <sup>4</sup>
	1.9 TD	11.96-05.98	66				0 265 006 162 <sup>3</sup>		
				LAB		0 265 006 325 <sup>4</sup>			
							RAB		0 265 006 326 <sup>4</sup>
	2.0 ti 16VT.S.	11.96-04.98	110				0 265 006 212 <sup>3</sup>		
						0 265 006 325 <sup>4</sup>			
						0 265 006 326 <sup>4</sup>			
		05.98-02.99	110				0 265 006 162 <sup>3</sup>		
<b>146 [930 MY99]</b>									
	1.8 i.e. 16VT.S.	02.99-12.00	103				0 204 102 506	← 54	0 204 104 208 <sup>8</sup>
						0 204 103 506			
							0 986 134 005		
							0 204 102 507	→ 54	0 204 104 208 <sup>8</sup>
							0 204 103 507		
	2.0 ti 16VT.S.	02.99-12.00	110				0 204 102 506	← 54	0 204 104 208 <sup>8</sup>
						0 204 103 506			
							0 986 134 005		
							0 204 102 507	→ 54	0 204 104 208 <sup>8</sup>
							0 204 103 507		
	1.4 i.e. 16VT.S.	02.99-12.00	76				F 026 002 434	↔ 22	
						F 026 002 434	↔ 22		
							F 026 002 434	↔ 22	
							F 026 002 434	↔ 22	
							F 026 002 434	↔ 22	
							F 026 002 434	↔ 22	
	1.4 i.e. 16VT.S.	02.99-12.00	76				1 987 477 375	→ 1460	
						1 987 477 382	← 1517		
							1 987 477 375	→ 1460	
							1 987 477 382	← 1517	
							1 987 477 375	→ 1460	
							1 987 477 382	← 1517	
							1 987 477 375	→ 1460	
							1 987 477 382	← 1517	
							1 987 477 375	→ 1460	
							1 987 477 382	← 1517	
	1.4 i.e. 16VT.S.	02.99-12.00	76				0 265 007 063 <sup>3</sup>		
				LAB		0 265 007 065 <sup>4</sup>			
							RAB		0 265 007 064 <sup>3</sup>
									0 265 007 066 <sup>4</sup>



1.6 i.e. 16V T.S.	02.99-12.00	82/88			LAB	0 265 007 063 <sup>3</sup>			
						0 265 007 065 <sup>4</sup>			
					RAB	0 265 007 064 <sup>3</sup>			
						0 265 007 066 <sup>4</sup>			
1.8 i.e. 16V T.S.	02.99-12.00	103			LAB	0 265 007 063 <sup>3</sup>			
						0 265 007 065 <sup>4</sup>			
					RAB	0 265 007 064 <sup>3</sup>			
						0 265 007 066 <sup>4</sup>			
1.9 JTD	02.99-12.00	77			LAB	0 265 007 063 <sup>3</sup>			
						0 265 007 065 <sup>4</sup>			
					RAB	0 265 007 064 <sup>3</sup>			
						0 265 007 066 <sup>4</sup>			
2.0 ti 16V T.S.	02.99-12.00	110			LAB	0 265 007 063 <sup>3</sup>			
						0 265 007 065 <sup>4</sup>			
					RAB	0 265 007 064 <sup>3</sup>			
						0 265 007 066 <sup>4</sup>			
<b>147 [937]</b>									
	1.6 TS 16V	11.00-09.01	88			0 204 102 854	← 54	0 204 104 208 <sup>B</sup>	
						0 204 103 854			
		0 204 102 855	→ 54	0 204 104 208 <sup>B</sup>					
		0 204 103 855							
		11.00-12.10	88		Fg.-Nr. 3384128→		0 204 902 105	←	0 204 104 208 <sup>B</sup>
							0 204 902 106	→	0 204 104 208 <sup>B</sup>
		10.01-12.10	88		Fg.-Nr. →3384127		0 204 102 854	← 54	0 204 104 208 <sup>B</sup>
							0 204 103 854		
							0 204 102 855	→ 54	0 204 104 208 <sup>B</sup>
							0 204 103 855		
	1.6 TS 16V ECO	11.00-09.01	77				0 204 102 847	← 54	
							0 986 473 157		
0 204 102 848							→ 54		
0 986 474 157									
							0 204 102 854	← 54	
							0 204 103 854		
							0 204 102 855	→ 54	
							0 204 103 855		
		11.00-12.10	77		Fg.-Nr. 3384128→		0 204 902 105	←	0 204 104 208 <sup>B</sup>
							0 204 902 106	→	0 204 104 208 <sup>B</sup>
		10.01-12.10	77		Fg.-Nr. →3384127		0 204 102 854	← 54	0 204 104 208 <sup>B</sup>
							0 204 103 854		
						0 204 102 855	→ 54	0 204 104 208 <sup>B</sup>	
						0 204 103 855			
1.9 JTD	11.00-09.01	81-85				0 204 102 854	← 54	0 204 104 208 <sup>B</sup>	
						0 204 103 854			
						0 204 102 855	→ 54	0 204 104 208 <sup>B</sup>	
						0 204 103 855			
		11.00-03.05	81-85		Fg.-Nr. 3384128→		0 204 902 105	←	0 204 104 208 <sup>B</sup>
							0 204 902 106	→	0 204 104 208 <sup>B</sup>
		10.01-03.05	81-85		Fg.-Nr. →3384127		0 204 102 854	← 54	0 204 104 208 <sup>B</sup>
							0 204 103 854		
							0 204 102 855	→ 54	0 204 104 208 <sup>B</sup>
							0 204 103 855		
		06.03-10.06	74		Fg.-Nr. →3384127		0 204 102 854	← 54	0 204 104 208 <sup>B</sup>
							0 204 103 854		
						0 204 102 855	→ 54	0 204 104 208 <sup>B</sup>	
						0 204 103 855			
				Fg.-Nr. 3384128→		0 204 902 105	←	0 204 104 208 <sup>B</sup>	
						0 204 902 106	→	0 204 104 208 <sup>B</sup>	



◀ ALFA ROMEO 147 [937]													
	1.9 JTDM	04.05-12.10	85/88	Fg.-Nr. →3384127	BSR	0 204 102 854	← 54	0 204 104 208 <sup>8</sup>					
						0 204 103 854							
						0 204 102 855	→ 54	0 204 104 208 <sup>8</sup>					
				Fg.-Nr. 3384128→	BSR	0 204 902 105	←	0 204 104 208 <sup>8</sup>					
						0 204 902 106	→	0 204 104 208 <sup>8</sup>					
	1.9 JTDM 16V	10.02-09.03	103	Fg.-Nr. →3384127			0 204 102 854	← 54	0 204 104 208 <sup>8</sup>				
							0 204 103 854						
							0 204 102 855	→ 54	0 204 104 208 <sup>8</sup>				
									Fg.-Nr. 3384128→	BSR	0 204 902 105	←	0 204 104 208 <sup>8</sup>
											0 204 902 106	→	0 204 104 208 <sup>8</sup>
		06.03-09.06	93	Fg.-Nr. →3384127		0 204 102 854	← 54	0 204 104 208 <sup>8</sup>					
						0 204 103 854							
						0 204 102 855	→ 54	0 204 104 208 <sup>8</sup>					
						Fg.-Nr. 3384128→	BSR	0 204 902 105	←	0 204 104 208 <sup>8</sup>			
								0 204 902 106	→	0 204 104 208 <sup>8</sup>			
		02.04-12.05	100	Fg.-Nr. →3384127		0 204 102 854	← 54	0 204 104 208 <sup>8</sup>					
						0 204 103 854							
						0 204 102 855	→ 54	0 204 104 208 <sup>8</sup>					
						Fg.-Nr. 3384128→	BSR	0 204 902 105	←	0 204 104 208 <sup>8</sup>			
								0 204 902 106	→	0 204 104 208 <sup>8</sup>			
		10.04-02.06	110	Fg.-Nr. →3384127		0 204 102 854	← 54	0 204 104 208 <sup>8</sup>					
						0 204 103 854							
						0 204 102 855	→ 54	0 204 104 208 <sup>8</sup>					
						Fg.-Nr. 3384128→	BSR	0 204 902 105	←	0 204 104 208 <sup>8</sup>			
								0 204 902 106	→	0 204 104 208 <sup>8</sup>			
		01.06-12.10	100	Fg.-Nr. →3384127	BSR	0 204 102 854	← 54	0 204 104 208 <sup>8</sup>					
						0 204 103 854							
						0 204 102 855	→ 54	0 204 104 208 <sup>8</sup>					
						Fg.-Nr. 3384128→	BSR	0 204 902 105	←	0 204 104 208 <sup>8</sup>			
								0 204 902 106	→	0 204 104 208 <sup>8</sup>			
		03.06-12.10	110	Fg.-Nr. →3384127	BSR	0 204 102 854	← 54	0 204 104 208 <sup>8</sup>					
						0 204 103 854							
						0 204 102 855	→ 54	0 204 104 208 <sup>8</sup>					
						Fg.-Nr. 3384128→	BSR	0 204 902 105	←	0 204 104 208 <sup>8</sup>			
								0 204 902 106	→	0 204 104 208 <sup>8</sup>			
		10.07-12.10	125	Fg.-Nr. →3384127	BSR	0 204 102 854	← 54	0 204 104 208 <sup>8</sup>					
						0 204 103 854							
						0 204 102 855	→ 54	0 204 104 208 <sup>8</sup>					
						Fg.-Nr. 3384128→	BSR	0 204 902 105	←	0 204 104 208 <sup>8</sup>			
								0 204 902 106	→	0 204 104 208 <sup>8</sup>			
		11.00-09.01	110		BSR	0 204 102 854	← 54						
						0 204 103 854							
						0 204 102 855	→ 54						
						Fg.-Nr. 3384128→	BSR	0 204 902 105	←	0 204 104 208 <sup>8</sup>			
								0 204 902 106	→	0 204 104 208 <sup>8</sup>			
		10.01-12.10	110	Fg.-Nr. →3384127	BSR	0 204 102 854	← 54	0 204 104 208 <sup>8</sup>					
						0 204 103 854							
						0 204 102 855	→ 54	0 204 104 208 <sup>8</sup>					
						Fg.-Nr. 3384128→	BSR	0 204 902 105	←	0 204 104 208 <sup>8</sup>			
								0 204 902 106	→	0 204 104 208 <sup>8</sup>			
	1.6 TS 16V	11.00-12.10	77/88			0 986 473 251	← 38						
	1.6 TS 16VECO					0 986 474 251	→ 38						



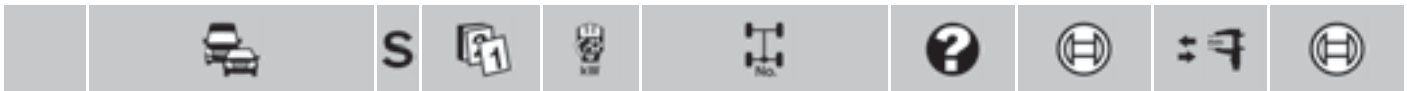

<b>1.9 JTD</b>	11.00-10.06	74/81-85			0 986 473 251	← 38	
					0 986 474 251	→ 38	
<b>1.9 JTDM</b>	06.03-12.10	85/88/93		BSR	0 986 473 251	← 38	
<b>1.9 JTDM 16V</b>					0 986 474 251	→ 38	
<b>1.9 JTDM 16V</b>	10.02-09.03	103			0 986 473 251	← 38	
					0 986 474 251	→ 38	
	02.04-12.05	100			0 986 473 251	← 38	
					0 986 474 251	→ 38	
	10.04-12.10	110/125		BSR	0 986 473 251	← 38	
					0 986 474 251	→ 38	
	01.06-12.10	100		BSR	0 986 473 251	← 38	
					0 986 474 251	→ 38	
<b>2.0 TS 16V</b>	11.00-12.10	110		BSR	0 986 473 251	← 38	
					0 986 474 251	→ 38	

	<b>1.6 TS 16V</b>	11.00-12.10	77/88		1 987 477 554	→ 1170	
	<b>1.6 TS 16V ECO</b>				1 987 477 831	← 1235	
	<b>1.9 JTD, JTDM, JTDM 16V</b>	11.00-12.10	74/81-85/88/93/ 100/103/110/125		1 987 477 554	→ 1170	
					1 987 477 831	← 1235	
	<b>2.0 TS 16V</b>	11.00-12.10	110		1 987 477 554	→ 1170	
					1 987 477 831	← 1235	
	<b>3.2 GTA</b>	01.03-12.10	184		1 987 477 831	← 1235	

	<b>1.6 TS 16V</b>	11.00-10.02	77/88	Ricam.Nr →03222100		0 265 007 089 <sup>4</sup>	
	<b>1.6 TS 16V ECO</b>				LAB	0 265 007 086 <sup>3</sup>	
					RAB	0 265 007 085 <sup>3</sup>	
		11.02-12.10	77/88	Ricam.Nr 03222101→		0 265 008 007 <sup>4</sup>	
					LAB	0 265 007 542 <sup>3</sup>	
					RAB	0 265 007 543 <sup>3</sup>	
	<b>1.9 JTD</b>	11.00-10.02	81-85	Ricam.Nr →03222100		0 265 007 089 <sup>4</sup>	
					LAB	0 265 007 086 <sup>3</sup>	
					RAB	0 265 007 085 <sup>3</sup>	
		11.02-03.05	81-85	Ricam.Nr 03222101→		0 265 008 007 <sup>4</sup>	
					LAB	0 265 007 542 <sup>3</sup>	
					RAB	0 265 007 543 <sup>3</sup>	
		06.03-10.06	74			0 265 008 007 <sup>4</sup>	
					LAB	0 265 007 542 <sup>3</sup>	
					RAB	0 265 007 543 <sup>3</sup>	
	<b>1.9 JTDM</b>	10.02-12.10	85/88/93/100/103/110/125			0 265 008 007 <sup>4</sup>	
	<b>1.9 JTDM 16V</b>	11.02-12.10	85/88/93/100/103/110/125		LAB	0 265 007 542 <sup>3</sup>	
					RAB	0 265 007 543 <sup>3</sup>	
	<b>2.0 TS 16V</b>	11.00-10.02	110	Ricam.Nr →03222100		0 265 007 089 <sup>4</sup>	
					LAB	0 265 007 086 <sup>3</sup>	
					RAB	0 265 007 085 <sup>3</sup>	
		11.02-12.10	110	Ricam.Nr 03222101→		0 265 008 007 <sup>4</sup>	
					LAB	0 265 007 542 <sup>3</sup>	
					RAB	0 265 007 543 <sup>3</sup>	
	<b>3.2 GTA</b>	01.03-12.10	184			0 265 008 007 <sup>4</sup>	
					LAB	0 265 007 486 <sup>3</sup>	
					RAB	0 265 007 487 <sup>3</sup>	































**155 [167 MY92]**

	<b>1.7 T.S.</b>	04.93-04.96	85	Ricam.Nr →00069451		0 204 102 528	← 48	0 204 104 234 <sup>7</sup>
						0 204 102 529	→ 48	0 204 104 234 <sup>7</sup>
				Ricam.Nr 00069452→		0 204 102 532	← 54	0 204 104 234 <sup>7</sup>
						0 204 103 532		
						0 204 102 533	→ 54	0 204 104 234 <sup>7</sup>
						0 204 103 533		



<b>◀ ALFA ROMEO 155 [167 MY92]</b>									
	1.8 T.S.	02.92-04.96	77	Ricam.Nr →00069451	0 204 102 528	← 48	0 204 104 234 <sup>7</sup>		
				Ricam.Nr →69452	0 204 102 529	→ 48	0 204 104 234 <sup>7</sup>		
	93-95	1.8 T.S.	02.92-04.96	77	Ricam.Nr →00069451	0 204 102 532	← 54	0 204 104 234 <sup>7</sup>	
					Ricam.Nr 00069452→	0 204 103 532	→ 54	0 204 104 234 <sup>7</sup>	
		1.9 TD	04.93-04.96	66		Ricam.Nr →00069451	0 204 102 533	→ 54	0 204 104 234 <sup>7</sup>
						Ricam.Nr 00069452→	0 204 103 533	→ 54	0 204 104 234 <sup>7</sup>
		2.0 T.S.	04.93-02.95	104		Ricam.Nr →00069451	0 204 102 530	← 54	0 204 104 237 <sup>7</sup>
						Ricam.Nr 00069452→	0 204 103 530	→ 54	0 204 104 237 <sup>7</sup>
		1.9 TD	04.93-04.96	66		Ricam.Nr →00069451	0 204 102 531	→ 54	0 204 104 237 <sup>7</sup>
						Ricam.Nr 00069452→	0 204 103 531	→ 54	0 204 104 237 <sup>7</sup>
2.0 T.S.	04.93-02.95	104		Ricam.Nr →00069451	0 204 102 528	← 48	0 204 104 234 <sup>7</sup>		
				Ricam.Nr 00069452→	0 204 102 529	→ 48	0 204 104 234 <sup>7</sup>		
2.0 T.S.	04.93-02.95	104		Ricam.Nr →00069451	0 204 102 532	← 54	0 204 104 234 <sup>7</sup>		
				Ricam.Nr 00069452→	0 204 103 532	→ 54	0 204 104 234 <sup>7</sup>		
2.0 T.S.	04.93-02.95	104		Ricam.Nr →00069451	0 204 102 533	→ 54	0 204 104 234 <sup>7</sup>		
				Ricam.Nr 00069452→	0 204 103 533	→ 54	0 204 104 234 <sup>7</sup>		
<hr/>									
	1.8 T.S.	02.92-07.95	77		0 986 473 077	← 33,9	1 987 470 028 <sup>7</sup>		
					0 986 474 077	→ 33,9	1 987 470 028 <sup>7</sup>		
	08.95-04.96	77		0 986 473 121	← 33,9	1 987 470 028 <sup>7</sup>			
				0 986 474 121	→ 33,9	1 987 470 028 <sup>7</sup>			
<hr/>									
	1.7 T.S.	04.93-04.96	85		1 987 477 375	→ 1460			
					1 987 477 382	← 1517			
	1.8 T.S.	02.92-04.96	77	93-95	Ricam.Nr →0159694	1 987 477 375	→ 1460		
					Ricam.Nr 0159168→	1 987 477 382	← 1517		
	1.9 TD	04.93-04.96	66		Ricam.Nr →0159167	1 987 477 375	→ 1460		
					Ricam.Nr 0159168→	1 987 477 382	← 1517		
	2.0 T.S.	02.92-04.96	104/140		Ricam.Nr →0159167	1 987 477 375	→ 1460		
					Ricam.Nr 0159168→	1 987 477 382	← 1517		
	2.5 TD, V6	02.92-04.96	92/120		Ricam.Nr →0159167	1 987 477 382	← 1517		
					Ricam.Nr 0159168→	1 987 477 382	← 1517		
<hr/>									
	1.7 T.S.	04.93-04.96	85		Ricam.Nr →0159167	0 265 006 197 <sup>4</sup>			
					Ricam.Nr 0159168→	0 265 006 212 <sup>3</sup>			
	1.8 T.S.	02.92-04.96	77/93-95		Ricam.Nr →0159167	0 265 006 162 <sup>3</sup>			
					Ricam.Nr 0159168→	0 265 006 197 <sup>4</sup>			
	1.9 TD	04.93-04.96	66		Ricam.Nr →0159167	0 265 006 212 <sup>3</sup>			
					Ricam.Nr 0159168→	0 265 006 197 <sup>4</sup>			
	2.0 T.S.	04.93-04.96	104/110		Ricam.Nr →0159167	0 265 006 162 <sup>3</sup>			
					Ricam.Nr 0159168→	0 265 006 212 <sup>3</sup>			
	2.0 Turbo 4x4	02.92-04.96	140		Ricam.Nr →0159167	0 265 006 197 <sup>4</sup>			
					Ricam.Nr 0159168→	0 265 001 304 <sup>4</sup>			
	2.5 TD	04.93-04.96	92		Ricam.Nr →0160724	0 265 001 355 <sup>3</sup>			
					Ricam.Nr 0160725→	0 265 006 162 <sup>3</sup>			
	2.5 TD	04.93-04.96	92		Ricam.Nr →0159167	0 265 006 197 <sup>4</sup>			
					Ricam.Nr 0159168→	0 265 006 212 <sup>3</sup>			
	2.5 TD	04.93-04.96	92		Ricam.Nr →0159167	0 265 006 197 <sup>4</sup>			
					Ricam.Nr 0159168→	0 265 006 162 <sup>3</sup>			

A

		S							
2.5 V6		02.92-04.96	120				0 265 006 197 <sup>4</sup>		
						Ricam.Nr →0159167	0 265 006 212 <sup>3</sup>		
						Ricam.Nr 0159168→	0 265 006 162 <sup>3</sup>		
<b>155 [167 MY96]</b>									
									
	1.6i 16VT.S.	05.96-10.97	85				0 204 102 532	← 54	
							0 204 103 532		
							0 204 102 533	→ 54	
							0 204 103 533		
	1.8i 16VT.S.	05.96-10.97	100		SBJ		0 204 102 532	← 54	
							0 204 103 532		
							0 204 102 533	→ 54	
							0 204 103 533		
	1.9TD	05.96-10.97	66				0 204 102 564	← 54	
							0 204 103 530		
							0 204 102 565	→ 54	
							0 204 103 531		
	2.0i 16VT.S.	05.96-10.97	110		SP		0 204 102 506	← 54	0 204 104 208 <sup>B</sup>
							0 204 103 506		
							0 986 134 005		
							0 204 102 507	→ 54	0 204 104 208 <sup>B</sup>
							0 204 103 507		
									
	1.6i 16VT.S.	05.96-10.97	85				1 987 477 375	→ 1460	
							1 987 477 382	← 1517	
	1.8i 16VT.S.	05.96-10.97	100				1 987 477 375	→ 1460	
							1 987 477 382	← 1517	
	2.0i 16VT.S.	05.96-10.97	110				1 987 477 375	→ 1460	
							1 987 477 382	← 1517	
	2.5i V6	10.92-10.97	120				1 987 477 375	→ 1460	
							1 987 477 382	← 1517	
	1.6i 16VT.S.	05.96-10.97	85				0 265 006 197 <sup>4</sup>		
							0 265 006 212 <sup>3</sup>		
	1.8i 16VT.S.	05.96-10.97	100				0 265 006 197 <sup>4</sup>		
							0 265 006 212 <sup>3</sup>		
	1.9TD	05.96-10.97	66				0 265 006 197 <sup>4</sup>		
							0 265 006 212 <sup>3</sup>		
	2.0i 16VT.S.	05.96-10.97	110				0 265 006 197 <sup>4</sup>		
							0 265 006 212 <sup>3</sup>		
	2.5i V6	10.92-10.97	92/120				0 265 006 197 <sup>4</sup>		
	2.5TD						0 265 006 212 <sup>3</sup>		
<b>156 Berlina [932]</b>									
									
	1.6 TS 16V	10.97-12.01	88				0 204 102 847	← 54	
							0 986 473 157		
							0 204 102 848	→ 54	
							0 986 474 157		
		04.98-09.00	82				0 204 102 847	← 54	
							0 986 473 157		
							0 204 102 848	→ 54	
							0 986 474 157		
		09.00-12.01	88				0 204 102 854	← 54	
							0 204 103 854		
							0 204 102 855	→ 54	
							0 204 103 855		



		S							
◀ ALFA ROMEO 156 Berlina [932]									
1.6 TS 16V	01.02-10.05	88					0 204 102 854	← 54	0 204 104 208 <sup>8</sup>
							0 204 103 854		
							0 204 102 855	→ 54	0 204 104 208 <sup>8</sup>
1.8 TS 16V	10.97-09.00	106					0 204 102 847	← 54	
							0 986 473 157		
							0 204 102 848	→ 54	
	09.00-12.01	103					0 204 102 847	← 54	
							0 986 473 157		
							0 204 102 848	→ 54	
	01.02-10.05	103					0 204 102 854	← 54	0 204 104 208 <sup>8</sup>
							0 204 103 854		
							0 204 102 855	→ 54	0 204 104 208 <sup>8</sup>
1.9 JTD	10.97-12.01	76/81-85					0 204 102 847	← 54	
							0 986 473 157		
							0 204 102 848	→ 54	
	06.03-12.04	74					0 204 102 854	← 54	0 204 104 208 <sup>8</sup>
							0 204 103 854		
							0 204 102 855	→ 54	0 204 104 208 <sup>8</sup>
1.9 JTD	01.02-10.05	85/93/100/					0 204 102 854	← 54	0 204 104 208 <sup>8</sup>
							0 204 103 854		
							0 204 102 855	→ 54	0 204 104 208 <sup>8</sup>
1.9 JTD 16V	01.02-10.05	103					0 204 103 855		
							0 204 102 855	→ 54	
							0 204 103 855		
1.9 JTD 16V	07.04-12.05	110					0 204 902 105	←	0 204 104 208 <sup>8</sup>
							0 204 902 106	→	0 204 104 208 <sup>8</sup>
2.0 JTS 16V	01.02-12.05	119/121					0 204 102 854	← 54	0 204 104 208 <sup>8</sup>
							0 204 103 854		
							0 204 102 855	→ 54	0 204 104 208 <sup>8</sup>
	10.97-12.01	114					0 204 103 855		
							0 204 102 854	← 54	0 204 104 208 <sup>8</sup>
							0 204 102 855	→ 54	0 204 104 208 <sup>8</sup>
	04.99-12.01	114					0 204 102 854	← 54	0 204 104 208 <sup>8</sup>
							0 204 103 854		
							0 204 102 855	→ 54	0 204 104 208 <sup>8</sup>
	09.00-10.05	110					0 204 103 855		
							0 204 102 854	← 54	0 204 104 208 <sup>8</sup>
							0 204 102 855	→ 54	0 204 104 208 <sup>8</sup>
2.0 TS 16V	10.97-12.01	114					0 204 103 855		
							0 204 102 854	← 54	
							0 204 102 855	→ 54	
2.4 JTD	10.97-09.00	100	Ricam.Nr 00125457→				0 204 102 854	← 54	0 204 104 208 <sup>8</sup>
							0 204 103 854		
							0 204 102 855	→ 54	0 204 104 208 <sup>8</sup>
	10.97-12.01	100					0 204 103 855		
							0 204 102 854	← 54	
							0 204 102 855	→ 54	
	09.00-12.01	100					0 204 103 855		
							0 204 102 854	← 54	0 204 104 208 <sup>8</sup>
							0 204 102 855	→ 54	0 204 104 208 <sup>8</sup>



		S							
2.4 JTD		01.02-10.05	110/120/				0 204 102 854	← 54	0 204 104 208 <sup>B</sup>
2.4 JTD 20V			129				0 204 103 854		
							0 204 102 855	→ 54	0 204 104 208 <sup>B</sup>
							0 204 103 855		
2.5 24V		10.97-12.01	140				0 204 102 854	← 54	
							0 204 103 854		
							0 204 102 855	→ 54	
							0 204 103 855		
		01.02-10.05	141				0 204 102 854	← 54	0 204 104 208 <sup>B</sup>
							0 204 103 854		
							0 204 102 855	→ 54	0 204 104 208 <sup>B</sup>
							0 204 103 855		
	1.6 TS 16V	01.02-10.05	88				0 986 473 251	← 38	
							0 986 474 251	→ 38	
	1.8 TS 16V	01.02-10.05	103				0 986 473 251	← 38	
							0 986 474 251	→ 38	
	1.9 JTD	01.02-12.05	74/85/93/100/				0 986 473 251	← 38	
	1.9 JTD 16V		103/110				0 986 474 251	→ 38	
	2.0 JTS 16V	01.02-12.05	110/119/				0 986 473 251	← 38	
	2.0 TS 16V		121				0 986 474 251	→ 38	
	2.4 JTD	01.02-10.05	110/120/				0 986 473 251	← 38	
	2.4 JTD 20V		129				0 986 474 251	→ 38	
	2.5 24V	01.02-10.05	141				0 986 473 251	← 38	
							0 986 474 251	→ 38	
	1.6 TS 16V	10.97-10.05	82/88				1 987 477 621	→ 1196	
							1 987 477 622	← 1256	
	1.8 TS 16V	10.97-10.05	103/106				1 987 477 621	→ 1196	
							1 987 477 622	← 1256	
	1.9 JTD	10.97-12.05	74/76/81-85/93/				1 987 477 621	→ 1196	
	1.9 JTD 16V		100/103/110				1 987 477 622	← 1256	
	2.0 JTS 16V	10.97-12.05	110/114/				1 987 477 621	→ 1196	
	2.0 TS 16V		119/121				1 987 477 622	← 1256	
	2.4 JTD	10.97-10.05	100/110/				1 987 477 621	→ 1196	
	2.4 JTD 20V		120/129				1 987 477 622	← 1256	
	2.5 24V	10.97-10.05	140/141				1 987 477 621	→ 1196	
							1 987 477 622	← 1256	
	3.2 GTA	03.02-10.05	184				1 987 477 621	→ 1196	
	1.6 TS 16V	10.97-12.01	88	Ricam.Nr →0062418			0 265 007 018 <sup>4</sup>		
					LAB		0 265 007 016 <sup>3</sup>		
					RAB		0 265 007 017 <sup>3</sup>		
				Ricam.Nr 0062419 →			0 265 007 048 <sup>4</sup>		
					LAB		0 265 007 046 <sup>3</sup>		
					RAB		0 265 007 047 <sup>3</sup>		
		04.98-09.00	82	Ricam.Nr →0062418			0 265 007 018 <sup>4</sup>		
					LAB		0 265 007 016 <sup>3</sup>		
					RAB		0 265 007 017 <sup>3</sup>		
				Ricam.Nr 0062419 →			0 265 007 048 <sup>4</sup>		
					LAB		0 265 007 046 <sup>3</sup>		
					RAB		0 265 007 047 <sup>3</sup>		
		01.02-10.02	88	Ricam.Nr →00526907			0 265 007 048 <sup>4</sup>		
					LAB		0 265 007 046 <sup>3</sup>		
					RAB		0 265 007 047 <sup>3</sup>		
		MFD 10.02-10.05	88				0 265 007 488 <sup>4</sup>		
					LAB		0 265 007 486 <sup>3</sup>		
					RAB		0 265 007 487 <sup>3</sup>		







◀ ALFA ROMEO 156 Berlina [932]						
<b>1.6 TS 16V</b>	OFD	10.02-10.05	88			0 265 007 113 <sup>4</sup>
					LAB	0 265 007 112 <sup>3</sup>
<b>1.8 TS 16V</b>	10.97-09.00	106		Ricam.Nr →0062418		0 265 007 018 <sup>4</sup>
					LAB	0 265 007 016 <sup>3</sup>
			RAB	0 265 007 111 <sup>3</sup>		
			Ricam.Nr 0062419→		0 265 007 018 <sup>4</sup>	
				LAB	0 265 007 046 <sup>3</sup>	
				RAB	0 265 007 017 <sup>3</sup>	
				Ricam.Nr 0062419→	0 265 007 048 <sup>4</sup>	
				LAB	0 265 007 046 <sup>3</sup>	
				RAB	0 265 007 047 <sup>3</sup>	
		09.00-12.01	103		Ricam.Nr →0062418	0 265 007 018 <sup>4</sup>
				LAB	0 265 007 016 <sup>3</sup>	
				RAB	0 265 007 017 <sup>3</sup>	
				Ricam.Nr 0062419→	0 265 007 048 <sup>4</sup>	
				LAB	0 265 007 046 <sup>3</sup>	
				RAB	0 265 007 047 <sup>3</sup>	
	01.02-10.02	103		Ricam.Nr →00526907	0 265 007 048 <sup>4</sup>	
				LAB	0 265 007 046 <sup>3</sup>	
				RAB	0 265 007 047 <sup>3</sup>	
	MFD	10.02-10.05	103		0 265 007 488 <sup>4</sup>	
				LAB	0 265 007 486 <sup>3</sup>	
				RAB	0 265 007 487 <sup>3</sup>	
	OFD	10.02-10.05	103		0 265 007 113 <sup>4</sup>	
				LAB	0 265 007 112 <sup>3</sup>	
				RAB	0 265 007 111 <sup>3</sup>	
<b>1.9 JTD</b>	10.97-12.01	76/81-85		Ricam.Nr →0062418		0 265 007 018 <sup>4</sup>
					LAB	0 265 007 016 <sup>3</sup>
					RAB	0 265 007 017 <sup>3</sup>
					Ricam.Nr 0062419→	0 265 007 048 <sup>4</sup>
					LAB	0 265 007 046 <sup>3</sup>
					RAB	0 265 007 047 <sup>3</sup>
	01.02-10.02	85		Ricam.Nr →00526907	0 265 007 048 <sup>4</sup>	
				LAB	0 265 007 046 <sup>3</sup>	
				RAB	0 265 007 047 <sup>3</sup>	
<b>1.9 JTD</b>	MFD	10.02-12.05	74/85/93/		0 265 007 488 <sup>4</sup>	
<b>1.9 JTD 16V</b>			100/103/		LAB	0 265 007 486 <sup>3</sup>
			110		RAB	0 265 007 487 <sup>3</sup>
	OFD	10.02-12.05	74/85/93/		0 265 007 113 <sup>4</sup>	
			100/103/		LAB	0 265 007 112 <sup>3</sup>
			110		RAB	0 265 007 111 <sup>3</sup>
<b>2.0 JTS 16V</b>	01.02-10.02	119/121		Ricam.Nr →00526907		0 265 007 048 <sup>4</sup>
					LAB	0 265 007 046 <sup>3</sup>
					RAB	0 265 007 047 <sup>3</sup>
		MFD	10.02-12.05	119/121		0 265 007 488 <sup>4</sup>
					LAB	0 265 007 486 <sup>3</sup>
					RAB	0 265 007 487 <sup>3</sup>
	OFD	10.02-12.05	119/121		0 265 007 113 <sup>4</sup>	
				LAB	0 265 007 112 <sup>3</sup>	
				RAB	0 265 007 111 <sup>3</sup>	
<b>2.0 TS 16V</b>	10.97-12.01	110/114		Ricam.Nr →0062418		0 265 007 018 <sup>4</sup>
					LAB	0 265 007 016 <sup>3</sup>
					RAB	0 265 007 017 <sup>3</sup>
					Ricam.Nr 0062419→	0 265 007 048 <sup>4</sup>
					LAB	0 265 007 046 <sup>3</sup>
					RAB	0 265 007 047 <sup>3</sup>
		MFD	01.02-10.05	110		0 265 007 488 <sup>4</sup>
					LAB	0 265 007 486 <sup>3</sup>
					RAB	0 265 007 487 <sup>3</sup>
		OFD	01.02-10.05	110		0 265 007 113 <sup>4</sup>
				LAB	0 265 007 112 <sup>3</sup>	
				RAB	0 265 007 111 <sup>3</sup>	





















		S										
2.4 JTD		10.97-12.01	100	Ricam.Nr →0062418			0 265 007 018 <sup>4</sup>					
							LAB	0 265 007 016 <sup>3</sup>				
							RAB	0 265 007 017 <sup>3</sup>				
							Ricam.Nr 0062419→	0 265 007 048 <sup>4</sup>				
							LAB	0 265 007 046 <sup>3</sup>				
							RAB	0 265 007 047 <sup>3</sup>				
2.4 JTD 2.4 JTD 20V		MFD 10.02-10.05	110/120/ 129	Ricam.Nr →00526907			0 265 007 488 <sup>4</sup>					
							LAB	0 265 007 486 <sup>3</sup>				
							RAB	0 265 007 487 <sup>3</sup>				
							OFD 10.02-10.05	110/120/ 129	0 265 007 113 <sup>4</sup>			
							LAB	0 265 007 112 <sup>3</sup>				
							RAB	0 265 007 111 <sup>3</sup>				
2.5 24V		10.97-12.01	140	Ricam.Nr →0062418			0 265 007 018 <sup>4</sup>					
							LAB	0 265 007 016 <sup>3</sup>				
							RAB	0 265 007 017 <sup>3</sup>				
							Ricam.Nr 0062419→	0 265 007 048 <sup>4</sup>				
							LAB	0 265 007 046 <sup>3</sup>				
							RAB	0 265 007 047 <sup>3</sup>				
		01.02-10.02	141	Ricam.Nr →00526907				0 265 007 048 <sup>4</sup>				
								LAB	0 265 007 046 <sup>3</sup>			
								RAB	0 265 007 047 <sup>3</sup>			
								MFD 10.02-10.05	141	0 265 007 488 <sup>4</sup>		
								LAB	0 265 007 486 <sup>3</sup>			
								RAB	0 265 007 487 <sup>3</sup>			
01.02-10.02	141	Ricam.Nr →00526907				0 265 007 113 <sup>4</sup>						
						LAB	0 265 007 112 <sup>3</sup>					
						RAB	0 265 007 111 <sup>3</sup>					
						OFD 10.02-10.05	141	0 265 007 113 <sup>4</sup>				
						LAB	0 265 007 112 <sup>3</sup>					
						RAB	0 265 007 111 <sup>3</sup>					
3.2 GTA		03.02-10.02	184	Ricam.Nr →00526907			0 265 007 048 <sup>4</sup>					
							LAB	0 265 007 046 <sup>3</sup>				
							RAB	0 265 007 047 <sup>3</sup>				
							MFD 10.02-10.05	184	0 265 007 488 <sup>4</sup>			
							LAB	0 265 007 486 <sup>3</sup>				
							RAB	0 265 007 487 <sup>3</sup>				
OFD 10.02-10.05	184	Ricam.Nr →00526907				0 265 007 113 <sup>4</sup>						
						LAB	0 265 007 112 <sup>3</sup>					
						RAB	0 265 007 111 <sup>3</sup>					
						<b>156 Sport Wagon Q4 [932]</b>						
							1.9 JTD 16V 4x4	10.04-12.05	110			
LAB	0 265 007 795 <sup>3</sup>											
RAB	0 265 007 796 <sup>3</sup>											
<b>156 Sport Wagon [932]</b>												
	1.6 TS 16V	06.00-12.01	88				0 204 102 847	← 54				
							0 986 473 157					
							0 204 102 848	→ 54				
							0 986 474 157					
							09.00-12.01	88	0 204 102 854	← 54		
							0 204 103 854					
		01.02-12.05	88					0 204 102 855	→ 54			
								0 204 103 855				
								0 204 102 854	← 54	0 204 104 208 <sup>B</sup>		
								0 204 103 854				
								0 204 102 855	→ 54	0 204 104 208 <sup>B</sup>		
								0 204 103 855				



		S							
	◀ ALFA ROMEO 156 Sport Wagon [932]								
1.8 TS 16V	06.00-12.01	106	0204 102 847	←	54				
			0986 473 157						
			0204 102 848	→	54				
	09.00-12.01	106	0986 474 157						
			0204 102 854	←	54				
			0204 103 854						
	01.02-12.05	106	0204 102 855	→	54				
			0204 103 855						
			0204 102 854	←	54	0204 104 208 <sup>8</sup>			
	01.02-12.05	106	0204 103 854						
			0204 102 855	→	54	0204 104 208 <sup>8</sup>			
			0204 103 855						
1.9 JTD	06.00-12.01	76/80-85	0204 102 847	←	54				
			0986 473 157						
			0204 102 848	→	54				
	06.03-12.04	74	0986 474 157						
			0204 102 854	←	54	0204 104 208 <sup>8</sup>			
			0204 103 854						
	01.02-12.05	103	0204 102 855	→	54	0204 104 208 <sup>8</sup>			
			0204 103 855						
			0204 102 854	←	54	0204 104 208 <sup>8</sup>			
1.9 JTD	01.02-12.05	85/93/100/	0204 102 854	←	54	0204 104 208 <sup>8</sup>			
			0204 103 854						
			0204 102 855	→	54	0204 104 208 <sup>8</sup>			
1.9 JTD 16V	01.02-12.05	103	0204 103 855						
			0204 102 854	←	54	0204 104 208 <sup>8</sup>			
			0204 103 854						
2.0 JTS 16V	01.02-12.05	121	0204 102 855	→	54	0204 104 208 <sup>8</sup>			
			0204 103 855						
			0204 102 854	←	54	0204 104 208 <sup>8</sup>			
2.0 TS 16V	06.00-10.05	110/114	0204 103 854						
			0204 102 854	←	54	0204 104 208 <sup>8</sup>			
			0204 102 855	→	54	0204 104 208 <sup>8</sup>			
2.0 JTS 16V	01.02-12.05	121	0204 103 855						
			0204 102 854	←	54	0204 104 208 <sup>8</sup>			
			0204 103 854						
2.0 TS 16V	06.00-10.05	110/114	0204 102 855	→	54	0204 104 208 <sup>8</sup>			
			0204 103 855						
			0204 102 854	←	54	0204 104 208 <sup>8</sup>			
2.4 JTD	06.00-09.00	100	Ricam.Nr 00125457→						
			0204 102 854	←	54	0204 104 208 <sup>8</sup>			
			0204 103 854						
	06.00-12.01	100	0204 102 855	→	54	0204 104 208 <sup>8</sup>			
			0204 103 855						
			0204 102 854	←	54				
	06.00-12.01	100	0204 103 854						
			0204 102 855	→	54				
			0204 103 855						
	09.00-12.01	100	0204 102 854	←	54	0204 104 208 <sup>8</sup>			
			0204 103 854						
			0204 102 855	→	54	0204 104 208 <sup>8</sup>			
2.4 JTD	01.02-12.05	110/120/	0204 103 855						
			0204 102 854	←	54	0204 104 208 <sup>8</sup>			
			0204 103 854						
2.4 JTD 20V	01.02-12.05	129	0204 102 855	→	54	0204 104 208 <sup>8</sup>			
			0204 103 855						
			0204 102 854	←	54				
2.5 24V	06.00-12.01	140	0204 103 854						
			0204 102 854	←	54				
			0204 102 855	→	54				
	01.02-10.05	141	0204 103 855						
			0204 102 854	←	54	0204 104 208 <sup>8</sup>			
			0204 103 854						
	01.02-10.05	141	0204 102 855	→	54	0204 104 208 <sup>8</sup>			
			0204 103 855						
			0204 102 854	←	54				
	1.6 TS 16V	01.02-12.05	88	0986 473 251		←	38		
				0986 474 251		→	38		
	1.8 TS 16V	08.01-12.05	106	0986 473 251		←	38		
				0986 474 251		→	38		



























		<b>S</b>							
<b>1.9 JTD</b>		08.01-12.05	74/80-85/93/				0 986 473 251		← 38
<b>1.9 JTD 16V</b>			100/103/110				0 986 474 251		→ 38
<b>2.0 JTS 16V</b>		01.02-12.05	110/121				0 986 473 251		← 38
<b>2.0 TS 16V</b>							0 986 474 251		→ 38
<b>2.4 JTD</b>		08.01-12.05	100/110/				0 986 473 251		← 38
<b>2.4 JTD 20V</b>			120/129				0 986 474 251		→ 38
<b>2.5 24V</b>		01.02-10.05	141				0 986 473 251		← 38
							0 986 474 251		→ 38
									
	<b>1.6 TS 16V</b>	06.00-12.05	88				1 987 477 621		→ 1196
							1 987 477 622		← 1256
	<b>1.8 TS 16V</b>	06.00-12.05	106				1 987 477 621		→ 1196
							1 987 477 622		← 1256
	<b>1.9 JTD</b>	06.00-12.05	74/76/80-85/				1 987 477 621		→ 1196
	<b>1.9 JTD 16V</b>		93/100/103				1 987 477 622		← 1256
	<b>2.0 JTS 16V</b>	06.00-12.05	110/114/				1 987 477 621		→ 1196
	<b>2.0 TS 16V</b>		121				1 987 477 622		← 1256
	<b>2.4 JTD</b>	06.00-12.05	100/110/				1 987 477 621		→ 1196
	<b>2.4 JTD 20V</b>		120/129				1 987 477 622		← 1256
	<b>2.5 24V</b>	06.00-10.05	140/141				1 987 477 621		→ 1196
							1 987 477 622		← 1256
	<b>3.2 GTA</b>	03.02-10.05	184				1 987 477 621		→ 1196
	<b>1.6 TS 16V</b>	06.00-12.01	88	Ricam.Nr →0062418			0 265 007 018 <sup>4</sup>		
						LAB	0 265 007 016 <sup>3</sup>		
						RAB	0 265 007 017 <sup>3</sup>		
				Ricam.Nr 0062419 →			0 265 007 048 <sup>4</sup>		
						LAB	0 265 007 046 <sup>3</sup>		
						RAB	0 265 007 047 <sup>3</sup>		
		01.02-10.02	88	Ricam.Nr →00526907			0 265 007 048 <sup>4</sup>		
						LAB	0 265 007 046 <sup>3</sup>		
						RAB	0 265 007 047 <sup>3</sup>		
		MFD 10.02-12.05	88				0 265 007 488 <sup>4</sup>		
						LAB	0 265 007 486 <sup>3</sup>		
						RAB	0 265 007 487 <sup>3</sup>		
		OFD 10.02-12.05	88				0 265 007 113 <sup>4</sup>		
						LAB	0 265 007 112 <sup>3</sup>		
						RAB	0 265 007 111 <sup>3</sup>		
	<b>1.8 TS 16V</b>	06.00-12.01	106	Ricam.Nr →0062418			0 265 007 018 <sup>4</sup>		
						LAB	0 265 007 016 <sup>3</sup>		
						RAB	0 265 007 017 <sup>3</sup>		
				Ricam.Nr 0062419 →			0 265 007 048 <sup>4</sup>		
						LAB	0 265 007 046 <sup>3</sup>		
						RAB	0 265 007 047 <sup>3</sup>		
		01.02-10.02	106	Ricam.Nr →00526907			0 265 007 048 <sup>4</sup>		
						LAB	0 265 007 046 <sup>3</sup>		
						RAB	0 265 007 047 <sup>3</sup>		
		MFD 10.02-12.05	106				0 265 007 488 <sup>4</sup>		
						LAB	0 265 007 486 <sup>3</sup>		
						RAB	0 265 007 487 <sup>3</sup>		
		OFD 10.02-12.05	106				0 265 007 113 <sup>4</sup>		
						LAB	0 265 007 112 <sup>3</sup>		
						RAB	0 265 007 111 <sup>3</sup>		
	<b>1.9 JTD</b>	06.00-12.01	76/80-85	Ricam.Nr →0062418			0 265 007 018 <sup>4</sup>		
						LAB	0 265 007 016 <sup>3</sup>		
						RAB	0 265 007 017 <sup>3</sup>		
				Ricam.Nr 0062419 →			0 265 007 048 <sup>4</sup>		
						LAB	0 265 007 046 <sup>3</sup>		
						RAB	0 265 007 047 <sup>3</sup>		



<b>ALFA ROMEO 156 Sport Wagon [932]</b>									
1.9 JTD	01.02-10.02	85	Ricam.Nr →00526907		0 265 007 048 <sup>4</sup>				
				LAB	0 265 007 046 <sup>3</sup>				
				RAB	0 265 007 047 <sup>3</sup>				
1.9 JTD	MFD 10.02-12.05	74/85/93/	100/103		0 265 007 488 <sup>4</sup>				
				LAB	0 265 007 486 <sup>3</sup>				
1.9 JTD 16V	10.02-12.05	74/85/93/	100/103		0 265 007 487 <sup>3</sup>				
				RAB	0 265 007 487 <sup>3</sup>				
1.9 JTD 16V	10.03-12.05	93/110		OFD	0 265 007 113 <sup>4</sup>				
				LAB	0 265 007 112 <sup>3</sup>				
				RAB	0 265 007 111 <sup>3</sup>				
2.0 JTS 16V	01.02-10.02	121	Ricam.Nr →00526907		0 265 007 048 <sup>4</sup>				
				LAB	0 265 007 046 <sup>3</sup>				
				RAB	0 265 007 047 <sup>3</sup>				
2.0 JTS 16V	10.02-12.05	121		MFD	0 265 007 488 <sup>4</sup>				
				LAB	0 265 007 486 <sup>3</sup>				
				RAB	0 265 007 487 <sup>3</sup>				
2.0 JTS 16V	10.02-12.05	121		OFD	0 265 007 113 <sup>4</sup>				
				LAB	0 265 007 112 <sup>3</sup>				
				RAB	0 265 007 111 <sup>3</sup>				
2.0 TS 16V	06.00-12.01	110/114	Ricam.Nr →0062418		0 265 007 018 <sup>4</sup>				
				LAB	0 265 007 016 <sup>3</sup>				
				RAB	0 265 007 017 <sup>3</sup>				
2.0 TS 16V	01.02-10.05	110	Ricam.Nr 0062419→		0 265 007 048 <sup>4</sup>				
				LAB	0 265 007 046 <sup>3</sup>				
				RAB	0 265 007 047 <sup>3</sup>				
2.0 TS 16V	01.02-10.05	110		MFD	0 265 007 488 <sup>4</sup>				
				LAB	0 265 007 486 <sup>3</sup>				
				RAB	0 265 007 487 <sup>3</sup>				
2.0 TS 16V	01.02-10.05	110		OFD	0 265 007 113 <sup>4</sup>				
				LAB	0 265 007 112 <sup>3</sup>				
				RAB	0 265 007 111 <sup>3</sup>				
2.4 JTD	06.00-12.01	100	Ricam.Nr →0062418		0 265 007 018 <sup>4</sup>				
				LAB	0 265 007 016 <sup>3</sup>				
				RAB	0 265 007 017 <sup>3</sup>				
2.4 JTD	01.02-10.02	110	Ricam.Nr 0062419→		0 265 007 048 <sup>4</sup>				
				LAB	0 265 007 046 <sup>3</sup>				
				RAB	0 265 007 047 <sup>3</sup>				
2.4 JTD	01.02-10.02	110	Ricam.Nr →00526907		0 265 007 048 <sup>4</sup>				
				LAB	0 265 007 046 <sup>3</sup>				
				RAB	0 265 007 047 <sup>3</sup>				
2.4 JTD	MFD 10.02-12.05	110/120/	129		0 265 007 488 <sup>4</sup>				
				LAB	0 265 007 486 <sup>3</sup>				
2.4 JTD 20V	10.02-12.05	110/120/	129		0 265 007 487 <sup>3</sup>				
				RAB	0 265 007 487 <sup>3</sup>				
2.4 JTD 20V	10.02-12.05	110/120/	129	OFD	0 265 007 113 <sup>4</sup>				
				LAB	0 265 007 112 <sup>3</sup>				
				RAB	0 265 007 111 <sup>3</sup>				
2.5 24V	06.00-12.01	140	Ricam.Nr →0062418		0 265 007 018 <sup>4</sup>				
				LAB	0 265 007 016 <sup>3</sup>				
				RAB	0 265 007 017 <sup>3</sup>				
2.5 24V	01.02-10.02	141	Ricam.Nr 0062419→		0 265 007 048 <sup>4</sup>				
				LAB	0 265 007 046 <sup>3</sup>				
				RAB	0 265 007 047 <sup>3</sup>				
2.5 24V	01.02-10.02	141	Ricam.Nr →00526907		0 265 007 048 <sup>4</sup>				
				LAB	0 265 007 046 <sup>3</sup>				
				RAB	0 265 007 047 <sup>3</sup>				
2.5 24V	10.02-10.05	141		MFD	0 265 007 488 <sup>4</sup>				
				LAB	0 265 007 486 <sup>3</sup>				
				RAB	0 265 007 487 <sup>3</sup>				
2.5 24V	10.02-10.05	141		OFD	0 265 007 113 <sup>4</sup>				
				LAB	0 265 007 112 <sup>3</sup>				
				RAB	0 265 007 111 <sup>3</sup>				



									
3.2 GTA		03.02-10.02	184	Ricam.Nr →00526907			0 265 007 048 <sup>4</sup>		
							LAB 0 265 007 046 <sup>3</sup>		
							RAB 0 265 007 047 <sup>3</sup>		
		MFD 10.02-10.05	184				0 265 007 488 <sup>4</sup>		
							LAB 0 265 007 486 <sup>3</sup>		
							RAB 0 265 007 487 <sup>3</sup>		
		OFD 10.02-10.05	184				0 265 007 113 <sup>4</sup>		
							LAB 0 265 007 112 <sup>3</sup>		
							RAB 0 265 007 111 <sup>3</sup>		
<b>156 Sportwagon [932]</b>									
									
	2.0 JTS 16V	01.02-12.05	119				0 204 102 854	← 54	0 204 104 208 <sup>8</sup>
							0 204 103 854		
							0 204 102 855	→ 54	0 204 104 208 <sup>8</sup>
							0 204 103 855		
									
	2.0 JTS 16V	01.02-12.05	119				0 986 473 251	 ← 38	
							0 986 474 251	 → 38	
									
	2.0 JTS 16V	01.02-12.05	119				1 987 477 621	→ 1196	
							1 987 477 622	← 1256	
	2.0 JTS 16V	01.02-10.02	119	Ricam.Nr →00526907			0 265 007 048 <sup>4</sup>		
							LAB 0 265 007 046 <sup>3</sup>		
							RAB 0 265 007 047 <sup>3</sup>		
		MFD 10.02-12.05	119				0 265 007 488 <sup>4</sup>		
							LAB 0 265 007 486 <sup>3</sup>		
							RAB 0 265 007 487 <sup>3</sup>		
		OFD 10.02-12.05	119				0 265 007 113 <sup>4</sup>		
							LAB 0 265 007 112 <sup>3</sup>		
							RAB 0 265 007 111 <sup>3</sup>		
<b>159 Berlina Q4 [939]</b>									
									
	2.4 JTD 20V	09.06-12.08	154				1 987 477 111	← 1755	
							1 987 477 112	→ 1735	
	3.2 JTS	01.06-12.08	191-195				1 987 477 111	← 1755	
							1 987 477 112	→ 1735	
	2.4 JTD 20V	09.06-12.08	154				0 265 008 055 <sup>3</sup>		
							0 265 008 056 <sup>4</sup>		
	3.2 JTS	01.06-12.08	191-195				0 265 008 055 <sup>3</sup>		
							0 265 008 056 <sup>4</sup>		
<b>159 Berlina [939]</b>									
									
	1.8 i	03.06-11.11	103/147				1 987 477 111	← 1755	
	1.8 TBi						1 987 477 112	→ 1735	
	1.9 JTDM 8V, JTDM 16V, JTS	06.05-12.08	85/88/100/ 110/118				1 987 477 111	← 1755	
							1 987 477 112	→ 1735	
	2.0 JTDM	05.09-12.11	100/120/				1 987 477 111	← 1755	
	2.0 JTDM 16V		125				1 987 477 112	→ 1735	
	2.2 JTS	06.05-12.08	136				1 987 477 111	← 1755	
							1 987 477 112	→ 1735	



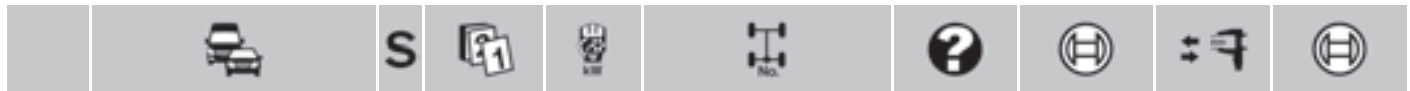

	◀ ALFA ROMEO 159 Berlina [939]						
	2.4 JTD 20V	06.05-12.08	147/154		1987 477 111	← 1755	
	2.4 JTDM 20V				1987 477 112	→ 1735	
	3.2 JTS	08.07-12.08	195		1987 477 111	← 1755	
					1987 477 112	→ 1735	

	1.8 i	03.06-08.07	103		0 265 008 055 <sup>3</sup>		
		03.06-11.11	103		0 265 008 056 <sup>4</sup>		
09.07-11.11		103		0 265 008 218 <sup>3</sup>			
	1.8 TBi	05.09-11.11	147		0 265 008 218 <sup>3</sup>		
	1.9 JTDM 8V	06.05-08.07	88		0 265 008 055 <sup>3</sup>		
		06.05-12.08	88		0 265 008 056 <sup>4</sup>		
		01.06-08.07	85		0 265 008 055 <sup>3</sup>		
		01.06-12.08	85		0 265 008 056 <sup>4</sup>		
	09.07-12.08	88		0 265 008 218 <sup>3</sup>			
	1.9 JTDM 16V	01.06-08.07	100		0 265 008 055 <sup>3</sup>		
	01.06-12.08	100		0 265 008 056 <sup>4</sup>			
	1.9 JTDM 16V	06.05-08.07	110/118		0 265 008 055 <sup>3</sup>		
	1.9 JTS	06.05-12.08	110/118		0 265 008 056 <sup>4</sup>		
		09.07-12.08	110/118		0 265 008 218 <sup>3</sup>		
	2.0 JTDM	05.09-12.11	120		0 265 008 056 <sup>4</sup>		
					0 265 008 218 <sup>3</sup>		
	2.0 JTDM 16V	05.09-12.10	125		0 265 008 218 <sup>3</sup>		
		06.10-12.11	100		0 265 008 218 <sup>3</sup>		
	2.2 JTS	06.05-08.07	136		0 265 008 055 <sup>3</sup>		
		06.05-12.08	136		0 265 008 056 <sup>4</sup>		
		09.07-12.08	136		0 265 008 218 <sup>3</sup>		
	2.4 JTD 20V	06.05-08.07	147/154		0 265 008 055 <sup>3</sup>		
	2.4 JTDM 20V	06.05-12.08	147/154		0 265 008 056 <sup>4</sup>		
		09.07-12.08	147/154		0 265 008 218 <sup>3</sup>		
	3.2 JTS	08.07-12.08	195		0 265 008 055 <sup>3</sup>		
					0 265 008 056 <sup>4</sup>		



















**159 Sport Wagon Q4 [939]**

	2.4 JTD 20V	09.06-12.08	154		1987 477 111	← 1755	
					1987 477 112	→ 1735	
	3.2 JTS	03.06-12.08	191-195		1987 477 111	← 1755	
					1987 477 112	→ 1735	

	2.4 JTD 20V	09.06-12.08	154		0 265 008 055 <sup>3</sup>		
					0 265 008 056 <sup>4</sup>		
	3.2 JTS	03.06-12.08	191-195		0 265 008 055 <sup>3</sup>		
					0 265 008 056 <sup>4</sup>		

**159 Sport Wagon [939]**

	1.8 TBi	05.09-12.10	147		1987 477 111	← 1755	
					1987 477 112	→ 1735	
	1.9 JTDM 8V, JTDM 16V, JTS	03.06-12.08	85/88/100/ 110/118		1987 477 111	← 1755	
					1987 477 112	→ 1735	
	2.0 JTDM	05.09-12.11	100/120/		1987 477 111	← 1755	
	2.0 JTDM 16V		125		1987 477 112	→ 1735	
	2.2 JTS	03.06-12.08	136		1987 477 111	← 1755	
					1987 477 112	→ 1735	
	2.4 JTD 20V	03.06-12.08	147/154		1987 477 111	← 1755	
	2.4 JTDM 20V				1987 477 112	→ 1735	
	3.2 JTS	08.07-12.08	195		1987 477 111	← 1755	
					1987 477 112	→ 1735	

		S							
	1.8 Tbi	05.09-12.10	147				0 265 008 218 <sup>3</sup>		
	1.9 JTDM 8V	03.06-08.07	85				0 265 008 055 <sup>3</sup>		
			88				0 265 008 055 <sup>3</sup>		
		03.06-12.08	85				0 265 008 056 <sup>4</sup>		
			88				0 265 008 056 <sup>4</sup>		
		09.07-12.08	88				0 265 008 218 <sup>3</sup>		
	1.9 JTDM 16V	03.06-08.07	100				0 265 008 055 <sup>3</sup>		
		03.06-12.08	100				0 265 008 056 <sup>4</sup>		
	1.9 JTDM 16V	03.06-08.07	110/118				0 265 008 055 <sup>3</sup>		
	1.9 JTS	03.06-12.08	110/118				0 265 008 056 <sup>4</sup>		
		09.07-12.08	110/118				0 265 008 218 <sup>3</sup>		
	2.0 JTDM	05.09-12.11	120				0 265 008 056 <sup>4</sup>		
							0 265 008 218 <sup>3</sup>		
	2.0 JTDM 16V	05.09-12.10	125				0 265 008 218 <sup>3</sup>		
		06.10-12.11	100				0 265 008 218 <sup>3</sup>		
	2.2 JTS	03.06-08.07	136				0 265 008 055 <sup>3</sup>		
		03.06-12.08	136				0 265 008 056 <sup>4</sup>		
		09.07-12.08	136				0 265 008 218 <sup>3</sup>		
	2.4 JTD 20V	03.06-08.07	147/154				0 265 008 055 <sup>3</sup>		
	2.4 JTDM 20V	03.06-12.08	147/154				0 265 008 056 <sup>4</sup>		
		09.07-12.08	147/154				0 265 008 218 <sup>3</sup>		
	3.2 JTS	08.07-12.08	195				0 265 008 055 <sup>3</sup>		
							0 265 008 056 <sup>4</sup>		
<b>159 Sportwagon [939]</b>									
									
	1.8 i	03.06-12.08	103				1 987 477 111	← 1755	
							1 987 477 112	→ 1735	
	1.8 i	03.06-08.07	103				0 265 008 055 <sup>3</sup>		
		03.06-12.08	103				0 265 008 056 <sup>4</sup>		
		09.07-12.08	103				0 265 008 218 <sup>3</sup>		
<b>164 [164]</b>									
									
	2.0 T.S.	09.92-10.98	106	Fg.-Nr. 6297365→			0 204 102 526	← 48	0 204 104 237 <sup>7</sup>
							0 204 103 526	↻	
							0 204 102 527	→ 48	0 204 104 237 <sup>7</sup>
							0 204 103 527	↻	
									
	2.0 T.S.	09.92-10.98	106/148				0 986 473 027	↻ ← 38	
	2.0 V6 Turbo						0 986 474 027	↻ → 38	
	2.5 D Turbo	09.92-10.98	92				0 986 473 027	↻ ← 38	
							0 986 474 027	↻ → 38	
	3.0 V6 12V, V6 24V, V6 24V Q.V., V6 24V Q.V. G.D.	09.92-10.98	132/145/ 155/169-171				0 986 473 027	↻ ← 38	
							0 986 474 027	↻ → 38	
									
	2.0 T.S., V6 Turbo	09.92-10.98	106/148				1 987 477 390	2950	
	2.5 D Turbo	09.92-10.98	92				1 987 477 390	2950	
	3.0 V6 12V, V6 24V, V6 24V Q.V., V6 24V Q.V. G.D.	09.92-10.98	132/145/ 155/169-171				1 987 477 390	2950	
	2.0 T.S.	09.92-10.98	106			LAB	0 265 006 118 <sup>3</sup>		
						RAB	0 265 006 119 <sup>3</sup>		
				Fg.-Nr. →6302794			0 265 003 075 <sup>4</sup>		



		S							
	<b>◀ ALFA ROMEO 164 [164]</b>								
2.0 V6 Turbo	09.92-10.98	148				LAB	0 265 006 118 <sup>3</sup>		
						RAB	0 265 006 119 <sup>3</sup>		
						Fg.-Nr. →6299489	0 265 003 075 <sup>4</sup>		
2.5 D Turbo	09.92-10.98	92				LAB	0 265 006 118 <sup>3</sup>		
						RAB	0 265 006 119 <sup>3</sup>		
						Fg.-Nr. →6302794	0 265 003 075 <sup>4</sup>		
3.0 Q4 4x4	12.93-10.98	171					0 265 006 120 <sup>4</sup>		
							0 265 006 118 <sup>3</sup>		
						RAB	0 265 006 119 <sup>3</sup>		
3.0 V6 12V	09.92-10.98	132/145				LAB	0 265 006 118 <sup>3</sup>		
						RAB	0 265 006 119 <sup>3</sup>		
						Fg.-Nr. →6302794	0 265 003 075 <sup>4</sup>		
3.0 V6 24V	09.92-10.98	155				LAB	0 265 006 118 <sup>3</sup>		
						RAB	0 265 006 119 <sup>3</sup>		
						Fg.-Nr. →6299489	0 265 003 075 <sup>4</sup>		
3.0 V6 24V Q.V.	09.92-10.98	169-171				LAB	0 265 006 118 <sup>3</sup>		
3.0 V6 24V Q.V. G.D.						RAB	0 265 006 119 <sup>3</sup>		
						Fg.-Nr. →6302794	0 265 003 075 <sup>4</sup>		
<b>166 [936]</b>									
	2.0 T.S. 16V	10.98-03.99	114				0 204 001 441	← 57	
							0 204 001 442	→ 57	
		04.99-09.00	114				0 204 102 871	← 57	
							0 986 473 496		
							0 204 102 872	→ 57	
							0 986 474 496		
		09.00-10.07	110				0 204 102 871	← 57	
							0 986 473 496		
							0 204 102 872	→ 57	
							0 986 474 496		
	2.0 Turbo V6	04.99-12.04	151				0 204 102 871	← 57	
							0 986 473 496		
							0 204 102 872	→ 57	
							0 986 474 496		
	2.4 JTD	10.98-03.99	100				0 204 001 441	← 57	
							0 204 001 442	→ 57	
		04.99-09.00	100				0 204 102 871	← 57	
							0 986 473 496		
							0 204 102 872	→ 57	
							0 986 474 496		
	2.4 JTD	09.00-10.07	100-110/				0 204 102 871	← 57	
	2.4 JTD 20V		120/128/				0 986 473 496		
	2.4 JTDM 20V		129/				0 204 102 872	→ 57	
			132-136				0 986 474 496		
	2.5 V6 24V	04.99-12.06	140				0 204 102 871	← 57	
							0 986 473 496		
							0 204 102 872	→ 57	
							0 986 474 496		
	3.0 V6 24V	04.99-09.00	166				0 204 102 871	← 57	
							0 986 473 496		
							0 204 102 872	→ 57	
							0 986 474 496		
	2.0 T.S. 16V	10.98-10.07	110/114/				1 987 477 623	← 1445	
							1 987 477 624	→ 1427	
	2.0 Turbo V6		151				1 987 477 658	311	
	2.4 JTD	10.98-10.07	100-110/120/				1 987 477 623	← 1445	
	2.4 JTD 20V		128/129/				1 987 477 624	→ 1427	
	2.4 JTDM 20V		132-136				1 987 477 658	311	

		<b>S</b>							
2.5 V6 24V		07.98-10.07	140				1 987 477 623	← 1445	
							1 987 477 624	→ 1427	
							1 987 477 658	311	
3.0 V6 24V		10.98-10.07	166				1 987 477 623	← 1445	
							1 987 477 624	→ 1427	
							1 987 477 658	311	
3.2 V6 24V		06.03-10.07	176,5				1 987 477 623	← 1445	
							1 987 477 624	→ 1427	
							1 987 477 658	311	

	2.0 T.S. 16V	10.98-10.07	110/114/				0 265 007 022 <sup>4</sup>		
	2.0 Turbo V6		151		LAB		0 265 007 021 <sup>3</sup>		
					RAB		0 265 007 020 <sup>3</sup>		
	2.4 JTD	10.98-10.07	100-110/120/				0 265 007 022 <sup>4</sup>		
	2.4 JTD 20V		128/129/		LAB		0 265 007 021 <sup>3</sup>		
	2.4 JTDM 20V		132-136		RAB		0 265 007 020 <sup>3</sup>		
	2.5 V6 24V	07.98-10.07	140				0 265 007 022 <sup>4</sup>		
					LAB		0 265 007 021 <sup>3</sup>		
					RAB		0 265 007 020 <sup>3</sup>		
	3.0 V6 24V	10.98-10.07	166				0 265 007 022 <sup>4</sup>		
					LAB		0 265 007 021 <sup>3</sup>		
					RAB		0 265 007 020 <sup>3</sup>		
	3.2 V6 24V	06.03-10.07	176,5				0 265 007 022 <sup>4</sup>		
					LAB		0 265 007 021 <sup>3</sup>		
					RAB		0 265 007 020 <sup>3</sup>		

**ALPINA (B. BOVENSIEPEN KG)**

**B7 [E65/66]**



	4.4	12.03-09.05	368				0 265 007 592 <sup>3</sup>		
		12.03-06.08	368				0 265 007 845 <sup>4</sup>		

**Roadster [Z8]**



	V8	06.02-10.03	280				0 986 594 531 <sup>4</sup>		
--	----	-------------	-----	--	--	--	----------------------------	--	--

**ASTON MARTIN**

**Virage Coupé**



	5.3 Kompressor	10.92-12.99	410				0 265 006 216 <sup>3</sup>		
--	----------------	-------------	-----	--	--	--	----------------------------	--	--

**AUDI**

**A1 Sportback [8X]**



	1.0 TFSI	03.15-05.15	70	PR-Code 1ZG	252			F 026 A06 100 <sup>7</sup>
						0 986 473 071	← 54	F 026 A06 100 <sup>7</sup>
						0 986 474 071	→ 54	F 026 A06 100 <sup>7</sup>
		03.15→	70	PR-Code 1ZC, PR-Code 1ZS	288		0 986 473 384	← 53,94
							0 986 474 384	→ 53,94



			S								
	◀ AUDI A1 Sportback [8X]										
1.2 TFSI	01.12-04.15	63	PR-Code 1ZC, PR-Code 1ZS	288	0986 473 384		← 53,94	F 026 A06 106 <sup>7</sup>			
					0986 474 384		→ 53,94	F 026 A06 106 <sup>7</sup>			
			PR-Code 1ZG	252	0986 473 071		← 54				
					0986 474 071		→ 54				
1.4 TDI	11.14-05.15	66	PR-Code 1ZG	252				F 026 A06 100 <sup>7</sup>			
					0986 473 071		← 54	F 026 A06 100 <sup>7</sup>			
					0986 474 071		→ 54	F 026 A06 100 <sup>7</sup>			
	11.14→	66	PR-Code 1ZC, PR-Code 1ZS	288	0986 473 384		← 53,94				
					0986 474 384		→ 53,94				
1.4 TFSI	11.11-04.15	90	PR-Code 1ZC, PR-Code 1ZS	288	0986 473 384		← 53,94	F 026 A06 106 <sup>7</sup>			
					0986 474 384		→ 53,94	F 026 A06 106 <sup>7</sup>			
			PR-Code 1ZG	252	0986 473 071		← 54				
					0986 474 071		→ 54				
		136	PR-Code 1LJ	312				F 026 A06 106 <sup>7</sup>			
					0986 473 071		← 54				
			PR-Code 1ZG	252	0986 473 071		← 54				
					0986 474 071		→ 54				
	02.13-04.15	103	PR-Code 1ZC, PR-Code 1ZS	288	0986 473 384		← 53,94	F 026 A06 106 <sup>7</sup>			
					0986 474 384		→ 53,94	F 026 A06 106 <sup>7</sup>			
			PR-Code 1ZG	252	0986 473 071		← 54				
					0986 474 071		→ 54				
	11.14-05.15	92	PR-Code 1ZG	252				F 026 A06 100 <sup>7</sup>			
					0986 473 071		← 54	F 026 A06 100 <sup>7</sup>			
					0986 474 071		→ 54	F 026 A06 100 <sup>7</sup>			
								F 026 A06 100 <sup>7</sup>			
	11.14→	92	PR-Code 1ZC, PR-Code 1ZS	288	0986 473 384		← 53,94				
					0986 474 384		→ 53,94				
		110	PR-Code 1ZG	252				F 026 A06 100 <sup>7</sup>			
					0986 473 071		← 54	F 026 A06 100 <sup>7</sup>			
					0986 474 071		→ 54	F 026 A06 100 <sup>7</sup>			
								F 026 A06 100 <sup>7</sup>			
	11.14→	92	PR-Code 1ZC, PR-Code 1ZS	288	0986 473 384		← 53,94				
					0986 474 384		→ 53,94				
		110	PR-Code 1ZC, PR-Code 1ZS	288	0986 473 384		← 53,94				
					0986 474 384		→ 53,94				
1.6 TDI	11.11-04.15	66/77	PR-Code 1ZC, PR-Code 1ZS	288	0986 473 384		← 53,94	F 026 A06 106 <sup>7</sup>			
					0986 474 384		→ 53,94	F 026 A06 106 <sup>7</sup>			
			PR-Code 1ZG	252	0986 473 071		← 54				
					0986 474 071		→ 54				
	11.14-05.15	85	PR-Code 1ZG	252				F 026 A06 100 <sup>7</sup>			
					0986 473 071		← 54	F 026 A06 100 <sup>7</sup>			
					0986 474 071		→ 54	F 026 A06 100 <sup>7</sup>			
								F 026 A06 100 <sup>7</sup>			
	11.14→	85	PR-Code 1ZC, PR-Code 1ZS	288	0986 473 384		← 53,94				
					0986 474 384		→ 53,94				
1.8 TFSI	02.15-05.15	141	PR-Code 1ZG	252				F 026 A06 100 <sup>7</sup>			
					0986 473 071		← 54	F 026 A06 100 <sup>7</sup>			
					0986 474 071		→ 54	F 026 A06 100 <sup>7</sup>			
								F 026 A06 100 <sup>7</sup>			
	02.15→	141	PR-Code 1ZC, PR-Code 1ZS	288	0986 473 384		← 53,94				
					0986 474 384		→ 53,94				
2.0 TDI	09.11-04.15	100/105	PR-Code 1ZC, PR-Code 1ZS	288	0986 473 384		← 53,94	F 026 A06 106 <sup>7</sup>			
					0986 474 384		→ 53,94	F 026 A06 106 <sup>7</sup>			
			PR-Code 1ZG	252	0986 473 071		← 54				
					0986 474 071		→ 54				
<hr/>											
	1.0 TFSI	03.15→	70	PR-Code 1KT, PR-Code 1KX, PR-Code 1KF	232				1987 470 040 <sup>7</sup>		
	1.2 TFSI	01.12-04.15	63	PR-Code 1KS		F 026 700 014		←			
						F 026 700 015		→			
				PR-Code 1KT	232				1987 470 040 <sup>7</sup>		

		S											
1.4 TDI		11.14→	66	PR-Code 1KT, PR-Code 1KX, PR-Code 1KF	232				1 987 470 040 <sup>7</sup>				
1.4 TFSI		11.11-04.15	90	PR-Code 1KS			F 026 700 014	←					
							F 026 700 015	→					
			136	PR-Code 1KT	232					1 987 470 040 <sup>7</sup>			
							F 026 700 014	←					
									F 026 700 015	→			
				02.13-04.15	103	PR-Code 1KS			F 026 700 014	←			
				PR-Code 1KT	232		F 026 700 015	→	1 987 470 040 <sup>7</sup>				
1.6 TDI		11.11-04.15	66/77	PR-Code 1KS			F 026 700 014	←					
							F 026 700 015	→					
				11.14→	85	PR-Code 1KT, PR-Code 1KX, PR-Code 1KF	232			1 987 470 040 <sup>7</sup>			
1.8 TFSI		02.15→	141	PR-Code 1KT, PR-Code 1KX, PR-Code 1KF	232			1 987 470 040 <sup>7</sup>					
2.0 TDI		09.11-04.15	100/105	PR-Code 1KS			F 026 700 014	←					
							F 026 700 015	→					
				PR-Code 1KT	232				1 987 470 040 <sup>7</sup>				
		1.2 TFSI	01.12-04.15	63			1 987 482 267	↔	1642				
		1.4 TFSI	11.11-04.15	90/103/136			1 987 482 267	↔	1642				
		1.6 TDI	11.11-04.15	66/77			1 987 482 267	↔	1642				
		2.0 TDI	09.11-04.15	100/105			1 987 482 267	↔	1642				
		1.0 TFSI	03.15→	70		LAB,Y85	0 986 594 504 <sup>4</sup>						
						RAB,Y85	0 986 594 507 <sup>4</sup>						
		1.4 TDI	11.14→	66/92/110			LAB,Y85	0 986 594 504 <sup>4</sup>					
		1.4 TFSI					RAB,Y85	0 986 594 507 <sup>4</sup>					
		1.6 TDI	11.14→	85			LAB,Y85	0 986 594 504 <sup>4</sup>					
							RAB,Y85	0 986 594 507 <sup>4</sup>					
1.8 TFSI		02.15→	141			LAB,Y85	0 986 594 504 <sup>4</sup>						
						RAB,Y85	0 986 594 507 <sup>4</sup>						
<b>A1 [8X]</b>													
		1.0 TFSI	03.15-05.15	70	PR-Code 1ZG	252			F 026 A06 100 <sup>7</sup>				
								0 986 473 071	↔	54	F 026 A06 100 <sup>7</sup>		
									0 986 474 071	↔	54	F 026 A06 100 <sup>7</sup>	
				03.15→	70	PR-Code 1ZC, PR-Code 1ZS	288		0 986 473 384	↔	53,94		
									0 986 474 384	↔	53,94		
		1.2 TFSI		05.10-04.15	63		PR-Code 1ZC, PR-Code 1ZS	288		0 986 473 384	↔	53,94	1 987 470 506 <sup>8</sup>
										0 986 474 384	↔	53,94	F 026 A06 106 <sup>7</sup>
												PR-Code 1ZG	252
									0 986 474 071	↔	54		
		1.4 TDI		11.14-05.15	66	PR-Code 1ZG	252				F 026 A06 100 <sup>7</sup>		
	0 986 473 071							↔	54	F 026 A06 100 <sup>7</sup>			
									0 986 474 071	↔	54	F 026 A06 100 <sup>7</sup>	
					110	PR-Code 1ZG	252				F 026 A06 100 <sup>7</sup>		
							0 986 473 071	↔	54	F 026 A06 100 <sup>7</sup>			
							0 986 474 071	↔	54	F 026 A06 100 <sup>7</sup>			



◀ AUDI A1 [8X]								
1.4 TDI	11.14→	66	PR-Code 1ZC, PR-Code 1ZS	288	0986 473 384		←	53,94
					0986 474 384		→	53,94
		110	PR-Code 1ZC, PR-Code 1ZS	288	0986 473 384		←	53,94
					0986 474 384		→	53,94
1.4 TFSI	05.10-04.15	90	PR-Code 1ZC, PR-Code 1ZS	288	0986 473 384		←	53,94
					0986 474 384		→	53,94
		136	PR-Code 1ZG	252	0986 473 071		←	54
					0986 474 071		→	54
	01.11-04.15	136	PR-Code 1LJ	312				1987 470 506 <sup>8</sup>
					PR-Code 1ZG	252	0986 473 071	
					0986 474 071		→	54
	02.13-04.15	103	PR-Code 1ZC, PR-Code 1ZS	288	0986 473 384		←	53,94
					0986 474 384		→	53,94
		103	PR-Code 1ZG	252	0986 473 071		←	54
					0986 474 071		→	54
	11.14-05.15	92	PR-Code 1ZG	252				F 026 A06 100 <sup>7</sup>
					0986 473 071		←	54
					0986 474 071		→	54
	11.14→	92	PR-Code 1ZC, PR-Code 1ZS	288	0986 473 384		←	53,94
					0986 474 384		→	53,94
1.6 TDI	05.10-04.15	66/77	PR-Code 1ZC, PR-Code 1ZS	288	0986 473 384		←	53,94
					0986 474 384		→	53,94
		85	PR-Code 1ZG	252	0986 473 071		←	54
					0986 474 071		→	54
	11.14→	85	PR-Code 1ZC, PR-Code 1ZS	288	0986 473 384		←	53,94
					0986 474 384		→	53,94
1.8 TFSI	02.15-05.15	141	PR-Code 1ZG	252				F 026 A06 100 <sup>7</sup>
					0986 473 071		←	54
					0986 474 071		→	54
	02.15→	141	PR-Code 1ZC, PR-Code 1ZS	288	0986 473 384		←	53,94
					0986 474 384		→	53,94
2.0 TDI	09.11-04.15	100/105	PR-Code 1ZC, PR-Code 1ZS	288	0986 473 384		←	53,94
					0986 474 384		→	53,94
		100/105	PR-Code 1ZG	252	0986 473 071		←	54
					0986 474 071		→	54
2.0 TFSI quattro	03.12-12.12	188	PR-Code 1LJ	312				1987 470 506 <sup>8</sup>
					PR-Code 1ZC	288	0986 473 384	
					0986 474 384		→	53,94
		188	PR-Code 1ZG	252	0986 473 071		←	54
					0986 474 071		→	54
	1.0 TFSI	03.15→	70	PR-Code 1KT, PR-Code 1KX, PR-Code 1KF	232			1987 470 040 <sup>7</sup>
1.2 TFSI	05.10-04.15	63	PR-Code 1KS			F 026 700 014	←	
						F 026 700 015	→	
1.4 TDI	11.14→	66	PR-Code 1KT, PR-Code 1KX, PR-Code 1KF	232	1987 470 040 <sup>7</sup>			
					110	PR-Code 1KT, PR-Code 1KX, PR-Code 1KF	232	1987 470 040 <sup>7</sup>

		S											
<b>1.4 TFSI</b>	05.10-04.15	90	PR-Code 1KS						F 026 <b>700 014</b>	←			
									F 026 <b>700 015</b>	→			
	01.11-04.15	136	PR-Code 1KS	232	PR-Code 1KT					F 026 <b>700 014</b>	←	1987 <b>470 040</b> <sup>7</sup>	
										F 026 <b>700 015</b>	→		
	02.13-04.15	103	PR-Code 1KS	232	PR-Code 1KT					F 026 <b>700 014</b>	←	1987 <b>470 040</b> <sup>7</sup>	
										F 026 <b>700 015</b>	→		
	11.14→	92	PR-Code 1KT, PR-Code 1KX, PR-Code 1KF	232								1987 <b>470 040</b> <sup>7</sup>	
	<b>1.6 TDI</b>	05.10-04.15	66/77	PR-Code 1KS						F 026 <b>700 014</b>	←		
										F 026 <b>700 015</b>	→		
	11.14→	85	PR-Code 1KT, PR-Code 1KX, PR-Code 1KF	232							1987 <b>470 040</b> <sup>7</sup>		
<b>1.8 TFSI</b>	02.15→	141	PR-Code 1KT, PR-Code 1KX, PR-Code 1KF	232							1987 <b>470 040</b> <sup>7</sup>		
<b>2.0 TDI</b> <b>2.0 TFSI quattro</b>	09.11-04.15	100/105/ 188	PR-Code 1KS						F 026 <b>700 014</b>	←			
									F 026 <b>700 015</b>	→			
			PR-Code 1KT	232							1987 <b>470 040</b> <sup>7</sup>		
	<b>1.2 TFSI</b>	05.10-04.15	63						1987 <b>482 267</b>	↔	1642		
	<b>1.4 TFSI</b>	05.10-04.15	90/103/136						1987 <b>482 267</b>	↔	1642		
	<b>1.6 TDI</b>	05.10-04.15	66/77						1987 <b>482 267</b>	↔	1642		
	<b>2.0 TDI</b>	09.11-04.15	100/105						1987 <b>482 267</b>	↔	1642		
	<b>1.0 TFSI</b>	03.15→	70	LAB, Y85					0 986 <b>594 504</b> <sup>4</sup>				
				RAB, Y85					0 986 <b>594 507</b> <sup>4</sup>				
	<b>1.4 TDI</b>	11.14→	66/92/110	LAB, Y85					0 986 <b>594 504</b> <sup>4</sup>				
				RAB, Y85					0 986 <b>594 507</b> <sup>4</sup>				
	<b>1.6 TDI</b>	11.14→	85	LAB, Y85					0 986 <b>594 504</b> <sup>4</sup>				
				RAB, Y85					0 986 <b>594 507</b> <sup>4</sup>				
<b>1.8 TFSI</b>	02.15→	141	LAB, Y85					0 986 <b>594 504</b> <sup>4</sup>					
			RAB, Y85					0 986 <b>594 507</b> <sup>4</sup>					
<b>A2 [8Z0]</b>													
	<b>1.2 TDI 3L</b>	03.01-08.05	45								1987 <b>470 506</b> <sup>8</sup>		
	<b>1.4</b>	09.99-08.05	55/66						0 986 <b>473 071</b>		← 54	1987 <b>470 506</b> <sup>8</sup>	
									0 986 <b>474 071</b>		→ 54	1987 <b>470 506</b> <sup>8</sup>	
	<b>1.6 FSI</b>	01.02-08.05	81							0 986 <b>473 071</b>		← 54	1987 <b>470 506</b> <sup>8</sup>
0 986 <b>474 071</b>											→ 54	1987 <b>470 506</b> <sup>8</sup>	
	<b>1.2 TDI 3L</b>	03.01-08.05	45						0 986 <b>475 260</b>	↔	17,46		
									0 986 <b>475 438</b>	↔	15,87		
	<b>1.4</b> <b>1.4 TDI</b>	09.99-08.05	55							0 986 <b>475 260</b>	↔	17,46	
										0 986 <b>475 438</b>	↔	15,87	
	<b>1.4 TDI</b>	11.03-08.05	66						0 986 <b>473 180</b>		← 34	1987 <b>470 040</b> <sup>7</sup>	
									0 986 <b>473 180</b>		← 34	1987 <b>474 496</b> <sup>8</sup>	
									0 986 <b>474 180</b>		→ 34	1987 <b>470 040</b> <sup>7</sup>	
	<b>1.6 FSI</b>	01.02-08.05	81							0 986 <b>473 180</b>		← 34	1987 <b>470 040</b> <sup>7</sup>
										0 986 <b>473 180</b>		← 34	1987 <b>474 496</b> <sup>8</sup>
									0 986 <b>474 180</b>		→ 34	1987 <b>470 040</b> <sup>7</sup>	





◀ AUDI A2 [8Z0]



	1.2 TDI 3L	03.01-09.01	45	Fg.-Nr. →8Z..2..010 000		1987 477 808	↔ 1075
		10.01-08.05	45	Fg.-Nr. 8Z..3..010 001→		1987 477 808	→ 1075
						1987 482 125	← 1057
1.4		09.99-09.01	55	Fg.-Nr. →8Z..2..010 000		1987 477 808	↔ 1075
		10.01-04.02	55	Fg.-Nr. 8Z..3..010 001→		1987 477 808	→ 1075
		11.01-08.05	55			1987 477 808	→ 1075
1.4		10.01-08.03	55	Fg.-Nr. 8Z..3..010 001→		1987 482 125	← 1057
1.4 TDI		11.01-08.05	55			1987 482 125	← 1057
1.4 TDI		09.99-09.01	55	Fg.-Nr. →8Z..2..010 000		1987 477 808	↔ 1075
		10.01-08.03	55	Fg.-Nr. 8Z..3..010 001→		1987 477 808	→ 1075
		05.03-08.05	55			1987 477 808	→ 1075
		11.03-08.05	66			1987 482 310	↔ 1152
1.6 FSI		01.02-08.05	81			1987 482 310	↔ 1152
	1.4	09.99-08.05	55/66		LAB	0986 594 500 <sup>3</sup>	
					RAB	0986 594 502 <sup>4</sup>	
						0986 594 501 <sup>3</sup>	
						0986 594 503 <sup>4</sup>	
1.6 FSI		01.02-08.05	81		LAB	0986 594 500 <sup>3</sup>	
					RAB	0986 594 502 <sup>4</sup>	
						0986 594 501 <sup>3</sup>	
						0986 594 503 <sup>4</sup>	

A3 Cabriolet



	1.6 TDI	05.15→	81		GBM,LAB	0986 594 526 <sup>4</sup>	
					GBM,RAB	0986 594 526 <sup>4</sup>	

A3 Cabriolet [8P7]



	1.2 TFSI	03.10-05.13	77				1987 470 506 <sup>8</sup>		
					PR-Code 1ZE	288	0986 473 384	☞ ← 53,94	F 026 A06 106 <sup>7</sup>
							0986 474 384	☞ → 53,94	F 026 A06 106 <sup>7</sup>
					PR-Code 1ZF	228	0986 473 071	☞ ← 54	F 026 A06 100 <sup>7</sup>
						0986 474 071	☞ → 54	F 026 A06 100 <sup>7</sup>	
1.4 TFSI		02.11-05.13	92				1987 470 506 <sup>8</sup>		
					PR-Code 1ZE	288	0986 473 384	☞ ← 53,94	F 026 A06 106 <sup>7</sup>
							0986 474 384	☞ → 53,94	F 026 A06 106 <sup>7</sup>
					PR-Code 1ZF	228	0986 473 071	☞ ← 54	F 026 A06 100 <sup>7</sup>
						0986 474 071	☞ → 54	F 026 A06 100 <sup>7</sup>	
1.6	1.6 TDI	09.08-05.13	75/77				1987 470 506 <sup>8</sup>		
					PR-Code 1ZE	288	0986 473 384	☞ ← 53,94	F 026 A06 106 <sup>7</sup>
							0986 474 384	☞ → 53,94	F 026 A06 106 <sup>7</sup>
					PR-Code 1ZF	228	0986 473 071	☞ ← 54	F 026 A06 100 <sup>7</sup>
						0986 474 071	☞ → 54	F 026 A06 100 <sup>7</sup>	
1.8 TFSI		04.08-05.13	118				1987 470 506 <sup>8</sup>		
					PR-Code 1ZE	288	0986 473 384	☞ ← 53,94	F 026 A06 106 <sup>7</sup>
							0986 474 384	☞ → 53,94	F 026 A06 106 <sup>7</sup>
					PR-Code 1ZF	228	0986 473 071	☞ ← 54	F 026 A06 100 <sup>7</sup>
						0986 474 071	☞ → 54	F 026 A06 100 <sup>7</sup>	
1.9 TDI		04.08-05.09	77				1987 470 506 <sup>8</sup>		
					PR-Code 1ZE	288	0986 473 384	☞ ← 53,94	F 026 A06 106 <sup>7</sup>
							0986 474 384	☞ → 53,94	F 026 A06 106 <sup>7</sup>
					PR-Code 1ZF	228	0986 473 071	☞ ← 54	F 026 A06 100 <sup>7</sup>
						0986 474 071	☞ → 54	F 026 A06 100 <sup>7</sup>	

	S							
<b>2.0 TDI</b>	04.08-05.13	100/103						1 987 470 506 <sup>8</sup>
			PR-Code 1ZE	288		0 986 473 384	53,94	F 026 A06 106 <sup>7</sup>
						0 986 474 384	53,94	F 026 A06 106 <sup>7</sup>
			PR-Code 1ZF	228		0 986 473 071	54	F 026 A06 100 <sup>7</sup>
						0 986 474 071	54	F 026 A06 100 <sup>7</sup>
<b>2.0 TFSI</b>	04.08-05.13	147						1 987 470 506 <sup>8</sup>
			PR-Code 1LJ, PR-Code 1ZA	312		0 986 473 384	53,94	F 026 A06 106 <sup>7</sup>
						0 986 474 384	53,94	F 026 A06 106 <sup>7</sup>
			PR-Code 1LK			0 986 134 257		F 026 A03 545 <sup>7</sup>
						0 986 135 257		F 026 A03 545 <sup>7</sup>
<b>1.2 TFSI</b>	03.10-05.13	77	PR-Code 1KD			0 986 473 381	38,1	1 987 470 040 <sup>7</sup>
						0 986 474 381	38,1	1 987 470 040 <sup>7</sup>
			PR-Code 1KZ			0 986 134 048	38	
						0 986 135 048	38	
<b>1.4 TFSI</b>	02.11-05.13	92	PR-Code 1KD			0 986 473 381	38,1	1 987 470 040 <sup>7</sup>
						0 986 474 381	38,1	1 987 470 040 <sup>7</sup>
			PR-Code 1KZ			0 986 134 048	38	
						0 986 135 048	38	
<b>1.6</b>	09.08-05.13	75/77	PR-Code 1KD			0 986 473 381	38,1	1 987 470 040 <sup>7</sup>
<b>1.6 TDI</b>						0 986 474 381	38,1	1 987 470 040 <sup>7</sup>
			PR-Code 1KZ			0 986 134 048	38	
						0 986 135 048	38	
<b>1.8 TFSI</b>	04.08-05.13	118	PR-Code 1KD			0 986 473 381	38,1	1 987 470 040 <sup>7</sup>
						0 986 474 381	38,1	1 987 470 040 <sup>7</sup>
			PR-Code 1KZ			0 986 134 048	38	
						0 986 135 048	38	
<b>1.9 TDI</b>	04.08-05.09	77	PR-Code 1KD			0 986 473 381	38,1	1 987 470 040 <sup>7</sup>
						0 986 474 381	38,1	1 987 470 040 <sup>7</sup>
			PR-Code 1KZ			0 986 134 048	38	
						0 986 135 048	38	
<b>2.0 TDI</b>	04.08-05.13	100/103	PR-Code 1KD			0 986 473 381	38,1	1 987 470 040 <sup>7</sup>
						0 986 474 381	38,1	1 987 470 040 <sup>7</sup>
			PR-Code 1KZ			0 986 134 048	38	
						0 986 135 048	38	
<b>2.0 TFSI</b>	04.08-05.13	147				0 986 134 048	38	1 987 470 040 <sup>7</sup>
						0 986 135 048	38	1 987 470 040 <sup>7</sup>
<b>1.2 TFSI</b>	03.10-05.13	77			LAB	0 986 594 504 <sup>3</sup>		
						0 986 594 506 <sup>4</sup>		
					RAB	0 986 594 505 <sup>3</sup>		
						0 986 594 507 <sup>4</sup>		
<b>1.4 TFSI</b>	02.11-05.13	92			LAB	0 986 594 504 <sup>3</sup>		
						0 986 594 506 <sup>4</sup>		
					RAB	0 986 594 505 <sup>3</sup>		
						0 986 594 507 <sup>4</sup>		
<b>1.6</b>	09.08-05.13	75/77			LAB	0 986 594 504 <sup>3</sup>		
<b>1.6 TDI</b>						0 986 594 506 <sup>4</sup>		
					RAB	0 986 594 505 <sup>3</sup>		
						0 986 594 507 <sup>4</sup>		
<b>1.8 TFSI</b>	04.08-05.13	118			LAB	0 986 594 504 <sup>3</sup>		
						0 986 594 506 <sup>4</sup>		
					RAB	0 986 594 505 <sup>3</sup>		
						0 986 594 507 <sup>4</sup>		
<b>1.9 TDI</b>	04.08-05.09	77			LAB	0 986 594 504 <sup>3</sup>		
						0 986 594 506 <sup>4</sup>		
					RAB	0 986 594 505 <sup>3</sup>		
						0 986 594 507 <sup>4</sup>		





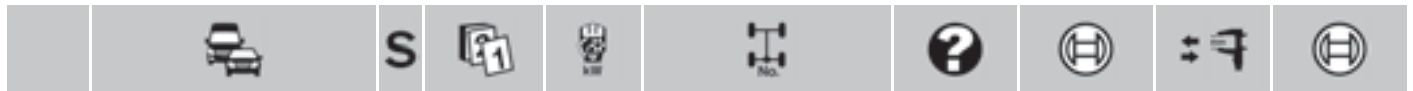

	◀ AUDI A3 Cabriolet [8P7]							
	2.0 TDI	04.08-05.13	100/103/		LAB	0986 594 504 <sup>3</sup>		
	2.0 TFSI		147		RAB	0986 594 506 <sup>4</sup>		
						0986 594 505 <sup>3</sup>		
						0986 594 507 <sup>4</sup>		

**A3 Cabriolet [8V7]**

	1.4 TFSI	10.13→	92/103/ 110		GBM,LAB	0986 594 526 <sup>4</sup>		
					GBM,RAB	0986 594 526 <sup>4</sup>		
	1.6 TDI	02.14-05.15	81		GBM,LAB	0986 594 526 <sup>4</sup>		
					GBM,RAB	0986 594 526 <sup>4</sup>		
	1.8 TFSI	10.13→	132		GBM,LAB	0986 594 526 <sup>4</sup>		
					GBM,RAB	0986 594 526 <sup>4</sup>		
		05.14→	125		GBM,LAB	0986 594 526 <sup>4</sup>		
					GBM,RAB	0986 594 526 <sup>4</sup>		
	1.8 TFSI quattro	03.14→	132		GBM,LAB	0986 594 524 <sup>4</sup>		
					GBM,RAB	0986 594 525 <sup>4</sup>		
					GBM,LAB	0986 594 504 <sup>4</sup>		
					GBM,RAB	0986 594 505 <sup>4</sup>		
	2.0 TDI	10.13→	100		GBM,LAB	0986 594 526 <sup>4</sup>		
					GBM,RAB	0986 594 526 <sup>4</sup>		
			110		GBM,LAB	0986 594 526 <sup>4</sup>		
					GBM,RAB	0986 594 526 <sup>4</sup>		
		03.14→	135		GBM,RAB	0986 594 526 <sup>4</sup>		
	2.0 TDI quattro	03.14→	110		GBM,LAB	0986 594 524 <sup>4</sup>		
					GBM,RAB	0986 594 525 <sup>4</sup>		
					GBM,LAB	0986 594 504 <sup>4</sup>		
					GBM,RAB	0986 594 505 <sup>4</sup>		
			135		GBM,LAB	0986 594 524 <sup>4</sup>		
					GBM,RAB	0986 594 525 <sup>4</sup>		
					GBM,LAB	0986 594 504 <sup>4</sup>		
					GBM,RAB	0986 594 505 <sup>4</sup>		
	2.0 TFSI quattro	05.14→	162		GBM,LAB	0986 594 524 <sup>4</sup>		
					GBM,RAB	0986 594 525 <sup>4</sup>		
					GBM,LAB	0986 594 504 <sup>4</sup>		
					GBM,RAB	0986 594 505 <sup>4</sup>		

**A3 Limousine [8VS]**

	1.2 TFSI	10.13→	77/81	PR-Code 1KE				1987 470 506 <sup>8</sup>
	1.4 TFSI	09.13→	90/92/103/ 110	PR-Code 1KE				1987 470 506 <sup>8</sup>
	1.6 TDI	09.13-05.15	77/81	PR-Code 1KE				1987 470 506 <sup>8</sup>
	1.8 FSI, TFSI, TFSI quattro	05.13→	125/132	PR-Code 1KE				1987 470 506 <sup>8</sup>
	2.0 TDI	05.13→	81/100/	PR-Code 1KE				1987 470 506 <sup>8</sup>
	2.0 TDI quattro		105/110/135					
	1.2 TFSI	10.13→	77/81		GBM,LAB	0986 594 526 <sup>4</sup>		
					GBM,RAB	0986 594 526 <sup>4</sup>		
	1.4 TFSI	09.13→	90/92/103/ 110		GBM,LAB	0986 594 526 <sup>4</sup>		
					GBM,RAB	0986 594 526 <sup>4</sup>		
	1.6 TDI	09.13→	77/81		GBM,LAB	0986 594 526 <sup>4</sup>		
					GBM,RAB	0986 594 526 <sup>4</sup>		
	1.8 FSI	05.13→	132		GBM,LAB	0986 594 526 <sup>4</sup>		
	1.8 TFSI				GBM,RAB	0986 594 526 <sup>4</sup>		
	1.8 TFSI	11.13→	125		GBM,LAB	0986 594 526 <sup>4</sup>		
					GBM,RAB	0986 594 526 <sup>4</sup>		

		<b>S</b>							
<b>1.8 TFSI quattro</b>	11.13→	132					GBM,LAB	0 986 594 524 <sup>4</sup>	
							GBM,RAB	0 986 594 525 <sup>4</sup>	
							GBM,LAB	0 986 594 504 <sup>4</sup>	
							GBM,RAB	0 986 594 505 <sup>4</sup>	
<b>2.0 TDI</b>	05.13→	81/100/ 105					GBM,LAB	0 986 594 526 <sup>4</sup>	
		110/135					GBM,RAB	0 986 594 526 <sup>4</sup>	
							GBM,LAB	0 986 594 526 <sup>4</sup>	
							GBM,RAB	0 986 594 526 <sup>4</sup>	
<b>2.0 TDI quattro</b>	10.13→	110/135					GBM,LAB	0 986 594 524 <sup>4</sup>	
							GBM,RAB	0 986 594 525 <sup>4</sup>	
							GBM,LAB	0 986 594 504 <sup>4</sup>	
							GBM,RAB	0 986 594 505 <sup>4</sup>	
<b>2.0 TFSI quattro</b>	10.13-05.14	206					GBM,LAB	0 986 594 524 <sup>4</sup>	
							GBM,RAB	0 986 594 525 <sup>4</sup>	
							GBM,LAB	0 986 594 504 <sup>4</sup>	
							GBM,RAB	0 986 594 505 <sup>4</sup>	































































**A3 Sportback [8PA]**

	<b>1.2 TFSI</b>	11.09-08.12	77						1 987 470 506 <sup>8</sup>
				PR-Code 1ZE	288		0 986 473 384	← 53,94	F 026 A06 106 <sup>7</sup>
							0 986 474 384	→ 53,94	F 026 A06 106 <sup>7</sup>
				PR-Code 1ZF	228		0 986 473 071	← 54	F 026 A06 100 <sup>7</sup>
							0 986 474 071	→ 54	F 026 A06 100 <sup>7</sup>
	<b>1.4 TFSI</b>	06.07-03.13	92						1 987 470 506 <sup>8</sup>
				PR-Code 1ZE	288		0 986 473 384	← 53,94	F 026 A06 106 <sup>7</sup>
							0 986 474 384	→ 53,94	F 026 A06 106 <sup>7</sup>
				PR-Code 1ZF	228		0 986 473 071	← 54	F 026 A06 100 <sup>7</sup>
							0 986 474 071	→ 54	F 026 A06 100 <sup>7</sup>
	<b>1.6</b>	09.04-05.05	75			228	0 986 473 071	← 54	1 987 470 506 <sup>8</sup>
							0 986 474 071	→ 54	1 987 470 506 <sup>8</sup>
						288	0 986 473 384	← 53,94	F 026 A06 100 <sup>7</sup>
							0 986 473 384	← 53,94	1 987 470 506 <sup>8</sup>
							0 986 474 384	→ 53,94	F 026 A06 100 <sup>7</sup>
		06.05-03.13	75						1 987 470 506 <sup>8</sup>
				PR-Code 1ZE	288		0 986 473 384	← 53,94	F 026 A06 106 <sup>7</sup>
							0 986 474 384	→ 53,94	F 026 A06 106 <sup>7</sup>
				PR-Code 1ZF	228		0 986 473 071	← 54	F 026 A06 100 <sup>7</sup>
							0 986 474 071	→ 54	F 026 A06 100 <sup>7</sup>
	<b>1.6 FSI</b>	09.04-09.07	85			228	0 986 473 071	← 54	1 987 470 506 <sup>8</sup>
							0 986 474 071	→ 54	1 987 470 506 <sup>8</sup>
						288	0 986 473 384	← 53,94	F 026 A06 100 <sup>7</sup>
							0 986 473 384	← 53,94	1 987 470 506 <sup>8</sup>
							0 986 474 384	→ 53,94	F 026 A06 100 <sup>7</sup>
	<b>1.6 TDI</b>	05.09-03.13	66						1 987 470 506 <sup>8</sup>
				PR-Code 1ZE	288		0 986 473 384	← 53,94	F 026 A06 106 <sup>7</sup>
							0 986 474 384	→ 53,94	F 026 A06 106 <sup>7</sup>
				PR-Code 1ZF	228		0 986 473 071	← 54	F 026 A06 100 <sup>7</sup>
							0 986 474 071	→ 54	F 026 A06 100 <sup>7</sup>
		11.09-03.13	77						1 987 470 506 <sup>8</sup>
				PR-Code 1ZE	288		0 986 473 384	← 53,94	F 026 A06 106 <sup>7</sup>
							0 986 474 384	→ 53,94	F 026 A06 106 <sup>7</sup>
				PR-Code 1ZF	228		0 986 473 071	← 54	F 026 A06 100 <sup>7</sup>
							0 986 474 071	→ 54	F 026 A06 100 <sup>7</sup>
	<b>1.8 TFSI</b>	11.06-06.08	118			288,312	0 986 473 384	← 53,94	F 026 A06 100 <sup>7</sup>
							0 986 473 384	← 53,94	1 987 470 506 <sup>8</sup>
							0 986 474 384	→ 53,94	F 026 A06 100 <sup>7</sup>
		07.08-08.12	118	PR-Code 1LJ, PR-Code 1ZE, PR-Code 1ZA, PR-Code 1ZD	288,312		0 986 473 384	← 53,94	F 026 A06 106 <sup>7</sup>
							0 986 473 384	← 53,94	1 987 470 506 <sup>8</sup>
							0 986 474 384	→ 53,94	F 026 A06 106 <sup>7</sup>



			S								
◀ AUDI A3 Sportback [8PA]											
1.8 TFSI quattro	07.08-03.13	118	PR-Code 1LJ, PR-Code 1ZE, PR-Code 1ZA, PR-Code 1ZD	288,312	0986 473 384		53,94	F 026 A06 106 <sup>7</sup>			
					0986 473 384		53,94	1 987 470 506 <sup>8</sup>			
					0986 474 384		53,94	F 026 A06 106 <sup>7</sup>			
1.9 TDI	09.04-05.06	77		228	0986 473 071		54	1 987 470 506 <sup>8</sup>			
					0986 474 071		54	1 987 470 506 <sup>8</sup>			
					0986 473 384		53,94	F 026 A06 100 <sup>7</sup>			
	11.05-05.10	77			288	0986 473 384		53,94	F 026 A06 106 <sup>7</sup>		
						0986 474 384		53,94	F 026 A06 106 <sup>7</sup>		
						0986 473 071		54	F 026 A06 100 <sup>7</sup>		
			PR-Code 1ZE	288	0986 473 384		53,94	F 026 A06 106 <sup>7</sup>			
			PR-Code 1ZF	228	0986 473 071		54	F 026 A06 100 <sup>7</sup>			
					0986 474 071		54	F 026 A06 100 <sup>7</sup>			
2.0 FSI	09.04-06.08	110/120		288,312	0986 473 384		53,94	F 026 A06 100 <sup>7</sup>			
2.0 TDI					0986 473 384		53,94	1 987 470 506 <sup>8</sup>			
					0986 474 384		53,94	F 026 A06 100 <sup>7</sup>			
2.0 TDI	09.04-06.08	100		288,312	0986 473 384		53,94	F 026 A06 100 <sup>7</sup>			
					0986 473 384		53,94	1 987 470 506 <sup>8</sup>			
					0986 474 384		53,94	F 026 A06 100 <sup>7</sup>			
	07.08-03.13	100			288	0986 473 384		53,94	F 026 A06 106 <sup>7</sup>		
						0986 474 384		53,94	F 026 A06 106 <sup>7</sup>		
						0986 473 071		54	F 026 A06 100 <sup>7</sup>		
			PR-Code 1ZF	228	0986 474 071		54	F 026 A06 100 <sup>7</sup>			
2.0 TDI quattro	11.09-03.13	103						1 987 470 506 <sup>8</sup>			
		125						1 987 470 506 <sup>8</sup>			
2.0 TDI 2.0 TDI quattro	09.04-06.08	103		288,312	0986 473 384		53,94	F 026 A06 100 <sup>7</sup>			
					0986 473 384		53,94	1 987 470 506 <sup>8</sup>			
					0986 474 384		53,94	F 026 A06 100 <sup>7</sup>			
	03.06-06.08	125			288,312	0986 473 384		53,94	F 026 A06 100 <sup>7</sup>		
						0986 473 384		53,94	1 987 470 506 <sup>8</sup>		
						0986 474 384		53,94	F 026 A06 100 <sup>7</sup>		
	07.08-05.10	103			288,312	0986 473 384		53,94	F 026 A06 106 <sup>7</sup>		
						0986 473 384		53,94	1 987 470 506 <sup>8</sup>		
						0986 474 384		53,94	F 026 A06 106 <sup>7</sup>		
			125			0986 473 384		53,94	F 026 A06 106 <sup>7</sup>		
						0986 473 384		53,94	1 987 470 506 <sup>8</sup>		
						0986 474 384		53,94	F 026 A06 106 <sup>7</sup>		
		11.09-03.13	103	PR-Code 1LJ, PR-Code 1ZE, PR-Code 1ZA, PR-Code 1ZD	288,312	0986 473 384		53,94	F 026 A06 106 <sup>7</sup>		
						0986 473 384		53,94	1 987 470 506 <sup>8</sup>		
						0986 474 384		53,94	F 026 A06 106 <sup>7</sup>		
		125	PR-Code 1LJ, PR-Code 1ZE, PR-Code 1ZA, PR-Code 1ZD	288,312	0986 473 384		53,94	F 026 A06 106 <sup>7</sup>			
					0986 473 384		53,94	1 987 470 506 <sup>8</sup>			
					0986 474 384		53,94	F 026 A06 106 <sup>7</sup>			
2.0 TFSI	09.07-08.13	147			0986 473 384		53,94	F 026 A06 106 <sup>7</sup>			
					0986 474 384		53,94	F 026 A06 106 <sup>7</sup>			
		07.08-03.13	147	PR-Code 1LJ, PR-Code 1ZE, PR-Code 1ZA, PR-Code 1ZD	288,312	0986 473 384		53,94	F 026 A06 106 <sup>7</sup>		
					0986 474 384		53,94	F 026 A06 106 <sup>7</sup>			
2.0 TFSI quattro	07.08-03.13	147	PR-Code 1LJ, PR-Code 1ZE, PR-Code 1ZA, PR-Code 1ZD	288,312	0986 473 384		53,94	F 026 A06 106 <sup>7</sup>			
					0986 474 384		53,94	F 026 A06 106 <sup>7</sup>			
2.0 TFSI 2.0 TFSI quattro	09.04-05.09	147			0986 473 384		53,94	F 026 A06 100 <sup>7</sup>			
					0986 474 384		53,94	F 026 A06 100 <sup>7</sup>			
	09.04-08.13	147				0986 473 384		53,94	1 987 470 506 <sup>8</sup>		
		09.07-08.13	147								
			PR-Code 1LK		0986 134 257			F 026 A03 545 <sup>7</sup>			
					0986 135 257			F 026 A03 545 <sup>7</sup>			
	07.08-03.13	147	PR-Code 1LJ, PR-Code 1ZE, PR-Code 1ZA, PR-Code 1ZD	288,312	0986 473 384		53,94	1 987 470 506 <sup>8</sup>			
3.2 quattro	09.04-10.05	184		312	0986 135 257			1 987 470 506 <sup>8</sup>			
					0986 473 384		53,94	F 026 A06 100 <sup>7</sup>			
					0986 473 384		53,94	1 987 470 506 <sup>8</sup>			
					0986 474 384		53,94	F 026 A06 100 <sup>7</sup>			



									
3.2 quattro		09.04-05.09	184				0 986 134 257	 ←	F 026 A03 545 <sup>7</sup>
							0 986 134 257	 ←	1 987 470 506 <sup>8</sup>
		11.05-05.09	184				0 986 135 257	 →	F 026 A03 545 <sup>7</sup>
									
 1.2 TFSI		11.09-08.12	77	PR-Code 1KD			0 986 473 381	 ← 38,1	
							0 986 474 381	 → 38,1	
				PR-Code 1KD, PR-Code 1KZ					1 987 470 040 <sup>7</sup>
				PR-Code 1KZ			0 986 134 048	 ← 38	
							0 986 135 048	 → 38	
1.4 TFSI		06.07-03.13	92	PR-Code 1KD			0 986 473 381	 ← 38,1	
							0 986 474 381	 → 38,1	
				PR-Code 1KD, PR-Code 1KZ					1 987 470 040 <sup>7</sup>
				PR-Code 1KZ			0 986 134 048	 ← 38	
							0 986 135 048	 → 38	
1.6		09.04-05.05	75	PR-Code 1KE			0 986 473 448	 ← 41	
							0 986 474 448	 → 41	
				PR-Code 1KQ, PR-Code 1KD			0 986 473 381	 ← 38,1	1 987 470 040 <sup>7</sup>
							0 986 474 381	 → 38,1	1 987 470 040 <sup>7</sup>
		06.05-03.13	75	PR-Code 1KD			0 986 473 381	 ← 38,1	
							0 986 474 381	 → 38,1	
				PR-Code 1KD, PR-Code 1KZ					1 987 470 040 <sup>7</sup>
				PR-Code 1KZ			0 986 134 048	 ← 38	
							0 986 135 048	 → 38	
1.6 FSI		09.04-09.07	85	PR-Code 1KE			0 986 473 448	 ← 41	
							0 986 474 448	 → 41	
				PR-Code 1KQ, PR-Code 1KD			0 986 473 381	 ← 38,1	1 987 470 040 <sup>7</sup>
							0 986 474 381	 → 38,1	1 987 470 040 <sup>7</sup>
1.6 TDI		05.09-03.13	66	PR-Code 1KD			0 986 473 381	 ← 38,1	
							0 986 474 381	 → 38,1	
				PR-Code 1KD, PR-Code 1KZ					1 987 470 040 <sup>7</sup>
				PR-Code 1KZ			0 986 134 048	 ← 38	
							0 986 135 048	 → 38	
		11.09-03.13	77	PR-Code 1KD			0 986 473 381	 ← 38,1	
							0 986 474 381	 → 38,1	
				PR-Code 1KD, PR-Code 1KZ					1 987 470 040 <sup>7</sup>
				PR-Code 1KZ			0 986 134 048	 ← 38	
							0 986 135 048	 → 38	
1.8 TFSI		11.06-06.07	118	PR-Code 1KQ, PR-Code 1KD			0 986 473 381	 ← 38,1	1 987 470 040 <sup>7</sup>
							0 986 474 381	 → 38,1	1 987 470 040 <sup>7</sup>
		11.06-06.08	118	PR-Code 1KZ			0 986 134 048	 ← 38	1 987 470 040 <sup>7</sup>
							0 986 135 048	 → 38	1 987 470 040 <sup>7</sup>
		06.07-06.08	118	PR-Code 1KD			0 986 473 381	 ← 38,1	1 987 470 040 <sup>7</sup>
							0 986 474 381	 → 38,1	1 987 470 040 <sup>7</sup>
		07.08-08.12	118	PR-Code 1KD			0 986 473 381	 ← 38,1	
							0 986 474 381	 → 38,1	
				PR-Code 1KD, PR-Code 1KZ					1 987 470 040 <sup>7</sup>
				PR-Code 1KZ			0 986 134 048	 ← 38	
							0 986 135 048	 → 38	
1.8 TFSI quattro		07.08-03.13	118	PR-Code 1KJ			0 986 473 448	 ← 41	
							0 986 474 448	 → 41	
1.9 TDI		09.04-05.06	77	PR-Code 1KE			0 986 473 448	 ← 41	
							0 986 474 448	 → 41	
				PR-Code 1KQ, PR-Code 1KD			0 986 473 381	 ← 38,1	1 987 470 040 <sup>7</sup>
							0 986 474 381	 → 38,1	1 987 470 040 <sup>7</sup>
		11.05-05.10	77	PR-Code 1KD			0 986 473 381	 ← 38,1	1 987 470 040 <sup>7</sup>
							0 986 474 381	 → 38,1	1 987 470 040 <sup>7</sup>
				PR-Code 1KZ			0 986 134 048	 ← 38	
							0 986 135 048	 → 38	



			S								
<b>◀ AUDI A3 Sportback [8PA]</b>											
<b>2.0 FSI</b>	09.04-10.05	110	PR-Code 1KE	0986 473 448		←	41				
				0986 474 448		→	41				
	09.04-11.06	110	PR-Code 1KQ, PR-Code 1KD	0986 473 381		←	38,1	1987 470 040 <sup>7</sup>			
				0986 474 381		→	38,1	1987 470 040 <sup>7</sup>			
				PR-Code 1KZ	0986 134 048		←	38	1987 470 040 <sup>7</sup>		
					0986 135 048		→	38	1987 470 040 <sup>7</sup>		
	11.05-06.08	110		0986 134 048		←	38	1987 470 040 <sup>7</sup>			
				0986 135 048		→	38	1987 470 040 <sup>7</sup>			
	<b>2.0 TDI</b>	09.04-06.08	100	PR-Code 1KE	0986 473 448		←	41			
					0986 474 448		→	41			
PR-Code 1KQ, PR-Code 1KD					0986 473 381		←	38,1	1987 470 040 <sup>7</sup>		
					0986 474 381		→	38,1	1987 470 040 <sup>7</sup>		
103			PR-Code 1KE	0986 473 448		←	41				
				0986 474 448		→	41				
				PR-Code 1KQ, PR-Code 1KD	0986 473 381		←	38,1	1987 470 040 <sup>7</sup>		
					0986 474 381		→	38,1	1987 470 040 <sup>7</sup>		
09.04-03.13		103	PR-Code 1KD	0986 473 381		←	38,1				
				0986 474 381		→	38,1				
				PR-Code 1KD, PR-Code 1KZ					1987 470 040 <sup>7</sup>		
					0986 134 048		←	38			
03.06-06.08		125		0986 135 048		→	38				
				0986 134 048		←	38	1987 470 040 <sup>7</sup>			
06.06-06.08		120		0986 134 048		←	38	1987 470 040 <sup>7</sup>			
				0986 135 048		→	38	1987 470 040 <sup>7</sup>			
07.08-05.10		100	PR-Code 1KD	0986 473 381		←	38,1	1987 470 040 <sup>7</sup>			
				0986 474 381		→	38,1	1987 470 040 <sup>7</sup>			
				125	PR-Code 1KD	0986 473 381		←	38,1	1987 470 040 <sup>7</sup>	
						0986 474 381		→	38,1	1987 470 040 <sup>7</sup>	
07.08-03.13	100	PR-Code 1KZ	0986 134 048		←	38					
			0986 135 048		→	38					
			125	PR-Code 1KZ	0986 134 048		←	38			
					0986 135 048		→	38			
11.09-03.13	100	PR-Code 1KD	0986 473 381		←	38,1					
			0986 474 381		→	38,1					
			PR-Code 1KD, PR-Code 1KZ					1987 470 040 <sup>7</sup>			
				125	PR-Code 1KD	0986 473 381		←	38,1		
	0986 474 381		→	38,1							
	PR-Code 1KD, PR-Code 1KZ					1987 470 040 <sup>7</sup>					
<b>2.0 TDI quattro</b>		09.04-06.08	103	0986 473 448		←	41				
	0986 474 448				→	41					
	03.06-06.08			125		0986 473 448		←	41		
						0986 474 448		→	41		
07.08-03.13	103	PR-Code 1KJ	0986 473 448		←	41					
			0986 474 448		→	41					
			125	PR-Code 1KJ	0986 473 448		←	41			
					0986 474 448		→	41			
<b>2.0 TFSI</b>	09.04-10.05	147	PR-Code 1KE	0986 473 448		←	41				
				0986 474 448		→	41				
				PR-Code 1KZ	0986 134 048		←	38	1987 470 040 <sup>7</sup>		
					0986 135 048		→	38	1987 470 040 <sup>7</sup>		
	04.05-05.09	147		0986 134 048		←	38	1987 470 040 <sup>7</sup>			
				0986 135 048		→	38	1987 470 040 <sup>7</sup>			
	09.07-08.13	147	PR-Code 1KD	0986 473 381		←	38,1	1987 470 040 <sup>7</sup>			
				0986 474 381		→	38,1	1987 470 040 <sup>7</sup>			
				PR-Code 1KZ	0986 134 048		←	38			
					0986 135 048		→	38			
07.08-03.13	147	PR-Code 1KJ	0986 473 448		←	41					
			0986 474 448		→	41					
<b>2.0 TFSI quattro</b>	09.04-10.05	147	PR-Code 1KU, PR-Code 1KJ, PR-Code 1KF	0986 473 448		←	41				
				0986 474 448		→	41				
				11.05-05.09	147		0986 473 448		←	41	
							0986 474 448		→	41	



		S							
2.0 TFSI quattro	07.08-03.13	147		PR-Code 1KJ			0 986 473 448		41
							0 986 474 448		41
3.2 quattro	09.04-10.05	184					0 986 134 297		1 987 474 496 <sup>B</sup>
	11.05-05.09	184		PR-Code 2EA	FBJ		0 986 134 297		1 987 474 496 <sup>B</sup>
							0 986 135 297		
							0 986 135 297		
	1.2 TFSI	11.09-08.12	77	PR-Code 1SA, PR-Code 1SB	SSZ		1 987 482 445		1447
				PR-Code 1SK	SSZ		1 987 477 958		1447
	1.4 TFSI	06.07-03.13	92	PR-Code 1SA, PR-Code 1SB	SSZ		1 987 482 445		1447
				PR-Code 1SK	SSZ		1 987 477 958		1447
	1.6	09.04-03.13	66/75/77/85	PR-Code 1SA, PR-Code 1SB	SSZ		1 987 482 445		1447
				PR-Code 1SK	SSZ		1 987 477 958		1447
	1.6 FSI	09.04-09.07	66/75/77/85	PR-Code 1SA, PR-Code 1SB	SSZ		1 987 482 445		1447
				PR-Code 1SK	SSZ		1 987 477 958		1447
	1.6 TDI	05.09-03.13	66/75/77/85	PR-Code 1SA, PR-Code 1SB	SSZ		1 987 482 445		1447
				PR-Code 1SK	SSZ		1 987 477 958		1447
	1.8 TFSI	11.06-08.12	118	PR-Code 1SA, PR-Code 1SB	SSZ		1 987 482 445		1447
				PR-Code 1SK	SSZ		1 987 477 958		1447
	1.8 TFSI quattro	07.08-03.13	118				1 987 477 958		1447
	1.9 TDI	09.04-05.10	77	PR-Code 1SA, PR-Code 1SB	SSZ		1 987 482 445		1447
				PR-Code 1SK	SSZ		1 987 477 958		1447
	2.0 FSI	09.04-06.08	110/120	PR-Code 1SA, PR-Code 1SB	SSZ		1 987 482 445		1447
				PR-Code 1SK	SSZ		1 987 477 958		1447
	2.0 TDI	09.04-03.13	100	PR-Code 1SA, PR-Code 1SB	SSZ		1 987 482 445		1447
				PR-Code 1SK	SSZ		1 987 477 958		1447
		09.04-08.13	103	PR-Code 1SA, PR-Code 1SB	SSZ		1 987 482 445		1447
				PR-Code 1SK	SSZ		1 987 477 958		1447
		03.06-03.13	125	PR-Code 1SA, PR-Code 1SB	SSZ		1 987 482 445		1447
				PR-Code 1SK	SSZ		1 987 477 958		1447
		06.06-06.08	110/120	PR-Code 1SA, PR-Code 1SB	SSZ		1 987 482 445		1447
				PR-Code 1SK	SSZ		1 987 477 958		1447
	2.0 TDI quattro	09.04-01.06	103	Fg.-Nr. →8P..6A140 000, →8P..6B012 000			1 987 482 445		1447
		02.06-06.08	103	Fg.-Nr. 8P..6A140 001→, 8P..6B012 001→			1 987 477 958		1447
		03.06-03.13	125				1 987 477 958		1447
		07.08-03.13	103				1 987 477 958		1447
	2.0 TFSI	09.04-08.13	147	PR-Code 1SA, PR-Code 1SB	SSZ		1 987 482 445		1447
				PR-Code 1SK	SSZ		1 987 477 958		1447
	2.0 TFSI quattro	09.04-10.05	147				1 987 482 445		1447
		11.05-01.06	147	Fg.-Nr. →8P..6A140 000, →8P..6B012 000			1 987 482 445		1447
		02.06-05.09	147	Fg.-Nr. 8P..6A140 001→, 8P..6B012 001→			1 987 477 958		1447
		07.08-03.13	147				1 987 477 958		1447
	3.2 quattro	09.04-10.05	184				1 987 482 445		1447
		11.05-01.06	184	Fg.-Nr. →8P..6A140 000, →8P..6B012 000			1 987 482 445		1447
		02.06-05.09	184	Fg.-Nr. 8P..6A140 001→, 8P..6B012 001→			1 987 477 958		1447
	1.2 TFSI	11.09-08.12	77		LAB		0 986 594 504 <sup>3</sup>		
					RAB		0 986 594 506 <sup>4</sup>		
							0 986 594 505 <sup>3</sup>		
							0 986 594 507 <sup>4</sup>		
	1.4 TFSI	06.07-03.13	92		LAB		0 986 594 504 <sup>3</sup>		
					RAB		0 986 594 506 <sup>4</sup>		
							0 986 594 505 <sup>3</sup>		
							0 986 594 507 <sup>4</sup>		





AUDI A3 Sportback [8PA]									
1.6	09.04-03.13	66/75/77/	85	LAB	0986 594 504 <sup>3</sup>				
					0986 594 506 <sup>4</sup>				
1.6 FSI									
1.6 TDI				RAB	0986 594 505 <sup>3</sup>				
					0986 594 507 <sup>4</sup>				
1.8 TFSI	11.06-08.12	118		LAB	0986 594 504 <sup>3</sup>				
					0986 594 506 <sup>4</sup>				
1.8 TFSI quattro	07.08-03.13	118		LAB	0986 594 504 <sup>3</sup>				
					0986 594 504 <sup>4</sup>				
1.8 TFSI quattro	07.08-03.13	118		RAB	0986 594 505 <sup>3</sup>				
					0986 594 505 <sup>4</sup>				
1.9 TDI	09.04-05.10	77		LAB	0986 594 504 <sup>3</sup>				
					0986 594 506 <sup>4</sup>				
2.0 FSI	09.04-06.08	110/120		LAB	0986 594 504 <sup>3</sup>				
					0986 594 506 <sup>4</sup>				
2.0 TDI	09.04-03.13	100		RAB	0986 594 505 <sup>3</sup>				
					0986 594 507 <sup>4</sup>				
2.0 TDI	09.04-03.13	100		LAB	0986 594 504 <sup>3</sup>				
					0986 594 506 <sup>4</sup>				
2.0 TDI	09.04-03.13	103		RAB	0986 594 505 <sup>3</sup>				
					0986 594 507 <sup>4</sup>				
2.0 TDI	09.04-08.13	103		LAB	0986 594 504 <sup>3</sup>				
					0986 594 506 <sup>4</sup>				
2.0 TDI quattro	09.04-03.13	103		LAB	0986 594 504 <sup>3</sup>				
					0986 594 504 <sup>4</sup>				
2.0 TDI quattro	09.04-03.13	103		RAB	0986 594 505 <sup>3</sup>				
					0986 594 505 <sup>4</sup>				
2.0 TDI quattro	03.06-03.13	125/147		LAB	0986 594 504 <sup>3</sup>				
					0986 594 504 <sup>4</sup>				
2.0 TDI quattro	09.04-03.13	103		RAB	0986 594 505 <sup>3</sup>				
					0986 594 505 <sup>4</sup>				
2.0 TDI quattro	03.06-03.13	125/147		LAB	0986 594 504 <sup>3</sup>				
					0986 594 504 <sup>4</sup>				
2.0 TDI	09.04-08.13	125/147		LAB	0986 594 506 <sup>4</sup>				
					0986 594 507 <sup>4</sup>				
2.0 TFSI	09.04-08.13	125/147		RAB	0986 594 507 <sup>4</sup>				
					0986 594 504 <sup>3</sup>				
2.0 TFSI	09.04-08.13	125/147		LAB	0986 594 504 <sup>3</sup>				
					0986 594 505 <sup>3</sup>				
2.0 TFSI quattro	09.04-03.13	125/147		LAB	0986 594 504 <sup>3</sup>				
					0986 594 504 <sup>4</sup>				
2.0 TFSI quattro	09.04-03.13	125/147		RAB	0986 594 505 <sup>3</sup>				
					0986 594 505 <sup>4</sup>				
3.2 quattro	09.04-05.09	184		LAB	0986 594 504 <sup>3</sup>				
					0986 594 504 <sup>4</sup>				
3.2 quattro	09.04-05.09	184		RAB	0986 594 505 <sup>3</sup>				
					0986 594 505 <sup>4</sup>				

**A3 Sportback [8VA]**









	1.2 TFSI	05.13→	77/81	PR-Code 1KE					1987 470 506 <sup>8</sup>
	1.4 TFSI, TFSI e-tron, TFSI g-tron	02.13→	81/90/92/103/110	PR-Code 1KE					1987 470 506 <sup>8</sup>
	1.6 TDI	01.13-05.15	77/81	PR-Code 1KE					1987 470 506 <sup>8</sup>
	1.8 FSI quattro, TFSI	09.12→	132	PR-Code 1KE					1987 470 506 <sup>8</sup>
	2.0 TDI	09.12→	81/100/105/110/135	PR-Code 1KE					1987 470 506 <sup>8</sup>
	2.0 TDI quattro								

		S								
	1.2 TFSI	05.13→	77/81			GBM,LAB	0 986 594 526 <sup>4</sup>			
						GBM,RAB	0 986 594 526 <sup>4</sup>			
	1.4 TFSI, TFSI e-tron, TFSI g-tron	09.12→	81/90/92/ 103/110			GBM,LAB	0 986 594 526 <sup>4</sup>			
						GBM,RAB	0 986 594 526 <sup>4</sup>			
	1.6 TDI	01.13→	77/81			GBM,LAB	0 986 594 526 <sup>4</sup>			
						GBM,RAB	0 986 594 526 <sup>4</sup>			
	1.8 FSI quattro	05.13→	132			GBM,LAB	0 986 594 524 <sup>4</sup>			
						GBM,RAB	0 986 594 525 <sup>4</sup>			
						GBM,LAB	0 986 594 504 <sup>4</sup>			
						GBM,RAB	0 986 594 505 <sup>4</sup>			
	1.8 TFSI	09.12→	132			GBM,LAB	0 986 594 526 <sup>4</sup>			
						GBM,RAB	0 986 594 526 <sup>4</sup>			
	2.0 TDI	09.12→	110			GBM,LAB	0 986 594 526 <sup>4</sup>			
						GBM,RAB	0 986 594 526 <sup>4</sup>			
			03.13→	81/100/ 105			GBM,LAB	0 986 594 526 <sup>4</sup>		
							GBM,RAB	0 986 594 526 <sup>4</sup>		
		05.13→	135			GBM,LAB	0 986 594 526 <sup>4</sup>			
						GBM,RAB	0 986 594 526 <sup>4</sup>			
2.0 TDI quattro	05.13→	135				GBM,LAB	0 986 594 524 <sup>4</sup>			
						GBM,RAB	0 986 594 525 <sup>4</sup>			
						GBM,LAB	0 986 594 504 <sup>4</sup>			
						GBM,RAB	0 986 594 505 <sup>4</sup>			
2.0 TDI	02.13→	110				GBM,LAB	0 986 594 524 <sup>4</sup>			
2.0 TDI quattro						GBM,RAB	0 986 594 525 <sup>4</sup>			
						GBM,LAB	0 986 594 504 <sup>4</sup>			
						GBM,RAB	0 986 594 505 <sup>4</sup>			
<b>A3 Sportsback [8VA]</b>										
	1.4 TFSI	05.14→	110	PR-Code 1KE					1 987 470 506 <sup>B</sup>	
	1.4 TFSI	05.14→	110			GBM,LAB	0 986 594 526 <sup>4</sup>			
						GBM,RAB	0 986 594 526 <sup>4</sup>			
<b>A3 [8L1]</b>										
	1.6	09.96-06.01	74	PR-Code 1LE	288		0 986 471 923	← 54	1 987 470 506 <sup>B</sup>	
							0 986 473 923			
							0 986 471 924	→ 54	1 987 470 506 <sup>B</sup>	
							0 986 473 924			
				PR-Code 1LQ, PR-Code 1LS, PR-Code 1ZP	228,252		0 986 473 071	← 54	1 987 470 506 <sup>B</sup>	
							0 986 474 071	→ 54	1 987 470 506 <sup>B</sup>	
				PR-Code 1LT	312		0 986 473 923	← 54	1 987 470 506 <sup>B</sup>	
							0 986 473 924	→ 54	1 987 470 506 <sup>B</sup>	
		05.99-09.06	74				0 986 473 071	← 54	1 987 470 506 <sup>B</sup>	
							0 986 474 071	→ 54	1 987 470 506 <sup>B</sup>	
		05.00-06.03	75	PR-Code 1LE	288		0 986 471 923	← 54	1 987 470 506 <sup>B</sup>	
							0 986 473 923			
							0 986 471 924	→ 54	1 987 470 506 <sup>B</sup>	
							0 986 473 924			
			PR-Code 1LQ, PR-Code 1LS, PR-Code 1ZP	228,252		0 986 473 071	← 54	1 987 470 506 <sup>B</sup>		
						0 986 474 071	→ 54	1 987 470 506 <sup>B</sup>		
			PR-Code 1LT	312		0 986 473 923	← 54	1 987 470 506 <sup>B</sup>		
						0 986 473 924	→ 54	1 987 470 506 <sup>B</sup>		





<b>AUDI A3 [8L1]</b>								
<b>1.8</b>	09.96-06.03	92	PR-Code 1LQ, PR-Code 1LS, PR-Code 1ZP	228,252	0986 473 071		← 54	1987 470 506 <sup>8</sup>
					0986 474 071		→ 54	1987 470 506 <sup>8</sup>
<b>1.8</b>	05.99-09.06	92			0986 473 071		← 54	1987 470 506 <sup>8</sup>
					0986 474 071		→ 54	1987 470 506 <sup>8</sup>
<b>1.8 quattro</b>	09.96-06.03	92	PR-Code 1LE	288	0986 471 923		← 54	1987 470 506 <sup>8</sup>
					0986 473 923			
					0986 471 924		→ 54	1987 470 506 <sup>8</sup>
<b>1.8 quattro</b>			PR-Code 1LT	312	0986 473 924			
					0986 473 923		← 54	1987 470 506 <sup>8</sup>
<b>1.8 quattro</b>	08.98-06.99	92	PR-Code 1LQ, PR-Code 1LS, PR-Code 1ZP	228,252	0986 473 071		← 54	1987 470 506 <sup>8</sup>
					0986 474 071		→ 54	1987 470 506 <sup>8</sup>
<b>1.8 T</b>	12.96-06.03	110/132	PR-Code 1LE	288	0986 471 923		← 54	1987 470 506 <sup>8</sup>
					0986 473 923			
					0986 471 924		→ 54	1987 470 506 <sup>8</sup>
<b>1.8 T quattro</b>	08.97-06.03	110/132	PR-Code 1LE	288	0986 471 923		← 54	1987 470 506 <sup>8</sup>
					0986 473 923			
					0986 471 924		→ 54	1987 470 506 <sup>8</sup>
<b>1.8 T</b>	12.96-06.03	110/132	PR-Code 1LQ, PR-Code 1LS, PR-Code 1ZP	228,252	0986 473 071		← 54	1987 470 506 <sup>8</sup>
					0986 474 071		→ 54	1987 470 506 <sup>8</sup>
<b>1.8 T quattro</b>			PR-Code 1LT	312	0986 473 923		← 54	1987 470 506 <sup>8</sup>
					0986 473 924		→ 54	1987 470 506 <sup>8</sup>
<b>1.9 TDI</b>	09.96-06.03	66/74	PR-Code 1LE	288	0986 471 923		← 54	1987 470 506 <sup>8</sup>
					0986 473 923			
					0986 471 924		→ 54	1987 470 506 <sup>8</sup>
<b>1.9 TDI</b>			PR-Code 1LQ, PR-Code 1LS, PR-Code 1ZP	228,252	0986 473 071		← 54	1987 470 506 <sup>8</sup>
					0986 474 071		→ 54	1987 470 506 <sup>8</sup>
					0986 473 923		← 54	1987 470 506 <sup>8</sup>
<b>1.9 TDI</b>	01.97-06.01	81	PR-Code 1LE	288	0986 473 924		→ 54	1987 470 506 <sup>8</sup>
					0986 471 923		← 54	1987 470 506 <sup>8</sup>
					0986 473 924			
<b>1.9 TDI</b>			PR-Code 1LQ, PR-Code 1LS, PR-Code 1ZP	228,252	0986 473 071		← 54	1987 470 506 <sup>8</sup>
					0986 474 071		→ 54	1987 470 506 <sup>8</sup>
					0986 473 923		← 54	1987 470 506 <sup>8</sup>
<b>1.9 TDI</b>	01.00-09.06	81	PR-Code 1LT	312	0986 473 924		→ 54	1987 470 506 <sup>8</sup>
					0986 471 923		← 54	1987 470 506 <sup>8</sup>
					0986 473 923			
<b>1.9 TDI</b>	05.00-06.03	96	PR-Code 1LE	288	0986 471 923		← 54	1987 470 506 <sup>8</sup>
					0986 473 923			
<b>1.9 TDI quattro</b>			PR-Code 1LQ, PR-Code 1LS, PR-Code 1ZP	228,252	0986 473 071		← 54	1987 470 506 <sup>8</sup>
					0986 474 071		→ 54	1987 470 506 <sup>8</sup>
<b>1.9 TDI quattro</b>			PR-Code 1LT	312	0986 473 923		← 54	1987 470 506 <sup>8</sup>
					0986 473 924		→ 54	1987 470 506 <sup>8</sup>
	<b>1.6</b>	09.96-06.99	74	Fg.-Nr. →8L..X..200 000	0986 473 072		← 38	1987 470 040 <sup>7</sup>
					0986 473 072		← 38	1987 474 496 <sup>8</sup>
					0986 474 072		→ 38	1987 470 040 <sup>7</sup>

		S							
1.6	05.99-09.06	74					0 986 473 099	← 38,1	1 987 470 040 <sup>7</sup>
							0 986 473 099	← 38,1	1 987 474 496 <sup>B</sup>
							0 986 474 099	→ 38,1	1 987 470 040 <sup>7</sup>
	05.00-06.03	75					0 986 473 099	← 38,1	1 987 470 040 <sup>7</sup>
							0 986 473 099	← 38,1	1 987 474 496 <sup>B</sup>
							0 986 474 099	→ 38,1	1 987 470 040 <sup>7</sup>
1.8	09.96-06.99	92	Fg.-Nr. →8L..X..200 000				0 986 473 072	← 38	1 987 470 040 <sup>7</sup>
							0 986 473 072	← 38	1 987 474 496 <sup>B</sup>
							0 986 474 072	→ 38	1 987 470 040 <sup>7</sup>
	05.99-09.06	92					0 986 473 099	← 38,1	1 987 470 040 <sup>7</sup>
							0 986 473 099	← 38,1	1 987 474 496 <sup>B</sup>
							0 986 474 099	→ 38,1	1 987 470 040 <sup>7</sup>
1.8 quattro	08.98-06.99	92			232		0 986 473 029	← 41	1 987 474 496 <sup>B</sup>
							0 986 474 029	→ 41	1 987 474 496 <sup>B</sup>
1.8 T	12.96-06.99	110	Fg.-Nr. →8L..X..200 000				0 986 473 072	← 38	1 987 470 040 <sup>7</sup>
							0 986 473 072	← 38	1 987 474 496 <sup>B</sup>
							0 986 474 072	→ 38	1 987 470 040 <sup>7</sup>
	08.98-06.99	110					0 986 473 072	← 38	1 987 470 040 <sup>7</sup>
							0 986 473 072	← 38	1 987 474 496 <sup>B</sup>
							0 986 474 072	→ 38	1 987 470 040 <sup>7</sup>
		132	Fg.-Nr. →8L..X..200 000				0 986 473 072	← 38	1 987 470 040 <sup>7</sup>
							0 986 473 072	← 38	1 987 474 496 <sup>B</sup>
							0 986 474 072	→ 38	1 987 470 040 <sup>7</sup>
	05.99-09.06	110					0 986 473 099	← 38,1	1 987 470 040 <sup>7</sup>
							0 986 473 099	← 38,1	1 987 474 496 <sup>B</sup>
							0 986 474 099	→ 38,1	1 987 470 040 <sup>7</sup>
	07.99-08.00	132	Fg.-Nr. 8L..Y..000 001→				0 986 473 099	← 38,1	1 987 470 040 <sup>7</sup>
							0 986 473 099	← 38,1	1 987 474 496 <sup>B</sup>
							0 986 474 099	→ 38,1	1 987 470 040 <sup>7</sup>
	03.00-09.06	132					0 986 473 099	← 38,1	1 987 470 040 <sup>7</sup>
							0 986 473 099	← 38,1	1 987 474 496 <sup>B</sup>
							0 986 474 099	→ 38,1	1 987 470 040 <sup>7</sup>
1.8 T quattro	08.97-06.03	110			232		0 986 473 029	← 41	1 987 474 496 <sup>B</sup>
							0 986 474 029	→ 41	1 987 474 496 <sup>B</sup>
							0 986 473 029	← 41	1 987 474 496 <sup>B</sup>
	08.98-06.03	132			232		0 986 474 029	→ 41	1 987 474 496 <sup>B</sup>
							0 986 473 029	← 41	1 987 474 496 <sup>B</sup>
							0 986 474 029	→ 41	1 987 474 496 <sup>B</sup>
1.9 TDI	09.96-06.99	66	Fg.-Nr. →8L..X..200 000				0 986 473 072	← 38	1 987 470 040 <sup>7</sup>
							0 986 473 072	← 38	1 987 474 496 <sup>B</sup>
							0 986 474 072	→ 38	1 987 470 040 <sup>7</sup>
	01.97-06.99	81	Fg.-Nr. →8L..X..200 000				0 986 473 072	← 38	1 987 470 040 <sup>7</sup>
							0 986 473 072	← 38	1 987 474 496 <sup>B</sup>
							0 986 474 072	→ 38	1 987 470 040 <sup>7</sup>
	07.99-08.00	81	Fg.-Nr. 8L..Y..000 001→				0 986 473 099	← 38,1	1 987 470 040 <sup>7</sup>
							0 986 473 099	← 38,1	1 987 474 496 <sup>B</sup>
							0 986 474 099	→ 38,1	1 987 470 040 <sup>7</sup>
	07.99-06.01	66	Fg.-Nr. 8L..Y..000 001→				0 986 473 099	← 38,1	1 987 470 040 <sup>7</sup>
							0 986 473 099	← 38,1	1 987 474 496 <sup>B</sup>
							0 986 474 099	→ 38,1	1 987 470 040 <sup>7</sup>
	09.99-09.06	81					0 986 473 099	← 38,1	1 987 470 040 <sup>7</sup>
							0 986 473 099	← 38,1	1 987 474 496 <sup>B</sup>
							0 986 474 099	→ 38,1	1 987 470 040 <sup>7</sup>
	05.00-06.03	96					0 986 473 099	← 38,1	1 987 470 040 <sup>7</sup>
							0 986 473 099	← 38,1	1 987 474 496 <sup>B</sup>
							0 986 474 099	→ 38,1	1 987 470 040 <sup>7</sup>
	09.00-06.03	74					0 986 473 099	← 38,1	1 987 470 040 <sup>7</sup>
							0 986 473 099	← 38,1	1 987 474 496 <sup>B</sup>
							0 986 474 099	→ 38,1	1 987 470 040 <sup>7</sup>
1.9 TDI quattro	05.00-06.03	96			232		0 986 473 029	← 41	1 987 474 496 <sup>B</sup>
							0 986 474 029	→ 41	1 987 474 496 <sup>B</sup>























































		S								
◀ AUDI A3 [8L1]										
	1.6	09.96-06.99	74	Fg.-Nr. →8L..X..200 000			1 987 477 696	↔	1688	
		07.99-06.01	74	Fg.-Nr. 8L..Y..000 001→			1 987 477 698	↔	1693	
		05.00-04.02	75				1 987 477 698	↔	1693	
		05.02-06.03	75		SSZ		1 987 477 698	↔	1693	
	1.8	09.96-06.99	92	Fg.-Nr. →8L..X..200 000			1 987 477 696	↔	1688	
		07.99-06.03	92	Fg.-Nr. 8L..Y..000 001→			1 987 477 698	↔	1693	
	1.8 quattro	08.98-06.99	92				1 987 477 686	↔	1723	
	1.8 T	12.96-06.99	110	Fg.-Nr. →8L..X..200 000			1 987 477 696	↔	1688	
		08.98-06.99	110				1 987 477 696	↔	1688	
			132	Fg.-Nr. →8L..X..200 000			1 987 477 696	↔	1688	
		07.99-08.00	132	Fg.-Nr. 8L..Y..000 001→			1 987 477 698	↔	1693	
		07.99-06.03	110				1 987 477 698	↔	1693	
		05.00-06.03	132				1 987 477 698	↔	1693	
		09.00-06.01	132			SSZ	1 987 477 698	↔	1693	
	1.8 T quattro	08.97-06.03	110				1 987 477 686	↔	1723	
		08.98-06.03	132				1 987 477 686	↔	1723	
	1.9 TDI	09.96-06.99	66	Fg.-Nr. →8L..X..200 000			1 987 477 696	↔	1688	
		01.97-06.99	81	Fg.-Nr. →8L..X..200 000			1 987 477 696	↔	1688	
		07.99-08.00	81	Fg.-Nr. 8L..Y..000 001→			1 987 477 698	↔	1693	
		07.99-06.01	66	Fg.-Nr. 8L..Y..000 001→			1 987 477 698	↔	1693	
09.99-06.01		81				1 987 477 698	↔	1693		
05.00-06.03		96				1 987 477 698	↔	1693		
09.00-06.03		74			SSZ	1 987 477 698	↔	1693		
1.9 TDI quattro	05.00-06.03	96				1 987 477 686	↔	1723		
	1.6	09.96-09.06	74/75				0 986 594 004 <sup>4</sup>			
					LAB		0 986 594 001 <sup>3</sup>			
					RAB		0 986 594 000 <sup>3</sup>			
	1.8, quattro, T, T quattro	09.96-09.06	92/110/				0 986 594 001 <sup>3</sup>			
			132				0 986 594 000 <sup>3</sup>			
	1.8, T	09.96-09.06	92/110/132				0 986 594 004 <sup>4</sup>			
	1.8 quattro, T quattro	08.97-06.03	92/110/132				0 986 594 008 <sup>4</sup>			
	1.9 TDI	09.96-09.06	66/74/81					0 986 594 004 <sup>4</sup>		
							LAB	0 986 594 001 <sup>3</sup>		
							RAB	0 986 594 000 <sup>3</sup>		
		05.00-06.03	96					0 986 594 004 <sup>4</sup>		
	1.9 TDI quattro	05.00-06.03	96					0 986 594 008 <sup>4</sup>		
	1.9 TDI	05.00-06.03	96			LAB	0 986 594 001 <sup>3</sup>			
	1.9 TDI quattro					RAB	0 986 594 000 <sup>3</sup>			
	<b>A3 [8P1]</b>									
	1.2 TFSI	04.10-03.13	77						1 987 470 506 <sup>8</sup>	
				PR-Code 1ZE	288		0 986 473 384		← 53,94	F 026 A06 106 <sup>7</sup>
							0 986 474 384		→ 53,94	F 026 A06 106 <sup>7</sup>
				PR-Code 1ZF	228		0 986 473 071		← 54	F 026 A06 100 <sup>7</sup>
						0 986 474 071		→ 54	F 026 A06 100 <sup>7</sup>	
	1.4 TFSI	09.07-03.13	92							1 987 470 506 <sup>8</sup>
				PR-Code 1ZE	288		0 986 473 384		← 53,94	F 026 A06 106 <sup>7</sup>
							0 986 474 384		→ 53,94	F 026 A06 106 <sup>7</sup>
				PR-Code 1ZF	228		0 986 473 071		← 54	F 026 A06 100 <sup>7</sup>
						0 986 474 071		→ 54	F 026 A06 100 <sup>7</sup>	
	1.6	05.03-05.05	75							1 987 470 506 <sup>8</sup>
						228	0 986 473 071		← 54	1 987 470 506 <sup>8</sup>
					288	0 986 474 071		→ 54	1 987 470 506 <sup>8</sup>	
					288	0 986 473 384		← 53,94	F 026 A06 100 <sup>7</sup>	
					288	0 986 473 384		← 53,94	1 987 470 506 <sup>8</sup>	
						0 986 474 384		→ 53,94	F 026 A06 100 <sup>7</sup>	

		S							
<b>1.6</b>		06.05-03.13	75						1 987 470 506 <sup>B</sup>
				PR-Code 1ZE	288	0 986 473 384		53,94	F 026 A06 106 <sup>7</sup>
						0 986 474 384		53,94	F 026 A06 106 <sup>7</sup>
				PR-Code 1ZF	228	0 986 473 071		54	F 026 A06 100 <sup>7</sup>
						0 986 474 071		54	F 026 A06 100 <sup>7</sup>
<b>1.6 FSI</b>		08.03-09.07	85		228	0 986 473 071		54	1 987 470 506 <sup>B</sup>
					288	0 986 473 384		53,94	F 026 A06 100 <sup>7</sup>
						0 986 473 384		53,94	1 987 470 506 <sup>B</sup>
						0 986 474 384		53,94	F 026 A06 100 <sup>7</sup>
<b>1.6 TDI</b>		05.09-03.13	66						1 987 470 506 <sup>B</sup>
				PR-Code 1ZE	288	0 986 473 384		53,94	F 026 A06 106 <sup>7</sup>
						0 986 474 384		53,94	F 026 A06 106 <sup>7</sup>
				PR-Code 1ZF	228	0 986 473 071		54	F 026 A06 100 <sup>7</sup>
						0 986 474 071		54	F 026 A06 100 <sup>7</sup>
		11.09-08.12	77						1 987 470 506 <sup>B</sup>
				PR-Code 1ZE	288	0 986 473 384		53,94	F 026 A06 106 <sup>7</sup>
						0 986 474 384		53,94	F 026 A06 106 <sup>7</sup>
				PR-Code 1ZF	228	0 986 473 071		54	F 026 A06 100 <sup>7</sup>
						0 986 474 071		54	F 026 A06 100 <sup>7</sup>
<b>1.8 TFSI</b>		11.06-05.08	118		288,312	0 986 473 384		53,94	F 026 A06 100 <sup>7</sup>
						0 986 473 384		53,94	1 987 470 506 <sup>B</sup>
						0 986 474 384		53,94	F 026 A06 100 <sup>7</sup>
		07.08-08.12	118	PR-Code 1LJ, PR-Code 1ZE, PR-Code 1ZA, PR-Code 1ZD	288,312	0 986 473 384		53,94	F 026 A06 106 <sup>7</sup>
						0 986 473 384		53,94	1 987 470 506 <sup>B</sup>
						0 986 474 384		53,94	F 026 A06 106 <sup>7</sup>
<b>1.8 TFSI quattro</b>		07.08-03.13	118	PR-Code 1LJ, PR-Code 1ZE, PR-Code 1ZA, PR-Code 1ZD	288,312	0 986 473 384		53,94	F 026 A06 106 <sup>7</sup>
						0 986 473 384		53,94	1 987 470 506 <sup>B</sup>
						0 986 474 384		53,94	F 026 A06 106 <sup>7</sup>
<b>1.9 TDI</b>		06.03-05.10	77		228	0 986 473 071		54	1 987 470 506 <sup>B</sup>
					288	0 986 474 071		54	1 987 470 506 <sup>B</sup>
						0 986 473 384		53,94	F 026 A06 100 <sup>7</sup>
						0 986 473 384		53,94	1 987 470 506 <sup>B</sup>
						0 986 474 384		53,94	F 026 A06 100 <sup>7</sup>
<b>2.0 FSI</b>		05.03-06.08	110/120		288,312	0 986 473 384		53,94	F 026 A06 100 <sup>7</sup>
<b>2.0 TDI</b>						0 986 473 384		53,94	1 987 470 506 <sup>B</sup>
						0 986 474 384		53,94	F 026 A06 100 <sup>7</sup>
<b>2.0 TDI</b>		05.03-06.08	100		288,312	0 986 473 384		53,94	F 026 A06 100 <sup>7</sup>
						0 986 473 384		53,94	1 987 470 506 <sup>B</sup>
						0 986 474 384		53,94	F 026 A06 100 <sup>7</sup>
			103		288,312	0 986 473 384		53,94	F 026 A06 100 <sup>7</sup>
						0 986 473 384		53,94	1 987 470 506 <sup>B</sup>
						0 986 474 384		53,94	F 026 A06 100 <sup>7</sup>
		07.08-05.10	100		228	0 986 473 071		54	1 987 470 506 <sup>B</sup>
					288	0 986 474 071		54	1 987 470 506 <sup>B</sup>
						0 986 473 384		53,94	F 026 A06 100 <sup>7</sup>
						0 986 473 384		53,94	1 987 470 506 <sup>B</sup>
						0 986 474 384		53,94	F 026 A06 100 <sup>7</sup>
			103		228	0 986 473 071		54	1 987 470 506 <sup>B</sup>
					288	0 986 474 071		54	1 987 470 506 <sup>B</sup>
						0 986 473 384		53,94	F 026 A06 100 <sup>7</sup>
						0 986 473 384		53,94	1 987 470 506 <sup>B</sup>
						0 986 474 384		53,94	F 026 A06 100 <sup>7</sup>
		11.09-03.13	100						1 987 470 506 <sup>B</sup>
				PR-Code 1ZE	288	0 986 473 384		53,94	F 026 A06 106 <sup>7</sup>
						0 986 474 384		53,94	F 026 A06 106 <sup>7</sup>
				PR-Code 1ZF	228	0 986 473 071		54	F 026 A06 100 <sup>7</sup>
						0 986 474 071		54	F 026 A06 100 <sup>7</sup>
			103	PR-Code 1LJ, PR-Code 1ZE, PR-Code 1ZA, PR-Code 1ZD	288,312	0 986 473 384		53,94	F 026 A06 106 <sup>7</sup>
						0 986 473 384		53,94	1 987 470 506 <sup>B</sup>
						0 986 474 384		53,94	F 026 A06 106 <sup>7</sup>











<b>AUDI A3 [8P1]</b>														
	2.0 TDI quattro	05.03-06.08	100		288,312	0986 473 384		53,94	F 026 A06 100 <sup>7</sup>					
						0986 473 384		53,94	1 987 470 506 <sup>8</sup>					
						0986 474 384		53,94	F 026 A06 100 <sup>7</sup>					
	11.04-06.08	103			288,312	0986 473 384		53,94	F 026 A06 100 <sup>7</sup>					
						0986 473 384		53,94	1 987 470 506 <sup>8</sup>					
						0986 474 384		53,94	F 026 A06 100 <sup>7</sup>					
	09.08-05.10	103				0986 473 384		53,94	F 026 A06 106 <sup>7</sup>					
						0986 473 384		53,94	1 987 470 506 <sup>8</sup>					
						0986 474 384		53,94	F 026 A06 106 <sup>7</sup>					
	11.09-03.13	103							1 987 470 506 <sup>8</sup>					
						PR-Code 1LJ, PR-Code 1ZE, PR-Code 1ZA, PR-Code 1ZD	288,312	0986 473 384		53,94	F 026 A06 106 <sup>7</sup>			
								0986 473 384		53,94	1 987 470 506 <sup>8</sup>			
									0986 474 384		53,94	F 026 A06 106 <sup>7</sup>		
												1 987 470 506 <sup>8</sup>		
		2.0 TDI	03.06-06.08	125		288,312	0986 473 384		53,94	F 026 A06 100 <sup>7</sup>				
0986 473 384								53,94	1 987 470 506 <sup>8</sup>					
0986 474 384								53,94	F 026 A06 100 <sup>7</sup>					
2.0 TDI quattro		07.08-05.10	125			288,312	0986 473 384		53,94	F 026 A06 106 <sup>7</sup>				
							0986 473 384		53,94	1 987 470 506 <sup>8</sup>				
							0986 474 384		53,94	F 026 A06 106 <sup>7</sup>				
11.09-03.13		125				288,312	0986 473 384		53,94	F 026 A06 106 <sup>7</sup>				
							PR-Code 1LJ, PR-Code 1ZE, PR-Code 1ZA, PR-Code 1ZD			0986 473 384		53,94	1 987 470 506 <sup>8</sup>	
									0986 474 384		53,94	F 026 A06 106 <sup>7</sup>		
											1 987 470 506 <sup>8</sup>			
2.0 TFSI		09.04-06.08	147				0986 473 384		53,94	F 026 A06 100 <sup>7</sup>				
							0986 473 384		53,94	1 987 470 506 <sup>8</sup>				
							0986 474 384		53,94	F 026 A06 100 <sup>7</sup>				
		07.08-03.13	147								1 987 470 506 <sup>8</sup>			
								PR-Code 1LJ, PR-Code 1ZE, PR-Code 1ZA, PR-Code 1ZD	288,312	0986 473 384		53,94	F 026 A06 106 <sup>7</sup>	
									0986 473 384		53,94	1 987 470 506 <sup>8</sup>		
								0986 474 384		53,94	F 026 A06 106 <sup>7</sup>			
											0986 134 257			F 026 A03 545 <sup>7</sup>
											0986 135 257			F 026 A03 545 <sup>7</sup>
3.2 quattro	07.03-10.05	184			312	0986 473 384		53,94	F 026 A06 100 <sup>7</sup>					
						0986 473 384		53,94	1 987 470 506 <sup>8</sup>					
						0986 474 384		53,94	F 026 A06 100 <sup>7</sup>					
	07.03-05.09	184				312	0986 134 257			F 026 A03 545 <sup>7</sup>				
							0986 134 257			1 987 470 506 <sup>8</sup>				
							0986 135 257			F 026 A03 545 <sup>7</sup>				
		1.2 TFSI	04.10-03.13	77			PR-Code 1KD			0986 473 381		38,1		
									0986 474 381		38,1			
PR-Code 1KD, PR-Code 1KZ PR-Code 1KZ												1 987 470 040 <sup>7</sup>		
							0986 134 048		38					
							0986 135 048		38					
1.4 TFSI		09.07-03.13	92				PR-Code 1KD			0986 473 381		38,1		
										0986 474 381		38,1		
							PR-Code 1KD, PR-Code 1KZ PR-Code 1KZ					1 987 470 040 <sup>7</sup>		
							0986 134 048		38					
							0986 135 048		38					
1.6		05.03-05.05	75				PR-Code 1KE			0986 473 448		41		
										0986 474 448		41		
							PR-Code 1KQ, PR-Code 1KD					1 987 470 040 <sup>7</sup>		
							0986 473 381		38,1	1 987 470 040 <sup>7</sup>				
							0986 474 381		38,1	1 987 470 040 <sup>7</sup>				
06.05-03.13	75					PR-Code 1KD			0986 473 381		38,1	1 987 470 040 <sup>7</sup>		
									0986 474 381		38,1	1 987 470 040 <sup>7</sup>		
1.6 FSI	08.03-09.07	85				PR-Code 1KE			0986 473 448		41			
									0986 474 448		41			
						PR-Code 1KQ, PR-Code 1KD					1 987 470 040 <sup>7</sup>			
						0986 473 381		38,1	1 987 470 040 <sup>7</sup>					
						0986 474 381		38,1	1 987 470 040 <sup>7</sup>					

		<b>S</b>								
<b>1.6 TDI</b>	05.09-03.13	66	PR-Code 1KD	0986 473 381		← 38,1	1987 470 040 <sup>7</sup>			
				0986 474 381		→ 38,1	1987 470 040 <sup>7</sup>			
	11.09-08.12	77	PR-Code 1KD	0986 473 381		← 38,1	1987 470 040 <sup>7</sup>			
				0986 474 381		→ 38,1	1987 470 040 <sup>7</sup>			
<b>1.8 TFSI</b>	11.06-06.07	118	PR-Code 1KQ, PR-Code 1KD	0986 473 381		← 38,1	1987 470 040 <sup>7</sup>			
				0986 474 381		→ 38,1	1987 470 040 <sup>7</sup>			
	11.06-05.08	118	PR-Code 1KZ	0986 134 048		← 38	1987 470 040 <sup>7</sup>			
				0986 135 048		→ 38	1987 470 040 <sup>7</sup>			
	06.07-05.08	118	PR-Code 1KD	0986 473 381		← 38,1	1987 470 040 <sup>7</sup>			
0986 474 381					→ 38,1	1987 470 040 <sup>7</sup>				
07.08-08.12	118	PR-Code 1KZ	0986 134 048		← 38	1987 470 040 <sup>7</sup>				
			0986 135 048		→ 38	1987 470 040 <sup>7</sup>				
<b>1.8 TFSI quattro</b>	07.08-03.13	118	PR-Code 1KJ	0986 473 448		← 41				
				0986 474 448		→ 41				
<b>1.9 TDI</b>	06.03-05.06	77	PR-Code 1KE	0986 473 448		← 41				
				0986 474 448		→ 41				
		11.05-05.10	77	PR-Code 1KQ, PR-Code 1KD	0986 473 381		← 38,1	1987 470 040 <sup>7</sup>		
					0986 474 381		→ 38,1	1987 470 040 <sup>7</sup>		
		05.03-10.05	110	PR-Code 1KE	0986 473 448		← 41			
0986 474 448						→ 41				
<b>2.0 FSI</b>	05.03-11.06	110	PR-Code 1KQ, PR-Code 1KD	0986 473 381		← 38,1	1987 470 040 <sup>7</sup>			
				0986 474 381		→ 38,1	1987 470 040 <sup>7</sup>			
		11.05-06.08	110	PR-Code 1KZ	0986 134 048		← 38	1987 470 040 <sup>7</sup>		
					0986 135 048		→ 38	1987 470 040 <sup>7</sup>		
		05.03-06.08	100	PR-Code 1KE	0986 473 448		← 41			
0986 474 448						→ 41				
<b>2.0 TDI</b>		103	PR-Code 1KQ, PR-Code 1KD	0986 473 381		← 38,1	1987 470 040 <sup>7</sup>			
				0986 474 381		→ 38,1	1987 470 040 <sup>7</sup>			
		103	PR-Code 1KZ	0986 134 048		← 38	1987 470 040 <sup>7</sup>			
				0986 135 048		→ 38	1987 470 040 <sup>7</sup>			
		03.06-06.08	125	PR-Code 1KQ, PR-Code 1KD	0986 473 381		← 38,1	1987 470 040 <sup>7</sup>		
					0986 474 381		→ 38,1	1987 470 040 <sup>7</sup>		
		06.06-06.08	120	PR-Code 1KQ, PR-Code 1KD	0986 134 048		← 38	1987 470 040 <sup>7</sup>		
					0986 135 048		→ 38	1987 470 040 <sup>7</sup>		
		07.08-05.10	100	PR-Code 1KQ, PR-Code 1KD	0986 473 381		← 38,1	1987 470 040 <sup>7</sup>		
					0986 474 381		→ 38,1	1987 470 040 <sup>7</sup>		
		09.08-05.10	125	PR-Code 1KD	0986 473 381		← 38,1	1987 470 040 <sup>7</sup>		
					0986 474 381		→ 38,1	1987 470 040 <sup>7</sup>		
		09.08-03.13	125	PR-Code 1KZ	0986 134 048		← 38			
0986 135 048						→ 38				
	11.09-03.13	100	PR-Code 1KD	0986 473 381		← 38,1				
				0986 474 381		→ 38,1				
			PR-Code 1KD, PR-Code 1KZ				1987 470 040 <sup>7</sup>			
					PR-Code 1KZ	0986 134 048		← 38		
		0986 135 048				→ 38				



		S							
	◀ AUDI A3 [8P1]								
2.0 TDI	11.09-03.13	103	PR-Code 1KD				0986 473 381		← 38,1
							0986 474 381		→ 38,1
			PR-Code 1KD, PR-Code 1KZ						1987 470 040 <sup>7</sup>
			PR-Code 1KZ				0986 134 048		← 38
							0986 135 048		→ 38
	125		PR-Code 1KD				0986 473 381		← 38,1
							0986 474 381		→ 38,1
			PR-Code 1KD, PR-Code 1KZ						1987 470 040 <sup>7</sup>
2.0 TDI quattro	05.03-06.08	100					0986 473 448		← 41
							0986 474 448		→ 41
	11.04-06.08	103					0986 473 448		← 41
							0986 474 448		→ 41
	03.06-06.08	125					0986 473 448		← 41
							0986 474 448		→ 41
	07.08-03.13	125	PR-Code 1KJ				0986 473 448		← 41
							0986 474 448		→ 41
	09.08-03.13	103	PR-Code 1KJ				0986 473 448		← 41
							0986 474 448		→ 41
2.0 TFSI	09.04-10.05	147	PR-Code 1KE				0986 473 448		← 41
							0986 474 448		→ 41
			PR-Code 1KZ				0986 134 048		← 38
							0986 135 048		→ 38
	09.05-06.08	147					0986 134 048		← 38
							0986 135 048		→ 38
	07.08-03.13	147	PR-Code 1KJ				0986 473 448		← 41
							0986 474 448		→ 41
2.0 TFSI quattro	09.04-10.05	147	PR-Code 1KU, PR-Code 1KJ, PR-Code 1KF				0986 473 448		← 41
							0986 474 448		→ 41
	11.05-06.08	147					0986 473 448		← 41
							0986 474 448		→ 41
	07.08-03.13	147	PR-Code 1KJ				0986 473 448		← 41
							0986 474 448		→ 41
3.2 quattro	07.03-10.05	184					0986 134 297		←
							0986 135 297		→
	11.05-05.09	184	PR-Code 2EA			FBJ	0986 134 297		←
							0986 135 297		→
	1.2 TFSI	04.10-03.13	77	PR-Code 1SA, PR-Code 1SB	SSZ		1987 482 445		↔ 1447
							1987 477 958		↔ 1447
	1.4 TFSI	09.07-03.13	92	PR-Code 1SA, PR-Code 1SB	SSZ		1987 482 445		↔ 1447
							PR-Code 1SK	SSZ	1987 477 958
	1.6	05.03-03.13	66/75/77/ 85	PR-Code 1SA, PR-Code 1SB	SSZ		1987 482 445		↔ 1447
							PR-Code 1SK	SSZ	1987 477 958
	1.6 FSI	08.03-09.07	66/75/77/ 85	PR-Code 1SA, PR-Code 1SB	SSZ		1987 482 445		↔ 1447
							PR-Code 1SK	SSZ	1987 477 958
	1.6 TDI	05.09-03.13	66/75/77/ 85	PR-Code 1SA, PR-Code 1SB	SSZ		1987 482 445		↔ 1447
							PR-Code 1SK	SSZ	1987 477 958
	1.8 TFSI	11.06-05.08	118	PR-Code 1SA, PR-Code 1SB	SSZ		1987 482 445		↔ 1447
							PR-Code 1SK	SSZ	1987 477 958
		07.08-08.12	118	PR-Code 1SA, PR-Code 1SB	SSZ		1987 482 445		↔ 1447
				PR-Code 1SK	SSZ		1987 477 958		↔ 1447
	1.8 TFSI quattro	07.08-03.13	118				1987 477 958		↔ 1447
	1.9 TDI	06.03-05.10	77	PR-Code 1SA, PR-Code 1SB	SSZ		1987 482 445		↔ 1447
							PR-Code 1SK	SSZ	1987 477 958
	2.0 FSI	05.03-06.08	110/120	PR-Code 1SA, PR-Code 1SB	SSZ		1987 482 445		↔ 1447
							PR-Code 1SK	SSZ	1987 477 958
	2.0 TDI	05.03-03.13	100	PR-Code 1SA, PR-Code 1SB	SSZ		1987 482 445		↔ 1447
							PR-Code 1SK	SSZ	1987 477 958
			103	PR-Code 1SA, PR-Code 1SB	SSZ		1987 482 445		↔ 1447
				PR-Code 1SK	SSZ		1987 477 958		↔ 1447

		S								
<b>2.0 TDI</b>	03.06-06.08	125		PR-Code 1SA, PR-Code 1SB	SSZ	1 987 482 445	↔ 1447			
				PR-Code 1SK	SSZ	1 987 477 958	↔ 1447			
	06.06-06.08	110/120		PR-Code 1SA, PR-Code 1SB	SSZ	1 987 482 445	↔ 1447			
				PR-Code 1SK	SSZ	1 987 477 958	↔ 1447			
09.08-03.13	125		PR-Code 1SA, PR-Code 1SB	SSZ	1 987 482 445	↔ 1447				
			PR-Code 1SK	SSZ	1 987 477 958	↔ 1447				
<b>2.0 TDI quattro</b>	05.03-01.06	100		Fg.-Nr. →8P..6A140 000, →8P..6B012 000		1 987 482 445	↔ 1447			
	11.04-01.06	103		Fg.-Nr. →8P..6A140 000, →8P..6B012 000		1 987 482 445	↔ 1447			
	02.06-06.08	100		Fg.-Nr. 8P..6A140 001→, 8P..6B012 001→		1 987 477 958	↔ 1447			
		103		Fg.-Nr. 8P..6A140 001→, 8P..6B012 001→		1 987 477 958	↔ 1447			
	03.06-03.13	125				1 987 477 958	↔ 1447			
	09.08-03.13	103				1 987 477 958	↔ 1447			
<b>2.0 TFSI</b>	09.04-03.13	147		PR-Code 1SA, PR-Code 1SB	SSZ	1 987 482 445	↔ 1447			
				PR-Code 1SK	SSZ	1 987 477 958	↔ 1447			
<b>2.0 TFSI quattro</b>	09.04-10.05	147				1 987 482 445	↔ 1447			
	11.05-01.06	147		Fg.-Nr. →8P..6A140 000, →8P..6B012 000		1 987 482 445	↔ 1447			
	02.06-06.08	147		Fg.-Nr. 8P..6A140 001→, 8P..6B012 001→		1 987 477 958	↔ 1447			
		147				1 987 477 958	↔ 1447			
<b>3.2 quattro</b>	07.03-10.05	184				1 987 482 445	↔ 1447			
	11.05-01.06	184		Fg.-Nr. →8P..6A140 000, →8P..6B012 000		1 987 482 445	↔ 1447			
		184				1 987 482 445	↔ 1447			
	02.06-05.09	184		Fg.-Nr. 8P..6A140 001→, 8P..6B012 001→		1 987 477 958	↔ 1447			
 <b>1.2 TFSI</b>	04.10-03.13	77			LAB	0 986 594 504 <sup>3</sup>				
					RAB	0 986 594 505 <sup>3</sup>				
						0 986 594 507 <sup>4</sup>				
<b>1.4 TFSI</b>	09.07-03.13	92			LAB	0 986 594 504 <sup>3</sup>				
					RAB	0 986 594 505 <sup>3</sup>				
						0 986 594 507 <sup>4</sup>				
<b>1.6</b> <b>1.6 FSI</b> <b>1.6 TDI</b>	05.03-03.13	66/75/77/ 85			LAB	0 986 594 504 <sup>3</sup>				
					RAB	0 986 594 505 <sup>3</sup>				
						0 986 594 507 <sup>4</sup>				
<b>1.8 TFSI</b>	11.06-05.08	118			LAB	0 986 594 504 <sup>3</sup>				
					RAB	0 986 594 505 <sup>3</sup>				
						0 986 594 507 <sup>4</sup>				
	07.08-08.12	118				LAB	0 986 594 504 <sup>3</sup>			
						RAB	0 986 594 505 <sup>3</sup>			
							0 986 594 507 <sup>4</sup>			
<b>1.8 TFSI quattro</b>	07.08-03.13	118			LAB	0 986 594 504 <sup>3</sup>				
					RAB	0 986 594 505 <sup>3</sup>				
						0 986 594 507 <sup>4</sup>				
<b>1.9 TDI</b>	06.03-05.10	77			LAB	0 986 594 504 <sup>3</sup>				
					RAB	0 986 594 505 <sup>3</sup>				
						0 986 594 507 <sup>4</sup>				
<b>2.0 FSI</b> <b>2.0 TDI</b>	05.03-06.08	110/120			LAB	0 986 594 504 <sup>3</sup>				
					RAB	0 986 594 505 <sup>3</sup>				
						0 986 594 507 <sup>4</sup>				













































◀ AUDI A3 [8P1]										
2.0 TDI	05.03-05.10	100		LAB	0 986 594 506 <sup>4</sup>					
					RAB	0 986 594 507 <sup>4</sup>				
2.0 TDI	05.03-03.13	100		LAB	0 986 594 504 <sup>3</sup>					
				RAB	0 986 594 505 <sup>3</sup>					
	103			LAB	0 986 594 504 <sup>3</sup>					
				RAB	0 986 594 506 <sup>4</sup>					
	03.06-06.08	125/147			LAB	0 986 594 504 <sup>3</sup>				
					RAB	0 986 594 505 <sup>3</sup>				
09.08-03.13	125/147			LAB	0 986 594 504 <sup>3</sup>					
				RAB	0 986 594 505 <sup>3</sup>					
11.09-03.13	100			LAB	0 986 594 504 <sup>4</sup>					
				RAB	0 986 594 505 <sup>4</sup>					
2.0 TDI quattro	05.03-06.08	100		LAB	0 986 594 504 <sup>3</sup>					
				RAB	0 986 594 504 <sup>4</sup>					
2.0 TDI quattro	11.04-06.08	103		LAB	0 986 594 504 <sup>3</sup>					
				RAB	0 986 594 505 <sup>3</sup>					
	03.06-03.13	125/147			LAB	0 986 594 504 <sup>3</sup>				
					RAB	0 986 594 505 <sup>3</sup>				
	09.08-03.13	103			LAB	0 986 594 504 <sup>3</sup>				
					RAB	0 986 594 505 <sup>3</sup>				
2.0 TDI	09.04-03.13	125/147		LAB	0 986 594 506 <sup>4</sup>					
				RAB	0 986 594 507 <sup>4</sup>					
2.0 TFSI	09.04-03.13	125/147		LAB	0 986 594 504 <sup>3</sup>					
				RAB	0 986 594 505 <sup>3</sup>					
2.0 TFSI quattro	09.04-03.13	125/147		LAB	0 986 594 504 <sup>3</sup>					
				RAB	0 986 594 505 <sup>3</sup>					
3.2 quattro	07.03-05.09	184		LAB	0 986 594 504 <sup>3</sup>					
				RAB	0 986 594 505 <sup>3</sup>					
					0 986 594 505 <sup>4</sup>					



**A3 [8V1]**

	1.2 TFSI	12.12→	77/81	PR-Code 1KE					1 987 470 506 <sup>8</sup>
	1.4 TFSI	01.13→	90/92/103/110	PR-Code 1KE					1 987 470 506 <sup>8</sup>
	1.6 TDI	09.13-05.15	81	PR-Code 1KE					1 987 470 506 <sup>8</sup>
	1.8 FSI quattro, TFSI	04.12→	132	PR-Code 1KE					1 987 470 506 <sup>8</sup>
	2.0 quattro, TDI, TDI quattro	04.12→	77/81/100/105/110/135	PR-Code 1KE					1 987 470 506 <sup>8</sup>
	1.2 TFSI	12.12→	77/81		GBM,LAB	0 986 594 526 <sup>4</sup>			
					GBM,RAB	0 986 594 526 <sup>4</sup>			
	1.4 TFSI	04.12→	90/92/103/110		GBM,LAB	0 986 594 526 <sup>4</sup>			
					GBM,RAB	0 986 594 526 <sup>4</sup>			
	1.6 TDI	09.13→	81		GBM,LAB	0 986 594 526 <sup>4</sup>			
					GBM,RAB	0 986 594 526 <sup>4</sup>			

									
<b>1.8 FSI quattro</b>	08.12→	132				GBM,LAB	0 986 594 524 <sup>4</sup>		
						GBM,RAB	0 986 594 525 <sup>4</sup>		
						GBM,LAB	0 986 594 504 <sup>4</sup>		
						GBM,RAB	0 986 594 505 <sup>4</sup>		
<b>1.8 TFSI</b>	04.12→	132				GBM,LAB	0 986 594 526 <sup>4</sup>		
						GBM,RAB	0 986 594 526 <sup>4</sup>		
<b>2.0 quattro</b> <b>2.0 TDI quattro</b>	10.12→	110				GBM,LAB	0 986 594 524 <sup>4</sup>		
						GBM,RAB	0 986 594 525 <sup>4</sup>		
						GBM,LAB	0 986 594 504 <sup>4</sup>		
						GBM,RAB	0 986 594 505 <sup>4</sup>		
<b>2.0 TDI</b>	04.12→	110				GBM,LAB	0 986 594 526 <sup>4</sup>		
						GBM,RAB	0 986 594 526 <sup>4</sup>		
	09.12→	77/81/100/ 105					GBM,LAB	0 986 594 526 <sup>4</sup>	
							GBM,RAB	0 986 594 526 <sup>4</sup>	
	05.13→	135					GBM,LAB	0 986 594 526 <sup>4</sup>	
							GBM,RAB	0 986 594 526 <sup>4</sup>	
<b>2.0 TDI quattro</b>	05.13→	135				GBM,LAB	0 986 594 524 <sup>4</sup>		
						GBM,RAB	0 986 594 525 <sup>4</sup>		
						GBM,LAB	0 986 594 504 <sup>4</sup>		
						GBM,RAB	0 986 594 505 <sup>4</sup>		

**A4 Allroad [8KH]**









										
	<b>2.0 TDI</b>	04.09-06.11	120	PR-Code 1LA		0 986 134 266		←		
			125	PR-Code 1LA		0 986 135 266		→		
		04.09-01.12	120	PR-Code 1LT	S31	0 986 134 267		←	57	1 987 470 506 <sup>B</sup>
			125	PR-Code 1LT	S31	0 986 135 267		→	57	1 987 470 506 <sup>B</sup>
	09.09-06.11	100/105	PR-Code 1LA			0 986 134 266		←		
						0 986 135 266		→		
	09.09→	100/105	PR-Code 1LT		S31	0 986 134 267		←	57	1 987 470 506 <sup>B</sup>
						0 986 135 267		→	57	1 987 470 506 <sup>B</sup>
	11.11→	130/140	PR-Code 1LT		S31	0 986 134 267		←	57	1 987 470 506 <sup>B</sup>
						0 986 135 267		→	57	1 987 470 506 <sup>B</sup>
	03.12→	120	PR-Code 1LT		S31	0 986 134 267		←	57	1 987 470 506 <sup>B</sup>
						0 986 135 267		→	57	1 987 470 506 <sup>B</sup>
	05.13→	110	PR-Code 1LT		S31	0 986 134 267		←	57	1 987 470 506 <sup>B</sup>
						0 986 135 267		→	57	1 987 470 506 <sup>B</sup>
	<b>2.0 TFSI</b>	04.09-06.11	155	PR-Code 1LA			0 986 134 266		←	
							0 986 135 266		→	
04.09-05.13		155	PR-Code 1LT		S31	0 986 134 267		←	57	1 987 470 506 <sup>B</sup>
						0 986 135 267		→	57	1 987 470 506 <sup>B</sup>
05.13→	162/165	PR-Code 1LT		S31	0 986 134 267		←	57	1 987 470 506 <sup>B</sup>	
					0 986 135 267		→	57	1 987 470 506 <sup>B</sup>	
<b>2.0 TFSI flexible fuel</b>	03.12-05.13	155	PR-Code 1LT		S31	0 986 134 267		←	57	1 987 470 506 <sup>B</sup>
						0 986 135 267		→	57	1 987 470 506 <sup>B</sup>
<b>3.0 TDI</b>	04.09-06.11	176	PR-Code 1LA			0 986 134 266		←		
						0 986 135 266		→		
	04.09-01.12	176	PR-Code 1LT		S31	0 986 134 267		←	57	1 987 470 506 <sup>B</sup>
						0 986 135 267		→	57	1 987 470 506 <sup>B</sup>
	01.12→	180	PR-Code 1LT		S31	0 986 134 267		←	57	1 987 470 506 <sup>B</sup>
						0 986 135 267		→	57	1 987 470 506 <sup>B</sup>

								
	<b>2.0 TDI</b>	04.09→	100/105/110/ 120/125/130/ 140/155/162/ 165		LAB	0 265 007 928 <sup>4</sup>		
					RAB	0 265 007 930 <sup>3</sup>		
						0 265 007 928 <sup>3</sup>		
						0 265 007 930 <sup>4</sup>		



<b>◀ AUDI A4 Allroad [8KH]</b>													
	2.0 TFSI	04.09→	100/105/110/ 120/125/130/ 140/155/162/ 165		LAB	0 265 007 928 <sup>4</sup>							
					RAB	0 265 007 930 <sup>3</sup>							
	2.0 TFSI flexible fuel	03.12-05.13	100/105/110/ 120/125/130/ 140/155/162/ 165		LAB	0 265 007 928 <sup>4</sup>							
					RAB	0 265 007 930 <sup>3</sup>							
	3.0 TDI	04.09→	176/180		LAB	0 265 007 928 <sup>4</sup>							
					RAB	0 265 007 930 <sup>3</sup>							
<b>A4 Avant [8D5; B5]</b>													
	1.6	11.94-10.96	74			0 986 471 810	← 54	1 987 470 287 <sup>7</sup>					
						0 986 473 810							
						0 986 471 811	→ 54	1 987 470 287 <sup>7</sup>					
						0 986 473 811							
						10.96-02.97	74	Fg.-Nr. →8D..V..169 695		0 986 471 810	← 54	1 987 470 287 <sup>7</sup>	
										0 986 473 810			
										0 986 471 811	→ 54	1 987 470 287 <sup>7</sup>	
										0 986 473 811			
						02.97-07.99	74	Fg.-Nr. 8D..V..169 696→		0 986 474 897	← 54	1 987 470 287 <sup>7</sup>	
										0 986 474 898	→ 54	1 987 470 287 <sup>7</sup>	
						08.98-10.00	74		228	0 986 474 897	← 54	1 987 470 287 <sup>7</sup>	
										0 986 474 898	→ 54	1 987 470 287 <sup>7</sup>	
										0 986 473 070	← 56,93	1 987 470 506 <sup>8</sup>	
										0 986 474 070	→ 56,93	1 987 470 506 <sup>8</sup>	
						06.00-09.01	75		228	0 986 474 897	← 54	1 987 470 287 <sup>7</sup>	
										0 986 474 898	→ 54	1 987 470 287 <sup>7</sup>	
										0 986 473 070	← 56,93	1 987 470 506 <sup>8</sup>	
										0 986 474 070	→ 56,93	1 987 470 506 <sup>8</sup>	
						1.8	11.94-11.94	92	Fg.-Nr. →8D..S..011 333	288	0 986 473 070	← 56,93	1 987 470 005 <sup>7</sup>
											0 986 473 070	← 56,93	1 987 470 506 <sup>8</sup>
											0 986 474 070	→ 56,93	1 987 470 005 <sup>7</sup>
											0 986 473 070	← 56,93	1 987 470 506 <sup>8</sup>
											0 986 474 070	→ 56,93	1 987 470 506 <sup>8</sup>
											0 986 473 070	→ 56,93	1 987 470 506 <sup>8</sup>
1.8 1.8 quattro	11.94-10.96	92	Fg.-Nr. →8D..V..054 061	288	0 986 473 270	← 57	1 987 470 005 <sup>7</sup>						
					0 986 473 270	← 57	1 987 470 506 <sup>8</sup>						
					0 986 474 270	→ 57	1 987 470 005 <sup>7</sup>						
					0 986 473 270	← 57	1 987 470 506 <sup>8</sup>						
	07.95-10.96	85	Fg.-Nr. →8D..V..054 061		0 986 473 270	← 57	1 987 470 005 <sup>7</sup>						
					0 986 473 270	← 57	1 987 470 506 <sup>8</sup>						
	10.96-04.99	92	Fg.-Nr. 8D..V..054 062→	228	0 986 474 897	← 54	1 987 470 287 <sup>7</sup>						
					0 986 474 898	→ 54	1 987 470 287 <sup>7</sup>						
	10.96-09.01	85	Fg.-Nr. 8D..V..054 062→	228	0 986 474 897	← 54	1 987 470 287 <sup>7</sup>						
					0 986 474 898	→ 54	1 987 470 287 <sup>7</sup>						
	08.98-09.01	92		228	0 986 474 897	← 54	1 987 470 287 <sup>7</sup>						
					0 986 474 898	→ 54	1 987 470 287 <sup>7</sup>						
1.8 quattro	08.98-09.01	92		288	0 986 473 070	← 56,93	1 987 470 506 <sup>8</sup>						
					0 986 474 070	→ 56,93	1 987 470 506 <sup>8</sup>						
1.8 T	10.95-07.98	110		288	0 986 473 070	← 56,93	1 987 470 005 <sup>7</sup>						
					0 986 473 070	← 56,93	1 987 470 506 <sup>8</sup>						
	08.98-09.01	110		288	0 986 474 070	→ 56,93	1 987 470 005 <sup>7</sup>						
					0 986 473 070	← 56,93	1 987 470 506 <sup>8</sup>						











		<b>S</b>									
<b>1.8 T quattro</b>	02.96-07.97	110					0986 473 070	← 56,93	1987 470 005 <sup>7</sup>		
							0986 474 070	→ 56,93	1987 470 005 <sup>7</sup>		
	02.96-12.98	110					0986 473 070	← 56,93	1987 470 506 <sup>8</sup>		
	08.97-12.98	110					0986 474 070	→ 56,93	1987 470 506 <sup>8</sup>		
	08.98-12.98	110			288		0986 473 070	← 56,93	1987 470 506 <sup>8</sup>		
							0986 474 070	→ 56,93	1987 470 506 <sup>8</sup>		
	02.99-09.01	110			288		0986 473 070	← 56,93	1987 470 506 <sup>8</sup>		
	05.00-09.01	125					0986 474 070	→ 56,93	1987 470 506 <sup>8</sup>		
							0986 473 070	← 56,93	1987 470 005 <sup>7</sup>		
							0986 473 070	← 56,93	1987 470 506 <sup>8</sup>		
<b>1.8 T</b>	08.97-09.01	132			228	0986 474 897	← 54	1987 470 287 <sup>7</sup>			
						0986 474 898	→ 54	1987 470 287 <sup>7</sup>			
<b>1.8 T quattro</b>					288	0986 473 070	← 56,93	1987 470 506 <sup>8</sup>			
						0986 474 070	→ 56,93	1987 470 506 <sup>8</sup>			
						08.98-09.01	110	228	0986 474 897	← 54	1987 470 287 <sup>7</sup>
						0986 474 898	→ 54	1987 470 287 <sup>7</sup>			
<b>1.9 TDI</b>	01.95-07.96	66			TA	0986 471 810	← 54	1987 470 287 <sup>7</sup>			
						0986 473 810					
						0986 471 811	→ 54	1987 470 287 <sup>7</sup>			
						0986 473 811					
						TA	0986 473 270	← 57	1987 470 005 <sup>7</sup>		
							0986 473 270	← 57	1987 470 506 <sup>8</sup>		
							0986 474 270	→ 57	1987 470 005 <sup>7</sup>		
							0986 473 070	← 56,93	1987 470 506 <sup>8</sup>		
	02.96-12.98	81					0986 474 070	→ 56,93	1987 470 506 <sup>8</sup>		
	08.96-02.97	66				Fg.-Nr. →8D..V..169 695	0986 471 810	← 54	1987 470 287 <sup>7</sup>		
							0986 473 810				
							0986 471 811	→ 54	1987 470 287 <sup>7</sup>		
							0986 473 811				
	02.97-06.00	66				Fg.-Nr. 8D..V..169 696→	0986 474 897	← 54	1987 470 287 <sup>7</sup>		
	04.97-09.01	66					0986 474 898	→ 54	1987 470 287 <sup>7</sup>		
							0986 474 897	← 54	1987 470 287 <sup>7</sup>		
08.99-06.00	81			288		0986 474 898	→ 54	1987 470 287 <sup>7</sup>			
						0986 473 070	← 56,93	1987 470 506 <sup>8</sup>			
<b>1.9 TDI quattro</b>	07.96-07.99	81				0986 474 070	→ 56,93	1987 470 506 <sup>8</sup>			
						0986 473 070	← 56,93	1987 470 506 <sup>8</sup>			
08.99-01.00	81			288		0986 474 070	→ 56,93	1987 470 506 <sup>8</sup>			
						0986 473 070	← 56,93	1987 470 506 <sup>8</sup>			
<b>1.9 TDI</b>	02.96-07.97	81				0986 473 070	← 56,93	1987 470 005 <sup>7</sup>			
<b>1.9 TDI quattro</b>	08.98-09.01	85			228	0986 474 897	← 54	1987 470 287 <sup>7</sup>			
						0986 474 898	→ 54	1987 470 287 <sup>7</sup>			
						0986 473 070	← 56,93	1987 470 506 <sup>8</sup>			
	08.99-06.00	81			228		0986 474 070	→ 56,93	1987 470 506 <sup>8</sup>		
							0986 474 897	← 54	1987 470 287 <sup>7</sup>		
							0986 474 898	→ 54	1987 470 287 <sup>7</sup>		
<b>2.4</b>	08.97-09.01	120/121			228	0986 474 897	← 54	1987 470 287 <sup>7</sup>			
						0986 474 898	→ 54	1987 470 287 <sup>7</sup>			
<b>2.4 quattro</b>					288	0986 473 070	← 56,93	1987 470 506 <sup>8</sup>			
						0986 474 070	→ 56,93	1987 470 506 <sup>8</sup>			
						0986 473 070	← 56,93	1987 470 506 <sup>8</sup>			
<b>2.5 TDI</b>	11.97-09.01	110			228	0986 474 897	← 54	1987 470 287 <sup>7</sup>			
						0986 474 898	→ 54	1987 470 287 <sup>7</sup>			
<b>2.5 TDI quattro</b>					288	0986 473 070	← 56,93	1987 470 506 <sup>8</sup>			
						0986 474 070	→ 56,93	1987 470 506 <sup>8</sup>			
						0986 473 070	← 56,93	1987 470 506 <sup>8</sup>			
<b>2.6</b>	11.94-07.98	110				0986 473 070	← 56,93	1987 470 506 <sup>8</sup>			
						0986 474 070	→ 56,93	1987 470 506 <sup>8</sup>			
<b>2.6</b>	11.94-07.97	110				0986 473 070	← 56,93	1987 470 005 <sup>7</sup>			
						0986 473 070	← 56,93	1987 470 005 <sup>7</sup>			
<b>2.6 quattro</b>	01.96-07.97	102				0986 473 070	← 56,93	1987 470 005 <sup>7</sup>			
						0986 473 070	← 56,93	1987 470 506 <sup>8</sup>			
						0986 474 070	→ 56,93	1987 470 005 <sup>7</sup>			



<div style="display: flex; align-items: center;"> <span>◀ AUDI A4 Avant [8D5; B5]</span> </div>										
2.6 quattro	11.94-07.97	110				0986 474 070		→ 56,93	1987 470 005 <sup>7</sup>	
	11.94-07.98	110				0986 473 070		← 56,93	1987 470 506 <sup>8</sup>	
	08.97-07.98	110				0986 474 070		→ 56,93	1987 470 506 <sup>8</sup>	
	2.8	03.96-07.97	142				0986 473 070		← 56,93	1987 470 005 <sup>7</sup>
							0986 474 070		→ 56,93	1987 470 005 <sup>7</sup>
		03.96-07.98	142				0986 473 070		← 56,93	1987 470 506 <sup>8</sup>
		08.97-07.98	142				0986 474 070		→ 56,93	1987 470 506 <sup>8</sup>
		08.97-07.99	142		288		0986 473 070		← 56,93	1987 470 506 <sup>8</sup>
							0986 474 070		→ 56,93	1987 470 506 <sup>8</sup>
	2.8	08.97-09.01	142		228		0986 474 897		← 54	1987 470 287 <sup>7</sup>
							0986 474 898		→ 54	1987 470 287 <sup>7</sup>
	2.8 quattro	03.99-09.01	140		228		0986 474 897		← 54	1987 470 287 <sup>7</sup>
						0986 474 898		→ 54	1987 470 287 <sup>7</sup>	
				288		0986 473 070		← 56,93	1987 470 506 <sup>8</sup>	
						0986 474 070		→ 56,93	1987 470 506 <sup>8</sup>	
2.8 quattro	03.96-07.97	142				0986 473 070		← 56,93	1987 470 005 <sup>7</sup>	
						0986 474 070		→ 56,93	1987 470 005 <sup>7</sup>	
		03.96-07.98	142				0986 473 070		← 56,93	1987 470 506 <sup>8</sup>
		08.97-07.98	142				0986 474 070		→ 56,93	1987 470 506 <sup>8</sup>
		08.97-09.01	142		288		0986 473 070		← 56,93	1987 470 506 <sup>8</sup>
							0986 474 070		→ 56,93	1987 470 506 <sup>8</sup>
		08.99-09.01	142				0986 473 070		← 56,93	1987 470 005 <sup>7</sup>
							0986 473 070		← 56,93	1987 470 506 <sup>8</sup>
						0986 474 070		→ 56,93	1987 470 005 <sup>7</sup>	
						0986 474 070		→ 56,93	1987 470 506 <sup>8</sup>	
<div style="display: flex; align-items: center;"> </div>										
1.6	11.94-10.96	74				0986 471 856		← 33		
						0986 473 856				
						0986 471 857		→ 33		
						0986 473 857				
		10.96-02.97	74		Fg.-Nr. →8D..V..168 350		0986 471 856		← 33	
							0986 473 856			
							0986 471 857		→ 33	
							0986 473 857			
		02.97-07.99	74		Fg.-Nr. 8D..V..168 351→		0986 472 830		← 38	1987 470 040 <sup>7</sup>
							0986 474 830			1987 474 496 <sup>8</sup>
							0986 472 831		→ 38	1987 470 040 <sup>7</sup>
							0986 474 831			
	08.98-10.00	74				0986 472 830		← 38	1987 470 040 <sup>7</sup>	
						0986 474 830			1987 474 496 <sup>8</sup>	
						0986 472 831		→ 38	1987 470 040 <sup>7</sup>	
						0986 474 831				
	06.00-09.01	75				0986 472 830		← 38	1987 470 040 <sup>7</sup>	
						0986 474 830			1987 474 496 <sup>8</sup>	
						0986 472 831		→ 38	1987 470 040 <sup>7</sup>	
						0986 474 831				
1.8	11.94-02.97	92		Fg.-Nr. →8D..V..168 350		0986 471 856		← 33		
						0986 473 856				
						0986 471 857		→ 33		
						0986 473 857				
		07.95-02.97	85		Fg.-Nr. →8D..V..168 350		0986 471 856		← 33	
							0986 473 856			
							0986 471 857		→ 33	
							0986 473 857			
	02.97-12.98	85		Fg.-Nr. 8D..V..168 351→		0986 472 830		← 38	1987 470 040 <sup>7</sup>	
						0986 474 830			1987 474 496 <sup>8</sup>	
						0986 472 831		→ 38	1987 470 040 <sup>7</sup>	
						0986 474 831				











		S										
1.8	02.97-04.99	92	Fg.-Nr. 8D..V..168 351→				0 986 472 830	← 38	1 987 470 040 <sup>7</sup>			
							0 986 474 830	↻	1 987 474 496 <sup>8</sup>			
							0 986 472 831	→ 38	1 987 470 040 <sup>7</sup>			
							0 986 474 831	↻				
	08.98-07.99	92						0 986 472 830	← 38	1 987 470 040 <sup>7</sup>		
								0 986 474 830	↻	1 987 474 496 <sup>8</sup>		
								0 986 472 831	→ 38	1 987 470 040 <sup>7</sup>		
								0 986 474 831	↻			
	06.00-09.01	92						0 986 472 830	← 38	1 987 470 040 <sup>7</sup>		
								0 986 474 830	↻	1 987 474 496 <sup>8</sup>		
								0 986 472 831	→ 38	1 987 470 040 <sup>7</sup>		
								0 986 474 831	↻			
1.8 quattro	11.94-12.98	92	Fg.-Nr. →8D..X..199 999	INB			0 986 474 841	↻ ← 38	1 987 470 040 <sup>7</sup>			
								0 986 474 842	↻ → 38	1 987 470 040 <sup>7</sup>		
	07.95-12.98	85	Fg.-Nr. →8D..X..199 999	INB				0 986 474 841	↻ ← 38	1 987 470 040 <sup>7</sup>		
								0 986 474 842	↻ → 38	1 987 470 040 <sup>7</sup>		
	01.99-06.00	92	Fg.-Nr. 8D..X..200 001→	INB				0 986 134 068	↻ ← 43	F 026 A06 121 <sup>7</sup>		
								0 986 134 068	↻ ← 43	1 987 474 496 <sup>8</sup>		
				INB						0 986 135 068	↻ → 43	F 026 A06 121 <sup>7</sup>
										0 986 474 841	↻ ← 38	1 987 470 040 <sup>7</sup>
	01.99-09.01	85	Fg.-Nr. 8D..X..200 001→	INB				0 986 474 842	↻ → 38	1 987 470 040 <sup>7</sup>		
								0 986 134 068	↻ ← 43	F 026 A06 121 <sup>7</sup>		
				INB						0 986 134 068	↻ ← 43	1 987 474 496 <sup>8</sup>
										0 986 135 068	↻ → 43	F 026 A06 121 <sup>7</sup>
04.99-09.01	92		INB				0 986 474 841	↻ ← 38	1 987 470 040 <sup>7</sup>			
							0 986 134 068	↻ ← 43	F 026 A06 121 <sup>7</sup>			
			INB						0 986 134 068	↻ ← 43	1 987 474 496 <sup>8</sup>	
									0 986 135 068	↻ → 43	F 026 A06 121 <sup>7</sup>	
1.8 T	10.95-02.97	110	Fg.-Nr. →8D..V..168 350				0 986 471 856	← 33				
							0 986 473 856	↻				
							0 986 471 857	→ 33				
							0 986 473 857	↻				
	02.97-07.98	110	Fg.-Nr. 8D..V..168 351→					0 986 472 830	← 38	1 987 470 040 <sup>7</sup>		
									0 986 474 830	↻	1 987 474 496 <sup>8</sup>	
									0 986 472 831	→ 38	1 987 470 040 <sup>7</sup>	
									0 986 474 831	↻		
	08.97-09.01	132						0 986 472 830	← 38	1 987 470 040 <sup>7</sup>		
								0 986 474 830	↻	1 987 474 496 <sup>8</sup>		
								0 986 472 831	→ 38	1 987 470 040 <sup>7</sup>		
								0 986 474 831	↻			
08.98-09.01	110						0 986 472 830	← 38	1 987 470 040 <sup>7</sup>			
							0 986 474 830	↻	1 987 474 496 <sup>8</sup>			
							0 986 472 831	→ 38	1 987 470 040 <sup>7</sup>			
							0 986 474 831	↻				
1.8 T quattro	02.96-12.98	110					0 986 474 841	↻ ← 38	1 987 470 040 <sup>7</sup>			
								0 986 474 842	↻ → 38	1 987 470 040 <sup>7</sup>		
	08.97-12.98	132	Fg.-Nr. →8D..X..199 999	INB				0 986 474 841	↻ ← 38	1 987 470 040 <sup>7</sup>		
								0 986 474 842	↻ → 38	1 987 470 040 <sup>7</sup>		
	01.99-09.01	132	Fg.-Nr. 8D..X..200 001→	INB				0 986 134 068	↻ ← 43	F 026 A06 121 <sup>7</sup>		
								0 986 134 068	↻ ← 43	1 987 474 496 <sup>8</sup>		
				INB						0 986 135 068	↻ → 43	F 026 A06 121 <sup>7</sup>
										0 986 474 841	↻ ← 38	1 987 470 040 <sup>7</sup>
	02.99-09.01	110		INB				0 986 474 842	↻ → 38	1 987 470 040 <sup>7</sup>		
								0 986 134 068	↻ ← 43	F 026 A06 121 <sup>7</sup>		
				INB						0 986 134 068	↻ ← 43	1 987 474 496 <sup>8</sup>
										0 986 135 068	↻ → 43	F 026 A06 121 <sup>7</sup>
INB						0 986 474 841	↻ ← 38	1 987 470 040 <sup>7</sup>				
						0 986 474 842	↻ → 38	1 987 470 040 <sup>7</sup>				



			S									
◀ AUDI A4 Avant [8D5; B5]												
<b>1.8</b> T quattro	05.00-09.01	125						0986 472 830	← 38	1987 470 040 <sup>7</sup>		
								0986 474 830		1987 474 496 <sup>8</sup>		
								0986 472 831	→ 38	1987 470 040 <sup>7</sup>		
								0986 474 831				
<b>1.9</b> TDI	01.95-07.96	66						0986 471 856	← 33			
								0986 473 856				
								0986 471 857	→ 33			
								0986 473 857				
	02.96-02.97	81		Fg.-Nr. →8D..V..168 350					0986 471 856	← 33		
									0986 473 856			
									0986 471 857	→ 33		
									0986 473 857			
	08.96-02.97	66		Fg.-Nr. →8D..V..168 350					0986 471 856	← 33		
									0986 473 856			
									0986 471 857	→ 33		
									0986 473 857			
	02.97-12.98	81		Fg.-Nr. 8D..V..168 351→					0986 472 830	← 38	1987 470 040 <sup>7</sup>	
									0986 474 830		1987 474 496 <sup>8</sup>	
									0986 472 831	→ 38	1987 470 040 <sup>7</sup>	
									0986 474 831			
	02.97-06.00	66		Fg.-Nr. 8D..V..168 351→					0986 472 830	← 38	1987 470 040 <sup>7</sup>	
									0986 474 830		1987 474 496 <sup>8</sup>	
									0986 472 831	→ 38	1987 470 040 <sup>7</sup>	
									0986 474 831			
04.97-09.01	66							0986 472 830	← 38	1987 470 040 <sup>7</sup>		
								0986 474 830		1987 474 496 <sup>8</sup>		
								0986 472 831	→ 38	1987 470 040 <sup>7</sup>		
								0986 474 831				
08.98-09.01	85							0986 472 830	← 38	1987 470 040 <sup>7</sup>		
								0986 474 830		1987 474 496 <sup>8</sup>		
								0986 472 831	→ 38	1987 470 040 <sup>7</sup>		
								0986 474 831				
08.99-06.00	81							0986 472 830	← 38	1987 470 040 <sup>7</sup>		
								0986 474 830		1987 474 496 <sup>8</sup>		
								0986 472 831	→ 38	1987 470 040 <sup>7</sup>		
								0986 474 831				
<b>1.9</b> TDI quattro	07.96-12.98	81	Fg.-Nr. →8D..X..199 999			INB		0986 474 841	← 38	1987 470 040 <sup>7</sup>		
								0986 474 842	→ 38	1987 470 040 <sup>7</sup>		
								0986 474 841	← 38	1987 470 040 <sup>7</sup>		
								0986 474 842	→ 38	1987 470 040 <sup>7</sup>		
	12.98-12.98	85							0986 474 841	← 38	1987 470 040 <sup>7</sup>	
									0986 474 842	→ 38	1987 470 040 <sup>7</sup>	
									0986 134 068	← 43	F 026 A06 121 <sup>7</sup>	
									0986 134 068	← 43	1987 474 496 <sup>8</sup>	
	01.99-07.99	81		Fg.-Nr. 8D..X..200 001→			INB		0986 135 068	→ 43	F 026 A06 121 <sup>7</sup>	
									INB	0986 474 841	← 38	1987 470 040 <sup>7</sup>
									INB	0986 474 842	→ 38	1987 470 040 <sup>7</sup>
									INB	0986 134 068	← 43	F 026 A06 121 <sup>7</sup>
	08.99-01.00	81					INB		0986 134 068	← 43	F 026 A06 121 <sup>7</sup>	
									INB	0986 134 068	← 43	1987 474 496 <sup>8</sup>
									INB	0986 135 068	→ 43	F 026 A06 121 <sup>7</sup>
									INB	0986 474 841	← 38	1987 470 040 <sup>7</sup>
01.00-09.01	85					INB		0986 474 842	→ 38	1987 470 040 <sup>7</sup>		
								INB	0986 134 068	← 43	F 026 A06 121 <sup>7</sup>	
								INB	0986 134 068	← 43	1987 474 496 <sup>8</sup>	
								INB	0986 135 068	→ 43	F 026 A06 121 <sup>7</sup>	
<b>2.4</b>	08.97-09.01	121						0986 472 830	← 38	1987 470 040 <sup>7</sup>		
								0986 474 830		1987 474 496 <sup>8</sup>		
								0986 472 831	→ 38	1987 470 040 <sup>7</sup>		
								0986 474 831				
	08.98-09.01	120							0986 472 830	← 38	1987 470 040 <sup>7</sup>	
									0986 474 830		1987 474 496 <sup>8</sup>	
									0986 472 831	→ 38	1987 470 040 <sup>7</sup>	
									0986 474 831			



		S								
2.4 quattro	08.97-07.98	120					0986 474 841	← 38	1987 470 040 <sup>7</sup>	
							0986 474 842	→ 38	1987 470 040 <sup>7</sup>	
	08.97-12.98	121						0986 474 841	← 38	1987 470 040 <sup>7</sup>
								0986 474 842	→ 38	1987 470 040 <sup>7</sup>
	08.98-06.00	120			INB			0986 134 068	← 43	F 026 A06 121 <sup>7</sup>
								0986 134 068	← 43	1987 474 496 <sup>8</sup>
								0986 135 068	→ 43	F 026 A06 121 <sup>7</sup>
	08.98-09.01	121			INB			0986 134 068	← 43	F 026 A06 121 <sup>7</sup>
								0986 134 068	← 43	1987 474 496 <sup>8</sup>
								0986 135 068	→ 43	F 026 A06 121 <sup>7</sup>
01.99-06.00	120		Fg.-Nr. 8D..X..200 001→	INB			0986 474 841	← 38	1987 470 040 <sup>7</sup>	
							0986 474 842	→ 38	1987 470 040 <sup>7</sup>	
01.99-09.01	121		Fg.-Nr. 8D..X..200 001→	INB			0986 474 841	← 38	1987 470 040 <sup>7</sup>	
							0986 474 842	→ 38	1987 470 040 <sup>7</sup>	
02.99-07.99	121			INB			0986 474 841	← 38	1987 470 040 <sup>7</sup>	
							0986 474 842	→ 38	1987 470 040 <sup>7</sup>	
2.5 TDI	11.97-09.01	110					0986 472 830	← 38	1987 470 040 <sup>7</sup>	
							0986 474 830		1987 474 496 <sup>8</sup>	
							0986 472 831	→ 38	1987 470 040 <sup>7</sup>	
							0986 474 831			
2.5 TDI quattro	11.97-12.98	110	Fg.-Nr. →8D..X..199 999	INB			0986 474 841	← 38	1987 470 040 <sup>7</sup>	
							0986 474 842	→ 38	1987 470 040 <sup>7</sup>	
	07.98-07.99	110			INB			0986 134 068	← 43	F 026 A06 121 <sup>7</sup>
								0986 134 068	← 43	1987 474 496 <sup>8</sup>
								0986 135 068	→ 43	F 026 A06 121 <sup>7</sup>
	01.99-06.00	110	Fg.-Nr. 8D..X..200 001→	INB				0986 134 068	← 43	F 026 A06 121 <sup>7</sup>
								0986 134 068	← 43	1987 474 496 <sup>8</sup>
								0986 135 068	→ 43	F 026 A06 121 <sup>7</sup>
								0986 474 841	← 38	1987 470 040 <sup>7</sup>
					INB			0986 474 842	→ 38	1987 470 040 <sup>7</sup>
2.6	11.94-02.97	102/110	Fg.-Nr. →8D..V..168 350				0986 471 856	← 33		
							0986 473 856			
							0986 471 857	→ 33		
	02.97-07.98	102/110	Fg.-Nr. 8D..V..168 351→					0986 472 830	← 38	1987 470 040 <sup>7</sup>
								0986 474 830		1987 474 496 <sup>8</sup>
								0986 472 831	→ 38	1987 470 040 <sup>7</sup>
							0986 474 831			
2.6 quattro	11.94-07.98	102/110					0986 474 841	← 38	1987 470 040 <sup>7</sup>	
							0986 474 842	→ 38	1987 470 040 <sup>7</sup>	
2.8	03.96-02.97	142	Fg.-Nr. →8D..V..168 350				0986 471 856	← 33		
							0986 473 856			
							0986 471 857	→ 33		
	02.97-07.98	142	Fg.-Nr. 8D..V..168 351→					0986 472 830	← 38	1987 470 040 <sup>7</sup>
								0986 474 830		1987 474 496 <sup>8</sup>
								0986 472 831	→ 38	1987 470 040 <sup>7</sup>
								0986 474 831		
	08.97-07.99	142						0986 472 830	← 38	1987 470 040 <sup>7</sup>
								0986 474 830		1987 474 496 <sup>8</sup>
								0986 472 831	→ 38	1987 470 040 <sup>7</sup>
0986 474 831										
03.99-09.01	140						0986 472 830	← 38	1987 470 040 <sup>7</sup>	
							0986 474 830		1987 474 496 <sup>8</sup>	
							0986 472 831	→ 38	1987 470 040 <sup>7</sup>	
							0986 474 831			
2.8 quattro	03.96-07.98	142					0986 474 841	← 38	1987 470 040 <sup>7</sup>	
							0986 474 842	→ 38	1987 470 040 <sup>7</sup>	
	08.98-09.01	142			INB			0986 134 068	← 43	F 026 A06 121 <sup>7</sup>
								0986 134 068	← 43	1987 474 496 <sup>8</sup>
								0986 135 068	→ 43	F 026 A06 121 <sup>7</sup>
	01.99-06.00	142	Fg.-Nr. 8D..X..200 001→	INB				0986 474 841	← 38	1987 470 040 <sup>7</sup>
0986 474 842								→ 38	1987 470 040 <sup>7</sup>	







**AUDI A4 Avant [8D5; B5]**









2.8 quattro	02.99-09.01	142	INB	0986 474 841	← 38	1987 470 040 <sup>7</sup>
				0986 474 842	→ 38	1987 470 040 <sup>7</sup>
	08.99-09.01	142		0986 472 830	← 38	1987 470 040 <sup>7</sup>
				0986 474 830		1987 474 496 <sup>8</sup>
				0986 472 831	→ 38	1987 470 040 <sup>7</sup>
				0986 474 831		
	09.99-09.01	140	INB	0986 134 068	← 43	F 026 A06 121 <sup>7</sup>
				0986 134 068	← 43	1987 474 496 <sup>8</sup>
				0986 135 068	→ 43	F 026 A06 121 <sup>7</sup>
			INB	0986 474 841	← 38	1987 470 040 <sup>7</sup>
				0986 474 842	→ 38	1987 470 040 <sup>7</sup>

**U**

1.6	11.94-09.01	74/75		1987 477 659	↔ 1812	
1.8	11.94-07.99	85/92/110/132		1987 477 659	↔ 1812	
	06.00-09.01	85/92/110/132		1987 477 659	↔ 1812	
1.8 T	10.95-09.01	85/92/110/132		1987 477 659	↔ 1812	
1.9 TDI	01.95-09.01	66/81/85		1987 477 659	↔ 1812	
2.4	08.97-09.01	120/121		1987 477 659	↔ 1812	
2.5 TDI	11.97-09.01	110		1987 477 659	↔ 1812	
2.6	11.94-07.98	102/110		1987 477 659	↔ 1812	
2.8	03.96-09.01	140/142		1987 477 659	↔ 1812	

**A**

1.6	11.94-10.96	74		0986 594 014 <sup>3</sup>			
	11.94-10.00	74		0986 594 005 <sup>4</sup>			
	10.96-12.98	74	Fg.-Nr. →8D..X..199 999	0986 594 014 <sup>3</sup>			
	01.99-10.00	74	Fg.-Nr. 8D..X..200 001→	0986 594 002 <sup>3</sup>			
	06.00-09.01	75		0986 594 002 <sup>3</sup>			
1.8	11.94-12.98	92	Fg.-Nr. →8D..X..199 999	0986 594 014 <sup>3</sup>			
	11.94-07.99	92		0986 594 005 <sup>4</sup>			
	07.95-12.98	85		0986 594 005 <sup>4</sup>			
				0986 594 014 <sup>3</sup>			
				0986 594 002 <sup>3</sup>			
	01.99-07.99	92	Fg.-Nr. 8D..X..200 001→	0986 594 002 <sup>3</sup>			
	04.99-07.99	92		0986 594 002 <sup>3</sup>			
	06.00-09.01	92		0986 594 002 <sup>3</sup>			
				0986 594 005 <sup>4</sup>			
	1.8 quattro	11.94-12.98	92	Fg.-Nr. →8D..X..199 999	0986 594 014 <sup>3</sup>		
07.95-12.98		85	Fg.-Nr. →8D..X..199 999	0986 594 014 <sup>3</sup>			
06.98-04.99		92	Fg.-Nr. 8D..W..280 001→	ALR,LAB	0 265 006 571 <sup>4</sup>		
				ALR,RAB	0 265 006 569 <sup>4</sup>		
				ALR	0 265 006 569 <sup>4</sup>		
06.98-09.01		85	Fg.-Nr. 8D..W..280 001→	ALR,LAB	0 265 006 571 <sup>4</sup>		
				ALR,RAB	0 265 006 569 <sup>4</sup>		
				ALR	0 265 006 569 <sup>4</sup>		
08.98-09.01		92		ALR,LAB	0 265 006 571 <sup>4</sup>		
				ALR,RAB	0 265 006 569 <sup>4</sup>		
				ALR	0 265 006 569 <sup>4</sup>		
01.99-06.00		92	Fg.-Nr. 8D..X..200 001→	SCK	0 265 006 578 <sup>3</sup>		
				STK	0986 594 002 <sup>3</sup>		
01.99-09.01		85	Fg.-Nr. 8D..X..200 001→	SCK	0 265 006 578 <sup>3</sup>		
	STK			0986 594 002 <sup>3</sup>			
	SCK			0 265 006 578 <sup>3</sup>			
04.99-09.01	92		STK	0986 594 002 <sup>3</sup>			
1.8 T	10.95-07.98	110		0986 594 014 <sup>3</sup>			
	10.95-09.01	110		0986 594 005 <sup>4</sup>			
	08.97-12.98	132	Fg.-Nr. →8D..X..199 999	0986 594 014 <sup>3</sup>			
	08.97-09.01	132		0986 594 005 <sup>4</sup>			
	08.98-12.98	110	Fg.-Nr. →8D..X..199 999	0986 594 014 <sup>3</sup>			
	01.99-09.01	110	Fg.-Nr. 8D..X..200 001→		0986 594 002 <sup>3</sup>		
				0986 594 002 <sup>3</sup>			

									
<b>1.8 T</b>	05.99-07.99	110					0 986 594 002 <sup>3</sup>		
	06.00-09.01	110					0 986 594 002 <sup>3</sup>		
<b>1.8 T quattro</b>	02.96-12.98	110					0 986 594 014 <sup>3</sup>		
	08.97-12.98	132	Fg.-Nr. →8D..X..199 999				0 986 594 014 <sup>3</sup>		
	06.98-12.98	110	Fg.-Nr. 8D..W..280 001→		ALR,LAB	0 265 006 571 <sup>4</sup>			
					ALR,RAB	0 265 006 569 <sup>4</sup>			
					ALR	0 265 006 569 <sup>4</sup>			
	06.98-09.01	132	Fg.-Nr. 8D..W..280 001→		ALR,LAB	0 265 006 571 <sup>4</sup>			
					ALR,RAB	0 265 006 569 <sup>4</sup>			
					ALR	0 265 006 569 <sup>4</sup>			
	08.98-12.98	110			ALR,LAB	0 265 006 571 <sup>4</sup>			
					ALR,RAB	0 265 006 569 <sup>4</sup>			
					ALR	0 265 006 569 <sup>4</sup>			
	01.99-09.01	132	Fg.-Nr. 8D..X..200 001→		SCK	0 265 006 578 <sup>3</sup>			
					STK	0 986 594 002 <sup>3</sup>			
	02.99-09.01	110			ALR,LAB	0 265 006 571 <sup>4</sup>			
				ALR,RAB	0 265 006 569 <sup>4</sup>				
				ALR	0 265 006 569 <sup>4</sup>				
				SCK	0 265 006 578 <sup>3</sup>				
05.00-09.01	125			STK	0 986 594 002 <sup>3</sup>				
					0 986 594 002 <sup>3</sup>				
<b>1.9 TDI</b>	01.95-09.01	66					0 986 594 005 <sup>4</sup>		
							0 986 594 014 <sup>3</sup>		
	02.96-12.98	81					0 986 594 005 <sup>4</sup>		
							0 986 594 014 <sup>3</sup>		
	08.98-12.98	85	Fg.-Nr. →8D..X..199 999				0 986 594 014 <sup>3</sup>		
	08.98-09.01	85					0 986 594 005 <sup>4</sup>		
	01.99-09.01	85	Fg.-Nr. 8D..X..200 001→				0 986 594 002 <sup>3</sup>		
	08.99-06.00	81					0 986 594 002 <sup>3</sup>		
						0 986 594 005 <sup>4</sup>			
<b>1.9 TDI quattro</b>	07.96-12.98	81	Fg.-Nr. →8D..X..199 999				0 986 594 014 <sup>3</sup>		
	06.98-07.99	81	Fg.-Nr. 8D..W..280 001→		ALR,LAB	0 265 006 571 <sup>4</sup>			
					ALR,RAB	0 265 006 569 <sup>4</sup>			
					ALR	0 265 006 569 <sup>4</sup>			
	12.98-12.98	85					0 986 594 014 <sup>3</sup>		
					ALR,LAB	0 265 006 571 <sup>4</sup>			
					ALR,RAB	0 265 006 569 <sup>4</sup>			
					ALR	0 265 006 569 <sup>4</sup>			
					SCK	0 265 006 578 <sup>3</sup>			
					STK	0 986 594 002 <sup>3</sup>			
	08.99-01.00	81			ALR,LAB	0 265 006 571 <sup>4</sup>			
					ALR,RAB	0 265 006 569 <sup>4</sup>			
					ALR	0 265 006 569 <sup>4</sup>			
					SCK	0 265 006 578 <sup>3</sup>			
				STK	0 986 594 002 <sup>3</sup>				
01.00-09.01	85			ALR,LAB	0 265 006 571 <sup>4</sup>				
				ALR,RAB	0 265 006 569 <sup>4</sup>				
				ALR	0 265 006 569 <sup>4</sup>				
				SCK	0 265 006 578 <sup>3</sup>				
				STK	0 986 594 002 <sup>3</sup>				
<b>2.4</b>	08.97-07.98	121					0 986 594 014 <sup>3</sup>		
	08.97-09.01	121					0 986 594 005 <sup>4</sup>		
	08.98-12.98	120	Fg.-Nr. →8D..X..199 999				0 986 594 014 <sup>3</sup>		
					Fg.-Nr. →8D..X..199 999		0 986 594 014 <sup>3</sup>		
	08.98-09.01	120					0 986 594 005 <sup>4</sup>		
	01.99-06.00	120	Fg.-Nr. 8D..X..200 001→				0 986 594 002 <sup>3</sup>		
	01.99-09.01	121	Fg.-Nr. 8D..X..200 001→				0 986 594 002 <sup>3</sup>		
06.00-09.01	120					0 986 594 002 <sup>3</sup>			
<b>2.4 quattro</b>	08.97-07.98	120					0 986 594 014 <sup>3</sup>		
	08.97-12.98	121					0 986 594 014 <sup>3</sup>		





**AUDI A4 Avant [8D5; B5]**

<b>2.4 quattro</b>	06.98-07.98	120	Fg.-Nr. 8D..W..280 001→	ALR,LAB	0 265 <b>006 571</b> <sup>4</sup>			
				ALR,RAB	0 265 <b>006 569</b> <sup>4</sup>			
				ALR	0 265 <b>006 569</b> <sup>4</sup>			
		121	Fg.-Nr. 8D..W..280 001→	ALR,LAB	0 265 <b>006 571</b> <sup>4</sup>			
				ALR,RAB	0 265 <b>006 569</b> <sup>4</sup>			
				ALR	0 265 <b>006 569</b> <sup>4</sup>			
	08.98-12.98	120	Fg.-Nr. →8D..X..199 999		0 986 <b>594 014</b> <sup>3</sup>			
	08.98-06.00	120		ALR,LAB	0 265 <b>006 571</b> <sup>4</sup>			
				ALR,RAB	0 265 <b>006 569</b> <sup>4</sup>			
				ALR	0 265 <b>006 569</b> <sup>4</sup>			
	08.98-09.01	121		ALR,LAB	0 265 <b>006 571</b> <sup>4</sup>			
				ALR,RAB	0 265 <b>006 569</b> <sup>4</sup>			
				ALR	0 265 <b>006 569</b> <sup>4</sup>			
	01.99-06.00	120	Fg.-Nr. 8D..X..200 001→	SCK	0 265 <b>006 578</b> <sup>3</sup>			
				STK	0 986 <b>594 002</b> <sup>3</sup>			
	01.99-09.01	121	Fg.-Nr. 8D..X..200 001→	SCK	0 265 <b>006 578</b> <sup>3</sup>			
				STK	0 986 <b>594 002</b> <sup>3</sup>			
	02.99-07.99	121		SCK	0 265 <b>006 578</b> <sup>3</sup>			
				STK	0 986 <b>594 002</b> <sup>3</sup>			
<b>2.5 TDI</b>	11.97-12.98	110	Fg.-Nr. →8D..X..199 999		0 986 <b>594 014</b> <sup>3</sup>			
					0 986 <b>594 005</b> <sup>4</sup>			
					0 986 <b>594 002</b> <sup>3</sup>			
<b>2.5 TDI quattro</b>	11.97-12.98	110	Fg.-Nr. →8D..X..199 999		0 986 <b>594 014</b> <sup>3</sup>			
				06.98-06.00	110	Fg.-Nr. 8D..W..280 001→	ALR,LAB	0 265 <b>006 571</b> <sup>4</sup>
							ALR,RAB	0 265 <b>006 569</b> <sup>4</sup>
				ALR	0 265 <b>006 569</b> <sup>4</sup>			
	07.98-07.99	110		ALR,LAB	0 265 <b>006 571</b> <sup>4</sup>			
				ALR,RAB	0 265 <b>006 569</b> <sup>4</sup>			
				ALR	0 265 <b>006 569</b> <sup>4</sup>			
	01.99-06.00	110	Fg.-Nr. 8D..X..200 001→	SCK	0 265 <b>006 578</b> <sup>3</sup>			
				STK	0 986 <b>594 002</b> <sup>3</sup>			
<b>2.6</b>	11.94-07.98	110			0 986 <b>594 005</b> <sup>4</sup>			
					0 986 <b>594 014</b> <sup>3</sup>			
					0 986 <b>594 005</b> <sup>4</sup>			
<b>2.6 quattro</b>	11.94-07.98	110			0 986 <b>594 014</b> <sup>3</sup>			
				01.96-07.97	102			0 986 <b>594 014</b> <sup>3</sup>
								0 986 <b>594 014</b> <sup>3</sup>
	06.98-07.98	110	Fg.-Nr. 8D..W..280 001→	ALR,LAB	0 265 <b>006 571</b> <sup>4</sup>			
				ALR,RAB	0 265 <b>006 569</b> <sup>4</sup>			
				ALR	0 265 <b>006 569</b> <sup>4</sup>			
<b>2.8</b>	01.99-08.99	142	Fg.-Nr. 8D..X..200 001→		0 986 <b>594 002</b> <sup>3</sup>			
				03.99-09.01	140			0 986 <b>594 002</b> <sup>3</sup>
								0 986 <b>594 005</b> <sup>4</sup>
<b>2.8 quattro</b>	03.96-07.98	142			0 986 <b>594 014</b> <sup>3</sup>			
				03.96-09.01	142			0 986 <b>594 005</b> <sup>4</sup>
								0 986 <b>594 014</b> <sup>3</sup>
<b>2.8 quattro</b>	06.98-07.98	142	Fg.-Nr. 8D..W..280 001→	ALR,LAB	0 265 <b>006 571</b> <sup>4</sup>			
				ALR,RAB	0 265 <b>006 569</b> <sup>4</sup>			
				ALR	0 265 <b>006 569</b> <sup>4</sup>			
	08.98-09.01	142			ALR,LAB	0 265 <b>006 571</b> <sup>4</sup>		
					ALR,RAB	0 265 <b>006 569</b> <sup>4</sup>		
					ALR	0 265 <b>006 569</b> <sup>4</sup>		
	01.99-06.00	142	Fg.-Nr. 8D..X..200 001→		SCK	0 265 <b>006 578</b> <sup>3</sup>		
					STK	0 986 <b>594 002</b> <sup>3</sup>		
					02.99-09.01	142		
	STK	0 986 <b>594 002</b> <sup>3</sup>						
	08.99-09.01	142						
					09.99-09.01	140		ALR,LAB
ALR,RAB								0 265 <b>006 569</b> <sup>4</sup>
				ALR	0 265 <b>006 569</b> <sup>4</sup>			
				SCK	0 265 <b>006 578</b> <sup>3</sup>			
				STK	0 986 <b>594 002</b> <sup>3</sup>			

















<b>◀ AUDI A4 Avant [8ED; B7]</b>									
	2.0 TDI 2.0 TDI quattro	06.06-06.08	120	PR-Code 1LT, PR-Code 1LF	312	0986 473 070	← 56,93	1987 470 005 <sup>7</sup>	
						0986 473 070	← 56,93	1987 470 506 <sup>8</sup>	
						0986 474 070	→ 56,93	1987 470 005 <sup>7</sup>	
	2.0 TFSI	11.04-06.08	147	PR-Code 1LA, PR-Code 1LC	PR-Code 1LB, PR-Code 1LE	288	0986 473 070	← 56,93	1987 470 005 <sup>7</sup>
							0986 473 070	← 56,93	1987 470 506 <sup>8</sup>
							0986 474 070	→ 56,93	1987 470 005 <sup>7</sup>
							0986 473 070	← 56,93	1987 470 005 <sup>7</sup>
							0986 473 070	← 56,93	1987 470 506 <sup>8</sup>
							0986 474 070	→ 56,93	1987 470 005 <sup>7</sup>
	2.0 TFSI quattro	11.04-06.08	147	PR-Code 1LA, PR-Code 1LC	PR-Code 1LT, PR-Code 1LF	312	0986 473 070	← 56,93	1987 470 005 <sup>7</sup>
							0986 473 070	← 56,93	1987 470 506 <sup>8</sup>
							0986 474 070	→ 56,93	1987 470 005 <sup>7</sup>
0986 473 070							← 56,93	1987 470 506 <sup>8</sup>	
0986 473 070							← 56,93	1987 470 005 <sup>7</sup>	
0986 474 070							→ 56,93	1987 470 005 <sup>7</sup>	
2.0 TFSI quattro	11.04-06.08	147	PR-Code 1LA, PR-Code 1LC	PR-Code 1LT, PR-Code 1LF	312	0986 473 070	← 56,93	1987 470 005 <sup>7</sup>	
						0986 473 070	← 56,93	1987 470 506 <sup>8</sup>	
						0986 474 070	→ 56,93	1987 470 005 <sup>7</sup>	
						0986 473 070	← 56,93	1987 470 506 <sup>8</sup>	
						0986 473 070	← 56,93	1987 470 005 <sup>7</sup>	
						0986 474 070	→ 56,93	1987 470 005 <sup>7</sup>	
2.5 TDI	11.04-05.06	120	PR-Code 1LA, PR-Code 1LC	PR-Code 1LB, PR-Code 1LE	288	0986 473 229	← 60		
						0986 473 229	← 60		
						0986 474 229	→ 60		
						0986 473 229	← 60		
						0986 473 229	← 60		
						0986 474 229	→ 60		
2.7 TDI	11.05-06.08	120/132	PR-Code 1LA, PR-Code 1LC	PR-Code 1LB, PR-Code 1LE	288	0986 473 229	← 60		
						0986 473 229	← 60		
						0986 474 229	→ 60		
						0986 473 070	← 56,93	1987 470 005 <sup>7</sup>	
						0986 473 070	← 56,93	1987 470 506 <sup>8</sup>	
						0986 474 070	→ 56,93	1987 470 005 <sup>7</sup>	
3.0, quattro, TDI quattro	11.04-06.08	150/160/ 171	PR-Code 1LA, PR-Code 1LC	PR-Code 1LT, PR-Code 1LF	312	0986 473 070	← 56,93	1987 470 005 <sup>7</sup>	
						0986 473 070	← 56,93	1987 470 506 <sup>8</sup>	
						0986 474 070	→ 56,93	1987 470 005 <sup>7</sup>	
						0986 473 070	← 56,93	1987 470 506 <sup>8</sup>	
						0986 473 070	← 56,93	1987 470 005 <sup>7</sup>	
						0986 474 070	→ 56,93	1987 470 005 <sup>7</sup>	
3.2 FSI 3.2 FSI quattro	01.05-06.08	188	PR-Code 1LA, PR-Code 1LC	PR-Code 1LT, PR-Code 1LF	312	0986 473 229	← 60		
						0986 474 229	→ 60		
	1.6	11.04-06.08	75		212,245	0986 473 109	← 38,1	1987 470 040 <sup>7</sup>	
						0986 473 109	← 38,1	1987 474 496 <sup>8</sup>	
						0986 474 109	→ 38,1	1987 470 040 <sup>7</sup>	
	1.8 T 1.8 T quattro	11.04-06.08	120			212	0986 473 109	← 38,1	1987 470 040 <sup>7</sup>
							0986 473 109	← 38,1	1987 474 496 <sup>8</sup>
	1.9 TDI	11.04-06.08	85			212,245	0986 474 109	→ 38,1	1987 470 040 <sup>7</sup>
							0986 473 109	← 38,1	1987 474 496 <sup>8</sup>
							0986 474 109	→ 38,1	1987 470 040 <sup>7</sup>
	2.0 2.0 TDI 2.0 TDI quattro	11.04-06.08	89/93/96/ 100/103			212,245	0986 473 109	← 38,1	1987 470 040 <sup>7</sup>
							0986 473 109	← 38,1	1987 474 496 <sup>8</sup>
							0986 474 109	→ 38,1	1987 470 040 <sup>7</sup>

	S							
2.0 TDI 2.0 TDI quattro	06.06-06.08	120			212	0 986 473 109	← 38,1	1 987 470 040 <sup>7</sup>
						0 986 474 109	→ 38,1	1 987 470 040 <sup>7</sup>
						0 986 474 109	→ 38,1	1 987 474 496 <sup>8</sup>
2.0 TDI 2.0 TDI quattro	06.06-06.08	125			212	0 986 473 109	← 38,1	1 987 470 040 <sup>7</sup>
						0 986 473 109	← 38,1	1 987 474 496 <sup>8</sup>
						0 986 474 109	→ 38,1	1 987 470 040 <sup>7</sup>
2.0 TFSI 2.5 TDI	11.04-05.06	120			212	0 986 473 109	← 38,1	1 987 470 040 <sup>7</sup>
						0 986 473 109	← 38,1	1 987 474 496 <sup>8</sup>
						0 986 474 109	→ 38,1	1 987 470 040 <sup>7</sup>
2.7 TDI	11.05-06.08	120			212	0 986 473 109	← 38,1	1 987 470 040 <sup>7</sup>
						0 986 473 109	← 38,1	1 987 474 496 <sup>8</sup>
						0 986 474 109	→ 38,1	1 987 470 040 <sup>7</sup>
	11.04-06.08	75				1 987 477 922	← 1928	
						1 987 477 923	→ 2005	
						1 987 477 922	← 1928	
1.8 T	11.04-06.08	120				1 987 477 922	← 1928	
						1 987 477 923	→ 2005	
1.8 T quattro	11.04-06.08	120				1 987 477 257	↔ 1736	
1.9 TDI	11.04-06.08	85				1 987 477 922	← 1928	
						1 987 477 923	→ 2005	
2.0 2.0 TDI	11.04-06.08	89/93/96/ 100				1 987 477 922	← 1928	
						1 987 477 923	→ 2005	
2.0 TDI quattro	01.06-06.08	103/120/125/147/162				1 987 477 257	↔ 1736	
2.0 TDI	11.04-06.08	103/120/125/147/162				1 987 477 922	← 1928	
2.0 TFSI						1 987 477 923	→ 2005	
2.0 TFSI quattro	11.04-06.08	103/120/125/147/162				1 987 477 257	↔ 1736	
2.5 TDI	11.04-05.06	120				1 987 477 922	← 1928	
						1 987 477 923	→ 2005	
2.7 TDI	11.05-06.08	120/132				1 987 477 922	← 1928	
						1 987 477 923	→ 2005	
3.0	11.04-05.06	160				1 987 477 922	← 1928	
						1 987 477 923	→ 2005	
3.0 quattro	11.04-05.06	160				1 987 477 257	↔ 1736	
3.0 TDI quattro	01.05-05.06	150				1 987 477 257	↔ 1736	
						01.06-06.08	171	1 987 477 257
3.2 FSI	01.05-06.08	188				1 987 477 922	← 1928	
						1 987 477 923	→ 2005	
3.2 FSI quattro	01.05-06.08	188				1 987 477 257	↔ 1736	
	11.04-06.08	75				0 265 006 809 <sup>3</sup>		
						ALR,LAB	0 265 006 828 <sup>4</sup>	
						ALR,RAB	0 265 006 824 <sup>4</sup>	
						ALR	0 265 006 824 <sup>4</sup>	
1.8 T 1.8 T quattro	11.04-06.08	120				0 265 006 809 <sup>3</sup>		
						ALR,LAB	0 265 006 828 <sup>4</sup>	
						ALR,RAB	0 265 006 824 <sup>4</sup>	
						ALR	0 265 006 824 <sup>4</sup>	
1.9 TDI	11.04-06.08	85				0 265 006 809 <sup>3</sup>		
						ALR,LAB	0 265 006 828 <sup>4</sup>	
						ALR,RAB	0 265 006 824 <sup>4</sup>	
						ALR	0 265 006 824 <sup>4</sup>	
2.0, TDI, TDI quattro, TFSI, TFSI quattro	11.04-06.08	89/93/96/ 100/103/ 120/125/ 147/162				0 265 006 809 <sup>3</sup>		
						ALR,LAB	0 265 006 828 <sup>4</sup>	
						ALR,RAB	0 265 006 824 <sup>4</sup>	
						ALR	0 265 006 824 <sup>4</sup>	
2.5 TDI	11.04-05.06	120				0 265 006 809 <sup>3</sup>		
						ALR,LAB	0 265 006 828 <sup>4</sup>	
						ALR,RAB	0 265 006 824 <sup>4</sup>	
						ALR	0 265 006 824 <sup>4</sup>	













		S										
2.5 TDI 2.5 TDI quattro		09.01-12.04	114/120/	132		288	0986 473 070	← 56,93	1987 470 506 <sup>B</sup>			
			312				0986 474 070	→ 56,93	1987 470 506 <sup>B</sup>			
							0986 473 070	← 56,93	1987 470 005 <sup>7</sup>			
							0986 473 070	← 56,93	1987 470 506 <sup>B</sup>			
3.0 3.0 quattro		09.01-12.04	160/162		228	0986 474 897	← 54	1987 470 287 <sup>7</sup>				
						0986 474 898	→ 54	1987 470 287 <sup>7</sup>				
						0986 473 070	← 56,93	1987 470 506 <sup>B</sup>				
						0986 474 070	→ 56,93	1987 470 506 <sup>B</sup>				
			288			0986 473 070	← 56,93	1987 470 005 <sup>7</sup>				
			312			0986 473 070	← 56,93	1987 470 506 <sup>B</sup>				
						0986 473 070	← 56,93	1987 470 506 <sup>B</sup>				
						0986 474 070	→ 56,93	1987 470 005 <sup>7</sup>				
												
	1.6	09.01-12.04	75				0986 473 109	← 38,1	1987 470 040 <sup>7</sup>			
							0986 473 109	← 38,1	1987 474 496 <sup>B</sup>			
							0986 474 109	→ 38,1	1987 470 040 <sup>7</sup>			
1.8 T 1.8 T quattro	09.01-12.04	110/120/	125/140				0986 473 109	← 38,1	1987 470 040 <sup>7</sup>			
							0986 473 109	← 38,1	1987 474 496 <sup>B</sup>			
							0986 474 109	→ 38,1	1987 470 040 <sup>7</sup>			
1.9 TDI 1.9 TDI quattro	09.01-12.04	74/85/96					0986 473 109	← 38,1	1987 470 040 <sup>7</sup>			
							0986 473 109	← 38,1	1987 474 496 <sup>B</sup>			
							0986 474 109	→ 38,1	1987 470 040 <sup>7</sup>			
2.0 2.0 FSI	09.01-12.04	96/110					0986 473 109	← 38,1	1987 470 040 <sup>7</sup>			
							0986 473 109	← 38,1	1987 474 496 <sup>B</sup>			
							0986 474 109	→ 38,1	1987 470 040 <sup>7</sup>			
2.4	09.01-12.04	120/125					0986 473 109	← 38,1	1987 470 040 <sup>7</sup>			
							0986 473 109	← 38,1	1987 474 496 <sup>B</sup>			
							0986 474 109	→ 38,1	1987 470 040 <sup>7</sup>			
2.5 TDI	09.01-12.04	114/120					0986 473 109	← 38,1	1987 470 040 <sup>7</sup>			
							0986 473 109	← 38,1	1987 474 496 <sup>B</sup>			
							0986 474 109	→ 38,1	1987 470 040 <sup>7</sup>			
2.5 TDI quattro	09.01-12.04	132					0986 473 109	← 38,1	1987 470 040 <sup>7</sup>			
							0986 473 109	← 38,1	1987 474 496 <sup>B</sup>			
							0986 474 109	→ 38,1	1987 470 040 <sup>7</sup>			
							0986 473 109	→ 38,1	1987 474 496 <sup>B</sup>			
							11.02-12.04	132	0986 474 109	→ 38,1	1987 474 496 <sup>B</sup>	
3.0 3.0 quattro	09.01-12.04	160/162					0986 473 109	← 38,1	1987 470 040 <sup>7</sup>			
							0986 473 109	← 38,1	1987 474 496 <sup>B</sup>			
							0986 474 109	→ 38,1	1987 470 040 <sup>7</sup>			
												
	1.6	09.01-12.04	75				1987 477 922	← 1928				
							1987 477 923	→ 2005				
	1.8 T	09.01-06.02	110					1987 477 922	← 1928			
								1987 477 923	→ 2005			
			07.02-12.04					120	1987 477 922	← 1928		
								1987 477 923	→ 2005			
		11.02-12.04	140	1987 477 922	← 1928							
				1987 477 923	→ 2005							
	1.8 T quattro	09.01-06.02	110					SSZ	1987 477 259	1727		
			09.01-12.04					125	SSZ	1987 477 259	1727	
			07.02-05.03					120	Fg.-Nr. →8E..3..500 000	SSZ	1987 477 259	1727
			07.02-12.04					120		SSZ	1987 477 259	1727
			11.02-05.03					140	Fg.-Nr. →8E..3..500 000	SSZ	1987 477 259	1727
			11.02-12.04					140		SSZ	1987 477 259	1727
	1.9 TDI	09.01-12.04	74/85					1987 477 922	← 1928			
			1987 477 923					→ 2005				
			96					1987 477 922	← 1928			
								1987 477 923	→ 2005			
1.9 TDI quattro	09.01-05.03	96					Fg.-Nr. →8E..3..500 000	SSZ	1987 477 259	1727		
		09.01-12.04					96	SSZ	1987 477 259	1727		





◀ AUDI A4 Avant [8E5; B6]										
2.0	09.01-12.04	96/110				1987 477 922	←	1928		
2.0 FSI						1987 477 923	→	2005		
2.4	09.01-12.04	120/125				1987 477 922	←	1928		
						1987 477 923	→	2005		
2.5 TDI	09.01-12.04	114/120				1987 477 922	←	1928		
						1987 477 923	→	2005		
2.5 TDI quattro	09.01-12.04	132			SSZ	1987 477 259		1727		
	11.02-05.03	132	Fg.-Nr. →8E..3..500 000		SSZ	1987 477 259		1727		
3.0	09.01-12.04	160/162				1987 477 922	←	1928		
						1987 477 923	→	2005		
3.0 quattro	09.01-05.03	160/162	Fg.-Nr. →8E..3..500 000		SSZ	1987 477 259		1727		
	09.01-12.04	160/162			SSZ	1987 477 259		1727		
<hr/>										
1.6	09.01-05.03	75	Fg.-Nr. →8E..3..500 000			0 265 006 683 <sup>3</sup>				
	09.01-05.04	75	Fg.-Nr. →8E..4..050 000	ALR,LAB		0 265 006 707 <sup>4</sup>				
				Fg.-Nr. →8E..4..400 000	ALR,RAB		0 265 006 681 <sup>4</sup>			
					ALR		0 265 006 681 <sup>4</sup>			
	06.03-12.04	75	Fg.-Nr. 8E..4..000 001→			0 265 006 809 <sup>3</sup>				
	06.04-12.04	75	Fg.-Nr. 8E..5..000 001→	ALR,LAB		0 265 006 826 <sup>4</sup>				
					ALR,RAB		0 265 006 824 <sup>4</sup>			
					ALR		0 265 006 824 <sup>4</sup>			
	1.8 T quattro	09.01-12.04	125				0 265 006 683 <sup>3</sup>			
							0 265 006 707 <sup>4</sup>			
						0 265 006 681 <sup>4</sup>				
						0 265 006 681 <sup>4</sup>				
1.8 T	09.01-06.02	110				0 265 006 683 <sup>3</sup>				
1.8 T quattro						0 265 006 707 <sup>4</sup>				
						0 265 006 681 <sup>4</sup>				
						0 265 006 681 <sup>4</sup>				
	07.02-05.03	120	Fg.-Nr. →8E..3..500 000			0 265 006 683 <sup>3</sup>				
	07.02-05.04	120	Fg.-Nr. →8E..4..050 000	ALR,LAB		0 265 006 707 <sup>4</sup>				
			Fg.-Nr. →8E..4..400 000	ALR,RAB		0 265 006 681 <sup>4</sup>				
				ALR		0 265 006 681 <sup>4</sup>				
	11.02-05.03	140	Fg.-Nr. →8E..3..500 000			0 265 006 683 <sup>3</sup>				
	11.02-05.04	140	Fg.-Nr. →8E..4..050 000	ALR,LAB		0 265 006 707 <sup>4</sup>				
			Fg.-Nr. →8E..4..400 000	ALR,RAB		0 265 006 681 <sup>4</sup>				
				ALR		0 265 006 681 <sup>4</sup>				
	06.03-12.04	120	Fg.-Nr. 8E..4..000 001→			0 265 006 809 <sup>3</sup>				
		140	Fg.-Nr. 8E..4..000 001→			0 265 006 809 <sup>3</sup>				
	06.04-12.04	120	Fg.-Nr. 8E..5..000 001→	ALR,LAB		0 265 006 826 <sup>4</sup>				
				ALR,RAB		0 265 006 824 <sup>4</sup>				
				ALR		0 265 006 824 <sup>4</sup>				
		140	Fg.-Nr. 8E..5..000 001→	ALR,LAB		0 265 006 826 <sup>4</sup>				
				ALR,RAB		0 265 006 824 <sup>4</sup>				
				ALR		0 265 006 824 <sup>4</sup>				
1.9 TDI	09.01-05.03	74	Fg.-Nr. →8E..3..500 000			0 265 006 683 <sup>3</sup>				
	09.01-06.03	96				0 265 006 683 <sup>3</sup>				
						0 265 006 707 <sup>4</sup>				
						0 265 006 681 <sup>4</sup>				
						0 265 006 681 <sup>4</sup>				
	09.01-05.04	74				0 265 006 707 <sup>4</sup>				
						0 265 006 681 <sup>4</sup>				
						0 265 006 681 <sup>4</sup>				
		96	Fg.-Nr. →8E..4..050 000	ALR,LAB		0 265 006 707 <sup>4</sup>				
			Fg.-Nr. →8E..4..400 000	ALR,RAB		0 265 006 681 <sup>4</sup>				
				ALR		0 265 006 681 <sup>4</sup>				
	06.03-05.04	74	Fg.-Nr. 8E..4..000 001→			0 265 006 809 <sup>3</sup>				
	06.04-12.04	85				0 265 006 809 <sup>3</sup>				
						0 265 006 826 <sup>4</sup>				
						0 265 006 824 <sup>4</sup>				
						0 265 006 824 <sup>4</sup>				



									
<b>1.9 TDI quattro</b>	09.01-05.03	96	Fg.-Nr. →8E..3..500 000				0 265 006 683 <sup>3</sup>		
	09.01-05.04	96	Fg.-Nr. →8E..4..050 000	ALR,LAB			0 265 006 707 <sup>4</sup>		
			Fg.-Nr. →8E..4..400 000	ALR,RAB			0 265 006 681 <sup>4</sup>		
				ALR			0 265 006 681 <sup>4</sup>		
<b>1.9 TDI</b>	06.03-12.04	96	Fg.-Nr. 8E..4..000 001→				0 265 006 809 <sup>3</sup>		
<b>1.9 TDI quattro</b>	06.04-12.04	96	Fg.-Nr. 8E..5..000 001→	ALR,LAB			0 265 006 826 <sup>4</sup>		
				ALR,RAB			0 265 006 824 <sup>4</sup>		
				ALR			0 265 006 824 <sup>4</sup>		
<b>2.0</b>	09.01-05.03	96/110	Fg.-Nr. →8E..3..500 000				0 265 006 683 <sup>3</sup>		
	09.01-05.04	96/110	Fg.-Nr. →8E..4..050 000	ALR,LAB			0 265 006 707 <sup>4</sup>		
			Fg.-Nr. →8E..4..400 000	ALR,RAB			0 265 006 681 <sup>4</sup>		
				ALR			0 265 006 681 <sup>4</sup>		
	06.03-12.04	96/110	Fg.-Nr. 8E..4..000 001→				0 265 006 809 <sup>3</sup>		
	06.04-12.04	96/110	Fg.-Nr. 8E..5..000 001→	ALR,LAB			0 265 006 826 <sup>4</sup>		
ALR,RAB						0 265 006 824 <sup>4</sup>			
ALR						0 265 006 824 <sup>4</sup>			
<b>2.4</b>	09.01-05.03	120/125	Fg.-Nr. →8E..3..500 000				0 265 006 683 <sup>3</sup>		
	09.01-05.04	120/125	Fg.-Nr. →8E..4..050 000	ALR,LAB			0 265 006 707 <sup>4</sup>		
			Fg.-Nr. →8E..4..400 000	ALR,RAB			0 265 006 681 <sup>4</sup>		
				ALR			0 265 006 681 <sup>4</sup>		
	06.03-12.04	120/125	Fg.-Nr. 8E..4..000 001→				0 265 006 809 <sup>3</sup>		
	06.04-12.04	120/125	Fg.-Nr. 8E..5..000 001→	ALR,LAB			0 265 006 826 <sup>4</sup>		
ALR,RAB						0 265 006 824 <sup>4</sup>			
ALR						0 265 006 824 <sup>4</sup>			
<b>2.5 TDI</b>	09.01-06.02	114					0 265 006 683 <sup>3</sup>		
				ALR,LAB			0 265 006 707 <sup>4</sup>		
				ALR,RAB			0 265 006 681 <sup>4</sup>		
				ALR			0 265 006 681 <sup>4</sup>		
	07.02-05.03	120					0 265 006 683 <sup>3</sup>		
ALR,LAB						0 265 006 707 <sup>4</sup>			
ALR,RAB						0 265 006 681 <sup>4</sup>			
				ALR			0 265 006 681 <sup>4</sup>		
	06.03-05.04	120	Fg.-Nr. →8E..4..050 000	ALR,LAB			0 265 006 707 <sup>4</sup>		
			Fg.-Nr. →8E..4..400 000	ALR,RAB			0 265 006 681 <sup>4</sup>		
				ALR			0 265 006 681 <sup>4</sup>		
	06.03-12.04	120	Fg.-Nr. 8E..4..000 001→				0 265 006 809 <sup>3</sup>		
	06.04-12.04	120	Fg.-Nr. 8E..5..000 001→	ALR,LAB			0 265 006 826 <sup>4</sup>		
ALR,RAB						0 265 006 824 <sup>4</sup>			
ALR						0 265 006 824 <sup>4</sup>			
<b>2.5 TDI quattro</b>	09.01-05.03	132					0 265 006 683 <sup>3</sup>		
				ALR,LAB			0 265 006 707 <sup>4</sup>		
				ALR,RAB			0 265 006 681 <sup>4</sup>		
				ALR			0 265 006 681 <sup>4</sup>		
	11.02-05.04	132	Fg.-Nr. →8E..4..050 000	ALR,LAB			0 265 006 707 <sup>4</sup>		
			Fg.-Nr. →8E..4..400 000	ALR,RAB			0 265 006 681 <sup>4</sup>		
				ALR			0 265 006 681 <sup>4</sup>		
	06.03-12.04	132	Fg.-Nr. 8E..4..000 001→				0 265 006 809 <sup>3</sup>		
	06.04-12.04	132	Fg.-Nr. 8E..5..000 001→	ALR,LAB			0 265 006 826 <sup>4</sup>		
ALR,RAB						0 265 006 824 <sup>4</sup>			
ALR						0 265 006 824 <sup>4</sup>			
<b>3.0</b>	09.01-05.03	162	Fg.-Nr. →8E..3..500 000				0 265 006 683 <sup>3</sup>		
	09.01-05.04	162	Fg.-Nr. →8E..4..050 000	ALR,LAB			0 265 006 707 <sup>4</sup>		
			Fg.-Nr. →8E..4..400 000	ALR,RAB			0 265 006 681 <sup>4</sup>		
				ALR			0 265 006 681 <sup>4</sup>		
<b>3.0</b>	09.01-05.03	160	Fg.-Nr. →8E..3..500 000				0 265 006 683 <sup>3</sup>		
	09.01-05.04	160	Fg.-Nr. →8E..4..050 000	ALR,LAB			0 265 006 707 <sup>4</sup>		
			Fg.-Nr. →8E..4..400 000	ALR,RAB			0 265 006 681 <sup>4</sup>		
				ALR			0 265 006 681 <sup>4</sup>		
<b>3.0 quattro</b>	06.03-12.04	160	Fg.-Nr. 8E..4..000 001→				0 265 006 809 <sup>3</sup>		
	06.04-12.04	160	Fg.-Nr. 8E..4..000 001→				0 265 006 809 <sup>3</sup>		
			Fg.-Nr. 8E..5..000 001→	ALR,LAB			0 265 006 826 <sup>4</sup>		
				ALR,RAB			0 265 006 824 <sup>4</sup>		
				ALR			0 265 006 824 <sup>4</sup>		



			S								
<b>◀ AUDI A4 Avant [8E5; B6]</b>											
<b>3.0</b> <b>3.0 quattro</b>	06.04-12.04	162	Fg.-Nr. 8E..5..000 001→	ALR,LAB	0 265 006 826 <sup>4</sup>						
				ALR,RAB	0 265 006 824 <sup>4</sup>						
<b>3.0 quattro</b>	09.01-05.04	162		ALR	0 265 006 824 <sup>4</sup>						
					0 265 006 683 <sup>3</sup>						
				ALR,LAB	0 265 006 707 <sup>4</sup>						
				ALR,RAB	0 265 006 681 <sup>4</sup>						
				ALR	0 265 006 681 <sup>4</sup>						
<b>A4 Avant [8K5; B8]</b>											
	<b>1.8 TFSI</b> <b>1.8 TFSI quattro</b>	11.07-06.11	88/118	PR-Code 1LA	0 986 134 266		←				
					0 986 135 266		→				
		11.07→	88/118	PR-Code 1LT	S31	0 986 134 267		← 57			
				PR-Code 1LY	S31	0 986 135 267		→ 57			
		11.11→	125	PR-Code 1LT	S31	0 986 134 267		← 57		F 026 A03 545 <sup>7</sup>	
				PR-Code 1LT, PR-Code 1LY	S31	0 986 135 267		→ 57			
				PR-Code 1LY	S31					1 987 470 506 <sup>8</sup>	
				PR-Code 1LY	S31					F 026 A03 545 <sup>7</sup>	
<b>2.0 TDI</b>	04.08-06.11	88/100		PR-Code 1LA	0 986 134 266		←				
					0 986 135 266		→				
		120	PR-Code 1LA	0 986 134 266		←					
				0 986 135 266		→					
	04.08→	88/100	PR-Code 1LT	S31	0 986 134 267		← 57				
				0 986 135 267		→ 57					
		120	PR-Code 1LT	S31	0 986 134 267		← 57				
				0 986 135 267		→ 57					
				PR-Code 1LY	S31						F 026 A03 545 <sup>7</sup>
		11.11→	105	PR-Code 1LT, PR-Code 1LY	S31						1 987 470 506 <sup>8</sup>
		120	PR-Code 1LT, PR-Code 1LY	S31						1 987 470 506 <sup>8</sup>	
<b>2.0 TDI quattro</b>	05.09-03.12	105	PR-Code 1LT, PR-Code 1LY	ATE						1 987 470 506 <sup>8</sup>	
	11.11→	105	PR-Code 1LT, PR-Code 1LY	S31						1 987 470 506 <sup>8</sup>	
	04.14→	88/100	PR-Code 1LT	S31	0 986 134 267		← 57				
					0 986 135 267		→ 57				
<b>2.0 TDI</b> <b>2.0 TDI quattro</b>	04.08-06.11	105		PR-Code 1LA	0 986 134 266		←				
					0 986 135 266		→				
		125	PR-Code 1LA	0 986 134 266		←					
				0 986 135 266		→					
	04.08-03.12	125	PR-Code 1LT	S31	0 986 134 267		← 57				
				PR-Code 1LY	S31	0 986 135 267		→ 57			
				PR-Code 1LY	S31					F 026 A03 545 <sup>7</sup>	
	04.08→	88/100	PR-Code 1LY	S31						F 026 A03 545 <sup>7</sup>	
		105	PR-Code 1LT	S31	0 986 134 267		← 57				
				PR-Code 1LY	S31	0 986 135 267		→ 57			
				PR-Code 1LY	S31					F 026 A03 545 <sup>7</sup>	
	11.11→	130	PR-Code 1LT	S31	0 986 134 267		← 57				
				PR-Code 1LT, PR-Code 1LY	S31	0 986 135 267		→ 57			
				PR-Code 1LY	S31					1 987 470 506 <sup>8</sup>	
				PR-Code 1LY	S31					F 026 A03 545 <sup>7</sup>	
	01.12→	88/100	PR-Code 1LT, PR-Code 1LY	S31						1 987 470 506 <sup>8</sup>	
	05.13→	110	PR-Code 1LT	S31	0 986 134 267		← 57				
				PR-Code 1LT, PR-Code 1LY	S31	0 986 135 267		→ 57			
				PR-Code 1LY	S31					1 987 470 506 <sup>8</sup>	
				PR-Code 1LY	S31					F 026 A03 545 <sup>7</sup>	
	09.13→	140	PR-Code 1LT	S31	0 986 134 267		← 57				
				PR-Code 1LT, PR-Code 1LY	S31	0 986 135 267		→ 57			
				PR-Code 1LY	S31					1 987 470 506 <sup>8</sup>	
				PR-Code 1LY	S31					F 026 A03 545 <sup>7</sup>	



<b>2.0 TFSI</b> <b>2.0 TFSI flexible fuel</b> <b>2.0 TFSI quattro flexible fuel</b>	06.08-06.11	132	PR-Code 1LA			0 986 134 266		←
						0 986 135 266		→
	06.08→	132	PR-Code 1LT	S31		0 986 134 267		← 57
			PR-Code 1LY	S31		0 986 135 267		→ 57
<b>2.0 TFSI</b> <b>2.0 TFSI quattro</b>	05.08-06.11	155	PR-Code 1LA			0 986 134 266		←
						0 986 135 266		→
	05.08→	155	PR-Code 1LT	S31		0 986 134 267		← 57
			PR-Code 1LY	S31		0 986 135 267		→ 57
	05.13→	165	PR-Code 1LT	S31		0 986 134 267		← 57
			PR-Code 1LT, PR-Code 1LY	S31		0 986 135 267		→ 57
<b>2.7 TDI</b>	04.08-06.11	120/140	PR-Code 1LA			0 986 134 266		←
						0 986 135 266		→
	04.08-03.12	120/140	PR-Code 1LT	S31		0 986 134 267		← 57
			PR-Code 1LY	S31		0 986 135 267		→ 57
<b>3.0 TDI</b>	11.11→	150	PR-Code 1LT	S31		0 986 134 267		← 57
			PR-Code 1LT, PR-Code 1LY	S31		0 986 135 267		→ 57
			PR-Code 1LY	S31				1 987 470 506 <sup>B</sup>
<b>3.0 TDI quattro</b>	04.08-06.11	155/176	PR-Code 1LA			0 986 134 266		←
						0 986 135 266		→
	04.08-03.12	155/176	PR-Code 1LT	S31		0 986 134 267		← 57
			PR-Code 1LY	S31		0 986 135 267		→ 57
<b>3.0 TDI quattro</b> <b>3.0 TFSI quattro</b>	05.13→	180/200	PR-Code 1LT	S31		0 986 134 267		← 57
			PR-Code 1LT, PR-Code 1LY	S31		0 986 135 267		→ 57
			PR-Code 1LY	S31				1 987 470 506 <sup>B</sup>
<b>3.2 FSI</b> <b>3.2 FSI quattro</b>	04.08-06.11	195	PR-Code 1LA			0 986 134 266		←
						0 986 135 266		→
	04.08-03.12	195	PR-Code 1LT	S31		0 986 134 267		← 57
			PR-Code 1LY	S31		0 986 135 267		→ 57
		11.07→	88/118/ 125	LAB	0 265 007 928 <sup>4</sup>			
				RAB	0 265 007 930 <sup>3</sup>			
	<b>1.8 TFSI quattro</b>	09.08→	88/118/ 125	LAB	0 265 007 928 <sup>4</sup>			
				RAB	0 265 007 928 <sup>3</sup>			
	<b>2.0 TDI</b>	04.08→	88/100/105/110/ 120/125/130/ 132/140/155/ 165	LAB	0 265 007 928 <sup>4</sup>			
				RAB	0 265 007 928 <sup>3</sup>			
	<b>2.0 TDI quattro</b>	06.08→	88/100/105/110/ 120/125/130/ 132/140/155/ 165	LAB	0 265 007 928 <sup>4</sup>			
				RAB	0 265 007 928 <sup>3</sup>			
	<b>2.0 TFSI</b>	06.08→	88/100/105/110/ 120/125/130/ 132/140/155/ 165	LAB	0 265 007 928 <sup>4</sup>			
				RAB	0 265 007 928 <sup>3</sup>			
						0 265 007 930 <sup>4</sup>		



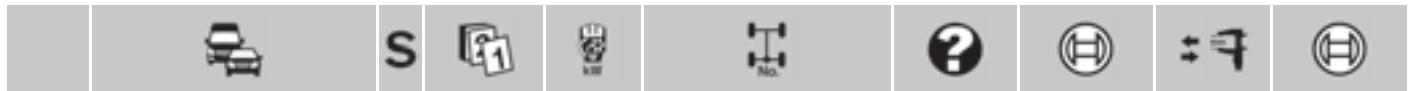

















AUDI A4 Avant [8K5; B8]									
2.0 TFSI flexible fuel	11.09→	88/100/105/110/ 120/125/130/ 132/140/155/ 165	LAB	0 265 007 928 <sup>4</sup>					
			RAB	0 265 007 930 <sup>3</sup>					
2.0 TFSI quattro	06.08→	88/100/105/110/ 120/125/130/ 132/140/155/ 165	LAB	0 265 007 928 <sup>4</sup>					
			RAB	0 265 007 930 <sup>3</sup>					
2.0 TFSI quattro flexible fuel	11.09→	88/100/105/110/ 120/125/130/ 132/140/155/ 165	LAB	0 265 007 928 <sup>4</sup>					
			RAB	0 265 007 930 <sup>3</sup>					
2.7 TDI	04.08-03.12	120/140	LAB	0 265 007 928 <sup>4</sup>					
			RAB	0 265 007 930 <sup>3</sup>					
				0 265 007 930 <sup>4</sup>					
3.0 TDI	11.11→	150/155/ 176/180/ 200	LAB	0 265 007 928 <sup>4</sup>					
			RAB	0 265 007 930 <sup>3</sup>					
				0 265 007 930 <sup>4</sup>					
3.0 TDI quattro	04.08→	150/155/ 176/180/ 200	LAB	0 265 007 928 <sup>4</sup>					
			RAB	0 265 007 930 <sup>3</sup>					
				0 265 007 930 <sup>4</sup>					
3.0 TFSI quattro	02.12→	150/155/ 176/180/ 200	LAB	0 265 007 928 <sup>4</sup>					
			RAB	0 265 007 930 <sup>3</sup>					
				0 265 007 930 <sup>4</sup>					
3.2 FSI	09.08-03.12	195	LAB	0 265 007 928 <sup>4</sup>					
			RAB	0 265 007 930 <sup>3</sup>					
				0 265 007 930 <sup>4</sup>					
3.2 FSI quattro	04.08-03.12	195	LAB	0 265 007 928 <sup>4</sup>					
			RAB	0 265 007 930 <sup>3</sup>					
				0 265 007 930 <sup>4</sup>					

**A4 Cabriolet [8HE; B7]**









A4 Cabriolet [8HE; B7]									
1.8 T	01.06-03.09	120	PR-Code 1LB	288	0 986 473 070	← 56,93	1 987 470 005 <sup>7</sup>		
			PR-Code 1LT	312	0 986 473 070	← 56,93	1 987 470 506 <sup>8</sup>		
2.0 TDI	01.06-03.09	100/103	PR-Code 1LB		0 986 474 070	→ 56,93	1 987 470 005 <sup>7</sup>		
					0 986 473 070	← 56,93	1 987 470 506 <sup>8</sup>		
					0 986 474 070	→ 56,93	1 987 470 005 <sup>7</sup>		
2.0 TFSI	01.06-03.09	147	PR-Code 1LA				1 987 470 506 <sup>8</sup>		
			PR-Code 1LT	312	0 986 473 070	← 56,93	1 987 470 005 <sup>7</sup>		
	08.06-03.09	147			0 986 473 070	← 56,93	1 987 470 506 <sup>8</sup>		
					0 986 474 070	→ 56,93	1 987 470 005 <sup>7</sup>		
2.7 TDI	11.05-03.09	132	PR-Code 1LT		0 986 473 070	← 56,93	1 987 470 005 <sup>7</sup>		
					0 986 473 070	← 56,93	1 987 470 506 <sup>8</sup>		
					0 986 474 070	→ 56,93	1 987 470 005 <sup>7</sup>		
3.0 TDI quattro	01.06-03.09	150/171	PR-Code 1LA				1 987 470 506 <sup>8</sup>		
			PR-Code 1LT	312	0 986 473 070	← 56,93	1 987 470 005 <sup>7</sup>		
					0 986 473 070	← 56,93	1 987 470 506 <sup>8</sup>		
3.2 FSI	01.06-03.09	188	PR-Code 1LA				1 987 470 005 <sup>7</sup>		
							0 986 474 070	→ 56,93	1 987 470 506 <sup>8</sup>

									
<b>3.2 FSI quattro</b>		01.06-03.09	188	PR-Code 1LA					1 987 470 506 <sup>8</sup>
				PR-Code 1LT	312		0 986 473 070	← 56,93	1 987 470 005 <sup>7</sup>
							0 986 473 070	← 56,93	1 987 470 506 <sup>8</sup>
							0 986 474 070	→ 56,93	1 987 470 005 <sup>7</sup>
									
 <b>1.8 T</b>		01.06-03.09	120		212		0 986 473 109	← 38,1	1 987 470 040 <sup>7</sup>
							0 986 473 109	← 38,1	1 987 474 496 <sup>8</sup>
							0 986 474 109	→ 38,1	1 987 470 040 <sup>7</sup>
<b>2.0 TDI</b>		01.06-03.09	100/103		212,245		0 986 473 109	← 38,1	1 987 470 040 <sup>7</sup>
							0 986 473 109	← 38,1	1 987 474 496 <sup>8</sup>
							0 986 474 109	→ 38,1	1 987 470 040 <sup>7</sup>
									
 <b>1.8 T</b>		01.06-03.09	120				1 987 477 922	← 1928	
							1 987 477 923	→ 2005	
<b>2.0 TDI</b>		01.06-03.09	100/103/				1 987 477 922	← 1928	
<b>2.0 TFSI</b>			147				1 987 477 923	→ 2005	
<b>2.7 TDI</b>		11.05-03.09	132				1 987 477 922	← 1928	
							1 987 477 923	→ 2005	
<b>3.0 TDI quattro</b>		01.06-03.09	150/171				1 987 477 257	↔ 1736	
<b>3.2 FSI</b>		01.06-03.09	188				1 987 477 922	← 1928	
							1 987 477 923	→ 2005	
<b>3.2 FSI quattro</b>		01.06-03.09	188				1 987 477 257	↔ 1736	
 <b>1.8 T</b>		01.06-03.09	120				0 265 006 809 <sup>3</sup>		
						ALR,LAB	0 265 006 828 <sup>4</sup>		
						ALR,RAB	0 265 006 824 <sup>4</sup>		
						ALR	0 265 006 824 <sup>4</sup>		
<b>2.0 TDI</b>		01.06-03.09	100/103/				0 265 006 809 <sup>3</sup>		
<b>2.0 TFSI</b>			147			ALR,LAB	0 265 006 828 <sup>4</sup>		
						ALR,RAB	0 265 006 824 <sup>4</sup>		
						ALR	0 265 006 824 <sup>4</sup>		
<b>2.7 TDI</b>		11.05-03.09	132				0 265 006 809 <sup>3</sup>		
						ALR,LAB	0 265 006 828 <sup>4</sup>		
						ALR,RAB	0 265 006 824 <sup>4</sup>		
						ALR	0 265 006 824 <sup>4</sup>		
<b>3.0 TDI quattro</b>		01.06-03.09	150/171				0 265 006 809 <sup>3</sup>		
						ALR,LAB	0 265 006 828 <sup>4</sup>		
						ALR,RAB	0 265 006 824 <sup>4</sup>		
						ALR	0 265 006 824 <sup>4</sup>		
<b>3.2 FSI</b>		01.06-03.09	188				0 265 006 809 <sup>3</sup>		
<b>3.2 FSI quattro</b>						ALR,LAB	0 265 006 828 <sup>4</sup>		
						ALR,RAB	0 265 006 824 <sup>4</sup>		
						ALR	0 265 006 824 <sup>4</sup>		
<b>A4 Cabriolet [8H7; B6]</b>									
									
 <b>1.8 T</b>		10.02-06.06	125	PR-Code 1LE	288		0 986 473 070	← 56,93	1 987 470 005 <sup>7</sup>
							0 986 473 070	← 56,93	1 987 470 506 <sup>8</sup>
							0 986 474 070	→ 56,93	1 987 470 005 <sup>7</sup>
				PR-Code 1LF	312		0 986 473 070	← 56,93	1 987 470 005 <sup>7</sup>
							0 986 473 070	← 56,93	1 987 470 506 <sup>8</sup>
							0 986 474 070	→ 56,93	1 987 470 005 <sup>7</sup>
<b>1.8 T</b>		04.02-12.05	120		228		0 986 474 897	← 54	1 987 470 287 <sup>7</sup>
<b>1.8 T quattro</b>							0 986 474 898	→ 54	1 987 470 287 <sup>7</sup>
					288		0 986 473 070	← 56,93	1 987 470 506 <sup>8</sup>
							0 986 474 070	→ 56,93	1 987 470 506 <sup>8</sup>



		S							
	◀ AUDI A4 Cabriolet [8H7; B6]								
1.8 T	04.02-12.05	120			312	0986 473 070		← 56,93	1987 470 005 <sup>7</sup>
1.8 T quattro						0986 473 070		← 56,93	1987 470 506 <sup>8</sup>
						0986 474 070		→ 56,93	1987 470 005 <sup>7</sup>
2.0	05.04-12.05	96			228	0986 474 897		← 54	1987 470 287 <sup>7</sup>
					288	0986 474 898		→ 54	1987 470 287 <sup>7</sup>
						0986 473 070		← 56,93	1987 470 506 <sup>8</sup>
						0986 474 070		→ 56,93	1987 470 506 <sup>8</sup>
2.4	04.02-12.05	120/125			228	0986 474 897		← 54	1987 470 287 <sup>7</sup>
					288	0986 474 898		→ 54	1987 470 287 <sup>7</sup>
						0986 473 070		← 56,93	1987 470 506 <sup>8</sup>
						0986 474 070		→ 56,93	1987 470 506 <sup>8</sup>
					312	0986 473 070		← 56,93	1987 470 005 <sup>7</sup>
						0986 473 070		← 56,93	1987 470 506 <sup>8</sup>
						0986 474 070		→ 56,93	1987 470 005 <sup>7</sup>
2.5 TDI	08.02-05.03	120			228	0986 474 897		← 54	1987 470 287 <sup>7</sup>
	08.02-12.05	120			288	0986 473 070		← 56,93	1987 470 506 <sup>8</sup>
						0986 474 070		→ 56,93	1987 470 506 <sup>8</sup>
					312	0986 473 070		← 56,93	1987 470 005 <sup>7</sup>
						0986 473 070		← 56,93	1987 470 506 <sup>8</sup>
						0986 474 070		→ 56,93	1987 470 005 <sup>7</sup>
3.0	04.02-12.05	160/162			228	0986 474 897		← 54	1987 470 287 <sup>7</sup>
3.0 quattro					288	0986 474 898		→ 54	1987 470 287 <sup>7</sup>
						0986 473 070		← 56,93	1987 470 506 <sup>8</sup>
						0986 474 070		→ 56,93	1987 470 506 <sup>8</sup>
					312	0986 473 070		← 56,93	1987 470 005 <sup>7</sup>
						0986 473 070		← 56,93	1987 470 506 <sup>8</sup>
						0986 474 070		→ 56,93	1987 470 005 <sup>7</sup>
4.2 quattro	02.04-12.05	253							1987 470 506 <sup>8</sup>
	1.8 T	04.02-06.06	120/125			0986 473 109		← 38,1	1987 470 040 <sup>7</sup>
	1.8 T quattro					0986 473 109		← 38,1	1987 474 496 <sup>8</sup>
						0986 474 109		→ 38,1	1987 470 040 <sup>7</sup>
	2.0	05.04-12.05	96			0986 473 109		← 38,1	1987 470 040 <sup>7</sup>
						0986 473 109		← 38,1	1987 474 496 <sup>8</sup>
						0986 474 109		→ 38,1	1987 470 040 <sup>7</sup>
	2.4	04.02-12.05	120/125			0986 473 109		← 38,1	1987 470 040 <sup>7</sup>
						0986 473 109		← 38,1	1987 474 496 <sup>8</sup>
						0986 474 109		→ 38,1	1987 470 040 <sup>7</sup>
	2.5 TDI	08.02-12.05	120			0986 473 109		← 38,1	1987 470 040 <sup>7</sup>
						0986 473 109		← 38,1	1987 474 496 <sup>8</sup>
		06.03-12.05	120			0986 474 109		→ 38,1	1987 470 040 <sup>7</sup>
	3.0	04.02-12.05	160/162			0986 473 109		← 38,1	1987 470 040 <sup>7</sup>
	3.0 quattro					0986 473 109		← 38,1	1987 474 496 <sup>8</sup>
						0986 474 109		→ 38,1	1987 470 040 <sup>7</sup>
	1.8 T	04.02-12.05	120			1987 477 922		← 1928	
						1987 477 923		→ 2005	
		10.02-06.06	125			1987 477 922		← 1928	
						1987 477 923		→ 2005	
	1.8 T quattro	07.02-12.05	120			1987 477 257		← 1736	
						1987 477 923		→ 2005	
	2.0	05.04-12.05	96			1987 477 922		← 1928	
						1987 477 923		→ 2005	
	2.4	04.02-12.05	120/125			1987 477 922		← 1928	
						1987 477 923		→ 2005	
	2.5 TDI	08.02-12.05	120			1987 477 922		← 1928	
						1987 477 923		→ 2005	



		<b>S</b>									
<b>3.0</b>		04.02-12.05	160				1 987 477 922	← 1928			
							1 987 477 923	→ 2005			
			162				1 987 477 922	← 1928			
							1 987 477 923	→ 2005			
<b>3.0 quattro</b>		06.03-12.05	162			1 987 477 257	← 1736				
							1 987 477 923	→ 2005			
 <b>1.8 T</b>		10.02-05.03	125	Fg.-Nr. →8H..3..050 000			0 265 006 683 <sup>3</sup>				
			125	Fg.-Nr. →8H..4..050 000, →8H..4..902 000, PR-Code 8Q3	LAB		0 265 006 707 <sup>4</sup>				
			125	Fg.-Nr. →8H..6..007 938, →8H..6..900 601, PR-Code 8Q0, PR-Code 8Q1	LAB,RAB		0 265 006 681 <sup>4</sup>				
				Fg.-Nr. →8H..6..007 938, →8H..6..900 601, PR-Code 8Q3	RAB		0 265 006 681 <sup>4</sup>				
			125	Fg.-Nr. 8H..4..000 001→			0 265 006 809 <sup>3</sup>				
			125	Fg.-Nr. 8H..5..000 001→, 8H..5..900 001→, PR-Code 8Q3	LAB		0 265 006 826 <sup>4</sup>				
			125	Fg.-Nr. 8H..6..007 939→, 8H..6..900 602→, PR-Code 8Q0, PR-Code 8Q1	LAB,RAB		0 265 006 824 <sup>4</sup>				
				Fg.-Nr. 8H..6..007 939→, 8H..6..900 602→, PR-Code 8Q3	RAB		0 265 006 824 <sup>4</sup>				
			<b>1.8 T</b>		04.02-05.03	120	Fg.-Nr. →8E..3..500 000			0 265 006 683 <sup>3</sup>	
			<b>1.8 T quattro</b>		04.02-05.04	120	Fg.-Nr. →8E..4..050 000	ALR,LAB		0 265 006 707 <sup>4</sup>	
	Fg.-Nr. →8E..4..400 000	ALR,RAB					0 265 006 681 <sup>4</sup>				
					ALR		0 265 006 681 <sup>4</sup>				
		06.03-12.05	120	Fg.-Nr. 8E..4..000 001→			0 265 006 809 <sup>3</sup>				
		06.04-12.05	120	Fg.-Nr. 8E..5..000 001→	ALR,LAB		0 265 006 826 <sup>4</sup>				
	ALR,RAB					0 265 006 824 <sup>4</sup>					
	ALR					0 265 006 824 <sup>4</sup>					
<b>2.0</b>		05.04-12.05	96				0 265 006 809 <sup>3</sup>				
					ALR,LAB		0 265 006 826 <sup>4</sup>				
					ALR,RAB		0 265 006 824 <sup>4</sup>				
					ALR		0 265 006 824 <sup>4</sup>				
<b>2.4</b>		04.02-05.03	120/125	Fg.-Nr. →8E..3..500 000			0 265 006 683 <sup>3</sup>				
			120/125	Fg.-Nr. →8E..4..050 000	ALR,LAB		0 265 006 707 <sup>4</sup>				
					Fg.-Nr. →8E..4..400 000	ALR,RAB		0 265 006 681 <sup>4</sup>			
						ALR		0 265 006 681 <sup>4</sup>			
			06.03-12.05	120/125	Fg.-Nr. 8E..4..000 001→			0 265 006 809 <sup>3</sup>			
		06.04-12.05	120/125	Fg.-Nr. 8E..5..000 001→	ALR,LAB		0 265 006 826 <sup>4</sup>				
	ALR,RAB					0 265 006 824 <sup>4</sup>					
	ALR					0 265 006 824 <sup>4</sup>					
<b>2.5 TDI</b>		08.02-05.03	120				0 265 006 683 <sup>3</sup>				
					ALR,LAB		0 265 006 707 <sup>4</sup>				
					ALR,RAB		0 265 006 681 <sup>4</sup>				
					ALR		0 265 006 681 <sup>4</sup>				
					06.03-05.04	120	Fg.-Nr. →8E..4..050 000	ALR,LAB		0 265 006 707 <sup>4</sup>	
				Fg.-Nr. →8E..4..400 000	ALR,RAB		0 265 006 681 <sup>4</sup>				
					ALR		0 265 006 681 <sup>4</sup>				
		06.03-12.05	120				0 265 006 809 <sup>3</sup>				
		06.04-12.05	120	Fg.-Nr. 8E..5..000 001→	ALR,LAB		0 265 006 826 <sup>4</sup>				
	ALR,RAB					0 265 006 824 <sup>4</sup>					
	ALR					0 265 006 824 <sup>4</sup>					
<b>3.0</b>		04.02-05.03	160	Fg.-Nr. →8E..3..500 000			0 265 006 683 <sup>3</sup>				
			162	Fg.-Nr. →8E..3..500 000			0 265 006 683 <sup>3</sup>				
		04.02-05.04	160	Fg.-Nr. →8E..4..050 000	ALR,LAB		0 265 006 707 <sup>4</sup>				
				Fg.-Nr. →8E..4..400 000	ALR,RAB		0 265 006 681 <sup>4</sup>				
						ALR		0 265 006 681 <sup>4</sup>			
				162	Fg.-Nr. →8E..4..050 000	ALR,LAB		0 265 006 707 <sup>4</sup>			
	06.03-12.05	160	Fg.-Nr. 8E..4..000 001→				0 265 006 809 <sup>3</sup>				
		162	Fg.-Nr. 8E..4..000 001→				0 265 006 809 <sup>3</sup>				



















































		S											
<b>◀ AUDI A4 Cabriolet [8H7; B6]</b>													
<b>3.0</b>		06.04-12.05	160	Fg.-Nr. 8E..5..000 001→		ALR,LAB	0 265	<b>006 826<sup>4</sup></b>					
						ALR,RAB	0 265	<b>006 824<sup>4</sup></b>					
						ALR	0 265	<b>006 824<sup>4</sup></b>					
<b>3.0 quattro</b>		04.02-05.04	162	Fg.-Nr. →8E..4..400 000		ALR,RAB	0 265	<b>006 681<sup>4</sup></b>					
		06.04-12.05	162	Fg.-Nr. 8E..5..000 001→		ALR	0 265	<b>006 681<sup>4</sup></b>					
<b>3.0 quattro</b>		06.03-05.04	162	Fg.-Nr. →8E..4..050 000		ALR,LAB	0 265	<b>006 826<sup>4</sup></b>					
						ALR,RAB	0 265	<b>006 824<sup>4</sup></b>					
						ALR	0 265	<b>006 824<sup>4</sup></b>					
		06.03-12.05	162				0 265	<b>006 809<sup>3</sup></b>					
<b>A4 Sportback [8TA]</b>													
	<b>2.0 TDI quattro</b>	01.12→	130	PR-Code 1LT		S31	0 986	<b>134 267</b>		← 57			
							0 986	<b>135 267</b>		→ 57			
		04.12→	130	PR-Code 1LT, PR-Code 1LY		S31					1 987	<b>470 506<sup>8</sup></b>	
				PR-Code 1LY		S31						F 026	<b>A03 545<sup>7</sup></b>
	<b>2.0 TDI quattro</b>	01.12→	130			LAB	0 265	<b>007 928<sup>4</sup></b>					
							0 265	<b>007 930<sup>3</sup></b>					
						RAB	0 265	<b>007 928<sup>3</sup></b>					
							0 265	<b>007 930<sup>4</sup></b>					
<b>A4 [8D2; B5]</b>													
	<b>1.6</b>	11.94-10.96	74				0 986	<b>471 810</b>		← 54	1 987	<b>470 287<sup>7</sup></b>	
							0 986	<b>473 810</b>					
							0 986	<b>471 811</b>		→ 54	1 987	<b>470 287<sup>7</sup></b>	
		10.96-02.97	74	Fg.-Nr. →8D..V..169 695			0 986	<b>473 811</b>					
							0 986	<b>471 810</b>		← 54	1 987	<b>470 287<sup>7</sup></b>	
							0 986	<b>473 810</b>					
							0 986	<b>471 811</b>		→ 54	1 987	<b>470 287<sup>7</sup></b>	
							0 986	<b>473 811</b>					
		02.97-07.99	74	Fg.-Nr. 8D..V..169 696→			0 986	<b>474 897</b>		← 54	1 987	<b>470 287<sup>7</sup></b>	
							0 986	<b>474 898</b>		→ 54	1 987	<b>470 287<sup>7</sup></b>	
		08.98-06.00	74			228	0 986	<b>474 897</b>		← 54	1 987	<b>470 287<sup>7</sup></b>	
							0 986	<b>474 898</b>		→ 54	1 987	<b>470 287<sup>7</sup></b>	
						288	0 986	<b>473 070</b>		← 56,93	1 987	<b>470 506<sup>8</sup></b>	
							0 986	<b>474 070</b>		← 56,93	1 987	<b>470 506<sup>8</sup></b>	
		06.00-10.00	75			228	0 986	<b>474 897</b>		← 54	1 987	<b>470 287<sup>7</sup></b>	
							0 986	<b>474 898</b>		→ 54	1 987	<b>470 287<sup>7</sup></b>	
						288	0 986	<b>473 070</b>		← 56,93	1 987	<b>470 506<sup>8</sup></b>	
							0 986	<b>474 070</b>		→ 56,93	1 987	<b>470 506<sup>8</sup></b>	
<b>1.8</b>		11.94-11.94	92	Fg.-Nr. →8D..S..011 333		288	0 986	<b>473 070</b>		← 56,93	1 987	<b>470 005<sup>7</sup></b>	
<b>1.8 quattro</b>							0 986	<b>473 070</b>		← 56,93	1 987	<b>470 506<sup>8</sup></b>	
							0 986	<b>474 070</b>		→ 56,93	1 987	<b>470 005<sup>7</sup></b>	
		11.94-10.96	92	Fg.-Nr. →8D..V..054 061			0 986	<b>473 270</b>		← 57	1 987	<b>470 005<sup>7</sup></b>	
							0 986	<b>473 270</b>		← 57	1 987	<b>470 506<sup>8</sup></b>	
							0 986	<b>474 270</b>		→ 57	1 987	<b>470 005<sup>7</sup></b>	
		04.95-10.96	85	Fg.-Nr. →8D..V..054 061			0 986	<b>473 270</b>		← 57	1 987	<b>470 005<sup>7</sup></b>	
							0 986	<b>473 270</b>		← 57	1 987	<b>470 506<sup>8</sup></b>	
							0 986	<b>474 270</b>		→ 57	1 987	<b>470 005<sup>7</sup></b>	
		10.96-04.99	92	Fg.-Nr. 8D..V..054 062→		228	0 986	<b>474 897</b>		← 54	1 987	<b>470 287<sup>7</sup></b>	
							0 986	<b>474 898</b>		→ 54	1 987	<b>470 287<sup>7</sup></b>	
		10.96-10.01	85	Fg.-Nr. 8D..V..054 062→		228	0 986	<b>474 897</b>		← 54	1 987	<b>470 287<sup>7</sup></b>	
							0 986	<b>474 898</b>		→ 54	1 987	<b>470 287<sup>7</sup></b>	



		S															
<b>1.8</b>	08.98-10.00	92				228	0986 474 897	← 54	1987 470 287 <sup>7</sup>								
							0986 474 898	→ 54	1987 470 287 <sup>7</sup>								
<b>1.8 quattro</b>						288	0986 473 070	← 56,93	1987 470 506 <sup>8</sup>								
							0986 474 070	→ 56,93	1987 470 506 <sup>8</sup>								
<b>1.8 T</b>	11.94-07.98	110					0986 473 070	← 56,93	1987 470 005 <sup>7</sup>								
							0986 473 070	← 56,93	1987 470 506 <sup>8</sup>								
							0986 474 070	→ 56,93	1987 470 005 <sup>7</sup>								
	08.97-12.98	132						0986 473 070	← 56,93	1987 470 506 <sup>8</sup>							
								0986 474 070	→ 56,93	1987 470 506 <sup>8</sup>							
	08.98-10.00	110					288	0986 473 070	← 56,93	1987 470 506 <sup>8</sup>							
0986 474 070								→ 56,93	1987 470 506 <sup>8</sup>								
<b>1.8 T quattro</b>	11.94-07.97	110					0986 473 070	← 56,93	1987 470 005 <sup>7</sup>								
							0986 474 070	→ 56,93	1987 470 005 <sup>7</sup>								
	11.94-12.98	110						0986 473 070	← 56,93	1987 470 506 <sup>8</sup>							
								0986 474 070	→ 56,93	1987 470 506 <sup>8</sup>							
	08.97-12.98	110						0986 474 070	→ 56,93	1987 470 506 <sup>8</sup>							
								0986 473 070	← 56,93	1987 470 506 <sup>8</sup>							
08.97-10.00	132					228	0986 474 897	← 54	1987 470 287 <sup>7</sup>								
							0986 474 898	→ 54	1987 470 287 <sup>7</sup>								
<b>1.8 T</b>	07.98-10.00	110				228	0986 474 897	← 54	1987 470 287 <sup>7</sup>								
							0986 474 898	→ 54	1987 470 287 <sup>7</sup>								
							0986 473 070	← 56,93	1987 470 005 <sup>7</sup>								
	05.00-08.01	125						0986 473 070	← 56,93	1987 470 005 <sup>7</sup>							
								0986 473 070	← 56,93	1987 470 506 <sup>8</sup>							
	0986 474 070							0986 474 070	→ 56,93	1987 470 005 <sup>7</sup>							
0986 473 070								← 56,93	1987 470 506 <sup>8</sup>								
<b>1.9 TDI</b>	11.94-07.96	66					0986 471 810	← 54	1987 470 287 <sup>7</sup>								
							0986 473 810										
							0986 471 811	→ 54	1987 470 287 <sup>7</sup>								
							0986 473 811										
							0986 473 270	← 57	1987 470 005 <sup>7</sup>								
							0986 473 270	← 57	1987 470 506 <sup>8</sup>								
	02.96-07.99	81						0986 473 070	← 56,93	1987 470 506 <sup>8</sup>							
								0986 474 070	→ 56,93	1987 470 506 <sup>8</sup>							
								03.96-02.97	55		Fg.-Nr. →8D..V..169 695				0986 471 810	← 54	1987 470 287 <sup>7</sup>
															0986 473 810		
								0986 471 811	→ 54	1987 470 287 <sup>7</sup>							
								0986 473 811									
08.96-02.97	66		Fg.-Nr. →8D..V..169 695				0986 471 810	← 54	1987 470 287 <sup>7</sup>								
							0986 473 810										
							0986 471 811	→ 54	1987 470 287 <sup>7</sup>								
0986 473 811																	
02.97-06.00	55		Fg.-Nr. 8D..V..169 696→				0986 474 897	← 54	1987 470 287 <sup>7</sup>								
							0986 474 898	→ 54	1987 470 287 <sup>7</sup>								
	66		Fg.-Nr. 8D..V..169 696→				0986 474 897	← 54	1987 470 287 <sup>7</sup>								
							0986 474 898	→ 54	1987 470 287 <sup>7</sup>								
04.97-10.00	66						0986 474 897	← 54	1987 470 287 <sup>7</sup>								
							0986 474 898	→ 54	1987 470 287 <sup>7</sup>								
08.99-06.00	81					288	0986 473 070	← 56,93	1987 470 506 <sup>8</sup>								
							0986 474 070	→ 56,93	1987 470 506 <sup>8</sup>								
<b>1.9 TDI quattro</b>	07.96-12.98	81					0986 473 070	← 56,93	1987 470 506 <sup>8</sup>								
							0986 474 070	→ 56,93	1987 470 506 <sup>8</sup>								
08.99-01.00	81					288	0986 473 070	← 56,93	1987 470 506 <sup>8</sup>								
							0986 474 070	→ 56,93	1987 470 506 <sup>8</sup>								
<b>1.9 TDI</b>	02.96-07.97	81					0986 473 070	← 56,93	1987 470 005 <sup>7</sup>								
							0986 474 897	← 54	1987 470 287 <sup>7</sup>								
<b>1.9 TDI quattro</b>	08.98-11.00	85				228	0986 474 897	← 54	1987 470 287 <sup>7</sup>								
							0986 473 070	← 56,93	1987 470 506 <sup>8</sup>								
							288	0986 474 070	→ 56,93	1987 470 506 <sup>8</sup>							
								0986 474 897	← 54	1987 470 287 <sup>7</sup>							
08.99-06.00	81					228	0986 474 897	← 54	1987 470 287 <sup>7</sup>								
							0986 474 898	→ 54	1987 470 287 <sup>7</sup>								























































		S							
	◀ AUDI A4 [8D2; B5]								
2.4		07.95-07.97	110				0986 473 070	← 56,93	1987 470 005 <sup>7</sup>
							0986 473 070	← 56,93	1987 470 506 <sup>8</sup>
							0986 474 070	→ 56,93	1987 470 005 <sup>7</sup>
2.4		08.97-10.00	120/121		228		0986 474 897	← 54	1987 470 287 <sup>7</sup>
2.4 quattro							0986 474 898	→ 54	1987 470 287 <sup>7</sup>
					288		0986 473 070	← 56,93	1987 470 506 <sup>8</sup>
							0986 474 070	→ 56,93	1987 470 506 <sup>8</sup>
2.5 TDI		08.97-10.00	110		228		0986 474 897	← 54	1987 470 287 <sup>7</sup>
2.5 TDI quattro							0986 474 898	→ 54	1987 470 287 <sup>7</sup>
					288		0986 473 070	← 56,93	1987 470 506 <sup>8</sup>
							0986 474 070	→ 56,93	1987 470 506 <sup>8</sup>
2.6		11.94-07.98	110				0986 473 070	← 56,93	1987 470 506 <sup>8</sup>
							0986 474 070	→ 56,93	1987 470 506 <sup>8</sup>
2.6		11.94-07.97	110				0986 473 070	← 56,93	1987 470 005 <sup>7</sup>
2.6 quattro		04.95-07.97	102				0986 473 070	← 56,93	1987 470 005 <sup>7</sup>
							0986 473 070	← 56,93	1987 470 506 <sup>8</sup>
							0986 474 070	→ 56,93	1987 470 005 <sup>7</sup>
2.6 quattro		11.94-07.97	110				0986 474 070	→ 56,93	1987 470 005 <sup>7</sup>
		11.94-07.98	110				0986 473 070	← 56,93	1987 470 506 <sup>8</sup>
		08.97-07.98	110				0986 474 070	→ 56,93	1987 470 506 <sup>8</sup>
2.8		03.96-12.98	142				0986 473 070	← 56,93	1987 470 506 <sup>8</sup>
							0986 474 070	→ 56,93	1987 470 506 <sup>8</sup>
		10.96-06.00	142		288		0986 473 070	← 56,93	1987 470 506 <sup>8</sup>
							0986 474 070	→ 56,93	1987 470 506 <sup>8</sup>
2.8		11.94-07.97	128				0986 473 070	← 56,93	1987 470 005 <sup>7</sup>
2.8 quattro							0986 473 070	← 56,93	1987 470 506 <sup>8</sup>
							0986 474 070	→ 56,93	1987 470 005 <sup>7</sup>
		03.96-07.97	142				0986 473 070	← 56,93	1987 470 005 <sup>7</sup>
		10.96-10.00	142		228		0986 474 897	← 54	1987 470 287 <sup>7</sup>
							0986 474 898	→ 54	1987 470 287 <sup>7</sup>
		03.99-10.00	140		228		0986 474 897	← 54	1987 470 287 <sup>7</sup>
							0986 474 898	→ 54	1987 470 287 <sup>7</sup>
					288		0986 473 070	← 56,93	1987 470 506 <sup>8</sup>
							0986 474 070	→ 56,93	1987 470 506 <sup>8</sup>
2.8 quattro		03.96-07.97	142				0986 474 070	→ 56,93	1987 470 005 <sup>7</sup>
		03.96-07.98	142				0986 473 070	← 56,93	1987 470 506 <sup>8</sup>
		08.97-07.98	142				0986 474 070	→ 56,93	1987 470 506 <sup>8</sup>
		02.99-10.00	142		288		0986 473 070	← 56,93	1987 470 506 <sup>8</sup>
							0986 474 070	→ 56,93	1987 470 506 <sup>8</sup>
	1.6	11.94-10.96	74				0986 471 856	← 33	
							0986 473 856		
							0986 471 857	→ 33	
							0986 473 857		
		10.96-02.97	74			Fg.-Nr. →8D..V..168 350	0986 471 856	← 33	
							0986 473 856		
							0986 471 857	→ 33	
							0986 473 857		
		02.97-07.99	74			Fg.-Nr. 8D..V..168 351→	0986 472 830	← 38	1987 470 040 <sup>7</sup>
							0986 474 830		1987 474 496 <sup>8</sup>
							0986 472 831	→ 38	1987 470 040 <sup>7</sup>
							0986 474 831		
		08.98-06.00	74				0986 472 830	← 38	1987 470 040 <sup>7</sup>
							0986 474 830		1987 474 496 <sup>8</sup>
							0986 472 831	→ 38	1987 470 040 <sup>7</sup>
							0986 474 831		
		06.00-10.00	75				0986 472 830	← 38	1987 470 040 <sup>7</sup>
							0986 474 830		1987 474 496 <sup>8</sup>
							0986 472 831	→ 38	1987 470 040 <sup>7</sup>
							0986 474 831		

		S												
<b>1.8</b>	11.94-02.97	92	Fg.-Nr. →8D..V..168 350				0 986 471 856	← 33						
							0 986 473 856							
							0 986 471 857	→ 33						
							0 986 473 857							
	04.95-02.97	85	Fg.-Nr. →8D..V..168 350				0 986 471 856	← 33						
							0 986 473 856							
							0 986 471 857	→ 33						
	02.97-04.99	92	Fg.-Nr. 8D..V..168 351→				0 986 472 830	← 38	1 987 470 040 <sup>7</sup>					
							0 986 474 830		1 987 474 496 <sup>8</sup>					
							0 986 472 831	→ 38	1 987 470 040 <sup>7</sup>					
							0 986 474 831							
	02.97-06.00	85	Fg.-Nr. 8D..V..168 351→				0 986 472 830	← 38	1 987 470 040 <sup>7</sup>					
0 986 474 830								1 987 474 496 <sup>8</sup>						
0 986 472 831							→ 38	1 987 470 040 <sup>7</sup>						
0 986 474 831														
08.98-10.00	92					0 986 472 830	← 38	1 987 470 040 <sup>7</sup>						
						0 986 474 830		1 987 474 496 <sup>8</sup>						
						0 986 472 831	→ 38	1 987 470 040 <sup>7</sup>						
						0 986 474 831								
<b>1.8 quattro</b>	11.94-12.98	92	Fg.-Nr. →8D..X..199 999	INB			0 986 474 841		← 38	1 987 470 040 <sup>7</sup>				
							0 986 474 842		→ 38	1 987 470 040 <sup>7</sup>				
	07.95-12.98	85	Fg.-Nr. →8D..X..199 999	INB				0 986 474 841		← 38	1 987 470 040 <sup>7</sup>			
								0 986 474 842		→ 38	1 987 470 040 <sup>7</sup>			
	01.99-04.99	92	Fg.-Nr. 8D..X..200 001→	INB				0 986 134 068		← 43	F 026 A06 121 <sup>7</sup>			
								0 986 135 068		→ 43	1 987 474 496 <sup>8</sup>			
				INB							0 986 474 841		← 38	1 987 470 040 <sup>7</sup>
											0 986 474 842		→ 38	1 987 470 040 <sup>7</sup>
	01.99-10.01	85	Fg.-Nr. 8D..X..200 001→	INB				0 986 134 068		← 43	F 026 A06 121 <sup>7</sup>			
								0 986 135 068		→ 43	1 987 474 496 <sup>8</sup>			
				INB							0 986 474 841		← 38	1 987 470 040 <sup>7</sup>
											0 986 474 842		→ 38	1 987 470 040 <sup>7</sup>
	02.99-10.00	92		INB				0 986 134 068		← 43	F 026 A06 121 <sup>7</sup>			
								0 986 135 068		→ 43	1 987 474 496 <sup>8</sup>			
				INB							0 986 474 841		← 38	1 987 470 040 <sup>7</sup>
											0 986 474 842		→ 38	1 987 470 040 <sup>7</sup>
<b>1.8 T</b>	11.94-02.97	110	Fg.-Nr. →8D..V..168 350				0 986 471 856	← 33						
							0 986 473 856							
							0 986 471 857	→ 33						
							0 986 473 857							
	02.97-07.98	110	Fg.-Nr. 8D..V..168 351→					0 986 472 830	← 38	1 987 470 040 <sup>7</sup>				
								0 986 474 830		1 987 474 496 <sup>8</sup>				
								0 986 472 831	→ 38	1 987 470 040 <sup>7</sup>				
								0 986 474 831						
	08.97-12.98	132						0 986 472 830	← 38	1 987 470 040 <sup>7</sup>				
								0 986 474 830		1 987 474 496 <sup>8</sup>				
								0 986 472 831	→ 38	1 987 470 040 <sup>7</sup>				
								0 986 474 831						
08.98-10.00	110						0 986 472 830	← 38	1 987 470 040 <sup>7</sup>					
							0 986 474 830		1 987 474 496 <sup>8</sup>					
							0 986 472 831	→ 38	1 987 470 040 <sup>7</sup>					
							0 986 474 831							
<b>1.8 T quattro</b>	11.94-12.98	110					0 986 474 841		← 38	1 987 470 040 <sup>7</sup>				
							0 986 474 842		→ 38	1 987 470 040 <sup>7</sup>				
08.97-12.98	132	Fg.-Nr. →8D..X..199 999	INB				0 986 474 841		← 38	1 987 470 040 <sup>7</sup>				
							0 986 474 842		→ 38	1 987 470 040 <sup>7</sup>				
07.98-12.98	110	Fg.-Nr. →8D..X..199 999	INB				0 986 474 841		← 38	1 987 470 040 <sup>7</sup>				
							0 986 474 842		→ 38	1 987 470 040 <sup>7</sup>				



	S								
◀ AUDI A4 [8D2; B5]									
1.8 T quattro	01.99-07.99	110	Fg.-Nr. 8D..X..200 001→	INB	0986 134 068		43	F 026 A06 121 <sup>7</sup>	
					0986 134 068		43	1 987 474 496 <sup>8</sup>	
					0986 135 068		43	F 026 A06 121 <sup>7</sup>	
	INB	0986 474 841		38	1 987 470 040 <sup>7</sup>				
		0986 474 842		38	1 987 470 040 <sup>7</sup>				
		0986 134 068		43	F 026 A06 121 <sup>7</sup>				
	01.99-10.00	132	Fg.-Nr. 8D..X..200 001→	INB	0986 134 068		43	F 026 A06 121 <sup>7</sup>	
					0986 134 068		43	1 987 474 496 <sup>8</sup>	
					0986 135 068		43	F 026 A06 121 <sup>7</sup>	
	INB	0986 474 841		38	1 987 470 040 <sup>7</sup>				
		0986 474 842		38	1 987 470 040 <sup>7</sup>				
		0986 134 068		43	F 026 A06 121 <sup>7</sup>				
02.99-10.00	110		INB	0986 134 068		43	F 026 A06 121 <sup>7</sup>		
				0986 134 068		43	1 987 474 496 <sup>8</sup>		
				0986 135 068		43	F 026 A06 121 <sup>7</sup>		
INB	0986 474 841		38	1 987 470 040 <sup>7</sup>					
	0986 474 842		38	1 987 470 040 <sup>7</sup>					
	0986 474 842		38	1 987 470 040 <sup>7</sup>					
1.8 T	05.00-08.01	125		INB	0986 472 830		38	1 987 470 040 <sup>7</sup>	
					0986 474 830		38	1 987 474 496 <sup>8</sup>	
1.8 T quattro				INB	0986 472 831		38	1 987 470 040 <sup>7</sup>	
					0986 474 831		38		
1.9 TDI	11.94-07.96	66		INB	0986 471 856		33		
					0986 473 856		33		
					0986 471 857		33		
	02.96-02.97	81	Fg.-Nr. →8D..V..168 350		INB	0986 471 856		33	
						0986 473 856		33	
						0986 471 857		33	
	03.96-02.97	55	Fg.-Nr. →8D..V..168 350		INB	0986 471 856		33	
						0986 473 856		33	
						0986 471 857		33	
	08.96-02.97	66	Fg.-Nr. →8D..V..168 350		INB	0986 471 856		33	
						0986 473 856		33	
						0986 471 857		33	
02.97-07.99	81	Fg.-Nr. 8D..V..168 351→		INB	0986 472 830		38	1 987 470 040 <sup>7</sup>	
					0986 474 830		38	1 987 474 496 <sup>8</sup>	
					0986 472 831		38	1 987 470 040 <sup>7</sup>	
02.97-06.00	55	Fg.-Nr. 8D..V..168 351→		INB	0986 472 830		38	1 987 470 040 <sup>7</sup>	
					0986 474 830		38	1 987 474 496 <sup>8</sup>	
					0986 472 831		38	1 987 470 040 <sup>7</sup>	
66	Fg.-Nr. 8D..V..168 351→		INB	0986 472 830		38	1 987 470 040 <sup>7</sup>		
				0986 474 830		38	1 987 474 496 <sup>8</sup>		
				0986 472 831		38	1 987 470 040 <sup>7</sup>		
04.97-10.00	66			INB	0986 472 830		38	1 987 470 040 <sup>7</sup>	
					0986 474 830		38	1 987 474 496 <sup>8</sup>	
					0986 472 831		38	1 987 470 040 <sup>7</sup>	
08.98-11.00	85			INB	0986 472 830		38	1 987 470 040 <sup>7</sup>	
					0986 474 830		38	1 987 474 496 <sup>8</sup>	
					0986 472 831		38	1 987 470 040 <sup>7</sup>	
08.99-06.00	81			INB	0986 472 830		38	1 987 470 040 <sup>7</sup>	
					0986 474 830		38	1 987 474 496 <sup>8</sup>	
					0986 472 831		38	1 987 470 040 <sup>7</sup>	
0986 474 831	0986 474 831		38	1 987 470 040 <sup>7</sup>					
	0986 474 831		38	1 987 474 496 <sup>8</sup>					
	0986 474 831		38	1 987 470 040 <sup>7</sup>					
1.9 TDI quattro	07.96-12.98	81		INB	0986 474 841		38	1 987 470 040 <sup>7</sup>	
					0986 474 842		38	1 987 470 040 <sup>7</sup>	
12.98-12.98	85			INB	0986 474 841		38	1 987 470 040 <sup>7</sup>	
					0986 474 842		38	1 987 470 040 <sup>7</sup>	











		S													
1.9 TDI quattro	08.99-01.00	81				INB	0 986 134 068	 ← 43	F 026 A06 121 <sup>7</sup>						
							0 986 134 068	 ← 43	1 987 474 496 <sup>B</sup>						
							0 986 135 068	 → 43	F 026 A06 121 <sup>7</sup>						
							INB	0 986 474 841	 ← 38	1 987 470 040 <sup>7</sup>					
								0 986 474 842	 → 38	1 987 470 040 <sup>7</sup>					
								0 986 134 068	 ← 43	F 026 A06 121 <sup>7</sup>					
01.00-10.00	85				INB	0 986 134 068	 ← 43	F 026 A06 121 <sup>7</sup>							
						0 986 134 068	 ← 43	1 987 474 496 <sup>B</sup>							
						0 986 135 068	 → 43	F 026 A06 121 <sup>7</sup>							
						INB	0 986 474 841	 ← 38	1 987 470 040 <sup>7</sup>						
							0 986 474 842	 → 38	1 987 470 040 <sup>7</sup>						
							0 986 471 856	 ← 33							
2.4	07.95-02.97	110				Fg.-Nr. →8D..V..168 350	0 986 471 856	 ← 33							
							0 986 473 856								
							0 986 471 857	 → 33							
							0 986 473 857								
							02.97-07.97	110				Fg.-Nr. 8D..V..168 351→	0 986 472 830	 ← 38	1 987 470 040 <sup>7</sup>
													0 986 474 830		1 987 474 496 <sup>B</sup>
0 986 472 831	 → 38	1 987 470 040 <sup>7</sup>													
0 986 474 831															
08.97-10.00	120/121					0 986 472 830	 ← 38	1 987 470 040 <sup>7</sup>							
						0 986 474 830		1 987 474 496 <sup>B</sup>							
						0 986 472 831	 → 38	1 987 470 040 <sup>7</sup>							
						0 986 474 831									
2.4 quattro	08.97-12.98	120/121					0 986 474 841	 ← 38	1 987 470 040 <sup>7</sup>						
							0 986 474 842	 → 38	1 987 470 040 <sup>7</sup>						
	02.99-10.00	120/121				INB	0 986 134 068	 ← 43	F 026 A06 121 <sup>7</sup>						
							0 986 134 068	 ← 43	1 987 474 496 <sup>B</sup>						
							0 986 135 068	 → 43	F 026 A06 121 <sup>7</sup>						
							INB	0 986 474 841	 ← 38	1 987 470 040 <sup>7</sup>					
0 986 474 842	 → 38	1 987 470 040 <sup>7</sup>													
2.5 TDI	08.97-10.00	110					0 986 472 830	 ← 38	1 987 470 040 <sup>7</sup>						
							0 986 474 830		1 987 474 496 <sup>B</sup>						
							0 986 472 831	 → 38	1 987 470 040 <sup>7</sup>						
							0 986 474 831								
2.5 TDI quattro	11.97-12.98	110				Fg.-Nr. →8D..X..199 999	INB	0 986 474 841	 ← 38	1 987 470 040 <sup>7</sup>					
							0 986 474 842	 → 38	1 987 470 040 <sup>7</sup>						
	01.99-06.00	110				Fg.-Nr. 8D..X..200 001→	INB	0 986 134 068	 ← 43	F 026 A06 121 <sup>7</sup>					
								0 986 134 068	 ← 43	1 987 474 496 <sup>B</sup>					
								0 986 135 068	 → 43	F 026 A06 121 <sup>7</sup>					
								INB	0 986 474 841	 ← 38	1 987 470 040 <sup>7</sup>				
	0 986 474 842	 → 38	1 987 470 040 <sup>7</sup>												
	02.99-10.00	110				INB	0 986 134 068	 ← 43	F 026 A06 121 <sup>7</sup>						
							0 986 134 068	 ← 43	1 987 474 496 <sup>B</sup>						
							0 986 135 068	→ 43	F 026 A06 121 <sup>7</sup>						
							INB	0 986 474 841	← 38	1 987 470 040 <sup>7</sup>					
	0 986 474 842	→ 38	1 987 470 040 <sup>7</sup>												
2.6	11.94-02.97	102/110				Fg.-Nr. →8D..V..168 350	0 986 471 856	← 33							
							0 986 473 856								
							0 986 471 857	→ 33							
	02.97-07.98	102/110				Fg.-Nr. 8D..V..168 351→	0 986 472 830	← 38	1 987 470 040 <sup>7</sup>						
							0 986 474 830		1 987 474 496 <sup>B</sup>						
							0 986 472 831	→ 38	1 987 470 040 <sup>7</sup>						
0 986 474 831															
							0 986 474 841	← 38	1 987 470 040 <sup>7</sup>						
2.6 quattro	11.94-07.98	102/110					0 986 474 842	→ 38	1 987 470 040 <sup>7</sup>						
							0 986 474 841	← 38	1 987 470 040 <sup>7</sup>						
2.8	11.94-02.97	128				Fg.-Nr. →8D..V..168 350	0 986 471 856	← 33							
							0 986 473 856								
							0 986 471 857	→ 33							
	03.96-02.97	142				Fg.-Nr. →8D..V..168 350	INB	0 986 473 857							
								0 986 471 856	← 33						
								0 986 473 856							
0 986 471 857	→ 33														
0 986 473 857															





◀ AUDI A4 [8D2; B5]								
	2.8	02.97-07.97	128	Fg.-Nr. 8D..V..168 351→		0986 472 830	← 38	1987 470 040 <sup>7</sup>
						0986 474 830		1987 474 496 <sup>8</sup>
						0986 472 831	→ 38	1987 470 040 <sup>7</sup>
						0986 474 831		
		02.97-12.98	142	Fg.-Nr. 8D..V..168 351→		0986 472 830	← 38	1987 470 040 <sup>7</sup>
						0986 474 830		1987 474 496 <sup>8</sup>
						0986 472 831	→ 38	1987 470 040 <sup>7</sup>
						0986 474 831		
		08.97-06.00	142			0986 472 830	← 38	1987 470 040 <sup>7</sup>
						0986 474 830		1987 474 496 <sup>8</sup>
						0986 472 831	→ 38	1987 470 040 <sup>7</sup>
						0986 474 831		
	03.99-10.00	140			0986 472 830	← 38	1987 470 040 <sup>7</sup>	
					0986 474 830		1987 474 496 <sup>8</sup>	
					0986 472 831	→ 38	1987 470 040 <sup>7</sup>	
					0986 474 831			
	2.8 quattro	11.94-12.96	128			0986 474 841	← 38	1987 470 040 <sup>7</sup>
						0986 474 842	→ 38	1987 470 040 <sup>7</sup>
						0986 474 841	← 38	1987 470 040 <sup>7</sup>
						0986 474 842	→ 38	1987 470 040 <sup>7</sup>
		02.99-06.00	142		INB	0986 135 068	→ 43	1987 474 496 <sup>8</sup>
		02.99-10.00	142		INB	0986 134 068	← 43	F 026 A06 121 <sup>7</sup>
						0986 134 068	← 43	1987 474 496 <sup>8</sup>
						0986 135 068	→ 43	F 026 A06 121 <sup>7</sup>
					INB	0986 474 841	← 38	1987 470 040 <sup>7</sup>
						0986 474 842	→ 38	1987 470 040 <sup>7</sup>
		09.99-10.00	140		INB	0986 134 068	← 43	F 026 A06 121 <sup>7</sup>
						0986 134 068	← 43	1987 474 496 <sup>8</sup>
					0986 135 068	→ 43	F 026 A06 121 <sup>7</sup>	
				INB	0986 474 841	← 38	1987 470 040 <sup>7</sup>	
					0986 474 842	→ 38	1987 470 040 <sup>7</sup>	
	1.6	11.94-10.00	74/75			1987 477 659	↔ 1812	
	1.8	11.94-10.00	85/92/110/132			1987 477 659	↔ 1812	
	1.8 T	11.94-10.00	85/92/110/132			1987 477 659	↔ 1812	
	1.9 TDI	11.94-11.00	55/66/81/85			1987 477 659	↔ 1812	
	2.4	07.95-10.00	110/120/121			1987 477 659	↔ 1812	
	2.5 TDI	08.97-10.00	110			1987 477 659	↔ 1812	
	2.6	11.94-07.98	102/110			1987 477 659	↔ 1812	
2.8	11.94-10.00	128/140/142			1987 477 659	↔ 1812		
	1.6	11.94-10.96	74			0986 594 014 <sup>3</sup>		
		11.94-06.00	74			0986 594 005 <sup>4</sup>		
		10.96-12.98	74	Fg.-Nr. →8D..X..199 999		0986 594 014 <sup>3</sup>		
		01.99-06.00	74	Fg.-Nr. 8D..X..200 001→		0986 594 002 <sup>3</sup>		
		06.00-10.00	75			0986 594 002 <sup>3</sup>		
						0986 594 005 <sup>4</sup>		
	1.8	11.94-12.98	92	Fg.-Nr. →8D..X..199 999		0986 594 014 <sup>3</sup>		
		11.94-10.00	92			0986 594 005 <sup>4</sup>		
		04.95-12.98	85	Fg.-Nr. →8D..X..199 999		0986 594 014 <sup>3</sup>		
		04.95-06.00	85			0986 594 005 <sup>4</sup>		
		01.99-06.00	85	Fg.-Nr. 8D..X..200 001→		0986 594 002 <sup>3</sup>		
		01.99-10.00	92	Fg.-Nr. 8D..X..200 001→		0986 594 002 <sup>3</sup>		
		04.99-10.00	92			0986 594 002 <sup>3</sup>		
	1.8 quattro	11.94-12.98	92	Fg.-Nr. →8D..X..199 999		0986 594 014 <sup>3</sup>		
		07.95-12.98	85	Fg.-Nr. →8D..X..199 999		0986 594 014 <sup>3</sup>		
06.98-04.99		92	Fg.-Nr. 8D..W..280 001→	ALR,LAB	0 265 006 571 <sup>4</sup>			
				ALR,RAB	0 265 006 569 <sup>4</sup>			
				ALR	0 265 006 569 <sup>4</sup>			













































									
1.8 quattro	06.98-10.01	85	Fg.-Nr. 8D..W..280 001→	ALR,LAB	0 265 006 571 <sup>4</sup>				
				ALR,RAB	0 265 006 569 <sup>4</sup>				
				ALR	0 265 006 569 <sup>4</sup>				
	01.99-04.99	92	Fg.-Nr. 8D..X..200 001→	SCK	0 265 006 578 <sup>3</sup>				
				STK	0 986 594 002 <sup>3</sup>				
	01.99-10.01	85	Fg.-Nr. 8D..X..200 001→	SCK	0 265 006 578 <sup>3</sup>				
				STK	0 986 594 002 <sup>3</sup>				
	02.99-10.00	92		ALR,LAB	0 265 006 571 <sup>4</sup>				
				ALR,RAB	0 265 006 569 <sup>4</sup>				
				ALR	0 265 006 569 <sup>4</sup>				
				SCK	0 265 006 578 <sup>3</sup>				
				STK	0 986 594 002 <sup>3</sup>				
1.8 T	11.94-07.98	110			0 986 594 014 <sup>3</sup>				
	11.94-10.00	110			0 986 594 005 <sup>4</sup>				
	08.97-12.98	132			0 986 594 005 <sup>4</sup>				
					0 986 594 014 <sup>3</sup>				
	08.98-12.98	110	Fg.-Nr. →8D..X..199 999		0 986 594 014 <sup>3</sup>				
	01.99-07.99	110	Fg.-Nr. 8D..X..200 001→		0 986 594 002 <sup>3</sup>				
	05.99-10.00	110			0 986 594 002 <sup>3</sup>				
1.8 T quattro	11.94-12.98	110			0 986 594 014 <sup>3</sup>				
	08.97-12.98	132	Fg.-Nr. →8D..X..199 999		0 986 594 014 <sup>3</sup>				
	06.98-12.98	110	Fg.-Nr. 8D..W..280 001→	ALR,LAB	0 265 006 571 <sup>4</sup>				
				ALR,RAB	0 265 006 569 <sup>4</sup>				
				ALR	0 265 006 569 <sup>4</sup>				
	06.98-10.00	132	Fg.-Nr. 8D..W..280 001→	ALR,LAB	0 265 006 571 <sup>4</sup>				
				ALR,RAB	0 265 006 569 <sup>4</sup>				
				ALR	0 265 006 569 <sup>4</sup>				
	07.98-10.00	110		ALR,LAB	0 265 006 571 <sup>4</sup>				
				ALR,RAB	0 265 006 569 <sup>4</sup>				
				ALR	0 265 006 569 <sup>4</sup>				
				SCK	0 265 006 578 <sup>3</sup>				
				STK	0 986 594 002 <sup>3</sup>				
	01.99-10.00	132	Fg.-Nr. 8D..X..200 001→	SCK	0 265 006 578 <sup>3</sup>				
				STK	0 986 594 002 <sup>3</sup>				
1.8 T	05.00-08.01	125			0 986 594 002 <sup>3</sup>				
1.8 T quattro					0 986 594 005 <sup>4</sup>				
1.9 TDI	11.94-10.00	66			0 986 594 005 <sup>4</sup>				
					0 986 594 014 <sup>3</sup>				
	02.96-12.98	81	Fg.-Nr. →8D..X..199 999		0 986 594 014 <sup>3</sup>				
	02.96-06.00	81			0 986 594 005 <sup>4</sup>				
	03.96-12.98	55	Fg.-Nr. →8D..X..199 999		0 986 594 014 <sup>3</sup>				
	03.96-06.00	55			0 986 594 005 <sup>4</sup>				
	08.98-11.00	85			0 986 594 005 <sup>4</sup>				
					0 986 594 014 <sup>3</sup>				
	01.99-07.99	81	Fg.-Nr. 8D..X..200 001→		0 986 594 002 <sup>3</sup>				
	01.99-06.00	55	Fg.-Nr. 8D..X..200 001→		0 986 594 002 <sup>3</sup>				
	08.99-06.00	81			0 986 594 002 <sup>3</sup>				
	1.9 TDI quattro	07.96-12.98	81			0 986 594 014 <sup>3</sup>			
		06.98-12.98	81	Fg.-Nr. 8D..W..280 001→	ALR,LAB	0 265 006 571 <sup>4</sup>			
ALR,RAB					0 265 006 569 <sup>4</sup>				
ALR					0 265 006 569 <sup>4</sup>				
12.98-12.98		85			0 986 594 014 <sup>3</sup>				
				ALR,LAB	0 265 006 571 <sup>4</sup>				
				ALR,RAB	0 265 006 569 <sup>4</sup>				
08.99-01.00		81		ALR	0 265 006 569 <sup>4</sup>				
				ALR,LAB	0 265 006 571 <sup>4</sup>				
				ALR,RAB	0 265 006 569 <sup>4</sup>				
	ALR			0 265 006 569 <sup>4</sup>					
			SCK	0 265 006 578 <sup>3</sup>					
			STK	0 986 594 002 <sup>3</sup>					

















									
 <b>◀ AUDI A4 [8D2; B5]</b>									
1.9 TDI quattro	01.00-10.00	85					ALR,LAB	0 265 006 571 <sup>4</sup>	
							ALR,RAB	0 265 006 569 <sup>4</sup>	
							<del>ALR</del>	0 265 006 569 <sup>4</sup>	
							SCK	0 265 006 578 <sup>3</sup>	
							STK	0 986 594 002 <sup>3</sup>	
<b>2.4</b>	07.95-07.97	110						0 986 594 005 <sup>4</sup>	
								0 986 594 014 <sup>3</sup>	
	08.97-07.98	120						0 986 594 014 <sup>3</sup>	
		121						0 986 594 014 <sup>3</sup>	
	08.97-10.00	120						0 986 594 005 <sup>4</sup>	
		121						0 986 594 005 <sup>4</sup>	
	08.98-12.98	120	Fg.-Nr. →8D..X..199 999					0 986 594 014 <sup>3</sup>	
		121	Fg.-Nr. →8D..X..199 999					0 986 594 014 <sup>3</sup>	
	01.99-06.00	120	Fg.-Nr. 8D..X..200 001→					0 986 594 002 <sup>3</sup>	
	01.99-10.00	121	Fg.-Nr. 8D..X..200 001→					0 986 594 002 <sup>3</sup>	
	06.00-10.00	120						0 986 594 002 <sup>3</sup>	
<b>2.4 quattro</b>	08.97-07.98	120						0 986 594 014 <sup>3</sup>	
	08.97-12.98	121						0 986 594 014 <sup>3</sup>	
	06.98-07.98	120	Fg.-Nr. 8D..W..280 001→				ALR,LAB	0 265 006 571 <sup>4</sup>	
							ALR,RAB	0 265 006 569 <sup>4</sup>	
							<del>ALR</del>	0 265 006 569 <sup>4</sup>	
		121	Fg.-Nr. 8D..W..280 001→				ALR,LAB	0 265 006 571 <sup>4</sup>	
							ALR,RAB	0 265 006 569 <sup>4</sup>	
							<del>ALR</del>	0 265 006 569 <sup>4</sup>	
	08.98-12.98	121					ALR,LAB	0 265 006 571 <sup>4</sup>	
							ALR,RAB	0 265 006 569 <sup>4</sup>	
							<del>ALR</del>	0 265 006 569 <sup>4</sup>	
	02.99-06.00	120					ALR,LAB	0 265 006 571 <sup>4</sup>	
							ALR,RAB	0 265 006 569 <sup>4</sup>	
							<del>ALR</del>	0 265 006 569 <sup>4</sup>	
							SCK	0 265 006 578 <sup>3</sup>	
							STK	0 986 594 002 <sup>3</sup>	
	02.99-10.00	121					ALR,LAB	0 265 006 571 <sup>4</sup>	
							ALR,RAB	0 265 006 569 <sup>4</sup>	
							<del>ALR</del>	0 265 006 569 <sup>4</sup>	
							SCK	0 265 006 578 <sup>3</sup>	
							STK	0 986 594 002 <sup>3</sup>	
<b>2.5 TDI</b>	08.97-12.98	110	Fg.-Nr. →8D..X..199 999					0 986 594 014 <sup>3</sup>	
	08.97-10.00	110						0 986 594 005 <sup>4</sup>	
	01.99-10.00	110	Fg.-Nr. 8D..X..200 001→					0 986 594 002 <sup>3</sup>	
<b>2.5 TDI quattro</b>	11.97-12.98	110	Fg.-Nr. →8D..X..199 999					0 986 594 014 <sup>3</sup>	
	06.98-06.00	110	Fg.-Nr. 8D..W..280 001→				ALR,LAB	0 265 006 571 <sup>4</sup>	
							ALR,RAB	0 265 006 569 <sup>4</sup>	
							<del>ALR</del>	0 265 006 569 <sup>4</sup>	
	01.99-06.00	110	Fg.-Nr. 8D..X..200 001→				SCK	0 265 006 578 <sup>3</sup>	
							STK	0 986 594 002 <sup>3</sup>	
	02.99-10.00	110					ALR,LAB	0 265 006 571 <sup>4</sup>	
							ALR,RAB	0 265 006 569 <sup>4</sup>	
							<del>ALR</del>	0 265 006 569 <sup>4</sup>	
							SCK	0 265 006 578 <sup>3</sup>	
							STK	0 986 594 002 <sup>3</sup>	
<b>2.6</b>	11.94-07.98	110						0 986 594 005 <sup>4</sup>	
								0 986 594 014 <sup>3</sup>	
	01.96-07.97	102						0 986 594 005 <sup>4</sup>	
								0 986 594 014 <sup>3</sup>	
<b>2.6 quattro</b>	11.94-07.98	110						0 986 594 014 <sup>3</sup>	
	04.95-07.97	102						0 986 594 014 <sup>3</sup>	
	06.98-07.98	110	Fg.-Nr. 8D..W..280 001→				ALR,LAB	0 265 006 571 <sup>4</sup>	
							ALR,RAB	0 265 006 569 <sup>4</sup>	
							<del>ALR</del>	0 265 006 569 <sup>4</sup>	



		<b>S</b>							
<b>2.8</b>	11.94-07.97	128					0 986 594 005 <sup>4</sup>		
							0 986 594 014 <sup>3</sup>		
	03.96-12.98	142					0 986 594 014 <sup>3</sup>		
	03.96-06.00	142					0 986 594 005 <sup>4</sup>		
	01.99-06.00	142	Fg.-Nr. 8D..X..200 001→				0 986 594 002 <sup>3</sup>		
	03.99-10.00	140					0 986 594 002 <sup>3</sup>		
							0 986 594 005 <sup>4</sup>		
<b>2.8 quattro</b>	11.94-12.96	128					0 986 594 014 <sup>3</sup>		
	03.96-07.98	142					0 986 594 014 <sup>3</sup>		
	06.98-07.98	142	Fg.-Nr. 8D..W..280 001→		ALR,LAB		0 265 006 571 <sup>4</sup>		
					ALR,RAB		0 265 006 569 <sup>4</sup>		
					ALR		0 265 006 569 <sup>4</sup>		
	02.99-10.00	142			ALR,LAB		0 265 006 571 <sup>4</sup>		
					ALR,RAB		0 265 006 569 <sup>4</sup>		
					ALR		0 265 006 569 <sup>4</sup>		
					SCK		0 265 006 578 <sup>3</sup>		
					STK		0 986 594 002 <sup>3</sup>		
	09.99-10.00	140			ALR,LAB		0 265 006 571 <sup>4</sup>		
					ALR,RAB		0 265 006 569 <sup>4</sup>		
					ALR		0 265 006 569 <sup>4</sup>		
				SCK		0 265 006 578 <sup>3</sup>			
				STK		0 986 594 002 <sup>3</sup>			
<b>A4 [8EC; B7]</b>									
									
 <b>1.6</b>	11.04-05.07	75	Fg.-Nr. →8E..7..300 000, PR-Code 1LZ	228			0 986 474 897	 54	1 987 470 287 <sup>7</sup>
							0 986 474 898	 54	1 987 470 287 <sup>7</sup>
	11.04-06.08	75	PR-Code 1LB, PR-Code 1LE	288			0 986 473 070	 56,93	1 987 470 005 <sup>7</sup>
							0 986 473 070	 56,93	1 987 470 506 <sup>8</sup>
							0 986 474 070	 56,93	1 987 470 005 <sup>7</sup>
	06.07-06.08	75	Fg.-Nr. 8E..8..000 001→, PR-Code 1LZ	228			0 986 474 897	 54	1 987 470 287 <sup>7</sup>
							0 986 474 898	 54	1 987 470 287 <sup>7</sup>
<b>1.8 T</b> <b>1.8 T quattro</b>	11.04-05.07	120	Fg.-Nr. →8E..7..300 000, PR-Code 1LZ	228			0 986 474 897	 54	1 987 470 287 <sup>7</sup>
							0 986 474 898	 54	1 987 470 287 <sup>7</sup>
	11.04-06.08	120	PR-Code 1LB, PR-Code 1LE	288			0 986 473 070	 56,93	1 987 470 005 <sup>7</sup>
							0 986 473 070	 56,93	1 987 470 506 <sup>8</sup>
							0 986 474 070	 56,93	1 987 470 005 <sup>7</sup>
	06.07-06.08	120	Fg.-Nr. 8E..8..000 001→, PR-Code 1LZ	228			0 986 474 897	 54	1 987 470 287 <sup>7</sup>
							0 986 474 898	 54	1 987 470 287 <sup>7</sup>
<b>1.9 TDI</b>	11.04-11.05	84	PR-Code 1LB, PR-Code 1LE	288			0 986 473 070	 56,93	1 987 470 005 <sup>7</sup>
							0 986 473 070	 56,93	1 987 470 506 <sup>8</sup>
							0 986 474 070	 56,93	1 987 470 005 <sup>7</sup>
			PR-Code 1LZ	228			0 986 474 897	 54	1 987 470 287 <sup>7</sup>
							0 986 474 898	 54	1 987 470 287 <sup>7</sup>
	01.06-05.07	85	Fg.-Nr. →8E..7..300 000, PR-Code 1LZ	228			0 986 474 897	 54	1 987 470 287 <sup>7</sup>
							0 986 474 898	 54	1 987 470 287 <sup>7</sup>
	01.06-06.08	85	PR-Code 1LB, PR-Code 1LE	288			0 986 473 070	 56,93	1 987 470 005 <sup>7</sup>
							0 986 473 070	 56,93	1 987 470 506 <sup>8</sup>
							0 986 474 070	 56,93	1 987 470 005 <sup>7</sup>
	06.07-06.08	85	Fg.-Nr. 8E..8..000 001→, PR-Code 1LZ	228			0 986 474 897	 54	1 987 470 287 <sup>7</sup>
							0 986 474 898	 54	1 987 470 287 <sup>7</sup>
<b>2.0</b>	11.04-05.07	96	Fg.-Nr. →8E..7..300 000, PR-Code 1LZ	228			0 986 474 897	 54	1 987 470 287 <sup>7</sup>
							0 986 474 898	 54	1 987 470 287 <sup>7</sup>
	11.04-06.08	96	PR-Code 1LB, PR-Code 1LE	288			0 986 473 070	 56,93	1 987 470 005 <sup>7</sup>
							0 986 473 070	 56,93	1 987 470 506 <sup>8</sup>
							0 986 474 070	 56,93	1 987 470 005 <sup>7</sup>
	06.07-06.08	96	Fg.-Nr. 8E..8..000 001→, PR-Code 1LZ	228			0 986 474 897	 54	1 987 470 287 <sup>7</sup>
							0 986 474 898	 54	1 987 470 287 <sup>7</sup>





		S									
2.7 TDI	11.05-06.08	120/132	PR-Code 1LA, PR-Code 1LC				0 986 473 229	← 60			
							0 986 474 229	→ 60			
							PR-Code 1LB, PR-Code 1LE	288	0 986 473 070	← 56,93	1 987 470 005 <sup>7</sup>
									0 986 473 070	← 56,93	1 987 470 506 <sup>B</sup>
							PR-Code 1LT, PR-Code 1LF	312	0 986 474 070	→ 56,93	1 987 470 005 <sup>7</sup>
									0 986 473 070	← 56,93	1 987 470 005 <sup>7</sup>
0 986 473 070	← 56,93	1 987 470 506 <sup>B</sup>									
0 986 474 070	→ 56,93	1 987 470 005 <sup>7</sup>									
3.0, quattro, TDI quattro	11.04-06.08	150/160/ 171	PR-Code 1LA, PR-Code 1LC				0 986 473 229	← 60			
							0 986 474 229	→ 60			
3.2 FSI	01.05-06.08	188	PR-Code 1LA, PR-Code 1LC				0 986 473 229	← 60			
3.2 FSI quattro							0 986 474 229	→ 60			
											
	1.6	11.04-06.08	75			212,245	0 986 473 109	← 38,1	1 987 470 040 <sup>7</sup>		
							0 986 473 109	← 38,1	1 987 474 496 <sup>B</sup>		
							0 986 474 109	→ 38,1	1 987 470 040 <sup>7</sup>		
1.8 T 1.8 T quattro	11.04-06.08	120				212	0 986 473 109	← 38,1	1 987 470 040 <sup>7</sup>		
							0 986 473 109	← 38,1	1 987 474 496 <sup>B</sup>		
							0 986 474 109	→ 38,1	1 987 470 040 <sup>7</sup>		
1.9 TDI	11.04-11.05	84				212,245	0 986 473 109	← 38,1	1 987 470 040 <sup>7</sup>		
							0 986 473 109	← 38,1	1 987 474 496 <sup>B</sup>		
							0 986 474 109	→ 38,1	1 987 470 040 <sup>7</sup>		
	01.06-06.08	85				212,245	0 986 473 109	← 38,1	1 987 470 040 <sup>7</sup>		
							0 986 473 109	← 38,1	1 987 474 496 <sup>B</sup>		
							0 986 474 109	→ 38,1	1 987 470 040 <sup>7</sup>		
2.0 2.0 TDI 2.0 TDI quattro	11.04-06.08	89/93/96/ 100/103				212,245	0 986 473 109	← 38,1	1 987 470 040 <sup>7</sup>		
							0 986 473 109	← 38,1	1 987 474 496 <sup>B</sup>		
							0 986 474 109	→ 38,1	1 987 470 040 <sup>7</sup>		
2.0 TDI	06.06-06.08	120				212,245	0 986 473 109	← 38,1	1 987 470 040 <sup>7</sup>		
							0 986 473 109	← 38,1	1 987 474 496 <sup>B</sup>		
							0 986 474 109	→ 38,1	1 987 470 040 <sup>7</sup>		
2.0 TDI quattro	06.06-06.08	120				212	0 986 473 109	← 38,1	1 987 470 040 <sup>7</sup>		
							0 986 473 109	← 38,1	1 987 474 496 <sup>B</sup>		
							0 986 474 109	→ 38,1	1 987 470 040 <sup>7</sup>		
2.0 TDI 2.0 TDI quattro 2.0 TFSI	06.06-06.08	125				212	0 986 473 109	← 38,1	1 987 470 040 <sup>7</sup>		
							0 986 473 109	← 38,1	1 987 474 496 <sup>B</sup>		
							0 986 474 109	→ 38,1	1 987 470 040 <sup>7</sup>		
2.5 TDI	11.04-05.06	120				212	0 986 473 109	← 38,1	1 987 470 040 <sup>7</sup>		
							0 986 473 109	← 38,1	1 987 474 496 <sup>B</sup>		
							0 986 474 109	→ 38,1	1 987 470 040 <sup>7</sup>		
2.7 TDI	11.05-06.08	120				212	0 986 473 109	← 38,1	1 987 470 040 <sup>7</sup>		
							0 986 473 109	← 38,1	1 987 474 496 <sup>B</sup>		
							0 986 474 109	→ 38,1	1 987 470 040 <sup>7</sup>		
											
	1.6	11.04-06.08	75				1 987 477 922	← 1928			
							1 987 477 923	→ 2005			
							1.8 T	11.04-06.08	120		
1 987 477 923	→ 2005										
1.8 T quattro	11.04-06.08	120				SSZ	1 987 477 257	← 1736			
							1 987 477 923	→ 2005			
							1 987 477 257	↔ 1736			
1.9 TDI	11.04-11.05	84					1 987 477 922	← 1928			
							1 987 477 923	→ 2005			
	01.06-06.08	85				1 987 477 922	← 1928				
2.0	11.04-06.08	89/93/96/ 100					1 987 477 922	← 1928			
2.0 TDI							1 987 477 923	→ 2005			
2.0 TDI	11.04-06.08	103/120/125					1 987 477 923	→ 2005			

		S							
	◀ AUDI A4 [8EC; B7]								
2.0 TDI quattro	01.06-06.08	103/120/125				SSZ	1987 477 257	← 1736	
							1987 477 923	→ 2005	
						SSZ	1987 477 257	↔ 1736	
2.0 TDI, TFSI	11.04-06.08	103/120/125					1987 477 922	← 1928	
2.0 TFSI	11.04-06.08	147					1987 477 922	← 1928	
	06.05-06.08	162					1987 477 922	← 1928	
							1987 477 923	→ 2005	
	10.06-06.08	103/120/125					1987 477 923	→ 2005	
2.0 TFSI quattro	11.04-06.08	147				SSZ	1987 477 257	← 1736	
							1987 477 923	→ 2005	
						SSZ	1987 477 257	↔ 1736	
	01.05-05.06	147					1987 477 257	← 1736	
							1987 477 923	→ 2005	
	06.05-06.08	162				SSZ	1987 477 257	← 1736	
							1987 477 923	→ 2005	
						SSZ	1987 477 257	↔ 1736	
2.5 TDI	11.04-05.06	120					1987 477 922	← 1928	
							1987 477 923	→ 2005	
2.7 TDI	11.05-06.08	120/132					1987 477 922	← 1928	
							1987 477 923	→ 2005	
3.0	11.04-05.06	160					1987 477 922	← 1928	
							1987 477 923	→ 2005	
3.0 quattro	11.04-05.06	160				SSZ	1987 477 257	← 1736	
							1987 477 923	→ 2005	
						SSZ	1987 477 257	↔ 1736	
3.0 TDI quattro	01.05-05.06	150				SSZ	1987 477 257	← 1736	
							1987 477 923	→ 2005	
						SSZ	1987 477 257	↔ 1736	
	01.06-06.08	171				SSZ	1987 477 257	← 1736	
							1987 477 923	→ 2005	
						SSZ	1987 477 257	↔ 1736	
3.2 FSI	01.05-06.08	188					1987 477 922	← 1928	
							1987 477 923	→ 2005	
3.2 FSI quattro	01.05-06.08	188				SSZ	1987 477 257	← 1736	
							1987 477 923	→ 2005	
						SSZ	1987 477 257	↔ 1736	
	1.6	11.04-06.08	75				0 265 006 809 <sup>3</sup>		
						ALR,LAB	0 265 006 828 <sup>4</sup>		
						ALR,RAB	0 265 006 824 <sup>4</sup>		
						ALR	0 265 006 824 <sup>4</sup>		
1.8 T	11.04-06.08	120					0 265 006 809 <sup>3</sup>		
1.8 T quattro						ALR,LAB	0 265 006 828 <sup>4</sup>		
						ALR,RAB	0 265 006 824 <sup>4</sup>		
						ALR	0 265 006 824 <sup>4</sup>		
1.9 TDI	11.04-11.05	84					0 265 006 809 <sup>3</sup>		
						ALR,LAB	0 265 006 828 <sup>4</sup>		
						ALR,RAB	0 265 006 824 <sup>4</sup>		
						ALR	0 265 006 824 <sup>4</sup>		
	01.06-06.08	85					0 265 006 809 <sup>3</sup>		
						ALR,LAB	0 265 006 828 <sup>4</sup>		
						ALR,RAB	0 265 006 824 <sup>4</sup>		
						ALR	0 265 006 824 <sup>4</sup>		
2.0, TDI, TDI quattro, TFSI, TFSI quattro	11.04-06.08	89/93/96/100/103/120/125/147/162					0 265 006 809 <sup>3</sup>		
						ALR,LAB	0 265 006 828 <sup>4</sup>		
						ALR,RAB	0 265 006 824 <sup>4</sup>		
						ALR	0 265 006 824 <sup>4</sup>		
2.5 TDI	11.04-05.06	120					0 265 006 809 <sup>3</sup>		
						ALR,LAB	0 265 006 828 <sup>4</sup>		
						ALR,RAB	0 265 006 824 <sup>4</sup>		
						ALR	0 265 006 824 <sup>4</sup>		





			S							
	◀ AUDI A4 [8E2; B6]									
2.4	04.01-12.04 120/125	228	0986 474 897	☞ ← 54	1987 470 287 <sup>7</sup>					
			0986 474 898	☞ → 54	1987 470 287 <sup>7</sup>					
		288	0986 473 070	☞ ← 56,93	1987 470 506 <sup>8</sup>					
			0986 474 070	☞ → 56,93	1987 470 506 <sup>8</sup>					
		312	0986 473 070	☞ ← 56,93	1987 470 005 <sup>7</sup>					
			0986 473 070	☞ ← 56,93	1987 470 506 <sup>8</sup>					
	0986 474 070	☞ → 56,93	1987 470 005 <sup>7</sup>							
		☞ → 56,93	1987 470 005 <sup>7</sup>							
	2.5 TDI 2.5 TDI quattro	12.00-05.03 114/120/ 132	228	0986 474 897	☞ ← 54	1987 470 287 <sup>7</sup>				
				0986 474 898	☞ → 54	1987 470 287 <sup>7</sup>				
		12.00-12.04 114/120/ 132	288	0986 473 070	☞ ← 56,93	1987 470 506 <sup>8</sup>				
				0986 474 070	☞ → 56,93	1987 470 506 <sup>8</sup>				
312		0986 473 070	☞ ← 56,93	1987 470 005 <sup>7</sup>						
		0986 473 070	☞ ← 56,93	1987 470 506 <sup>8</sup>						
0986 474 070	☞ → 56,93	1987 470 005 <sup>7</sup>								
3.0 3.0 quattro	12.00-12.04 160/162	228	0986 474 897	☞ ← 54	1987 470 287 <sup>7</sup>					
			0986 474 898	☞ → 54	1987 470 287 <sup>7</sup>					
		288	0986 473 070	☞ ← 56,93	1987 470 506 <sup>8</sup>					
			0986 474 070	☞ → 56,93	1987 470 506 <sup>8</sup>					
		312	0986 473 070	☞ ← 56,93	1987 470 005 <sup>7</sup>					
			0986 473 070	☞ ← 56,93	1987 470 506 <sup>8</sup>					
0986 474 070	☞ → 56,93	1987 470 005 <sup>7</sup>								
	1.6	10.00-12.04 75								
1.6	10.00-12.04 75	75	0986 473 109	☞ ← 38,1	1987 470 040 <sup>7</sup>					
			0986 473 109	☞ ← 38,1	1987 474 496 <sup>8</sup>					
			0986 474 109	☞ → 38,1	1987 470 040 <sup>7</sup>					
1.8 i Turbo 1.8 T 1.8 T quattro	12.00-08.08 110/120	110/120	0986 473 109	☞ ← 38,1	1987 470 040 <sup>7</sup>					
			0986 473 109	☞ ← 38,1	1987 474 496 <sup>8</sup>					
			0986 474 109	☞ → 38,1	1987 470 040 <sup>7</sup>					
1.8 T 1.8 T quattro	07.01-08.05 125	125	0986 473 109	☞ ← 38,1	1987 470 040 <sup>7</sup>					
			0986 474 109	☞ → 38,1	1987 470 040 <sup>7</sup>					
	11.02-12.04 140	140	0986 473 109	☞ ← 38,1	1987 470 040 <sup>7</sup>					
0986 473 109	☞ ← 38,1	1987 474 496 <sup>8</sup>								
0986 474 109	☞ → 38,1	1987 470 040 <sup>7</sup>								
1.9 TDI 1.9 TDI quattro	12.00-12.04 74/85/96	74/85/96	0986 473 109	☞ ← 38,1	1987 470 040 <sup>7</sup>					
			0986 473 109	☞ ← 38,1	1987 474 496 <sup>8</sup>					
			0986 474 109	☞ → 38,1	1987 470 040 <sup>7</sup>					
2.0 2.0 FSI	12.00-12.04 96/110	96/110	0986 473 109	☞ ← 38,1	1987 470 040 <sup>7</sup>					
			0986 473 109	☞ ← 38,1	1987 474 496 <sup>8</sup>					
			0986 474 109	☞ → 38,1	1987 470 040 <sup>7</sup>					
2.4	04.01-12.04 120/125	120/125	0986 473 109	☞ ← 38,1	1987 470 040 <sup>7</sup>					
			0986 473 109	☞ ← 38,1	1987 474 496 <sup>8</sup>					
			0986 474 109	☞ → 38,1	1987 470 040 <sup>7</sup>					
2.5 TDI	04.01-06.02 114	114	0986 473 109	☞ ← 38,1	1987 470 040 <sup>7</sup>					
			0986 473 109	☞ ← 38,1	1987 474 496 <sup>8</sup>					
			0986 474 109	☞ → 38,1	1987 470 040 <sup>7</sup>					
2.5 TDI 2.5 TDI quattro	12.00-12.04 120/132	120/132	0986 473 109	☞ ← 38,1	1987 470 040 <sup>7</sup>					
			0986 473 109	☞ ← 38,1	1987 474 496 <sup>8</sup>					
	07.02-12.04 120/132	120/132	0986 474 109	☞ → 38,1	1987 474 496 <sup>8</sup>					
3.0	12.00-08.05 162	162	0986 473 109	☞ ← 38,1	1987 470 040 <sup>7</sup>					
			0986 473 109	☞ ← 38,1	1987 474 496 <sup>8</sup>					
			0986 474 109	☞ → 38,1	1987 470 040 <sup>7</sup>					
3.0 3.0 quattro	03.01-12.04 160	160	0986 473 109	☞ ← 38,1	1987 470 040 <sup>7</sup>					
			0986 473 109	☞ ← 38,1	1987 474 496 <sup>8</sup>					
			0986 474 109	☞ → 38,1	1987 470 040 <sup>7</sup>					
3.0 quattro	12.00-12.04 162	162	0986 473 109	☞ ← 38,1	1987 474 496 <sup>8</sup>					
			0986 474 109	☞ → 38,1	1987 470 040 <sup>7</sup>					
			0986 474 109	☞ → 38,1	1987 474 496 <sup>8</sup>					



	<b>1.6</b>	10.00-12.04	75			1 987 477 922	← 1928
						1 987 477 923	→ 2005
	<b>1.8 T</b>	12.00-06.02	110			1 987 477 922	← 1928
						1 987 477 923	→ 2005
		07.01-08.05	125			1 987 477 922	← 1928
						1 987 477 923	→ 2005
		07.02-12.04	120			1 987 477 922	← 1928
						1 987 477 923	→ 2005
		11.02-12.04	140			1 987 477 922	← 1928
						1 987 477 923	→ 2005
	<b>1.8 T quattro</b>	12.00-06.02	110		SSZ	1 987 477 259	1727
		07.01-12.04	125		SSZ	1 987 477 259	1727
		07.02-05.03	120	Fg.-Nr. →8E..3..500 000	SSZ	1 987 477 259	1727
		07.02-12.04	120		SSZ	1 987 477 259	1727
		11.02-05.03	140	Fg.-Nr. →8E..3..500 000	SSZ	1 987 477 259	1727
	11.02-12.04	140		SSZ	1 987 477 259	1727	
<b>1.9 TDI</b>	12.00-12.04	96			1 987 477 922	← 1928	
					1 987 477 923	→ 2005	
	04.01-12.04	74/85			1 987 477 922	← 1928	
					1 987 477 923	→ 2005	
<b>1.9 TDI quattro</b>	04.01-05.03	96	Fg.-Nr. →8E..3..500 000	SSZ	1 987 477 259	1727	
	04.01-12.04	96		SSZ	1 987 477 259	1727	
<b>2.0</b>	12.00-12.04	96/110			1 987 477 922	← 1928	
<b>2.0 FSI</b>					1 987 477 923	→ 2005	
<b>2.4</b>	04.01-12.04	120/125			1 987 477 922	← 1928	
					1 987 477 923	→ 2005	
<b>2.5 TDI</b>	04.01-12.04	114/120			1 987 477 922	← 1928	
					1 987 477 923	→ 2005	
<b>2.5 TDI quattro</b>	12.00-12.04	132		SSZ	1 987 477 259	1727	
	11.02-05.03	132	Fg.-Nr. →8E..3..500 000	SSZ	1 987 477 259	1727	
<b>3.0</b>	12.00-08.05	160/162			1 987 477 922	← 1928	
					1 987 477 923	→ 2005	
<b>3.0 quattro</b>	12.00-05.03	160/162	Fg.-Nr. →8E..3..500 000	SSZ	1 987 477 259	1727	
	12.00-12.04	160/162		SSZ	1 987 477 259	1727	

	<b>1.6</b>	10.00-05.03	75	Fg.-Nr. →8E..3..500 000		0 265 006 683 <sup>3</sup>	
		10.00-05.04	75	Fg.-Nr. →8E..4..050 000	ALR,LAB	0 265 006 707 <sup>4</sup>	
				Fg.-Nr. →8E..4..400 000	ALR,RAB	0 265 006 681 <sup>4</sup>	
					ALR	0 265 006 681 <sup>4</sup>	
		06.03-12.04	75	Fg.-Nr. 8E..4..000 001→		0 265 006 809 <sup>3</sup>	
		06.04-12.04	75	Fg.-Nr. 8E..5..000 001→	ALR,LAB	0 265 006 826 <sup>4</sup>	
					ALR,RAB	0 265 006 824 <sup>4</sup>	
					ALR	0 265 006 824 <sup>4</sup>	
	<b>1.8 i Turbo</b>	01.03-08.08	120			0 265 006 681 <sup>4</sup>	
	<b>1.8 i Turbo, T, T quattro</b>	07.02-05.03	120	Fg.-Nr. →8E..3..500 000		0 265 006 683 <sup>3</sup>	
		06.03-08.08	120	Fg.-Nr. 8E..4..000 001→		0 265 006 809 <sup>3</sup>	
	<b>1.8 T</b>	12.00-06.02	110			0 265 006 683 <sup>3</sup>	
	<b>1.8 T quattro</b>				ALR,LAB	0 265 006 707 <sup>4</sup>	
					ALR,RAB	0 265 006 681 <sup>4</sup>	
					ALR	0 265 006 681 <sup>4</sup>	
		07.01-08.05	125			0 265 006 683 <sup>3</sup>	
					ALR,LAB	0 265 006 707 <sup>4</sup>	
					ALR,RAB	0 265 006 681 <sup>4</sup>	
					ALR	0 265 006 681 <sup>4</sup>	
		07.02-05.04	120	Fg.-Nr. →8E..4..050 000	ALR,LAB	0 265 006 707 <sup>4</sup>	
				Fg.-Nr. →8E..4..400 000	ALR,RAB	0 265 006 681 <sup>4</sup>	
					ALR	0 265 006 681 <sup>4</sup>	
		11.02-05.03	140	Fg.-Nr. →8E..3..500 000		0 265 006 683 <sup>3</sup>	
		11.02-05.04	140	Fg.-Nr. →8E..4..050 000	ALR,LAB	0 265 006 707 <sup>4</sup>	
				Fg.-Nr. →8E..4..400 000	ALR,RAB	0 265 006 681 <sup>4</sup>	
				ALR	0 265 006 681 <sup>4</sup>		





<b>◀ AUDI A4 [8E2; B6]</b>									
<b>1.8 T</b>	06.03-12.04	140	Fg.-Nr. 8E..4..000 001→			0 265 006 809 <sup>3</sup>			
<b>1.8 T quattro</b>	06.04-12.04	120	Fg.-Nr. 8E..5..000 001→	ALR,LAB		0 265 006 826 <sup>4</sup>			
				ALR,RAB		0 265 006 824 <sup>4</sup>			
				ALR		0 265 006 824 <sup>4</sup>			
		140	Fg.-Nr. 8E..5..000 001→	ALR,LAB		0 265 006 826 <sup>4</sup>			
				ALR,RAB		0 265 006 824 <sup>4</sup>			
				ALR		0 265 006 824 <sup>4</sup>			
<b>1.9 TDI</b>	12.00-06.03	96				0 265 006 683 <sup>3</sup>			
				ALR,LAB		0 265 006 707 <sup>4</sup>			
				ALR,RAB		0 265 006 681 <sup>4</sup>			
				ALR		0 265 006 681 <sup>4</sup>			
	04.01-05.03	74	Fg.-Nr. →8E..3..500 000			0 265 006 683 <sup>3</sup>			
	04.01-05.04	74		ALR,LAB		0 265 006 707 <sup>4</sup>			
				ALR,RAB		0 265 006 681 <sup>4</sup>			
				ALR		0 265 006 681 <sup>4</sup>			
		96	Fg.-Nr. →8E..4..050 000	ALR,LAB		0 265 006 707 <sup>4</sup>			
			Fg.-Nr. →8E..4..400 000	ALR,RAB		0 265 006 681 <sup>4</sup>			
				ALR		0 265 006 681 <sup>4</sup>			
	06.03-05.04	74	Fg.-Nr. 8E..4..000 001→			0 265 006 809 <sup>3</sup>			
	06.04-12.04	85				0 265 006 809 <sup>3</sup>			
				ALR,LAB		0 265 006 826 <sup>4</sup>			
				ALR,RAB		0 265 006 824 <sup>4</sup>			
				ALR		0 265 006 824 <sup>4</sup>			
<b>1.9 TDI quattro</b>	04.01-05.03	96	Fg.-Nr. →8E..3..500 000			0 265 006 683 <sup>3</sup>			
	04.01-05.04	96	Fg.-Nr. →8E..4..050 000	ALR,LAB		0 265 006 707 <sup>4</sup>			
			Fg.-Nr. →8E..4..400 000	ALR,RAB		0 265 006 681 <sup>4</sup>			
				ALR		0 265 006 681 <sup>4</sup>			
<b>1.9 TDI</b>	06.03-12.04	96	Fg.-Nr. 8E..4..000 001→			0 265 006 809 <sup>3</sup>			
<b>1.9 TDI quattro</b>	06.04-12.04	96	Fg.-Nr. 8E..5..000 001→	ALR,LAB		0 265 006 826 <sup>4</sup>			
				ALR,RAB		0 265 006 824 <sup>4</sup>			
				ALR		0 265 006 824 <sup>4</sup>			
<b>2.0</b>	12.00-05.03	96/110	Fg.-Nr. →8E..3..500 000			0 265 006 683 <sup>3</sup>			
<b>2.0 FSI</b>	12.00-05.04	96/110	Fg.-Nr. →8E..4..050 000	ALR,LAB		0 265 006 707 <sup>4</sup>			
			Fg.-Nr. →8E..4..400 000	ALR,RAB		0 265 006 681 <sup>4</sup>			
				ALR		0 265 006 681 <sup>4</sup>			
	06.03-12.04	96/110	Fg.-Nr. 8E..4..000 001→			0 265 006 809 <sup>3</sup>			
	06.04-12.04	96/110	Fg.-Nr. 8E..5..000 001→	ALR,LAB		0 265 006 826 <sup>4</sup>			
				ALR,RAB		0 265 006 824 <sup>4</sup>			
				ALR		0 265 006 824 <sup>4</sup>			
<b>2.4</b>	04.01-05.03	120/125	Fg.-Nr. →8E..3..500 000			0 265 006 683 <sup>3</sup>			
	04.01-05.04	120/125	Fg.-Nr. →8E..4..050 000	ALR,LAB		0 265 006 707 <sup>4</sup>			
			Fg.-Nr. →8E..4..400 000	ALR,RAB		0 265 006 681 <sup>4</sup>			
				ALR		0 265 006 681 <sup>4</sup>			
	06.03-12.04	120/125	Fg.-Nr. 8E..4..000 001→			0 265 006 809 <sup>3</sup>			
	06.04-12.04	120/125	Fg.-Nr. 8E..5..000 001→	ALR,LAB		0 265 006 826 <sup>4</sup>			
				ALR,RAB		0 265 006 824 <sup>4</sup>			
				ALR		0 265 006 824 <sup>4</sup>			
<b>2.5 TDI</b>	04.01-06.02	114				0 265 006 683 <sup>3</sup>			
				ALR,LAB		0 265 006 707 <sup>4</sup>			
				ALR,RAB		0 265 006 681 <sup>4</sup>			
				ALR		0 265 006 681 <sup>4</sup>			
	07.02-05.03	120				0 265 006 683 <sup>3</sup>			
				ALR,LAB		0 265 006 707 <sup>4</sup>			
				ALR,RAB		0 265 006 681 <sup>4</sup>			
				ALR		0 265 006 681 <sup>4</sup>			
	06.03-05.04	120	Fg.-Nr. →8E..4..050 000	ALR,LAB		0 265 006 707 <sup>4</sup>			
			Fg.-Nr. →8E..4..400 000	ALR,RAB		0 265 006 681 <sup>4</sup>			
				ALR		0 265 006 681 <sup>4</sup>			
	06.03-12.04	120				0 265 006 809 <sup>3</sup>			
	06.04-12.04	120	Fg.-Nr. 8E..5..000 001→	ALR,LAB		0 265 006 826 <sup>4</sup>			
				ALR,RAB		0 265 006 824 <sup>4</sup>			
				ALR		0 265 006 824 <sup>4</sup>			



















		S									
2.5 TDI quattro		12.00-05.03	132				0 265 006 683 <sup>3</sup>				
				ALR,LAB		0 265 006 707 <sup>4</sup>					
				ALR,RAB		0 265 006 681 <sup>4</sup>					
									0 265 006 681 <sup>4</sup>		
		11.02-05.04	132	Fg.-Nr. →8E..4..050 000		ALR,LAB		0 265 006 707 <sup>4</sup>			
				Fg.-Nr. →8E..4..400 000		ALR,RAB		0 265 006 681 <sup>4</sup>			
						ALR		0 265 006 681 <sup>4</sup>			
		06.03-12.04	132	Fg.-Nr. 8E..4..000 001→			0 265 006 809 <sup>3</sup>				
		06.04-12.04	132	Fg.-Nr. 8E..5..000 001→		ALR,LAB		0 265 006 826 <sup>4</sup>			
						ALR,RAB		0 265 006 824 <sup>4</sup>			
	ALR					0 265 006 824 <sup>4</sup>					
3.0 3.0 quattro		12.00-05.03	162	Fg.-Nr. →8E..3..500 000		0 265 006 683 <sup>3</sup>					
		12.00-05.04	162	Fg.-Nr. →8E..4..050 000		ALR,LAB		0 265 006 707 <sup>4</sup>			
						ALR,RAB		0 265 006 681 <sup>4</sup>			
						ALR		0 265 006 681 <sup>4</sup>			
		03.01-05.03	160	Fg.-Nr. →8E..3..500 000			0 265 006 683 <sup>3</sup>				
		03.01-05.04	160	Fg.-Nr. →8E..4..050 000		ALR,LAB		0 265 006 707 <sup>4</sup>			
						ALR,RAB		0 265 006 681 <sup>4</sup>			
						ALR		0 265 006 681 <sup>4</sup>			
		09.01-05.04	162					0 265 006 683 <sup>3</sup>			
						ALR,LAB		0 265 006 707 <sup>4</sup>			
						ALR,RAB		0 265 006 681 <sup>4</sup>			
								0 265 006 681 <sup>4</sup>			
		06.03-12.04	160	Fg.-Nr. 8E..4..000 001→				0 265 006 809 <sup>3</sup>			
								0 265 006 809 <sup>3</sup>			
								0 265 006 809 <sup>3</sup>			
06.04-12.04	160	Fg.-Nr. 8E..5..000 001→		ALR,LAB		0 265 006 826 <sup>4</sup>					
				ALR,RAB		0 265 006 824 <sup>4</sup>					
				ALR		0 265 006 824 <sup>4</sup>					
			162	Fg.-Nr. 8E..5..000 001→		ALR,LAB		0 265 006 826 <sup>4</sup>			
						ALR,RAB		0 265 006 824 <sup>4</sup>			
						ALR		0 265 006 824 <sup>4</sup>			
<b>A4 [8K2; B4]</b>											
	2.0 TFSI	05.13→	165	PR-Code 1LT	S31	0 986 134 267		← 57			
						0 986 135 267		→ 57			
									1 987 470 506 <sup>8</sup>		
									F 026 A03 545 <sup>7</sup>		
	2.0 TFSI	05.13→	165		LAB	0 265 007 928 <sup>4</sup>					
						0 265 007 930 <sup>3</sup>					
							RAB	0 265 007 928 <sup>3</sup>			
								0 265 007 930 <sup>4</sup>			
<b>A4 [8K2; B8]</b>											
	1.8 TFSI 1.8 TFSI quattro	11.07-06.11	88/118	PR-Code 1LA		0 986 134 266		←			
						0 986 135 266		→			
		11.07→	88/118	PR-Code 1LT	S31	0 986 134 267		← 57			
						0 986 135 267		→ 57			
				PR-Code 1LY	S31				F 026 A03 545 <sup>7</sup>		
		11.11→	125	PR-Code 1LT	S31	0 986 134 267		← 57			
						0 986 135 267		→ 57			
				PR-Code 1LT, PR-Code 1LY	S31				1 987 470 506 <sup>8</sup>		
		PR-Code 1LY	S31				F 026 A03 545 <sup>7</sup>				
2.0 TDI	11.07-06.11	88/100	PR-Code 1LA		0 986 134 266		←				
					0 986 135 266		→				



		S							
◀ AUDI A4 [8K2; B8]									
2.0 TDI	11.07→	88/100	PR-Code 1LT	S31	0986 134 267		←	57	
					0986 135 267		→	57	
			PR-Code 1LY	S31					F 026 A03 545 <sup>7</sup>
	01.08-06.11	120	PR-Code 1LA		0986 134 266		←		
					0986 135 266		→		
	01.08→	120	PR-Code 1LT	S31	0986 134 267		←	57	
					0986 135 267		→	57	
			PR-Code 1LY	S31					F 026 A03 545 <sup>7</sup>
	11.11→	105	PR-Code 1LT, PR-Code 1LY	S31					1987 470 506 <sup>8</sup>
		120	PR-Code 1LT, PR-Code 1LY	S31					1987 470 506 <sup>8</sup>
	01.12→	88/100	PR-Code 1LT, PR-Code 1LY	S31					1987 470 506 <sup>8</sup>
2.0 TDI quattro	05.09-03.12	105	PR-Code 1LT, PR-Code 1LY	ATE					1987 470 506 <sup>8</sup>
	11.11→	105	PR-Code 1LT, PR-Code 1LY	S31					1987 470 506 <sup>8</sup>
2.0 TDI	11.07-06.11	105	PR-Code 1LA		0986 134 266		←		
					0986 135 266		→		
2.0 TDI quattro	11.07→	105	PR-Code 1LT	S31	0986 134 267		←	57	
					0986 135 267		→	57	
			PR-Code 1LY	S31					F 026 A03 545 <sup>7</sup>
	01.08-06.11	125	PR-Code 1LA		0986 134 266		←		
					0986 135 266		→		
	01.08-03.12	125	PR-Code 1LT	S31	0986 134 267		←	57	
					0986 135 267		→	57	
			PR-Code 1LY	S31					F 026 A03 545 <sup>7</sup>
	11.11→	130	PR-Code 1LT	S31	0986 134 267		←	57	
					0986 135 267		→	57	
			PR-Code 1LT, PR-Code 1LY	S31					1987 470 506 <sup>8</sup>
			PR-Code 1LY	S31					F 026 A03 545 <sup>7</sup>
	05.13→	110	PR-Code 1LT	S31	0986 134 267		←	57	
					0986 135 267		→	57	
			PR-Code 1LT, PR-Code 1LY	S31					1987 470 506 <sup>8</sup>
			PR-Code 1LY	S31					F 026 A03 545 <sup>7</sup>
	09.13→	140	PR-Code 1LT	S31	0986 134 267		←	57	
					0986 135 267		→	57	
			PR-Code 1LT, PR-Code 1LY	S31					1987 470 506 <sup>8</sup>
			PR-Code 1LY	S31					F 026 A03 545 <sup>7</sup>
2.0 TFSI	06.08-06.11	132	PR-Code 1LA		0986 134 266		←		
2.0 TFSI flexible fuel					0986 135 266		→		
2.0 TFSI quattro flexible fuel	06.08→	132	PR-Code 1LT	S31	0986 134 267		←	57	
					0986 135 267		→	57	
			PR-Code 1LY	S31					F 026 A03 545 <sup>7</sup>
2.0 TFSI	06.08-06.11	155	PR-Code 1LA		0986 134 266		←		
2.0 TFSI quattro	05.13→	162/165	PR-Code 1LT	S31	0986 134 267		←	57	
					0986 135 267		→	57	
			PR-Code 1LT, PR-Code 1LY	S31					1987 470 506 <sup>8</sup>
			PR-Code 1LY	S31					F 026 A03 545 <sup>7</sup>
2.0 TFSI	06.08→	155	PR-Code 1LT	S31	0986 134 267		←	57	
2.0 TFSI quattro					0986 135 267		→	57	
2.0 TFSI quattro flexible fuel			PR-Code 1LY	S31					F 026 A03 545 <sup>7</sup>
2.7 TDI	11.07-06.11	120/140	PR-Code 1LA		0986 134 266		←		
					0986 135 266		→		
	11.07-03.12	120/140	PR-Code 1LT	S31	0986 134 267		←	57	
					0986 135 267		→	57	
			PR-Code 1LY	S31					F 026 A03 545 <sup>7</sup>
3.0 TDI	11.11→	150	PR-Code 1LT	S31	0986 134 267		←	57	
					0986 135 267		→	57	
			PR-Code 1LT, PR-Code 1LY	S31					1987 470 506 <sup>8</sup>
			PR-Code 1LY	S31					F 026 A03 545 <sup>7</sup>
3.0 TDI quattro	11.07-06.11	155/176	PR-Code 1LA		0986 134 266		←		
					0986 135 266		→		
	11.07-03.12	155/176	PR-Code 1LT	S31	0986 134 267		←	57	
					0986 135 267		→	57	
			PR-Code 1LY	S31					F 026 A03 545 <sup>7</sup>











								
3.0 TDI quattro 3.0 TFSI quattro	05.13→	180/200	PR-Code 1LT	S31		0 986 134 267	 57	
						0 986 135 267	 57	
			PR-Code 1LT, PR-Code 1LY	S31				1 987 470 506 <sup>8</sup>
			PR-Code 1LY	S31				F 026 A03 545 <sup>7</sup>
3.2 FSI 3.2 FSI quattro	01.08-06.11	195	PR-Code 1LA			0 986 134 266	 57	
						0 986 135 266	 57	
	01.08-03.12	195	PR-Code 1LT	S31		0 986 134 267	 57	
					0 986 135 267	 57		
			PR-Code 1LY	S31				F 026 A03 545 <sup>7</sup>
<hr/>								
								
 1.8 TFSI	11.07→	88/118/ 125		LAB		0 265 007 928 <sup>4</sup>		
				RAB		0 265 007 930 <sup>3</sup>		
						0 265 007 928 <sup>3</sup>		
						0 265 007 930 <sup>4</sup>		
1.8 TFSI quattro	09.08→	88/118/ 125		LAB		0 265 007 928 <sup>4</sup>		
				RAB		0 265 007 930 <sup>3</sup>		
						0 265 007 928 <sup>3</sup>		
						0 265 007 930 <sup>4</sup>		
2.0 TDI	11.07→	88/100/105/110/ 120/125/130/ 132/140/155/ 162/165		LAB		0 265 007 928 <sup>4</sup>		
				RAB		0 265 007 930 <sup>3</sup>		
						0 265 007 928 <sup>3</sup>		
						0 265 007 930 <sup>4</sup>		
2.0 TDI quattro	06.08→	88/100/105/110/ 120/125/130/ 132/140/155/ 162/165		LAB		0 265 007 928 <sup>4</sup>		
				RAB		0 265 007 930 <sup>3</sup>		
						0 265 007 928 <sup>3</sup>		
						0 265 007 930 <sup>4</sup>		
2.0 TFSI	06.08→	88/100/105/110/ 120/125/130/ 132/140/155/ 162/165		LAB		0 265 007 928 <sup>4</sup>		
				RAB		0 265 007 930 <sup>3</sup>		
						0 265 007 928 <sup>3</sup>		
						0 265 007 930 <sup>4</sup>		
2.0 TFSI flexible fuel	11.09→	88/100/105/110/ 120/125/130/ 132/140/155/ 162/165		LAB		0 265 007 928 <sup>4</sup>		
				RAB		0 265 007 930 <sup>3</sup>		
						0 265 007 928 <sup>3</sup>		
						0 265 007 930 <sup>4</sup>		
2.0 TFSI quattro	06.08→	88/100/105/110/ 120/125/130/ 132/140/155/ 162/165		LAB		0 265 007 928 <sup>4</sup>		
				RAB		0 265 007 930 <sup>3</sup>		
						0 265 007 928 <sup>3</sup>		
						0 265 007 930 <sup>4</sup>		
2.0 TFSI quattro flexible fuel	11.09→	88/100/105/110/ 120/125/130/ 132/140/155/ 162/165		LAB		0 265 007 928 <sup>4</sup>		
				RAB		0 265 007 930 <sup>3</sup>		
						0 265 007 928 <sup>3</sup>		
						0 265 007 930 <sup>4</sup>		
2.7 TDI	11.07-03.12	120/140		LAB		0 265 007 928 <sup>4</sup>		
				RAB		0 265 007 930 <sup>3</sup>		
						0 265 007 928 <sup>3</sup>		
						0 265 007 930 <sup>4</sup>		
3.0 TDI	11.11→	150/155/ 176/180/ 200		LAB		0 265 007 928 <sup>4</sup>		
				RAB		0 265 007 930 <sup>3</sup>		
						0 265 007 928 <sup>3</sup>		
						0 265 007 930 <sup>4</sup>		
3.0 TDI quattro	11.07→	150/155/ 176/180/ 200		LAB		0 265 007 928 <sup>4</sup>		
				RAB		0 265 007 930 <sup>3</sup>		
						0 265 007 928 <sup>3</sup>		
						0 265 007 930 <sup>4</sup>		
3.0 TFSI quattro	02.12→	150/155/ 176/180/ 200		LAB		0 265 007 928 <sup>4</sup>		
				RAB		0 265 007 930 <sup>3</sup>		
						0 265 007 928 <sup>3</sup>		
						0 265 007 930 <sup>4</sup>		



		S									
<b>AUDI A4 [8K2; B8]</b>											
	3.2 FSI	09.08-03.12	195			LAB	0 265 007 928 <sup>4</sup>				
							0 265 007 930 <sup>3</sup>				
						RAB	0 265 007 928 <sup>3</sup>				
							0 265 007 930 <sup>4</sup>				
3.2 FSI quattro	01.08-03.12	195				LAB	0 265 007 928 <sup>4</sup>				
							0 265 007 930 <sup>3</sup>				
						RAB	0 265 007 928 <sup>3</sup>				
							0 265 007 930 <sup>4</sup>				
<b>A5 Cabriolet [8F7]</b>											
	1.8 TFSI	09.09-07.11	118			PR-Code 1LA, PR-Code 1LB	0 986 134 266		←		
							0 986 135 266		→		
		09.09-03.12	118			PR-Code 1LT	S31	0 986 134 267		← 57	1 987 470 506 <sup>8</sup>
								0 986 135 267		→ 57	1 987 470 506 <sup>8</sup>
		09.11→	125/130			PR-Code 1LT	S31	0 986 134 267		← 57	1 987 470 506 <sup>8</sup>
								0 986 135 267		→ 57	1 987 470 506 <sup>8</sup>
2.0 TDI	05.09-07.11	120/125				PR-Code 1LA, PR-Code 1LB	0 986 134 266		←		
							0 986 135 266		→		
	05.09→	120/125				PR-Code 1LT	S31	0 986 134 267		← 57	1 987 470 506 <sup>8</sup>
								0 986 135 267		→ 57	1 987 470 506 <sup>8</sup>
		10.11→	105/110			PR-Code 1LT	S31	0 986 134 267		← 57	1 987 470 506 <sup>8</sup>
								0 986 135 267		→ 57	1 987 470 506 <sup>8</sup>
2.0 TDI	10.11→	130				PR-Code 1LT	S31	0 986 134 267		← 57	1 987 470 506 <sup>8</sup>
2.0 TDI quattro	09.13→	140				PR-Code 1LT	S31	0 986 134 267		← 57	1 987 470 506 <sup>8</sup>
								0 986 135 267		→ 57	1 987 470 506 <sup>8</sup>
2.0 TFSI	03.09-07.11	132				PR-Code 1LA, PR-Code 1LB	0 986 134 266		←		
							0 986 135 266		→		
	03.09-03.12	132				PR-Code 1LT	S31	0 986 134 267		← 57	1 987 470 506 <sup>8</sup>
								0 986 135 267		→ 57	1 987 470 506 <sup>8</sup>
	09.13→	162				PR-Code 1LT	S31	0 986 134 267		← 57	1 987 470 506 <sup>8</sup>
								0 986 135 267		→ 57	1 987 470 506 <sup>8</sup>
2.0 TFSI quattro flexible fuel	03.12-05.13	155-157				PR-Code 1LT	S31	0 986 134 267		← 57	1 987 470 506 <sup>8</sup>
								0 986 135 267		→ 57	1 987 470 506 <sup>8</sup>
2.0 TFSI	03.09-07.11	155				PR-Code 1LA, PR-Code 1LB		0 986 134 266		←	
2.0 TFSI quattro	03.09-05.13	155				PR-Code 1LT	S31	0 986 134 267		← 57	1 987 470 506 <sup>8</sup>
								0 986 135 267		→ 57	1 987 470 506 <sup>8</sup>
2.7 TDI	03.09-07.11	120/140				PR-Code 1LA, PR-Code 1LB	0 986 134 266		←		
							0 986 135 266		→		
	03.09-03.12	120/140				PR-Code 1LT	S31	0 986 134 267		← 57	1 987 470 506 <sup>8</sup>
								0 986 135 267		→ 57	1 987 470 506 <sup>8</sup>
3.0 TDI quattro	03.09-07.11	176				PR-Code 1LA, PR-Code 1LB	0 986 134 266		←		
							0 986 135 266		→		
	03.09-03.12	176				PR-Code 1LT	S31	0 986 134 267		← 57	1 987 470 506 <sup>8</sup>
								0 986 135 267		→ 57	1 987 470 506 <sup>8</sup>
3.0 TDI	09.11→	150/160				PR-Code 1LT	S31	0 986 134 267		← 57	1 987 470 506 <sup>8</sup>
3.0 TDI quattro								0 986 135 267		→ 57	1 987 470 506 <sup>8</sup>
3.2 FSI	03.09-07.11	195				PR-Code 1LA, PR-Code 1LB	0 986 134 266		←		
							0 986 135 266		→		
3.2 FSI quattro	03.09-03.12	195				PR-Code 1LT	S31	0 986 134 267		← 57	1 987 470 506 <sup>8</sup>
								0 986 135 267		→ 57	1 987 470 506 <sup>8</sup>
	1.8 TFSI	09.09→	118/125			LAB	0 265 007 928 <sup>4</sup>				
							0 265 007 930 <sup>3</sup>				
						RAB	0 265 007 928 <sup>3</sup>				
							0 265 007 930 <sup>4</sup>				



































		S												
<b>2.0 TDI</b>	05.09→	120/125/ 130/132/	140/155-157/ 162/165			LAB	0 265 007 928 <sup>4</sup>							
						RAB	0 265 007 930 <sup>3</sup>							
		10.11-05.13	105				LAB	0 265 007 928 <sup>4</sup>						
							RAB	0 265 007 930 <sup>3</sup>						
	05.13-05.15	110				LAB	0 265 007 928 <sup>4</sup>							
						RAB	0 265 007 930 <sup>4</sup>							
	05.13→	110				LAB	0 265 007 930 <sup>3</sup>							
						RAB	0 265 007 928 <sup>3</sup>							
	05.14→	110				LAB	0 265 007 930 <sup>4</sup>							
						RAB	0 265 007 928 <sup>4</sup>							
<b>2.0 TDI quattro</b>	01.12→	120/125/ 130/132/	140/155-157/ 162/165			LAB	0 265 007 928 <sup>4</sup>							
						RAB	0 265 007 930 <sup>3</sup>							
							LAB	0 265 007 928 <sup>4</sup>						
							RAB	0 265 007 930 <sup>3</sup>						
<b>2.0 TFSI</b>	03.09→	120/125/ 130/132/	140/155-157/ 162/165			LAB	0 265 007 928 <sup>4</sup>							
						RAB	0 265 007 930 <sup>3</sup>							
							LAB	0 265 007 928 <sup>4</sup>						
							RAB	0 265 007 930 <sup>3</sup>						
<b>2.0 TFSI quattro</b>	03.09→	120/125/ 130/132/	140/155-157/ 162/165			LAB	0 265 007 928 <sup>4</sup>							
						RAB	0 265 007 930 <sup>3</sup>							
							LAB	0 265 007 928 <sup>3</sup>						
							RAB	0 265 007 930 <sup>4</sup>						
<b>2.0 TFSI quattro flexible fuel</b>	03.12-05.13	120/125/ 130/132/	140/155-157/ 162/165			LAB	0 265 007 928 <sup>4</sup>							
						RAB	0 265 007 930 <sup>3</sup>							
							LAB	0 265 007 928 <sup>3</sup>						
							RAB	0 265 007 930 <sup>4</sup>						
<b>2.7 TDI</b>	03.09-03.12	120/140				LAB	0 265 007 928 <sup>4</sup>							
						RAB	0 265 007 930 <sup>3</sup>							
											LAB	0 265 007 928 <sup>4</sup>		
											RAB	0 265 007 930 <sup>3</sup>		
<b>3.0 FSI quattro</b>	11.11-06.14	200				LAB	0 265 007 928 <sup>4</sup>							
						RAB	0 265 007 930 <sup>3</sup>							
											LAB	0 265 007 928 <sup>4</sup>		
											RAB	0 265 007 930 <sup>3</sup>		
<b>3.0 TDI</b>	09.11→	150/176/ 180				LAB	0 265 007 928 <sup>4</sup>							
						RAB	0 265 007 930 <sup>3</sup>							
							LAB	0 265 007 928 <sup>3</sup>						
							RAB	0 265 007 930 <sup>4</sup>						
<b>3.0 TDI quattro</b>	03.09→	150/176/ 180				LAB	0 265 007 928 <sup>4</sup>							
						RAB	0 265 007 930 <sup>3</sup>							
							LAB	0 265 007 928 <sup>3</sup>						
							RAB	0 265 007 930 <sup>4</sup>						
<b>3.0 TFSI quattro</b>	05.14→	200				LAB	0 265 007 930 <sup>3</sup>							
						RAB	0 265 007 930 <sup>4</sup>							
											LAB	0 265 007 928 <sup>4</sup>		
											RAB	0 265 007 928 <sup>3</sup>		
<b>3.2 FSI</b>	03.09-03.12	195				LAB	0 265 007 928 <sup>4</sup>							
						RAB	0 265 007 930 <sup>3</sup>							
											LAB	0 265 007 928 <sup>3</sup>		
											RAB	0 265 007 930 <sup>4</sup>		
<b>3.2 FSI quattro</b>	03.09-03.12	195				LAB	0 265 007 928 <sup>4</sup>							
						RAB	0 265 007 930 <sup>3</sup>							
											LAB	0 265 007 928 <sup>3</sup>		
											RAB	0 265 007 930 <sup>4</sup>		



<b>A5 Coupé [8T3]</b>										
	1.8 TFSI	10.07-11.08	125	PR-Code 1LA, PR-Code 1LB		0986 <b>134 266</b>				
				PR-Code 1LT		S31	0986 <b>135 266</b>			
										1987 <b>470 506</b> <sup>8</sup>
							0986 <b>134 267</b>		57	
							0986 <b>135 267</b>		57	
	05.09-06.11		118		PR-Code 1LA		0986 <b>134 266</b>			
							0986 <b>135 266</b>			
	05.09-09.11		118		PR-Code 1LT		S31			1987 <b>470 506</b> <sup>8</sup>
							0986 <b>134 267</b>		57	
							0986 <b>135 267</b>		57	
	08.11→		125		PR-Code 1LT		S31	0986 <b>134 267</b>		57
					PR-Code 1LT, PR-Code 1LY		S31	0986 <b>135 267</b>		57
	04.12→		125		PR-Code 1LY		S31			F 026 <b>A03 545</b> <sup>7</sup>
	2.0 TDI	01.08-06.11		120		PR-Code 1LA		0986 <b>134 266</b>		
								0986 <b>135 266</b>		
		01.08-03.12		120		PR-Code 1LT		S31		1987 <b>470 506</b> <sup>8</sup>
01.08→		120		PR-Code 1LT		S31	0986 <b>134 267</b>		57	
						0986 <b>135 267</b>		57		
08.11→		120		PR-Code 1LT, PR-Code 1LY		S31			1987 <b>470 506</b> <sup>8</sup>	
04.12→		120		PR-Code 1LY		S31			F 026 <b>A03 545</b> <sup>7</sup>	
2.0 TDI 2.0 TDI quattro	01.08-06.11		125		PR-Code 1LA		0986 <b>134 266</b>			
							0986 <b>135 266</b>			
	01.08-03.12		125		PR-Code 1LT		S31		1987 <b>470 506</b> <sup>8</sup>	
							0986 <b>134 267</b>		57	
							0986 <b>135 267</b>		57	
	08.11→		130		PR-Code 1LT		S31	0986 <b>134 267</b>		57
					PR-Code 1LT, PR-Code 1LY		S31	0986 <b>135 267</b>		57
	04.12→		130		PR-Code 1LY		S31			F 026 <b>A03 545</b> <sup>7</sup>
	09.13→		140		PR-Code 1LT		S31	0986 <b>134 267</b>		57
					PR-Code 1LT, PR-Code 1LY		S31			1987 <b>470 506</b> <sup>8</sup>
					PR-Code 1LY		S31			F 026 <b>A03 545</b> <sup>7</sup>
	2.0 TFSI	09.08-06.11		132		PR-Code 1LA		0986 <b>134 266</b>		
						0986 <b>135 266</b>				
09.08→		132		PR-Code 1LT		S31	0986 <b>134 267</b>		57	
				PR-Code 1LT, PR-Code 1LY		S31	0986 <b>135 267</b>		57	
04.12→		132		PR-Code 1LY		S31			F 026 <b>A03 545</b> <sup>7</sup>	
2.0 TFSI 2.0 TFSI quattro		06.08-06.11		155		PR-Code 1LA		0986 <b>134 266</b>		
							0986 <b>135 266</b>			
	05.13→		162/165		PR-Code 1LT		S31	0986 <b>134 267</b>		57
					PR-Code 1LT, PR-Code 1LY		S31	0986 <b>135 267</b>		57
2.0 TFSI 2.0 TFSI quattro 2.0 TFSI quattro flexible fuel	06.08-05.13		155		PR-Code 1LT		S31	0986 <b>134 267</b>		57
					PR-Code 1LT, PR-Code 1LY		S31	0986 <b>135 267</b>		57
	04.12-05.13		155		PR-Code 1LY		S31			F 026 <b>A03 545</b> <sup>7</sup>
	2.7 TDI	07.07-05.08		120/140		PR-Code 1LA, PR-Code 1LB		0986 <b>134 266</b>		
								0986 <b>135 266</b>		
		07.07-03.12		120/140		PR-Code 1LT		S31		1987 <b>470 506</b> <sup>8</sup>
						0986 <b>134 267</b>		57		
						0986 <b>135 267</b>		57		
05.08-06.11		120/140		PR-Code 1LA			0986 <b>134 266</b>			
							0986 <b>135 266</b>			



									
<b>3.0 TDI</b>	10.11→	150	PR-Code 1LT	S31	0 986 134 267	 ← 57			
					0 986 135 267	 → 57			
	04.12→	150	PR-Code 1LT, PR-Code 1LY	S31				1 987 470 506 <sup>B</sup>	
<b>3.0 TDI quattro</b>	06.07-07.07	176	Fg.-Nr. →8T..8..009 000,	S31	0 986 134 266	 ←		F 026 A03 545 <sup>7</sup>	
			PR-Code 1LA		0 986 135 266	 →			
	06.07-03.12	176	PR-Code 1LT	S31				1 987 470 506 <sup>B</sup>	
					0 986 134 267	 ← 57			
					0 986 135 267	 → 57			
	08.07-05.08	176	Fg.-Nr. 8T..8..009 001→,		0 986 134 266	 ←			
			PR-Code 1LA		0 986 135 266	 →			
	03.08-05.10	155	PR-Code 1LA, PR-Code 1LB		0 986 134 266	 ←			
					0 986 135 266	 →			
			PR-Code 1LT	S31				1 987 470 506 <sup>B</sup>	
					0 986 134 267	 ← 57			
					0 986 135 267	 → 57			
<b>3.0 TDI quattro</b>	08.11→	180/200	PR-Code 1LT	S31	0 986 134 267	 ← 57			
					0 986 135 267	 → 57			
<b>3.0 TFSI quattro</b>	04.12→	180/200	PR-Code 1LT, PR-Code 1LY	S31				1 987 470 506 <sup>B</sup>	
			PR-Code 1LY	S31				F 026 A03 545 <sup>7</sup>	
<b>3.2 FSI</b>	06.07-07.07	195	Fg.-Nr. →8T..8..009 000,		0 986 134 266	 ←			
			PR-Code 1LA		0 986 135 266	 →			
	08.07-03.12	195	Fg.-Nr. 8T..8..009 001→,		0 986 134 266	 ←			
			PR-Code 1LA		0 986 135 266	 →			
<b>3.2 FSI quattro</b>	11.07-03.12	195	PR-Code 1LA, PR-Code 1LB		0 986 134 266	 ←			
					0 986 135 266	 →			
<b>3.2 FSI</b>	06.07-03.12	195	PR-Code 1LT	S31				1 987 470 506 <sup>B</sup>	
					0 986 134 267	 ← 57			
<b>3.2 FSI quattro</b>					0 986 135 267	 → 57			
									
 <b>1.8 TFSI</b>	10.07-11.08	125		LAB	0 265 007 928 <sup>4</sup>				
				RAB	0 265 007 930 <sup>3</sup>				
					0 265 007 928 <sup>3</sup>				
					0 265 007 930 <sup>4</sup>				
	05.09-09.11	118		LAB	0 265 007 928 <sup>4</sup>				
				RAB	0 265 007 930 <sup>3</sup>				
					0 265 007 928 <sup>3</sup>				
					0 265 007 930 <sup>4</sup>				
	08.11→	125		LAB	0 265 007 928 <sup>4</sup>				
				RAB	0 265 007 930 <sup>3</sup>				
					0 265 007 928 <sup>3</sup>				
					0 265 007 930 <sup>4</sup>				
<b>2.0 TDI</b>	01.08→	120/125/ 130/132/ 140/155/ 162/165		LAB	0 265 007 928 <sup>4</sup>				
				RAB	0 265 007 930 <sup>3</sup>				
					0 265 007 928 <sup>3</sup>				
					0 265 007 930 <sup>4</sup>				
<b>2.0 TDI quattro</b>	08.08→	120/125/ 130/132/ 140/155/ 162/165		LAB	0 265 007 928 <sup>4</sup>				
				RAB	0 265 007 930 <sup>3</sup>				
					0 265 007 928 <sup>3</sup>				
					0 265 007 930 <sup>4</sup>				
<b>2.0 TFSI</b>	06.08→	120/125/ 130/132/ 140/155/ 162/165		LAB	0 265 007 928 <sup>4</sup>				
				RAB	0 265 007 930 <sup>3</sup>				
					0 265 007 928 <sup>3</sup>				
					0 265 007 930 <sup>4</sup>				
<b>2.0 TFSI quattro</b>	06.08→	120/125/ 130/132/ 140/155/ 162/165		LAB	0 265 007 928 <sup>4</sup>				
				RAB	0 265 007 930 <sup>3</sup>				
					0 265 007 928 <sup>3</sup>				
					0 265 007 930 <sup>4</sup>				













<b>◀ AUDI A5 Coupé [8T3]</b>								
<b>2.0 TFSI quattro flexible fuel</b>	05.13→	120/125/	LAB	0 265 007 928 <sup>4</sup>				
		130/132/		0 265 007 930 <sup>3</sup>				
		140/155/	RAB	0 265 007 928 <sup>3</sup>				
		162/165		0 265 007 930 <sup>4</sup>				
<b>2.0 TFSI quattro flexible fuel</b>	03.12-05.13	120/125/	LAB	0 265 007 928 <sup>4</sup>				
		130/132/		0 265 007 930 <sup>3</sup>				
		140/155/	RAB	0 265 007 928 <sup>3</sup>				
		162/165		0 265 007 930 <sup>4</sup>				
<b>2.7 TDI</b>	07.07-03.12	120/140	LAB	0 265 007 928 <sup>4</sup>				
				0 265 007 930 <sup>3</sup>				
			RAB	0 265 007 928 <sup>3</sup>				
				0 265 007 930 <sup>4</sup>				
<b>3.0 TDI</b>	10.11→	150/155/	LAB	0 265 007 928 <sup>4</sup>				
		176/180		0 265 007 930 <sup>3</sup>				
			RAB	0 265 007 928 <sup>3</sup>				
				0 265 007 930 <sup>4</sup>				
<b>3.0 TDI quattro</b>	06.07→	150/155/	LAB	0 265 007 928 <sup>4</sup>				
		176/180		0 265 007 930 <sup>3</sup>				
			RAB	0 265 007 928 <sup>3</sup>				
				0 265 007 930 <sup>4</sup>				
<b>3.0 TFSI quattro</b>	12.11→	200	LAB	0 265 007 928 <sup>4</sup>				
				0 265 007 930 <sup>3</sup>				
			RAB	0 265 007 928 <sup>3</sup>				
				0 265 007 930 <sup>4</sup>				
	05.14→	200	LAB	0 265 007 930 <sup>4</sup>				
				0 265 007 928 <sup>4</sup>				
<b>3.2 FSI</b>	06.07-03.12	195	LAB	0 265 007 928 <sup>4</sup>				
				0 265 007 930 <sup>3</sup>				
			RAB	0 265 007 928 <sup>3</sup>				
				0 265 007 930 <sup>4</sup>				
<b>3.2 FSI quattro</b>	11.07-03.12	195	LAB	0 265 007 928 <sup>4</sup>				
				0 265 007 930 <sup>3</sup>				
			RAB	0 265 007 928 <sup>3</sup>				
				0 265 007 930 <sup>4</sup>				

**A5 Sportback [8TA]**

<b>1.8 TFSI</b>	11.09-06.11	118	PR-Code 1LA	0 986 134 266					
				0 986 135 266					
	11.09-09.11	118	PR-Code 1LT	S31	0 986 134 267			57	
					0 986 135 267				
	08.11→	125	PR-Code 1LT	S31	0 986 134 267			57	
					0 986 135 267				
	04.12→	125	PR-Code 1LT, PR-Code 1LY	S31					
					PR-Code 1LY				S31
	09.14→	106	PR-Code 1LT	S31	0 986 134 267			57	
					0 986 135 267				
			PR-Code 1LT, PR-Code 1LY	S31					
					PR-Code 1LY				S31
<b>2.0 TDI</b>	09.09-06.11	100/105	PR-Code 1LA	0 986 134 266					
				0 986 135 266					
		120	PR-Code 1LA	0 986 134 266					
				0 986 135 266					
09.09-03.12	100/105	PR-Code 1LT	S31					1 987 470 506 <sup>8</sup>	
				PR-Code 1LT					S31
09.09→	100/105	PR-Code 1LT	S31	0 986 134 267			57	1 987 470 506 <sup>8</sup>	
				0 986 135 267					
		120	PR-Code 1LT	0 986 134 267			57	1 987 470 506 <sup>8</sup>	
				0 986 135 267					

									
<b>2.0 TDI</b>	08.11→	120	PR-Code 1LT, PR-Code 1LY	S31				1 987 470 506 <sup>B</sup>	
		130	PR-Code 1LT	S31	0 986 134 267		← 57		
					0 986 135 267		→ 57		
				PR-Code 1LT, PR-Code 1LY	S31				1 987 470 506 <sup>B</sup>
	11.11→	100/105	PR-Code 1LT, PR-Code 1LY	S31				1 987 470 506 <sup>B</sup>	
	04.12→	100/105	PR-Code 1LY	S31				F 026 A03 545 <sup>7</sup>	
		120	PR-Code 1LY	S31				F 026 A03 545 <sup>7</sup>	
		130	PR-Code 1LY	S31				F 026 A03 545 <sup>7</sup>	
	05.13→	110	PR-Code 1LT	S31	0 986 134 267		← 57		
					0 986 135 267		→ 57		
			PR-Code 1LT, PR-Code 1LY	S31					1 987 470 506 <sup>B</sup>
			PR-Code 1LY	S31				F 026 A03 545 <sup>7</sup>	
<b>2.0 TDI</b> <b>2.0 TDI quattro</b>	09.09-06.11	125	PR-Code 1LA		0 986 134 266		←		
					0 986 135 266		→		
	09.09-03.12	125	PR-Code 1LT	S31				1 987 470 506 <sup>B</sup>	
					0 986 134 267		← 57		
					0 986 135 267		→ 57		
	09.13→	140	PR-Code 1LT	S31	0 986 134 267		← 57		
			PR-Code 1LT, PR-Code 1LY	S31				1 987 470 506 <sup>B</sup>	
			PR-Code 1LY	S31				F 026 A03 545 <sup>7</sup>	
<b>2.0 TFSI</b>	09.09-06.11	132	PR-Code 1LA		0 986 134 266		←		
					0 986 135 266		→		
	09.09→	132	PR-Code 1LT	S31	0 986 134 267		← 57		
				PR-Code 1LT, PR-Code 1LY	S31				1 987 470 506 <sup>B</sup>
	04.12→	132	PR-Code 1LY	S31				F 026 A03 545 <sup>7</sup>	
<b>2.0 TFSI</b> <b>2.0 TFSI quattro</b>	09.09-06.11	155	PR-Code 1LA		0 986 134 266		←		
					0 986 135 266		→		
	09.09→	155	PR-Code 1LT	S31	0 986 134 267		← 57		
			PR-Code 1LT, PR-Code 1LY	S31				1 987 470 506 <sup>B</sup>	
	04.12→	155	PR-Code 1LY	S31				F 026 A03 545 <sup>7</sup>	
	05.13→	165	PR-Code 1LT	S31	0 986 134 267		← 57		
			PR-Code 1LT, PR-Code 1LY	S31				1 987 470 506 <sup>B</sup>	
			PR-Code 1LY	S31				F 026 A03 545 <sup>7</sup>	
<b>2.7 TDI</b>	09.09-06.11	120/140	PR-Code 1LA		0 986 134 266		←		
					0 986 135 266		→		
	09.09-03.12	120/140	PR-Code 1LT	S31				1 987 470 506 <sup>B</sup>	
					0 986 134 267		← 57		
					0 986 135 267		→ 57		
<b>3.0 TDI</b>	10.11→	150	PR-Code 1LT	S31	0 986 134 267		← 57		
			PR-Code 1LT, PR-Code 1LY	S31				1 987 470 506 <sup>B</sup>	
	04.12→	150	PR-Code 1LY	S31				F 026 A03 545 <sup>7</sup>	
<b>3.0 TDI quattro</b>	05.09-05.10	155	PR-Code 1LA, PR-Code 1LB		0 986 134 266		←		
			PR-Code 1LT	S31	0 986 135 266		→		
					0 986 134 267		← 57		
					0 986 135 267		→ 57		
	09.09-06.11	176	PR-Code 1LA		0 986 134 266		←		
					0 986 135 266		→		
	09.09-03.12	176	PR-Code 1LT	S31				1 987 470 506 <sup>B</sup>	
					0 986 134 267		← 57		
					0 986 135 267		→ 57		
<b>3.0 TDI quattro</b> <b>3.0 TFSI quattro</b>	08.11→	180/200	PR-Code 1LT	S31	0 986 134 267		← 57		
			PR-Code 1LT, PR-Code 1LY	S31				1 987 470 506 <sup>B</sup>	
	04.12→	180/200	PR-Code 1LY	S31				F 026 A03 545 <sup>7</sup>	



			S								
<b>AUDI A5 Sportback [8TA]</b>											
<b>3.2 FSI quattro</b>	09.09-06.11	195	PR-Code 1LA				0 986 134 266		←		
							0 986 135 266		→		
	09.09-03.12	195	PR-Code 1LT	S31				0 986 134 267		← 57	
								0 986 135 267		→ 57	
											1 987 470 506 <sup>8</sup>
<hr/>											
<b>1.8 TFSI</b>	11.09→	118/125		LAB				0 265 007 928 <sup>4</sup>			
				RAB				0 265 007 930 <sup>3</sup>			
<b>09.14→</b>	106			LAB				0 265 007 928 <sup>3</sup>			
				RAB				0 265 007 930 <sup>4</sup>			
				LAB				0 265 007 930 <sup>3</sup>			
				RAB				0 265 007 928 <sup>3</sup>			
				LAB				0 265 007 928 <sup>4</sup>			
				RAB				0 265 007 928 <sup>3</sup>			
<b>2.0 TDI</b>	09.09→	100		LAB				0 265 007 928 <sup>4</sup>			
				RAB				0 265 007 930 <sup>3</sup>			
				LAB				0 265 007 928 <sup>4</sup>			
				RAB				0 265 007 928 <sup>3</sup>			
				LAB				0 265 007 928 <sup>4</sup>			
				RAB				0 265 007 930 <sup>3</sup>			
	05.13→	110			LAB				0 265 007 928 <sup>4</sup>		
					RAB				0 265 007 930 <sup>3</sup>		
					LAB				0 265 007 928 <sup>4</sup>		
					RAB				0 265 007 928 <sup>3</sup>		
					LAB				0 265 007 928 <sup>4</sup>		
					RAB				0 265 007 930 <sup>4</sup>		
04.14→	100			LAB				0 265 007 930 <sup>4</sup>			
				RAB				0 265 007 928 <sup>4</sup>			
				LAB				0 265 007 930 <sup>4</sup>			
				RAB				0 265 007 928 <sup>4</sup>			
				LAB				0 265 007 930 <sup>4</sup>			
				RAB				0 265 007 928 <sup>4</sup>			
<b>2.0 TDI quattro</b>	09.09-03.12	120/125/ 130/132/ 140/155/ 165		LAB				0 265 007 928 <sup>4</sup>			
				RAB				0 265 007 930 <sup>3</sup>			
				LAB				0 265 007 928 <sup>4</sup>			
				RAB				0 265 007 928 <sup>3</sup>			
				LAB				0 265 007 928 <sup>4</sup>			
				RAB				0 265 007 930 <sup>4</sup>			
<b>09.13→</b>	120/125/ 130/132/ 140/155/ 165			LAB				0 265 007 928 <sup>4</sup>			
				RAB				0 265 007 930 <sup>3</sup>			
				LAB				0 265 007 928 <sup>3</sup>			
				RAB				0 265 007 928 <sup>3</sup>			
				LAB				0 265 007 928 <sup>4</sup>			
				RAB				0 265 007 930 <sup>4</sup>			
<b>2.0 TFSI</b>	09.09→	120/125/ 130/132/ 140/155/ 165		LAB				0 265 007 928 <sup>4</sup>			
				RAB				0 265 007 930 <sup>3</sup>			
				LAB				0 265 007 928 <sup>3</sup>			
				RAB				0 265 007 930 <sup>4</sup>			
<b>2.0 TFSI quattro</b>	09.09→	120/125/ 130/132/ 140/155/ 165		LAB				0 265 007 928 <sup>4</sup>			
				RAB				0 265 007 930 <sup>3</sup>			
				LAB				0 265 007 928 <sup>3</sup>			
				RAB				0 265 007 930 <sup>4</sup>			
<b>2.7 TDI</b>	09.09-03.12	120/140		LAB				0 265 007 928 <sup>4</sup>			
				RAB				0 265 007 930 <sup>3</sup>			
				LAB				0 265 007 928 <sup>3</sup>			
				RAB				0 265 007 930 <sup>4</sup>			
<b>3.0 TDI</b>	10.11→	150/155/ 176/180		LAB				0 265 007 928 <sup>4</sup>			
				RAB				0 265 007 930 <sup>3</sup>			
				LAB				0 265 007 928 <sup>3</sup>			
				RAB				0 265 007 930 <sup>4</sup>			



	S							
3.0 TDI quattro	05.09→	150/155/ 176/180			LAB	0 265 007 928 <sup>4</sup> 0 265 007 930 <sup>3</sup>		
					RAB	0 265 007 928 <sup>3</sup> 0 265 007 930 <sup>4</sup>		
3.0 TFSI quattro	05.14→	200			LAB	0 265 007 928 <sup>4</sup> 0 265 007 930 <sup>3</sup>		
					RAB	0 265 007 928 <sup>3</sup> 0 265 007 930 <sup>4</sup>		
3.2 FSI quattro	09.09-03.12	195			LAB	0 265 007 928 <sup>4</sup> 0 265 007 930 <sup>3</sup>		
					RAB	0 265 007 928 <sup>3</sup> 0 265 007 930 <sup>4</sup>		
<b>A6 Allroad [4BH; C5]</b>								
2.5 TDI	05.00-08.05	120/132			FSB	0 986 134 078  ← 60 0 986 135 078  → 60	1 987 470 506 <sup>B</sup>	
					SSB	0 986 134 074  ← 43 0 986 135 074  → 43		
2.7 T	05.00-08.05	184			FSB	0 986 134 078  ← 60 0 986 135 078  → 60	1 987 470 506 <sup>B</sup>	
					SSB	0 986 134 074  ← 43 0 986 135 074  → 43		
	09.01-08.05	187				0 986 134 078  ← 60 0 986 135 078  → 60	1 987 470 506 <sup>B</sup>	
					321	0 986 134 074  ← 43 0 986 135 074  → 43		
4.2	07.02-08.05	220				0 986 134 078  ← 60 0 986 135 078  → 60	1 987 470 506 <sup>B</sup>	
					FSB	0 986 134 078  ← 60 0 986 135 078  → 60	1 987 470 506 <sup>B</sup>	
					SSB	0 986 134 074  ← 43 0 986 135 074  → 43		
					321	0 986 134 074  ← 43 0 986 135 074  → 43		
2.5 TDI	05.00-08.05	120/132				0 986 473 225  ← 38,1 0 986 473 225  ← 38,1	1 987 470 040 <sup>7</sup> 1 987 474 496 <sup>B</sup>	
						0 986 474 225  → 38,1	1 987 470 040 <sup>7</sup>	
2.7 T	05.00-08.05	184/187				0 986 473 225  ← 38,1 0 986 473 225  ← 38,1	1 987 470 040 <sup>7</sup> 1 987 474 496 <sup>B</sup>	
						0 986 474 225  → 38,1	1 987 470 040 <sup>7</sup>	
4.2	07.02-08.05	220				0 986 473 185  ← 43 0 986 473 185  ← 43	F 026 A06 121 <sup>7</sup> 1 987 474 496 <sup>B</sup>	
						0 986 474 185  → 43	F 026 A06 121 <sup>7</sup>	
2.5 TDI	05.00-08.05	120/132				1 987 477 959	↔ 1925	
2.7 T	05.00-08.05	184/187				1 987 477 959	↔ 1925	
4.2	07.02-08.05	220				1 987 477 959	↔ 1925	
2.5 TDI	05.00-11.01	132	Fg.-Nr. →4B..2..079 500		LAB	0 265 006 655 <sup>4</sup>		
					RAB	0 265 006 657 <sup>4</sup>		
	12.01-05.03	132	Fg.-Nr. 4B..2..079 501→		LAB	0 265 006 781 <sup>4</sup>		
					RAB	0 265 006 783 <sup>4</sup>		
	06.03-08.05	120			LAB	0 265 006 781 <sup>4</sup>		
					RAB	0 265 006 783 <sup>4</sup>		



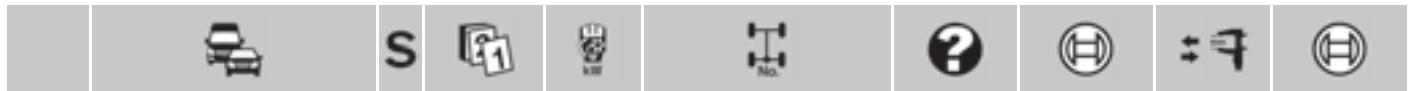

	◀ AUDI A6 Allroad [4BH; C5]									
	2.5 TDI	06.03-08.05	132			LAB	0 265 006 781 <sup>4</sup>			
						RAB	0 265 006 783 <sup>4</sup>			
	2.7 T	05.00-11.01	184	Fg.-Nr. →4B..2..079 500		LAB	0 265 006 655 <sup>4</sup>			
						RAB	0 265 006 657 <sup>4</sup>			
		09.01-08.05	187			LAB	0 265 006 781 <sup>4</sup>			
						RAB	0 265 006 783 <sup>4</sup>			
		12.01-06.02	184	Fg.-Nr. 4B..2..079 501→		LAB	0 265 006 781 <sup>4</sup>			
						RAB	0 265 006 783 <sup>4</sup>			
		07.02-08.05	184			LAB	0 265 006 781 <sup>4</sup>			
						RAB	0 265 006 783 <sup>4</sup>			
	4.2	07.02-08.05	220			LAB	0 265 006 781 <sup>4</sup>			
						RAB	0 265 006 783 <sup>4</sup>			

**A6 Allroad [4FH; C6]**

	2.7 TDI	05.06-08.11	120/132/ 140	PR-Code 1LG	321		0 986 473 229	← 60	
							0 986 474 229	→ 60	
				PR-Code 1ZL	347				1 987 470 506 <sup>8</sup>
	3.0 TDI	05.06-08.11	155/171/	PR-Code 1LG	321		0 986 473 229	← 60	
	3.0 TFSI		176/213				0 986 474 229	→ 60	
				PR-Code 1ZL	347				1 987 470 506 <sup>8</sup>
	3.2 FSI	05.06-10.08	188	PR-Code 1LG	321		0 986 473 229	← 60	
							0 986 474 229	→ 60	
				PR-Code 1ZL	347				1 987 470 506 <sup>8</sup>
	4.2 FSI	05.06-08.11	257	PR-Code 1LG	321		0 986 473 229	← 60	
							0 986 474 229	→ 60	
				PR-Code 1ZL	347				1 987 470 506 <sup>8</sup>



















































**A**

	3.0 TDI	10.08-08.11	155/176/						1 987 474 496 <sup>8</sup>
	3.0 TFSI		213						

	2.7 TDI	05.06-08.11	120/132/ 140			LAB	0 265 007 930 <sup>3</sup>		
						RAB	0 265 007 930 <sup>4</sup>		
							0 265 007 928 <sup>3</sup>		
							0 265 007 928 <sup>4</sup>		
	3.0 TDI	05.06-08.11	155/171/ 176/213			LAB	0 265 007 930 <sup>3</sup>		
						RAB	0 265 007 930 <sup>4</sup>		
							0 265 007 928 <sup>3</sup>		
							0 265 007 928 <sup>4</sup>		
	3.0 TFSI	10.08-08.11	155/171/ 176/213			LAB	0 265 007 930 <sup>3</sup>		
						RAB	0 265 007 930 <sup>4</sup>		
							0 265 007 928 <sup>3</sup>		
							0 265 007 928 <sup>4</sup>		
	3.2 FSI	05.06-10.08	188			LAB	0 265 007 930 <sup>3</sup>		
						RAB	0 265 007 930 <sup>4</sup>		
							0 265 007 928 <sup>3</sup>		
							0 265 007 928 <sup>4</sup>		
	4.2 FSI	05.06-08.11	257			LAB	0 265 007 930 <sup>3</sup>		
						RAB	0 265 007 930 <sup>4</sup>		
							0 265 007 928 <sup>3</sup>		
							0 265 007 928 <sup>4</sup>		

**A6 Allroad [4GH, C7]**

	3.0 TDI	09.14→	155/160/200/ 235/245			LAB	0 265 007 928 <sup>4</sup>		
							0 265 007 930 <sup>3</sup>		

		S							
3.0 TDI		09.14→	155/160/200/ 235/245			RAB	0 265 007 928 <sup>3</sup> 0 265 007 930 <sup>4</sup>		
3.0 TFSI		09.14→	155/160/200/ 235/245			LAB	0 265 007 928 <sup>4</sup> 0 265 007 930 <sup>3</sup>		
						RAB	0 265 007 928 <sup>3</sup> 0 265 007 930 <sup>4</sup>		
<b>A6 Allroad [4GH; C7]</b>									
									
	3.0 TDI	01.12→	150/180/ 228/230			LAB	0 265 007 928 <sup>4</sup> 0 265 007 930 <sup>3</sup>		
						RAB	0 265 007 928 <sup>3</sup> 0 265 007 930 <sup>4</sup>		
	3.0 TFSI	01.12→	150/180/ 228/230			LAB	0 265 007 928 <sup>4</sup> 0 265 007 930 <sup>3</sup>		
						RAB	0 265 007 928 <sup>3</sup> 0 265 007 930 <sup>4</sup>		
<b>A6 Avant [4A5; C4]</b>									
									
	1.8 1.8 quattro	10.95-10.97	92				0 986 473 929  ← 57 0 986 473 929  ← 57 0 986 473 930  → 57 0 986 473 929  ← 57 0 986 473 930  → 57	1987 470 005 <sup>7</sup> 1987 470 506 <sup>B</sup> 1987 470 005 <sup>7</sup> 1987 470 506 <sup>B</sup> 1987 470 005 <sup>7</sup>	
	1.9 TDI	07.94-10.97	66				0 986 473 929  ← 57 0 986 473 930  → 57	1987 470 005 <sup>7</sup> 1987 470 506 <sup>B</sup>	
	2.0 2.0 quattro	06.94-10.97	79/85/103				0 986 473 929  ← 57 0 986 473 929  ← 57 0 986 473 930  → 57	1987 470 005 <sup>7</sup> 1987 470 506 <sup>B</sup> 1987 470 005 <sup>7</sup>	
	2.3 2.3 quattro	06.94-06.96	98				0 986 473 929  ← 57 0 986 473 929  ← 57 0 986 473 930  → 57	1987 470 005 <sup>7</sup> 1987 470 506 <sup>B</sup> 1987 470 005 <sup>7</sup>	
	2.5 TDI	06.94-10.97	85				0 986 473 929  ← 57 0 986 473 929  ← 57 0 986 473 930  → 57	1987 470 005 <sup>7</sup> 1987 470 506 <sup>B</sup> 1987 470 005 <sup>7</sup>	
	2.5 TDI 2.5 TDI quattro	10.94-10.97	103				0 986 474 882  ← 57 0 986 474 882  ← 57 0 986 474 884  → 57	1987 470 005 <sup>7</sup> 1987 470 506 <sup>B</sup> 1987 470 005 <sup>7</sup>	
	2.6 2.6 quattro	06.94-10.97	102/110				0 986 474 882  ← 57 0 986 474 882  ← 57 0 986 474 884  → 57	1987 470 005 <sup>7</sup> 1987 470 506 <sup>B</sup> 1987 470 005 <sup>7</sup>	
	2.8 2.8 quattro	06.94-12.98	120/ 125-128/ 142				0 986 474 882  ← 57 0 986 474 882  ← 57 0 986 474 884  → 57	1987 470 005 <sup>7</sup> 1987 470 506 <sup>B</sup> 1987 470 005 <sup>7</sup>	
									
	1.8 1.8 quattro	10.95-10.97	92				0 986 473 695  ← 38 0 986 474 695  → 38 0 986 474 698  ← 38 0 986 473 698  → 38	1987 470 040 <sup>7</sup> 1987 470 040 <sup>7</sup> 1987 470 040 <sup>7</sup> 1987 470 040 <sup>7</sup>	
	1.9 TDI	07.94-10.97	66				0 986 473 695  ← 38 0 986 474 695  → 38	1987 470 040 <sup>7</sup> 1987 470 040 <sup>7</sup>	
	2.0 2.0 quattro	06.94-10.97	79/85				0 986 473 695  ← 38 0 986 474 695  → 38 0 986 473 695  ← 38 0 986 474 695  → 38	1987 470 040 <sup>7</sup> 1987 470 040 <sup>7</sup> 1987 470 040 <sup>7</sup> 1987 470 040 <sup>7</sup>	
	2.3	06.94-06.96	98				0 986 473 695  ← 38 0 986 474 695  → 38	1987 470 040 <sup>7</sup> 1987 470 040 <sup>7</sup>	





AUDI A6 Avant [4A5; C4]					
2.3 quattro	08.94-06.95	98	0986 474 698	↻ ← 38	1987 470 040 <sup>7</sup>
			0986 473 698	↻ → 38	1987 470 040 <sup>7</sup>
2.4	07.96-10.97	110	0986 473 695	↻ ← 38	1987 470 040 <sup>7</sup>
			0986 474 695	↻ → 38	1987 470 040 <sup>7</sup>
2.5 TDI	06.94-10.97	85	0986 473 695	↻ ← 38	1987 470 040 <sup>7</sup>
			0986 474 695	↻ → 38	1987 470 040 <sup>7</sup>
	10.94-07.96	103	0986 473 695	↻ ← 38	1987 470 040 <sup>7</sup>
			0986 474 695	↻ → 38	1987 470 040 <sup>7</sup>
2.5 TDI quattro	07.96-10.97	103	0986 474 698	↻ ← 38	1987 470 040 <sup>7</sup>
			0986 473 698	↻ → 38	1987 470 040 <sup>7</sup>
2.6	06.94-07.96	102/110	0986 473 695	↻ ← 38	1987 470 040 <sup>7</sup>
			0986 474 695	↻ → 38	1987 470 040 <sup>7</sup>
2.6 quattro	06.94-10.97	102/110	0986 474 698	↻ ← 38	1987 470 040 <sup>7</sup>
			0986 473 698	↻ → 38	1987 470 040 <sup>7</sup>
2.8	06.94-07.96	120	0986 473 695	↻ ← 38	1987 470 040 <sup>7</sup>
			0986 474 695	↻ → 38	1987 470 040 <sup>7</sup>
	09.94-10.97	128/142	0986 473 695	↻ ← 38	1987 470 040 <sup>7</sup>
			0986 474 695	↻ → 38	1987 470 040 <sup>7</sup>
2.8 quattro	06.94-10.97	125-128	0986 474 698	↻ ← 38	1987 470 040 <sup>7</sup>
			0986 473 698	↻ → 38	1987 470 040 <sup>7</sup>
	08.94-12.98	128/142	0986 474 698	↻ ← 38	1987 470 040 <sup>7</sup>
			0986 473 698	↻ → 38	1987 470 040 <sup>7</sup>
07.96-10.97	120	0986 474 698	↻ ← 38	1987 470 040 <sup>7</sup>	
		0986 473 698	↻ → 38	1987 470 040 <sup>7</sup>	

AUDI A6 Avant [4B; C5]					
1.8	10.95-10.97	92	1987 477 687	↔ 1491	
			1987 477 813	← 1692	
1.8 quattro	07.96-10.97	92	1987 477 815	→ 1676	
			1987 477 687	↔ 1491	
1.9 TDI	07.94-10.97	66	1987 477 687	↔ 1491	
2.0	06.94-10.97	79/85	1987 477 687	↔ 1491	
			07.96-10.97	103	1987 477 687
2.0 quattro	06.94-10.97	103	1987 477 813	← 1692	
			1987 477 815	→ 1676	
2.3	06.94-06.96	98	1987 477 687	↔ 1491	
2.3 quattro	08.94-06.95	98	1987 477 813	← 1692	
			1987 477 815	→ 1676	
2.4	07.96-10.97	110	1987 477 687	↔ 1491	
2.5 TDI	06.94-10.97	85	1987 477 687	↔ 1491	
			10.94-07.96	103	1987 477 687
2.5 TDI quattro	07.96-10.97	103	1987 477 813	← 1692	
			1987 477 815	→ 1676	
2.6	06.94-07.96	102/110	1987 477 687	↔ 1491	
2.6 quattro	06.94-10.97	102/110	1987 477 813	← 1692	
			1987 477 815	→ 1676	
2.8	06.94-07.96	120	1987 477 687	↔ 1491	
			09.94-10.97	128/142	1987 477 687
2.8 quattro	06.94-10.97	125-128	1987 477 813	← 1692	
			1987 477 815	→ 1676	
	08.94-12.98	128/142	1987 477 813	← 1692	
			1987 477 815	→ 1676	
07.96-10.97	120	1987 477 813	← 1692		
		1987 477 815	→ 1676		

**A6 Avant [4B; C5]**

AUDI A6 Avant [4B; C5]						
4.2 quattro	04.99-05.01	220	312	0986 473 070	↻ ← 56,93	1987 470 005 <sup>7</sup>
				0986 473 070	↻ ← 56,93	1987 470 506 <sup>8</sup>
				0986 474 070	↻ → 56,93	1987 470 005 <sup>7</sup>
				0986 134 078	↻ ← 60	1987 470 506 <sup>8</sup>
			321,FSB	0986 135 078	↻ → 60	1987 470 506 <sup>8</sup>

















































		S							
4.2 quattro		04.99-05.01	220		321,SSB		0 986 134 074	← 43	1 987 470 506 <sup>8</sup>
							0 986 135 074	→ 43	1 987 470 506 <sup>8</sup>
4.2 quattro		04.99-05.01	220				0 986 473 185	← 43	F 026 A06 121 <sup>7</sup>
							0 986 473 185	← 43	1 987 474 496 <sup>8</sup>
							0 986 474 185	→ 43	F 026 A06 121 <sup>7</sup>
4.2 quattro		04.99-05.01	220				1 987 477 959	↔ 1925	
4.2 quattro		04.99-05.01	220				0 265 006 578 <sup>3</sup>		
					LAB		0 265 006 567 <sup>4</sup>		
					RAB		0 265 006 565 <sup>4</sup>		
<b>A6 Avant [4B5; C5]</b>									
1.8		02.98-01.05	85/92/110/	PR-Code 1LB, PR-Code 1LE	288		0 986 473 070	← 56,93	
1.8 T			132				0 986 474 070	→ 56,93	
1.8 T quattro				PR-Code 1LB, PR-Code 1LE, PR-Code 1LT, PR-Code 1LF	288,312				1 987 470 005 <sup>7</sup>
				PR-Code 1LT, PR-Code 1LF	312		0 986 473 070	← 56,93	1 987 470 506 <sup>8</sup>
							0 986 474 070	→ 56,93	
1.9 TDI		02.98-04.01	81/85	PR-Code 1LB, PR-Code 1LE	288		0 986 473 070	← 56,93	
				PR-Code 1LB, PR-Code 1LE, PR-Code 1LT, PR-Code 1LF	288,312				1 987 470 005 <sup>7</sup>
				PR-Code 1LT, PR-Code 1LF	312		0 986 473 070	← 56,93	1 987 470 506 <sup>8</sup>
							0 986 474 070	→ 56,93	
		06.01-01.05	96	PR-Code 1LB, PR-Code 1LE	288		0 986 473 070	← 56,93	
				PR-Code 1LB, PR-Code 1LE, PR-Code 1LT, PR-Code 1LF	288,312				1 987 470 005 <sup>7</sup>
				PR-Code 1LG, PR-Code 1LA			0 986 134 078	← 60	1 987 470 506 <sup>8</sup>
							0 986 135 078	→ 60	1 987 470 506 <sup>8</sup>
				PR-Code 1LT, PR-Code 1LF	312		0 986 473 070	← 56,93	
							0 986 474 070	→ 56,93	
2.0		06.01-01.05	96	PR-Code 1LB, PR-Code 1LE	288		0 986 473 070	← 56,93	
				PR-Code 1LB, PR-Code 1LE, PR-Code 1LT, PR-Code 1LF	288,312				1 987 470 005 <sup>7</sup>
				PR-Code 1LG, PR-Code 1LA			0 986 134 078	← 60	1 987 470 506 <sup>8</sup>
							0 986 135 078	→ 60	1 987 470 506 <sup>8</sup>
				PR-Code 1LT, PR-Code 1LF	312		0 986 473 070	← 56,93	
							0 986 474 070	→ 56,93	
2.4		02.98-05.00	100	PR-Code 1LB, PR-Code 1LE	288		0 986 473 070	← 56,93	
				PR-Code 1LB, PR-Code 1LE, PR-Code 1LT, PR-Code 1LF	288,312				1 987 470 005 <sup>7</sup>
				PR-Code 1LT, PR-Code 1LF	312		0 986 473 070	← 56,93	1 987 470 506 <sup>8</sup>
							0 986 474 070	→ 56,93	
		06.01-01.05	100	PR-Code 1LB, PR-Code 1LE	288		0 986 473 070	← 56,93	
				PR-Code 1LB, PR-Code 1LE, PR-Code 1LT, PR-Code 1LF	288,312				1 987 470 005 <sup>7</sup>
				PR-Code 1LG, PR-Code 1LA			0 986 134 078	← 60	1 987 470 506 <sup>8</sup>
							0 986 135 078	→ 60	1 987 470 506 <sup>8</sup>
				PR-Code 1LT, PR-Code 1LF	312		0 986 473 070	← 56,93	
							0 986 474 070	→ 56,93	































































<b>◀ AUDI A6 Avant [4B5; C5]</b>									
<b>2.4</b>	06.01-01.05	125	PR-Code 1LB, PR-Code 1LE, PR-Code 1LT, PR-Code 1LF	288,312					1 987 470 506 <sup>8</sup>
<b>2.4</b>	04.97-05.01	115/120/121	PR-Code 1LB, PR-Code 1LE	288	0 986 473 070		←	56,93	
<b>2.4 quattro</b>			PR-Code 1LB, PR-Code 1LE, PR-Code 1LT, PR-Code 1LF	288,312	0 986 474 070		→	56,93	
			PR-Code 1LB, PR-Code 1LE, PR-Code 1LT, PR-Code 1LF	288,312					1 987 470 005 <sup>7</sup>
			PR-Code 1LT, PR-Code 1LF	312	0 986 473 070		←	56,93	
					0 986 474 070		→	56,93	
	06.01-01.05	125	PR-Code 1LB, PR-Code 1LE	288	0 986 473 070		←	56,93	
			PR-Code 1LB, PR-Code 1LE, PR-Code 1LT, PR-Code 1LF	288,312					
			PR-Code 1LT, PR-Code 1LF	312	0 986 473 070		←	56,93	
					0 986 474 070		→	56,93	
<b>2.4 quattro</b>	06.01-01.05	125	PR-Code 1LB, PR-Code 1LE, PR-Code 1LT, PR-Code 1LF	288,312					1 987 470 506 <sup>8</sup>
			PR-Code 1LG, PR-Code 1LA			0 986 134 078		←	60
					0 986 135 078		→	60	1 987 470 506 <sup>8</sup>
<b>2.5 TDI</b>	02.98-04.01	110	PR-Code 1LB, PR-Code 1LE	288	0 986 473 070		←	56,93	
<b>2.5 TDI quattro</b>			PR-Code 1LB, PR-Code 1LE, PR-Code 1LT, PR-Code 1LF	288,312					
			PR-Code 1LT, PR-Code 1LF	312	0 986 473 070		←	56,93	
					0 986 474 070		→	56,93	
	10.99-01.05	114/120/132	PR-Code 1LB, PR-Code 1LE	288	0 986 473 070		←	56,93	
			PR-Code 1LB, PR-Code 1LE, PR-Code 1LT, PR-Code 1LF	288,312					
			PR-Code 1LT, PR-Code 1LF	312	0 986 473 070		←	56,93	
					0 986 474 070		→	56,93	
	06.01-01.05	114/120/132	PR-Code 1LG, PR-Code 1LA		0 986 134 078		←	60	1 987 470 506 <sup>8</sup>
						0 986 135 078		→	60
<b>2.7 Biturbo</b>	02.99-05.01	169			0 986 134 078		←	60	1 987 470 506 <sup>8</sup>
							0 986 135 078		→
<b>2.7 Biturbo quattro</b>	02.99-05.01	169			0 986 134 074		←	43	
							0 986 135 074		→
	06.01-06.02	184		312	0 986 473 070		←	56,93	1 987 470 005 <sup>7</sup>
							0 986 473 070		←
					0 986 474 070		→	56,93	1 987 470 005 <sup>7</sup>
			PR-Code 1LX		0 986 134 074		←	43	
					0 986 135 074		→	43	
	06.01-01.05	184	PR-Code 1LG, PR-Code 1LA		0 986 134 078		←	60	1 987 470 506 <sup>8</sup>
							0 986 135 078		→
	07.02-01.05	184	PR-Code 1LB, PR-Code 1LE	288	0 986 473 070		←	56,93	
					PR-Code 1LB, PR-Code 1LE, PR-Code 1LT, PR-Code 1LF	288,312			
			PR-Code 1LT, PR-Code 1LF	312	0 986 473 070		←	56,93	
					0 986 474 070		→	56,93	
<b>2.8</b>	02.98-05.01	132/140/142	PR-Code 1LB, PR-Code 1LE	288	0 986 473 070		←	56,93	
<b>2.8 quattro</b>			PR-Code 1LB, PR-Code 1LE, PR-Code 1LT, PR-Code 1LF	288,312					
			PR-Code 1LT, PR-Code 1LF	312	0 986 473 070		←	56,93	
					0 986 474 070		→	56,93	
<b>3.0</b>	06.01-01.05	160	PR-Code 1LB, PR-Code 1LE, PR-Code 1LT, PR-Code 1LF	288,312					1 987 470 506 <sup>8</sup>
<b>3.0</b>	06.01-01.05	160	PR-Code 1LB, PR-Code 1LE	288	0 986 473 070		←	56,93	
<b>3.0 quattro</b>			PR-Code 1LB, PR-Code 1LE, PR-Code 1LT, PR-Code 1LF	288,312					
			PR-Code 1LT, PR-Code 1LF	312	0 986 473 070		←	56,93	
					0 986 474 070		→	56,93	













								
<b>3.0</b>	06.01-01.05	162	PR-Code 1LB, PR-Code 1LE	288	0 986 473 070		← 56,93	
<b>3.0 quattro</b>					0 986 474 070		→ 56,93	
			PR-Code 1LB, PR-Code 1LE, PR-Code 1LT, PR-Code 1LF	288,312				1 987 470 005 <sup>7</sup> 1 987 470 506 <sup>B</sup>
			PR-Code 1LG, PR-Code 1LA		0 986 134 078		← 60	1 987 470 506 <sup>B</sup>
					0 986 135 078		→ 60	1 987 470 506 <sup>B</sup>
			PR-Code 1LT, PR-Code 1LF	312	0 986 473 070		← 56,93	
					0 986 474 070		→ 56,93	
<b>3.0 quattro</b>	06.01-01.05	160	PR-Code 1LB, PR-Code 1LE, PR-Code 1LT, PR-Code 1LF	288,312				1 987 470 506 <sup>B</sup>
			PR-Code 1LG, PR-Code 1LA		0 986 134 078		← 60	1 987 470 506 <sup>B</sup>
					0 986 135 078		→ 60	1 987 470 506 <sup>B</sup>
								
 <b>1.8</b>	02.98-04.01	85/92			0 986 472 830		← 38	1 987 470 040 <sup>7</sup>
					0 986 474 830			1 987 474 496 <sup>B</sup>
					0 986 472 831		→ 38	1 987 470 040 <sup>7</sup>
					0 986 474 831			
<b>1.8 T</b>	02.98-10.00	132			0 986 472 830		← 38	1 987 470 040 <sup>7</sup>
					0 986 474 830			1 987 474 496 <sup>B</sup>
					0 986 472 831		→ 38	1 987 470 040 <sup>7</sup>
					0 986 474 831			
	02.98-01.05	110			0 986 472 830		← 38	1 987 470 040 <sup>7</sup>
					0 986 474 830			1 987 474 496 <sup>B</sup>
					0 986 472 831		→ 38	1 987 470 040 <sup>7</sup>
					0 986 474 831			
<b>1.8 T quattro</b>	02.98-10.00	132			0 986 473 225		← 38,1	1 987 470 040 <sup>7</sup>
					0 986 473 225		← 38,1	1 987 474 496 <sup>B</sup>
					0 986 474 225		→ 38,1	1 987 470 040 <sup>7</sup>
					0 986 474 225		→ 38,1	1 987 474 496 <sup>B</sup>
	02.98-05.01	110			0 986 473 225		← 38,1	1 987 470 040 <sup>7</sup>
	02.98-01.05	110			0 986 474 225		→ 38,1	1 987 470 040 <sup>7</sup>
					0 986 474 225		→ 38,1	1 987 474 496 <sup>B</sup>
	01.99-01.05	110			0 986 473 225		← 38,1	1 987 474 496 <sup>B</sup>
	05.00-01.05	110			0 986 473 185		← 43	F 026 A06 121 <sup>7</sup>
					0 986 473 185		← 43	1 987 474 496 <sup>B</sup>
					0 986 474 185		→ 43	F 026 A06 121 <sup>7</sup>
<b>1.9 TDI</b>	02.98-04.01	81/85			0 986 472 830		← 38	1 987 470 040 <sup>7</sup>
					0 986 474 830			1 987 474 496 <sup>B</sup>
					0 986 472 831		→ 38	1 987 470 040 <sup>7</sup>
					0 986 474 831			
	06.01-01.05	96			0 986 473 185		← 43	F 026 A06 121 <sup>7</sup>
					0 986 473 185		← 43	1 987 474 496 <sup>B</sup>
					0 986 474 185		→ 43	F 026 A06 121 <sup>7</sup>
				245	0 986 472 830		← 38	1 987 470 040 <sup>7</sup>
					0 986 474 830			1 987 474 496 <sup>B</sup>
					0 986 472 831		→ 38	1 987 470 040 <sup>7</sup>
					0 986 474 831			
<b>2.0</b>	06.01-01.05	96			0 986 473 185		← 43	F 026 A06 121 <sup>7</sup>
					0 986 473 185		← 43	1 987 474 496 <sup>B</sup>
					0 986 474 185		→ 43	F 026 A06 121 <sup>7</sup>
				245	0 986 472 830		← 38	1 987 470 040 <sup>7</sup>
					0 986 474 830			1 987 474 496 <sup>B</sup>
					0 986 472 831		→ 38	1 987 470 040 <sup>7</sup>
					0 986 474 831			
<b>2.4</b>	04.97-04.01	121			0 986 472 830		← 38	1 987 470 040 <sup>7</sup>
					0 986 474 830			1 987 474 496 <sup>B</sup>
					0 986 472 831		→ 38	1 987 470 040 <sup>7</sup>
					0 986 474 831			
	02.98-05.00	100			0 986 472 830		← 38	1 987 470 040 <sup>7</sup>
					0 986 474 830			1 987 474 496 <sup>B</sup>
					0 986 472 831		→ 38	1 987 470 040 <sup>7</sup>
					0 986 474 831			



									
 ◀ AUDI A6 Avant [4B5; C5]									
2.4	02.98-04.01	115/120	0986 472 830	← 38	1987 470 040 <sup>7</sup>				
			0986 474 830		1987 474 496 <sup>8</sup>				
			0986 472 831	→ 38	1987 470 040 <sup>7</sup>				
			0986 474 831						
			0986 473 185		← 43	F 026 A06 121 <sup>7</sup>			
	06.01-01.05	100	0986 473 185		← 43	1987 474 496 <sup>8</sup>			
			0986 474 185		→ 43	F 026 A06 121 <sup>7</sup>			
			245	0986 472 830	← 38	1987 470 040 <sup>7</sup>			
				0986 474 830		1987 474 496 <sup>8</sup>			
				0986 472 831	→ 38	1987 470 040 <sup>7</sup>			
	125	0986 474 831							
		0986 473 185		← 43	1987 474 496 <sup>8</sup>				
		0986 474 185		→ 43	1987 474 496 <sup>8</sup>				
		245	0986 472 830	← 38	1987 470 040 <sup>7</sup>				
			0986 474 830		1987 474 496 <sup>8</sup>				
0986 472 831	→ 38		1987 470 040 <sup>7</sup>						
0986 474 831									
2.4	06.01-01.05	125	0986 473 185		← 43	F 026 A06 121 <sup>7</sup>			
2.4 quattro	04.97-01.99	121	0986 474 225		→ 38,1	1987 474 496 <sup>8</sup>			
2.4 quattro			0986 473 225		← 38,1	1987 470 040 <sup>7</sup>			
			0986 473 225		← 38,1	1987 474 496 <sup>8</sup>			
			02.98-05.01	115/120	0986 473 225		← 38,1	1987 470 040 <sup>7</sup>	
					0986 473 225		← 38,1	1987 474 496 <sup>8</sup>	
					0986 474 225		→ 38,1	1987 470 040 <sup>7</sup>	
			11.98-05.01	121	0986 474 225		→ 38,1	1987 470 040 <sup>7</sup>	
			06.01-01.05	125	0986 473 185		← 43	1987 474 496 <sup>8</sup>	
					0986 473 225		← 38,1	1987 470 040 <sup>7</sup>	
					0986 473 225		← 38,1	1987 474 496 <sup>8</sup>	
0986 474 185		→ 43			F 026 A06 121 <sup>7</sup>				
0986 474 225		→ 38,1			1987 470 040 <sup>7</sup>				
2.5 TDI	02.98-04.01	110			0986 472 830	← 38	1987 470 040 <sup>7</sup>		
					0986 474 830		1987 474 496 <sup>8</sup>		
2.5 TDI	10.99-01.05	132	0986 472 831	→ 38	1987 470 040 <sup>7</sup>				
			0986 474 831						
			0986 473 185		← 43	1987 474 496 <sup>8</sup>			
			0986 474 185		→ 43	1987 474 496 <sup>8</sup>			
			245	0986 472 830	← 38	1987 470 040 <sup>7</sup>			
	0986 474 830			1987 474 496 <sup>8</sup>					
	0986 472 831	→ 38		1987 470 040 <sup>7</sup>					
	0986 474 831								
	06.01-01.05	114/120	0986 473 185		← 43	F 026 A06 121 <sup>7</sup>			
			0986 473 185		← 43	1987 474 496 <sup>8</sup>			
			0986 474 185		→ 43	F 026 A06 121 <sup>7</sup>			
			245	0986 472 830	← 38	1987 470 040 <sup>7</sup>			
				0986 474 830		1987 474 496 <sup>8</sup>			
	0986 472 831	→ 38		1987 470 040 <sup>7</sup>					
	0986 474 831								
2.5 TDI quattro	02.98-05.00	110	0986 474 225		→ 38,1	1987 474 496 <sup>8</sup>			
			0986 473 225		← 38,1	1987 470 040 <sup>7</sup>			
	02.98-04.01	110	0986 474 225		→ 38,1	1987 470 040 <sup>7</sup>			
			0986 473 225		← 38,1	1987 474 496 <sup>8</sup>			
			0986 473 185		← 43	1987 474 496 <sup>8</sup>			
	11.98-04.01	110	0986 473 225		← 38,1	1987 474 496 <sup>8</sup>			
	10.99-01.05	132	0986 473 185		← 43	1987 474 496 <sup>8</sup>			
			0986 473 225		← 38,1	1987 470 040 <sup>7</sup>			
0986 473 225				← 38,1	1987 474 496 <sup>8</sup>				
0986 474 185				→ 43	1987 474 496 <sup>8</sup>				
0986 474 225		→ 38,1	1987 470 040 <sup>7</sup>						
2.5 TDI, TDI quattro	10.99-01.05	132	0986 474 185		→ 43	F 026 A06 121 <sup>7</sup>			
2.7 Biturbo	02.99-05.01	169	0986 472 830	← 38	1987 470 040 <sup>7</sup>				
			0986 474 830		1987 474 496 <sup>8</sup>				
			0986 472 831	→ 38	1987 470 040 <sup>7</sup>				
			0986 474 831						











									
2.7 Biturbo quattro	02.99-05.01	169	0 986 473 225	☞	← 38,1	1 987 470 040 <sup>7</sup>			
			0 986 473 225	☞	← 38,1	1 987 474 496 <sup>B</sup>			
			0 986 474 225	☞	→ 38,1	1 987 470 040 <sup>7</sup>			
	06.01-01.05	184	0 986 473 185	☞	← 43	F 026 A06 121 <sup>7</sup>			
			0 986 473 185	☞	← 43	1 987 474 496 <sup>B</sup>			
			0 986 473 225	☞	← 38,1	1 987 470 040 <sup>7</sup>			
			0 986 473 225	☞	← 38,1	1 987 474 496 <sup>B</sup>			
			0 986 474 185	☞	→ 43	F 026 A06 121 <sup>7</sup>			
			0 986 474 225	☞	→ 38,1	1 987 470 040 <sup>7</sup>			
			0 986 474 225	☞	→ 38,1	1 987 470 040 <sup>7</sup>			
	2.8	02.98-04.01	132/140	0 986 472 830	☞	← 38	1 987 470 040 <sup>7</sup>		
				0 986 474 830	☞		1 987 474 496 <sup>B</sup>		
				0 986 472 831	☞	→ 38	1 987 470 040 <sup>7</sup>		
142		0 986 472 830	☞	← 38	1 987 470 040 <sup>7</sup>				
		0 986 474 830	☞		1 987 474 496 <sup>B</sup>				
		0 986 472 831	☞	→ 38	1 987 470 040 <sup>7</sup>				
		0 986 474 831	☞						
2.8 quattro	02.98-07.99	142	0 986 474 225	☞	→ 38,1	1 987 474 496 <sup>B</sup>			
	02.98-05.01	142	0 986 473 225	☞	← 38,1	1 987 470 040 <sup>7</sup>			
			0 986 473 225	☞	← 38,1	1 987 474 496 <sup>B</sup>			
			0 986 474 225	☞	→ 38,1	1 987 470 040 <sup>7</sup>			
	04.98-05.01	132/140	0 986 473 225	☞	← 38,1	1 987 470 040 <sup>7</sup>			
			0 986 473 225	☞	← 38,1	1 987 474 496 <sup>B</sup>			
			0 986 474 225	☞	→ 38,1	1 987 470 040 <sup>7</sup>			
			0 986 473 185	☞	← 43	1 987 474 496 <sup>B</sup>			
			0 986 474 185	☞	→ 43	1 987 474 496 <sup>B</sup>			
3.0	06.01-01.05	160/162	0 986 472 830	☞	← 38	1 987 470 040 <sup>7</sup>			
			0 986 474 830	☞		1 987 474 496 <sup>B</sup>			
			0 986 472 831	☞	→ 38	1 987 470 040 <sup>7</sup>			
			0 986 474 831	☞					
	245	0 986 473 185	☞	→ 43	F 026 A06 121 <sup>7</sup>				
		0 986 473 185	☞	← 43	F 026 A06 121 <sup>7</sup>				
		0 986 473 185	☞	← 43	1 987 474 496 <sup>B</sup>				
		0 986 473 225	☞	← 38,1	1 987 470 040 <sup>7</sup>				
3.0, quattro	06.01-01.05	160/162	0 986 474 185	☞	→ 43	F 026 A06 121 <sup>7</sup>			
			0 986 473 185	☞	← 43	F 026 A06 121 <sup>7</sup>			
3.0 quattro	06.01-01.05	160/162	0 986 473 185	☞	← 43	1 987 474 496 <sup>B</sup>			
			0 986 473 225	☞	← 38,1	1 987 470 040 <sup>7</sup>			
			0 986 473 225	☞	← 38,1	1 987 474 496 <sup>B</sup>			
			0 986 474 225	☞	→ 38,1	1 987 470 040 <sup>7</sup>			
	1.8	02.98-04.01	85/92	1 987 477 603	☞	← 1958			
				1 987 477 604	☞	→ 1958			
	1.8 T	02.98-01.05	110/132	1 987 477 603	☞	← 1958			
				1 987 477 604	☞	→ 1958			
	1.8 T quattro	02.98-01.05	110/132	1 987 477 959	☞	↔ 1925			
	1.9 TDI	02.98-04.01	81/85	1 987 477 603	☞	← 1958			
				1 987 477 604	☞	→ 1958			
	06.01-01.05	96	1 987 477 603	☞	← 1958				
			1 987 477 604	☞	→ 1958				
			1 987 477 604	☞	→ 1958				
	2.0	06.01-01.05	96	1 987 477 603	☞	← 1958			
				1 987 477 604	☞	→ 1958			
	2.4	04.97-04.01	115/120/ 121	1 987 477 603	☞	← 1958			
				1 987 477 604	☞	→ 1958			
		02.98-05.00	100	1 987 477 603	☞	← 1958			
				1 987 477 604	☞	→ 1958			
				1 987 477 603	☞	← 1958			
		06.01-01.05	100	1 987 477 603	☞	← 1958			
				1 987 477 604	☞	→ 1958			
125	1 987 477 603	☞	← 1958						
	1 987 477 604	☞	→ 1958						
	1 987 477 604	☞	→ 1958						
2.4 quattro	04.97-05.01	115/120/121	1 987 477 959	☞	↔ 1925				
	06.01-01.05	125	1 987 477 959	☞	↔ 1925				





◀ AUDI A6 Avant [4B5; C5]									
2.5 TDI	02.98-04.01	110				1987 477 603		← 1958	
						1987 477 604		→ 1958	
	10.99-01.05	132				1987 477 603		← 1958	
						1987 477 604		→ 1958	
	06.01-01.05	114/120				1987 477 603		← 1958	
						1987 477 604		→ 1958	
	2.5 TDI quattro	02.98-04.01	110			1987 477 959		↔ 1925	
		10.99-01.05	132			1987 477 959		↔ 1925	
	2.7 Biturbo	02.99-05.01	169			1987 477 603		← 1958	
						1987 477 604		→ 1958	
2.7 Biturbo quattro	02.99-05.01	169				1987 477 959		↔ 1925	
	06.01-01.05	184				1987 477 959		↔ 1925	
2.8	02.98-04.01	132/140/142				1987 477 603		← 1958	
						1987 477 604		→ 1958	
2.8 quattro	02.98-05.01	132/140/142				1987 477 959		↔ 1925	
3.0	06.01-01.05	160/162				1987 477 603		← 1958	
						1987 477 604		→ 1958	
3.0 quattro	06.01-01.05	160/162				1987 477 959		↔ 1925	
1.8	02.98-12.98	85	Fg.-Nr. →4B..X..060 000			0986 594 006 <sup>3</sup>			
		92	Fg.-Nr. →4B..X..060 000			0986 594 006 <sup>3</sup>			
	12.98-04.99	92	Fg.-Nr. 4B..X..060 001→			0986 594 007 <sup>3</sup>			
	12.98-05.00	85	Fg.-Nr. 4B..X..060 001→			0986 594 007 <sup>3</sup>			
	01.99-04.01	92				0986 594 007 <sup>3</sup>			
1.8 T	02.98-01.99	110				0986 594 006 <sup>3</sup>			
	02.98-10.00	132				0986 594 006 <sup>3</sup>			
	12.98-04.01	110	Fg.-Nr. 4B..X..060 001→			0986 594 007 <sup>3</sup>			
1.8 T quattro	01.99-01.05	110				0986 594 007 <sup>3</sup>			
	02.98-12.98	110	Fg.-Nr. →4B..X..060 000			0986 594 006 <sup>3</sup>			
		132	Fg.-Nr. →4B..X..060 000			0986 594 006 <sup>3</sup>			
	12.98-10.00	132	Fg.-Nr. 4B..X..060 001→			0986 594 007 <sup>3</sup>			
			Fg.-Nr. 4B..X..062 732→		ALR,LAB	0265 006 586 <sup>4</sup>			
					ALR,RAB	0265 006 584 <sup>4</sup>			
					ALR	0265 006 584 <sup>4</sup>			
	12.98-05.01	110	Fg.-Nr. 4B..X..060 001→			0986 594 007 <sup>3</sup>			
			Fg.-Nr. 4B..X..062 732→		ALR,LAB	0265 006 586 <sup>4</sup>			
					ALR,RAB	0265 006 584 <sup>4</sup>			
					ALR	0265 006 584 <sup>4</sup>			
	01.99-09.00	110				0986 594 007 <sup>3</sup>			
					ALR,LAB	0265 006 586 <sup>4</sup>			
					ALR,RAB	0265 006 584 <sup>4</sup>			
					ALR	0265 006 584 <sup>4</sup>			
	05.00-08.01	110	Fg.-Nr. →4B..2..031 500			0986 594 007 <sup>3</sup>			
	05.00-12.01	110	Fg.-Nr. →4B..2..079 500		ALR,LAB	0265 006 586 <sup>4</sup>			
					ALR,RAB	0265 006 584 <sup>4</sup>			
					ALR	0265 006 584 <sup>4</sup>			
	09.01-06.02	110	Fg.-Nr. 4B..2..031 501→			0265 006 578 <sup>3</sup>			
			4B..2..200 000						
	12.01-01.05	110	Fg.-Nr. 4B..2..079 501→		ALR,LAB	0265 006 763 <sup>4</sup>			
					ALR,RAB	0265 006 761 <sup>4</sup>			
					ALR	0265 006 761 <sup>4</sup>			
	07.02-01.05	110	Fg.-Nr. 4B..3..000 001→			0265 006 765 <sup>3</sup>			
1.9 TDI	02.98-12.98	81	Fg.-Nr. →4B..X..060 000			0986 594 006 <sup>3</sup>			
	02.98-04.01	85				0986 594 007 <sup>3</sup>			
	12.98-04.01	81	Fg.-Nr. 4B..X..060 001→			0986 594 007 <sup>3</sup>			
	06.01-08.01	96	Fg.-Nr. →4B..2..031 500			0986 594 007 <sup>3</sup>			
	09.01-06.02	96	Fg.-Nr. 4B..2..031 501→4B..2..200 000			0265 006 578 <sup>3</sup>			
	07.02-01.05	96	Fg.-Nr. 4B..3..000 001→			0265 006 765 <sup>3</sup>			
2.0	06.01-08.01	96	Fg.-Nr. →4B..2..031 500			0986 594 007 <sup>3</sup>			
	09.01-06.02	96	Fg.-Nr. 4B..2..031 501→4B..2..200 000			0265 006 578 <sup>3</sup>			
	07.02-01.05	96	Fg.-Nr. 4B..3..000 001→			0265 006 765 <sup>3</sup>			



		S							
2.4	02.98-07.98	120					0 986 594 006 <sup>3</sup>		
	02.98-12.98	100	Fg.-Nr. →4B..X..060 000				0 986 594 006 <sup>3</sup>		
	04.98-12.98	115	Fg.-Nr. →4B..X..060 000				0 986 594 006 <sup>3</sup>		
	11.98-12.98	120	Fg.-Nr. →4B..X..060 000				0 986 594 006 <sup>3</sup>		
	12.98-01.99	100	Fg.-Nr. 4B..X..060 001→				0 986 594 007 <sup>3</sup>		
	12.98-05.00	120	Fg.-Nr. 4B..X..060 001→				0 986 594 007 <sup>3</sup>		
	12.98-04.01	121	Fg.-Nr. 4B..X..060 001→				0 986 594 007 <sup>3</sup>		
	02.99-05.00	100					0 986 594 007 <sup>3</sup>		
	06.00-04.01	120					0 986 594 007 <sup>3</sup>		
	06.01-08.01	100	Fg.-Nr. →4B..2..031 500				0 986 594 007 <sup>3</sup>		
	09.01-06.02	100	Fg.-Nr. 4B..2..031 501→4B..2..200 000				0 265 006 578 <sup>3</sup>		
		125	Fg.-Nr. 4B..2..031 501→4B..2..200 000				0 265 006 578 <sup>3</sup>		
	07.02-01.05	100	Fg.-Nr. 4B..3..000 001→				0 265 006 765 <sup>3</sup>		
	2.4 quattro	04.97-12.98	121	Fg.-Nr. →4B..X..060 000				0 986 594 006 <sup>3</sup>	
06.01-08.01		125	Fg.-Nr. →4B..2..031 500				0 986 594 007 <sup>3</sup>		
07.02-01.05		125	Fg.-Nr. 4B..3..000 001→				0 265 006 765 <sup>3</sup>		
2.4 quattro	02.98-12.98	120	Fg.-Nr. →4B..X..060 000				0 986 594 006 <sup>3</sup>		
	08.98-12.98	115	Fg.-Nr. →4B..X..060 000				0 986 594 006 <sup>3</sup>		
	12.98-05.01	115	Fg.-Nr. 4B..X..060 001→				0 986 594 007 <sup>3</sup>		
			Fg.-Nr. 4B..X..062 732→	ALR,LAB			0 265 006 584 <sup>4</sup>		
				ALR,RAB			0 265 006 584 <sup>4</sup>		
				ALR			0 265 006 584 <sup>4</sup>		
		120	Fg.-Nr. 4B..X..060 001→				0 986 594 007 <sup>3</sup>		
			Fg.-Nr. 4B..X..062 732→	ALR,LAB			0 265 006 584 <sup>4</sup>		
				ALR,RAB			0 265 006 584 <sup>4</sup>		
				ALR			0 265 006 584 <sup>4</sup>		
		121	Fg.-Nr. 4B..X..060 001→				0 986 594 007 <sup>3</sup>		
			Fg.-Nr. 4B..X..062 732→	ALR,LAB			0 265 006 584 <sup>4</sup>		
				ALR,RAB			0 265 006 584 <sup>4</sup>		
				ALR			0 265 006 584 <sup>4</sup>		
		06.00-05.01	121				0 986 594 007 <sup>3</sup>		
							ALR,LAB	0 265 006 584 <sup>4</sup>	
						ALR,RAB	0 265 006 584 <sup>4</sup>		
						ALR	0 265 006 584 <sup>4</sup>		
	06.01-12.01	125	Fg.-Nr. →4B..2..079 500				ALR,LAB	0 265 006 584 <sup>4</sup>	
							ALR,RAB	0 265 006 584 <sup>4</sup>	
							ALR	0 265 006 584 <sup>4</sup>	
	09.01-06.02	125	Fg.-Nr. 4B..2..031 501→ 4B..2..200 000					0 265 006 578 <sup>3</sup>	
	12.01-01.05	125	Fg.-Nr. 4B..2..079 501→				ALR,LAB	0 265 006 763 <sup>4</sup>	
							ALR,RAB	0 265 006 761 <sup>4</sup>	
							ALR	0 265 006 761 <sup>4</sup>	
2.5 TDI	06.01-08.01	114	Fg.-Nr. →4B..2..031 500					0 986 594 007 <sup>3</sup>	
	09.01-06.02	114	Fg.-Nr. 4B..2..031 501→					0 265 006 578 <sup>3</sup>	
		132	Fg.-Nr. 4B..2..031 501→ 4B..2..200 000					0 265 006 578 <sup>3</sup>	
	07.02-01.05	120						0 265 006 765 <sup>3</sup>	
2.5 TDI quattro	12.98-04.01	110	Fg.-Nr. 4B..X..062 732→				ALR,LAB	0 265 006 586 <sup>4</sup>	
							ALR,RAB	0 265 006 584 <sup>4</sup>	
							ALR	0 265 006 584 <sup>4</sup>	
	10.99-12.01	132	Fg.-Nr. →4B..2..079 500				ALR,LAB	0 265 006 586 <sup>4</sup>	
							ALR,RAB	0 265 006 584 <sup>4</sup>	
							ALR	0 265 006 584 <sup>4</sup>	
	09.01-06.02	132	Fg.-Nr. 4B..2..031 501→ 4B..2..200 000					0 265 006 578 <sup>3</sup>	
	12.01-08.03	132	Fg.-Nr. 4B..2..079 501→				ALR,LAB	0 265 006 763 <sup>4</sup>	
							ALR,RAB	0 265 006 761 <sup>4</sup>	
							ALR	0 265 006 761 <sup>4</sup>	
	02.03-01.05	132					ALR,LAB	0 265 006 763 <sup>4</sup>	
							ALR,RAB	0 265 006 761 <sup>4</sup>	
							ALR	0 265 006 761 <sup>4</sup>	



		S								
◀ AUDI A6 Avant [4B5; C5]										
2.5 TDI	02.98-12.98	110	Fg.-Nr. →4B..X..060 000				0986 594 006 <sup>3</sup>			
2.5 TDI quattro	12.98-04.01	110	Fg.-Nr. 4B..X..060 001→				0986 594 007 <sup>3</sup>			
	10.99-08.01	132	Fg.-Nr. →4B..2..031 500				0986 594 007 <sup>3</sup>			
	07.02-08.03	132	Fg.-Nr. 4B..3..000 001→				0265 006 765 <sup>3</sup>			
	11.02-01.05	132					0265 006 765 <sup>3</sup>			
2.7 Biturbo quattro	02.99-05.01	169		ALR,LAB			0265 006 586 <sup>4</sup>			
				ALR,RAB			0265 006 584 <sup>4</sup>			
				ALR			0265 006 584 <sup>4</sup>			
	06.01-08.01	184	Fg.-Nr. →4B..2..031 500				0986 594 007 <sup>3</sup>			
	06.01-12.01	184	Fg.-Nr. →4B..2..079 500		ALR,LAB			0265 006 586 <sup>4</sup>		
					ALR,RAB			0265 006 584 <sup>4</sup>		
					ALR			0265 006 584 <sup>4</sup>		
	09.01-06.02	184	Fg.-Nr. 4B..2..031 501→				0265 006 578 <sup>3</sup>			
	12.01-06.02	184	Fg.-Nr. 4B..2..079 501→		ALR,LAB			0265 006 763 <sup>4</sup>		
					ALR,RAB			0265 006 761 <sup>4</sup>		
					ALR			0265 006 761 <sup>4</sup>		
	07.02-01.05	184						0265 006 765 <sup>3</sup>		
				ALR,LAB			0265 006 763 <sup>4</sup>			
				ALR,RAB			0265 006 761 <sup>4</sup>			
				ALR			0265 006 761 <sup>4</sup>			
2.7 Biturbo, Biturbo quattro	02.99-05.01	169					0986 594 007 <sup>3</sup>			
2.8	12.98-04.01	142	Fg.-Nr. 4B..X..060 001→				0986 594 007 <sup>3</sup>			
2.8 quattro	02.98-12.98	132	Fg.-Nr. →4B..X..060 000				0986 594 006 <sup>3</sup>			
	02.98-07.99	142					0986 594 006 <sup>3</sup>			
	12.98-05.01	132	Fg.-Nr. 4B..X..060 001→				0986 594 007 <sup>3</sup>			
	07.99-05.01	140					0986 594 007 <sup>3</sup>			
2.8 quattro	12.98-01.99	142	Fg.-Nr. 4B..X..060 001→				0986 594 007 <sup>3</sup>			
					ALR,LAB			0265 006 586 <sup>4</sup>		
					ALR,RAB			0265 006 584 <sup>4</sup>		
	12.98-07.99	142	Fg.-Nr. 4B..X..062 732→		ALR			0265 006 584 <sup>4</sup>		
					ALR,LAB			0265 006 586 <sup>4</sup>		
					ALR,RAB			0265 006 584 <sup>4</sup>		
	12.98-05.01	132	Fg.-Nr. 4B..X..062 732→		ALR			0265 006 584 <sup>4</sup>		
					ALR,LAB			0265 006 586 <sup>4</sup>		
					ALR,RAB			0265 006 584 <sup>4</sup>		
	01.99-05.01	142						0986 594 007 <sup>3</sup>		
					ALR,LAB			0265 006 586 <sup>4</sup>		
					ALR,RAB			0265 006 584 <sup>4</sup>		
				ALR			0265 006 584 <sup>4</sup>			
07.99-05.01	140			ALR,LAB			0265 006 586 <sup>4</sup>			
				ALR,RAB			0265 006 584 <sup>4</sup>			
				ALR			0265 006 584 <sup>4</sup>			
3.0	06.01-08.01	162	Fg.-Nr. →4B..2..031 500				0986 594 007 <sup>3</sup>			
	09.01-06.02	160	Fg.-Nr. 4B..2..031 501→				0265 006 578 <sup>3</sup>			
		162	Fg.-Nr. 4B..2..031 501→ 4B..2..200 000					0265 006 578 <sup>3</sup>		
3.0	06.01-08.01	160	Fg.-Nr. →4B..2..031 500				0986 594 007 <sup>3</sup>			
3.0 quattro	07.02-01.05	160	Fg.-Nr. 4B..3..000 001→				0265 006 765 <sup>3</sup>			
		162	Fg.-Nr. 4B..3..000 001→				0265 006 765 <sup>3</sup>			
3.0 quattro	06.01-08.01	162	Fg.-Nr. →4B..2..031 500				0986 594 007 <sup>3</sup>			
					ALR,LAB			0265 006 586 <sup>4</sup>		
					ALR,RAB			0265 006 584 <sup>4</sup>		
	06.01-12.01	160	Fg.-Nr. →4B..2..079 500		ALR			0265 006 584 <sup>4</sup>		
					ALR,LAB			0265 006 586 <sup>4</sup>		
					ALR,RAB			0265 006 584 <sup>4</sup>		
	162	Fg.-Nr. →4B..2..079 500		ALR				0265 006 584 <sup>4</sup>		
				ALR,LAB			0265 006 586 <sup>4</sup>			
				ALR,RAB			0265 006 584 <sup>4</sup>			
	06.01-06.02	162	Fg.-Nr. →4B..2..031 500			B17,B18	0265 006 578 <sup>3</sup>			
	09.01-06.02	160	Fg.-Nr. 4B..2..031 501→				165	0986 594 007 <sup>3</sup>		
								0265 006 578 <sup>3</sup>		
162	Fg.-Nr. 4B..2..031 501→						0265 006 578 <sup>3</sup>			
						0265 006 578 <sup>3</sup>				
				4B..2..200 000						
				4B..2..200 000						





















		S							
3.0 quattro		12.01-01.05	160	Fg.-Nr. 4B..2..079 501→	ALR,LAB	0 265 006 763 <sup>4</sup>			
					ALR,RAB	0 265 006 761 <sup>4</sup>			
					ALR	0 265 006 761 <sup>4</sup>			
			162	Fg.-Nr. 4B..2..079 501→	ALR,LAB	0 265 006 763 <sup>4</sup>			
					ALR,RAB	0 265 006 761 <sup>4</sup>			
					ALR	0 265 006 761 <sup>4</sup>			
<b>A6 Avant [4B5;C5]</b>									
	2.4	06.00-04.01	121	PR-Code 1LB, PR-Code 1LE	288	0 986 473 070		← 56,93	
						0 986 474 070		→ 56,93	
				PR-Code 1LB, PR-Code 1LE, PR-Code 1LT, PR-Code 1LF	288,312				1 987 470 005 <sup>7</sup> 1 987 470 506 <sup>8</sup>
				PR-Code 1LT, PR-Code 1LF	312	0 986 473 070		← 56,93	
						0 986 474 070		→ 56,93	
	2.4	06.00-04.01	121			0 986 473 225		← 38,1	1 987 470 040 <sup>7</sup>
						0 986 473 225		← 38,1	1 987 474 496 <sup>8</sup>
						0 986 474 225		→ 38,1	1 987 470 040 <sup>7</sup>
	2.4	06.00-04.01	121			1 987 477 959		↔ 1925	
	2.4	06.00-04.01	121			0 986 594 007 <sup>3</sup>			
					ALR,LAB	0 265 006 586 <sup>4</sup>			
					ALR,RAB	0 265 006 584 <sup>4</sup>			
					ALR	0 265 006 584 <sup>4</sup>			
<b>A6 Avant [4B6; C5]</b>									
	4.2 quattro	06.01-01.05	220		312	0 986 473 070		← 56,93	1 987 470 005 <sup>7</sup>
						0 986 473 070		← 56,93	1 987 470 506 <sup>8</sup>
						0 986 474 070		→ 56,93	1 987 470 005 <sup>7</sup>
					321,FSB	0 986 134 078		← 60	1 987 470 506 <sup>8</sup>
						0 986 135 078		→ 60	1 987 470 506 <sup>8</sup>
					321,SSB	0 986 134 074		← 43	1 987 470 506 <sup>8</sup>
						0 986 135 074		→ 43	1 987 470 506 <sup>8</sup>
	4.2 quattro	06.01-01.05	220			0 986 473 185		← 43	F 026 A06 121 <sup>7</sup>
						0 986 473 185		← 43	1 987 474 496 <sup>8</sup>
						0 986 474 185		→ 43	F 026 A06 121 <sup>7</sup>
	4.2 quattro	06.01-01.05	220			1 987 477 959		↔ 1925	
	4.2 quattro	06.01-12.01	220	Fg.-Nr. →4B..2..079 500	LAB	0 265 006 567 <sup>4</sup>			
					RAB	0 265 006 565 <sup>4</sup>			
		06.01-06.02	220	Fg.-Nr. →4B..2..200 000		0 265 006 578 <sup>3</sup>			
		12.01-01.05	220	Fg.-Nr. 4B..2..079 501→	LAB	0 265 006 769 <sup>4</sup>			
		01.02-01.05	220	Fg.-Nr. 4B..2..079 501→	RAB	0 265 006 767 <sup>4</sup>			
		07.02-01.05	220	Fg.-Nr. 4B..3..000 001→		0 265 006 765 <sup>3</sup>			





◀ AUDI										
<b>A6 Avant [4F5, C6]</b>										
	<b>2.8 FSI quattro</b>	11.06-10.08	154	PR-Code 1LG, PR-Code 1LD	321	0986 473 229		← 60		
						0986 474 229		→ 60		
				PR-Code 1LT	S31					1987 470 005 <sup>7</sup>
						0986 473 070		← 56,93	1987 470 506 <sup>8</sup>	
						0986 474 070		→ 56,93	1987 470 506 <sup>8</sup>	
		PR-Code 1LT, PR-Code 1LG, PR-Code 1LD, PR-Code 1ZL, PR-Code 1LH	321,347, S31				1987 470 506 <sup>8</sup>			
<b>A6 Avant [4F5; C6]</b>										
	<b>2.0 TDI</b>	06.05-08.11	89/100/	PR-Code 1LG, PR-Code 1LD	321	0986 473 229		← 60		
						0986 474 229		→ 60		
	<b>2.0 TDI e</b>			103/120/	PR-Code 1LT	S31			1987 470 005 <sup>7</sup>	
							0986 473 070		← 56,93	1987 470 506 <sup>8</sup>
	<b>2.0 TFSI</b>			125	PR-Code 1LT	S31			1987 470 506 <sup>8</sup>	
							0986 474 070		→ 56,93	1987 470 506 <sup>8</sup>
			PR-Code 1LT, PR-Code 1LG, PR-Code 1LD, PR-Code 1ZL, PR-Code 1LH	321,347, S31				1987 470 506 <sup>8</sup>		
	<b>2.4 quattro</b>	03.05-10.08	130	PR-Code 1LG, PR-Code 1LD	321	0986 473 229		← 60		
						0986 474 229		→ 60		
				PR-Code 1LT	S31				1987 470 005 <sup>7</sup>	
					0986 473 070		← 56,93	1987 470 506 <sup>8</sup>		
				0986 474 070		→ 56,93	1987 470 506 <sup>8</sup>			
		PR-Code 1LT, PR-Code 1LG, PR-Code 1LD, PR-Code 1ZL, PR-Code 1LH	321,347, S31				1987 470 506 <sup>8</sup>			
<b>2.7 TDI</b>	03.05-10.08	132	PR-Code 1LT, PR-Code 1LG, PR-Code 1LD, PR-Code 1ZL, PR-Code 1LH	321,347, S31				1987 470 506 <sup>8</sup>		
					PR-Code 1ZL, PR-Code 1LH	347			1987 470 506 <sup>8</sup>	
			PR-Code 1LT, PR-Code 1LG, PR-Code 1LD, PR-Code 1ZL, PR-Code 1LH	321,347, S31				1987 470 506 <sup>8</sup>		
					0986 473 229		← 60			
				0986 474 229		→ 60				
<b>2.7 TDI quattro</b>	06.05-10.08	132	PR-Code 1LT, PR-Code 1LG, PR-Code 1LD, PR-Code 1ZL, PR-Code 1LH	321,347, S31				1987 470 506 <sup>8</sup>		
					0986 473 070		← 56,93	1987 470 506 <sup>8</sup>		
					0986 474 229		→ 60			
					0986 473 070		← 56,93	1987 470 506 <sup>8</sup>		
				0986 474 070		→ 56,93	1987 470 506 <sup>8</sup>			
		PR-Code 1LT, PR-Code 1LG, PR-Code 1LD, PR-Code 1ZL, PR-Code 1LH	321,347, S31				1987 470 506 <sup>8</sup>			
<b>2.7 TDI</b>	03.05-10.08	132	PR-Code 1LG, PR-Code 1LD	321	0986 473 229		← 60			
					0986 474 229		→ 60			
			PR-Code 1LT	S31				1987 470 005 <sup>7</sup>		
					0986 473 070		← 56,93	1987 470 506 <sup>8</sup>		
				0986 474 070		→ 56,93	1987 470 506 <sup>8</sup>			
		PR-Code 1LT, PR-Code 1LG, PR-Code 1LD, PR-Code 1ZL, PR-Code 1LH	321,347, S31				1987 470 506 <sup>8</sup>			
<b>2.7 TDI quattro</b>	03.05-10.08	132	PR-Code 1LG, PR-Code 1LD	321	0986 473 229		← 60			
					0986 474 229		→ 60			
			PR-Code 1LT	S31				1987 470 005 <sup>7</sup>		
					0986 473 070		← 56,93	1987 470 506 <sup>8</sup>		
				0986 474 070		→ 56,93	1987 470 506 <sup>8</sup>			
		PR-Code 1LT, PR-Code 1LG, PR-Code 1LD, PR-Code 1ZL, PR-Code 1LH	321,347, S31				1987 470 506 <sup>8</sup>			
<b>2.7 TDI</b>	10.08-08.11	140	PR-Code 1LG, PR-Code 1LD	321	0986 473 229		← 60			
					0986 474 229		→ 60			
			PR-Code 1LT	S31				1987 470 005 <sup>7</sup>		
					0986 473 070		← 56,93	1987 470 506 <sup>8</sup>		
				0986 474 070		→ 56,93	1987 470 506 <sup>8</sup>			
		PR-Code 1LT, PR-Code 1LG, PR-Code 1LD, PR-Code 1ZL, PR-Code 1LH	321,347, S31				1987 470 506 <sup>8</sup>			



										
<b>2.8 FSI</b> <b>2.8 FSI quattro</b>	11.06-08.11	140/154/ 162	PR-Code 1LG, PR-Code 1LD		321	0 986 473 229	 ← 60			
			PR-Code 1LT		S31		0 986 474 229	 → 60		
			PR-Code 1LT, PR-Code 1LG, PR-Code 1LD, PR-Code 1ZL, PR-Code 1LH		321,347, S31					1 987 470 005 <sup>7</sup>
							0 986 473 070	 ← 56,93	1 987 470 506 <sup>B</sup>	
<b>3.0</b> <b>3.0 quattro</b> <b>3.0 TDI quattro</b> <b>3.0 TFSI quattro</b>	03.05-08.11	155/160/ 165/171/ 176/213/ 220	PR-Code 1LG, PR-Code 1LD		321	0 986 473 229	 ← 60			
			PR-Code 1LT		S31				1 987 470 005 <sup>7</sup>	
			PR-Code 1LT, PR-Code 1LG, PR-Code 1LD, PR-Code 1ZL, PR-Code 1LH		321,347, S31					1 987 470 506 <sup>B</sup>
							0 986 474 070	 → 56,93	1 987 470 506 <sup>B</sup>	
<b>3.2 FSI</b> <b>3.2 FSI quattro</b>	03.05-10.08	188	PR-Code 1LG, PR-Code 1LD		321	0 986 473 229	 ← 60			
			PR-Code 1LT		S31				1 987 470 005 <sup>7</sup>	
							0 986 473 070	 ← 56,93	1 987 470 506 <sup>B</sup>	
							0 986 474 070	 → 56,93	1 987 470 506 <sup>B</sup>	
<b>4.2 FSI quattro, quattro</b>	03.05-08.11	246/257	PR-Code 1ZL, PR-Code 1LH		347			1 987 470 506 <sup>B</sup>		
	06.05-10.08	100	LAB			0 265 007 930				
			RAB			0 265 007 928				
							0 265 007 930			
							0 265 007 928			
		09.05-06.06	89	LAB			0 265 007 930			
				RAB			0 265 007 928			
								0 265 007 930 <sup>3</sup>		
								0 265 007 928 <sup>3</sup>		
		11.08-08.11	120/125	LAB			0 265 007 930 <sup>3</sup>			
				RAB			0 265 007 928 <sup>3</sup>			
								0 265 007 930 <sup>4</sup>		
								0 265 007 928 <sup>4</sup>		
<b>2.0 TDI e</b>	10.08-03.11	100	LAB			0 265 007 930 <sup>3</sup>				
			RAB			0 265 007 928 <sup>3</sup>				
<b>2.0 TFSI</b>	06.05-08.11	120/125	LAB			0 265 007 930 <sup>3</sup>				
			RAB			0 265 007 928 <sup>3</sup>				
<b>2.4</b> <b>2.4 quattro</b>	03.05-10.08	130	LAB			0 265 007 930				
			RAB			0 265 007 928				
<b>2.7 TDI</b>	03.05-05.06	120	LAB			0 265 007 930				
			RAB			0 265 007 928				
	10.08-05.09	120	LAB			0 265 007 930 <sup>3</sup>				
			RAB			0 265 007 928 <sup>3</sup>				
	10.08-08.11	140	LAB			0 265 007 930 <sup>3</sup>				
			RAB			0 265 007 928 <sup>3</sup>				
<b>2.7 TDI quattro</b>	06.05-10.08	120	LAB			0 265 007 930				
			RAB			0 265 007 928				





<b>◀ AUDI A6 Avant [4F5; C6]</b>									
2.7 TDI quattro	10.08-08.11	120	LAB	0 265 007 930 <sup>3</sup>					
			RAB	0 265 007 928 <sup>3</sup>					
140			LAB	0 265 007 930 <sup>3</sup>					
			RAB	0 265 007 928 <sup>3</sup>					
2.7 TDI	03.05-10.08	132	LAB	0 265 007 930					
2.7 TDI quattro			RAB	0 265 007 928					
2.8 FSI	10.08-08.11	140/162	LAB	0 265 007 930 <sup>3</sup>					
			RAB	0 265 007 928 <sup>3</sup>					
2.8 FSI quattro	10.08-08.11	140/162	LAB	0 265 007 930 <sup>3</sup>					
			RAB	0 265 007 928 <sup>3</sup>					
3.0, quattro, TDI quattro	03.05-05.06	160/165	LAB	0 265 007 930					
			RAB	0 265 007 928					
3.0 TDI quattro	03.05-10.08	155	LAB	0 265 007 930					
			RAB	0 265 007 928					
	06.06-08.11	171/176/ 213/220	LAB	0 265 007 930 <sup>3</sup>					
			RAB	0 265 007 928 <sup>3</sup>					
	10.08-08.11	155	LAB	0 265 007 930 <sup>3</sup>					
			RAB	0 265 007 928 <sup>3</sup>					
3.0 TFSI quattro	10.08-08.11	171/176/ 213/220	LAB	0 265 007 930 <sup>3</sup>					
			RAB	0 265 007 928 <sup>3</sup>					
3.2 FSI	03.05-10.08	188	LAB	0 265 007 930 <sup>3</sup>					
			RAB	0 265 007 928 <sup>3</sup>					
3.2 FSI quattro	03.05-10.08	188	LAB	0 265 007 930 <sup>3</sup>					
			RAB	0 265 007 928 <sup>3</sup>					
4.2 FSI quattro	06.06-08.11	257	LAB	0 265 007 930 <sup>3</sup>					
			RAB	0 265 007 928 <sup>3</sup>					
4.2 quattro	03.05-05.06	246	LAB	0 265 007 930					
			RAB	0 265 007 928					

**A6 Avant [4G; C7]**

1.8 TFSI	09.14->	140	LAB	0 265 007 928 <sup>4</sup>					
			RAB	0 265 007 930 <sup>3</sup>					
2.0 FSI	06.11-04.15	100/110/ 120/130/ 132/140/ 185	LAB	0 265 007 928 <sup>4</sup>					
			RAB	0 265 007 930 <sup>3</sup>					

	S								
2.0 TDI	05.11→	100/110/ 120/130/ 132/140/ 185	LAB	0 265 007 928 <sup>4</sup>					
				0 265 007 930 <sup>3</sup>					
2.0 TDI quattro	04.15→	100/110/ 120/130/ 132/140/ 185	LAB	0 265 007 928 <sup>4</sup>					
			RAB	0 265 007 930 <sup>3</sup>					
2.0 TFSI	09.14→	100/110/ 120/130/ 132/140/ 185	LAB	0 265 007 928 <sup>4</sup>					
			RAB	0 265 007 930 <sup>3</sup>					
2.8 FSI	05.11→	150/162	LAB	0 265 007 928 <sup>4</sup>					
			RAB	0 265 007 930 <sup>3</sup>					
2.8 FSI quattro	05.11-04.15	150/162	LAB	0 265 007 928 <sup>4</sup>					
			RAB	0 265 007 930 <sup>3</sup>					
2.8 TFSI quattro	09.14→	150/162	LAB	0 265 007 928 <sup>4</sup>					
			RAB	0 265 007 930 <sup>3</sup>					
3.0 TDI	05.11→	150/155/160/180/ 200/220/228/230/ 235/240/245	LAB	0 265 007 928 <sup>4</sup>					
			RAB	0 265 007 930 <sup>3</sup>					
3.0 TDI quattro	11.11→	150/155/160/180/ 200/220/228/230/ 235/240/245	LAB	0 265 007 928 <sup>4</sup>					
			RAB	0 265 007 930 <sup>3</sup>					
3.0 TFSI quattro	05.11→	150/155/160/180/ 200/220/228/230/ 235/240/245	LAB	0 265 007 928 <sup>4</sup>					
			RAB	0 265 007 930 <sup>3</sup>					

**A6 [4A2; C4]**

	1.8 1.8 quattro	06.94-10.97	92	0 986 473 929			← 57	1 987 470 005 <sup>7</sup>
				0 986 473 930				
1.9 TDI	06.94-10.97	66	0 986 473 929			← 57	1 987 470 005 <sup>7</sup>	
			0 986 473 930					
2.0 2.0 quattro	06.94-10.97	74/79/85/ 103	0 986 473 929			← 57	1 987 470 005 <sup>7</sup>	
			0 986 473 930					
2.3 2.3 quattro	06.94-10.97	98	0 986 473 929			← 57	1 987 470 005 <sup>7</sup>	
			0 986 473 930					
2.5 TDI	06.94-10.97	85	0 986 473 929			← 57	1 987 470 005 <sup>7</sup>	
			0 986 473 930					
2.5 TDI 2.5 TDI quattro	10.94-10.97	103	0 986 474 882			← 57	1 987 470 005 <sup>7</sup>	
			0 986 474 884					
2.6 2.6 quattro	06.94-10.97	102/110	0 986 474 882			← 57	1 987 470 005 <sup>7</sup>	
			0 986 474 884					



	<b>▲ AUDI A6 [4A2; C4]</b>								
2.8	06.94-12.97	120/128/				0986 474 882		57	1987 470 005 <sup>7</sup>
2.8 i		142				0986 474 882		57	1987 470 506 <sup>8</sup>
2.8 quattro						0986 474 884		57	1987 470 005 <sup>7</sup>
	1.8	06.94-10.97	92			0986 473 695		38	1987 470 040 <sup>7</sup>
						0986 474 695		38	1987 470 040 <sup>7</sup>
	1.8 quattro	10.95-10.97	92			0986 474 698		38	1987 470 040 <sup>7</sup>
						0986 473 698		38	1987 470 040 <sup>7</sup>
	1.9 TDI	06.94-10.97	66			0986 473 695		38	1987 470 040 <sup>7</sup>
						0986 474 695		38	1987 470 040 <sup>7</sup>
	2.0	06.94-10.97	74/79/85			0986 473 695		38	1987 470 040 <sup>7</sup>
						0986 474 695		38	1987 470 040 <sup>7</sup>
			103			0986 473 695		38	1987 470 040 <sup>7</sup>
						0986 474 695		38	1987 470 040 <sup>7</sup>
	2.0 quattro	06.94-10.97	103			0986 474 698		38	1987 470 040 <sup>7</sup>
						0986 473 698		38	1987 470 040 <sup>7</sup>
	2.3	06.94-10.97	98			0986 473 695		38	1987 470 040 <sup>7</sup>
						0986 474 695		38	1987 470 040 <sup>7</sup>
	2.3 quattro	08.94-07.95	98			0986 474 698		38	1987 470 040 <sup>7</sup>
						0986 473 698		38	1987 470 040 <sup>7</sup>
	2.4	07.95-10.97	110			0986 473 695		38	1987 470 040 <sup>7</sup>
						0986 474 695		38	1987 470 040 <sup>7</sup>
	2.5 TDI	06.94-10.97	85			0986 473 695		38	1987 470 040 <sup>7</sup>
						0986 474 695		38	1987 470 040 <sup>7</sup>
		10.94-10.97	103			0986 473 695		38	1987 470 040 <sup>7</sup>
						0986 474 695		38	1987 470 040 <sup>7</sup>
	2.5 TDI quattro	07.95-10.97	103			0986 474 698		38	1987 470 040 <sup>7</sup>
						0986 473 698		38	1987 470 040 <sup>7</sup>
	2.6	06.94-10.97	102/110			0986 473 695		38	1987 470 040 <sup>7</sup>
						0986 474 695		38	1987 470 040 <sup>7</sup>
	2.6 quattro	06.94-10.97	102/110			0986 474 698		38	1987 470 040 <sup>7</sup>
						0986 473 698		38	1987 470 040 <sup>7</sup>
	2.8	06.94-12.97	120/128/			0986 473 695		38	1987 470 040 <sup>7</sup>
	2.8 i		142			0986 474 695		38	1987 470 040 <sup>7</sup>
	2.8 quattro	06.94-10.97	120/128/			0986 474 698		38	1987 470 040 <sup>7</sup>
			142			0986 473 698		38	1987 470 040 <sup>7</sup>
	1.8	06.94-10.97	92			1987 477 687		1491	
	1.8 quattro	10.95-10.97	92			1987 477 813		1692	
						1987 477 815		1676	
	1.9 TDI	06.94-10.97	66			1987 477 687		1491	
	2.0	06.94-10.97	74/79/85			1987 477 687		1491	
			103			1987 477 687		1491	
	2.0 quattro	06.94-10.97	103			1987 477 813		1692	
						1987 477 815		1676	
	2.3	06.94-10.97	98			1987 477 687		1491	
	2.3 quattro	08.94-07.95	98			1987 477 813		1692	
						1987 477 815		1676	
	2.4	07.95-10.97	110			1987 477 687		1491	
	2.5 TDI	06.94-10.97	85			1987 477 687		1491	
		10.94-10.97	103			1987 477 687		1491	
	2.5 TDI quattro	07.95-10.97	103			1987 477 813		1692	
						1987 477 815		1676	
	2.6	06.94-10.97	102/110			1987 477 687		1491	
	2.6 quattro	06.94-10.97	102/110			1987 477 813		1692	
						1987 477 815		1676	
	2.8	06.94-10.97	120/128/142			1987 477 687		1491	
	2.8 quattro	06.94-10.97	120/128/			1987 477 813		1692	
			142			1987 477 815		1676	



			S							
<b>A6 [4B2; C5]</b>										
	<b>1.8</b>	04.97-05.04	85/92/	PR-Code 1LB, PR-Code 1LE	288	0 986 <b>473 070</b>		←	56,93	
	<b>1.8 T</b>		110/132			0 986 <b>474 070</b>		→	56,93	
	<b>1.8 T quattro</b>			PR-Code 1LB, PR-Code 1LE, PR-Code 1LT, PR-Code 1LF	288,312					1 987 <b>470 005</b> <sup>7</sup> 1 987 <b>470 506</b> <sup>8</sup>
				PR-Code 1LT, PR-Code 1LF	312	0 986 <b>473 070</b>		←	56,93	
						0 986 <b>474 070</b>		→	56,93	
	<b>1.9 TDI</b>	04.97-04.01	81/85	PR-Code 1LB, PR-Code 1LE	288	0 986 <b>473 070</b>		←	56,93	
						0 986 <b>474 070</b>		→	56,93	
				PR-Code 1LB, PR-Code 1LE, PR-Code 1LT, PR-Code 1LF	288,312					1 987 <b>470 005</b> <sup>7</sup> 1 987 <b>470 506</b> <sup>8</sup>
				PR-Code 1LT, PR-Code 1LF	312	0 986 <b>473 070</b>		←	56,93	
						0 986 <b>474 070</b>		→	56,93	
		06.01-05.04	96	PR-Code 1LB, PR-Code 1LE	288	0 986 <b>473 070</b>		←	56,93	
						0 986 <b>474 070</b>		→	56,93	
				PR-Code 1LB, PR-Code 1LE, PR-Code 1LT, PR-Code 1LF	288,312					1 987 <b>470 005</b> <sup>7</sup> 1 987 <b>470 506</b> <sup>8</sup>
				PR-Code 1LG, PR-Code 1LA		0 986 <b>134 078</b>		←	60	1 987 <b>470 506</b> <sup>8</sup>
						0 986 <b>135 078</b>		→	60	1 987 <b>470 506</b> <sup>8</sup>
				PR-Code 1LT, PR-Code 1LF	312	0 986 <b>473 070</b>		←	56,93	
						0 986 <b>474 070</b>		→	56,93	
	<b>2.0</b>	06.01-05.04	96	PR-Code 1LB, PR-Code 1LE	288	0 986 <b>473 070</b>		←	56,93	
						0 986 <b>474 070</b>		→	56,93	
				PR-Code 1LB, PR-Code 1LE, PR-Code 1LT, PR-Code 1LF	288,312					1 987 <b>470 005</b> <sup>7</sup> 1 987 <b>470 506</b> <sup>8</sup>
				PR-Code 1LG, PR-Code 1LA		0 986 <b>134 078</b>		←	60	1 987 <b>470 506</b> <sup>8</sup>
						0 986 <b>135 078</b>		→	60	1 987 <b>470 506</b> <sup>8</sup>
				PR-Code 1LT, PR-Code 1LF	312	0 986 <b>473 070</b>		←	56,93	
						0 986 <b>474 070</b>		→	56,93	
	<b>2.4</b>	04.97-05.00	120	PR-Code 1LB, PR-Code 1LE	288	0 986 <b>473 070</b>		←	56,93	
						0 986 <b>474 070</b>		→	56,93	
				PR-Code 1LB, PR-Code 1LE, PR-Code 1LT, PR-Code 1LF	288,312					1 987 <b>470 005</b> <sup>7</sup> 1 987 <b>470 506</b> <sup>8</sup>
				PR-Code 1LT, PR-Code 1LF	312	0 986 <b>473 070</b>		←	56,93	
						0 986 <b>474 070</b>		→	56,93	
		08.97-05.00	100	PR-Code 1LB, PR-Code 1LE	288	0 986 <b>473 070</b>		←	56,93	
						0 986 <b>474 070</b>		→	56,93	
				PR-Code 1LB, PR-Code 1LE, PR-Code 1LT, PR-Code 1LF	288,312					1 987 <b>470 005</b> <sup>7</sup> 1 987 <b>470 506</b> <sup>8</sup>
				PR-Code 1LT, PR-Code 1LF	312	0 986 <b>473 070</b>		←	56,93	
						0 986 <b>474 070</b>		→	56,93	
		06.01-05.04	100	PR-Code 1LB, PR-Code 1LE	288	0 986 <b>473 070</b>		←	56,93	
						0 986 <b>474 070</b>		→	56,93	
				PR-Code 1LB, PR-Code 1LE, PR-Code 1LT, PR-Code 1LF	288,312					1 987 <b>470 005</b> <sup>7</sup> 1 987 <b>470 506</b> <sup>8</sup>
				PR-Code 1LG, PR-Code 1LA		0 986 <b>134 078</b>		←	60	1 987 <b>470 506</b> <sup>8</sup>
						0 986 <b>135 078</b>		→	60	1 987 <b>470 506</b> <sup>8</sup>
				PR-Code 1LT, PR-Code 1LF	312	0 986 <b>473 070</b>		←	56,93	
						0 986 <b>474 070</b>		→	56,93	
			120	PR-Code 1LB, PR-Code 1LE	288	0 986 <b>473 070</b>		←	56,93	
						0 986 <b>474 070</b>		→	56,93	
				PR-Code 1LB, PR-Code 1LE, PR-Code 1LT, PR-Code 1LF	288,312					1 987 <b>470 005</b> <sup>7</sup> 1 987 <b>470 506</b> <sup>8</sup>
				PR-Code 1LG, PR-Code 1LA		0 986 <b>134 078</b>		←	60	1 987 <b>470 506</b> <sup>8</sup>
						0 986 <b>135 078</b>		→	60	1 987 <b>470 506</b> <sup>8</sup>
				PR-Code 1LT, PR-Code 1LF	312	0 986 <b>473 070</b>		←	56,93	
						0 986 <b>474 070</b>		→	56,93	



		S							
<div style="display: flex; align-items: center;"> <span>◀ AUDI A6 [4B2; C5]</span> </div>									
2.4	2.4 quattro	04.97-09.01	121	PR-Code 1LB, PR-Code 1LE	288	0986 473 070		56,93	
						0986 474 070			
				PR-Code 1LB, PR-Code 1LE, PR-Code 1LT, PR-Code 1LF	288,312				1987 470 005 <sup>7</sup>
				PR-Code 1LT, PR-Code 1LF	312	0986 473 070		56,93	1987 470 506 <sup>8</sup>
						0986 474 070		56,93	
		04.98-04.01	115	PR-Code 1LB, PR-Code 1LE	288	0986 473 070		56,93	
								0986 474 070	
				PR-Code 1LB, PR-Code 1LE, PR-Code 1LT, PR-Code 1LF	288,312				1987 470 005 <sup>7</sup>
				PR-Code 1LT, PR-Code 1LF	312	0986 473 070		56,93	1987 470 506 <sup>8</sup>
						0986 474 070		56,93	
		06.01-05.04	125	PR-Code 1LB, PR-Code 1LE	288	0986 473 070		56,93	
								0986 474 070	
				PR-Code 1LB, PR-Code 1LE, PR-Code 1LT, PR-Code 1LF	288,312				1987 470 005 <sup>7</sup>
				PR-Code 1LG, PR-Code 1LA		0986 134 078		60	1987 470 506 <sup>8</sup>
						0986 135 078		60	1987 470 506 <sup>8</sup>
				PR-Code 1LT, PR-Code 1LF	312	0986 473 070		56,93	
						0986 474 070		56,93	
2.4 quattro		06.97-05.00	120	PR-Code 1LB, PR-Code 1LE	288	0986 473 070		56,93	
								0986 474 070	
				PR-Code 1LB, PR-Code 1LE, PR-Code 1LT, PR-Code 1LF	288,312				1987 470 005 <sup>7</sup>
				PR-Code 1LT, PR-Code 1LF	312	0986 473 070		56,93	1987 470 506 <sup>8</sup>
						0986 474 070		56,93	
2.5 TDI	2.5 TDI quattro	04.97-04.01	110	PR-Code 1LB, PR-Code 1LE	288	0986 473 070		56,93	
							0986 474 070		56,93
				PR-Code 1LB, PR-Code 1LE, PR-Code 1LT, PR-Code 1LF	288,312				1987 470 005 <sup>7</sup>
				PR-Code 1LT, PR-Code 1LF	312	0986 473 070		56,93	1987 470 506 <sup>8</sup>
						0986 474 070		56,93	
		10.99-05.04	114/120/ 132	PR-Code 1LB, PR-Code 1LE	288	0986 473 070		56,93	
								0986 474 070	
				PR-Code 1LB, PR-Code 1LE, PR-Code 1LT, PR-Code 1LF	288,312				1987 470 005 <sup>7</sup>
				PR-Code 1LT, PR-Code 1LF	312	0986 473 070		56,93	1987 470 506 <sup>8</sup>
						0986 474 070		56,93	
		06.01-05.04	114/120/ 132	PR-Code 1LG, PR-Code 1LA		0986 134 078		60	1987 470 506 <sup>8</sup>
							0986 135 078		60
2.7 Biturbo		02.99-05.01	169			0986 134 078		60	1987 470 506 <sup>8</sup>
							0986 135 078		60
2.7 Biturbo quattro		01.99-08.00	169	Fg.-Nr. 4B..X..060 001→		0986 134 074		43	
							0986 135 074		43
		09.00-05.01	169			0986 134 074		43	
							0986 135 074		43
		06.01-06.02	184		312	0986 473 070		56,93	1987 470 005 <sup>7</sup>
							0986 473 070		56,93
						0986 474 070		56,93	1987 470 005 <sup>7</sup>
				PR-Code 1LX		0986 134 074		43	
						0986 135 074		43	
		06.01-05.04	184	PR-Code 1LG, PR-Code 1LA		0986 134 078		60	1987 470 506 <sup>8</sup>
							0986 135 078		60
		07.02-05.04	184	PR-Code 1LB, PR-Code 1LE	288	0986 473 070		56,93	
								0986 474 070	
				PR-Code 1LB, PR-Code 1LE, PR-Code 1LT, PR-Code 1LF	288,312				1987 470 005 <sup>7</sup>
				PR-Code 1LT, PR-Code 1LF	312	0986 473 070		56,93	1987 470 506 <sup>8</sup>
						0986 474 070		56,93	



		S									
<b>2.8</b> 2.8 quattro		04.97-05.01	132/140/ 142	PR-Code 1LB, PR-Code 1LE	288	0 986 473 070		← 56,93			
						0 986 474 070		→ 56,93			
				PR-Code 1LB, PR-Code 1LE, PR-Code 1LT, PR-Code 1LF	288,312					1 987 470 005 <sup>7</sup>	1 987 470 506 <sup>8</sup>
				PR-Code 1LT, PR-Code 1LF	312	0 986 473 070		← 56,93			
<b>3.0</b>		06.01-05.04	162	PR-Code 1LB, PR-Code 1LE	288	0 986 473 070		← 56,93			
						0 986 474 070		→ 56,93			
				PR-Code 1LT, PR-Code 1LF	312	0 986 473 070		← 56,93			
						0 986 474 070		→ 56,93			
<b>3.0</b> 3.0 quattro		06.01-05.04	160	PR-Code 1LB, PR-Code 1LE	288	0 986 473 070		← 56,93			
						0 986 474 070		→ 56,93			
				PR-Code 1LB, PR-Code 1LE, PR-Code 1LT, PR-Code 1LF	288,312					1 987 470 005 <sup>7</sup>	1 987 470 506 <sup>8</sup>
				PR-Code 1LG, PR-Code 1LA		0 986 134 078		← 60	1 987 470 506 <sup>8</sup>		
						0 986 135 078		→ 60	1 987 470 506 <sup>8</sup>		
				PR-Code 1LT, PR-Code 1LF	312	0 986 473 070		← 56,93			
						0 986 474 070		→ 56,93			
				PR-Code 1LB, PR-Code 1LE, PR-Code 1LT, PR-Code 1LF PR-Code 1LG, PR-Code 1LA	288,312					1 987 470 005 <sup>7</sup>	1 987 470 506 <sup>8</sup>
		0 986 134 078		← 60	1 987 470 506 <sup>8</sup>						
		0 986 135 078		→ 60	1 987 470 506 <sup>8</sup>						
<b>3.0 quattro</b>		06.01-05.04	162	PR-Code 1LB, PR-Code 1LE	288	0 986 473 070		← 56,93			
						0 986 474 070		→ 56,93			
				PR-Code 1LT, PR-Code 1LF	312	0 986 473 070		← 56,93			
						0 986 474 070		→ 56,93			
		09.01-08.04	162			0 986 473 070		← 56,93	1 987 470 005 <sup>7</sup>		
						0 986 473 070		← 56,93	1 987 470 506 <sup>8</sup>		
						0 986 474 070		→ 56,93	1 987 470 005 <sup>7</sup>		
		05.97-04.01	85/92			0 986 472 830		← 38	1 987 470 040 <sup>7</sup>		
						0 986 474 830			1 987 474 496 <sup>8</sup>		
						0 986 472 831		→ 38	1 987 470 040 <sup>7</sup>		
						0 986 474 831					
<b>1.8 T</b>		04.97-05.04	110/132			0 986 472 830		← 38	1 987 470 040 <sup>7</sup>		
						0 986 474 830			1 987 474 496 <sup>8</sup>		
						0 986 472 831		→ 38	1 987 470 040 <sup>7</sup>		
						0 986 474 831					
<b>1.8 T quattro</b>		04.97-05.04	110/132			0 986 473 225		← 38,1	1 987 470 040 <sup>7</sup>		
						0 986 473 225		← 38,1	1 987 474 496 <sup>8</sup>		
						0 986 474 225		→ 38,1	1 987 470 040 <sup>7</sup>		
<b>1.9 TDI</b>		04.97-04.01	81/85			0 986 472 830		← 38	1 987 470 040 <sup>7</sup>		
						0 986 474 830			1 987 474 496 <sup>8</sup>		
						0 986 472 831		→ 38	1 987 470 040 <sup>7</sup>		
						0 986 474 831					
		06.01-05.04	96			0 986 473 185		← 43	F 026 A06 121 <sup>7</sup>		
						0 986 473 185		← 43	1 987 474 496 <sup>8</sup>		
						0 986 474 185		→ 43	F 026 A06 121 <sup>7</sup>		
				245		0 986 472 830		← 38	1 987 470 040 <sup>7</sup>		
						0 986 474 830			1 987 474 496 <sup>8</sup>		
						0 986 472 831		→ 38	1 987 470 040 <sup>7</sup>		
						0 986 474 831					
<b>2.0</b>		06.01-05.04	96			0 986 473 185		← 43	F 026 A06 121 <sup>7</sup>		
						0 986 473 185		← 43	1 987 474 496 <sup>8</sup>		
						0 986 474 185		→ 43	F 026 A06 121 <sup>7</sup>		
						245		0 986 472 830		← 38	1 987 470 040 <sup>7</sup>
								0 986 474 830			1 987 474 496 <sup>8</sup>
						0 986 472 831		→ 38	1 987 470 040 <sup>7</sup>		
						0 986 474 831					





		S							
	◀ AUDI A6 [4B2; C5]								
2.4	04.97-05.00	120	0986 472 830	← 38	1987 470 040 <sup>7</sup>	0986 474 830		1987 474 496 <sup>8</sup>	
			0986 472 831	→ 38	1987 470 040 <sup>7</sup>	0986 474 831			
	04.97-04.01	121	0986 472 830	← 38	1987 470 040 <sup>7</sup>	0986 474 830		1987 474 496 <sup>8</sup>	
			0986 472 831	→ 38	1987 470 040 <sup>7</sup>	0986 474 831			
	08.97-05.00	100	0986 472 830	← 38	1987 470 040 <sup>7</sup>	0986 474 830		1987 474 496 <sup>8</sup>	
			0986 472 831	→ 38	1987 470 040 <sup>7</sup>	0986 474 831			
	04.98-04.01	115	0986 472 830	← 38	1987 470 040 <sup>7</sup>	0986 474 830		1987 474 496 <sup>8</sup>	
			0986 472 831	→ 38	1987 470 040 <sup>7</sup>	0986 474 831			
	06.01-05.04	100	0986 473 185	← 43	F 026 A06 121 <sup>7</sup>	0986 473 185		1987 474 496 <sup>8</sup>	
			0986 474 185	→ 43	F 026 A06 121 <sup>7</sup>	0986 474 185			
		245	0986 472 830	← 38	1987 470 040 <sup>7</sup>	0986 474 830		1987 474 496 <sup>8</sup>	
			0986 472 831	→ 38	1987 470 040 <sup>7</sup>	0986 474 831			
		120	0986 473 185	← 43	F 026 A06 121 <sup>7</sup>	0986 473 185		1987 474 496 <sup>8</sup>	
			0986 474 185	→ 43	F 026 A06 121 <sup>7</sup>	0986 474 185			
		245	0986 472 830	← 38	1987 470 040 <sup>7</sup>	0986 474 830		1987 474 496 <sup>8</sup>	
			0986 472 831	→ 38	1987 470 040 <sup>7</sup>	0986 474 831			
		125	0986 473 185	← 43	F 026 A06 121 <sup>7</sup>	0986 473 185		1987 474 496 <sup>8</sup>	
			0986 474 185	→ 43	F 026 A06 121 <sup>7</sup>	0986 474 185			
		245	0986 472 830	← 38	1987 470 040 <sup>7</sup>	0986 474 830		1987 474 496 <sup>8</sup>	
			0986 472 831	→ 38	1987 470 040 <sup>7</sup>	0986 474 831			
2.4 quattro	04.97-09.01	121	0986 473 225	← 38,1	1987 470 040 <sup>7</sup>	0986 473 225		1987 474 496 <sup>8</sup>	
			0986 474 225	→ 38,1	1987 470 040 <sup>7</sup>	0986 474 225			
	06.97-05.00	120	0986 473 225	← 38,1	1987 470 040 <sup>7</sup>	0986 473 225		1987 474 496 <sup>8</sup>	
			0986 474 225	→ 38,1	1987 470 040 <sup>7</sup>	0986 474 225			
	08.98-07.99	115	0986 473 225	← 38,1	1987 470 040 <sup>7</sup>	0986 473 225		1987 474 496 <sup>8</sup>	
			0986 474 225	→ 38,1	1987 470 040 <sup>7</sup>	0986 474 225			
	06.01-05.04	125	0986 473 225	← 38,1	1987 470 040 <sup>7</sup>	0986 473 225		1987 474 496 <sup>8</sup>	
			0986 474 225	→ 38,1	1987 470 040 <sup>7</sup>	0986 474 225			
2.5 TDI	04.97-04.01	110	0986 472 830	← 38	1987 470 040 <sup>7</sup>	0986 474 830		1987 474 496 <sup>8</sup>	
			0986 472 831	→ 38	1987 470 040 <sup>7</sup>	0986 474 831			
	10.99-05.04	132	0986 473 185	← 43	F 026 A06 121 <sup>7</sup>	0986 473 185		1987 474 496 <sup>8</sup>	
			0986 474 185	→ 43	F 026 A06 121 <sup>7</sup>	0986 474 185			
		245	0986 472 830	← 38	1987 470 040 <sup>7</sup>	0986 474 830		1987 474 496 <sup>8</sup>	
			0986 472 831	→ 38	1987 470 040 <sup>7</sup>	0986 474 831			











<b>2.5 TDI</b>	06.01-05.04	114/120							
							0 986 473 185	← 43	F 026 A06 121 <sup>7</sup>
							0 986 473 185	← 43	1 987 474 496 <sup>8</sup>
							0 986 474 185	→ 43	F 026 A06 121 <sup>7</sup>
			245				0 986 472 830	← 38	1 987 470 040 <sup>7</sup>
							0 986 474 830		1 987 474 496 <sup>8</sup>
							0 986 472 831	→ 38	1 987 470 040 <sup>7</sup>
							0 986 474 831		
<b>2.5 TDI quattro</b>	07.97-04.01	110					0 986 473 225	← 38,1	1 987 470 040 <sup>7</sup>
							0 986 473 225	← 38,1	1 987 474 496 <sup>8</sup>
							0 986 474 225	→ 38,1	1 987 470 040 <sup>7</sup>
	10.99-05.04	132					0 986 473 225	← 38,1	1 987 470 040 <sup>7</sup>
							0 986 473 225	← 38,1	1 987 474 496 <sup>8</sup>
							0 986 474 225	→ 38,1	1 987 470 040 <sup>7</sup>
<b>2.7 Biturbo</b>	02.99-05.01	169					0 986 472 830	← 38	1 987 470 040 <sup>7</sup>
							0 986 474 830		1 987 474 496 <sup>8</sup>
							0 986 472 831	→ 38	1 987 470 040 <sup>7</sup>
							0 986 474 831		
<b>2.7 Biturbo quattro</b>	10.97-05.01	169					0 986 473 225	← 38,1	1 987 470 040 <sup>7</sup>
							0 986 473 225	← 38,1	1 987 474 496 <sup>8</sup>
							0 986 474 225	→ 38,1	1 987 474 496 <sup>8</sup>
	06.01-05.04	184					0 986 473 185	← 43	F 026 A06 121 <sup>7</sup>
							0 986 473 185	← 43	1 987 474 496 <sup>8</sup>
							0 986 473 225	← 38,1	1 987 470 040 <sup>7</sup>
							0 986 473 225	← 38,1	1 987 474 496 <sup>8</sup>
							0 986 474 185	→ 43	F 026 A06 121 <sup>7</sup>
							0 986 474 225	→ 38,1	1 987 470 040 <sup>7</sup>
<b>2.8</b>	04.97-04.01	132/140/ 142					0 986 472 830	← 38	1 987 470 040 <sup>7</sup>
							0 986 474 830		1 987 474 496 <sup>8</sup>
							0 986 472 831	→ 38	1 987 470 040 <sup>7</sup>
							0 986 474 831		
<b>2.8 quattro</b>	04.97-05.01	132/140/ 142					0 986 473 225	← 38,1	1 987 470 040 <sup>7</sup>
							0 986 473 225	← 38,1	1 987 474 496 <sup>8</sup>
							0 986 474 225	→ 38,1	1 987 470 040 <sup>7</sup>
<b>3.0</b>	06.01-05.04	160					0 986 473 185	← 43	F 026 A06 121 <sup>7</sup>
							0 986 473 185	← 43	1 987 474 496 <sup>8</sup>
							0 986 474 185	→ 43	F 026 A06 121 <sup>7</sup>
			245				0 986 472 830	← 38	1 987 470 040 <sup>7</sup>
							0 986 474 830		1 987 474 496 <sup>8</sup>
							0 986 472 831	→ 38	1 987 470 040 <sup>7</sup>
							0 986 474 831		
		162					0 986 473 185	← 43	1 987 474 496 <sup>8</sup>
							0 986 474 185	→ 43	1 987 474 496 <sup>8</sup>
			245				0 986 472 830	← 38	1 987 470 040 <sup>7</sup>
							0 986 474 830		1 987 474 496 <sup>8</sup>
							0 986 472 831	→ 38	1 987 470 040 <sup>7</sup>
							0 986 474 831		
<b>3.0, quattro</b>	06.01-05.04	162					0 986 474 185	→ 43	F 026 A06 121 <sup>7</sup>
<b>3.0 quattro</b>	06.01-05.04	160					0 986 473 225	← 38,1	1 987 470 040 <sup>7</sup>
							0 986 473 225	← 38,1	1 987 474 496 <sup>8</sup>
							0 986 474 225	→ 38,1	1 987 470 040 <sup>7</sup>
		162					0 986 473 185	← 43	F 026 A06 121 <sup>7</sup>
							0 986 473 185	← 43	1 987 474 496 <sup>8</sup>
	06.01-08.04	162					0 986 473 225	← 38,1	1 987 470 040 <sup>7</sup>
							0 986 473 225	← 38,1	1 987 474 496 <sup>8</sup>
							0 986 474 225	→ 38,1	1 987 470 040 <sup>7</sup>
	<b>1.8</b>	05.97-04.01	85/92				1 987 477 603	← 1958	
							1 987 477 604	→ 1958	
	<b>1.8 T</b>	04.97-05.04	110/132				1 987 477 603	← 1958	
							1 987 477 604	→ 1958	
	<b>1.8 T quattro</b>	04.97-05.04	110/132				1 987 477 959	↔ 1925	



◀ AUDI A6 [4B2; C5]										
1.9 TDI	04.97-04.01	81/85				1987 477 603	←	1958		
						1987 477 604	→	1958		
	06.01-05.04	96				1987 477 603	←	1958		
						1987 477 604	→	1958		
2.0	06.01-05.04	96				1987 477 603	←	1958		
						1987 477 604	→	1958		
2.4	04.97-05.00	120				1987 477 603	←	1958		
						1987 477 604	→	1958		
	04.97-04.01	121				1987 477 603	←	1958		
						1987 477 604	→	1958		
	08.97-05.00	100				1987 477 603	←	1958		
						1987 477 604	→	1958		
	04.98-04.01	115				1987 477 603	←	1958		
						1987 477 604	→	1958		
2.4 quattro	06.01-05.04	100				1987 477 603	←	1958		
						1987 477 604	→	1958		
		120				1987 477 603	←	1958		
						1987 477 604	→	1958		
		125				1987 477 603	←	1958		
						1987 477 604	→	1958		
	04.97-09.01	121				1987 477 959	↔	1925		
	06.97-05.00	120				1987 477 959	↔	1925		
2.5 TDI	08.98-07.99	115				1987 477 959	↔	1925		
	06.01-05.04	125				1987 477 959	↔	1925		
	04.97-04.01	110				1987 477 603	←	1958		
2.5 TDI quattro						1987 477 604	→	1958		
	10.99-05.04	132				1987 477 603	←	1958		
						1987 477 604	→	1958		
	06.01-05.04	114/120				1987 477 603	←	1958		
2.5 TDI quattro						1987 477 604	→	1958		
	07.97-04.01	110				1987 477 959	↔	1925		
2.7 Biturbo	10.99-05.04	132				1987 477 959	↔	1925		
	02.99-05.01	169				1987 477 603	←	1958		
2.7 Biturbo quattro						1987 477 604	→	1958		
	10.97-05.01	169				1987 477 959	↔	1925		
	06.01-05.04	184				1987 477 959	↔	1925		
2.8	04.97-04.01	132/140/ 142				1987 477 603	←	1958		
						1987 477 604	→	1958		
2.8 quattro	04.97-05.01	132/140/142				1987 477 959	↔	1925		
3.0	06.01-05.04	160/162				1987 477 603	←	1958		
						1987 477 604	→	1958		
3.0 quattro	06.01-08.04	160/162				1987 477 959	↔	1925		
1.8	05.97-12.98	85	Fg.-Nr. →4B..X..060 000			0986 594 006 <sup>3</sup>				
	12.97-12.98	92	Fg.-Nr. →4B..X..060 000			0986 594 006 <sup>3</sup>				
	12.98-07.99	92	Fg.-Nr. 4B..X..060 001→			0986 594 007 <sup>3</sup>				
	12.98-05.00	85	Fg.-Nr. 4B..X..060 001→			0986 594 007 <sup>3</sup>				
	01.99-04.01	92				0986 594 007 <sup>3</sup>				
1.8 T	04.97-01.99	110				0986 594 006 <sup>3</sup>				
	11.97-10.00	132				0986 594 006 <sup>3</sup>				
	12.98-04.01	110	Fg.-Nr. 4B..X..060 001→			0986 594 007 <sup>3</sup>				
	01.99-05.04	110				0986 594 007 <sup>3</sup>				
1.8 T quattro	04.97-12.98	110	Fg.-Nr. →4B..X..060 000			0986 594 006 <sup>3</sup>				
	06.97-12.98	132	Fg.-Nr. →4B..X..060 000			0986 594 006 <sup>3</sup>				
	12.98-10.00	132		Fg.-Nr. 4B..X..060 001→			0986 594 007 <sup>3</sup>			
				Fg.-Nr. 4B..X..062 732→	ALR,LAB	0265 006 584 <sup>4</sup>				
					ALR,RAB	0265 006 584 <sup>4</sup>				
				ALR	0265 006 584 <sup>4</sup>					
	12.98-05.01	110	Fg.-Nr. 4B..X..060 001→			0986 594 007 <sup>3</sup>				
				Fg.-Nr. 4B..X..062 732→	ALR,LAB	0265 006 584 <sup>4</sup>				
				ALR,RAB	0265 006 584 <sup>4</sup>					
				ALR	0265 006 584 <sup>4</sup>					



										
1.8 T quattro	01.99-09.00	110					0 986 594 007 <sup>3</sup>			
						ALR,LAB	0 265 006 586 <sup>4</sup>			
						ALR,RAB	0 265 006 584 <sup>4</sup>			
						ALR	0 265 006 584 <sup>4</sup>			
	05.00-08.01	110	Fg.-Nr. →4B..2..031 500				0 986 594 007 <sup>3</sup>			
	05.00-12.01	110	Fg.-Nr. →4B..2..079 500			ALR,LAB	0 265 006 586 <sup>4</sup>			
						ALR,RAB	0 265 006 584 <sup>4</sup>			
						ALR	0 265 006 584 <sup>4</sup>			
	09.01-06.02	110	Fg.-Nr. 4B..2..031 501→ 4B..2..200 000				0 265 006 578 <sup>3</sup>			
	12.01-05.04	110	Fg.-Nr. 4B..2..079 501→			ALR,LAB	0 265 006 763 <sup>4</sup>			
					ALR,RAB	0 265 006 761 <sup>4</sup>				
					ALR	0 265 006 761 <sup>4</sup>				
	07.02-05.04	110	Fg.-Nr. 4B..3..000 001→				0 265 006 765 <sup>3</sup>			
1.9 TDI	04.97-12.98	81	Fg.-Nr. →4B..X..060 000				0 986 594 006 <sup>3</sup>			
	12.98-08.99	81	Fg.-Nr. 4B..X..060 001→				0 986 594 007 <sup>3</sup>			
	05.99-04.01	85					0 986 594 007 <sup>3</sup>			
	08.99-10.00	81					0 986 594 007 <sup>3</sup>			
	06.01-08.01	96	Fg.-Nr. →4B..2..031 500				0 986 594 007 <sup>3</sup>			
	09.01-06.02	96	Fg.-Nr. 4B..2..031 501→4B..2..200 000				0 265 006 578 <sup>3</sup>			
	07.02-05.04	96	Fg.-Nr. 4B..3..000 001→				0 265 006 765 <sup>3</sup>			
	2.0	06.01-08.01	96	Fg.-Nr. →4B..2..031 500				0 986 594 007 <sup>3</sup>		
		09.01-06.02	96	Fg.-Nr. 4B..2..031 501→4B..2..200 000				0 265 006 578 <sup>3</sup>		
		07.02-05.04	96	Fg.-Nr. 4B..3..000 001→				0 265 006 765 <sup>3</sup>		
2.4	04.97-07.98	120					0 986 594 006 <sup>3</sup>			
	06.97-12.98	120	Fg.-Nr. →4B..X..060 000				0 986 594 006 <sup>3</sup>			
	08.97-12.98	100	Fg.-Nr. →4B..X..060 000				0 986 594 006 <sup>3</sup>			
	12.98-01.99	100	Fg.-Nr. 4B..X..060 001→				0 986 594 007 <sup>3</sup>			
	12.98-05.00	120	Fg.-Nr. 4B..X..060 001→				0 986 594 007 <sup>3</sup>			
	02.99-05.00	100					0 986 594 007 <sup>3</sup>			
	06.01-08.01	100	Fg.-Nr. →4B..2..031 500				0 986 594 007 <sup>3</sup>			
		120	Fg.-Nr. →4B..2..031 500				0 986 594 007 <sup>3</sup>			
	09.01-06.02	100	Fg.-Nr. 4B..2..031 501→4B..2..200 000				0 265 006 578 <sup>3</sup>			
		120	Fg.-Nr. 4B..2..031 501→4B..2..200 000				0 265 006 578 <sup>3</sup>			
		125	Fg.-Nr. 4B..2..031 501→4B..2..200 000				0 265 006 578 <sup>3</sup>			
	07.02-05.04	100	Fg.-Nr. 4B..3..000 001→				0 265 006 765 <sup>3</sup>			
		120	Fg.-Nr. 4B..3..000 001→				0 265 006 765 <sup>3</sup>			
	2.4	04.97-12.98	121	Fg.-Nr. →4B..X..060 000				0 986 594 006 <sup>3</sup>		
	2.4 quattro	04.98-12.98	115	Fg.-Nr. →4B..X..060 000				0 986 594 006 <sup>3</sup>		
		12.98-04.01	115	Fg.-Nr. 4B..X..060 001→				0 986 594 007 <sup>3</sup>		
12.98-09.01		121	Fg.-Nr. 4B..X..060 001→				0 986 594 007 <sup>3</sup>			
06.00-05.01		121					0 986 594 007 <sup>3</sup>			
06.01-08.01		125	Fg.-Nr. →4B..2..031 500				0 986 594 007 <sup>3</sup>			
07.02-05.04		125	Fg.-Nr. 4B..3..000 001→				0 265 006 765 <sup>3</sup>			
2.4 quattro		06.97-12.98	120	Fg.-Nr. →4B..X..060 000				0 986 594 006 <sup>3</sup>		
		12.98-07.99	115	Fg.-Nr. 4B..X..062 732→			ALR,LAB	0 265 006 586 <sup>4</sup>		
							ALR,RAB	0 265 006 584 <sup>4</sup>		
							ALR	0 265 006 584 <sup>4</sup>		
	12.98-05.00	120	Fg.-Nr. 4B..X..060 001→				0 986 594 007 <sup>3</sup>			
			Fg.-Nr. 4B..X..062 732→			ALR,LAB	0 265 006 586 <sup>4</sup>			
						ALR,RAB	0 265 006 584 <sup>4</sup>			
						ALR	0 265 006 584 <sup>4</sup>			
	12.98-09.01	121	Fg.-Nr. 4B..X..062 732→			ALR,LAB	0 265 006 586 <sup>4</sup>			
						ALR,RAB	0 265 006 584 <sup>4</sup>			
					ALR	0 265 006 584 <sup>4</sup>				
06.00-05.01	121				ALR,LAB	0 265 006 586 <sup>4</sup>				
					ALR,RAB	0 265 006 584 <sup>4</sup>				
					ALR	0 265 006 584 <sup>4</sup>				
06.01-12.01	125	Fg.-Nr. →4B..2..079 500			ALR,LAB	0 265 006 586 <sup>4</sup>				
					ALR,RAB	0 265 006 584 <sup>4</sup>				
					ALR	0 265 006 584 <sup>4</sup>				
09.01-06.02	125	Fg.-Nr. 4B..2..031 501→ 4B..2..200 000				0 265 006 578 <sup>3</sup>				



		S								
◀ AUDI A6 [4B2; C5]										
2.4 quattro	12.01-05.04	125	Fg.-Nr. 4B..2..079 501→	ALR,LAB	0 265 006 763 <sup>4</sup>					
				ALR,RAB	0 265 006 761 <sup>4</sup>					
				ALR	0 265 006 761 <sup>4</sup>					
2.5 TDI	06.01-08.01	114	Fg.-Nr. →4B..2..031 500		0 986 594 007 <sup>3</sup>					
	09.01-06.02	114	Fg.-Nr. 4B..2..031 501→		0 265 006 578 <sup>3</sup>					
		132	Fg.-Nr. 4B..2..031 501→ 4B..2..200 000		0 265 006 578 <sup>3</sup>					
	07.02-05.04	120			0 265 006 765 <sup>3</sup>					
2.5 TDI quattro	12.98-04.01	110	Fg.-Nr. 4B..X..062 732→	ALR,LAB	0 265 006 586 <sup>4</sup>					
				ALR,RAB	0 265 006 584 <sup>4</sup>					
				ALR	0 265 006 584 <sup>4</sup>					
	10.99-12.01	132	Fg.-Nr. →4B..2..079 500	ALR,LAB	0 265 006 586 <sup>4</sup>					
				ALR,RAB	0 265 006 584 <sup>4</sup>					
				ALR	0 265 006 584 <sup>4</sup>					
	09.01-06.02	132	Fg.-Nr. 4B..2..031 501→ 4B..2..200 000		0 265 006 578 <sup>3</sup>					
	12.01-08.03	132	Fg.-Nr. 4B..2..079 501→	ALR,LAB	0 265 006 763 <sup>4</sup>					
				ALR,RAB	0 265 006 761 <sup>4</sup>					
				ALR	0 265 006 761 <sup>4</sup>					
				ALR,LAB	0 265 006 763 <sup>4</sup>					
ALR,RAB	0 265 006 761 <sup>4</sup>									
ALR	0 265 006 761 <sup>4</sup>									
02.03-05.04	132			0 265 006 763 <sup>4</sup>						
ALR,RAB	0 265 006 761 <sup>4</sup>									
ALR	0 265 006 761 <sup>4</sup>									
2.5 TDI	04.97-12.98	110	Fg.-Nr. →4B..X..060 000		0 986 594 006 <sup>3</sup>					
2.5 TDI quattro	12.98-04.01	110	Fg.-Nr. 4B..X..060 001→		0 986 594 007 <sup>3</sup>					
	10.99-08.01	132	Fg.-Nr. →4B..2..031 500		0 986 594 007 <sup>3</sup>					
	07.02-08.03	132	Fg.-Nr. 4B..3..000 001→		0 265 006 765 <sup>3</sup>					
	11.02-05.04	132			0 265 006 765 <sup>3</sup>					
	02.99-05.01	169			0 986 594 007 <sup>3</sup>					
2.7 Biturbo	10.97-12.98	169	Fg.-Nr. →4B..X..060 000		0 986 594 006 <sup>3</sup>					
2.7 Biturbo quattro	12.98-08.00	169	Fg.-Nr. 4B..X..060 001→ Fg.-Nr. 4B..X..062 732→	ALR,LAB	0 265 006 586 <sup>4</sup>					
				ALR,RAB	0 265 006 584 <sup>4</sup>					
				ALR	0 265 006 584 <sup>4</sup>					
	09.00-05.01	169			0 986 594 007 <sup>3</sup>					
	ALR,LAB	0 265 006 586 <sup>4</sup>								
	ALR,RAB	0 265 006 584 <sup>4</sup>								
	ALR	0 265 006 584 <sup>4</sup>								
	06.01-08.01	184	Fg.-Nr. →4B..2..031 500		0 986 594 007 <sup>3</sup>					
	06.01-12.01	184	Fg.-Nr. →4B..2..079 500	ALR,LAB	0 265 006 586 <sup>4</sup>					
				ALR,RAB	0 265 006 584 <sup>4</sup>					
				ALR	0 265 006 584 <sup>4</sup>					
	09.01-06.02	184	Fg.-Nr. 4B..2..031 501→		0 265 006 578 <sup>3</sup>					
	12.01-06.02	184	Fg.-Nr. 4B..2..079 501→	ALR,LAB	0 265 006 763 <sup>4</sup>					
				ALR,RAB	0 265 006 761 <sup>4</sup>					
				ALR	0 265 006 761 <sup>4</sup>					
				ALR,LAB	0 265 006 763 <sup>4</sup>					
	ALR,RAB	0 265 006 761 <sup>4</sup>								
ALR	0 265 006 761 <sup>4</sup>									
07.02-05.04	184			0 265 006 765 <sup>3</sup>						
ALR,LAB	0 265 006 763 <sup>4</sup>									
ALR,RAB	0 265 006 761 <sup>4</sup>									
ALR	0 265 006 761 <sup>4</sup>									
2.8	04.97-12.98	142			0 986 594 006 <sup>3</sup>					
2.8 quattro	10.97-12.98	132	Fg.-Nr. →4B..X..060 000		0 986 594 006 <sup>3</sup>					
	12.98-05.00	132	Fg.-Nr. 4B..X..060 001→		0 986 594 007 <sup>3</sup>					
	12.98-05.01	142	Fg.-Nr. 4B..X..060 001→		0 986 594 007 <sup>3</sup>					
	01.99-05.01	142			0 986 594 007 <sup>3</sup>					
	07.99-05.01	140			0 986 594 007 <sup>3</sup>					
	12.98-05.00	132	Fg.-Nr. 4B..X..062 732→		0 265 006 586 <sup>4</sup>					
2.8 quattro	12.98-05.01	142	Fg.-Nr. 4B..X..062 732→	ALR,LAB	0 265 006 584 <sup>4</sup>					
				ALR,RAB	0 265 006 584 <sup>4</sup>					
				ALR	0 265 006 584 <sup>4</sup>					
	12.98-05.01	142	Fg.-Nr. 4B..X..062 732→	ALR,LAB	0 265 006 586 <sup>4</sup>					
				ALR,RAB	0 265 006 584 <sup>4</sup>					
ALR	0 265 006 584 <sup>4</sup>									











































	S							
2.8 quattro	01.99-05.01	142				ALR,LAB	0 265 006 586 <sup>4</sup>	
						ALR,RAB	0 265 006 584 <sup>4</sup>	
						ALR	0 265 006 584 <sup>4</sup>	
	07.99-05.01	140				ALR,LAB	0 265 006 586 <sup>4</sup>	
						ALR,RAB	0 265 006 584 <sup>4</sup>	
						ALR	0 265 006 584 <sup>4</sup>	
3.0	06.01-08.01	162		Fg.-Nr. →4B..2..031 500		0 986 594 007 <sup>3</sup>		
	09.01-06.02	160		Fg.-Nr. 4B..2..031 501→ 4B..2..200 000		0 265 006 578 <sup>3</sup>		
		162		Fg.-Nr. 4B..2..031 501→ 4B..2..200 000		0 265 006 578 <sup>3</sup>		
3.0 3.0 quattro	06.01-08.01	160		Fg.-Nr. →4B..2..031 500		0 986 594 007 <sup>3</sup>		
	07.02-05.04	160		Fg.-Nr. 4B..3..000 001→		0 265 006 765 <sup>3</sup>		
		162		Fg.-Nr. 4B..3..000 001→		0 265 006 765 <sup>3</sup>		
3.0 quattro	06.01-08.01	162		Fg.-Nr. →4B..2..031 500		0 986 594 007 <sup>3</sup>		
	06.01-12.01	160		Fg.-Nr. →4B..2..079 500	ALR,LAB	0 265 006 586 <sup>4</sup>		
					ALR,RAB	0 265 006 584 <sup>4</sup>		
					ALR	0 265 006 584 <sup>4</sup>		
	09.01-06.02	160		Fg.-Nr. →4B..2..079 500	ALR,LAB	0 265 006 586 <sup>4</sup>		
					ALR,RAB	0 265 006 584 <sup>4</sup>		
					ALR	0 265 006 584 <sup>4</sup>		
	09.01-06.02	160		Fg.-Nr. 4B..2..031 501→ 4B..2..200 000		0 265 006 578 <sup>3</sup>		
					162		Fg.-Nr. →4B..2..031 500	B17,B18
		165		0 986 594 007 <sup>3</sup>				
	12.01-05.04	160		Fg.-Nr. 4B..2..031 501→ 4B..2..200 000		0 265 006 578 <sup>3</sup>		
					12.01-05.04	160		Fg.-Nr. 4B..2..079 501→
		ALR,RAB	0 265 006 761 <sup>4</sup>					
					ALR	0 265 006 761 <sup>4</sup>		
12.01-08.04	162		Fg.-Nr. 4B..2..079 501→	ALR,LAB	0 265 006 763 <sup>4</sup>			
				ALR,RAB	0 265 006 761 <sup>4</sup>			
				ALR	0 265 006 761 <sup>4</sup>			
12.01-08.04	162		Fg.-Nr. 4B..2..079 501→	ALR,LAB	0 265 006 763 <sup>4</sup>			
				ALR,RAB	0 265 006 761 <sup>4</sup>			
				ALR	0 265 006 761 <sup>4</sup>			

**A6 [4B4; C5]**

	4.2 quattro	04.99-05.04	220		312	0 986 473 070		← 56,93	1 987 470 005 <sup>7</sup>		
						0 986 473 070		← 56,93	1 987 470 506 <sup>8</sup>		
						0 986 474 070		→ 56,93	1 987 470 005 <sup>7</sup>		
						321,FSB	0 986 134 078		← 60	1 987 470 506 <sup>8</sup>	
							0 986 135 078		→ 60	1 987 470 506 <sup>8</sup>	
						321,SSB	0 986 134 074		← 43	1 987 470 506 <sup>8</sup>	
	06.01-07.04	220				321	0 986 135 074		→ 43	1 987 470 506 <sup>8</sup>	
							0 986 134 078		← 60	1 987 470 506 <sup>8</sup>	
							0 986 135 078		→ 60	1 987 470 506 <sup>8</sup>	
								0 986 134 074		← 43	
								0 986 135 074		→ 43	
	4.2 quattro	04.99-07.04	220			0 986 473 185		← 43	F 026 A06 121 <sup>7</sup>		
						0 986 473 185		← 43	1 987 474 496 <sup>8</sup>		
						0 986 474 185		→ 43	F 026 A06 121 <sup>7</sup>		
	4.2 quattro	04.99-07.04	220			1 987 477 959		↔ 1925			
	4.2 quattro	04.99-05.01	220				0 265 006 578 <sup>3</sup>				
						LAB	0 265 006 567 <sup>4</sup>				
						RAB	0 265 006 565 <sup>4</sup>				



											
<b>AUDI A6 [4B4; C5]</b>											
		4.2 quattro	06.00-12.01	220	Fg.-Nr. →4B..2..079 500	LAB	0 265 006 567 <sup>4</sup>				
						RAB	0 265 006 565 <sup>4</sup>				
			06.00-06.02	220	Fg.-Nr. →4B..2..200 000		0 265 006 578 <sup>3</sup>				
			06.01-08.01	220	Fg.-Nr. →4B..2..031 500		0 265 006 578 <sup>3</sup>				
			12.01-07.04	220	Fg.-Nr. 4B..2..079 501→	LAB	0 265 006 769 <sup>4</sup>				
			01.02-07.04	220	Fg.-Nr. 4B..2..079 501→	RAB	0 265 006 767 <sup>4</sup>				
		07.02-07.04	220	Fg.-Nr. 4B..3..000 001→		0 265 006 765 <sup>3</sup>					
<b>A6 [4F2, C6]</b>											
											
		2.8 FSI quattro	11.06-10.08	154	PR-Code 1LG, PR-Code 1LD	321	0 986 473 229	 ← 60			
							0 986 474 229	 → 60			
					PR-Code 1LT	S31				1 987 470 005 <sup>7</sup>	
							0 986 473 070	 ← 56,93	1 987 470 506 <sup>8</sup>		
							0 986 474 070	 → 56,93	1 987 470 506 <sup>8</sup>		
				PR-Code 1LT, PR-Code 1LG, PR-Code 1LD, PR-Code 1ZL, PR-Code 1LH	321,347, S31			1 987 470 506 <sup>8</sup>			
											
		2.8 FSI quattro	11.06-10.08	154		LAB	0 265 007 930 <sup>3</sup>				
						RAB	0 265 007 930 <sup>4</sup>				
							0 265 007 928 <sup>3</sup>				
							0 265 007 928 <sup>4</sup>				
<b>A6 [4F2; C6]</b>											
											
		2.0 TDI 2.0 TDI e 2.0 TFSI	07.04-08.11	89/100/ 103/120/ 125	PR-Code 1LG, PR-Code 1LD	321	0 986 473 229	 ← 60			
							0 986 474 229	 → 60			
					PR-Code 1LT	S31				1 987 470 005 <sup>7</sup>	
							0 986 473 070	 ← 56,93	1 987 470 506 <sup>8</sup>		
							0 986 474 070	 → 56,93	1 987 470 506 <sup>8</sup>		
							PR-Code 1LT, PR-Code 1LG, PR-Code 1LD, PR-Code 1ZL, PR-Code 1LH	321,347, S31		1 987 470 506 <sup>8</sup>	
					2.4 2.4 quattro	04.04-10.08	130	PR-Code 1LG, PR-Code 1LD	321	0 986 473 229	 ← 60
									0 986 474 229	 → 60	
							PR-Code 1LT	S31			1 987 470 005 <sup>7</sup>
									0 986 473 070	 ← 56,93	1 987 470 506 <sup>8</sup>
									0 986 474 070	 → 56,93	1 987 470 506 <sup>8</sup>
							PR-Code 1LT, PR-Code 1LG, PR-Code 1LD, PR-Code 1ZL, PR-Code 1LH	321,347, S31		1 987 470 506 <sup>8</sup>	
		2.7 TDI 2.7 TDI quattro	11.04-08.11	120/132/ 140	PR-Code 1LG, PR-Code 1LD	321	0 986 473 229	 ← 60			
						0 986 474 229	 → 60				
				PR-Code 1LT	S31			1 987 470 005 <sup>7</sup>			
						0 986 473 070	 ← 56,93	1 987 470 506 <sup>8</sup>			
						0 986 474 070	 → 56,93	1 987 470 506 <sup>8</sup>			
				PR-Code 1LT, PR-Code 1LG, PR-Code 1LD, PR-Code 1ZL, PR-Code 1LH	321,347, S31		1 987 470 506 <sup>8</sup>				
		2.8 FSI 2.8 FSI quattro	11.06-08.11	140/154/ 162	PR-Code 1LG, PR-Code 1LD	321	0 986 473 229	 ← 60			
						0 986 474 229	 → 60				
				PR-Code 1LT	S31			1 987 470 005 <sup>7</sup>			
						0 986 473 070	 ← 56,93	1 987 470 506 <sup>8</sup>			
						0 986 474 070	 → 56,93	1 987 470 506 <sup>8</sup>			
				PR-Code 1LT, PR-Code 1LG, PR-Code 1LD, PR-Code 1ZL, PR-Code 1LH	321,347, S31		1 987 470 506 <sup>8</sup>				

		S								
<b>3.0</b>		04.04-09.11	155/160/	PR-Code 1LG, PR-Code 1LD	321		0 986 473 229		← 60	
<b>3.0 quattro</b>			165/171/				0 986 474 229		→ 60	
<b>3.0 TDI quattro</b>			176/213/	PR-Code 1LT	S31					1 987 470 005 <sup>7</sup>
<b>3.0 TFSI quattro</b>			220				0 986 473 070		← 56,93	1 987 470 506 <sup>B</sup>
							0 986 474 070		→ 56,93	1 987 470 506 <sup>B</sup>
				PR-Code 1LT, PR-Code 1LG, PR-Code 1LD, PR-Code 1ZL, PR-Code 1LH	321,347, S31					1 987 470 506 <sup>B</sup>
<b>3.2 FSI</b>		04.04-08.11	183/188/	PR-Code 1LG, PR-Code 1LD	321		0 986 473 229		← 60	
<b>3.2 FSI quattro</b>			195				0 986 474 229		→ 60	
				PR-Code 1LT	S31					1 987 470 005 <sup>7</sup>
							0 986 473 070		← 56,93	1 987 470 506 <sup>B</sup>
							0 986 474 070		→ 56,93	1 987 470 506 <sup>B</sup>
				PR-Code 1LT, PR-Code 1LG, PR-Code 1LD, PR-Code 1ZL, PR-Code 1LH	321,347, S31					1 987 470 506 <sup>B</sup>
<b>4.2 FSI quattro, quattro</b>		04.04-08.11	246/257	PR-Code 1ZL, PR-Code 1LH	347					1 987 470 506 <sup>B</sup>
<hr/>										
<b>2.0 TDI</b>		07.04-06.08	89/100/		LAB		0 265 007 930 <sup>3</sup>			
			103/120/		RAB		0 265 007 930 <sup>4</sup>			
			125				0 265 007 928 <sup>3</sup>			
							0 265 007 928 <sup>4</sup>			
		10.08-08.11	89/100/		LAB		0 265 007 930 <sup>3</sup>			
			103/120/		RAB		0 265 007 930 <sup>4</sup>			
			125				0 265 007 928 <sup>3</sup>			
							0 265 007 928 <sup>4</sup>			
<b>2.0 TDI e</b>		10.08-03.11	89/100/		LAB		0 265 007 930 <sup>3</sup>			
			103/120/		RAB		0 265 007 930 <sup>4</sup>			
			125				0 265 007 928 <sup>3</sup>			
							0 265 007 928 <sup>4</sup>			
<b>2.0 TFSI</b>		06.05-08.11	89/100/		LAB		0 265 007 930 <sup>3</sup>			
			103/120/		RAB		0 265 007 930 <sup>4</sup>			
			125				0 265 007 928 <sup>3</sup>			
							0 265 007 928 <sup>4</sup>			
<b>2.4</b>		04.04-10.08	130		LAB		0 265 007 930 <sup>3</sup>			
					RAB		0 265 007 930 <sup>4</sup>			
							0 265 007 928 <sup>3</sup>			
							0 265 007 928 <sup>4</sup>			
<b>2.4 quattro</b>		01.05-10.08	130		LAB		0 265 007 930 <sup>3</sup>			
					RAB		0 265 007 930 <sup>4</sup>			
							0 265 007 928 <sup>3</sup>			
							0 265 007 928 <sup>4</sup>			
<b>2.7 TDI</b>		11.04-08.11	120/132/		LAB		0 265 007 930 <sup>3</sup>			
			140		RAB		0 265 007 930 <sup>4</sup>			
							0 265 007 928 <sup>3</sup>			
							0 265 007 928 <sup>4</sup>			
<b>2.7 TDI quattro</b>		06.05-08.11	120/132/		LAB		0 265 007 930 <sup>3</sup>			
			140		RAB		0 265 007 930 <sup>4</sup>			
							0 265 007 928 <sup>3</sup>			
							0 265 007 928 <sup>4</sup>			
<b>2.8 FSI</b>		11.06-08.11	140/154/		LAB		0 265 007 930 <sup>3</sup>			
			162		RAB		0 265 007 930 <sup>4</sup>			
							0 265 007 928 <sup>3</sup>			
							0 265 007 928 <sup>4</sup>			
<b>2.8 FSI quattro</b>		10.08-08.11	140/154/		LAB		0 265 007 930 <sup>3</sup>			
			162		RAB		0 265 007 930 <sup>4</sup>			
							0 265 007 928 <sup>3</sup>			
							0 265 007 928 <sup>4</sup>			





		S							
<b>◀ AUDI A6 [4F2; C6]</b>									
<b>3.0</b>	04.04-05.06	155/160/ 165/171/ 176/213/ 220	LAB	0 265 007 930 <sup>3</sup>					
				0 265 007 930 <sup>4</sup>					
			RAB	0 265 007 928 <sup>3</sup>					
			0 265 007 928 <sup>4</sup>						
<b>3.0 quattro</b>	04.04-05.06	155/160/ 165/171/ 176/213/ 220	LAB	0 265 007 930 <sup>3</sup>					
				0 265 007 930 <sup>4</sup>					
			RAB	0 265 007 928 <sup>3</sup>					
			0 265 007 928 <sup>4</sup>						
<b>3.0 TDI quattro</b>	04.04-08.11	155/160/ 165/171/ 176/213/ 220	LAB	0 265 007 930 <sup>3</sup>					
				0 265 007 930 <sup>4</sup>					
			RAB	0 265 007 928 <sup>3</sup>					
			0 265 007 928 <sup>4</sup>						
<b>3.0 TFSI quattro</b>	10.08-09.11	155/160/ 165/171/ 176/213/ 220	LAB	0 265 007 930 <sup>3</sup>					
				0 265 007 930 <sup>4</sup>					
			RAB	0 265 007 928 <sup>3</sup>					
			0 265 007 928 <sup>4</sup>						
<b>3.2 FSI</b>	04.04-08.11	183/188/ 195	LAB	0 265 007 930 <sup>3</sup>					
				0 265 007 930 <sup>4</sup>					
			RAB	0 265 007 928 <sup>3</sup>					
			0 265 007 928 <sup>4</sup>						
<b>3.2 FSI quattro</b>	04.04-10.08	183/188/ 195	LAB	0 265 007 930 <sup>3</sup>					
				0 265 007 930 <sup>4</sup>					
			RAB	0 265 007 928 <sup>3</sup>					
			0 265 007 928 <sup>4</sup>						
<b>4.2 FSI quattro</b>	06.06-08.11	246/257	LAB	0 265 007 930 <sup>3</sup>					
				0 265 007 930 <sup>4</sup>					
			RAB	0 265 007 928 <sup>3</sup>					
			0 265 007 928 <sup>4</sup>						
<b>4.2 quattro</b>	04.04-05.06	246/257	LAB	0 265 007 930 <sup>3</sup>					
				0 265 007 930 <sup>4</sup>					
			RAB	0 265 007 928 <sup>3</sup>					
			0 265 007 928 <sup>4</sup>						
<b>A6 [4G; C7]</b>									
<b>1.8 TFSI</b>	09.14→	140	LAB	0 265 007 928 <sup>4</sup>					
				0 265 007 930 <sup>3</sup>					
			RAB	0 265 007 928 <sup>3</sup>					
			0 265 007 930 <sup>4</sup>						
<b>2.0 TDI</b>	02.11→	100/110/ 120/130/ 132/140/ 155/165/185	LAB	0 265 007 928 <sup>4</sup>					
				0 265 007 930 <sup>3</sup>					
			RAB	0 265 007 928 <sup>3</sup>					
			0 265 007 930 <sup>4</sup>						
<b>2.0 TDI quattro</b>	04.15→	100/110/ 120/130/ 132/140/ 155/165/185	LAB	0 265 007 928 <sup>4</sup>					
				0 265 007 930 <sup>3</sup>					
			RAB	0 265 007 928 <sup>3</sup>					
			0 265 007 930 <sup>4</sup>						
<b>2.0 TFSI</b>	03.11→	100/110/ 120/130/ 132/140/ 155/165/185	LAB	0 265 007 928 <sup>4</sup>					
				0 265 007 930 <sup>3</sup>					
			RAB	0 265 007 928 <sup>3</sup>					
			0 265 007 930 <sup>4</sup>						
<b>2.0 TFSI Hybrid</b>	11.11-04.15	100/110/ 120/130/ 132/140/ 155/165/185	LAB	0 265 007 928 <sup>4</sup>					
				0 265 007 930 <sup>3</sup>					
			RAB	0 265 007 928 <sup>3</sup>					
			0 265 007 930 <sup>4</sup>						
<b>2.0 TFSI quattro</b>	05.12→	100/110/ 120/130/ 132/140/ 155/165/185	LAB	0 265 007 928 <sup>4</sup>					
				0 265 007 930 <sup>3</sup>					
			RAB	0 265 007 928 <sup>3</sup>					
			0 265 007 930 <sup>4</sup>						



2.8 FSI	11.10-04.15	150/162		LAB		0 265 007 928 <sup>4</sup>		
						0 265 007 930 <sup>3</sup>		
2.8 FSI quattro	11.10→	150/162		LAB		0 265 007 928 <sup>4</sup>		
						0 265 007 930 <sup>3</sup>		
3.0 TDI	11.10-07.15	150/155/160/176/ 180/200/220/228/ 230/235/245		LAB		0 265 007 928 <sup>4</sup>		
						0 265 007 930 <sup>3</sup>		
3.0 TDI quattro	11.10→	150/155/160/176/ 180/200/220/228/ 230/235/245		LAB		0 265 007 928 <sup>4</sup>		
						0 265 007 930 <sup>3</sup>		
3.0 TFSI quattro	11.10→	150/155/160/176/ 180/200/220/228/ 230/235/245		LAB		0 265 007 928 <sup>4</sup>		
						0 265 007 930 <sup>3</sup>		
						0 265 007 928 <sup>3</sup>		
						0 265 007 930 <sup>4</sup>		

**A7 Sportback [4G]**

2.0 TFSI	09.14→	185		LAB		0 265 007 928 <sup>4</sup>		
						0 265 007 930 <sup>3</sup>		
2.8 FSI	02.11→	150/162		LAB		0 265 007 928 <sup>4</sup>		
						0 265 007 930 <sup>3</sup>		
2.8 FSI quattro	10.10→	150/162		LAB		0 265 007 928 <sup>4</sup>		
						0 265 007 930 <sup>3</sup>		
3.0 TDI	11.10→	150/155/160/176/ 180/200/220/228/ 230/235/240/245		LAB		0 265 007 928 <sup>4</sup>		
						0 265 007 930 <sup>3</sup>		
3.0 TDI quattro	07.10→	150/155/160/176/ 180/200/220/228/ 230/235/240/245		LAB		0 265 007 928 <sup>4</sup>		
						0 265 007 930 <sup>3</sup>		
3.0 TFSI quattro	07.10→	150/155/160/176/ 180/200/220/228/ 230/235/240/245		LAB		0 265 007 928 <sup>4</sup>		
						0 265 007 930 <sup>3</sup>		
						0 265 007 928 <sup>3</sup>		
						0 265 007 930 <sup>4</sup>		

**A8 [4D2; D2]**

2.5 TDI	10.98-09.02	110	Fg.-Nr. 4D..X..005 001→			0 986 134 074		← 43
						0 986 135 074		→ 43
2.5 TDI quattro	11.99-09.02	132				0 986 134 074		← 43
						0 986 135 074		→ 43
2.8	10.98-12.98	142	Fg.-Nr. 4D..X..005 001→			0 986 134 074		← 43
						0 986 135 074		→ 43
2.8 quattro	01.99-09.02	142				0 986 134 074		← 43
						0 986 135 074		→ 43
3.3 TDI quattro	12.99-08.02	165				0 986 134 074		← 43
						0 986 135 074		→ 43



		S							
	◀ AUDI A8 [4D2; D2]								
3.7	10.98-12.98	169	Fg.-Nr. 4D..X..005 001→	0986 134 074		← 43			
3.7 quattro	10.98-09.02	191		0986 135 074		→ 43			
	10.98-12.98	210/	Fg.-Nr. 4D..X..005 001→	0986 134 074		← 43			
		220-224		0986 135 074		→ 43			
4.2 quattro	10.98-09.02	228		0986 134 074		← 43			
				0986 135 074		→ 43			
	02.99-04.00	175		0986 134 074		← 43			
				0986 135 074		→ 43			
6.0 quattro	03.01-08.02	309		0986 134 074		← 43			
				0986 135 074		→ 43			
	2.5 TDI	06.97-12.98	110	Fg.-Nr. →4D..X..004 999	0986 473 698		← 38	1987 470 040 <sup>7</sup>	
		01.99-09.02	110	Fg.-Nr. 4D..X..005 001→	0986 474 698		→ 38	1987 470 040 <sup>7</sup>	
	2.5 TDI quattro	06.97-10.98	110	Fg.-Nr. →4D..X..004 999				1987 470 040 <sup>7</sup>	
		11.98-06.00	110	Fg.-Nr. 4D..X..005 001→				F 026 A06 121 <sup>7</sup>	
								1987 474 496 <sup>8</sup>	
	2.5 TDI	11.99-09.02	132					F 026 A06 121 <sup>7</sup>	
	2.5 TDI quattro							1987 474 496 <sup>8</sup>	
	2.8	06.94-03.96	120/128					1987 470 040 <sup>7</sup>	
		03.96-10.98	142	Fg.-Nr. →4D..X..004 999	0986 473 523		← 43	1987 470 040 <sup>7</sup>	
		11.98-12.98	142	Fg.-Nr. 4D..X..005 001→	0986 474 523		→ 43	1987 470 040 <sup>7</sup>	
		01.99-09.02	142					1987 474 496 <sup>8</sup>	
	2.8	11.98-12.98	142	Fg.-Nr. 4D..X..005 001→				F 026 A06 121 <sup>7</sup>	
	2.8 quattro	01.99-09.02	142					F 026 A06 121 <sup>7</sup>	
	2.8 quattro	09.94-03.96	120/128					1987 470 040 <sup>7</sup>	
								1987 470 040 <sup>7</sup>	
		03.96-10.98	142	Fg.-Nr. →4D..X..004 999	0986 473 523		← 43	F 026 A06 121 <sup>7</sup>	
		11.98-12.98	142	Fg.-Nr. 4D..X..005 001→	0986 474 523		→ 43	F 026 A06 121 <sup>7</sup>	
		01.99-04.99	142					1987 474 496 <sup>8</sup>	
		05.00-09.02	142					1987 474 496 <sup>8</sup>	
	3.3 TDI quattro	12.99-08.02	165					F 026 A06 121 <sup>7</sup>	
								1987 474 496 <sup>8</sup>	
	3.7	07.95-10.98	169	Fg.-Nr. →4D..X..004 999	0986 473 523		← 43	1987 470 040 <sup>7</sup>	
		11.98-12.98	169	Fg.-Nr. 4D..X..005 001→	0986 474 523		→ 43	1987 470 040 <sup>7</sup>	
		10.98-09.02	191					F 026 A06 121 <sup>7</sup>	
	3.7 quattro	11.98-12.98	169	Fg.-Nr. 4D..X..005 001→				1987 474 496 <sup>8</sup>	
		10.95-10.98	169	Fg.-Nr. →4D..X..004 999	0986 473 523		← 43	F 026 A06 121 <sup>7</sup>	
		11.98-12.98	169	Fg.-Nr. 4D..X..005 001→	0986 474 523		→ 43	F 026 A06 121 <sup>7</sup>	
		06.94-07.96	180					1987 474 496 <sup>8</sup>	
	4.2 quattro	06.94-10.98	210/	Fg.-Nr. →4D..X..004 999	0986 473 523		← 43	F 026 A06 121 <sup>7</sup>	
			220-224		0986 474 523		→ 43	F 026 A06 121 <sup>7</sup>	
		10.98-09.02	228					F 026 A06 121 <sup>7</sup>	
		11.98-12.98	210/	Fg.-Nr. 4D..X..005 001→				1987 474 496 <sup>8</sup>	
			220-224					F 026 A06 121 <sup>7</sup>	
		02.99-04.00	175					1987 474 496 <sup>8</sup>	
								F 026 A06 121 <sup>7</sup>	
	6.0 quattro	03.01-08.02	309					1987 474 496 <sup>8</sup>	
								F 026 A06 121 <sup>7</sup>	
								1987 474 496 <sup>8</sup>	















		06.97-10.98	110	Fg.-Nr. →4D..X..004 999	1 987 477 882	→ 1720	
	2.5 TDI	11.98-09.02	110	Fg.-Nr. 4D..X..005 001→	1 987 477 881	← 1657	
					1 987 477 882	→ 1720	
		05.00-09.02	132		1 987 477 882	→ 1720	
	2.5 TDI quattro	06.97-06.00	110		1 987 477 881	← 1657	
					1 987 477 882	→ 1720	
				FLR	1 987 482 126	← 1776	
		11.99-09.02	132		1 987 477 882	→ 1720	
				FLR	1 987 482 126	← 1776	
	2.5 TDI, TDI quattro	11.99-09.02	132		1 987 477 881	← 1657	
	2.8	03.96-10.98	142	Fg.-Nr. →4D..X..004 999	1 987 477 882	→ 1720	
		11.98-12.98	142	Fg.-Nr. 4D..X..005 001→	1 987 477 881	← 1657	
					1 987 477 882	→ 1720	
		01.99-09.02	142		1 987 477 881	← 1657	
					1 987 477 882	→ 1720	
	2.8 quattro	09.94-03.96	120/128		1 987 477 881	← 1657	
				1 987 477 882	→ 1720		
03.96-04.99		142		1 987 477 881	← 1657		
				1 987 477 882	→ 1720		
			FLR	1 987 482 126	← 1776		
	05.00-09.02	142		1 987 477 881	← 1657		
				1 987 477 882	→ 1720		
			FLR	1 987 482 126	← 1776		
3.3 TDI quattro	12.99-08.02	165		1 987 477 881	← 1657		
				1 987 477 882	→ 1720		
			FLR	1 987 482 126	← 1776		
3.7	07.95-10.98	169	Fg.-Nr. →4D..X..004 999	1 987 477 882	→ 1720		
	10.98-09.02	191		1 987 477 882	→ 1720		
	11.98-12.98	169	Fg.-Nr. 4D..X..005 001→	1 987 477 881	← 1657		
				1 987 477 882	→ 1720		
3.7, quattro	10.98-09.02	191		1 987 477 881	← 1657		
3.7 quattro	10.95-12.98	169		1 987 477 881	← 1657		
				1 987 477 882	→ 1720		
			FLR	1 987 482 126	← 1776		
	10.98-09.02	191		1 987 477 882	→ 1720		
			FLR	1 987 482 126	← 1776		
4.2 quattro	06.94-07.96	180		1 987 477 881	← 1657		
				1 987 477 882	→ 1720		
	06.94-09.02	210/ 220-224/ 228		1 987 477 881	← 1657		
			FLR	1 987 482 126	← 1776		
	02.99-04.00	175		1 987 477 881	← 1657		
				1 987 477 882	→ 1720		
			FLR	1 987 482 126	← 1776		
6.0 quattro	03.01-08.02	309		1 987 477 881	← 1657		
				1 987 477 882	→ 1720		
			FLR	1 987 482 126	← 1776		
	2.5 TDI	10.98-09.02	110	Fg.-Nr. 4D..X..005 001→	0 265 006 588 <sup>4</sup>		
				16R	0 265 006 580 <sup>3</sup>		
				20R	0 265 006 662 <sup>3</sup>		
		05.00-09.02	132		0 265 006 588 <sup>4</sup>		
				16R	0 265 006 580 <sup>3</sup>		
				20R	0 265 006 662 <sup>3</sup>		
	2.5 TDI quattro	06.97-06.00	110		FKR	0 265 006 588 <sup>4</sup>	
		10.98-06.00	110	Fg.-Nr. 4D..X..005 001→	16R,FKR	0 265 006 580 <sup>3</sup>	
					20R,FKR	0 265 006 662 <sup>3</sup>	
		11.99-09.02	132		FKR	0 265 006 588 <sup>4</sup>	
				16R,FKR	0 265 006 580 <sup>3</sup>		
				20R,FKR	0 265 006 662 <sup>3</sup>		



		S							
<b>AUDI A8 [4D2; D2]</b>									
<b>2.8</b>		10.98-12.98	142	Fg.-Nr. 4D..X..005 001→			0 265 006 588 <sup>4</sup>		
					16R	0 265 006 580 <sup>3</sup>			
							0 265 006 662 <sup>3</sup>		
		01.99-09.02	142				0 265 006 588 <sup>4</sup>		
							0 265 006 580 <sup>3</sup>		
							0 265 006 662 <sup>3</sup>		
<b>2.8 quattro</b>		03.96-04.99	142				0 265 006 588 <sup>4</sup>		
		10.98-12.98	142	Fg.-Nr. 4D..X..005 001→	16R,FKR	0 265 006 580 <sup>3</sup>			
							0 265 006 662 <sup>3</sup>		
		01.99-04.99	142				0 265 006 580 <sup>3</sup>		
							0 265 006 662 <sup>3</sup>		
		05.00-09.02	142				0 265 006 588 <sup>4</sup>		
							0 265 006 580 <sup>3</sup>		
							0 265 006 662 <sup>3</sup>		
<b>3.3 TDI quattro</b>		12.99-08.02	165				0 265 006 588 <sup>4</sup>		
							0 265 006 662 <sup>3</sup>		
<b>3.7</b>		10.98-12.98	169	Fg.-Nr. 4D..X..005 001→			0 265 006 588 <sup>4</sup>		
					16R	0 265 006 580 <sup>3</sup>			
							0 265 006 662 <sup>3</sup>		
		10.98-09.02	191				0 265 006 588 <sup>4</sup>		
							0 265 006 580 <sup>3</sup>		
							0 265 006 662 <sup>3</sup>		
<b>3.7 quattro</b>		10.95-12.98	169				0 265 006 588 <sup>4</sup>		
		10.98-12.98	169	Fg.-Nr. 4D..X..005 001→	16R,FKR	0 265 006 580 <sup>3</sup>			
							0 265 006 662 <sup>3</sup>		
		10.98-09.02	191				0 265 006 588 <sup>4</sup>		
							0 265 006 580 <sup>3</sup>		
							0 265 006 662 <sup>3</sup>		
<b>4.2 quattro</b>		06.94-12.98	210/220-224				0 265 006 588 <sup>4</sup>		
		10.98-12.98	210/ 220-224	Fg.-Nr. 4D..X..005 001→	16R,FKR	0 265 006 580 <sup>3</sup>			
							0 265 006 662 <sup>3</sup>		
		10.98-09.02	228				0 265 006 588 <sup>4</sup>		
							0 265 006 580 <sup>3</sup>		
							0 265 006 662 <sup>3</sup>		
		02.99-04.00	175				0 265 006 588 <sup>4</sup>		
							0 265 006 580 <sup>3</sup>		
							0 265 006 662 <sup>3</sup>		
<b>6.0 quattro</b>		03.01-08.02	309				0 265 006 588 <sup>4</sup>		
							0 265 006 662 <sup>3</sup>		
<b>A8 [4E; D3]</b>									
<b>2.8 FSI</b>		09.07-07.10	154/170	PR-Code 1LG	321		0 986 473 229		← 60
							0 986 474 229		→ 60
<b>3.0</b>		07.03-07.10	155/160/ 162/171	PR-Code 1LG	321				1 987 470 506 <sup>8</sup>
<b>3.0 quattro</b>									
<b>3.0 TDI quattro</b>		07.04-07.10	155/160/ 162/171	Fg.-Nr. 4E..5..003 251→, PR-Code 1LG	321		0 986 473 229		← 60
							0 986 474 229		→ 60
<b>3.2 FSI</b>		06.05-07.10	191	PR-Code 1LG	321		0 986 473 229		← 60
<b>3.2 FSI quattro</b>							0 986 474 229		→ 60
<b>3.7 quattro</b>		11.02-05.06	206	PR-Code 1LG	321				1 987 470 506 <sup>8</sup>
		07.04-05.06	206	Fg.-Nr. 4E..5..003 251→, PR-Code 1LG			0 986 473 229		← 60
							0 986 474 229		→ 60
<b>4.0 TDI quattro</b>		05.03-07.05	202	PR-Code 1LG	321				1 987 470 506 <sup>8</sup>
		07.04-07.05	202	Fg.-Nr. 4E..5..003 251→, PR-Code 1LG			0 986 473 229		← 60
							0 986 474 229		→ 60
<b>2.8 FSI</b>		09.07-07.10	154/170						1 987 474 496 <sup>8</sup>
							0 986 473 229		← 60
<b>3.0, quattro, TDI quattro</b>		07.03-07.10	155/160/ 162/171	PR-Code 1KE, PR-Code 1KW, PR-Code 1KY	228,B31, B33				1 987 474 496 <sup>8</sup>

								
3.2 FSI, FSI quattro	06.05-07.10	191						1 987 474 496 <sup>B</sup>
3.7 quattro	11.02-05.06	206	PR-Code 1KE, PR-Code 1KW, PR-Code 1KY	228,B31, B33				1 987 474 496 <sup>B</sup>
4.0 TDI quattro	05.03-07.05	202	PR-Code 1KE, PR-Code 1KW, PR-Code 1KY	228,B31, B33				1 987 474 496 <sup>B</sup>
4.2 FSI quattro	06.06-07.10	257	PR-Code 1KY					1 987 474 496 <sup>B</sup>
4.2 quattro	11.02-05.06	246	PR-Code 1KE, PR-Code 1KW, PR-Code 1KY	228,B31, B33				1 987 474 496 <sup>B</sup>
4.2 TDI quattro	01.05-06.05	235	PR-Code 1KY	B33				1 987 474 496 <sup>B</sup>
	07.05-07.10	240	PR-Code 1KY					1 987 474 496 <sup>B</sup>
								
 2.8 FSI	09.07-07.10	154/170		LAB		0 265 007 928 <sup>4</sup>		
				RAB		0 265 007 930 <sup>3</sup>		
						0 265 007 928 <sup>3</sup>		
						0 265 007 930 <sup>4</sup>		
3.0	07.03-05.06	155/160/ 162/171		LAB		0 265 007 928 <sup>4</sup>		
				RAB		0 265 007 928 <sup>3</sup>		
						0 265 007 930 <sup>3</sup>		
						0 265 007 930 <sup>4</sup>		
3.0 quattro	11.03-05.06	155/160/ 162/171		LAB		0 265 007 928 <sup>4</sup>		
				RAB		0 265 007 928 <sup>3</sup>		
						0 265 007 930 <sup>3</sup>		
						0 265 007 930 <sup>4</sup>		
3.0 TDI quattro	11.03-07.10	155/160/ 162/171		LAB		0 265 007 928 <sup>4</sup>		
				RAB		0 265 007 928 <sup>3</sup>		
						0 265 007 930 <sup>3</sup>		
						0 265 007 930 <sup>4</sup>		
3.2 FSI	06.05-07.10	191		LAB		0 265 007 928 <sup>4</sup>		
				RAB		0 265 007 930 <sup>3</sup>		
						0 265 007 928 <sup>3</sup>		
						0 265 007 930 <sup>4</sup>		
3.2 FSI quattro	06.05-07.10	191		LAB		0 265 007 928 <sup>4</sup>		
				RAB		0 265 007 928 <sup>3</sup>		
						0 265 007 930 <sup>3</sup>		
						0 265 007 930 <sup>4</sup>		
3.7 quattro	11.02-05.06	206		LAB		0 265 007 928 <sup>4</sup>		
				RAB		0 265 007 928 <sup>3</sup>		
						0 265 007 930 <sup>3</sup>		
						0 265 007 930 <sup>4</sup>		
4.0 TDI quattro	05.03-07.05	202		LAB		0 265 007 928 <sup>4</sup>		
				RAB		0 265 007 928 <sup>3</sup>		
						0 265 007 930 <sup>3</sup>		
						0 265 007 930 <sup>4</sup>		
4.2 FSI quattro	06.06-07.10	235/240/ 246/257		LAB		0 265 007 928 <sup>4</sup>		
				RAB		0 265 007 928 <sup>3</sup>		
						0 265 007 930 <sup>3</sup>		
						0 265 007 930 <sup>4</sup>		
4.2 quattro	11.02-05.06	235/240/ 246/257		LAB		0 265 007 928 <sup>4</sup>		
				RAB		0 265 007 928 <sup>3</sup>		
						0 265 007 930 <sup>3</sup>		
						0 265 007 930 <sup>4</sup>		
4.2 TDI quattro	01.05-07.10	235/240/ 246/257		LAB		0 265 007 928 <sup>4</sup>		
				RAB		0 265 007 928 <sup>3</sup>		
						0 265 007 930 <sup>3</sup>		
						0 265 007 930 <sup>4</sup>		
6.0 quattro	02.04-07.10	331		FMS,LAB		0 265 007 930		
				FMS,RAB		0 265 007 928		





◀ AUDI

**A8 [4H; D4]**



	2.0 TFSI Hybrid	02.12→	155	LAB	0 265 007 928 <sup>4</sup>		
					RAB	0 265 007 928 <sup>3</sup>	
	3.0 TDI quattro	07.10→	150/155/ 176/184/ 190/213/ 228/245	LAB	0 265 007 928 <sup>4</sup>		
					RAB	0 265 007 928 <sup>3</sup>	
	3.0 TFSI quattro	06.10→	150/155/ 176/184/ 190/213/ 228/245	LAB	0 265 007 928 <sup>4</sup>		
					RAB	0 265 007 928 <sup>3</sup>	
	4.0 FSI quattro	05.12→	309-320	LAB	0 265 007 928 <sup>4</sup>		
					RAB	0 265 007 928 <sup>3</sup>	
	4.2 FSI quattro	11.09-04.14	258/273/ 283	LAB	0 265 007 928 <sup>4</sup>		
					RAB	0 265 007 928 <sup>3</sup>	
	4.2 TDI quattro	11.09→	258/273/ 283	LAB	0 265 007 928 <sup>4</sup>		
					RAB	0 265 007 928 <sup>3</sup>	
	6.3 FSI quattro	01.11→	368	LAB	0 265 007 928 <sup>4</sup>		
					RAB	0 265 007 928 <sup>3</sup>	

**Cabriolet [8G7; B4]**



	1.8	01.97-08.00	92	ATE	0 986 473 151	← 53,93	1 987 470 506 <sup>8</sup>
					GIR	0 986 474 151	→ 53,93
	1.9 TDI	07.95-08.00	66	ATE	0 986 473 151	← 53,93	1 987 470 506 <sup>8</sup>
					GIR	0 986 474 151	→ 53,93
	2.0	01.93-09.98	85/103	ATE	0 986 473 151	← 53,93	1 987 470 506 <sup>8</sup>
					GIR	0 986 474 151	→ 53,93
	2.3	06.91-07.94	98	ATE	0 986 473 151	← 53,93	1 987 470 506 <sup>8</sup>
					GIR	0 986 474 151	→ 53,93
	2.6	01.94-08.00	102/110	ATE	0 986 473 151	← 53,93	1 987 470 506 <sup>8</sup>
					GIR	0 986 474 151	→ 53,93
	2.8	11.92-08.00	128				1 987 470 023 <sup>7</sup>



	1.8	01.97-08.00	92	245	0 986 473 695	← 38	1 987 470 040 <sup>7</sup>
						0 986 474 695	→ 38









		S							
1.9 TDI		07.95-08.00	66			245	0 986 473 695	← 38	1 987 470 040 <sup>7</sup>
							0 986 474 695	→ 38	1 987 470 040 <sup>7</sup>
2.0		01.93-09.98	85/103			245	0 986 473 695	← 38	1 987 470 040 <sup>7</sup>
							0 986 474 695	→ 38	1 987 470 040 <sup>7</sup>
2.3		06.91-07.94	98			245	0 986 473 695	← 38	1 987 470 040 <sup>7</sup>
							0 986 474 695	→ 38	1 987 470 040 <sup>7</sup>
2.6		01.94-08.00	102/110			245	0 986 473 695	← 38	1 987 470 040 <sup>7</sup>
							0 986 474 695	→ 38	1 987 470 040 <sup>7</sup>
2.8		11.92-08.00	128			245	0 986 473 695	← 38	1 987 470 040 <sup>7</sup>
							0 986 474 695	→ 38	1 987 470 040 <sup>7</sup>
	1.8	01.97-08.00	92				1 987 477 708	1422	
	1.9 TDI	07.95-08.00	66				1 987 477 708	1422	
	2.0	03.93-09.98	85	Fg.-Nr. 8G..P..005 534→			1 987 477 708	1422	
		05.95-07.96	103				1 987 477 708	1422	
	2.3	03.93-07.94	98	Fg.-Nr. 8G..P..005 534→			1 987 477 708	1422	
	2.6	01.94-08.00	102/110				1 987 477 708	1422	
	2.8	03.93-08.00	128	Fg.-Nr. 8G..P..005 534→			1 987 477 708	1422	
<b>Coupé S2 [89; B3]</b>									
	2.2 T quattro	10.92-12.95	169						1 987 470 023 <sup>7</sup>
<b>Coupé [89; B3]</b>									
	2.0	09.91-12.95	85/103			ATE	0 986 473 151	← 53,93	1 987 470 506 <sup>8</sup>
							0 986 474 151	→ 53,93	1 987 470 506 <sup>8</sup>
						GIR	0 986 474 712	← 54	1 987 470 287 <sup>7</sup>
							0 986 473 712	→ 54	1 987 470 287 <sup>7</sup>
	2.3	11.88-07.94	98			ATE	0 986 473 151	← 53,93	1 987 470 506 <sup>8</sup>
	2.3 quattro						0 986 474 151	→ 53,93	1 987 470 506 <sup>8</sup>
						GIR	0 986 474 712	← 54	1 987 470 287 <sup>7</sup>
							0 986 473 712	→ 54	1 987 470 287 <sup>7</sup>
	2.6	08.92-12.95	110			ATE	0 986 473 151	← 53,93	1 987 470 506 <sup>8</sup>
							0 986 474 151	→ 53,93	1 987 470 506 <sup>8</sup>
						LFS	0 986 474 712	← 54	1 987 470 287 <sup>7</sup>
							0 986 473 712	→ 54	1 987 470 287 <sup>7</sup>
	2.6 quattro	08.92-12.95	110						1 987 470 023 <sup>7</sup>
	2.8, quattro	08.91-12.95	128						1 987 470 023 <sup>7</sup>
	2.0	07.92-12.95	85	Fg.-Nr. 8B..P..005 367→			0 986 473 695	← 38	1 987 470 040 <sup>7</sup>
							0 986 474 695	→ 38	1 987 470 040 <sup>7</sup>
		08.92-12.95	103				0 986 473 695	← 38	1 987 470 040 <sup>7</sup>
							0 986 474 695	→ 38	1 987 470 040 <sup>7</sup>
	2.3	07.92-07.94	98	Fg.-Nr. 8B..P..005 367→			0 986 473 695	← 38	1 987 470 040 <sup>7</sup>
							0 986 474 695	→ 38	1 987 470 040 <sup>7</sup>
	2.3 quattro	11.88-07.94	98				0 986 473 698	← 38	1 987 470 040 <sup>7</sup>
							0 986 474 698	→ 38	1 987 470 040 <sup>7</sup>
	2.6	08.92-12.95	110				0 986 473 695	← 38	1 987 470 040 <sup>7</sup>
							0 986 474 695	→ 38	1 987 470 040 <sup>7</sup>
	2.6 quattro	08.92-12.95	110				0 986 473 698	← 38	1 987 470 040 <sup>7</sup>
							0 986 474 698	→ 38	1 987 470 040 <sup>7</sup>
	2.8	09.91-12.95	128				0 986 473 695	← 38	1 987 470 040 <sup>7</sup>
							0 986 474 695	→ 38	1 987 470 040 <sup>7</sup>
	2.8 quattro	08.91-12.95	128				0 986 473 698	← 38	1 987 470 040 <sup>7</sup>
							0 986 474 698	→ 38	1 987 470 040 <sup>7</sup>





◀ AUDI Coupé [89; B3]									
	2.0	07.92-12.95	85	Fg.-Nr. 8B..P..005 367→		1987	<b>477 708</b>	1422	
		08.92-12.95	103			1987	<b>477 708</b>	1422	
	2.3	07.92-07.94	98	Fg.-Nr. 8B..P..005 367→		1987	<b>477 708</b>	1422	
	2.6	08.92-12.95	110			1987	<b>477 708</b>	1422	
	2.8	07.92-12.95	128	Fg.-Nr. 8B..P..005 367→		1987	<b>477 708</b>	1422	
<b>Maxxum</b>									
	140	03.07-05.10	74	PR-Code 1LF		0986	<b>134 200</b>		
						0986	<b>135 200</b>		
	140	03.07-05.10	74		LLE	1987	<b>482 444</b>	1890	
					RLE	1987	<b>482 187</b>	1630	
	140	03.07-05.10	74		LAB	0986	<b>594 524</b> <sup>3</sup>		
						0986	<b>594 524</b> <sup>4</sup>		
					RAB	0986	<b>594 525</b> <sup>3</sup>		
						0986	<b>594 525</b> <sup>4</sup>		
<b>Q3 RS [8U]</b>									
	2.5 TFSI quattro	10.13→	228/250		LAB	0986	<b>594 504</b> <sup>3</sup>		
						0986	<b>594 504</b> <sup>4</sup>		
					RAB	0986	<b>594 505</b> <sup>3</sup>		
						0986	<b>594 505</b> <sup>4</sup>		
<b>Q3 [8U]</b>									
	1.4 TFSI	10.13→	110			0986	<b>134 323</b>		57
						0986	<b>135 323</b>		57
	2.0 TDI, TDI quattro, TFSI, TFSI quattro	06.11→	88/100/103/110/120/125/130/132/135/147/155/162			0986	<b>134 323</b>		57
						0986	<b>135 323</b>		57
	1.4 TFSI	10.13→	110		FPA,LAB	0986	<b>594 561</b> <sup>4</sup>		
					FPA,RAB	0986	<b>594 560</b> <sup>4</sup>		
					FPA,LAB	0986	<b>594 506</b> <sup>4</sup>		
					FPA,RAB	0986	<b>594 507</b> <sup>4</sup>		
					LAB	0986	<b>594 504</b> <sup>3</sup>		
					RAB	0986	<b>594 505</b> <sup>3</sup>		
	2.0 TDI	09.11→	100		FPA,LAB	0986	<b>594 561</b> <sup>4</sup>		
					FPA,RAB	0986	<b>594 560</b> <sup>4</sup>		
					FPA,LAB	0986	<b>594 506</b> <sup>4</sup>		
					FPA,RAB	0986	<b>594 507</b> <sup>4</sup>		
					LAB	0986	<b>594 504</b> <sup>3</sup>		
					RAB	0986	<b>594 505</b> <sup>3</sup>		
			103/110		FPA,LAB	0986	<b>594 561</b> <sup>4</sup>		
					FPA,RAB	0986	<b>594 560</b> <sup>4</sup>		
					FPA,LAB	0986	<b>594 506</b> <sup>4</sup>		
					FPA,RAB	0986	<b>594 507</b> <sup>4</sup>		
					LAB	0986	<b>594 504</b> <sup>3</sup>		
					RAB	0986	<b>594 505</b> <sup>3</sup>		



										
<b>2.0 TDI</b>	05.13→	130	FPA,LAB	0 986 594 561 <sup>4</sup>						
			FPA,RAB	0 986 594 560 <sup>4</sup>						
			FPA,LAB	0 986 594 506 <sup>4</sup>						
			FPA,RAB	0 986 594 507 <sup>4</sup>						
			LAB	0 986 594 504 <sup>3</sup>						
<b>2.0 TDI quattro</b>	06.11→	120/125	FPA,LAB	0 986 594 504 <sup>4</sup>						
			FPA,RAB	0 986 594 505 <sup>4</sup>						
			LAB	0 986 594 504 <sup>3</sup>						
			RAB	0 986 594 505 <sup>3</sup>						
	130	FPA,LAB	0 986 594 524 <sup>4</sup>							
		FPA,RAB	0 986 594 525 <sup>4</sup>							
		FPA,LAB	0 986 594 504 <sup>4</sup>							
		FPA,RAB	0 986 594 505 <sup>4</sup>							
		LAB	0 986 594 504 <sup>3</sup>							
	01.12→	103/110	FPA,LAB	0 986 594 524 <sup>4</sup>						
			FPA,RAB	0 986 594 525 <sup>4</sup>						
			FPA,LAB	0 986 594 504 <sup>4</sup>						
			FPA,RAB	0 986 594 505 <sup>4</sup>						
LAB			0 986 594 504 <sup>3</sup>							
11.14→	132/135	FPA,LAB	0 986 594 504 <sup>4</sup>							
		FPA,RAB	0 986 594 505 <sup>4</sup>							
		LAB	0 986 594 504 <sup>3</sup>							
02.15→	88	FPA,LAB	0 986 594 524 <sup>4</sup>							
		FPA,RAB	0 986 594 525 <sup>4</sup>							
		FPA,LAB	0 986 594 504 <sup>4</sup>							
		FPA,RAB	0 986 594 505 <sup>4</sup>							
		LAB	0 986 594 504 <sup>3</sup>							
<b>2.0 TDI quattro</b>	06.11→	120/125	FPA,LAB	0 986 594 524 <sup>4</sup>						
			FPA,RAB	0 986 594 525 <sup>4</sup>						
<b>2.0 TFSI quattro</b>	11.14→	132/135	FPA,LAB	0 986 594 524 <sup>4</sup>						
<b>2.0 TDI quattro, TFSI, TFSI quattro</b>	11.14→	132/135	FPA,RAB	0 986 594 525 <sup>4</sup>						
<b>2.0 TFSI</b>	03.15→	147	FPA,LAB	0 986 594 561 <sup>4</sup>						
			FPA,RAB	0 986 594 560 <sup>4</sup>						
			FPA,LAB	0 986 594 506 <sup>4</sup>						
			FPA,RAB	0 986 594 507 <sup>4</sup>						
			LAB	0 986 594 504 <sup>3</sup>						
	05.15→	132/135	FPA,LAB	0 986 594 504 <sup>4</sup>						
			FPA,RAB	0 986 594 505 <sup>4</sup>						
			LAB	0 986 594 504 <sup>3</sup>						
			RAB	0 986 594 505 <sup>3</sup>						
			FPA,LAB	0 986 594 524 <sup>4</sup>						
			FPA,RAB	0 986 594 525 <sup>4</sup>						
<b>2.0 TFSI quattro</b>	06.11→	120/125	FPA,LAB	0 986 594 504 <sup>4</sup>						
			FPA,RAB	0 986 594 505 <sup>4</sup>						
			LAB	0 986 594 504 <sup>3</sup>						
			RAB	0 986 594 505 <sup>3</sup>						
	155/162	FPA,LAB	0 986 594 524 <sup>4</sup>							
		FPA,RAB	0 986 594 525 <sup>4</sup>							
		FPA,LAB	0 986 594 504 <sup>4</sup>							
		FPA,RAB	0 986 594 505 <sup>4</sup>							
		LAB	0 986 594 504 <sup>3</sup>							
	11.14→	132/135	FPA,LAB	0 986 594 504 <sup>4</sup>						
			FPA,RAB	0 986 594 505 <sup>4</sup>						
			LAB	0 986 594 504 <sup>3</sup>						
			RAB	0 986 594 505 <sup>3</sup>						





	◀ AUDI Q3 [8U]							
	2.0 TFSI quattro	03.15→	147		FPA,LAB	0 986 594 524 <sup>4</sup>		
					FPA,RAB	0 986 594 525 <sup>4</sup>		
					FPA,LAB	0 986 594 504 <sup>4</sup>		
					FPA,RAB	0 986 594 505 <sup>4</sup>		
					LAB	0 986 594 504 <sup>3</sup>		
					RAB	0 986 594 505 <sup>3</sup>		

**Q5 [8RB]**

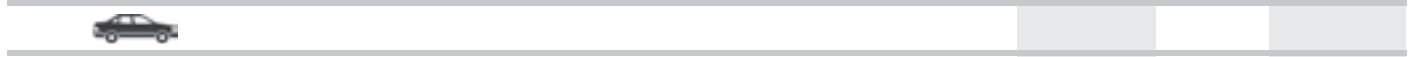

	2.0 TDI	11.10→	100/105/ 110		LAB	0 265 007 928 <sup>4</sup>		
						0 265 007 930 <sup>3</sup>		
					RAB	0 265 007 928 <sup>3</sup>		
						0 265 007 930 <sup>4</sup>		
	2.0 TDI quattro	11.08-09.12	120		LAB	0 265 007 928 <sup>4</sup>		
					RAB	0 265 007 930 <sup>4</sup>		
			125		LAB	0 265 007 928 <sup>4</sup>		
						0 265 007 930 <sup>3</sup>		
					RAB	0 265 007 928 <sup>3</sup>		
						0 265 007 930 <sup>4</sup>		
		11.08→	120		LAB	0 265 007 930 <sup>3</sup>		
					RAB	0 265 007 928 <sup>3</sup>		
		08.09→	100/105/ 110		LAB	0 265 007 928 <sup>4</sup>		
						0 265 007 930 <sup>3</sup>		
					RAB	0 265 007 928 <sup>3</sup>		
						0 265 007 930 <sup>4</sup>		
		06.12→	120		LAB	0 265 007 930 <sup>4</sup>		
					RAB	0 265 007 928 <sup>4</sup>		
			130		LAB	0 265 007 930 <sup>3</sup>		
						0 265 007 930 <sup>4</sup>		
					RAB	0 265 007 928 <sup>3</sup>		
						0 265 007 928 <sup>4</sup>		
		04.14→	120		LAB	0 265 007 928 <sup>4</sup>		
					RAB	0 265 007 928 <sup>3</sup>		
						0 265 007 930 <sup>4</sup>		
			140		LAB	0 265 007 928 <sup>4</sup>		
						0 265 007 930 <sup>3</sup>		
					RAB	0 265 007 928 <sup>3</sup>		
						0 265 007 930 <sup>4</sup>		
	2.0 TFSI Hybrid quattro	06.11→	155-180		LAB	0 265 007 928 <sup>4</sup>		
						0 265 007 930 <sup>3</sup>		
					RAB	0 265 007 928 <sup>3</sup>		
						0 265 007 930 <sup>4</sup>		
	2.0 TFSI quattro	11.08-09.12	155		LAB	0 265 007 928 <sup>4</sup>		
						0 265 007 930 <sup>3</sup>		
					RAB	0 265 007 928 <sup>3</sup>		
						0 265 007 930 <sup>4</sup>		
		08.09-09.12	132		LAB	0 265 007 928 <sup>4</sup>		
						0 265 007 930 <sup>3</sup>		
					RAB	0 265 007 928 <sup>3</sup>		
						0 265 007 930 <sup>4</sup>		
		06.12→	162/165		LAB	0 265 007 930 <sup>3</sup>		
						0 265 007 930 <sup>4</sup>		
					RAB	0 265 007 928 <sup>3</sup>		
						0 265 007 928 <sup>4</sup>		
	2.0 TFSI quattro flexible fuel	07.12→	155-157		LAB	0 265 007 930 <sup>3</sup>		
						0 265 007 930 <sup>4</sup>		
					RAB	0 265 007 928 <sup>3</sup>		
						0 265 007 928 <sup>4</sup>		





























		S								
3.0 TDI quattro	11.08-09.12	155	LAB	0 265 007 928 <sup>4</sup>		0 265 007 930 <sup>3</sup>				
				RAB	0 265 007 928 <sup>3</sup>					0 265 007 930 <sup>4</sup>
		176	LAB	0 265 007 928 <sup>4</sup>		0 265 007 930 <sup>3</sup>				
			RAB	0 265 007 928 <sup>3</sup>						0 265 007 930 <sup>4</sup>
		06.12→	180	LAB	0 265 007 930 <sup>3</sup>		0 265 007 928 <sup>4</sup>			
				RAB	0 265 007 928 <sup>3</sup>					0 265 007 928 <sup>4</sup>
	09.13→	176	LAB	0 265 007 928 <sup>4</sup>		0 265 007 930 <sup>3</sup>				
			RAB	0 265 007 928 <sup>3</sup>						0 265 007 930 <sup>4</sup>
	11.13→	184/190	LAB	0 265 007 928 <sup>4</sup>		0 265 007 930 <sup>3</sup>				
			RAB	0 265 007 928 <sup>3</sup>						0 265 007 930 <sup>4</sup>
	3.0 TFSI quattro	06.12→	200	LAB	0 265 007 930 <sup>3</sup>		0 265 007 928 <sup>4</sup>			
				RAB	0 265 007 928 <sup>3</sup>					0 265 007 928 <sup>4</sup>
				0 265 007 928 <sup>4</sup>						
3.2 FSI quattro	11.08-09.12	199	LAB	0 265 007 928 <sup>4</sup>		0 265 007 930 <sup>3</sup>				
			RAB	0 265 007 928 <sup>3</sup>						0 265 007 930 <sup>4</sup>
				0 265 007 930 <sup>4</sup>						
<b>Q7 [4LB]</b>										
	3.0 TDI	03.06→	150/155/	PR-Code 1LF	0 986 134 200		←			
	3.0 TFSI		165/171/ 176/180/ 200-249		0 986 135 200		→			
3.6 FSI	03.07-05.10	206	PR-Code 1LF	0 986 134 200		←				
				0 986 135 200		→				
4.2 FSI	03.06→	240/250/	PR-Code 1LF	0 986 134 200		←				
4.2 TDI		257		0 986 135 200		→				
6.0 TDI	09.08-04.12	368	PR-Code 1LF	0 986 134 200		←				
				0 986 135 200		→				
	3.0 TDI	03.06→	150/155/165/171/	LLE	1 987 482 444			1890		
	3.0 TFSI		176/180/200-249	RLE	1 987 482 187			1630		
3.6 FSI	03.07-05.10	206	LLE	1 987 482 444			1890			
			RLE	1 987 482 187			1630			
4.2 FSI	03.06→	240/250/	LLE	1 987 482 444			1890			
4.2 TDI		257	RLE	1 987 482 187			1630			
6.0 TDI	09.08-04.12	368	LLE	1 987 482 444			1890			
			RLE	1 987 482 187			1630			
	3.0 TDI	03.06-05.10	150/155/	LAB	0 986 594 524 <sup>3</sup>					
			165/171/176	RAB	0 986 594 525 <sup>3</sup>					
	03.06→	150/155/ 165/171/176	LAB	0 986 594 524 <sup>4</sup>						
			RAB	0 986 594 525 <sup>4</sup>						
	3.0 TDI	05.10→	180/	LAB	0 986 594 524 <sup>4</sup>					
				3.0 TFSI	200-249	RAB	0 986 594 525 <sup>4</sup>			

























<b>← AUDI Q7 [4LB]</b>									
	3.6 FSI	03.07-05.10	206	LAB	0 986 594 524 <sup>3</sup>				
					RAB	0 986 594 525 <sup>3</sup>			0 986 594 525 <sup>4</sup>
	4.2 FSI	03.06-05.10	240/250/ 257	LAB	0 986 594 524 <sup>3</sup>				
					RAB	0 986 594 525 <sup>3</sup>			0 986 594 525 <sup>4</sup>
	4.2 TDI	03.07-05.10	240/250/ 257	LAB	0 986 594 524 <sup>3</sup>				
					RAB	0 986 594 525 <sup>3</sup>			0 986 594 525 <sup>4</sup>
		03.07→	240/250/ 257	LAB	0 986 594 524 <sup>4</sup>				
					RAB	0 986 594 525 <sup>4</sup>			0 986 594 525 <sup>4</sup>
09.08-04.12	368	LAB	0 986 594 524 <sup>3</sup>						
			RAB	0 986 594 525 <sup>3</sup>			0 986 594 525 <sup>4</sup>		
<b>RS3 Sportback [8PA]</b>									
	2.5 TFSI quattro	01.11-12.12	250			1 987 477 958		↔ 1447	
	2.5 TFSI quattro	01.11-12.12	250	LAB	0 986 594 504 <sup>3</sup>				
					RAB	0 986 594 505 <sup>3</sup>			0 986 594 505 <sup>4</sup>
					0 986 594 505 <sup>4</sup>				
<b>RS4 Avant [8D5; B5]</b>									
	2.7 quattro	05.00-09.01	280					F 026 A06 121 <sup>7</sup> 1 987 474 496 <sup>8</sup>	
	2.7 quattro	05.00-09.01	280	LAB	0 265 006 578 <sup>3</sup>				
					RAB	0 265 006 695 <sup>4</sup>			0 265 006 693 <sup>4</sup>
					0 265 006 693 <sup>4</sup>				
<b>RS4 Avant [8ED; B7]</b>									
	4.2 quattro	05.06-05.07	309	Fg.-Nr. →8E..7..910 000				1 987 474 496 <sup>8</sup>	
		06.07-06.08	309	Fg.-Nr. 8E..8..900 001→				1 987 474 496 <sup>8</sup>	
	4.2 quattro	05.06-06.08	309	LAB	0 265 006 809 <sup>3</sup>				
					RAB	0 265 006 828 <sup>4</sup>			0 265 006 824 <sup>4</sup>
					0 265 006 824 <sup>4</sup>				
<b>RS4 Avant [8K5; B8]</b>									
	4.2 quattro	05.12→	331	LAB	0 265 007 928 <sup>4</sup>				
					RAB	0 265 007 930 <sup>3</sup>			0 265 007 928 <sup>3</sup>
					0 265 007 930 <sup>4</sup>				



		S							
<b>RS4 Cabriolet [8HE; B7]</b>									
									
	4.2 quattro	05.06-05.07	309	Fg.-Nr. →8H..7..805 000					1 987 474 496 <sup>8</sup>
		06.07-01.08	309	Fg.-Nr. 8H..8..800 001→					1 987 474 496 <sup>8</sup>
									
	4.2 quattro	05.06-01.08	309				0 265 006 809 <sup>3</sup>		
							LAB 0 265 006 828 <sup>4</sup>		
							RAB 0 265 006 824 <sup>4</sup>		
<b>RS4 [8EC; B7]</b>									
									
	4.2 quattro	11.05-05.07	309	Fg.-Nr. →8E..7..910 000					1 987 474 496 <sup>8</sup>
		06.07-06.08	309	Fg.-Nr. 8E..8..900 001→					1 987 474 496 <sup>8</sup>
									
	4.2 quattro	11.05-06.08	309				0 265 006 809 <sup>3</sup>		
							LAB 0 265 006 828 <sup>4</sup>		
							RAB 0 265 006 824 <sup>4</sup>		
<b>RS5 Cabriolet [8F7]</b>									
									
	4.2 FSI quattro	11.12→	331				LAB 0 265 007 928 <sup>4</sup>		
							0 265 007 930 <sup>3</sup>		
							RAB 0 265 007 928 <sup>3</sup>		
							0 265 007 930 <sup>4</sup>		
<b>RS5 Coupé [8T3]</b>									
									
	4.2 FSI quattro	03.10→	331				LAB 0 265 007 928 <sup>4</sup>		
							0 265 007 930 <sup>3</sup>		
							RAB 0 265 007 928 <sup>3</sup>		
							0 265 007 930 <sup>4</sup>		
<b>RS6 Avant [4B6]</b>									
									
	4.2 quattro	05.02-09.04	331/353						1 987 470 040 <sup>7</sup>
									1 987 474 496 <sup>8</sup>
									
	4.2 quattro	05.02-08.03	331	Fg.-Nr. →4B..4..900 476	LAB		0 265 006 771 <sup>4</sup>		
		05.02-04.04	331				0 265 006 765 <sup>3</sup>		
							RAB 0 265 006 767 <sup>4</sup>		
		09.03-04.04	331	Fg.-Nr. 4B..4..900 477→	LAB		0 265 006 769 <sup>4</sup>		
		04.04-09.04	353				0 265 006 765 <sup>3</sup>		
							LAB 0 265 006 769 <sup>4</sup>		
							RAB 0 265 006 767 <sup>4</sup>		
<b>RS6 Avant [4F5; C6]</b>									
									
	5.0 TFSI quattro	04.08-08.10	426				LAB 0 265 007 930 <sup>3</sup>		
							0 265 007 930 <sup>4</sup>		
							RAB 0 265 007 928 <sup>3</sup>		
							0 265 007 928 <sup>4</sup>		



		S				?			
◀ AUDI									
<b>RS6 Avant [4G; C7]</b>									
									
	4.0 TFSI quattro	01.13→	412				0 265 007 928 <sup>4</sup>		
							0 265 007 930 <sup>3</sup>		
<b>RS6 [4B4]</b>									
									
	4.2 quattro	07.02-04.04	331						1 987 470 040 <sup>7</sup>
									1 987 474 496 <sup>8</sup>
									
	4.2 quattro	07.02-08.03	331	Fg.-Nr. →4B..4..900 476	LAB		0 265 006 771 <sup>4</sup>		
		07.02-04.04	331				0 265 006 765 <sup>3</sup>		
					RAB		0 265 006 767 <sup>4</sup>		
		09.03-04.04	331	Fg.-Nr. 4B..4..900 477→	LAB		0 265 006 769 <sup>4</sup>		
<b>RS6 [4F2; C6]</b>									
									
	5.0 TFSI quattro	09.08-08.10	426		LAB		0 265 007 930 <sup>3</sup>		
							0 265 007 930 <sup>4</sup>		
					RAB		0 265 007 928 <sup>3</sup>		
							0 265 007 928 <sup>4</sup>		
<b>RS7 Sportback [4G]</b>									
									
	4.0 TFSI quattro	05.13→	412		LAB		0 265 007 928 <sup>4</sup>		
							0 265 007 930 <sup>3</sup>		
					RAB		0 265 007 928 <sup>3</sup>		
							0 265 007 930 <sup>4</sup>		
<b>R8 Spyder GT [427]</b>									
									
	5.2 FSI quattro	11.11-10.12	412		LAB		0 265 007 928 <sup>3</sup>		
							0 265 007 928 <sup>4</sup>		
					RAB		0 265 007 930 <sup>3</sup>		
							0 265 007 930 <sup>4</sup>		
<b>R8 Spyder [429]</b>									
									
	4.2 FSI quattro	09.10→	316		LAB		0 265 007 928 <sup>3</sup>		
							0 265 007 928 <sup>4</sup>		
					RAB		0 265 007 930 <sup>3</sup>		
							0 265 007 930 <sup>4</sup>		
	5.2 FSI quattro	02.10-07.12	386		LAB		0 265 007 928		
							0 265 007 930		
		07.12→	386		LAB		0 265 007 928 <sup>3</sup>		
							0 265 007 928 <sup>4</sup>		
					RAB		0 265 007 930 <sup>3</sup>		
							0 265 007 930 <sup>4</sup>		
<b>R8 [422]</b>									
									
	5.2 FSI GT quattro	11.10-10.12	412		LAB		0 265 007 928 <sup>3</sup>		
							0 265 007 928 <sup>4</sup>		



		S							
5.2 FSI GT quattro		11.10-10.12	412			RAB	0 265 007 930 <sup>3</sup>		
							0 265 007 930 <sup>4</sup>		
<b>R8 [423]</b>									
4.2 FSI quattro		04.07-09.10	309			LAB	0 265 007 928		
						RAB	0 265 007 930		
		09.10→	316			LAB	0 265 007 928 <sup>3</sup>		
							0 265 007 928 <sup>4</sup>		
						RAB	0 265 007 930 <sup>3</sup>		
							0 265 007 930 <sup>4</sup>		
5.2 FSI quattro		04.09-07.12	386			LAB	0 265 007 928		
						RAB	0 265 007 930		
		09.12→	404/419			LAB	0 265 007 928 <sup>3</sup>		
							0 265 007 928 <sup>4</sup>		
						RAB	0 265 007 930 <sup>3</sup>		
							0 265 007 930 <sup>4</sup>		
5.2 FSI quattro		09.12→	386			LAB	0 265 007 928 <sup>3</sup>		
							0 265 007 928 <sup>4</sup>		
						RAB	0 265 007 930 <sup>3</sup>		
							0 265 007 930 <sup>4</sup>		
<b>SQ5 [8RB]</b>									
3.0 TDI quattro		12.12→	230			LAB	0 265 007 930 <sup>3</sup>		
						RAB	0 265 007 930 <sup>4</sup>		
							0 265 007 928 <sup>3</sup>		
							0 265 007 928 <sup>4</sup>		
		05.15→	230			LAB	0 265 007 928 <sup>4</sup>		
						RAB	0 265 007 930 <sup>4</sup>		
			240/260			LAB	0 265 007 928 <sup>4</sup>		
							0 265 007 930 <sup>3</sup>		
						RAB	0 265 007 928 <sup>3</sup>		
							0 265 007 930 <sup>4</sup>		
3.0 TFSI quattro		06.13→	240/260			LAB	0 265 007 928 <sup>4</sup>		
							0 265 007 930 <sup>3</sup>		
						RAB	0 265 007 928 <sup>3</sup>		
							0 265 007 930 <sup>4</sup>		
<b>S1 Sportback [8X]</b>									
2.0 TFSI quattro		01.14→	170	PR-Code 1ZC, PR-Code 1ZS	288		0 986 473 384	← 53,94	
							0 986 474 384	→ 53,94	
				PR-Code 1ZC, PR-Code 1ZS, PR-Code 1ZM, PR-Code 1ZN	288				F 026 A06 106 <sup>7</sup>
2.0 TFSI quattro		01.14→	170	PR-Code 1KF, PR-Code 1KX					1 987 470 040 <sup>7</sup>
2.0 TFSI quattro		01.14→	170			LAB	0 986 594 504 <sup>4</sup>		
						RAB	0 986 594 507 <sup>4</sup>		





		S							
◀ AUDI									
<b>S1 [8X]</b>									
	2.0 TFSI quattro	01.14→	170	PR-Code 1ZC, PR-Code 1ZS	288	0986 473 384		53,94	
						0986 474 384		53,94	
				PR-Code 1ZC, PR-Code 1ZS, PR-Code 1ZM, PR-Code 1ZN	288				F 026 A06 106 <sup>7</sup>
	2.0 TFSI quattro	01.14→	170	PR-Code 1KF, PR-Code 1KX					1987 470 040 <sup>7</sup>
	2.0 TFSI quattro	01.14→	170		LAB	0986 594 504 <sup>4</sup>			
					RAB	0986 594 507 <sup>4</sup>			
<b>S3 Cabriolet [8V7]</b>									
	2.0 TFSI quattro	05.14→	210/221		GBM,LAB	0986 594 524 <sup>4</sup>			
					GBM,RAB	0986 594 525 <sup>4</sup>			
					GBM,LAB	0986 594 504 <sup>4</sup>			
					GBM,RAB	0986 594 505 <sup>4</sup>			
<b>S3 Limousine [8VS]</b>									
	2.0 TFSI quattro	11.13→	210/221		GBM,LAB	0986 594 524 <sup>4</sup>			
					GBM,RAB	0986 594 525 <sup>4</sup>			
					GBM,LAB	0986 594 504 <sup>4</sup>			
					GBM,RAB	0986 594 505 <sup>4</sup>			
<b>S3 Sportback [8PA]</b>									
	2.0 TFSI quattro	07.08-03.13	188/195			0986 134 287			F 026 A03 545 <sup>7</sup>
						0986 134 287			1987 470 506 <sup>8</sup>
						0986 135 287			F 026 A03 545 <sup>7</sup>
	2.0 TFSI quattro	07.08-03.13	188/195	PR-Code 2EA	FBJ	0986 134 297			
						0986 135 297			
	2.0 TFSI quattro	07.08-03.13	188/195			1987 477 958		1447	
	2.0 TFSI quattro	07.08-03.13	188/195		LAB	0986 594 504 <sup>3</sup>			
						0986 594 504 <sup>4</sup>			
					RAB	0986 594 505 <sup>3</sup>			
						0986 594 505 <sup>4</sup>			
<b>S3 Sportback [8VA]</b>									
	2.0 TFSI quattro	05.13→	206/210/221		GBM,LAB	0986 594 524 <sup>4</sup>			
					GBM,RAB	0986 594 525 <sup>4</sup>			
					GBM,LAB	0986 594 504 <sup>4</sup>			
					GBM,RAB	0986 594 505 <sup>4</sup>			



		S							
<b>S3 [8L1]</b>									
	1.8 quattro	08.98-06.03	154/165				0 986 473 923	← 54	1 987 470 506 <sup>8</sup>
							0 986 473 924	→ 54	1 987 470 506 <sup>8</sup>
	1.8 quattro	08.98-06.03	154/165				0 986 473 139	← 38,1	1 987 470 040 <sup>7</sup>
							0 986 473 139	← 38,1	1 987 474 496 <sup>8</sup>
							0 986 474 139	→ 38,1	1 987 470 040 <sup>7</sup>
	1.8 quattro	08.98-06.03	154/165				1 987 477 686	↔ 1723	
		1.8 quattro	08.98-04.02	154			0 986 594 008 <sup>4</sup>		
						LAB	0 986 594 001 <sup>3</sup>		
						RAB	0 986 594 000 <sup>3</sup>		
<b>S3 [8P1]</b>									
	2.0 TFSI quattro	11.06-03.13	188/195				0 986 134 287	←	F 026 A03 545 <sup>7</sup>
							0 986 134 287	←	1 987 470 506 <sup>8</sup>
							0 986 135 287	→	F 026 A03 545 <sup>7</sup>
	2.0 TFSI quattro	11.06-06.08	188/195	PR-Code 2EA			0 986 134 297	←	
							0 986 135 297	→	
		07.08-03.13	188/195	PR-Code 2EA	FBJ		0 986 134 297	←	
							0 986 135 297	→	
	2.0 TFSI quattro	11.06-03.13	188/195				1 987 477 958	↔ 1447	
		2.0 TFSI quattro	11.06-03.13	188/195		LAB	0 986 594 504 <sup>3</sup>		
							0 986 594 504 <sup>4</sup>		
						RAB	0 986 594 505 <sup>3</sup>		
							0 986 594 505 <sup>4</sup>		
<b>S3 [8V1]</b>									
	2.0 TFSI quattro	11.12→	206/210/ 221			GBM,LAB	0 986 594 524 <sup>4</sup>		
						GBM,RAB	0 986 594 525 <sup>4</sup>		
						GBM,LAB	0 986 594 504 <sup>4</sup>		
						GBM,RAB	0 986 594 505 <sup>4</sup>		
<b>S4 Avant [4A5; C4]</b>									
	2.2 quattro	07.92-07.94	169				0 986 474 208	← 43	
							0 986 473 208	→ 43	



		S							
◀ AUDI									
<b>S4 Avant [8D5; B5]</b>									
	2.7 Biturbo quattro	10.97-07.98	195				0986 <b>134 074</b>		← 43
							0986 <b>135 074</b>		→ 43
	2.7 Biturbo quattro	10.97-09.01	195-280				0986 <b>134 068</b>		← 43
							0986 <b>134 068</b>		← 43
							0986 <b>135 068</b>		→ 43
	2.7 Biturbo quattro	10.97-12.98	195	Fg.-Nr. →8D..X..199 999			0986 <b>594 014</b> <sup>3</sup>		
		06.98-09.01	195	Fg.-Nr. 8D..W..280 001→	ALR,LAB		0265 <b>006 571</b> <sup>4</sup>		
					ALR,RAB		0265 <b>006 569</b> <sup>4</sup>		
					ALR		0265 <b>006 569</b> <sup>4</sup>		
		01.99-09.01	195	Fg.-Nr. 8D..X..200 001→	SCK		0265 <b>006 578</b> <sup>3</sup>		
					STK		0986 <b>594 002</b> <sup>3</sup>		
		11.00-09.01	195-280		ALR,LAB		0265 <b>006 571</b> <sup>4</sup>		
					ALR,RAB		0265 <b>006 569</b> <sup>4</sup>		
					SCK		0265 <b>006 578</b> <sup>3</sup>		
					STK		0986 <b>594 002</b> <sup>3</sup>		
<b>S4 Avant [8ED; B7]</b>									
	4.2 quattro	11.04-06.06	253	Fg.-Nr. →8E..6..400 000					1987 <b>470 506</b> <sup>8</sup>
		07.06-06.08	253	Fg.-Nr. 8E..7..000 001→					1987 <b>470 506</b> <sup>8</sup>
	4.2 quattro	11.04-06.08	253				0265 <b>006 809</b> <sup>3</sup>		
					ALR,LAB		0265 <b>006 828</b> <sup>4</sup>		
					ALR,RAB		0265 <b>006 824</b> <sup>4</sup>		
					ALR		0265 <b>006 824</b> <sup>4</sup>		
<b>S4 Avant [8E5; B6]</b>									
	4.2 quattro	03.03-12.04	253						1987 <b>470 506</b> <sup>8</sup>
	4.2 quattro	03.03-05.03	253	Fg.-Nr. →8E..3..500 000			0265 <b>006 683</b> <sup>3</sup>		
		03.03-05.04	253	Fg.-Nr. →8E..4..050 000	ALR,LAB		0265 <b>006 707</b> <sup>4</sup>		
				Fg.-Nr. →8E..4..400 000	ALR,RAB		0265 <b>006 681</b> <sup>4</sup>		
					ALR		0265 <b>006 681</b> <sup>4</sup>		
		06.03-12.04	253	Fg.-Nr. 8E..4..000 001→			0265 <b>006 809</b> <sup>3</sup>		
		06.04-12.04	253	Fg.-Nr. 8E..5..000 001→	ALR,LAB		0265 <b>006 826</b> <sup>4</sup>		
					ALR,RAB		0265 <b>006 824</b> <sup>4</sup>		
					ALR		0265 <b>006 824</b> <sup>4</sup>		
<b>S4 Avant [8K5; B8]</b>									
	3.0 TFSI quattro	05.14→	245	PR-Code 1LT	S31		0986 <b>134 267</b>		← 57
							0986 <b>135 267</b>		→ 57
				PR-Code 1LT, PR-Code 1LY	S31				1987 <b>470 506</b> <sup>8</sup>
				PR-Code 1LY	S31				F 026 <b>A03 545</b> <sup>7</sup>







































		S							
	3.0 TFSI quattro	03.09→	245			LAB	0 265 007 928 <sup>4</sup>		
						RAB	0 265 007 930 <sup>3</sup>		
							0 265 007 928 <sup>3</sup>		
							0 265 007 930 <sup>4</sup>		
<b>S4 Cabriolet [8HE; B7]</b>									
	4.2 quattro	01.06-05.06	253	Fg.-Nr. →8H..7..900 460					1 987 470 506 <sup>B</sup>
		06.06-03.09	253	Fg.-Nr. 8H..7..900 461→					1 987 470 506 <sup>B</sup>
	4.2 quattro	01.06-03.09	253				0 265 006 809 <sup>3</sup>		
						LAB	0 265 006 828 <sup>4</sup>		
						RAB	0 265 006 824 <sup>4</sup>		
<b>S4 Cabriolet [8H7; B7]</b>									
	4.2 quattro	02.04-06.06	253						1 987 470 506 <sup>B</sup>
	4.2 quattro	02.04-05.04	253	Fg.-Nr. →8H..4..050 000,	LAB		0 265 006 707 <sup>4</sup>		
				→8H..4..902 000, PR-Code 8Q3					
		02.04-06.06	253				0 265 006 809 <sup>3</sup>		
				PR-Code 8Q0, PR-Code 8Q1			0 265 006 681 <sup>4</sup>		
				PR-Code 8Q3	RAB		0 265 006 681 <sup>4</sup>		
		06.04-06.06	253	Fg.-Nr. 8H..5..000 001→,	LAB		0 265 006 826 <sup>4</sup>		
				8H..5..900 001→, PR-Code 8Q3					
<b>S4 [4A2; C4]</b>									
	2.2 quattro	07.92-07.94	169				0 986 474 208		← 43
							0 986 473 208		→ 43
	4.2 quattro	07.92-07.94	206				0 986 474 208		← 43
							0 986 473 208		→ 43
	2.2 quattro	07.92-07.94	169				1 987 477 813		← 1692
							1 987 477 815		→ 1676
	4.2 quattro	07.92-07.94	206				1 987 477 813		← 1692
							1 987 477 815		→ 1676
<b>S4 [8D2; B5]</b>									
	2.7 Biturbo quattro	10.97-07.98	195				0 986 134 074		← 43
							0 986 135 074		→ 43
	2.7 Biturbo quattro	10.97-09.01	195				0 986 134 068		← 43
							0 986 134 068		← 43
							0 986 135 068		→ 43
									F 026 A06 121 <sup>7</sup>
									1 987 474 496 <sup>B</sup>
									F 026 A06 121 <sup>7</sup>



		S							
◀ AUDI S4 [8D2; B5]									
	2.7 Biturbo quattro	10.97-12.98	195	Fg.-Nr. →8D..X..199 999			0 986 594 014 <sup>3</sup>		
		06.98-10.00	195	Fg.-Nr. 8D..W..280 001→	ALR,LAB		0 265 006 571 <sup>4</sup>		
					ALR,RAB		0 265 006 569 <sup>4</sup>		
					ALR		0 265 006 569 <sup>4</sup>		
		01.99-10.00	195	Fg.-Nr. 8D..X..200 001→	SCK		0 265 006 578 <sup>3</sup>		
					STK		0 986 594 002 <sup>3</sup>		
		11.00-09.01	195		ALR,LAB		0 265 006 571 <sup>4</sup>		
					ALR,RAB		0 265 006 569 <sup>4</sup>		
					SCK		0 265 006 578 <sup>3</sup>		
					STK		0 986 594 002 <sup>3</sup>		
S4 [8EC; B7]									
	4.2 quattro	11.04-06.06	253	Fg.-Nr. →8E..6..400 000					1 987 470 506 <sup>8</sup>
		07.06-06.08	253	Fg.-Nr. 8E..7..000 001→					1 987 470 506 <sup>8</sup>
	4.2 quattro	11.04-06.08	253				0 265 006 809 <sup>3</sup>		
					ALR,LAB		0 265 006 828 <sup>4</sup>		
					ALR,RAB		0 265 006 824 <sup>4</sup>		
					ALR		0 265 006 824 <sup>4</sup>		
S4 [8E2; B6]									
	4.2 quattro	03.03-12.04	253						1 987 470 506 <sup>8</sup>
	4.2 quattro	03.03-05.03	253	Fg.-Nr. →8E..3..500 000			0 265 006 683 <sup>3</sup>		
		03.03-05.04	253	Fg.-Nr. →8E..4..050 000	ALR,LAB		0 265 006 707 <sup>4</sup>		
				Fg.-Nr. →8E..4..400 000	ALR,RAB		0 265 006 681 <sup>4</sup>		
					ALR		0 265 006 681 <sup>4</sup>		
		06.03-12.04	253	Fg.-Nr. 8E..4..000 001→			0 265 006 809 <sup>3</sup>		
		06.04-12.04	253	Fg.-Nr. 8E..5..000 001→	ALR,LAB		0 265 006 826 <sup>4</sup>		
					ALR,RAB		0 265 006 824 <sup>4</sup>		
					ALR		0 265 006 824 <sup>4</sup>		
S4 [8K2; B8]									
	3.0 TFSI quattro	05.14→	245	PR-Code 1LT	S31		0 986 134 267		← 57
							0 986 135 267		→ 57
				PR-Code 1LT, PR-Code 1LY	S31				1 987 470 506 <sup>8</sup>
				PR-Code 1LY	S31				F 026 A03 545 <sup>7</sup>
	3.0 TFSI quattro	03.09→	245		LAB		0 265 007 928 <sup>4</sup>		
							0 265 007 930 <sup>3</sup>		
					RAB		0 265 007 928 <sup>3</sup>		
							0 265 007 930 <sup>4</sup>		
S5 Cabriolet [8F7]									
	3.0 TFSI quattro	05.09-06.14	245		LAB		0 265 007 928 <sup>4</sup>		
					RAB		0 265 007 930 <sup>4</sup>		



		S							
3.0 TFSI quattro		05.09→	245			LAB	0 265 007 930 <sup>3</sup>		
						RAB	0 265 007 928 <sup>3</sup>		
		05.14→	245			LAB	0 265 007 930 <sup>4</sup>		
						RAB	0 265 007 928 <sup>4</sup>		
<b>S5 Coupé [8T3]</b>									
									
 3.0 TFSI quattro		09.11→	245/265			LAB	0 265 007 928 <sup>4</sup>		
							0 265 007 930 <sup>3</sup>		
						RAB	0 265 007 928 <sup>3</sup>		
							0 265 007 930 <sup>4</sup>		
4.2 quattro		06.07-03.12	260			LAB	0 265 007 928 <sup>4</sup>		
							0 265 007 930 <sup>3</sup>		
						RAB	0 265 007 928 <sup>3</sup>		
							0 265 007 930 <sup>4</sup>		
<b>S5 Sportback [8TA]</b>									
									
 3.0 TFSI quattro		01.10→	245/265			LAB	0 265 007 928 <sup>4</sup>		
							0 265 007 930 <sup>3</sup>		
						RAB	0 265 007 928 <sup>3</sup>		
							0 265 007 930 <sup>4</sup>		
<b>S6 Avant [4A5; C4]</b>									
									
 2.2 T quattro		06.94-07.97	169				0 986 474 208	 ← 43	
							0 986 473 208	 → 43	
4.2 quattro		09.94-07.97	213				0 986 474 208	 ← 43	
							0 986 473 208	 → 43	
									
 2.2 T quattro		06.94-07.97	169				1 987 477 813	← 1692	
							1 987 477 815	→ 1676	
4.2 Plus quattro		09.94-10.97	213/240				1 987 477 813	← 1692	
4.2 quattro							1 987 477 815	→ 1676	
<b>S6 Avant [4B; C5]</b>									
									
 4.2 quattro		09.99-05.01	250	PR-Code 1LT, PR-Code 1LF	312		0 986 473 070	 ← 56,93	1 987 470 005 <sup>7</sup>
							0 986 473 070	 ← 56,93	1 987 470 506 <sup>8</sup>
							0 986 474 070	 → 56,93	1 987 470 005 <sup>7</sup>
				PR-Code 1LX	321,FSB		0 986 134 078	 ← 60	1 987 470 506 <sup>8</sup>
							0 986 135 078	 → 60	1 987 470 506 <sup>8</sup>
					321,SSB		0 986 134 074	 ← 43	1 987 470 506 <sup>8</sup>
							0 986 135 074	 → 43	1 987 470 506 <sup>8</sup>
									
 4.2 quattro		09.99-05.01	250				0 986 473 185	 ← 43	F 026 A06 121 <sup>7</sup>
							0 986 473 185	 ← 43	1 987 474 496 <sup>8</sup>
							0 986 474 185	 → 43	F 026 A06 121 <sup>7</sup>
									
 4.2 quattro		09.99-05.01	250				1 987 477 959	1925	



◀ AUDI S6 Avant [4B; C5]													
	4.2 quattro	09.99-05.01	250			0 265 006 578 <sup>3</sup>							
				LAB	0 265 006 664 <sup>4</sup>								
				RAB	0 265 006 565 <sup>4</sup>								
<b>S6 Avant [4B6; C5]</b>													
	4.2 quattro	06.01-01.05	250	PR-Code 1LT, PR-Code 1LF	312	0 986 473 070		← 56,93	1 987 470 005 <sup>7</sup>				
						0 986 473 070		← 56,93	1 987 470 506 <sup>8</sup>				
										0 986 474 070		→ 56,93	1 987 470 005 <sup>7</sup>
								PR-Code 1LX	321,FSB	0 986 134 078		← 60	1 987 470 506 <sup>8</sup>
										0 986 135 078		→ 60	1 987 470 506 <sup>8</sup>
									321,SSB	0 986 134 074		← 43	1 987 470 506 <sup>8</sup>
										0 986 135 074		→ 43	1 987 470 506 <sup>8</sup>
	4.2 quattro	06.01-01.05	250			0 986 473 185		← 43	F 026 A06 121 <sup>7</sup>				
						0 986 473 185		← 43	1 987 474 496 <sup>8</sup>				
						0 986 474 185		→ 43	F 026 A06 121 <sup>7</sup>				
	4.2 quattro	06.01-01.05	250			1 987 477 959		1925					
	4.2 quattro	06.01-12.01	250	Fg.-Nr. →4B..2..079 500	LAB	0 265 006 664 <sup>4</sup>							
					RAB	0 265 006 565 <sup>4</sup>							
		01.02-01.05	250	Fg.-Nr. 4B..2..079 501→	LAB	0 265 006 771 <sup>4</sup>							
					RAB	0 265 006 767 <sup>4</sup>							
	07.02-01.05	250	Fg.-Nr. 4B..3..000 001→			0 265 006 765 <sup>3</sup>							
<b>S6 Avant [4F5; C6]</b>													
	5.2 FSI quattro	06.07-08.11	320	Fg.-Nr. 4F..8..000 001→				1 987 474 496 <sup>8</sup>					
	5.2 FSI quattro	06.06-08.11	320			LAB	0 265 007 930 <sup>3</sup>						
							0 265 007 930 <sup>4</sup>						
						RAB	0 265 007 928 <sup>3</sup>						
							0 265 007 928 <sup>4</sup>						
<b>S6 Avant [4G; C7]</b>													
	4.0 TFSI quattro	04.12→	309/331			LAB	0 265 007 928 <sup>4</sup>						
							0 265 007 930 <sup>3</sup>						
						RAB	0 265 007 928 <sup>3</sup>						
							0 265 007 930 <sup>4</sup>						
<b>S6 [4A2; C4]</b>													
	2.2 T quattro	06.94-07.97	169			0 986 474 208		← 43					
						0 986 473 208		→ 43					
	4.2 quattro	09.94-07.97	213			0 986 474 208		← 43					
						0 986 473 208		→ 43					



		S							
	2.2 T quattro	06.94-07.97	169				1 987 477 813	← 1692	
	4.2 Plus quattro	09.94-10.97	213/240				1 987 477 815	→ 1676	
	4.2 quattro						1 987 477 813	← 1692	
							1 987 477 815	→ 1676	
<b>S6 [4B4; C5]</b>									
	4.2 quattro	09.99-05.04	250	PR-Code 1LT, PR-Code 1LF	312		0 986 473 070	← 56,93	1 987 470 005 <sup>7</sup>
							0 986 473 070	← 56,93	1 987 470 506 <sup>8</sup>
							0 986 474 070	→ 56,93	1 987 470 005 <sup>7</sup>
				PR-Code 1LX	321,FSB		0 986 134 078	← 60	1 987 470 506 <sup>8</sup>
							0 986 135 078	→ 60	1 987 470 506 <sup>8</sup>
					321,SSB		0 986 134 074	← 43	1 987 470 506 <sup>8</sup>
							0 986 135 074	→ 43	1 987 470 506 <sup>8</sup>
	4.2 quattro	09.99-05.04	250				0 986 473 185	← 43	F 026 A06 121 <sup>7</sup>
							0 986 473 185	← 43	1 987 474 496 <sup>8</sup>
							0 986 474 185	→ 43	F 026 A06 121 <sup>7</sup>
	4.2 quattro	09.99-05.04	250				1 987 477 959		1925
	4.2 quattro	09.99-05.01	250				0 265 006 578 <sup>3</sup>		
						LAB	0 265 006 664 <sup>4</sup>		
						RAB	0 265 006 565 <sup>4</sup>		
		06.01-12.01	250	Fg.-Nr. →4B..2..079 500		LAB	0 265 006 664 <sup>4</sup>		
						RAB	0 265 006 565 <sup>4</sup>		
		01.02-05.04	250	Fg.-Nr. 4B..2..079 501→		LAB	0 265 006 771 <sup>4</sup>		
						RAB	0 265 006 767 <sup>4</sup>		
		07.02-05.04	250	Fg.-Nr. 4B..3..000 001→			0 265 006 765 <sup>3</sup>		
<b>S6 [4F2; C6]</b>									
	5.2 FSI quattro	06.07-08.11	320	Fg.-Nr. 4F..8..000 001→					1 987 474 496 <sup>8</sup>
	5.2 FSI quattro	06.06-08.11	320			LAB	0 265 007 930 <sup>3</sup>		
							0 265 007 930 <sup>4</sup>		
						RAB	0 265 007 928 <sup>3</sup>		
							0 265 007 928 <sup>4</sup>		
<b>S6 [4G; C7]</b>									
	4.0 TFSI quattro	04.12→	309/331			LAB	0 265 007 928 <sup>4</sup>		
							0 265 007 930 <sup>3</sup>		
						RAB	0 265 007 928 <sup>3</sup>		
							0 265 007 930 <sup>4</sup>		





◀ AUDI									
<b>S7 Sportback [4G]</b>									
	4.0 TFSI quattro	04.12→	309/331		LAB	0 265 007 928 <sup>4</sup>			
					RAB	0 265 007 930 <sup>3</sup>			
						0 265 007 928 <sup>3</sup>			
						0 265 007 930 <sup>4</sup>			
<b>S8 [4D2]</b>									
	4.2 quattro	05.99-09.02	265			0 986 134 074		← 43	
						0 986 135 074		→ 43	
	4.2 quattro	09.96-10.98	250	Fg.-Nr. →4D..X..004 999		0 986 473 523		← 43	F 026 A06 121 <sup>7</sup>
		11.98-12.98	250	Fg.-Nr. 4D..X..005 001→		0 986 474 523		→ 43	F 026 A06 121 <sup>7</sup>
		05.99-09.02	265						1 987 474 496 <sup>8</sup>
									F 026 A06 121 <sup>7</sup>
									1 987 474 496 <sup>8</sup>
	4.2 quattro	09.96-12.98	250			1 987 477 881		← 1657	
					FLR	1 987 477 882		→ 1720	
		05.99-09.02	265			1 987 482 126		← 1776	
					FLR	1 987 477 881		← 1657	
					FLR	1 987 477 882		→ 1720	
					FLR	1 987 482 126		← 1776	
	4.2 quattro	09.96-12.98	250		FKR	0 265 006 588 <sup>4</sup>			
		10.98-12.98	250	Fg.-Nr. 4D..X..005 001→	16R,FKR	0 265 006 580 <sup>3</sup>			
					20R,FKR	0 265 006 662 <sup>3</sup>			
		05.99-09.02	265		FKR	0 265 006 588 <sup>4</sup>			
					16R,FKR	0 265 006 580 <sup>3</sup>			
					20R,FKR	0 265 006 662 <sup>3</sup>			
<b>S8 [4E2]</b>									
	5.2 FSI quattro	06.06-07.10	331		LAB	0 265 007 928 <sup>4</sup>			
					RAB	0 265 007 930 <sup>3</sup>			
						0 265 007 928 <sup>3</sup>			
						0 265 007 930 <sup>4</sup>			
<b>S8 [4H; D4]</b>									
	4.0 FSI quattro	04.12-04.14	382		LAB	0 265 007 928 <sup>4</sup>			
					RAB	0 265 007 930 <sup>3</sup>			
						0 265 007 928 <sup>3</sup>			
						0 265 007 930 <sup>4</sup>			
	4.0 TFSI quattro	09.13→	382		LAB	0 265 007 928 <sup>4</sup>			
					RAB	0 265 007 930 <sup>3</sup>			
						0 265 007 928 <sup>3</sup>			
						0 265 007 930 <sup>4</sup>			



		S								
<b>TT Coupé [FV3]</b>										
	2.0 TFSI quattro	07.14→	169		LAB	0 986 594 524 <sup>4</sup>				
					RAB	0 986 594 525 <sup>4</sup>				
<b>TT Coupé [8J3]</b>										
	1.8 TFSI	06.08-06.14	118	PR-Code 1LJ	312	0 986 473 384		← 53,94		
						0 986 474 384		→ 53,94		
				PR-Code 1LL	312	0 986 473 384		← 53,94		
						0 986 474 384		→ 53,94		
				PR-Code 1LM	Y61					F 026 A03 545 <sup>7</sup> 1 987 470 506 <sup>8</sup>
	2.0 TDI quattro	06.08-06.14	125	PR-Code 1LJ	312	0 986 473 384		← 53,94		
						0 986 474 384		→ 53,94		
				PR-Code 1LL	312	0 986 473 384		← 53,94		
						0 986 474 384		→ 53,94		
				PR-Code 1LM	Y61					F 026 A03 545 <sup>7</sup> 1 987 470 506 <sup>8</sup>
	2.0 TFSI	07.06-10.06	147	PR-Code 1LK	Y61	0 986 134 287		←		1 987 470 506 <sup>8</sup>
				PR-Code 1LM	Y61	0 986 134 287		←		1 987 470 506 <sup>8</sup>
		07.06-06.10	147	PR-Code 1LJ	312	0 986 473 384		← 53,94		
						0 986 474 384		→ 53,94		
				PR-Code 1LL	312	0 986 473 384		← 53,94		
						0 986 474 384		→ 53,94		
		03.07-05.09	147	PR-Code 1LJ		0 986 473 384		← 53,94	F 026 A06 106 <sup>7</sup>	
						0 986 473 384		← 53,94	1 987 470 506 <sup>8</sup>	
						0 986 474 384		→ 53,94	F 026 A06 106 <sup>7</sup>	
	2.0 TFSI quattro	06.08-06.10	147	PR-Code 1LJ	312	0 986 473 384		← 53,94		
						0 986 474 384		→ 53,94		
				PR-Code 1LL	312	0 986 473 384		← 53,94		
						0 986 474 384		→ 53,94		
	2.0 TFSI	11.06-06.10	147	PR-Code 1LM	Y61					1 987 470 506 <sup>8</sup>
	2.0 TFSI quattro	06.08-06.10	147	PR-Code 1LM	Y61					F 026 A03 545 <sup>7</sup>
		05.10-06.14	155	PR-Code 1LJ	312	0 986 473 384		← 53,94		
						0 986 474 384		→ 53,94		
				PR-Code 1LL	312	0 986 473 384		← 53,94		
						0 986 474 384		→ 53,94		
				PR-Code 1LM	Y61					F 026 A03 545 <sup>7</sup> 1 987 470 506 <sup>8</sup>
	3.2 quattro	07.06-09.06	184	PR-Code 1LM		0 986 134 287		←		
		07.06-06.10	184	PR-Code 1LK		0 986 134 287		←	F 026 A03 545 <sup>7</sup>	
						0 986 134 287		←	1 987 470 506 <sup>8</sup>	
				PR-Code 1LM					F 026 A06 106 <sup>7</sup>	
									1 987 470 506 <sup>8</sup>	
				PR-Code 1LN		0 986 134 287		←	F 026 A03 545 <sup>7</sup>	
						0 986 134 287		←	1 987 470 506 <sup>8</sup>	
						0 986 135 287		→	F 026 A03 545 <sup>7</sup>	
	1.8 TFSI	06.08-06.14	118	PR-Code 1KZ		0 986 134 048		← 38		
						0 986 135 048		→ 38		
				PR-Code 1KZ, PR-Code 2ED						1 987 470 040 <sup>7</sup>
				PR-Code 2ED		0 986 134 048		← 38		1 987 474 496 <sup>8</sup>
						0 986 135 048		→ 38		1 987 474 496 <sup>8</sup>
	2.0 TDI quattro	06.08-06.14	125	PR-Code 1KJ		0 986 473 448		← 41		
						0 986 474 448		→ 41		



<b>AUDI TT Coupé [8J3]</b>												
	<b>2.0 TFSI</b>	07.06-06.10	147	PR-Code 1KZ		0986 134 048		← 38				
						0986 135 048		→ 38				
						PR-Code 1KZ, PR-Code 2ED			1987 470 040 <sup>7</sup>			
						PR-Code 2ED	0986 134 048		← 38	1987 474 496 <sup>8</sup>		
							0986 135 048		→ 38	1987 474 496 <sup>8</sup>		
		03.07-05.09		147	PR-Code 1KZ	0986 134 048		← 38	1987 470 040 <sup>7</sup>			
	05.10-06.14		155	PR-Code 1KZ	0986 134 048		← 38	1987 470 040 <sup>7</sup>				
					0986 135 048		→ 38	1987 470 040 <sup>7</sup>				
				PR-Code 1KZ, PR-Code 2ED				1987 470 040 <sup>7</sup>				
				PR-Code 2ED	0986 134 048		← 38	1987 474 496 <sup>8</sup>				
					0986 135 048		→ 38	1987 474 496 <sup>8</sup>				
	<b>2.0 TFSI quattro</b>	06.08-06.10		147	PR-Code 1KJ	0986 473 448		← 41				
			0986 474 448			→ 41						
05.10-06.14		155	PR-Code 1KJ	0986 473 448		← 41						
				0986 474 448		→ 41						
<b>3.2 quattro</b>	07.06-06.10		184	PR-Code 2EA	0986 134 297		←	1987 474 496 <sup>8</sup>				
					0986 135 297		→	1987 474 496 <sup>8</sup>				
				PR-Code 2EF				1987 474 496 <sup>8</sup>				
<b>TT Coupé [8N3]</b>												
	<b>1.8 TFSI</b>	06.08-06.14		118	LAB	0986 594 504 <sup>3</sup>						
						0986 594 506 <sup>4</sup>						
						RAB	0986 594 505 <sup>3</sup>					
							0986 594 507 <sup>4</sup>					
		<b>2.0 TDI quattro</b>	06.08-06.14			125	LAB	0986 594 504 <sup>3</sup>				
								0986 594 504 <sup>4</sup>				
								RAB	0986 594 505 <sup>3</sup>			
									0986 594 505 <sup>4</sup>			
		<b>2.0 TFSI</b>	07.06-06.14			147/155	LAB	0986 594 504 <sup>3</sup>				
								0986 594 506 <sup>4</sup>				
								RAB	0986 594 505 <sup>3</sup>			
									0986 594 507 <sup>4</sup>			
	<b>2.0 TFSI quattro</b>	06.08-06.14		147/155	LAB	0986 594 504 <sup>3</sup>						
						0986 594 504 <sup>4</sup>						
						RAB	0986 594 505 <sup>3</sup>					
							0986 594 505 <sup>4</sup>					
	<b>3.2 quattro</b>	07.06-06.10		184	LAB	0986 594 504 <sup>3</sup>						
						0986 594 504 <sup>4</sup>						
						RAB	0986 594 505 <sup>3</sup>					
							0986 594 505 <sup>4</sup>					
	<b>TT Coupé [8N3]</b>											
		<b>1.8 T</b>	07.98-06.06		132		0986 473 923		← 54	F 026 A06 100 <sup>7</sup>		
							0986 473 923		← 54	1987 470 506 <sup>8</sup>		
							0986 473 924		→ 54	F 026 A06 100 <sup>7</sup>		
01.01-08.02			110	0986 473 923				← 54	F 026 A06 100 <sup>7</sup>			
				0986 473 923				← 54	1987 470 506 <sup>8</sup>			
				0986 473 924				→ 54	F 026 A06 100 <sup>7</sup>			
				0986 473 923				← 54	F 026 A06 100 <sup>7</sup>			
09.02-06.06			110	PR-Code 1LD			0986 473 923		← 54	F 026 A06 100 <sup>7</sup>		
							0986 473 923		← 54	1987 470 506 <sup>8</sup>		
							0986 473 924		→ 54	F 026 A06 100 <sup>7</sup>		
				PR-Code 1LT, PR-Code 1LV			0986 473 923		← 54	F 026 A06 100 <sup>7</sup>		
							0986 473 923		← 54	1987 470 506 <sup>8</sup>		
							0986 473 924		→ 54	F 026 A06 100 <sup>7</sup>		
09.05-06.06			120	PR-Code 1LD			0986 473 923		← 54	F 026 A06 100 <sup>7</sup>		
							0986 473 923		← 54	1987 470 506 <sup>8</sup>		
							0986 473 924		→ 54	F 026 A06 100 <sup>7</sup>		



1.8 T	09.05-06.06	120	PR-Code 1LT, PR-Code 1LV	0986 473 923		← 54	F 026 A06 100 <sup>7</sup>			
				0986 473 923		← 54	1 987 470 506 <sup>B</sup>			
				0986 473 924		→ 54	F 026 A06 100 <sup>7</sup>			
1.8 T quattro	07.98-08.02	132	PR-Code 1LT, PR-Code 1LV	0986 473 923		← 54	F 026 A06 100 <sup>7</sup>			
				0986 473 923		← 54	1 987 470 506 <sup>B</sup>			
				0986 473 924		→ 54	F 026 A06 100 <sup>7</sup>			
		165	PR-Code 1LD	0986 473 923		← 54	F 026 A06 100 <sup>7</sup>			
				0986 473 923		← 54	1 987 470 506 <sup>B</sup>			
				0986 473 924		→ 54	F 026 A06 100 <sup>7</sup>			
	09.02-06.06	132	PR-Code 1LD	0986 473 923		← 54	F 026 A06 100 <sup>7</sup>			
				0986 473 923		← 54	1 987 470 506 <sup>B</sup>			
				0986 473 924		→ 54	F 026 A06 100 <sup>7</sup>			
		PR-Code 1LT, PR-Code 1LV	0986 473 923		← 54	F 026 A06 100 <sup>7</sup>				
			0986 473 923		← 54	1 987 470 506 <sup>B</sup>				
			0986 473 924		→ 54	F 026 A06 100 <sup>7</sup>				
		165	PR-Code 1LD	0986 473 923		← 54	F 026 A06 100 <sup>7</sup>			
				0986 473 923		← 54	1 987 470 506 <sup>B</sup>			
				0986 473 924		→ 54	F 026 A06 100 <sup>7</sup>			
PR-Code 1LT, PR-Code 1LV	0986 473 923		← 54	F 026 A06 100 <sup>7</sup>						
	0986 473 923		← 54	1 987 470 506 <sup>B</sup>						
	0986 473 924		→ 54	F 026 A06 100 <sup>7</sup>						
03.05-06.06	180	PR-Code 1LD	0986 473 923		← 54	F 026 A06 100 <sup>7</sup>				
			0986 473 924		→ 54	1 987 470 506 <sup>B</sup>				
	BSR	PR-Code 1LD	0986 473 923		← 54					
			0986 473 924		→ 54					
	BSR	PR-Code 1LT, PR-Code 1LV	0986 473 923		← 54					
			0986 473 924		→ 54					
1.8 T 1.8 T quattro	09.05-06.06	140	PR-Code 1LD	0986 473 923		← 54	F 026 A06 100 <sup>7</sup>			
				0986 473 923		← 54	1 987 470 506 <sup>B</sup>			
				0986 473 924		→ 54	F 026 A06 100 <sup>7</sup>			
				PR-Code 1LT, PR-Code 1LV	0986 473 923		← 54	F 026 A06 100 <sup>7</sup>		
					0986 473 923		← 54	1 987 470 506 <sup>B</sup>		
					0986 473 924		→ 54	F 026 A06 100 <sup>7</sup>		
	07.98-06.99	132	Fg.-Nr. →8N..Y..011 100	0986 473 072		← 38	1 987 470 040 <sup>7</sup>			
				0986 473 072		← 38	1 987 474 496 <sup>B</sup>			
				0986 474 072		→ 38	1 987 470 040 <sup>7</sup>			
				07.99-08.00	132	Fg.-Nr. 8N..Y..011 101→	0986 473 099		← 38,1	1 987 470 040 <sup>7</sup>
							0986 473 099		← 38,1	1 987 474 496 <sup>B</sup>
							0986 474 099		→ 38,1	1 987 470 040 <sup>7</sup>
				11.99-09.00	132	Fg.-Nr. 8N..Y..011 101→	0986 473 099		← 38,1	1 987 470 040 <sup>7</sup>
							0986 473 099		← 38,1	1 987 474 496 <sup>B</sup>
							0986 474 099		→ 38,1	1 987 470 040 <sup>7</sup>
				09.00-09.01	132	Fg.-Nr. →8N..2..012 000	0986 473 099		← 38,1	1 987 470 040 <sup>7</sup>
							0986 473 099		← 38,1	1 987 474 496 <sup>B</sup>
							0986 474 099		→ 38,1	1 987 470 040 <sup>7</sup>
				09.00-06.06	132	Fg.-Nr. 8N..2..012 001→	0986 473 072		← 38	1 987 470 040 <sup>7</sup>
							0986 473 072		← 38	1 987 474 496 <sup>B</sup>
							0986 474 072		→ 38	1 987 470 040 <sup>7</sup>
				01.01-09.01	110	Fg.-Nr. →8N..2..012 000	0986 473 099		← 38,1	1 987 470 040 <sup>7</sup>
							0986 473 099		← 38,1	1 987 474 496 <sup>B</sup>
							0986 474 099		→ 38,1	1 987 470 040 <sup>7</sup>
				10.01-06.06	110	Fg.-Nr. 8N..2..012 001→	0986 473 099		← 38,1	1 987 470 040 <sup>7</sup>
							0986 473 099		← 38,1	1 987 474 496 <sup>B</sup>
							0986 474 099		→ 38,1	1 987 470 040 <sup>7</sup>
					132	Fg.-Nr. 8N..2..012 001→	0986 473 099		← 38,1	1 987 470 040 <sup>7</sup>
							0986 473 099		← 38,1	1 987 474 496 <sup>B</sup>
							0986 474 099		→ 38,1	1 987 470 040 <sup>7</sup>
				09.05-06.06	120	Fg.-Nr. 8N..2..012 001→	0986 473 099		← 38,1	1 987 470 040 <sup>7</sup>
							0986 473 099		← 38,1	1 987 474 496 <sup>B</sup>
							0986 474 099		→ 38,1	1 987 470 040 <sup>7</sup>



<b>◀ AUDI TT Coupé [8N3]</b>															
<b>1.8 T</b>	09.05-06.06	140				0986 473 099		38,1	1987 470 040 <sup>7</sup>						
						0986 473 099		38,1	1987 474 496 <sup>8</sup>						
						0986 474 099		38,1	1987 470 040 <sup>7</sup>						
<b>1.8 T quattro</b>	07.98-05.05	132		PR-Code 1KE		0986 473 029		41	1987 470 040 <sup>7</sup>						
						0986 473 029		41	1987 474 496 <sup>8</sup>						
						0986 474 029		41	1987 470 040 <sup>7</sup>						
						0986 473 139		38,1	1987 470 040 <sup>7</sup>						
						0986 473 139		38,1	1987 474 496 <sup>8</sup>						
						0986 474 139		38,1	1987 470 040 <sup>7</sup>						
	07.98-06.06	165		PR-Code 1KF		0986 473 139		38,1	1987 470 040 <sup>7</sup>						
						0986 473 139		38,1	1987 474 496 <sup>8</sup>						
						0986 474 139		38,1	1987 470 040 <sup>7</sup>						
						0986 473 029		41	1987 470 040 <sup>7</sup>						
						0986 473 029		41	1987 474 496 <sup>8</sup>						
						0986 474 029		41	1987 470 040 <sup>7</sup>						
03.05-06.06	180			PR-Code 1KE	232	0986 473 029		41							
						0986 474 029		41							
						0986 473 139		38,1							
						0986 474 139		38,1							
						0986 473 147		38							
						0986 474 147		38							
						06.05-06.06	132				0986 473 099		38,1	1987 470 040 <sup>7</sup>	
											0986 473 099		38,1	1987 474 496 <sup>8</sup>	
											0986 474 099		38,1	1987 470 040 <sup>7</sup>	
											0986 473 029		41	1987 470 040 <sup>7</sup>	
											0986 473 029		41	1987 474 496 <sup>8</sup>	
											0986 474 029		41	1987 470 040 <sup>7</sup>	
09.05-06.06	140			PR-Code 1KE		0986 473 029		41	1987 470 040 <sup>7</sup>						
						0986 473 029		41	1987 474 496 <sup>8</sup>						
						0986 474 029		41	1987 470 040 <sup>7</sup>						
						0986 473 139		38,1	1987 470 040 <sup>7</sup>						
						0986 473 139		38,1	1987 474 496 <sup>8</sup>						
						0986 474 139		38,1	1987 470 040 <sup>7</sup>						
						<b>3.2 quattro</b>	07.03-06.06	184		PR-Code 1KE		0986 473 029		41	1987 470 040 <sup>7</sup>
												0986 473 029		41	1987 474 496 <sup>8</sup>
												0986 474 029		41	1987 470 040 <sup>7</sup>
												0986 473 139		38,1	1987 470 040 <sup>7</sup>
												0986 473 139		38,1	1987 474 496 <sup>8</sup>
												0986 474 139		38,1	1987 470 040 <sup>7</sup>
				PR-Code 1KF		0986 473 139		38,1	1987 470 040 <sup>7</sup>						
						0986 473 139		38,1	1987 474 496 <sup>8</sup>						
						0986 474 139		38,1	1987 470 040 <sup>7</sup>						
						0986 473 029		41	1987 470 040 <sup>7</sup>						
						0986 473 029		41	1987 474 496 <sup>8</sup>						
						0986 474 139		38,1	1987 470 040 <sup>7</sup>						
	<b>1.8 T</b>	07.98-06.99	132	Fg.-Nr. →8N..Y..011 100		1987 477 255		1617							
		07.99-08.00	132	Fg.-Nr. 8N..Y..011 101→		1987 477 255		1617							
		11.99-06.06	132			1987 477 255		1617							
		01.01-06.06	110			1987 477 255		1617							
		07.98-05.05	132			1987 477 249		1665							
<b>1.8 T quattro</b>	07.98-06.06	165/180			1987 477 249		1665								
	06.05-06.06	132			1987 477 255		1617								
	07.03-06.06	184			1987 477 249		1665								
	<b>1.8 T</b>	07.98-06.06	132/140			0986 594 004 <sup>4</sup>									
		01.01-06.06	110/120			0986 594 004 <sup>4</sup>									
						LAB	0986 594 001 <sup>3</sup>								
						RAB	0986 594 000 <sup>3</sup>								
		<b>1.8 T quattro</b>	07.98-06.06	132/140			0986 594 008 <sup>4</sup>								
				165			0986 594 008 <sup>4</sup>								
						LAB	0986 594 001 <sup>3</sup>								
						RAB	0986 594 000 <sup>3</sup>								
	03.05-06.06		180			0986 594 008 <sup>4</sup>									
						LAB	0986 594 001 <sup>3</sup>								
	<b>1.8 T</b>	07.98-06.06	132/140			LAB	0986 594 001 <sup>3</sup>								
	<b>1.8 T quattro</b>					RAB	0986 594 000 <sup>3</sup>								



		S							
3.2 quattro		07.03-06.06	184				0 986 594 008 <sup>4</sup>		
						LAB	0 986 594 001 <sup>3</sup>		
						RAB	0 986 594 000 <sup>3</sup>		
<b>TT Roadster [FV9]</b>									
	2.0 TFSI quattro	11.14→	169			LAB	0 986 594 524 <sup>4</sup>		
						RAB	0 986 594 525 <sup>4</sup>		
<b>TT Roadster [8J9]</b>									
	1.8 TFSI	06.08-06.14	118	PR-Code 1LJ	312		0 986 473 384		← 53,94
							0 986 474 384		→ 53,94
				PR-Code 1LL	312		0 986 473 384		← 53,94
							0 986 474 384		→ 53,94
				PR-Code 1LM	Y61				F 026 A03 545 <sup>7</sup>
									1 987 470 506 <sup>8</sup>
	2.0 TDI quattro	06.08-06.14	125	PR-Code 1LJ	312		0 986 473 384		← 53,94
							0 986 474 384		→ 53,94
				PR-Code 1LL	312		0 986 473 384		← 53,94
							0 986 474 384		→ 53,94
				PR-Code 1LM	Y61				F 026 A03 545 <sup>7</sup>
									1 987 470 506 <sup>8</sup>
	2.0 TFSI	02.07-06.10	147	PR-Code 1LJ	312		0 986 474 384		→ 53,94
				PR-Code 1LL	312		0 986 474 384		→ 53,94
		03.07-05.09	147	PR-Code 1LJ			0 986 473 384		← 53,94
							0 986 474 384		→ 53,94
									F 026 A06 106 <sup>7</sup>
									1 987 470 506 <sup>8</sup>
	2.0 TFSI Convertible quattro	06.08-06.10	147	PR-Code 1LJ	312		0 986 474 384		→ 53,94
	2.0 TFSI quattro			PR-Code 1LL	312		0 986 474 384		→ 53,94
	2.0 TFSI	02.07-06.10	147	PR-Code 1LJ	312		0 986 473 384		← 53,94
	2.0 TFSI Convertible quattro			PR-Code 1LL	312		0 986 473 384		← 53,94
	2.0 TFSI quattro			PR-Code 1LM	Y61				F 026 A03 545 <sup>7</sup>
									1 987 470 506 <sup>8</sup>
	2.0 TFSI	05.10-06.14	155	PR-Code 1LJ	312		0 986 473 384		← 53,94
	2.0 TFSI quattro						0 986 474 384		→ 53,94
				PR-Code 1LL	312		0 986 473 384		← 53,94
							0 986 474 384		→ 53,94
				PR-Code 1LM	Y61				F 026 A03 545 <sup>7</sup>
									1 987 470 506 <sup>8</sup>
	3.2 quattro	02.07-06.10	184	PR-Code 1LK			0 986 134 287		←
							0 986 134 287		←
				PR-Code 1LM					F 026 A06 106 <sup>7</sup>
									1 987 470 506 <sup>8</sup>
				PR-Code 1LN			0 986 134 287		←
							0 986 134 287		←
							0 986 135 287		→
									F 026 A03 545 <sup>7</sup>
		09.07-08.09	184				0 986 134 287		←
							0 986 134 287		←
									F 026 A03 545 <sup>7</sup>
									1 987 470 506 <sup>8</sup>
	1.8 TFSI	06.08-06.14	118	PR-Code 1KZ			0 986 134 048		← 38
							0 986 135 048		→ 38
				PR-Code 1KZ, PR-Code 2ED					1 987 470 040 <sup>7</sup>
				PR-Code 2ED			0 986 134 048		← 38
							0 986 135 048		→ 38
									1 987 474 496 <sup>8</sup>
	2.0 TDI quattro	06.08-06.14	125	PR-Code 1KJ			0 986 473 448		← 41
							0 986 474 448		→ 41



<b>AUDI TT Roadster [8J9]</b>												
	2.0 TFSI	02.07-06.10	147	PR-Code 1KZ		0986 134 048		← 38				
						0986 135 048		→ 38				
						PR-Code 1KZ, PR-Code 2ED			1987 470 040 <sup>7</sup>			
						PR-Code 2ED	0986 134 048		← 38	1987 474 496 <sup>8</sup>		
							0986 135 048		→ 38	1987 474 496 <sup>8</sup>		
		03.07-05.09		147	PR-Code 1KZ	0986 134 048		← 38	1987 470 040 <sup>7</sup>			
					0986 135 048		→ 38	1987 470 040 <sup>7</sup>				
	05.10-06.14		155	PR-Code 1KZ	0986 134 048		← 38					
					0986 135 048		→ 38					
					PR-Code 1KZ, PR-Code 2ED				1987 470 040 <sup>7</sup>			
					PR-Code 2ED	0986 134 048		← 38	1987 474 496 <sup>8</sup>			
					0986 135 048		→ 38	1987 474 496 <sup>8</sup>				
2.0 TFSI Convertible quattro		06.08-06.10	147	PR-Code 1KJ	0986 473 448		← 41					
2.0 TFSI quattro					0986 474 448		→ 41					
2.0 TFSI quattro		05.10-06.14	155	PR-Code 1KJ	0986 473 448		← 41					
					0986 474 448		→ 41					
3.2 quattro		02.07-06.10	184	PR-Code 2EA	0986 134 297		←	1987 474 496 <sup>8</sup>				
					0986 135 297		→	1987 474 496 <sup>8</sup>				
					PR-Code 2EF				1987 474 496 <sup>8</sup>			
<b>TT Roadster [8N9]</b>												
	1.8 TFSI	06.08-06.14	118		LAB	0986 594 504 <sup>3</sup>						
						0986 594 506 <sup>4</sup>						
						RAB	0986 594 505 <sup>3</sup>					
							0986 594 507 <sup>4</sup>					
	2.0 TDI quattro		06.08-06.14	125		LAB	0986 594 504 <sup>3</sup>					
							0986 594 504 <sup>4</sup>					
							RAB	0986 594 505 <sup>3</sup>				
						0986 594 505 <sup>4</sup>						
	2.0 TFSI		02.07-06.14	147/155		LAB	0986 594 504 <sup>3</sup>					
							0986 594 506 <sup>4</sup>					
							RAB	0986 594 505 <sup>3</sup>				
						0986 594 507 <sup>4</sup>						
	2.0 TFSI Convertible quattro		06.08-06.10	147/155		LAB	0986 594 504 <sup>3</sup>					
							0986 594 504 <sup>4</sup>					
							RAB	0986 594 505 <sup>3</sup>				
						0986 594 505 <sup>4</sup>						
	2.0 TFSI quattro		06.08-06.14	147/155		LAB	0986 594 504 <sup>3</sup>					
							0986 594 504 <sup>4</sup>					
							RAB	0986 594 505 <sup>3</sup>				
						0986 594 505 <sup>4</sup>						
	3.2 quattro		02.07-06.10	184		LAB	0986 594 504 <sup>3</sup>					
							0986 594 504 <sup>4</sup>					
							RAB	0986 594 505 <sup>3</sup>				
						0986 594 505 <sup>4</sup>						
<b>TT Roadster [8N9]</b>												
	1.8 T	04.99-08.02	132			0986 473 923		← 54	1987 470 506 <sup>8</sup>			
						01.01-08.02	110	0986 473 923		← 54	F 026 A06 100 <sup>7</sup>	
									0986 473 923		← 54	1987 470 506 <sup>8</sup>
									0986 473 924		→ 54	F 026 A06 100 <sup>7</sup>
		09.02-06.06		110		PR-Code 1LD	0986 473 923		← 54	F 026 A06 100 <sup>7</sup>		
							0986 473 923		← 54	1987 470 506 <sup>8</sup>		
							0986 473 924		→ 54	F 026 A06 100 <sup>7</sup>		
							PR-Code 1LT, PR-Code 1LV	0986 473 923		← 54	F 026 A06 100 <sup>7</sup>	
							0986 473 923		← 54	1987 470 506 <sup>8</sup>		
							0986 473 924		→ 54	F 026 A06 100 <sup>7</sup>		
							0986 473 923		← 54	1987 470 506 <sup>8</sup>		
							0986 473 924		→ 54	F 026 A06 100 <sup>7</sup>		
		132	PR-Code 1LD	0986 473 923		← 54	1987 470 506 <sup>8</sup>					
			PR-Code 1LT, PR-Code 1LV	0986 473 923		← 54	1987 470 506 <sup>8</sup>					





































		S									
<b>1.8 T</b>	09.05-06.06	120	PR-Code 1LD	0986 473 923		54	F 026	A06	100 <sup>7</sup>		
				0986 473 923		54		1987 470 506 <sup>B</sup>			
				0986 473 924		54		F 026	A06	100 <sup>7</sup>	
				0986 473 923		54		F 026	A06	100 <sup>7</sup>	
				0986 473 923		54		1987 470 506 <sup>B</sup>			
				0986 473 924		54		F 026	A06	100 <sup>7</sup>	
<b>1.8 T quattro</b>	03.99-05.06	165		0986 473 923		54	F 026	A06	100 <sup>7</sup>		
				0986 473 923		54		1987 470 506 <sup>B</sup>			
				0986 473 924		54		F 026	A06	100 <sup>7</sup>	
	07.99-08.02	132			0986 473 923		54	1987 470 506 <sup>B</sup>			
					0986 473 923		54		1987 470 506 <sup>B</sup>		
	09.02-05.05	132		PR-Code 1LD	0986 473 923		54	1987 470 506 <sup>B</sup>			
					0986 473 923		54		1987 470 506 <sup>B</sup>		
	09.02-06.06	165		PR-Code 1LD	0986 473 923		54	F 026	A06	100 <sup>7</sup>	
					0986 473 923		54		1987 470 506 <sup>B</sup>		
					0986 473 924		54		F 026	A06	100 <sup>7</sup>
					0986 473 923		54		F 026	A06	100 <sup>7</sup>
					0986 473 923		54		1987 470 506 <sup>B</sup>		
					0986 473 924		54		F 026	A06	100 <sup>7</sup>
	06.05-06.06	132						F 026	A06	100 <sup>7</sup>	
							1987 470 506 <sup>B</sup>				
PR-Code 1LD					BSR	0986 473 923			54		
						0986 473 924			54		
PR-Code 1LT, PR-Code 1LV					BSR	0986 473 923			54		
						0986 473 924			54		
<b>1.8 T</b>	04.99-08.02	132		0986 473 923		54	F 026	A06	100 <sup>7</sup>		
				0986 473 924		54		1987 470 506 <sup>B</sup>			
<b>1.8 T quattro</b>	09.02-06.06	132	PR-Code 1LD	0986 473 923		54	F 026	A06	100 <sup>7</sup>		
				0986 473 924		54		1987 470 506 <sup>B</sup>			
				PR-Code 1LT, PR-Code 1LV	0986 473 923		54	F 026	A06	100 <sup>7</sup>	
					0986 473 924		54		1987 470 506 <sup>B</sup>		
	09.05-06.06	140		PR-Code 1LD	0986 473 923		54	F 026	A06	100 <sup>7</sup>	
					0986 473 923		54		1987 470 506 <sup>B</sup>		
					0986 473 924		54		F 026	A06	100 <sup>7</sup>
					0986 473 923		54		F 026	A06	100 <sup>7</sup>
				PR-Code 1LT, PR-Code 1LV	0986 473 923		54	F 026	A06	100 <sup>7</sup>	
					0986 473 923		54		1987 470 506 <sup>B</sup>		
0986 473 924						54	F 026		A06	100 <sup>7</sup>	
0986 473 924						54	F 026		A06	100 <sup>7</sup>	
<b>1.8 T</b>	04.99-06.99	132	Fg.-Nr. →8N..Y..011 100	0986 473 072		38	1987 470 040 <sup>7</sup>				
				0986 473 072		38		1987 474 496 <sup>B</sup>			
				0986 474 072		38		1987 470 040 <sup>7</sup>			
	07.99-08.00	132	Fg.-Nr. 8N..Y..011 101→	0986 473 099		38,1	1987 470 040 <sup>7</sup>				
				0986 473 099		38,1		1987 474 496 <sup>B</sup>			
				0986 474 099		38,1		1987 470 040 <sup>7</sup>			
				0986 473 099		38,1		1987 470 040 <sup>7</sup>			
	09.99-10.01	132		0986 473 099		38,1	1987 470 040 <sup>7</sup>				
				0986 473 099		38,1		1987 474 496 <sup>B</sup>			
				0986 474 099		38,1		1987 470 040 <sup>7</sup>			
	09.00-08.02	132		0986 473 072		38	1987 470 040 <sup>7</sup>				
				0986 473 072		38		1987 474 496 <sup>B</sup>			
				0986 474 072		38		1987 470 040 <sup>7</sup>			
	01.01-09.01	110	Fg.-Nr. →8N..2..012 000	0986 473 099		38,1	1987 470 040 <sup>7</sup>				
				0986 473 099		38,1		1987 474 496 <sup>B</sup>			
				0986 474 099		38,1		1987 470 040 <sup>7</sup>			
				0986 473 099		38,1		1987 470 040 <sup>7</sup>			
	10.01-06.06	110	Fg.-Nr. 8N..2..012 001→	0986 473 099		38,1	1987 470 040 <sup>7</sup>				
				0986 473 099		38,1		1987 474 496 <sup>B</sup>			
				0986 474 099		38,1		1987 470 040 <sup>7</sup>			
		132	Fg.-Nr. 8N..2..012 001→	0986 473 099		38,1	1987 470 040 <sup>7</sup>				
				0986 473 099		38,1		1987 474 496 <sup>B</sup>			
				0986 474 099		38,1		1987 470 040 <sup>7</sup>			
	09.05-06.06	120		0986 473 099		38,1	1987 470 040 <sup>7</sup>				
0986 473 099					38,1	1987 474 496 <sup>B</sup>					
0986 474 099					38,1	1987 470 040 <sup>7</sup>					





			S										
◀ AUDI TT Roadster [8N9]													
	1.8 T	09.05-06.06	140			0986 473 099		← 38,1	1987 470 040 <sup>7</sup>				
				0986 473 099		← 38,1	1987 474 496 <sup>8</sup>						
				0986 474 099		→ 38,1	1987 470 040 <sup>7</sup>						
	1.8 T quattro	03.99-06.06	165	PR-Code 1KE			0986 473 029		← 41	1987 470 040 <sup>7</sup>			
					0986 473 029		← 41	1987 474 496 <sup>8</sup>					
					0986 474 029		→ 41	1987 470 040 <sup>7</sup>					
							0986 473 139		← 38,1	1987 470 040 <sup>7</sup>			
							0986 473 139		← 38,1	1987 474 496 <sup>8</sup>			
							0986 474 139		→ 38,1	1987 470 040 <sup>7</sup>			
		07.99-05.05	132	PR-Code 1KE			0986 473 029		← 41	1987 470 040 <sup>7</sup>			
							0986 473 029		← 41	1987 474 496 <sup>8</sup>			
							0986 474 029		→ 41	1987 470 040 <sup>7</sup>			
					0986 473 139		← 38,1	1987 470 040 <sup>7</sup>					
					0986 473 139		← 38,1	1987 474 496 <sup>8</sup>					
					0986 474 139		→ 38,1	1987 470 040 <sup>7</sup>					
06.05-06.06	132	PR-Code 1KE	232			0986 473 029		← 41					
					0986 474 029		→ 41						
			PR-Code 1KF	252,BSR			0986 473 139		← 38,1				
						0986 474 139		→ 38,1					
			PR-Code 2EH	252,BSR			0986 473 147		← 38				
							0986 474 147		→ 38				
09.05-06.06	140	PR-Code 1KE			0986 473 029		← 41	1987 470 040 <sup>7</sup>					
					0986 473 029		← 41	1987 474 496 <sup>8</sup>					
					0986 474 029		→ 41	1987 470 040 <sup>7</sup>					
					0986 473 139		← 38,1	1987 470 040 <sup>7</sup>					
					0986 473 139		← 38,1	1987 474 496 <sup>8</sup>					
					0986 474 139		→ 38,1	1987 470 040 <sup>7</sup>					
3.2 quattro	07.03-06.06	184	PR-Code 1KE			0986 473 029		← 41	1987 470 040 <sup>7</sup>				
						0986 473 029		← 41	1987 474 496 <sup>8</sup>				
						0986 474 029		→ 41	1987 470 040 <sup>7</sup>				
						0986 473 139		← 38,1	1987 470 040 <sup>7</sup>				
						0986 473 139		← 38,1	1987 474 496 <sup>8</sup>				
						0986 474 139		→ 38,1	1987 470 040 <sup>7</sup>				
	1.8 T	04.99-06.99	132	Fg.-Nr. →8N..Y..011 100			1987 477 255		1617				
					07.99-08.00	132	Fg.-Nr. 8N..Y..011 101→			1987 477 255		↔ 1617	
										1987 477 255		↔ 1617	
										1987 477 255		↔ 1617	
										1987 477 255		↔ 1617	
					01.01-06.06	110			1987 477 255		↔ 1617		
		1987 477 249		↔ 1665									
03.99-06.06	165			1987 477 249		↔ 1665							
				1987 477 249		↔ 1665							
07.99-06.06	132			1987 477 249		↔ 1665							
				1987 477 249		↔ 1665							
07.03-06.06	184			1987 477 249		↔ 1665							
				1987 477 249		↔ 1665							
	1.8 T	04.99-06.06	132/140			0986 594 004 <sup>4</sup>							
				01.01-06.06	110/120			0986 594 004 <sup>4</sup>					
								LAB	0986 594 001 <sup>3</sup>				
								RAB	0986 594 000 <sup>3</sup>				
									0986 594 008 <sup>4</sup>				
				03.99-06.06	165			LAB	0986 594 001 <sup>3</sup>				
			RAB			0986 594 000 <sup>3</sup>							
	07.99-06.06	132/140			0986 594 008 <sup>4</sup>								
					LAB	0986 594 001 <sup>3</sup>							
	04.99-06.06	132/140			LAB	0986 594 001 <sup>3</sup>							
					RAB	0986 594 000 <sup>3</sup>							
	07.03-06.06	184			0986 594 008 <sup>4</sup>								
			LAB	0986 594 001 <sup>3</sup>									
				RAB	0986 594 000 <sup>3</sup>								



		S							
<b>TT RS Coupé [8J3]</b>									
									
	2.5 TFSI quattro	07.09-06.14	250/265			LAB	0 986 594 504 <sup>3</sup>		
							0 986 594 504 <sup>4</sup>		
						RAB	0 986 594 505 <sup>3</sup>		
							0 986 594 507 <sup>4</sup>		
<b>TT RS Roadster [8J9]</b>									
									
	2.5 TFSI quattro	07.09-06.14	250/265			LAB	0 986 594 504 <sup>3</sup>		
							0 986 594 504 <sup>4</sup>		
						RAB	0 986 594 505 <sup>3</sup>		
							0 986 594 507 <sup>4</sup>		
<b>TTS Coupé [FV3]</b>									
									
	2.0 TFSI quattro	11.14→	228			LAB	0 986 594 524 <sup>4</sup>		
						RAB	0 986 594 525 <sup>4</sup>		
<b>TTS Coupé [8J3]</b>									
									
	2.0 TFSI quattro	05.08-06.14	195/200				0 986 134 287	 ←	F 026 A03 545 <sup>7</sup>
							0 986 134 287	 ←	1 987 470 506 <sup>8</sup>
							0 986 135 287	 →	F 026 A03 545 <sup>7</sup>
									
	2.0 TFSI quattro	05.08-06.14	195/200			LAB	0 986 594 504 <sup>3</sup>		
							0 986 594 504 <sup>4</sup>		
						RAB	0 986 594 505 <sup>3</sup>		
							0 986 594 505 <sup>4</sup>		
<b>TTS Roadster [FV9]</b>									
									
	2.0 TFSI quattro	02.15→	228			LAB	0 986 594 524 <sup>4</sup>		
						RAB	0 986 594 525 <sup>4</sup>		
<b>TTS Roadster [8J9]</b>									
									
	2.0 TFSI quattro	05.08-06.14	195/200				0 986 134 287	 ←	F 026 A03 545 <sup>7</sup>
							0 986 134 287	 ←	1 987 470 506 <sup>8</sup>
							0 986 135 287	 →	F 026 A03 545 <sup>7</sup>
									
	2.0 TFSI quattro	05.08-06.14	195/200			LAB	0 986 594 504 <sup>3</sup>		
							0 986 594 504 <sup>4</sup>		
						RAB	0 986 594 505 <sup>3</sup>		
							0 986 594 505 <sup>4</sup>		
<b>80 Avant [8C5; B4]</b>									
									
	1.6	06.93-07.95	74				0 986 474 712	 ← 54	1 987 470 287 <sup>7</sup>
							0 986 473 712	 → 54	1 987 470 287 <sup>7</sup>



		S								
	◀ AUDI 80 Avant [8C5; B4]									
1.9 TD	07.93-07.95	55	AG	0986 474 712		54	1987 470 287 <sup>7</sup>			
				0986 473 712		54	1987 470 287 <sup>7</sup>			
			GS	0986 473 808		54	1987 470 287 <sup>7</sup>			
				0986 473 809		54	1987 470 287 <sup>7</sup>			
1.9 TDI	08.92-07.95	66	TA	0986 473 808		54	1987 470 287 <sup>7</sup>			
				0986 473 809		54	1987 470 287 <sup>7</sup>			
			TA	0986 474 712		54	1987 470 287 <sup>7</sup>			
				0986 473 712		54	1987 470 287 <sup>7</sup>			
2.0	08.92-06.95	66	AG	0986 474 712		54	1987 470 287 <sup>7</sup>			
				0986 473 712		54	1987 470 287 <sup>7</sup>			
			GS	0986 473 808		54	1987 470 287 <sup>7</sup>			
				0986 473 809		54	1987 470 287 <sup>7</sup>			
	08.92-07.95	103		0986 474 712		54	1987 470 287 <sup>7</sup>			
				0986 473 712		54	1987 470 287 <sup>7</sup>			
2.0 E	08.92-07.95	79/85		0986 474 712		54	1987 470 287 <sup>7</sup>			
2.0 quattro				0986 473 712		54	1987 470 287 <sup>7</sup>			
2.0 quattro	07.94-07.95	103					1987 470 023 <sup>7</sup>			
			228	0986 474 712		54	1987 470 287 <sup>7</sup>			
				0986 473 712		54	1987 470 287 <sup>7</sup>			
2.2 S2 quattro	07.94-07.95	169					1987 470 023 <sup>7</sup>			
2.3 E	08.92-11.94	98		0986 474 712		54	1987 470 287 <sup>7</sup>			
				0986 473 712		54	1987 470 287 <sup>7</sup>			
2.3 quattro	08.92-11.94	98	228	0986 474 712		54	1987 470 287 <sup>7</sup>			
				0986 473 712		54	1987 470 287 <sup>7</sup>			
2.6 E	08.92-05.95	110		0986 474 712		54	1987 470 287 <sup>7</sup>			
				0986 473 712		54	1987 470 287 <sup>7</sup>			
2.6 E	05.93-05.95	102		0986 474 712		54	1987 470 287 <sup>7</sup>			
				0986 473 712		54	1987 470 287 <sup>7</sup>			
2.6 quattro	08.92-07.95	110	228	0986 474 712		54	1987 470 287 <sup>7</sup>			
				0986 473 712		54	1987 470 287 <sup>7</sup>			
2.8 E, quattro	08.92-07.95	128					1987 470 023 <sup>7</sup>			
	1.9 TDI	08.92-07.95	66				0986 475 039		20,64	
	2.0	08.92-06.95	66				0986 475 039		20,64	
	1.6	06.93-07.95	74				0986 473 854		38	1987 470 040 <sup>7</sup>
							0986 473 855		38	1987 470 040 <sup>7</sup>
1.9 TD	08.92-07.95	55/66					0986 473 854		38	1987 470 040 <sup>7</sup>
							0986 473 855		38	1987 470 040 <sup>7</sup>
1.9 TDI	08.92-06.95	66					0986 473 854		38	1987 470 040 <sup>7</sup>
							0986 473 855		38	1987 470 040 <sup>7</sup>
2.0	08.92-06.95	66					0986 473 854		38	1987 470 040 <sup>7</sup>
							0986 473 855		38	1987 470 040 <sup>7</sup>
	08.92-07.95	103					0986 473 854		38	1987 470 040 <sup>7</sup>
							0986 473 855		38	1987 470 040 <sup>7</sup>
2.0 E	08.92-07.95	85					0986 473 854		38	1987 470 040 <sup>7</sup>
							0986 473 855		38	1987 470 040 <sup>7</sup>
	11.93-06.95	79					0986 473 854		38	1987 470 040 <sup>7</sup>
							0986 473 855		38	1987 470 040 <sup>7</sup>
2.0 quattro	11.93-07.95	79					0986 473 442		38	1987 470 040 <sup>7</sup>
							0986 474 442		38	1987 470 040 <sup>7</sup>
	07.94-07.95	103					0986 473 442		38	1987 470 040 <sup>7</sup>
							0986 474 442		38	1987 470 040 <sup>7</sup>
2.2 S2 quattro	07.94-07.95	169					0986 473 442		38	1987 470 040 <sup>7</sup>
							0986 474 442		38	1987 470 040 <sup>7</sup>
2.3 E	08.92-11.94	98					0986 473 854		38	1987 470 040 <sup>7</sup>
							0986 473 855		38	1987 470 040 <sup>7</sup>
2.3 quattro	08.92-11.94	98					0986 473 442		38	1987 470 040 <sup>7</sup>
							0986 474 442		38	1987 470 040 <sup>7</sup>
2.6 E	08.92-05.95	102/110					0986 473 854		38	1987 470 040 <sup>7</sup>
							0986 473 855		38	1987 470 040 <sup>7</sup>

















		S								
2.6 quattro		08.92-07.95	102/110				0 986 473 442		38	1 987 470 040 <sup>7</sup>
							0 986 474 442		38	1 987 470 040 <sup>7</sup>
2.8 E		08.92-05.95	128				0 986 473 854		38	1 987 470 040 <sup>7</sup>
							0 986 473 855		38	1 987 470 040 <sup>7</sup>
2.8 quattro		08.92-07.95	128				0 986 473 442		38	1 987 470 040 <sup>7</sup>
							0 986 474 442		38	1 987 470 040 <sup>7</sup>
<hr/>										
	1.6	06.93-07.95	74				1 987 482 268		1723	
							1 987 482 269		1723	
	1.9 TD	07.93-07.95	55				1 987 482 268		1723	
							1 987 482 269		1723	
	1.9 TDI	05.93-07.95	66		Fg.-Nr. 8C..P..235 316→		1 987 482 268		1723	
							1 987 482 269		1723	
	2.0	05.93-06.95	66		Fg.-Nr. 8C..P..235 316→		1 987 482 268		1723	
							1 987 482 269		1723	
	2.0	05.93-07.95	85/103		Fg.-Nr. 8C..P..235 316→		1 987 482 268		1723	
	2.0 E						1 987 482 269		1723	
	2.0 E	11.93-06.95	79				1 987 482 268		1723	
							1 987 482 269		1723	
	2.3 E	05.93-11.94	98		Fg.-Nr. 8C..P..235 316→		1 987 482 268		1723	
							1 987 482 269		1723	
	2.6 E	05.93-05.95	102				1 987 482 268		1723	
							1 987 482 269		1723	
			110		Fg.-Nr. 8C..P..235 316→		1 987 482 268		1723	
							1 987 482 269		1723	
	2.8 E	05.93-05.95	128		Fg.-Nr. 8C..P..235 316→		1 987 482 268		1723	
							1 987 482 269		1723	
<hr/>										
<b>80 [8C2; B4]</b>										
	1.6	01.92-08.94	52			AG	0 986 474 712		54	1 987 470 287 <sup>7</sup>
							0 986 473 712		54	1 987 470 287 <sup>7</sup>
		08.92-08.94	52		Fg.-Nr. 8C..P..000 001→	GS	0 986 473 808		54	1 987 470 287 <sup>7</sup>
							0 986 473 809		54	1 987 470 287 <sup>7</sup>
		06.93-05.95	74				0 986 474 712		54	1 987 470 287 <sup>7</sup>
							0 986 473 712		54	1 987 470 287 <sup>7</sup>
	1.9 TD	09.91-05.95	55			AG	0 986 474 712		54	1 987 470 287 <sup>7</sup>
							0 986 473 712		54	1 987 470 287 <sup>7</sup>
		08.92-05.95	55		Fg.-Nr. 8C..P..000 001→	GS	0 986 473 808		54	1 987 470 287 <sup>7</sup>
							0 986 473 809		54	1 987 470 287 <sup>7</sup>
	1.9 TDI	09.91-05.95	66			TA	0 986 474 712		54	1 987 470 287 <sup>7</sup>
							0 986 473 712		54	1 987 470 287 <sup>7</sup>
		08.92-05.95	66		Fg.-Nr. 8C..P..000 001→	TA	0 986 473 808		54	1 987 470 287 <sup>7</sup>
							0 986 473 809		54	1 987 470 287 <sup>7</sup>
	2.0	09.91-05.95	66			AG	0 986 474 712		54	1 987 470 287 <sup>7</sup>
							0 986 473 712		54	1 987 470 287 <sup>7</sup>
		08.92-05.95	66		Fg.-Nr. 8C..P..000 001→	GS	0 986 473 808		54	1 987 470 287 <sup>7</sup>
							0 986 473 809		54	1 987 470 287 <sup>7</sup>
			103				0 986 474 712		54	1 987 470 287 <sup>7</sup>
							0 986 473 712		54	1 987 470 287 <sup>7</sup>
	2.0 E	09.91-05.95	85				0 986 474 712		54	1 987 470 287 <sup>7</sup>
							0 986 473 712		54	1 987 470 287 <sup>7</sup>
	2.0 E	11.93-05.95	79				0 986 474 712		54	1 987 470 287 <sup>7</sup>
	2.0 quattro						0 986 473 712		54	1 987 470 287 <sup>7</sup>
	2.0 quattro	09.91-12.94	85							1 987 470 023 <sup>7</sup>
						228,252	0 986 474 712		54	1 987 470 287 <sup>7</sup>
							0 986 473 712		54	1 987 470 287 <sup>7</sup>
		08.92-05.95	103							1 987 470 023 <sup>7</sup>
						228	0 986 474 712		54	1 987 470 287 <sup>7</sup>
							0 986 473 712		54	1 987 470 287 <sup>7</sup>



		S							
	<b>◀ AUDI 80 [8C2; B4]</b>								
	2.2 S2 quattro	02.93-05.95	169						1987 470 023 <sup>7</sup>
	2.3	09.90-11.94	98				0986 474 712	← 54	1987 470 287 <sup>7</sup>
							0986 473 712	→ 54	1987 470 287 <sup>7</sup>
	2.3 quattro	09.91-11.94	98						1987 470 023 <sup>7</sup>
					228		0986 474 712	← 54	1987 470 287 <sup>7</sup>
							0986 473 712	→ 54	1987 470 287 <sup>7</sup>
	2.6 E	07.92-05.95	110				0986 474 712	← 54	1987 470 287 <sup>7</sup>
							0986 473 712	→ 54	1987 470 287 <sup>7</sup>
	2.6 E	05.93-05.95	102				0986 474 712	← 54	1987 470 287 <sup>7</sup>
	2.6 quattro						0986 473 712	→ 54	1987 470 287 <sup>7</sup>
	2.6 quattro	07.92-05.95	110						1987 470 023 <sup>7</sup>
					228		0986 474 712	← 54	1987 470 287 <sup>7</sup>
							0986 473 712	→ 54	1987 470 287 <sup>7</sup>
	2.8 E, quattro	09.91-05.95	128						1987 470 023 <sup>7</sup>
	1.6	01.92-08.94	52				0986 475 260	↔ 17,46	
	1.9 TD	09.91-05.95	55				0986 475 260	↔ 17,46	
	1.9 TDI	08.92-05.95	66		Fg.-Nr. 8C..P..000 001→		0986 475 039	↔ 20,64	
	2.0	08.92-05.95	66		Fg.-Nr. 8C..P..000 001→		0986 475 039	↔ 20,64	
	1.6	01.92-05.95	52/74				0986 473 854	← 38	1987 470 040 <sup>7</sup>
							0986 473 855	→ 38	1987 470 040 <sup>7</sup>
	1.9 TD	09.91-05.95	55/66				0986 473 854	← 38	1987 470 040 <sup>7</sup>
	1.9 TDI						0986 473 855	→ 38	1987 470 040 <sup>7</sup>
	2.0	09.91-05.95	66				0986 473 854	← 38	1987 470 040 <sup>7</sup>
							0986 473 855	→ 38	1987 470 040 <sup>7</sup>
	2.0	09.91-05.95	79/85/103				0986 473 854	← 38	1987 470 040 <sup>7</sup>
	2.0 E						0986 473 855	→ 38	1987 470 040 <sup>7</sup>
	2.0 quattro	09.91-05.95	79/85/103				0986 473 442	← 38	1987 470 040 <sup>7</sup>
							0986 474 442	→ 38	1987 470 040 <sup>7</sup>
	2.2 S2 quattro	02.93-05.95	169				0986 473 442	← 38	1987 470 040 <sup>7</sup>
							0986 474 442	→ 38	1987 470 040 <sup>7</sup>
	2.3	09.90-11.94	98				0986 473 854	← 38	1987 470 040 <sup>7</sup>
							0986 473 855	→ 38	1987 470 040 <sup>7</sup>
	2.3 quattro	09.91-11.94	98				0986 473 442	← 38	1987 470 040 <sup>7</sup>
							0986 474 442	→ 38	1987 470 040 <sup>7</sup>
	2.6 E	07.92-05.95	102/110				0986 473 854	← 38	1987 470 040 <sup>7</sup>
							0986 473 855	→ 38	1987 470 040 <sup>7</sup>
	2.6 quattro	07.92-05.95	102/110				0986 473 442	← 38	1987 470 040 <sup>7</sup>
							0986 474 442	→ 38	1987 470 040 <sup>7</sup>
	2.8 E	09.91-05.95	128				0986 473 854	← 38	1987 470 040 <sup>7</sup>
							0986 473 855	→ 38	1987 470 040 <sup>7</sup>
	2.8 quattro	09.91-05.95	128				0986 473 442	← 38	1987 470 040 <sup>7</sup>
							0986 474 442	→ 38	1987 470 040 <sup>7</sup>
	1.6	05.93-08.94	52		Fg.-Nr. 8C..P..235 316→		1987 482 268	← 1723	
							1987 482 269	→ 1723	
		06.93-05.95	74				1987 482 268	← 1723	
							1987 482 269	→ 1723	
	1.9 TD	05.93-05.95	55/66		Fg.-Nr. 8C..P..235 316→		1987 482 268	← 1723	
	1.9 TDI						1987 482 269	→ 1723	
	2.0	05.93-05.95	66		Fg.-Nr. 8C..P..235 316→		1987 482 268	← 1723	
							1987 482 269	→ 1723	
	2.0	05.93-05.95	85/103		Fg.-Nr. 8C..P..235 316→		1987 482 268	← 1723	
	2.0 E						1987 482 269	→ 1723	
	2.0 E	07.94-05.95	79				1987 482 268	← 1723	
							1987 482 269	→ 1723	
	2.3	05.93-11.94	98		Fg.-Nr. 8C..P..235 316→		1987 482 268	← 1723	
							1987 482 269	→ 1723	



		S							
2.6E		05.93-05.95	102				1 987 482 268	← 1723	
			110	Fg.-Nr. 8C..P..235 316→			1 987 482 269	→ 1723	
							1 987 482 268	← 1723	
							1 987 482 269	→ 1723	
2.8E		05.93-05.95	128	Fg.-Nr. 8C..P..235 316→			1 987 482 268	← 1723	
							1 987 482 269	→ 1723	
<b>100 Avant [4A5; C4]</b>									
									
	2.0	07.92-07.94	79/85/103				0 986 473 929	← 57	1 987 470 005 <sup>7</sup>
							0 986 473 929	← 57	1 987 470 506 <sup>B</sup>
							0 986 473 930	→ 57	1 987 470 005 <sup>7</sup>
	2.3	12.90-07.94	98				0 986 473 929	← 57	1 987 470 005 <sup>7</sup>
	2.3 quattro						0 986 473 929	← 57	1 987 470 506 <sup>B</sup>
							0 986 473 930	→ 57	1 987 470 005 <sup>7</sup>
	2.4D	08.91-07.94	60				0 986 473 929	← 57	1 987 470 005 <sup>7</sup>
							0 986 473 929	← 57	1 987 470 506 <sup>B</sup>
							0 986 473 930	→ 57	1 987 470 005 <sup>7</sup>
	2.5 TDI	08.91-07.94	85				0 986 473 929	← 57	1 987 470 005 <sup>7</sup>
							0 986 473 929	← 57	1 987 470 506 <sup>B</sup>
							0 986 473 930	→ 57	1 987 470 005 <sup>7</sup>
	2.6	03.92-07.94	102/110				0 986 474 882	← 57	1 987 470 005 <sup>7</sup>
	2.6 quattro						0 986 474 882	← 57	1 987 470 506 <sup>B</sup>
							0 986 474 884	→ 57	1 987 470 005 <sup>7</sup>
	2.8	12.90-07.94	125-128				0 986 474 882	← 57	1 987 470 005 <sup>7</sup>
	2.8 quattro						0 986 474 882	← 57	1 987 470 506 <sup>B</sup>
							0 986 474 884	→ 57	1 987 470 005 <sup>7</sup>
									
	2.0	01.93-07.94	85				0 986 475 039	↔ 20,64	
	2.4D	08.91-07.94	60				0 986 475 039	↔ 20,64	
	2.0	04.93-07.94	85/103	Fg.-Nr. 4A..P..078 949→			0 986 473 695	← 38	1 987 470 040 <sup>7</sup>
							0 986 474 695	→ 38	1 987 470 040 <sup>7</sup>
		12.93-07.94	79				0 986 473 695	← 38	1 987 470 040 <sup>7</sup>
							0 986 474 695	→ 38	1 987 470 040 <sup>7</sup>
	2.3	04.93-07.94	98	Fg.-Nr. 4A..P..078 949→			0 986 473 695	← 38	1 987 470 040 <sup>7</sup>
							0 986 474 695	→ 38	1 987 470 040 <sup>7</sup>
	2.3 quattro	12.90-07.94	98				0 986 474 698	← 38	1 987 470 040 <sup>7</sup>
							0 986 473 698	→ 38	1 987 470 040 <sup>7</sup>
	2.5 TDI	04.93-07.94	85	Fg.-Nr. 4A..P..078 949→			0 986 473 695	← 38	1 987 470 040 <sup>7</sup>
							0 986 474 695	→ 38	1 987 470 040 <sup>7</sup>
	2.6	04.93-07.94	110	Fg.-Nr. 4A..P..078 949→			0 986 473 695	← 38	1 987 470 040 <sup>7</sup>
							0 986 474 695	→ 38	1 987 470 040 <sup>7</sup>
		07.93-07.94	102				0 986 473 695	← 38	1 987 470 040 <sup>7</sup>
							0 986 474 695	→ 38	1 987 470 040 <sup>7</sup>
	2.6 quattro	03.92-07.94	110				0 986 474 698	← 38	1 987 470 040 <sup>7</sup>
							0 986 473 698	→ 38	1 987 470 040 <sup>7</sup>
	2.8	04.93-07.94	125-128	Fg.-Nr. 4A..P..078 949→			0 986 473 695	← 38	1 987 470 040 <sup>7</sup>
							0 986 474 695	→ 38	1 987 470 040 <sup>7</sup>
	2.8 quattro	12.90-07.94	128				0 986 474 698	← 38	1 987 470 040 <sup>7</sup>
							0 986 473 698	→ 38	1 987 470 040 <sup>7</sup>
									
	2.0	01.93-07.94	85		TBR		1 987 477 063	↔ 1420	
		03.93-07.94	85	Fg.-Nr. 4A..P..078 949→	SBR		1 987 477 687	↔ 1491	
			103	Fg.-Nr. 4A..P..078 949→			1 987 477 687	↔ 1491	
		12.93-07.94	79				1 987 477 687	↔ 1491	
	2.3	03.93-07.94	98	Fg.-Nr. 4A..P..078 949→			1 987 477 687	↔ 1491	



<b>◀ AUDI 100 Avant [4A5; C4]</b>								
2.3 quattro	12.90-07.94	98				1987 477 813	← 1692	
						1987 477 815	→ 1676	
2.4 D	08.91-07.94	60				1987 477 063	↔ 1420	
2.5 TDI	03.93-07.94	85	Fg.-Nr. 4A..P..078 949→			1987 477 687	↔ 1491	
2.6	03.93-07.94	110	Fg.-Nr. 4A..P..078 949→			1987 477 687	↔ 1491	
	07.93-07.94	102				1987 477 687	↔ 1491	
2.6 quattro	03.92-07.94	110				1987 477 813	← 1692	
						1987 477 815	→ 1676	
2.8	03.93-07.94	125-128	Fg.-Nr. 4A..P..078 949→			1987 477 687	↔ 1491	
2.8 quattro	12.90-07.94	128				1987 477 813	← 1692	
						1987 477 815	→ 1676	

**100 [4A2; C4]**

	1.6	03.92-01.94	75			0986 473 929	← 57	1987 470 005 <sup>7</sup>
						0986 473 929	← 57	1987 470 506 <sup>8</sup>
						0986 473 930	→ 57	1987 470 005 <sup>7</sup>
	2.0	12.90-07.94	74/79/85/			0986 473 929	← 57	1987 470 005 <sup>7</sup>
	2.0 quattro		103			0986 473 929	← 57	1987 470 506 <sup>8</sup>
						0986 473 930	→ 57	1987 470 005 <sup>7</sup>
	2.3	12.90-07.94	98			0986 473 929	← 57	1987 470 005 <sup>7</sup>
	2.3 quattro					0986 473 929	← 57	1987 470 506 <sup>8</sup>
						0986 473 930	→ 57	1987 470 005 <sup>7</sup>
	2.4 D	05.91-07.94	60			0986 473 929	← 57	1987 470 005 <sup>7</sup>
						0986 473 929	← 57	1987 470 506 <sup>8</sup>
						0986 473 930	→ 57	1987 470 005 <sup>7</sup>
	2.5 TDI	08.91-07.94	85			0986 473 929	← 57	1987 470 005 <sup>7</sup>
						0986 473 929	← 57	1987 470 506 <sup>8</sup>
						0986 473 930	→ 57	1987 470 005 <sup>7</sup>
	2.6	03.92-07.94	102/110			0986 474 882	← 57	1987 470 005 <sup>7</sup>
	2.6 quattro					0986 474 882	← 57	1987 470 506 <sup>8</sup>
						0986 474 884	→ 57	1987 470 005 <sup>7</sup>
	2.8	12.90-07.94	128			0986 474 882	← 57	1987 470 005 <sup>7</sup>
	2.8 quattro					0986 474 882	← 57	1987 470 506 <sup>8</sup>
						0986 474 884	→ 57	1987 470 005 <sup>7</sup>

	1.6	03.92-01.94	75			0986 475 039	↔ 20,64	
	2.0	12.90-07.94	74/85			0986 475 039	↔ 20,64	
	2.2 E	01.92-12.98	96			0986 475 260	↔ 17,46	
	2.4 D	05.91-07.94	60			0986 475 039	↔ 20,64	
	2.6 E	01.92-12.98	110			0986 475 260	↔ 17,46	

	2.0	01.93-07.94	85			0986 473 695	← 38	1987 470 040 <sup>7</sup>
						0986 474 695	→ 38	1987 470 040 <sup>7</sup>
		04.93-07.94	74/79	Fg.-Nr. 4A..P..078 949→		0986 473 695	← 38	1987 470 040 <sup>7</sup>
						0986 474 695	→ 38	1987 470 040 <sup>7</sup>
			103	Fg.-Nr. 4A..P..078 949→		0986 473 695	← 38	1987 470 040 <sup>7</sup>
						0986 474 695	→ 38	1987 470 040 <sup>7</sup>
	2.0 quattro	01.92-07.94	103			0986 473 698	← 38	1987 470 040 <sup>7</sup>
						0986 474 698	→ 38	1987 470 040 <sup>7</sup>
	2.3	04.93-07.94	98	Fg.-Nr. 4A..P..078 949→		0986 473 695	← 38	1987 470 040 <sup>7</sup>
						0986 474 695	→ 38	1987 470 040 <sup>7</sup>
	2.3 quattro	12.90-07.94	98			0986 473 698	← 38	1987 470 040 <sup>7</sup>
						0986 474 698	→ 38	1987 470 040 <sup>7</sup>
	2.5 TDI	04.93-07.94	85	Fg.-Nr. 4A..P..078 949→		0986 473 695	← 38	1987 470 040 <sup>7</sup>
						0986 474 695	→ 38	1987 470 040 <sup>7</sup>
	2.6	04.93-07.94	102	Fg.-Nr. 4A..P..078 949→		0986 473 695	← 38	1987 470 040 <sup>7</sup>
						0986 474 695	→ 38	1987 470 040 <sup>7</sup>
			110	Fg.-Nr. 4A..P..078 949→		0986 473 695	← 38	1987 470 040 <sup>7</sup>
						0986 474 695	→ 38	1987 470 040 <sup>7</sup>

		S							
2.6 quattro		03.92-07.94	110				0 986 473 698	← 38	1 987 470 040 <sup>7</sup>
							0 986 474 698	→ 38	1 987 470 040 <sup>7</sup>
2.8		04.93-07.94	128	Fg.-Nr. 4A..P..078 949→			0 986 473 695	← 38	1 987 470 040 <sup>7</sup>
							0 986 474 695	→ 38	1 987 470 040 <sup>7</sup>
2.8 quattro		12.90-07.94	128				0 986 474 698	← 38	1 987 470 040 <sup>7</sup>
							0 986 473 698	→ 38	1 987 470 040 <sup>7</sup>

	1.6	03.92-01.94	75				1 987 477 063	↔ 1420	
	2.0	12.90-07.94	74			TBR	1 987 477 063	↔ 1420	
		01.93-07.94	85			SBR	1 987 477 687	↔ 1491	
						TBR	1 987 477 063	↔ 1420	
		03.93-07.94	74	Fg.-Nr. 4A..P..078 949→		SBR	1 987 477 687	↔ 1491	
			103	Fg.-Nr. 4A..P..078 949→			1 987 477 687	↔ 1491	
		12.93-07.94	79				1 987 477 687	↔ 1491	
	2.0 quattro	01.92-07.94	103				1 987 477 813	← 1692	
							1 987 477 815	→ 1676	
	2.3	03.93-07.94	98	Fg.-Nr. 4A..P..078 949→			1 987 477 687	↔ 1491	
	2.3 quattro	12.90-07.94	98				1 987 477 813	← 1692	
							1 987 477 815	→ 1676	
	2.4D	05.91-07.94	60				1 987 477 063	↔ 1420	
	2.5 TDI	03.93-07.94	85	Fg.-Nr. 4A..P..078 949→			1 987 477 687	↔ 1491	
	2.6	03.93-07.94	102	Fg.-Nr. 4A..P..078 949→			1 987 477 687	↔ 1491	
			110	Fg.-Nr. 4A..P..078 949→			1 987 477 687	↔ 1491	
	2.6 quattro	03.92-07.94	110				1 987 477 813	← 1692	
							1 987 477 815	→ 1676	
	2.8	03.93-07.94	128	Fg.-Nr. 4A..P..078 949→			1 987 477 687	↔ 1491	
	2.8 quattro	12.90-07.94	128				1 987 477 813	← 1692	
							1 987 477 815	→ 1676	

**AUTOBIANCHI**

**Y 10 [R.92]**

	1.1 i.e.	09.92-12.95	37/40				0 204 102 447	← 48	0 204 104 184
	1.1 i.e. ECVT						0 986 473 104		
	1.1 i.e. Selectronic						0 204 102 448	→ 48	0 204 104 184
	1.1 i.e. 4x4						0 986 474 104		
	1.3 i.e.	09.92-12.95	53				0 204 102 524	← 48	0 204 104 234 <sup>7</sup>
							0 204 103 524		
							0 204 102 525	→ 48	0 204 104 234 <sup>7</sup>
							0 204 103 525		

	1.1 i.e., i.e. ECVT, i.e. Selectronic, i.e. 4x4	09.92-12.95	37/40				F 026 002 454	↔ 19,05	
	1.3 i.e.	09.92-12.95	53				F 026 002 454	↔ 19,05	

	1.1 i.e., i.e. ECVT, i.e. Selectronic, i.e. 4x4	09.92-12.95	37/40				1 987 477 651	2385	
	1.3 i.e.	09.92-12.95	53				1 987 477 086	2668	







**BENTLEY**

**Continental Flying Spur**

	6.0	03.05-05.13	412	LAB	0 265 007 928 <sup>4</sup>	
					0 265 007 930 <sup>3</sup>	
				RAB	0 265 007 928 <sup>3</sup>	
					0 265 007 930 <sup>4</sup>	

**Continental Flying Spur Speed**

	6.0	07.08-05.13	449	LAB	0 265 007 928 <sup>4</sup>	
					0 265 007 930 <sup>3</sup>	
				RAB	0 265 007 928 <sup>3</sup>	
					0 265 007 930 <sup>4</sup>	

**Continental GT**

	4.0 V8	01.12→	373/389	LAB	0 265 007 928 <sup>4</sup>	
					0 265 007 930 <sup>3</sup>	
				RAB	0 265 007 928 <sup>3</sup>	
					0 265 007 930 <sup>4</sup>	
	4.0 V8 S	07.13→	373/389	LAB	0 265 007 928 <sup>4</sup>	
					0 265 007 930 <sup>3</sup>	
				RAB	0 265 007 928 <sup>3</sup>	
					0 265 007 930 <sup>4</sup>	
	6.0	06.03→	412/423/ 434	LAB	0 265 007 928 <sup>4</sup>	
					0 265 007 930 <sup>3</sup>	
				RAB	0 265 007 928 <sup>3</sup>	
					0 265 007 930 <sup>4</sup>	























**Continental GT Speed**

	6.0	05.06-07.10	449	LAB	0 265 007 928 <sup>4</sup>	
					0 265 007 930 <sup>3</sup>	
				RAB	0 265 007 928 <sup>3</sup>	
					0 265 007 930 <sup>4</sup>	
		09.12→	460/467	LAB	0 265 007 928 <sup>4</sup>	
					0 265 007 930 <sup>3</sup>	
				RAB	0 265 007 928 <sup>3</sup>	
					0 265 007 930 <sup>4</sup>	
	6.0 FFV	05.06-07.10	449	LAB	0 265 007 928 <sup>4</sup>	
					0 265 007 930 <sup>3</sup>	
				RAB	0 265 007 928 <sup>3</sup>	
					0 265 007 930 <sup>4</sup>	

**Continental GTC**

	4.0 V8	01.12→	373/389	LAB	0 265 007 928 <sup>4</sup>	
					0 265 007 930 <sup>3</sup>	
				RAB	0 265 007 928 <sup>3</sup>	
					0 265 007 930 <sup>4</sup>	
	4.0 V8 S	07.13→	373/389	LAB	0 265 007 928 <sup>4</sup>	
					0 265 007 930 <sup>3</sup>	
				RAB	0 265 007 928 <sup>3</sup>	
					0 265 007 930 <sup>4</sup>	



		S										
6.0		12.04-04.11	412/423/434			LAB	0 265 007 928 <sup>4</sup>					
							0 265 007 930 <sup>3</sup>					
							RAB	0 265 007 928 <sup>3</sup>				
							0 265 007 930 <sup>4</sup>					
							10.11→	412/423/434	LAB	0 265 007 928 <sup>4</sup>		
							RAB	0 265 007 928 <sup>3</sup>				
6.0 FFV		12.04-04.11	412/423/434			LAB	0 265 007 928 <sup>4</sup>					
							0 265 007 930 <sup>3</sup>					
							RAB	0 265 007 928 <sup>3</sup>				
0 265 007 930 <sup>4</sup>												
6.0 4X4		09.10-08.13	412/423/434			LAB	0 265 007 928 <sup>4</sup>					
							0 265 007 930 <sup>3</sup>					
							RAB	0 265 007 928 <sup>3</sup>				
0 265 007 930 <sup>4</sup>												
<b>Continental GTC Speed</b>												
												
6.0		05.09-04.11	449			LAB	0 265 007 928 <sup>4</sup>					
							0 265 007 930 <sup>3</sup>					
							RAB	0 265 007 928 <sup>3</sup>				
							0 265 007 930 <sup>4</sup>					
							09.12→	460/467	LAB	0 265 007 928 <sup>4</sup>		
							RAB	0 265 007 928 <sup>3</sup>				
6.0 FFV		05.09-04.11	449			LAB	0 265 007 928 <sup>4</sup>					
							0 265 007 930 <sup>3</sup>					
							RAB	0 265 007 928 <sup>3</sup>				
0 265 007 930 <sup>4</sup>												
<b>Continental GT3 R</b>												
												
4.0		06.14→	426			LAB	0 265 007 928 <sup>4</sup>					
							0 265 007 930 <sup>3</sup>					
							RAB	0 265 007 928 <sup>3</sup>				
0 265 007 930 <sup>4</sup>												
<b>Continental Supersport</b>												
												
6.0		03.10-12.11	463			LAB	0 265 007 928 <sup>4</sup>					
							0 265 007 930 <sup>3</sup>					
							RAB	0 265 007 928 <sup>3</sup>				
0 265 007 930 <sup>4</sup>												
<b>Continental Supersports</b>												
												
6.0		03.10-12.11	463			LAB	0 265 007 928 <sup>4</sup>					
							0 265 007 930 <sup>3</sup>					
							RAB	0 265 007 928 <sup>3</sup>				
0 265 007 930 <sup>4</sup>												
<b>Continental Supersports Cabrio</b>												
												
6.0		03.10-12.11	463			LAB	0 265 007 928 <sup>4</sup>					
							0 265 007 930 <sup>3</sup>					



		S							
	<b>BENTLEY Continental Supersports Cabrio</b>								
6.0		03.10-12.11	463			RAB	0 265 007 928 <sup>3</sup>		
							0 265 007 930 <sup>4</sup>		
<b>Continental Supersports ISR Cabrio</b>									
	6.0	03.11-12.11	471			LAB	0 265 007 928 <sup>4</sup>		
							0 265 007 930 <sup>3</sup>		
						RAB	0 265 007 928 <sup>3</sup>		
							0 265 007 930 <sup>4</sup>		
<b>Flying Spur</b>									
	4.0 V8	02.14→	373			LAB	0 265 007 928 <sup>4</sup>		
							0 265 007 930 <sup>3</sup>		
						RAB	0 265 007 928 <sup>3</sup>		
							0 265 007 930 <sup>4</sup>		
	6.0 W12	03.13→	460			LAB	0 265 007 928 <sup>4</sup>		
							0 265 007 930 <sup>3</sup>		
						RAB	0 265 007 928 <sup>3</sup>		
							0 265 007 930 <sup>4</sup>		
<b>Mulsanne</b>									
	6.8	09.09→	377			LAB	0 265 007 928 <sup>4</sup>		
							0 265 007 930 <sup>3</sup>		
						RAB	0 265 007 928 <sup>3</sup>		
							0 265 007 930 <sup>4</sup>		
<b>Mulsanne Speed</b>									
	6.8	10.14→	395			LAB	0 265 007 928 <sup>4</sup>		
							0 265 007 930 <sup>3</sup>		
						RAB	0 265 007 928 <sup>3</sup>		
							0 265 007 930 <sup>4</sup>		
<b>BMW</b>									
<b>Serie X [E 53]</b>									
	X5 3.0d, 3.0i, 4.4i	03.99-10.06	135/155-160/ 170/210				0 986 473 262		← 60
							0 986 474 262		→ 60
	X5 4.4i	10.03-10.06	235		332		0 986 473 262		← 60
							0 986 474 262		→ 60
	X5 3.0d, 3.0i, 4.4i	03.99-10.06	135/155-160/ 170/210				0 986 473 219		← 42
							0 986 474 219		→ 42
	X5 4.4i, 4.6i, 4.8i	02.02-10.06	235/255/265						F 026 A06 123 <sup>7</sup>
	X5 3.0d	03.01-10.06	135/155-160/170/ 210/235/255/265			LLE	1 987 477 820		↔ 1942
						RLE	1 987 477 821		↔ 1930
	X5 3.0i	10.99-09.06	135/155-160/170/ 210/235/255/265			LLE	1 987 477 820		↔ 1942
						RLE	1 987 477 821		↔ 1930







































B

		S							
<b>X5 4.4 i</b>		03.99-10.06	135/155-160/170/ 210/235/255/265			LLE RLE	1 987 <b>477 820</b> 1 987 <b>477 821</b>	↔ 1942 ↔ 1930	
<b>X5 4.6 is</b>		02.02-09.03	135/155-160/170/ 210/235/255/265			LLE RLE	1 987 <b>477 820</b> 1 987 <b>477 821</b>	↔ 1942 ↔ 1930	
<b>X5 4.8 is</b>		03.04-10.06	135/155-160/170/ 210/235/255/265			LLE RLE	1 987 <b>477 820</b> 1 987 <b>477 821</b>	↔ 1942 ↔ 1930	
<b>X5 3.0 d</b>		03.01-09.03	135				0 986 <b>594 529</b> <sup>3</sup> 0 986 <b>594 530</b> <sup>4</sup>		
		10.03-10.06	155-160				0 265 <b>007 852</b> <sup>3</sup> 0 265 <b>007 853</b> <sup>4</sup>		
<b>X5 3.0 i</b>		10.99-09.03	170				0 986 <b>594 529</b> <sup>3</sup> 0 986 <b>594 530</b> <sup>4</sup>		
		10.03-09.06	170				0 265 <b>007 852</b> <sup>3</sup> 0 265 <b>007 853</b> <sup>4</sup>		
<b>X5 4.4 i</b>		03.99-09.03	210				0 986 <b>594 530</b> <sup>4</sup>		
		05.00-09.03	210				0 986 <b>594 529</b> <sup>3</sup>		
		10.03-10.06	235				0 265 <b>007 852</b> <sup>3</sup> 0 265 <b>007 853</b> <sup>4</sup>		
<b>X5 4.6 is</b>		02.02-09.03	255				0 986 <b>594 529</b> <sup>3</sup> 0 986 <b>594 530</b> <sup>4</sup>		
<b>X5 4.8 is</b>		03.04-10.06	265				0 265 <b>007 852</b> <sup>3</sup> 0 265 <b>007 853</b> <sup>4</sup>		
<b>Serie X [E 83]</b>									
<b>X3 18 d xDrive, 2.0 d, 20 d xDrive, 2.0i, 20i xDrive, 2.5 si, 2.5i, 25i xDrive, 3.0 d, 30 d xDrive, 3.0 si, 3.0i, 30i xDrive</b>		01.04-08.10	105/110/120-130/ 141/150/155-160/ 170/200				0 986 <b>473 990</b> 0 986 <b>474 990</b>	← 57 → 57	
<b>X3 3.0 sd</b>		09.06-08.10	210				0 986 <b>473 262</b>	← 60	
<b>X3 35 d xDrive</b>							0 986 <b>474 262</b>	→ 60	
<b>X3 18 d xDrive, 2.0 d, 20 d xDrive, 2.0i, 20i xDrive, 2.5 si, 2.5i, 25i xDrive, 3.0 d, 30 d xDrive, 3.0 sd, 3.0 si, 3.0i, 30i xDrive, 35 d xDrive</b>		01.04-08.10	105/110/120-130/ 141/150/155-160/ 170/200/210				0 986 <b>473 160</b> 0 986 <b>474 160</b>	← → 41,94	F 026 <b>A06 123</b> <sup>7</sup> F 026 <b>A06 123</b> <sup>7</sup>
<b>X3 18 d xDrive, 2.0 d, 20 d xDrive, 2.0i, 20i xDrive, 2.5 si, 2.5i, 25i xDrive, 3.0 d, 30 d xDrive, 3.0 sd, 3.0 si, 3.0i, 30i xDrive, 35 d xDrive</b>		01.04-08.10	105/110/120-130/ 141/150/155-160/ 170/200/210				1 987 <b>477 987</b> 1 987 <b>477 988</b>	← 1613 → 1634	
<b>X3 18 d xDrive</b>		05.09-08.10	105				0 265 <b>007 854</b> <sup>3</sup> 0 265 <b>007 855</b> <sup>4</sup>		
<b>X3 2.0 d</b>		10.04-09.05	110				0 265 <b>007 622</b> <sup>4</sup>		
		10.04-09.07	110				0 265 <b>007 854</b> <sup>3</sup>		
		10.05-09.07	110				0 265 <b>007 855</b> <sup>4</sup>		
<b>X3 2.0 d</b>		09.07-08.10	120-130				0 265 <b>007 854</b> <sup>3</sup>		
<b>X3 20 d xDrive</b>							0 265 <b>007 855</b> <sup>4</sup>		
<b>X3 2.0i</b>		09.05-08.10	110				0 265 <b>007 854</b> <sup>3</sup>		
<b>X3 20i xDrive</b>							0 265 <b>007 855</b> <sup>4</sup>		
<b>X3 2.5 si, 25i xDrive, 3.0 d, 30 d xDrive, 3.0i</b>		09.05-08.10	155-160				0 265 <b>007 854</b> <sup>3</sup> 0 265 <b>007 855</b> <sup>4</sup>		
<b>X3 2.5i</b>		03.04-09.05	141				0 265 <b>007 622</b> <sup>4</sup>		
		03.04-08.06	141				0 265 <b>007 854</b> <sup>3</sup>		
		10.05-08.06	141				0 265 <b>007 855</b> <sup>4</sup>		
<b>X3 3.0 d</b>		01.04-09.05	150				0 265 <b>007 622</b> <sup>4</sup> 0 265 <b>007 854</b> <sup>3</sup>		



		S							
	<b>BMW Serie X [E 83]</b>								
	<b>X3 3.0sd, 3.0 si, 30i xDrive, 35 d xDrive</b>	09.06-08.10	200/210				0 265 <b>007 854</b> <sup>3</sup>		
							0 265 <b>007 855</b> <sup>4</sup>		
	<b>X3 3.0i</b>	01.04-09.05	170				0 265 <b>007 622</b> <sup>4</sup>		
		01.04-08.06	170				0 265 <b>007 854</b> <sup>3</sup>		
		10.05-08.06	170				0 265 <b>007 855</b> <sup>4</sup>		
<b>Serie X [E 84]</b>									
	<b>X1 16 d sDrive, 16 i sDrive, 18 d sDrive, 18 d xDrive, 18i sDrive, 20 d ed sDrive, 20 d sDrive, 20 d xDrive, 20 s xDrive, 20i sDrive, 20i xDrive</b>	10.09→	85/100-110/ 120-130/135				0 986 <b>134 063</b>		← 57
							0 986 <b>135 063</b>		→ 57
	<b>X1 23 d xDrive</b>	10.09-02.12	150				0 986 <b>134 324</b>		← 57
		03.12-06.12	150				0 986 <b>135 324</b>		→ 57
							0 986 <b>134 063</b>		← 57
							0 986 <b>135 063</b>		→ 57
	<b>X1 25 d xDrive</b>	07.12→	160				0 986 <b>134 063</b>		← 57
							0 986 <b>135 063</b>		→ 57
	<b>X1 25i xDrive</b>	03.10→	160				0 986 <b>134 324</b>		← 57
							0 986 <b>135 324</b>		→ 57
	<b>X1 28i xDrive</b>	03.11-02.12	180				0 986 <b>134 324</b>		← 57
		03.12→	180				0 986 <b>135 324</b>		→ 57
							0 986 <b>134 063</b>		← 57
							0 986 <b>135 063</b>		→ 57
	<b>X1 16 d sDrive, 16 i sDrive, 18 d sDrive, 18 d xDrive, 18i sDrive, 20 d ed sDrive, 20 d sDrive, 20 d xDrive, 20 s xDrive, 20i sDrive, 20i xDrive, 23 d xDrive, 25 d xDrive, 25i xDrive, 28i xDrive</b>	10.09→	85/100-110/120-130/ 135/150/160/180				0 986 <b>134 311</b>		←
							0 986 <b>135 311</b>		→
	<b>X1 28i xDrive</b>	10.09-08.11	190				0 986 <b>134 084</b>		← 44
							0 986 <b>135 084</b>		→ 44
	<b>X1 16 d sDrive</b>	07.12→	85/100-110				1 987 <b>482 368</b>		↔ 1558
	<b>X1 16 i sDrive</b>	05.13→	105				1 987 <b>482 493</b>		↔ 1558
	<b>X1 18 d sDrive</b>	11.09-06.12	85/100-110				1 987 <b>482 368</b>		↔ 1558
		07.12→	105				1 987 <b>482 368</b>		↔ 1558
	<b>X1 18 d xDrive</b>	11.09-06.12	85/100-110				1 987 <b>482 368</b>		↔ 1558
	<b>X1 18i sDrive</b>	03.10→	85/100-110				1 987 <b>482 368</b>		↔ 1558
	<b>X1 20 d ed sDrive</b>	09.11→	120-130				1 987 <b>482 368</b>		↔ 1558
	<b>X1 20 d sDrive</b>	10.09-06.12	120-130				1 987 <b>482 368</b>		↔ 1558
		07.12→	135				1 987 <b>482 368</b>		↔ 1558
	<b>X1 20 d xDrive</b>	10.09-06.12	120-130				1 987 <b>482 368</b>		↔ 1558
	<b>X1 20 s xDrive</b>	07.12→	135				1 987 <b>482 368</b>		↔ 1558
	<b>X1 20i sDrive</b>	09.11→	135				1 987 <b>482 493</b>		↔ 1558
	<b>X1 20i xDrive</b>	09.11→	135				1 987 <b>482 493</b>		↔ 1558
	<b>X1 23 d xDrive</b>	10.09-06.12	150/160				1 987 <b>482 368</b>		↔ 1558
	<b>X1 25 d xDrive</b>	07.12→	150/160				1 987 <b>482 368</b>		↔ 1558
	<b>X1 25i xDrive</b>	03.10→	150/160				1 987 <b>482 368</b>		↔ 1558
	<b>X1 28i xDrive</b>	10.09-08.11	190				1 987 <b>482 368</b>		↔ 1558
		03.11→	180				1 987 <b>482 493</b>		↔ 1558
	<b>X1 16 d sDrive, 16 i sDrive, 18 d sDrive, 18 d xDrive, 18i sDrive, 20 d ed sDrive, 20 d sDrive, 20 d xDrive, 20 s xDrive, 20i sDrive, 20i xDrive, 23 d xDrive, 25 d xDrive, 25i xDrive, 28i xDrive</b>	10.09→	85/100-110/120-130/ 135/150/160/180/190				0 265 <b>008 238</b> <sup>4</sup>		



		S							
<b>Serie Z Coupé [E 36/8]</b>									
									
	Z 3 2.8 Z 3 3.0i	09.97-06.02	142/170				0 986 473 917 0 986 473 918	 ← 54  → 54	
									
	Z 3 M 3.2 Z 3 2.8, 3.0i	09.97-12.00 03.01-06.02 09.97-06.02	236 239 142/170						F 026 A06 122 <sup>7</sup> F 026 A06 122 <sup>7</sup> F 026 A06 126 <sup>7</sup>
									
	Z 3 M 3.2 Z 3 2.8 Z 3 3.0i	09.97-12.00 03.01-06.02 09.97-09.00 05.00-06.02	142/170/236/239 142/170/236/239 142/170/236/239 142/170/236/239				1 987 477 710 1 987 477 710 1 987 477 710 1 987 477 710	↔ 1283 ↔ 1283 ↔ 1283 ↔ 1283	
	Z 3 M 3.2 Z 3 M 3.2, 2.8 Z 3 3.0i	03.01-06.02 09.97-12.00 MFD 05.00-09.00 OFD 05.00-06.02	239 142/236 170 170				0 986 594 015 <sup>3</sup> 0 986 594 015 <sup>3</sup> 0 986 594 015 <sup>3</sup> 0 986 594 015 <sup>3</sup>		
<b>Serie Z Coupé [E 86]</b>									
									
	Z 4 3.0 si	03.06-08.08	195				0 986 473 990 0 986 474 990	 ← 57  → 57	
									
	Z 4 3.0 si	03.06-08.08	195				0 986 473 159 0 986 474 159	 ← 39,94  → 39,94	F 026 A06 122 <sup>7</sup> F 026 A06 122 <sup>7</sup>
									
	Z 4 M 3.2 Z 4 3.0 si	03.06-08.08 03.06-08.08	195/252 195/252				1 987 477 949 1 987 477 949	↔ 1090 ↔ 1090	
	Z 4 M 3.2 Z 4 3.0 si	03.06-08.08	195/252				0 986 594 532 <sup>4</sup> 0 986 594 527 <sup>3</sup> 0 986 594 528 <sup>3</sup>		
<b>Serie Z [E 36/7]</b>									
									
	Z 3 1.8 Z 3 1.9	03.95-09.02	85/87/103				0 986 471 919 0 986 473 919 0 986 471 920 0 986 473 920	← 54  → 54 	
	Z 3 2.0, 2.2i, 2.5, 2.8, 3.0i	11.96-09.02	110/125/ 142/170				0 986 473 917 0 986 473 918	 ← 54  → 54	
									
	Z 3 M 3.2 Z 3 1.8, 1.9, 2.0, 2.2i, 2.5, 2.8, 3.0i	11.96-12.00 02.01-09.02 03.95-09.02	236 239 85/87/103/110/125/142/170						F 026 A06 122 <sup>7</sup> F 026 A06 122 <sup>7</sup> F 026 A06 126 <sup>7</sup>
									
	Z 3 M 3.2	11.96-12.00 02.01-09.02	110/125/142/170/236/239 110/125/142/170/236/239				1 987 477 710 1 987 477 710	↔ 1283 ↔ 1283	



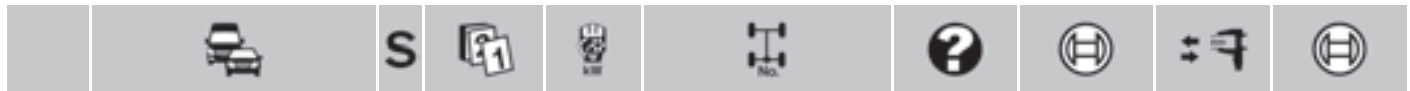

◀ BMW Serie Z [E 36/7]

	Z3 1.8	03.95-12.98	85		1987 477 709	↔ 1255
	Z3 1.9	09.95-12.99	103		1987 477 709	↔ 1255
		09.98-09.02	87		1987 477 710	↔ 1283
	Z3 2.0	04.99-12.00	110/125/142/170/236/239		1987 477 710	↔ 1283
	Z3 2.2i	09.00-09.02	110/125/142/170/236/239		1987 477 710	↔ 1283
	Z3 2.5	09.98-09.00	110/125/142/170/236/239		1987 477 710	↔ 1283
	Z3 2.8	11.96-08.00	110/125/142/170/236/239		1987 477 710	↔ 1283
	Z3 3.0i	05.00-06.02	110/125/142/170/236/239		1987 477 710	↔ 1283

	Z3 M3.2	02.01-09.02	239		0986 594 015 <sup>3</sup>	
	Z3 M3.2, 2.8	11.96-12.00	142/236		0986 594 015 <sup>3</sup>	
	Z3 1.8, 1.9	03.95-12.99	85/103		0986 594 015 <sup>3</sup>	
	Z3 1.9	MFD 09.98-09.00	87		0986 594 015 <sup>3</sup>	
		OFD 09.98-09.02	87		0986 594 015 <sup>3</sup>	
	Z3 2.0	MFD 04.99-09.00	110		0986 594 015 <sup>3</sup>	
		OFD 04.99-12.00	110		0986 594 015 <sup>3</sup>	
	Z3 2.2i	OFD 09.00-09.02	125		0986 594 015 <sup>3</sup>	
	Z3 2.5	09.98-09.00	125		0986 594 015 <sup>3</sup>	
	Z3 3.0i	MFD 05.00-09.00	170		0986 594 015 <sup>3</sup>	
		OFD 05.00-06.02	170		0986 594 015 <sup>3</sup>	

Serie Z [E 52]



	Z8	03.00-07.03	294		0986 594 531 <sup>4</sup>	
--	----	-------------	-----	--	---------------------------	--

Serie Z [E 85]



	Z4 2.0i, 2.2i, 2.5 si, 2.5i, 3.0i	10.02-08.08	110/125/130/ 141/160/170		0986 473 917	👁️ ← 54
					0986 473 918	👁️ → 54
	Z4 3.0 si	02.06-08.08	195		0986 473 990	👁️ ← 57
					0986 474 990	👁️ → 57



	Z4 2.0i, 2.2i, 2.5i	10.02-08.08	110/125/ 130/141		0986 473 470	👁️ ← 40 F 026 A06 122 <sup>7</sup>
					0986 474 470	👁️ → 40 F 026 A06 122 <sup>7</sup>
	Z4 2.5 si	02.06-08.08	160		0986 473 159	👁️ ← 39,94 F 026 A06 122 <sup>7</sup>
					0986 474 159	👁️ → 39,94 F 026 A06 122 <sup>7</sup>
	Z4 3.0 si	02.06-08.08	195		0986 473 159	👁️ ← 39,94 F 026 A06 122 <sup>7</sup>
					0986 474 159	👁️ → 39,94 F 026 A06 122 <sup>7</sup>
	Z4 3.0i	10.02-11.05	170		0986 473 159	👁️ ← 39,94 F 026 A06 122 <sup>7</sup>
					0986 474 159	👁️ → 39,94 F 026 A06 122 <sup>7</sup>



	Z4 M3.2	02.06-08.08	110/125/130/141/160/170/195/252		1987 477 949	↔ 1090
	Z4 2.0i	03.05-08.08	110/125/130/141/160/170/195/252		1987 477 949	↔ 1090
	Z4 2.2i	10.03-11.05	110/125/130/141/160/170/195/252		1987 477 949	↔ 1090
	Z4 2.5 si	02.06-08.08	110/125/130/141/160/170/195/252		1987 477 949	↔ 1090
	Z4 2.5i	10.02-11.05	110/125/130/141/160/170/195/252		1987 477 949	↔ 1090
		02.06-07.08	110/125/130/141/160/170/195/252		1987 477 949	↔ 1090
	Z4 3.0 si	02.06-08.08	110/125/130/141/160/170/195/252		1987 477 949	↔ 1090
	Z4 3.0i	10.02-11.05	110/125/130/141/160/170/195/252		1987 477 949	↔ 1090

	Z4 M3.2, 2.0i, 2.2i, 2.5 si, 2.5i, 3.0 si, 3.0i	10.02-08.08	110/125/130/ 141/160/170/ 195/252		0986 594 532 <sup>4</sup>	
				LAB	0986 594 527 <sup>3</sup>	
				RAB	0986 594 528 <sup>3</sup>	







































		S							
<b>Serie Z [E 89]</b>									
	Z 4 18i sDrive, 20i sDrive, 23i sDrive	04.09→	115/135/150				0 986 134 063		← 57
	Z 4 28i sDrive	04.09→	180/190				0 986 135 063		→ 57
	Z 4 30i sDrive						0 986 134 324		← 57
							0 986 135 324		→ 57
	Z 4 18i sDrive, 20i sDrive, 23i sDrive, 28i sDrive, 30i sDrive, 35i sDrive, 35is sDrive	04.09→	115/135/150/180/190/225/250				0 265 008 161 <sup>3</sup>		
							0 265 008 162 <sup>4</sup>		
<b>Serie 1 Cabrio [E 88]</b>									
	120 d	03.08-10.13	120-130				0 986 134 344		← 54
	120 i						0 986 135 344		→ 54
	120 i	03.08-10.13	115	PFN			0 986 134 344		← 54
							0 986 135 344		→ 54
	123 d	09.08-09.13	150				0 986 134 344		← 54
							0 986 135 344		→ 54
	125 i	03.08-10.13	160				0 986 134 344		← 54
							0 986 135 344		→ 54
	118 d	03.08-10.13	100-105				0 986 134 310		←
	118 i						0 986 135 310		→
	120 d	03.08-10.13	120-130				0 986 134 310		←
	120 i						0 986 135 310		→
	120 i	03.08-10.13	115	PFC			0 986 134 311		←
							0 986 135 311		→
				PFN			0 986 134 310		←
							0 986 135 310		→
	123 d	09.08-09.13	150				0 986 134 311		←
							0 986 135 311		→
	125 i	03.08-10.13	160				0 986 134 310		←
							0 986 135 310		→
	118 d	09.08-10.13	100-105				1 987 477 946		↔ 1434
	118 i	03.08-10.13	100-105				1 987 477 946		↔ 1434
	120 d	03.08-10.13	115/120-130				1 987 477 946		↔ 1434
	120 i	03.08-10.13	115/120-130				1 987 477 946		↔ 1434
	123 d	09.08-09.13	150				1 987 477 946		↔ 1434
	125 i	03.08-10.13	160				1 987 477 946		↔ 1434
	135 i	03.08-10.13	225-240				1 987 477 946		↔ 1434
	118 d	03.08-10.13	100-105				0 986 594 514 <sup>4</sup>		
	118 i						0 986 594 519 <sup>3</sup>		
	120 d	03.08-10.13	120-130	EAL			0 986 594 540 <sup>3</sup>		
	120 i						0 986 594 571 <sup>4</sup>		
				EAL			0 986 594 514 <sup>4</sup>		
							0 986 594 519 <sup>3</sup>		
	120 i	03.08-10.13	115				0 986 594 514 <sup>4</sup>		
							0 986 594 519 <sup>3</sup>		
	123 d	09.08-09.13	150	EAL			0 986 594 540 <sup>3</sup>		
							0 986 594 572 <sup>4</sup>		
				EAL			0 986 594 519 <sup>3</sup>		
							0 986 594 565 <sup>4</sup>		





		S							
	◀ BMW Serie 1 Cabrio [E 88]								
	125 i	03.08-10.13	160				0986 594 540 <sup>3</sup>		
							0986 594 571 <sup>4</sup>		
	135 i	03.08-10.13	225-240				0986 594 540 <sup>3</sup>		
							0986 594 572 <sup>4</sup>		
<b>Serie 1 Coupé [E 82]</b>									
	120 d	10.07-10.13	120-130				0986 134 344		← 54
							0986 135 344		→ 54
	120 i	09.09-09.13	125		PFN		0986 134 344		← 54
		09.09-10.13	115		PFN		0986 135 344		→ 54
							0986 134 344		← 54
							0986 135 344		→ 54
	123 d	10.07-09.13	150				0986 134 344		← 54
							0986 135 344		→ 54
	125 i	03.08-09.13	160		PFN		0986 134 344		← 54
							0986 135 344		→ 54
	118 d	09.09-10.13	100-105				0986 134 310		←
							0986 135 310		→
	120 d	10.07-10.13	120-130				0986 134 310		←
							0986 135 310		→
	120 i	09.09-09.13	125		PFC		0986 134 311		←
							0986 135 311		→
					PFN		0986 134 310		←
							0986 135 310		→
		09.09-10.13	115		PFC		0986 134 311		←
							0986 135 311		→
					PFN		0986 134 310		←
							0986 135 310		→
	123 d	10.07-09.13	150				0986 134 311		←
							0986 135 311		→
	125 i	03.08-09.13	160		PFC		0986 134 311		←
							0986 135 311		→
					PFN		0986 134 310		←
							0986 135 310		→
	M	04.11-06.12	250				1987 477 946		↔ 1434
	118 d	09.09-10.13	100-105				1987 477 946		↔ 1434
	120 d	10.07-10.13	115/120-130				1987 477 946		↔ 1434
	120 i	09.09-10.13	115/120-130				1987 477 946		↔ 1434
	123 d	10.07-09.13	150				1987 477 946		↔ 1434
	125 i	03.08-09.13	160				1987 477 946		↔ 1434
	135 i	10.07-10.13	225-240				1987 477 946		↔ 1434
	M	04.11-06.12	250				0986 594 572 <sup>4</sup>		
	118 d	09.09-10.13	100-105				0986 594 514 <sup>4</sup>		
							0986 594 519 <sup>3</sup>		
	120 d	10.07-10.13	120-130		EAL		0986 594 540 <sup>3</sup>		
							0986 594 571 <sup>4</sup>		
					<del>EAL</del>		0986 594 514 <sup>4</sup>		
							0986 594 519 <sup>3</sup>		
	120 i	09.09-09.13	125				0986 594 514 <sup>4</sup>		
		09.09-10.13	115				0986 594 519 <sup>3</sup>		
							0986 594 514 <sup>4</sup>		
							0986 594 519 <sup>3</sup>		













		S							
123 d		10.07-09.13	150			EAL	0 986 594 540 <sup>3</sup> 0 986 594 572 <sup>4</sup>		
						EAL	0 986 594 519 <sup>3</sup> 0 986 594 565 <sup>4</sup>		
125 i		03.08-09.13	160				0 986 594 540 <sup>3</sup> 0 986 594 571 <sup>4</sup>		
135 i		10.07-10.13	225-240				0 986 594 540 <sup>3</sup> 0 986 594 572 <sup>4</sup>		
<b>Serie 1 [E 81]</b>									
									
	120 d	05.07-12.11	115/ 120-130			PFN	0 986 134 344  ← 54 0 986 135 344  → 54		
	123 d	09.07-12.11	150			PFN	0 986 134 344  ← 54 0 986 135 344  → 54		
	130 i	05.07-12.11	190/195			PFN	0 986 134 344  ← 54 0 986 135 344  → 54		
									
	116 d	09.07-12.11	66-85/90			PFC	0 986 134 311  ← 0 986 135 311  →		
	118 d	05.07-12.11	100-105			PFC	0 986 134 311  ← 0 986 135 311  →		
						PFN	0 986 134 310  ← 0 986 135 310  →		
	118 i	05.07-12.11	100			PFC	0 986 134 311  ← 0 986 135 311  →		
	120 d	05.07-12.11	120-130			PFC	0 986 134 311  ← 0 986 135 311  →		
						PFN	0 986 134 310  ← 0 986 135 310  →		
	120 i	05.07-12.11	115/ 120-125			PFC	0 986 134 311  ← 0 986 135 311  →		
	123 d	09.07-12.11	150			PFN	0 986 134 311  ← 0 986 135 311  →		
	130 i	05.07-12.11	190/195			PFN	0 986 134 311  ← 0 986 135 311  →		
									
	116 d	03.09-12.11	66-85/90				1 987 477 946 ↔ 1434		
	116 i	09.07-12.11	66-85/90				1 987 477 946 ↔ 1434		
	118 d	05.07-12.11	100-105				1 987 477 946 ↔ 1434		
	118 i	05.07-12.11	100-105				1 987 477 946 ↔ 1434		
	120 d	05.07-12.11	115/120-130				1 987 477 946 ↔ 1434		
	120 i	05.07-12.11	115/120-130				1 987 477 946 ↔ 1434		
	123 d	09.07-12.11	150				1 987 477 946 ↔ 1434		
	130 i	05.07-12.11	190/195				1 987 477 946 ↔ 1434		
									
	116 d	09.07-12.11	66-85/90				0 986 594 514 <sup>4</sup> 0 986 594 519 <sup>3</sup>		
	118 d	05.07-12.11	100-105				0 986 594 514 <sup>4</sup> 0 986 594 519 <sup>3</sup>		
	118 i						0 986 594 519 <sup>3</sup>		
	120 d	05.07-12.11	120-130			EAL	0 986 594 540 <sup>3</sup> 0 986 594 571 <sup>4</sup>		
	120 i					EAL	0 986 594 514 <sup>4</sup> 0 986 594 519 <sup>3</sup>		
	120 i	05.07-10.11	115				0 986 594 514 <sup>4</sup> 0 986 594 519 <sup>3</sup>		



		S							
	◀ BMW Serie 1 [E 81]								
	123 d	09.07-12.11	150		EAL		0986 594 540 <sup>3</sup>		
							0986 594 572 <sup>4</sup>		
					<del>EAL</del>		0986 594 519 <sup>3</sup>		
							0986 594 565 <sup>4</sup>		
	130 i	05.07-12.11	190/195				0986 594 540 <sup>3</sup>		
							0986 594 572 <sup>4</sup>		
<b>Serie 1 [E 87]</b>									
	120 d	03.07-06.11	120-130				0986 134 344		← 54
							0986 135 344		→ 54
	120 i	03.07-06.11	115/ 120-125		PFN		0986 134 344		← 54
							0986 135 344		→ 54
	123 d	09.07-06.11	150				0986 134 344		← 54
							0986 135 344		→ 54
	130 i	09.05-06.11	190/195		PFN		0986 134 344		← 54
							0986 135 344		→ 54
	116 i	09.04-06.11	85/90		PFC		0986 134 311		←
							0986 135 311		→
	118 d	03.07-06.11	100-105				0986 134 310		←
							0986 135 310		→
	118 d	09.04-06.11	90/95/100		PFC		0986 134 311		←
	118 i						0986 135 311		→
	118 i	03.07-06.11	100-105		PFC		0986 134 311		←
							0986 135 311		→
	120 d	09.04-03.07	120				0986 134 310		←
							0986 135 310		→
		03.07-06.11	120-130				0986 134 310		←
							0986 135 310		→
	120 i	03.07-06.11	115		PFC		0986 134 311		←
							0986 135 311		→
			120-125		PFC		0986 134 311		←
							0986 135 311		→
	123 d	09.07-06.11	150				0986 134 311		←
							0986 135 311		→
	130 i	09.05-06.11	190/195		PFN		0986 134 311		←
							0986 135 311		→
	116 d	03.09-06.11	66-85/90				1987 477 946		↔ 1434
	116 i	09.04-06.11	66-85/90				1987 477 946		↔ 1434
	118 d	09.04-06.11	90/95/100-105				1987 477 946		↔ 1434
	118 i	11.04-06.11	90/95/100-105				1987 477 946		↔ 1434
	120 d	09.04-06.11	110/115/120-130				1987 477 946		↔ 1434
	120 i	09.04-06.11	110/115/120-130				1987 477 946		↔ 1434
	123 d	09.07-06.11	150				1987 477 946		↔ 1434
	130 i	09.05-06.11	190/195				1987 477 946		↔ 1434
	116 d	09.04-06.11	66-85/90				0986 594 514 <sup>4</sup>		
	116 i						0986 594 519 <sup>3</sup>		
	118 d	09.04-06.11	90/95/ 100-105				0986 594 514 <sup>4</sup>		
	118 i						0986 594 519 <sup>3</sup>		
	120 d	09.04-06.11	110/115/ 120				0986 594 514 <sup>4</sup>		
	120 i						0986 594 519 <sup>3</sup>		
		03.07-06.11	120-130		EAL		0986 594 540 <sup>3</sup>		
							0986 594 571 <sup>4</sup>		
					<del>EAL</del>		0986 594 514 <sup>4</sup>		
							0986 594 519 <sup>3</sup>		

B

		S							
123 d		09.07-06.11	150			EAL	0 986 594 540 <sup>3</sup>		
						EAL	0 986 594 572 <sup>4</sup>		
							0 986 594 519 <sup>3</sup>		
							0 986 594 565 <sup>4</sup>		
130 i		09.05-06.11	190/195				0 986 594 540 <sup>3</sup>		
							0 986 594 572 <sup>4</sup>		
<b>Serie 1 [F 20]</b>									
									
	M 135 i	07.12→	235/240			HZO	1 987 482 492	↔ 1463	
						Y45	1 987 482 492	↔ 1463	
	M 135 i xDrive	11.12→	235/240			HZO	1 987 482 492	↔ 1463	
						Y45	1 987 482 492	↔ 1463	
	114 d	11.12→	70			AAK	1 987 482 492	↔ 1463	
						AAK	1 987 482 492	↔ 1463	
		07.15→	70				1 987 482 492	↔ 1463	
	114 i	07.12-02.15	75				1 987 482 492	↔ 1463	
	116 d	09.11-02.15	85			AAK	1 987 482 492	↔ 1463	
						AAK	1 987 482 492	↔ 1463	
		03.15→	85			HZO	1 987 482 492	↔ 1463	
						Y45	1 987 482 492	↔ 1463	
	116 d ed	03.12-02.15	85			AAK	1 987 482 492	↔ 1463	
						AAK	1 987 482 492	↔ 1463	
		03.15→	85			HZO	1 987 482 492	↔ 1463	
						Y45	1 987 482 492	↔ 1463	
	116 i	09.11-02.15	100			AAK	1 987 482 492	↔ 1463	
						AAK	1 987 482 492	↔ 1463	
		03.15→	80			HZO	1 987 482 492	↔ 1463	
						Y45	1 987 482 492	↔ 1463	
	118 d	09.11-02.15	105			AAK	1 987 482 492	↔ 1463	
						AAK	1 987 482 492	↔ 1463	
		03.15→	110			HZO	1 987 482 492	↔ 1463	
						Y45	1 987 482 492	↔ 1463	
	118 d xDrive	07.13-02.15	105			AAK	1 987 482 492	↔ 1463	
						AAK	1 987 482 492	↔ 1463	
		03.15→	110			HZO	1 987 482 492	↔ 1463	
						Y45	1 987 482 492	↔ 1463	
	118 i	09.11-02.15	125			AAK	1 987 482 492	↔ 1463	
						AAK	1 987 482 492	↔ 1463	
		03.15→	100			HZO	1 987 482 492	↔ 1463	
						Y45	1 987 482 492	↔ 1463	
	120 d	09.11-02.15	135-147			AAK	1 987 482 492	↔ 1463	
						AAK	1 987 482 492	↔ 1463	
		03.15→	140			HZO	1 987 482 492	↔ 1463	
						Y45	1 987 482 492	↔ 1463	
	120 d xDrive	11.12-02.15	135-147			AAK	1 987 482 492	↔ 1463	
						AAK	1 987 482 492	↔ 1463	
	120 i	03.15→	130			HZO	1 987 482 492	↔ 1463	
						Y45	1 987 482 492	↔ 1463	
	120 xDrive	03.15→	140			HZO	1 987 482 492	↔ 1463	
						Y45	1 987 482 492	↔ 1463	
	125 d	03.12-02.15	160			AAK	1 987 482 492	↔ 1463	
						AAK	1 987 482 492	↔ 1463	
		03.15→	165			HZO	1 987 482 492	↔ 1463	
						Y45	1 987 482 492	↔ 1463	
	125 i	03.12→	160			AAK	1 987 482 492	↔ 1463	
						AAK	1 987 482 492	↔ 1463	





◀ BMW

**Serie 1 [F 21]**



	<b>M 135 i</b>	09.12-02.15	235		1987 <b>482 492</b>	↔ 1463		
		03.15→	240		1987 <b>482 492</b>	↔ 1463		
				HZO	1987 <b>482 492</b>	↔ 1463		
				Y45	1987 <b>482 492</b>	↔ 1463		
					1987 <b>482 492</b>	↔ 1463		
	<b>M 135 i xDrive</b>	11.12-02.15	235		1987 <b>482 492</b>	↔ 1463		
	<b>114 d</b>	11.12→	70	AAK	1987 <b>482 492</b>	↔ 1463		
				<del>AAK</del>	1987 <b>482 492</b>	↔ 1463		
		07.15→	70		1987 <b>482 492</b>	↔ 1463		
	<b>114 i</b>	09.12-02.15	75		1987 <b>482 492</b>	↔ 1463		
	<b>116 d</b>	09.12-02.15	85	AAK	1987 <b>482 492</b>	↔ 1463		
				<del>AAK</del>	1987 <b>482 492</b>	↔ 1463		
		03.15→	85	HZO	1987 <b>482 492</b>	↔ 1463		
				Y45	1987 <b>482 492</b>	↔ 1463		
	<b>116 d ed</b>	09.12-02.15	85	AAK	1987 <b>482 492</b>	↔ 1463		
				<del>AAK</del>	1987 <b>482 492</b>	↔ 1463		
				03.15→	85	HZO	1987 <b>482 492</b>	↔ 1463
				Y45	1987 <b>482 492</b>	↔ 1463		
	<b>116 i</b>	09.12-02.15	100	AAK	1987 <b>482 492</b>	↔ 1463		
				<del>AAK</del>	1987 <b>482 492</b>	↔ 1463		
		03.15→	80	HZO	1987 <b>482 492</b>	↔ 1463		
				Y45	1987 <b>482 492</b>	↔ 1463		
	<b>118 d</b>	09.12-02.15	105	AAK	1987 <b>482 492</b>	↔ 1463		
				<del>AAK</del>	1987 <b>482 492</b>	↔ 1463		
				03.15→	110	HZO	1987 <b>482 492</b>	↔ 1463
						Y45	1987 <b>482 492</b>	↔ 1463
	<b>118 d xDrive</b>	07.13-02.15	105	AAK	1987 <b>482 492</b>	↔ 1463		
				<del>AAK</del>	1987 <b>482 492</b>	↔ 1463		
	<b>118 i</b>	11.12-02.15	125	AAK	1987 <b>482 492</b>	↔ 1463		
				<del>AAK</del>	1987 <b>482 492</b>	↔ 1463		
		03.15→	100	HZO	1987 <b>482 492</b>	↔ 1463		
				Y45	1987 <b>482 492</b>	↔ 1463		
	<b>120 d</b>	11.12-02.15	135-147	AAK	1987 <b>482 492</b>	↔ 1463		
				<del>AAK</del>	1987 <b>482 492</b>	↔ 1463		
		03.15→	140	HZO	1987 <b>482 492</b>	↔ 1463		
				Y45	1987 <b>482 492</b>	↔ 1463		
	<b>120 d xDrive</b>	11.12-02.15	135-147	AAK	1987 <b>482 492</b>	↔ 1463		
				<del>AAK</del>	1987 <b>482 492</b>	↔ 1463		
		03.15→	140	HZO	1987 <b>482 492</b>	↔ 1463		
				Y45	1987 <b>482 492</b>	↔ 1463		
	<b>120 i</b>	03.15→	130	HZO	1987 <b>482 492</b>	↔ 1463		
						Y45	1987 <b>482 492</b>	↔ 1463
	<b>125 d</b>	09.12-02.15	160	AAK	1987 <b>482 492</b>	↔ 1463		
				<del>AAK</del>	1987 <b>482 492</b>	↔ 1463		
		03.15→	165	HZO	1987 <b>482 492</b>	↔ 1463		
				Y45	1987 <b>482 492</b>	↔ 1463		
	<b>125 i</b>	09.12→	160	AAK	1987 <b>482 492</b>	↔ 1463		
						<del>AAK</del>	1987 <b>482 492</b>	↔ 1463

**Serie 1 [F20]**



	<b>118 i</b>	07.15→	100	HZO	1987 <b>482 492</b>	↔ 1463
				Y45	1987 <b>482 492</b>	↔ 1463



**Serie 2 Cabrio [F 23]**

	<b>M 235 i</b>	11.14→	240		HZO	1 987 482 492	↔ 1463
					Y45	1 987 482 492	↔ 1463
		07.15→	240			1 987 482 492	↔ 1463
	<b>218 d</b>	07.15→	110			1 987 482 492	↔ 1463
	<b>218 i</b>	03.15→	100		HZO	1 987 482 492	↔ 1463
					Y45	1 987 482 492	↔ 1463
	<b>220 d</b>	11.14→	140		AAK	1 987 482 492	↔ 1463
					AAK	1 987 482 492	↔ 1463
	<b>220 i</b>	11.14→	135			1 987 482 492	↔ 1463
	<b>225 d</b>	07.15→	165			1 987 482 492	↔ 1463
<b>228 i</b>	11.14→	180			1 987 482 492	↔ 1463	

**Serie 2 Coupé [F 22]**

	<b>M 235 i</b>	03.14→	240			1 987 482 492	↔ 1463
	<b>M 235 i xDrive</b>	06.14→	240			1 987 482 492	↔ 1463
	<b>218 d</b>	03.14→	105		AAK	1 987 482 492	↔ 1463
					AAK	1 987 482 492	↔ 1463
		07.15→	110			1 987 482 492	↔ 1463
	<b>218 i</b>	03.15→	100		HZO	1 987 482 492	↔ 1463
					Y45	1 987 482 492	↔ 1463
	<b>220 d</b>	03.14-10.14	135		AAK	1 987 482 492	↔ 1463
					AAK	1 987 482 492	↔ 1463
		11.14→	140		AAK	1 987 482 492	↔ 1463
					AAK	1 987 482 492	↔ 1463
	<b>220 d xDrive</b>	03.15→	140		HZO	1 987 482 492	↔ 1463
					Y45	1 987 482 492	↔ 1463
	<b>220 i</b>	03.14→	135			1 987 482 492	↔ 1463
	<b>225 d</b>	03.14→	160		AAK	1 987 482 492	↔ 1463
				AAK	1 987 482 492	↔ 1463	
	07.15→	165			1 987 482 492	↔ 1463	
<b>228 i</b>	06.14→	180			1 987 482 492	↔ 1463	

**Serie 3 Cabrio [E 36]**

	<b>318 i</b>	01.94-12.99	85			0 986 471 919	← 54
						0 986 473 919	↻
						0 986 471 920	→ 54
						0 986 473 920	↻
	<b>320 i</b>	03.93-12.99	110			0 986 473 917	↻ ← 54
						0 986 473 918	↻ → 54
	<b>323 i</b>	05.95-09.99	125			0 986 473 917	↻ ← 54
						0 986 473 918	↻ → 54
	<b>325 i</b>	03.93-12.95	141			0 986 473 917	↻ ← 54
						0 986 473 918	↻ → 54
<b>328 i</b>	03.95-09.99	142			0 986 473 917	↻ ← 54	
					0 986 473 918	↻ → 54	

	<b>M 3, 3.2</b>	01.94-12.99	210/236				F 026 A06 122 <sup>7</sup>
	<b>318 i</b>	01.94-12.99	85			0 986 473 134	↻ ← 37,94 F 026 A06 134 <sup>7</sup>
						0 986 474 134	↻ → 37,94 F 026 A06 134 <sup>7</sup>
	<b>320 i</b>	03.93-12.95	110		AG	0 986 473 134	↻ ← 37,94 F 026 A06 134 <sup>7</sup>
						0 986 474 134	↻ → 37,94 F 026 A06 134 <sup>7</sup>
					GS	0 986 473 020	↻ ← F 026 A06 126 <sup>7</sup>
					0 986 473 019	↻ → F 026 A06 126 <sup>7</sup>	



		S							
	<b>BMW Serie 3 Cabrio [E 36]</b>								
	<b>320i</b>	09.94-12.99	110				0986 473 134	← 37,94	F 026 A06 134 <sup>7</sup>
							0986 474 134	→ 37,94	F 026 A06 134 <sup>7</sup>
	<b>323i</b>	05.95-09.99	125				0986 473 135	← 37,94	F 026 A06 134 <sup>7</sup>
							0986 474 135	→ 37,94	F 026 A06 134 <sup>7</sup>
	<b>325i</b>	03.93-12.95	141				0986 473 020	←	F 026 A06 126 <sup>7</sup>
							0986 473 019	→	F 026 A06 126 <sup>7</sup>
	<b>328i</b>	03.95-09.99	142				0986 473 135	← 37,94	F 026 A06 134 <sup>7</sup>
							0986 474 135	→ 37,94	F 026 A06 134 <sup>7</sup>
	<b>M 3</b>	01.94-12.95	210/236				1987 477 067	↔ 1631	
	<b>M 3 3.2</b>	01.96-12.99	210/236				1987 477 067	↔ 1631	
	<b>318i</b>	01.94-12.99	85				1987 477 067	↔ 1631	
	<b>320i</b>	03.93-12.99	110				1987 477 067	↔ 1631	
	<b>323i</b>	05.95-09.99	125				1987 477 067	↔ 1631	
	<b>325i</b>	03.93-12.95	141				1987 477 067	↔ 1631	
	<b>328i</b>	03.95-09.99	142				1987 477 067	↔ 1631	
	<b>M 3</b>	01.94-12.99	210/236				0986 594 015 <sup>3</sup>		
	<b>M 3 3.2</b>						0986 594 016 <sup>4</sup>		
	<b>318i</b>	01.94-12.99	85				0986 594 015 <sup>3</sup>		
							0986 594 016 <sup>4</sup>		
	<b>320i</b>	03.93-12.99	110				0986 594 015 <sup>3</sup>		
							0986 594 016 <sup>4</sup>		
	<b>323i</b>	05.95-09.99	125				0986 594 015 <sup>3</sup>		
							0986 594 016 <sup>4</sup>		
	<b>325i</b>	03.93-12.95	141				0986 594 015 <sup>3</sup>		
							0986 594 016 <sup>4</sup>		
	<b>328i</b>	03.95-09.99	142				0986 594 015 <sup>3</sup>		
							0986 594 016 <sup>4</sup>		
	<b>Serie 3 Cabrio [E 46]</b>								
	<b>318i</b>	09.01-08.06	105-110				0986 473 917	← 54	
							0986 473 918	→ 54	
	<b>320d</b>	09.00-08.06	110/				0986 473 917	← 54	
	<b>320i</b>		120-125				0986 473 918	→ 54	
	<b>323i</b>	03.00-09.00	125				0986 473 917	← 54	
							0986 473 918	→ 54	
	<b>325i</b>	09.00-08.06	141				0986 473 917	← 54	
							0986 473 918	→ 54	
	<b>330d</b>	05.00-08.06	150/170				0986 473 990	← 57	
	<b>330i</b>						0986 474 990	→ 57	
	<b>318i</b>	09.01-08.06	105-110				0986 473 159	← 39,94	F 026 A06 122 <sup>7</sup>
							0986 474 159	→ 39,94	F 026 A06 122 <sup>7</sup>
	<b>320d</b>	09.00-08.06	110/				0986 473 159	← 39,94	F 026 A06 122 <sup>7</sup>
	<b>320i</b>		120-125				0986 474 159	→ 39,94	F 026 A06 122 <sup>7</sup>
	<b>323i</b>	03.00-09.00	125				0986 473 159	← 39,94	F 026 A06 122 <sup>7</sup>
							0986 474 159	→ 39,94	F 026 A06 122 <sup>7</sup>
	<b>325i</b>	09.00-08.06	141				0986 473 159	← 39,94	F 026 A06 122 <sup>7</sup>
							0986 474 159	→ 39,94	F 026 A06 122 <sup>7</sup>
	<b>330d</b>	05.00-08.06	150/170				0986 473 160	←	F 026 A06 123 <sup>7</sup>
	<b>330i</b>						0986 474 160	→ 41,94	F 026 A06 123 <sup>7</sup>
	<b>M 3</b>	04.01-08.06	252				1987 477 531	→ 1708	
							1987 477 532	← 1693	



		<b>S</b>							
<b>318i</b>		09.01-08.06	105-110				1 987 477 531	→ 1708	
							1 987 477 532	← 1693	
<b>320d</b>		09.00-08.06	110/				1 987 477 531	→ 1708	
<b>320i</b>			120-125				1 987 477 532	← 1693	
<b>323i</b>		03.00-09.00	125				1 987 477 531	→ 1708	
							1 987 477 532	← 1693	
<b>325i</b>		09.00-08.06	141				1 987 477 531	→ 1708	
							1 987 477 532	← 1693	
<b>330d</b>		05.00-08.06	150/170				1 987 477 531	→ 1708	
<b>330i</b>							1 987 477 532	← 1693	

	<b>M 3</b>	04.01-09.02	252			0 986 594 017 <sup>4</sup>		
						0 986 594 018 <sup>3</sup>		
		10.02-08.06	252			0 986 594 513 <sup>4</sup>		
					LAB	0 986 594 527 <sup>3</sup>		
					RAB	0 986 594 528 <sup>3</sup>		
<b>318i</b>		09.01-08.06	105-110			0 986 594 513 <sup>4</sup>		
					LAB	0 986 594 527 <sup>3</sup>		
					RAB	0 986 594 528 <sup>3</sup>		
<b>320d</b>		09.00-08.06	110/			0 986 594 513 <sup>4</sup>		
<b>320i</b>			120-125		LAB	0 986 594 527 <sup>3</sup>		
					RAB	0 986 594 528 <sup>3</sup>		
<b>323i</b>		03.00-09.00	125			0 986 594 017 <sup>4</sup>		
						0 986 594 018 <sup>3</sup>		
<b>325i</b>		09.00-08.06	141			0 986 594 513 <sup>4</sup>		
					LAB	0 986 594 527 <sup>3</sup>		
					RAB	0 986 594 528 <sup>3</sup>		
<b>330d</b>		04.05-08.06	150		LAB	0 986 594 527 <sup>3</sup>		
					RAB	0 986 594 528 <sup>3</sup>		
<b>330i</b>		05.00-09.00	170			0 986 594 018 <sup>3</sup>		
					AG	0 986 594 017 <sup>4</sup>		
		08.00-09.00	170		GS	0 986 594 017 <sup>4</sup>		
		10.00-08.06	170		AG	0 986 594 513 <sup>4</sup>		
					LAB	0 986 594 527 <sup>3</sup>		
					RAB	0 986 594 528 <sup>3</sup>		

**Serie 3 Cabrio [E 93]**

	<b>318i</b>	03.10-09.13	105		PFN	0 986 134 344		← 54				
						0 986 135 344		→ 54				
	<b>320d</b>	03.08-02.10	130			0 986 134 063		← 57				
						0 986 135 063		→ 57				
						03.10-10.13	120-135		PFN	0 986 134 063		← 57
										0 986 135 063		→ 57
	<b>320i</b>	03.07-03.08	115/ 120-125		PFN	0 986 134 063		← 57				
						0 986 135 063		→ 57				
		04.08-10.13	115/ 120-125		PFN	0 986 134 344		← 54				
						0 986 135 344		→ 54				
	<b>323i</b>	09.07-04.12	130			0 986 134 063		← 57				
						0 986 135 063		→ 57				
	<b>325d</b>	09.07-02.10	145			0 986 134 324		← 57				
						0 986 135 324		→ 57				
	<b>325d</b>	03.07-09.13	150/ 155-160		PFN	0 986 134 324		← 57				
						0 986 135 324		→ 57				
						03.07-09.13	160		PFN	0 986 134 063		← 57
0 986 135 063		→ 57										
	<b>328i</b>	09.06-07.13	170-172			0 986 134 063		← 57				
						0 986 135 063		→ 57				
	<b>330d</b>	03.07-09.13	180/ 190-200		PFN	0 986 134 324		← 57				
						0 986 135 324		→ 57				







◀ BMW Serie 3 Cabrio [E 93]



	<b>318 i</b>	03.10-09.13	105		0986 134 311	
					0986 135 311	
	<b>320 d</b>	03.08-10.13	120-135		0986 134 311	
					0986 135 311	
	<b>320 i</b>	03.07-10.13	115/ 120-125	EAL, PFC	0986 134 311	
					0986 135 311	
				PFN	0986 134 311	
					0986 135 311	
	<b>323 i</b>	09.07-04.12	130	PFN	0986 134 311	
					0986 135 311	
	<b>325 d</b>	09.07-02.10	145		0986 134 084	44
					0986 135 084	44
		03.10-09.13	150	PFN	0986 134 084	44
					0986 135 084	44
	<b>325 i</b>	03.07-09.13	155-160	PFN	0986 134 311	
					0986 135 311	
	<b>328 i</b>	09.06-07.13	170-172	PFN	0986 134 311	
					0986 135 311	
	<b>330 d</b>	03.07-02.09	170		0986 134 084	44
					0986 135 084	44
	<b>330 d</b>	03.07-09.13	180/ 190-200	PFN	0986 134 084	44
	<b>330 i</b>				0986 135 084	44
	<b>335 i</b>	03.07-10.13	225-240		0986 134 084	44
					0986 135 084	44



	<b>M 3</b>	03.08-10.13	309		1987 477 950	1533
	<b>318 i</b>	03.10-09.13	105		1987 477 950	1533
	<b>320 d</b>	03.08-10.13	115/120-135		1987 477 950	1533
	<b>320 i</b>	03.07-10.13	115/120-135		1987 477 950	1533
	<b>323 i</b>	09.07-04.12	130		1987 477 950	1533
	<b>325 d</b>	09.07-09.13	145/150/155-160		1987 477 950	1533
	<b>325 i</b>	03.07-09.13	145/150/155-160		1987 477 950	1533
	<b>328 i</b>	09.06-07.13	170-172		1987 477 950	1533
	<b>330 d</b>	03.07-09.13	170/180/190-200		1987 477 950	1533
	<b>330 i</b>	03.07-09.13	170/180/190-200		1987 477 950	1533
	<b>335 i</b>	03.07-10.13	225-240		1987 477 950	1533

	<b>M 3</b>	03.08-10.13	309		0986 594 572 <sup>4</sup>		
	<b>318 i</b>	03.10-09.13	105		0986 594 514 <sup>4</sup>		
					0986 594 519 <sup>3</sup>		
	<b>320 d</b>	03.08-02.10	130	EAL	0986 594 540 <sup>3</sup>		
					0986 594 572 <sup>4</sup>		
				EAL	0986 594 519 <sup>3</sup>		
					0986 594 565 <sup>4</sup>		
			03.10-10.13	120-135		0986 594 519 <sup>3</sup>	
						0986 594 565 <sup>4</sup>	
	<b>320 i</b>	03.07-08.09	115 120-125	EAL	0986 594 565 <sup>4</sup>		
		03.07-08.13	115		0986 594 519 <sup>3</sup>		
		03.07-10.13	120-125	EAL	0986 594 540 <sup>3</sup>		
					0986 594 572 <sup>4</sup>		
				EAL	0986 594 519 <sup>3</sup>		
			09.09-08.13	115		0986 594 514 <sup>4</sup>	
			09.09-10.13	120-125	EAL	0986 594 514 <sup>4</sup>	
	<b>323 i</b>	09.07-04.12	130		0986 594 540 <sup>3</sup>		
					0986 594 572 <sup>4</sup>		
	<b>325 d</b>	03.07-09.13	145/150/ 155-160		0986 594 540 <sup>3</sup>		
	<b>325 i</b>				0986 594 572 <sup>4</sup>		

		S							
328i		09.06-07.13	170-172				0 986 594 540 <sup>3</sup>		
							0 986 594 572 <sup>4</sup>		
330d		03.07-09.13	170/180/				0 986 594 540 <sup>3</sup>		
330i			190-200				0 986 594 572 <sup>4</sup>		
335i		03.07-10.13	225-240				0 986 594 540 <sup>3</sup>		
							0 986 594 572 <sup>4</sup>		
<b>Serie 3 Compact [E 36]</b>									
	316g 316i	03.94-09.00	64-75/77				0 986 471 919	← 54	
							0 986 473 919		
							0 986 471 920	→ 54	
							0 986 473 920		
	318tds	01.95-09.00	66				0 986 471 919	← 54	
							0 986 473 919		
							0 986 471 920	→ 54	
							0 986 473 920		
	318ti	09.94-09.96	103				0 986 471 919	← 54	
							0 986 473 919		
							0 986 471 920	→ 54	
							0 986 473 920		
		12.95-09.00	103		INB		0 986 473 917	← 54	
							0 986 473 918	→ 54	
					INB		0 986 471 919	← 54	
							0 986 473 919		
							0 986 471 920	→ 54	
							0 986 473 920		
	323ti	06.97-09.00	125				0 986 473 917	← 54	
							0 986 473 918	→ 54	
	316g, i 318tds	03.94-09.00 01.95-09.00	64-75 66				0 986 475 736	↔ 22,2	
	316g 316i 318tds 318ti 323ti	03.94-09.00 09.94-09.00	64-75/77 66/103				0 986 473 075	← 33,94	
							0 986 474 075	→ 33,94	
							0 986 473 075	← 33,94	
							0 986 474 075	→ 33,94	
							0 986 473 075	← 33,94	
							0 986 474 075	→ 33,94	
	316g 316i	09.95-09.00 03.94-09.00	64-75 64-75		HTB 4SB		1 987 477 689	↔ 1740	
							1 987 477 924	↔ 1680	
					HTB 4SB		1 987 477 689	↔ 1740	
							1 987 477 924	↔ 1680	
		12.98-09.00	77				1 987 477 924	↔ 1680	
	318tds	01.95-09.00	66		HTB 4SB		1 987 477 689	↔ 1740	
							1 987 477 924	↔ 1680	
	318ti	09.94-09.00	103				1 987 477 924	↔ 1680	
	323ti	06.97-09.00	125				1 987 477 924	↔ 1680	
	316g, i 318tds, ti 323ti	03.94-09.00 09.94-09.00 06.97-09.00	64-75/77 66/103 125				0 986 594 015 <sup>3</sup>		
							0 986 594 015 <sup>3</sup>		
							0 986 594 015 <sup>3</sup>		





◀ BMW

**Serie 3 Compact [E 46]**



	316 ti	06.01-12.04	85		0986 473 917		← 54	
					0986 473 918		→ 54	
	318 td	09.01-12.04	85/105		0986 473 917		← 54	
	318 ti				0986 473 918		→ 54	
	320 td	09.01-12.04	110		0986 473 917		← 54	
					0986 473 918		→ 54	
	325 ti	06.01-12.04	141		0986 473 917		← 54	
					0986 473 918		→ 54	



	316 ti	06.01-12.04	85		0986 473 470		← 40	F 026 A06 122 <sup>7</sup>
					0986 474 470		→ 40	F 026 A06 122 <sup>7</sup>
	318 td	09.01-12.04	85/105		0986 473 159		← 39,94	F 026 A06 122 <sup>7</sup>
	318 ti				0986 474 159		→ 39,94	F 026 A06 122 <sup>7</sup>
	320 td	09.01-12.04	110		0986 473 159		← 39,94	F 026 A06 122 <sup>7</sup>
					0986 474 159		→ 39,94	F 026 A06 122 <sup>7</sup>
	325 ti	06.01-12.04	141		0986 473 159		← 39,94	F 026 A06 122 <sup>7</sup>
					0986 474 159		→ 39,94	F 026 A06 122 <sup>7</sup>



	316 ti	06.01-12.04	85		1987 477 531		→ 1708	
					1987 477 532		← 1693	
	318 td	09.01-12.04	85/105		1987 477 531		→ 1708	
	318 ti				1987 477 532		← 1693	
	320 td	09.01-12.04	110		1987 477 531		→ 1708	
					1987 477 532		← 1693	
	325 ti	06.01-12.04	141		1987 477 531		→ 1708	
					1987 477 532		← 1693	

	316 ti	06.01-12.04	85			0986 594 513 <sup>4</sup>		
					LAB	0986 594 527 <sup>3</sup>		
					RAB	0986 594 528 <sup>3</sup>		
	318 td	09.01-12.04	85/105			0986 594 513 <sup>4</sup>		
	318 ti				LAB	0986 594 527 <sup>3</sup>		
					RAB	0986 594 528 <sup>3</sup>		
	320 td	09.01-12.04	110			0986 594 513 <sup>4</sup>		
					LAB	0986 594 527 <sup>3</sup>		
					RAB	0986 594 528 <sup>3</sup>		
	325 ti	06.01-12.04	141			0986 594 513 <sup>4</sup>		
					LAB	0986 594 527 <sup>3</sup>		
					RAB	0986 594 528 <sup>3</sup>		

**Serie 3 Coupé [E 36]**



	316 i	09.93-12.99	75		0986 471 919		← 54	
					0986 473 919			
					0986 471 920		→ 54	
	318 is	03.92-08.99	103		0986 473 917		← 54	
					0986 473 918		→ 54	
	320 i	03.92-12.98	110		0986 473 917		← 54	
					0986 473 918		→ 54	
	323 i	03.95-06.99	125		0986 473 917		← 54	
					0986 473 918		→ 54	
	325 i	03.91-12.95	141		0986 473 917		← 54	
	325 is				0986 473 918		→ 54	

	328i	03.95-06.99	142					0 986 473 917	← 54	
								0 986 473 918	→ 54	
		316i	09.93-12.99	75				0 986 475 653	↔ 23,8	
		M 3, 3.2	09.92-12.98	179/210-217/236					F 026 A06 122 <sup>7</sup>	
		316i	09.93-12.99	75				0 986 473 020	← F 026 A06 126 <sup>7</sup>	
								0 986 473 019	→ F 026 A06 126 <sup>7</sup>	
		318is	03.92-08.99	103				0 986 473 020	← F 026 A06 126 <sup>7</sup>	
								0 986 473 019	→ F 026 A06 126 <sup>7</sup>	
		320i	03.92-12.95	110				0 986 471 875	← 34	
								0 986 471 876	→ 34	
			09.94-12.98	110				0 986 473 020	← F 026 A06 126 <sup>7</sup>	
								0 986 473 019	→ F 026 A06 126 <sup>7</sup>	
		323i	03.95-06.99	125		INB		0 986 473 135	← 37,94 F 026 A06 134 <sup>7</sup>	
						INB		0 986 474 135	→ 37,94 F 026 A06 134 <sup>7</sup>	
								0 986 473 020	← F 026 A06 126 <sup>7</sup>	
								0 986 473 019	→ F 026 A06 126 <sup>7</sup>	
		325i	03.91-12.95	141				0 986 473 020	← F 026 A06 126 <sup>7</sup>	
		325is						0 986 473 019	→ F 026 A06 126 <sup>7</sup>	
		328i	03.95-06.99	142		INB		0 986 473 135	← 37,94 F 026 A06 134 <sup>7</sup>	
						INB		0 986 474 135	→ 37,94 F 026 A06 134 <sup>7</sup>	
								0 986 473 020	← F 026 A06 126 <sup>7</sup>	
								0 986 473 019	→ F 026 A06 126 <sup>7</sup>	
		M 3	09.92-12.96	179/210-217/236				1 987 477 067	↔ 1631	
		M 3 3.2	10.95-12.98	179/210-217/236				1 987 477 067	↔ 1631	
		316i	09.93-12.99	75				1 987 477 181	↔ 1764	
		318is	03.92-08.99	103				1 987 477 067	↔ 1631	
		320i	03.92-12.98	110				1 987 477 067	↔ 1631	
		323i	03.95-06.99	125				1 987 477 067	↔ 1631	
		325i	03.92-12.95	141				1 987 477 067	↔ 1631	
		325is	03.91-09.95	141				1 987 477 067	↔ 1631	
		328i	03.95-06.99	142				1 987 477 067	↔ 1631	
		M 3	09.92-12.98	179/210-217/				0 986 594 015 <sup>3</sup>		
		M 3 3.2		236				0 986 594 016 <sup>4</sup>		
		316i	09.93-12.99	75				0 986 594 015 <sup>3</sup>		
								0 986 594 016 <sup>4</sup>		
		318is	03.92-08.99	103				0 986 594 015 <sup>3</sup>		
								0 986 594 016 <sup>4</sup>		
		320i	03.92-12.98	110				0 986 594 015 <sup>3</sup>		
								0 986 594 016 <sup>4</sup>		
		323i	03.95-06.99	125				0 986 594 015 <sup>3</sup>		
								0 986 594 016 <sup>4</sup>		
		325i	03.91-12.95	141				0 986 594 015 <sup>3</sup>		
		325is						0 986 594 016 <sup>4</sup>		
		328i	03.95-06.99	142				0 986 594 015 <sup>3</sup>		
								0 986 594 016 <sup>4</sup>		
	<b>Serie 3 Coupé [E 46]</b>									
		316i	10.99-05.06	75/85				0 986 473 917	← 54	
								0 986 473 918	→ 54	
		318i	04.99-05.06	87/105-110				0 986 473 917	← 54	
								0 986 473 918	→ 54	



		S							
	◀ BMW Serie 3 Coupé [E 46]								
	320 d	04.98-05.06	110/				0986 473 917		← 54
	320 i		120-125				0986 473 918		→ 54
	323 i	04.98-09.00	125				0986 473 917		← 54
							0986 473 918		→ 54
	325 i	09.00-05.06	137/141				0986 473 917		← 54
							0986 473 918		→ 54
	328 i	04.98-09.00	142				0986 473 917		← 54
							0986 473 918		→ 54
	330 d	05.00-05.06	150/170				0986 473 990		← 57
	330 i						0986 474 990		→ 57
	316 i	10.99-05.06	75/85				0986 473 470		← 40
							0986 474 470		→ 40
	318 i	04.99-09.01	87				0986 473 470		← 40
							0986 474 470		→ 40
		09.01-05.06	105-110				0986 473 159		← 39,94
							0986 474 159		→ 39,94
	320 d	04.98-05.06	110/				0986 473 159		← 39,94
	320 i		120-125				0986 474 159		→ 39,94
	323 i	04.98-09.00	125				0986 473 159		← 39,94
							0986 474 159		→ 39,94
	325 i	09.00-05.06	137/141				0986 473 159		← 39,94
							0986 474 159		→ 39,94
	328 i	04.98-09.00	142				0986 473 159		← 39,94
							0986 474 159		→ 39,94
	330 d	05.00-05.06	150/170				0986 473 160		←
	330 i						0986 474 160		→ 41,94
	M 3	09.00-05.06	252/265				1987 477 531		→ 1708
	M 3 CSL						1987 477 532		← 1693
	316 i	10.99-05.06	75/85				1987 477 531		→ 1708
							1987 477 532		← 1693
	318 i	04.99-05.06	87/105-110				1987 477 531		→ 1708
							1987 477 532		← 1693
	320 d	04.98-05.06	110/				1987 477 531		→ 1708
	320 i		120-125				1987 477 532		← 1693
	323 i	04.98-09.00	125				1987 477 531		→ 1708
							1987 477 532		← 1693
	325 i	09.00-05.06	137/141				1987 477 531		→ 1708
							1987 477 532		← 1693
	328 i	04.98-09.00	142				1987 477 531		→ 1708
							1987 477 532		← 1693
	330 d	05.00-05.06	150/170				1987 477 531		→ 1708
	330 i						1987 477 532		← 1693
	M 3	09.00-09.02	252				0986 594 017 <sup>4</sup>		
							0986 594 018 <sup>3</sup>		
		10.02-05.06	252				0986 594 513 <sup>4</sup>		
						LAB	0986 594 527 <sup>3</sup>		
						RAB	0986 594 528 <sup>3</sup>		
	M 3 CSL	03.03-12.03	265				0986 594 513 <sup>4</sup>		
						LAB	0986 594 527 <sup>3</sup>		
						RAB	0986 594 528 <sup>3</sup>		
	316 i	10.99-09.00	75				0986 594 017 <sup>4</sup>		
							0986 594 018 <sup>3</sup>		
		10.00-09.02	75				0986 594 513 <sup>4</sup>		
						LAB	0986 594 527 <sup>3</sup>		
						RAB	0986 594 528 <sup>3</sup>		

		S							
316 i		03.02-05.06	85						
						LAB	0 986 594 513 <sup>4</sup>		
						RAB	0 986 594 527 <sup>3</sup>		
318 i		04.99-09.00	87				0 986 594 528 <sup>3</sup>		
		04.99-09.01	87			TW	0 986 594 017 <sup>4</sup>		
		09.00-09.01	87			LAB,TW	0 986 594 018 <sup>3</sup>		
						RAB,TW	0 986 594 527 <sup>3</sup>		
		10.00-09.01	87				0 986 594 528 <sup>3</sup>		
		09.01-05.06	105-110				0 986 594 513 <sup>4</sup>		
						LAB	0 986 594 527 <sup>3</sup>		
						RAB	0 986 594 528 <sup>3</sup>		
320 d		09.03-05.06	110				0 986 594 513 <sup>4</sup>		
						LAB	0 986 594 527 <sup>3</sup>		
						RAB	0 986 594 528 <sup>3</sup>		
320 i		04.98-09.00	110				0 986 594 513 <sup>4</sup>		
							0 986 594 017 <sup>4</sup>		
		09.00-05.06	120-125				0 986 594 018 <sup>3</sup>		
						LAB	0 986 594 513 <sup>4</sup>		
						RAB	0 986 594 527 <sup>3</sup>		
		10.00-09.01	110				0 986 594 528 <sup>3</sup>		
						LAB	0 986 594 513 <sup>4</sup>		
						RAB	0 986 594 527 <sup>3</sup>		
323 i		04.98-09.00	125				0 986 594 528 <sup>3</sup>		
							0 986 594 017 <sup>4</sup>		
							0 986 594 018 <sup>3</sup>		
325 i		09.00-05.06	137/141				0 986 594 513 <sup>4</sup>		
						LAB	0 986 594 527 <sup>3</sup>		
						RAB	0 986 594 528 <sup>3</sup>		
328 i		04.98-09.00	142				0 986 594 513 <sup>4</sup>		
							0 986 594 017 <sup>4</sup>		
							0 986 594 018 <sup>3</sup>		
330 d		03.03-05.06	150			LAB	0 986 594 513 <sup>4</sup>		
						RAB	0 986 594 527 <sup>3</sup>		
							0 986 594 528 <sup>3</sup>		
330 i		05.00-09.00	170				0 986 594 018 <sup>3</sup>		
						AG	0 986 594 513 <sup>4</sup>		
		08.00-09.00	170			GS	0 986 594 017 <sup>4</sup>		
		10.00-05.06	170			AG	0 986 594 513 <sup>4</sup>		
						LAB	0 986 594 527 <sup>3</sup>		
						RAB	0 986 594 528 <sup>3</sup>		
<b>Serie 3 Coupé [E 92]</b>									
	316 i	09.07-06.13	90			PFN	0 986 134 344		← 54
							0 986 135 344		→ 54
	318 i	03.10-06.13	105			PFN	0 986 134 344		← 54
							0 986 135 344		→ 54
	320 d	03.10-06.13	120-135			PFN	0 986 134 063		← 57
							0 986 135 063		→ 57
	320 d xDrive	03.10-06.13	120-135				0 986 134 063		← 57
							0 986 135 063		→ 57
	320 d	03.07-02.10	130				0 986 134 063		← 57
	320 d xDrive						0 986 135 063		→ 57
	320 i	03.07-06.13	115/ 120-125			PFN	0 986 134 344		← 54
							0 986 135 344		→ 54
	323 i	09.06-02.12	130				0 986 134 063		← 57
							0 986 135 063		→ 57
	325 d	03.07-02.10	145				0 986 134 324		← 57
							0 986 135 324		→ 57
	325 d	09.07-06.13	150/ 155-160			PFN	0 986 134 324		← 57
	325 i						0 986 135 324		→ 57
	325 i	09.06-09.07	160				0 986 134 324		← 57
							0 986 135 324		→ 57
		09.06-06.13	160				0 986 134 063		← 57
							0 986 135 063		→ 57



		S							
	<b>BMW Serie 3 Coupé [E 92]</b>								
<b>325 i xDrive</b>		09.08-06.13	160				0986 134 324		← 57
							0986 135 324		→ 57
<b>325 i xDrive</b>		09.07-04.13	160				0986 134 063		← 57
<b>325 xi</b>							0986 135 063		→ 57
<b>325 xi</b>		09.06-08.08	160				0986 134 324		← 57
							0986 135 324		→ 57
<b>328 i</b>		09.06-06.13	172				0986 134 063		← 57
							0986 135 063		→ 57
<b>330 d</b>		09.08-06.13	180		PFN		0986 134 324		← 57
							0986 135 324		→ 57
<b>330 d xDrive</b>		09.08-06.13	180				0986 134 324		← 57
							0986 135 324		→ 57
<b>330 i</b>		09.06-08.12	200				0986 134 324		← 57
							0986 135 324		→ 57
		09.07-06.13	200		PFN		0986 134 324		← 57
							0986 135 324		→ 57
<b>330 i xDrive</b>		09.06-06.13	200				0986 134 324		← 57
<b>330 xi</b>							0986 135 324		→ 57
	<b>316 i</b>	09.07-06.13	90		PFC		0986 134 311		←
							0986 135 311		→
	<b>318 i</b>	03.10-06.13	105				0986 134 311		←
							0986 135 311		→
	<b>320 d, d xDrive, i</b>	03.07-06.13	115/ 120-135				0986 134 311		←
							0986 135 311		→
	<b>323 i</b>	09.06-02.12	130				0986 134 311		←
							0986 135 311		→
	<b>325 d</b>	03.07-02.10	145				0986 134 084		← 44
							0986 135 084		→ 44
		03.10-06.13	150		PFN		0986 134 084		← 44
							0986 135 084		→ 44
	<b>325 i, i xDrive, xi</b>	09.06-06.13	155-160				0986 134 311		←
							0986 135 311		→
	<b>328 i</b>	09.06-06.13	172				0986 134 311		←
							0986 135 311		→
	<b>330 d</b>	09.08-06.13	180/200		PFN		0986 134 084		← 44
							0986 135 084		→ 44
	<b>330 d xDrive</b>	09.08-06.13	180/200				0986 134 084		← 44
							0986 135 084		→ 44
	<b>330 d</b>	09.06-08.08	170				0986 134 084		← 44
	<b>330 xd</b>						0986 135 084		→ 44
	<b>330 i</b>	09.06-06.13	180/200		PFN		0986 134 084		← 44
							0986 135 084		→ 44
	<b>330 i xDrive</b>	09.06-06.13	180/200				0986 134 084		← 44
	<b>330 xi</b>						0986 135 084		→ 44
	<b>335 d, i, i xDrive, xi</b>	09.06-06.13	210/ 225-240				0986 134 084		← 44
							0986 135 084		→ 44
	<b>M 3</b>	05.07-06.13	309				1987 477 950		↔ 1533
	<b>316 i</b>	09.07-06.13	90				1987 477 950		↔ 1533
	<b>318 i</b>	03.10-06.13	105				1987 477 950		↔ 1533
	<b>320 d</b>	03.07-06.13	115/120-135				1987 477 950		↔ 1533
	<b>320 d xDrive</b>	09.08-06.13	115/120-135				1987 477 950		↔ 1533
	<b>320 i</b>	03.07-06.13	115/120-135				1987 477 950		↔ 1533
	<b>323 i</b>	09.06-02.12	130				1987 477 950		↔ 1533
	<b>325 d</b>	03.07-06.13	145/150/155-160				1987 477 950		↔ 1533
	<b>325 i</b>	09.06-06.13	145/150/155-160				1987 477 950		↔ 1533
	<b>325 i xDrive</b>	09.08-06.13	145/150/155-160				1987 477 950		↔ 1533
	<b>325 xi</b>	09.06-08.08	145/150/155-160				1987 477 950		↔ 1533
	<b>328 i</b>	09.06-06.13	172				1987 477 950		↔ 1533













		S							
330 d		09.06-06.13	170/180/200				1 987 477 950	↔ 1533	
330 d xDrive		09.08-06.13	170/180/200				1 987 477 950	↔ 1533	
330 i		09.06-06.13	170/180/200				1 987 477 950	↔ 1533	
330 i xDrive		09.08-06.13	170/180/200				1 987 477 950	↔ 1533	
330 xd		09.06-08.08	170/180/200				1 987 477 950	↔ 1533	
330 xi		09.06-08.08	170/180/200				1 987 477 950	↔ 1533	
335 d		09.06-03.13	210/225-240				1 987 477 950	↔ 1533	
335 i		09.06-06.13	210/225-240				1 987 477 950	↔ 1533	
335 i xDrive		09.08-06.13	210/225-240				1 987 477 950	↔ 1533	
335 xi		09.07-08.08	210/225-240				1 987 477 950	↔ 1533	
<b>M 3</b>									
	M 3	05.07-06.13	309				0 986 594 572 <sup>4</sup>		
	316 i	09.07-06.13	90				0 986 594 514 <sup>4</sup>		
							0 986 594 519 <sup>3</sup>		
	318 i	03.10-06.13	105				0 986 594 514 <sup>4</sup>		
							0 986 594 519 <sup>3</sup>		
	320 d	03.07-02.10	130		EAL		0 986 594 540 <sup>3</sup>		
							0 986 594 571 <sup>4</sup>		
					EAL		0 986 594 514 <sup>4</sup>		
							0 986 594 519 <sup>3</sup>		
		03.10-06.13	120-135				0 986 594 514 <sup>4</sup>		
							0 986 594 519 <sup>3</sup>		
	320 d xDrive	09.08-02.10	130				0 265 007 669 <sup>3</sup>		
		03.10-06.13	120-135				0 265 007 669 <sup>3</sup>		
	320 i	03.07-06.13	115				0 986 594 514 <sup>4</sup>		
							0 986 594 519 <sup>3</sup>		
			120-125		EAL		0 986 594 540 <sup>3</sup>		
							0 986 594 572 <sup>4</sup>		
					EAL		0 986 594 514 <sup>4</sup>		
							0 986 594 519 <sup>3</sup>		
	323 i	09.06-02.12	130				0 986 594 540 <sup>3</sup>		
							0 986 594 571 <sup>4</sup>		
	325 d	03.07-06.13	145/150				0 986 594 540 <sup>3</sup>		
							0 986 594 572 <sup>4</sup>		
	325 i	09.06-06.13	160				0 986 594 540 <sup>3</sup>		
							0 986 594 571 <sup>4</sup>		
		09.07-06.13	155-160				0 986 594 540 <sup>3</sup>		
							0 986 594 571 <sup>4</sup>		
	325 i xDrive, xi	09.06-06.13	160				0 265 007 669 <sup>3</sup>		
	328 i	09.06-06.13	172				0 986 594 540 <sup>3</sup>		
							0 986 594 571 <sup>4</sup>		
	330 d xDrive, i xDrive, xd, xi	09.06-06.13	170/180/200				0 265 007 669 <sup>3</sup>		
	330 d	09.06-06.13	170/180/				0 986 594 540 <sup>3</sup>		
	330 i		200				0 986 594 572 <sup>4</sup>		
	335 d	09.06-03.13	210				0 986 594 540 <sup>3</sup>		
							0 986 594 572 <sup>4</sup>		
	335 i	09.06-06.13	225-240				0 986 594 540 <sup>3</sup>		
							0 986 594 572 <sup>4</sup>		
	335 i xDrive, xi	09.07-06.13	225-240				0 265 007 669 <sup>3</sup>		
<b>Serie 3 [E 36]</b>									
	316 i	09.90-12.98	73-75/85				0 986 471 919	← 54	
							0 986 473 919		
							0 986 471 920	→ 54	
							0 986 473 920		
	318 i	12.90-02.94	83-85				0 986 471 919	← 54	
							0 986 473 919		
							0 986 471 920	→ 54	
							0 986 473 920		
		03.92-08.98	103				0 986 473 917	← 54	
							0 986 473 918	→ 54	





		S													
	◀ BMW Serie 3 [E 36]														
	318 i	11.92-10.98	85				0986 471 919	← 54							
							0986 473 919								
		09.93-12.98	85		INB	0986 471 919		← 54							
						0986 473 918		→ 54							
						0986 471 919		← 54							
						0986 473 919									
	318 is	03.93-12.96	103		INB	0986 473 917		← 54							
						0986 473 918		→ 54							
		03.95-12.98	103		INB	0986 471 919		← 54							
						0986 473 919									
						0986 471 920		→ 54							
						0986 473 920									
318 tds	10.94-03.98	66		INB	0986 473 917		← 54								
					0986 473 918		→ 54								
				INB	0986 471 919		← 54								
					0986 473 919										
					0986 471 920		→ 54								
					0986 473 920										
320 i	09.90-12.98	95/110			0986 473 917		← 54								
					0986 473 918		→ 54								
323 i	10.94-04.99	125/140			0986 473 917		← 54								
					0986 473 918		→ 54								
325 i, td, tds	09.90-12.98	85/105/138/141			0986 473 917		← 54								
					0986 473 918		→ 54								
328 i	10.94-12.98	142/148			0986 473 917		← 54								
					0986 473 918		→ 54								
	316 i	09.90-12.98	73-75/85				0986 475 653	↔ 23,8							
	318 i, tds	12.90-12.98	66/83-85				0986 475 653	↔ 23,8							
	M 3, 3.2	01.94-06.98	179/210/236						F 026 A06 122 <sup>7</sup>						
	316 i	09.90-12.98	73-75/85				0986 473 020		← F 026 A06 126 <sup>7</sup>						
	318 i, is, tds	12.90-12.98	66/83-85/ 103				0986 473 019		→ F 026 A06 126 <sup>7</sup>						
							0986 473 020		← F 026 A06 126 <sup>7</sup>						
	320 i	10.91-10.96	95				0986 473 020		← F 026 A06 126 <sup>7</sup>						
							0986 473 019		→ F 026 A06 126 <sup>7</sup>						
		09.94-12.98	110					0986 473 020		← F 026 A06 126 <sup>7</sup>					
								0986 473 019		→ F 026 A06 126 <sup>7</sup>					
		ABO	09.90-12.95	110					0986 471 875		← 34				
									0986 471 876		→ 34				
	ABS	09.90-12.95	110					0986 473 020		← F 026 A06 126 <sup>7</sup>					
								0986 473 019		→ F 026 A06 126 <sup>7</sup>					
	323 i	10.94-12.98	125			INB		0986 473 135		← 37,94 F 026 A06 134 <sup>7</sup>					
								0986 474 135		→ 37,94 F 026 A06 134 <sup>7</sup>					
								0986 473 020		←	F 026 A06 126 <sup>7</sup>				
												0986 473 019		→	F 026 A06 126 <sup>7</sup>
03.96-04.99								140							
												0986 474 135		→ 37,94 F 026 A06 134 <sup>7</sup>	
10.96-10.98		125						0986 473 135		← 37,94 F 026 A06 134 <sup>7</sup>					
								0986 474 135		→ 37,94 F 026 A06 134 <sup>7</sup>					
325 i		09.90-12.98	105/138/ 141					0986 473 020		← F 026 A06 126 <sup>7</sup>					
								0986 473 019		→ F 026 A06 126 <sup>7</sup>					



		S							
<b>325td</b>		ABO	09.91-12.98	85			0 986 471 875	← 34	
							0 986 471 876	→ 34	
		ABS	09.91-12.98	85			0 986 473 020	←	F 026 A06 126 <sup>7</sup>
							0 986 473 019	→	F 026 A06 126 <sup>7</sup>
<b>328i</b>			10.94-12.98	142		INB	0 986 473 135	← 37,94	F 026 A06 134 <sup>7</sup>
							0 986 474 135	→ 37,94	F 026 A06 134 <sup>7</sup>
						INB	0 986 473 020	←	F 026 A06 126 <sup>7</sup>
							0 986 473 019	→	F 026 A06 126 <sup>7</sup>
			08.95-10.98	148			0 986 473 135	← 37,94	F 026 A06 126 <sup>7</sup>
							0 986 474 135	→ 37,94	F 026 A06 126 <sup>7</sup>
									
	<b>M 3</b>		01.94-09.95	179/210/236			1 987 477 067	↔ 1631	
	<b>M 3 3.2</b>		10.95-06.98	179/210/236			1 987 477 067	↔ 1631	
	<b>316i</b>		09.90-12.98	73-75		HTB	1 987 477 181	↔ 1764	
						4SB	1 987 477 067	↔ 1631	
			10.91-10.94	85			1 987 477 067	↔ 1631	
	<b>318i</b>		12.90-12.98	66/83-85		HTB	1 987 477 181	↔ 1764	
						4SB	1 987 477 067	↔ 1631	
			03.92-08.98	103			1 987 477 067	↔ 1631	
	<b>318is</b>		03.93-12.98	103			1 987 477 067	↔ 1631	
	<b>318tds</b>		10.94-03.98	66/83-85		HTB	1 987 477 181	↔ 1764	
						4SB	1 987 477 067	↔ 1631	
	<b>320i</b>		09.90-12.98	95/110			1 987 477 067	↔ 1631	
	<b>323i</b>		10.94-04.99	125/140			1 987 477 067	↔ 1631	
	<b>325i</b>		09.90-12.95	85/105/138/141			1 987 477 067	↔ 1631	
	<b>325td</b>		09.91-12.98	85/105/138/141			1 987 477 067	↔ 1631	
	<b>325tds</b>		05.93-12.98	85/105/138/141			1 987 477 067	↔ 1631	
	<b>328i</b>		10.94-12.98	142/148			1 987 477 067	↔ 1631	
	<b>M 3</b>		01.94-06.98	179/210/			0 986 594 015 <sup>3</sup>		
	<b>M 3 3.2</b>			236			0 986 594 016 <sup>4</sup>		
	<b>316i</b>		09.90-12.98	73-75/85			0 986 594 015 <sup>3</sup>		
							0 986 594 016 <sup>4</sup>		
	<b>318i, is, tds</b>		12.90-12.98	66/83-85/			0 986 594 015 <sup>3</sup>		
				103			0 986 594 016 <sup>4</sup>		
	<b>320i</b>		09.90-12.98	95/110			0 986 594 015 <sup>3</sup>		
							0 986 594 016 <sup>4</sup>		
	<b>323i</b>		10.94-04.99	125/140			0 986 594 015 <sup>3</sup>		
							0 986 594 016 <sup>4</sup>		
	<b>325i, td, tds</b>		09.90-12.98	85/105/			0 986 594 015 <sup>3</sup>		
				138/141			0 986 594 016 <sup>4</sup>		
	<b>328i</b>		10.94-12.98	142/148			0 986 594 015 <sup>3</sup>		
							0 986 594 016 <sup>4</sup>		
<b>Serie 3 [E 46]</b>									
									
	<b>316i</b>		04.98-03.05	75/77/85			0 986 473 917	← 54	
							0 986 473 918	→ 54	
	<b>318d</b>		04.98-03.05	85/87/105			0 986 473 917	← 54	
	<b>318i</b>						0 986 473 918	→ 54	
	<b>320d</b>		04.98-03.05	100/110/			0 986 473 917	← 54	
	<b>320i</b>			120-125			0 986 473 918	→ 54	
	<b>323i</b>		04.98-12.03	125/135			0 986 473 917	← 54	
							0 986 473 918	→ 54	
	<b>325i</b>		09.02-12.04	137			0 986 473 917	← 54	
							0 986 473 918	→ 54	
	<b>325i</b>		09.00-03.05	141			0 986 473 917	← 54	
	<b>325xi</b>						0 986 473 990	← 57	
							0 986 473 918	→ 54	
							0 986 474 990	→ 57	



		S							
	◀ BMW Serie 3 [E 46]								
	328 i	04.98-09.00	142				0986 473 917		54
							0986 473 918		54
	330 d, i, xd, xi	10.99-04.05	135/150/ 170				0986 473 990		57
							0986 474 990		57
	316 i	04.98-09.02	75				0986 473 470		40
							0986 474 470		40
			77		INB		0986 473 159		39,94
							0986 474 159		39,94
					INB		0986 473 470		40
							0986 474 470		40
		02.02-03.05	85		INB		0986 473 159		39,94
							0986 474 159		39,94
					INB		0986 473 470		40
							0986 474 470		40
		03.02-03.05	85				0986 473 470		40
							0986 474 470		40
	318 d	09.01-03.05	85				0986 473 159		39,94
							0986 474 159		39,94
	318 i	04.98-09.01	87		INB		0986 473 159		39,94
							0986 474 159		39,94
					INB		0986 473 470		40
							0986 474 470		40
		11.98-09.01	87				0986 473 470		40
							0986 474 470		40
		09.01-03.05	105				0986 473 159		39,94
							0986 474 159		39,94
	320 d	04.98-03.05	100/110/ 120-125				0986 473 159		39,94
	320 i						0986 474 159		39,94
	323 i	04.98-12.03	125/135				0986 473 159		39,94
							0986 474 159		39,94
	325 i	09.00-03.05	141		NON		0986 473 159		39,94
							0986 474 159		39,94
		09.02-12.04	137				0986 473 159		39,94
							0986 474 159		39,94
	325 xi	09.00-03.05	141		294		0986 473 159		39,94
							0986 474 159		39,94
	328 i	04.98-09.00	142				0986 473 159		39,94
							0986 474 159		39,94
	330 d	10.99-04.05	135/150/ 170				0986 473 160		
	330 i						0986 474 160		41,94
	316 i	04.98-03.05	75/77/85				1987 477 531		1708
							1987 477 532		1693
	318 d	04.98-03.05	85/87/105				1987 477 531		1708
	318 i						1987 477 532		1693
	320 d	04.98-03.05	100/110/ 120-125				1987 477 531		1708
	320 i						1987 477 532		1693
	323 i	04.98-12.03	125/135				1987 477 531		1708
							1987 477 532		1693
	325 i	09.00-03.05	137/141				1987 477 531		1708
	325 xi						1987 477 532		1693
	328 i	04.98-09.00	142				1987 477 531		1708
							1987 477 532		1693
	330 d, i, xd, xi	10.99-04.05	135/150/ 170				1987 477 531		1708
							1987 477 532		1693
	316 i	04.98-09.00	75/77				0986 594 017 <sup>4</sup>		
							0986 594 018 <sup>3</sup>		

		S								
316 i		10.00-09.02	75/77						0 986 594 513 <sup>4</sup>	
							LAB		0 986 594 527 <sup>3</sup>	
							RAB		0 986 594 528 <sup>3</sup>	
		02.02-03.05	85						0 986 594 513 <sup>4</sup>	
							LAB		0 986 594 527 <sup>3</sup>	
							RAB		0 986 594 528 <sup>3</sup>	
318 d		09.01-03.05	85						0 986 594 513 <sup>4</sup>	
							LAB		0 986 594 527 <sup>3</sup>	
							RAB		0 986 594 528 <sup>3</sup>	
318 i		04.98-09.00	87						0 986 594 017 <sup>4</sup>	
									0 986 594 018 <sup>3</sup>	
									0 986 594 513 <sup>4</sup>	
				LAB		0 986 594 527 <sup>3</sup>				
				RAB		0 986 594 528 <sup>3</sup>				
				09.01-03.05	105					0 986 594 513 <sup>4</sup>
320 d		10.00-09.01	100						0 986 594 513 <sup>4</sup>	
							LAB		0 986 594 527 <sup>3</sup>	
							RAB		0 986 594 528 <sup>3</sup>	
320 d		04.98-09.00	100						0 986 594 017 <sup>4</sup>	
									0 986 594 018 <sup>3</sup>	
320 i		10.00-03.05	110						0 986 594 513 <sup>4</sup>	
							LAB		0 986 594 527 <sup>3</sup>	
							RAB		0 986 594 528 <sup>3</sup>	
320 i		04.98-09.00	110						0 986 594 017 <sup>4</sup>	
									0 986 594 018 <sup>3</sup>	
		09.00-03.05	120-125							0 986 594 513 <sup>4</sup>
								LAB		0 986 594 527 <sup>3</sup>
								RAB		0 986 594 528 <sup>3</sup>
323 i		04.98-09.00	125						0 986 594 017 <sup>4</sup>	
									0 986 594 018 <sup>3</sup>	
		03.99-09.00	135						0 986 594 017 <sup>4</sup>	
325 i		09.00-03.05	137/141						0 986 594 513 <sup>4</sup>	
							LAB		0 986 594 527 <sup>3</sup>	
							RAB		0 986 594 528 <sup>3</sup>	
328 i		04.98-09.00	142						0 986 594 017 <sup>4</sup>	
									0 986 594 018 <sup>3</sup>	
									0 986 594 018 <sup>3</sup>	
330 d		10.99-09.00	135						0 986 594 018 <sup>3</sup>	
									0 986 594 018 <sup>3</sup>	
		10.00-04.03	135							LAB 0 986 594 527 <sup>3</sup>
										RAB 0 986 594 528 <sup>3</sup>
										LAB 0 986 594 527 <sup>3</sup>
		03.03-03.05	150					RAB 0 986 594 528 <sup>3</sup>		
330 i		05.00-09.00	170						0 986 594 018 <sup>3</sup>	
									AG 0 986 594 017 <sup>4</sup>	
									GS 0 986 594 017 <sup>4</sup>	
		08.00-09.00	170							0 986 594 017 <sup>4</sup>
										AG 0 986 594 513 <sup>4</sup>
										LAB 0 986 594 527 <sup>3</sup>
		10.00-04.05	170					RAB 0 986 594 528 <sup>3</sup>		







































































**Serie 3 [E 90]**

	316 d	09.09-10.11	85						0 986 134 344  ← 54
									0 986 135 344  → 54
	316 i	09.07-10.11	90			PFN			0 986 134 344  ← 54
									0 986 135 344  → 54
		10.07-10.11	85			PFN			0 986 134 344  ← 54
									0 986 135 344  → 54
318 d	09.05-09.07	90				ERH,PFN			0 986 134 063  ← 57
									0 986 135 063  → 57
318 d	09.07-10.11	100-105				PFN			0 986 134 344  ← 54
318 i									0 986 135 344  → 54



◀ BMW Serie 3 [E 90]								
<b>318 i</b>	09.05-08.07	95-100	PFN	0986 134 063		←	57	
				0986 135 063		→	57	
	09.07-08.08	95-100	312,PFN	0986 134 063		←	57	
				0986 135 063		→	57	
	09.07-10.11	95-100	PFN	0986 134 344		←	54	
				0986 135 344		→	54	
<b>320 d</b>	03.05-09.07	120	ERH,PFN	0986 134 324		←	57	
				0986 135 324		→	57	
			NON,PFN	0986 134 063		←	57	
				0986 135 063		→	57	
	09.05-09.07	110	ERH,PFN	0986 134 324		←	57	
				0986 135 324		→	57	
	09.07-03.10	130	ERH,PFN	0986 134 324		←	57	
				0986 135 324		→	57	
			312,NON,PFN	0986 134 063		←	57	
				0986 135 063		→	57	
	03.10-12.11	120-135	ERH,PFN	0986 134 324		←	57	
				0986 135 324		→	57	
312,NON,PFN			0986 134 063		←	57		
			0986 135 063		→	57		
03.10-11.11	120	BHO	0986 134 324		←	57		
			0986 135 324		→	57		
		312,BHO	0986 134 063		←	57		
			0986 135 063		→	57		
<b>320 d xDrive</b>	09.08-02.10	120-130	BHO	0986 134 324		←	57	
				0986 135 324		→	57	
			312,BHO	0986 134 063		←	57	
				0986 135 063		→	57	
	03.10-10.11	120-135	BHO	0986 134 324		←	57	
				0986 135 324		→	57	
			312,BHO	0986 134 063		←	57	
				0986 135 063		→	57	
<b>320 i</b>	03.05-08.07	110-115	ERH,PFN	0986 134 063		←	57	
				0986 135 063		→	57	
	09.07-12.11	110-115	NON,PFN	0986 134 344		←	54	
				0986 135 344		→	54	
			312,ERH,PFN	0986 134 063		←	57	
				0986 135 063		→	57	
	120-125	NON,PFN	0986 134 344		←	54		
			0986 135 344		→	54		
312,ERH,PFN		0986 134 063		←	57			
		0986 135 063		→	57			
<b>320 si</b>	03.06-09.06	127		0986 134 063		←	57	
				0986 135 063		→	57	
<b>323 i</b>	09.05-12.11	130	PFN	0986 134 063		←	57	
				0986 135 063		→	57	
<b>325 d</b>	09.06-02.10	145	PFN	0986 134 324		←	57	
				0986 135 324		→	57	
	03.10-10.11	150	NON,PFN	0986 134 324		←	57	
				0986 135 324		→	57	
<b>325 i</b>	03.05-08.07	160	PFN	0986 134 063		←	57	
				0986 135 063		→	57	
	03.05-12.11	160	PFN	0986 134 324		←	57	
				0986 135 324		→	57	
	09.07-12.11	155-160	ERH,PFN	0986 134 324		←	57	
				0986 135 324		→	57	
			312,NON,PFN	0986 134 063		←	57	
				0986 135 063		→	57	
160	312,PFN	0986 134 063		←	57			
		0986 135 063		→	57			



	<b>S</b>							
<b>325 i xDrive</b>	09.08-10.11	160			312, NON	0 986 <b>134 063</b>	 ← 57	
						0 986 <b>135 063</b>	 → 57	
<b>325 i xDrive</b>	09.05-10.11	160			ERH	0 986 <b>134 324</b>	 ← 57	
<b>325 xi</b>						0 986 <b>135 324</b>	 → 57	
<b>325 xi</b>	09.05-09.07	160			NON	0 986 <b>134 063</b>	 ← 57	
						0 986 <b>135 063</b>	 → 57	
	09.07-08.08	160			312, NON	0 986 <b>134 063</b>	 ← 57	
						0 986 <b>135 063</b>	 → 57	
<b>328 i</b>	09.06-08.07	170-172			PFN	0 986 <b>134 063</b>	 ← 57	
						0 986 <b>135 063</b>	 → 57	
<b>330 d</b>	09.05-08.08	170				0 986 <b>134 324</b>	 ← 57	
						0 986 <b>135 324</b>	 → 57	
	09.08-12.11	180			PFN	0 986 <b>134 324</b>	 ← 57	
						0 986 <b>135 324</b>	 → 57	
<b>330 d xDrive</b>	09.08-10.11	180				0 986 <b>134 324</b>	 ← 57	
						0 986 <b>135 324</b>	 → 57	
<b>330 i, i xDrive, xi</b>	03.05-12.11	190-200				0 986 <b>134 324</b>	 ← 57	
						0 986 <b>135 324</b>	 → 57	
<b>330 xd</b>	09.05-09.07	170				0 986 <b>134 324</b>	 ← 57	
						0 986 <b>135 324</b>	 → 57	
								
 <b>316 i</b>	09.05-10.11	85/90			PFC	0 986 <b>134 311</b>	 ←	
						0 986 <b>135 311</b>	 →	
<b>318 d</b>	09.05-10.11	90/95-100			INB	0 986 <b>134 311</b>	 ←	
<b>318 i</b>						0 986 <b>135 311</b>	 →	
	09.07-10.11	100-105				0 986 <b>134 311</b>	 ←	
						0 986 <b>135 311</b>	 →	
<b>320 d</b>	03.05-09.07	120			BHO	0 986 <b>134 311</b>	 ←	
						0 986 <b>135 311</b>	 →	
					336, BHO	0 986 <b>134 084</b>	 ← 44	
						0 986 <b>135 084</b>	 → 44	
	09.05-09.07	110			BHO	0 986 <b>134 311</b>	 ←	
						0 986 <b>135 311</b>	 →	
					336, BHO	0 986 <b>134 084</b>	 ← 44	
						0 986 <b>135 084</b>	 → 44	
	09.07-03.10	130			BHO	0 986 <b>134 311</b>	 ←	
						0 986 <b>135 311</b>	 →	
					336, BHO	0 986 <b>134 084</b>	 ← 44	
						0 986 <b>135 084</b>	 → 44	
<b>320 d ed</b>	03.10-11.11	120			BHO	0 986 <b>134 311</b>	 ←	
						0 986 <b>135 311</b>	 →	
					336, BHO	0 986 <b>134 084</b>	 ← 44	
						0 986 <b>135 084</b>	 → 44	
<b>320 d</b>	09.08-12.11	120-135			BHO	0 986 <b>134 311</b>	 ←	
<b>320 d xDrive</b>						0 986 <b>135 311</b>	 →	
					336, BHO	0 986 <b>134 084</b>	 ← 44	
						0 986 <b>135 084</b>	 → 44	
<b>320 i</b>	03.05-12.11	110-115			INB	0 986 <b>134 311</b>	 ←	
						0 986 <b>135 311</b>	 →	
	09.07-12.11	120-125				0 986 <b>134 311</b>	 ←	
						0 986 <b>135 311</b>	 →	
<b>320 si</b>	03.06-09.06	127				0 986 <b>134 311</b>	 ←	
						0 986 <b>135 311</b>	 →	
<b>323 i</b>	09.05-12.11	130				0 986 <b>134 311</b>	 ←	
						0 986 <b>135 311</b>	 →	
<b>325 d</b>	09.06-10.11	145/150			PFN	0 986 <b>134 084</b>	 ← 44	
						0 986 <b>135 084</b>	 → 44	
<b>325 i</b>	03.05-12.11	155-160			NON	0 986 <b>134 311</b>	 ←	
<b>325 i xDrive</b>						0 986 <b>135 311</b>	 →	
<b>325 xi</b>					336, ERH	0 986 <b>134 084</b>	 ← 44	
						0 986 <b>135 084</b>	 → 44	



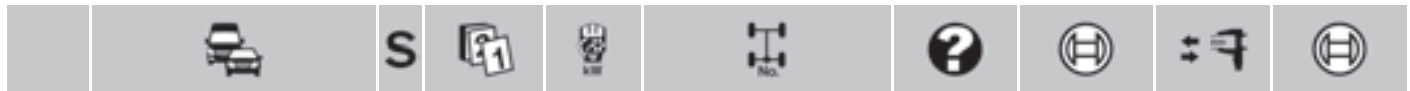









	◀ BMW Serie 3 [E 90]				
328 i	09.06-07.11	170-172		0986 134 311	↻ ←
				0986 135 311	↻ →
330 d	09.08-12.11	180	PFN	0986 134 084	↻ ← 44
				0986 135 084	↻ → 44
330 d xDrive	09.08-10.11	180		0986 134 084	↻ ← 44
				0986 135 084	↻ → 44
330 d	09.05-08.08	170		0986 134 084	↻ ← 44
330 xd				0986 135 084	↻ → 44
330 i, i xDrive, xi	03.05-12.11	190-200		0986 134 084	↻ ← 44
				0986 135 084	↻ → 44
335 d, i, i xDrive, xi	09.06-12.11	210/ 225-240		0986 134 084	↻ ← 44
				0986 135 084	↻ → 44





	M 3	11.07-10.11	309		1987 477 950	↔ 1533
	316 d	09.09-10.11	85/90		1987 477 950	↔ 1533
	316 i	09.05-10.11	85/90		1987 477 950	↔ 1533
	318 d	09.05-10.11	90/95-105		1987 477 950	↔ 1533
	318 i	09.05-10.11	90/95-105		1987 477 950	↔ 1533
	320 d	03.05-12.11	110-115/120-135		1987 477 950	↔ 1533
	320 d ed	03.10-11.11	110-115/120-135		1987 477 950	↔ 1533
	320 d xDrive	09.08-10.11	110-115/120-135		1987 477 950	↔ 1533
	320 i	03.05-12.11	110-115/120-135		1987 477 950	↔ 1533
	320 si	03.06-09.06	110-115/120-135		1987 477 950	↔ 1533
	323 i	09.05-12.11	130		1987 477 950	↔ 1533
	325 d	09.06-10.11	145/150/155-160		1987 477 950	↔ 1533
	325 i	03.05-12.11	145/150/155-160		1987 477 950	↔ 1533
	325 i xDrive	09.08-10.11	145/150/155-160		1987 477 950	↔ 1533
	325 xi	09.05-08.08	145/150/155-160		1987 477 950	↔ 1533
	328 i	09.06-07.11	170-172		1987 477 950	↔ 1533
	330 d	09.05-12.11	170/180/190-200		1987 477 950	↔ 1533
	330 d xDrive	09.08-10.11	170/180/190-200		1987 477 950	↔ 1533
	330 i	03.05-12.11	170/180/190-200		1987 477 950	↔ 1533
	330 i xDrive	09.08-10.11	170/180/190-200		1987 477 950	↔ 1533
	330 xd	09.05-08.08	170/180/190-200		1987 477 950	↔ 1533
	330 xi	09.05-08.08	170/180/190-200		1987 477 950	↔ 1533
	335 d	09.06-10.11	210/225-240		1987 477 950	↔ 1533
	335 i	09.06-12.11	210/225-240		1987 477 950	↔ 1533
	335 i xDrive	09.08-10.11	210/225-240		1987 477 950	↔ 1533
	335 xi	03.07-08.08	210/225-240		1987 477 950	↔ 1533

	M 3	11.07-10.11	309		0986 594 572 <sup>4</sup>	
	316 d	09.05-10.11	85/90		0986 594 514 <sup>4</sup>	
	316 i				0986 594 519 <sup>3</sup>	
	318 d	09.05-10.11	90/95-100		0986 594 519 <sup>3</sup>	
	318 i			INB	0986 594 565 <sup>4</sup>	
				INB	0986 594 514 <sup>4</sup>	
		09.07-10.11	100-105		0986 594 514 <sup>4</sup>	
					0986 594 519 <sup>3</sup>	
	320 d	03.05-09.07	120		0986 594 519 <sup>3</sup>	
				ERH	0986 594 565 <sup>4</sup>	
				NON	0986 594 514 <sup>4</sup>	
		09.05-09.07	110		0986 594 519 <sup>3</sup>	
				ERH	0986 594 565 <sup>4</sup>	
				NON	0986 594 514 <sup>4</sup>	
		09.07-03.10	130		0986 594 540 <sup>3</sup>	
					0986 594 571 <sup>4</sup>	
				EAL	0986 594 514 <sup>4</sup>	
				EAL	0986 594 519 <sup>3</sup>	

		S							
<b>320 d</b>		03.10-12.11	120-135				0 986 594 519 <sup>3</sup>		
						BHO,EAL	0 986 594 565 <sup>4</sup>		
						EAL	0 986 594 571 <sup>4</sup>		
						BHO,EAL	0 986 594 514 <sup>4</sup>		
<b>320 d ed</b>		03.10-11.11	120				0 986 594 519 <sup>3</sup>		
						BHO	0 986 594 565 <sup>4</sup>		
						BHO	0 986 594 514 <sup>4</sup>		
<b>320 d xDrive</b>		09.08-02.10	120-130				0 265 007 669 <sup>3</sup>		
		03.10-10.11	120-135				0 265 007 669 <sup>3</sup>		
<b>320 i</b>		03.05-12.11	110-115				0 986 594 519 <sup>3</sup>		
						INB	0 986 594 565 <sup>4</sup>		
						INB	0 986 594 514 <sup>4</sup>		
		09.07-12.11	120-125			EAL	0 986 594 540 <sup>3</sup>		
						EAL	0 986 594 571 <sup>4</sup>		
						EAL	0 986 594 514 <sup>4</sup>		
							0 986 594 519 <sup>3</sup>		
<b>320 si</b>		03.06-09.06	127				0 986 594 519 <sup>3</sup>		
							0 986 594 565 <sup>4</sup>		
<b>323 i</b>		09.05-12.11	130				0 986 594 540 <sup>3</sup>		
							0 986 594 571 <sup>4</sup>		
<b>325 d</b>		09.06-10.11	145/150				0 986 594 540 <sup>3</sup>		
							0 986 594 572 <sup>4</sup>		
<b>325 i</b>		03.05-12.11	160				0 986 594 540 <sup>3</sup>		
						ERH	0 986 594 572 <sup>4</sup>		
						NON	0 986 594 571 <sup>4</sup>		
		09.07-12.11	155-160				0 986 594 540 <sup>3</sup>		
						ERH	0 986 594 572 <sup>4</sup>		
						NON	0 986 594 571 <sup>4</sup>		
<b>325 i xDrive, xi</b>		09.05-10.11	160				0 265 007 669 <sup>3</sup>		
<b>328 i</b>		09.06-07.11	170-172				0 986 594 540 <sup>3</sup>		
							0 986 594 571 <sup>4</sup>		
<b>330 d</b>		09.05-12.11	170/180				0 986 594 540 <sup>3</sup>		
							0 986 594 572 <sup>4</sup>		
<b>330 d xDrive, xd</b>		09.05-10.11	170/180				0 265 007 669 <sup>3</sup>		
<b>330 i</b>		03.05-12.11	190-200				0 986 594 540 <sup>3</sup>		
							0 986 594 572 <sup>4</sup>		
		09.07-10.11	200				0 986 594 540 <sup>3</sup>		
							0 986 594 572 <sup>4</sup>		
<b>330 i xDrive, xi</b>		09.07-10.11	200				0 265 007 669 <sup>3</sup>		
<b>330 xi</b>		09.05-09.07	190				0 265 007 669 <sup>3</sup>		
<b>335 d</b>		09.06-10.11	210				0 986 594 540 <sup>3</sup>		
							0 986 594 572 <sup>4</sup>		
<b>335 i</b>		09.06-12.11	225-240				0 986 594 540 <sup>3</sup>		
							0 986 594 572 <sup>4</sup>		
<b>335 i xDrive, xi</b>		03.07-10.11	225-240				0 265 007 669 <sup>3</sup>		

## Serie 3 [F 30]

								
	<b>ActiveHybrid</b>	09.12→	225-250				1 987 482 491	↔ 1584
	<b>316 d</b>	03.12→	85				1 987 482 491	↔ 1584
	<b>316 i</b>	07.12→	100		AAK		1 987 482 491	↔ 1584
	<b>318 d</b>	03.12→	105		AAK		1 987 482 491	↔ 1584
		07.15→	110				1 987 482 491	↔ 1584
	<b>318 d xDrive</b>	07.15→	110				1 987 482 491	↔ 1584
	<b>320 d</b>	02.12→	135-147		AAK		1 987 482 491	↔ 1584
		07.15→	140				1 987 482 491	↔ 1584
	<b>320 d ed</b>	02.12→	120		AAK		1 987 482 491	↔ 1584
		07.15→	120				1 987 482 491	↔ 1584
	<b>320 d xDrive</b>	07.12→	135-147		AAK		1 987 482 491	↔ 1584
		07.15→	140				1 987 482 491	↔ 1584
	<b>320 i</b>	03.12→	135		AAK		1 987 482 491	↔ 1584
		07.15→	135				1 987 482 491	↔ 1584





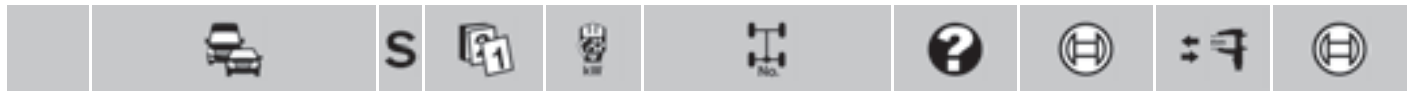

◀ BMW Serie 3 [F 30]

	320 i ed	07.15→	125			1987 482 491	↔ 1584
	320 i xDrive	07.12→	135			1987 482 491	↔ 1584
	323 d	03.13→	160	AAK		1987 482 491	↔ 1584
	328 i	02.12→	180			1987 482 491	↔ 1584
	328 i xDrive	07.12→	180			1987 482 491	↔ 1584
	330 d	07.12→	185/190-210			1987 482 491	↔ 1584
	330 i	07.15→	185/190-210			1987 482 491	↔ 1584
	330 i xDrive	07.15→	185/190-210			1987 482 491	↔ 1584
	335 d xDrive	07.13→	225-250			1987 482 491	↔ 1584
	335 i	02.12→	225-250			1987 482 491	↔ 1584
	335 i xDrive	07.12→	225-250			1987 482 491	↔ 1584
	340 i	07.15→	240			1987 482 491	↔ 1584
	340 i xDrive	07.15→	240			1987 482 491	↔ 1584

Serie 3 GT [F 34]























































	318 d	07.15→	110			1987 482 491	↔ 1584
	320 d	07.15→	140			1987 482 491	↔ 1584
	320 d xDrive	07.15→	140			1987 482 491	↔ 1584
	330 d	03.14-11.14	190-210			1987 482 491	↔ 1584
	330 d xDrive	03.14→	190-210	AAK		1987 482 491	↔ 1584
	335 d xDrive	03.14-11.14	230			1987 482 491	↔ 1584

Serie 3 Touring [E 30]

	316 i	09.91-06.94	73-75	GIR		0986 473 662	👁️ ← 48
						0986 474 662	👁️ → 48
	318 i	04.89-06.94	83-85	GIR		0986 473 662	👁️ ← 48
						0986 474 662	👁️ → 48
	316 i	09.91-06.94	73-75			0986 473 877	👁️ ← 35
						0986 473 878	👁️ → 35
	318 i	04.89-06.94	83-85			0986 473 877	👁️ ← 35
						0986 473 878	👁️ → 35
	316 i	09.91-06.94	73-75			1987 477 065	↔ 1725
	318 i	04.89-06.94	83-85			1987 477 065	↔ 1725
	316 i	09.91-06.94	73-75			0265 001 059	
				LAB		0265 001 058	
				RAB		0265 001 057	
	318 i	04.89-06.94	83-85			0265 001 059	
				LAB		0265 001 058	
				RAB		0265 001 057	

Serie 3 Touring [E 36]

	316 i	01.96-12.99	75	INB		0986 473 917	👁️ ← 54
						0986 473 918	👁️ → 54
				INB		0986 471 919	← 54
						0986 473 919	👁️
						0986 471 920	→ 54
						0986 473 920	👁️

		S							
<b>318i</b>		03.95-12.99	66/85			INB	0 986 473 917	 ← 54	
<b>318tds</b>							0 986 473 918	 → 54	
						INB	0 986 471 919	 ← 54	
							0 986 473 919	 → 54	
							0 986 471 920	 → 54	
							0 986 473 920	 → 54	
<b>320i</b>		03.95-12.99	110				0 986 473 917	 ← 54	
							0 986 473 918	 → 54	
<b>323i</b>		10.95-06.99	125				0 986 473 917	 ← 54	
							0 986 473 918	 → 54	
<b>325tds</b>		09.95-12.99	105				0 986 473 917	 ← 54	
							0 986 473 918	 → 54	
<b>328i</b>		03.95-12.99	142				0 986 473 917	 ← 54	
							0 986 473 918	 → 54	
									
	<b>316i</b>	01.96-12.99	75				0 986 473 134	 ← 37,94	F 026 A06 134 <sup>7</sup>
							0 986 474 134	 → 37,94	F 026 A06 134 <sup>7</sup>
	<b>318i</b>	03.95-12.99	66/85				0 986 473 134	 ← 37,94	F 026 A06 134 <sup>7</sup>
	<b>318tds</b>						0 986 474 134	 → 37,94	F 026 A06 134 <sup>7</sup>
	<b>320i</b>	03.95-12.99	110				0 986 473 134	 ← 37,94	F 026 A06 134 <sup>7</sup>
							0 986 474 134	 → 37,94	F 026 A06 134 <sup>7</sup>
	<b>323i</b>	10.95-06.99	125				0 986 473 135	 ← 37,94	F 026 A06 134 <sup>7</sup>
							0 986 474 135	 → 37,94	F 026 A06 134 <sup>7</sup>
	<b>325tds</b>	09.95-12.99	105				0 986 473 134	 ← 37,94	F 026 A06 134 <sup>7</sup>
							0 986 474 134	 → 37,94	F 026 A06 134 <sup>7</sup>
	<b>328i</b>	03.95-12.99	142				0 986 473 135	 ← 37,94	F 026 A06 134 <sup>7</sup>
							0 986 474 135	 → 37,94	F 026 A06 134 <sup>7</sup>
									
	<b>316i</b>	01.96-12.99	75				1 987 477 067	 ↔ 1631	
	<b>318i</b>	07.95-12.99	66/85				1 987 477 067	 ↔ 1631	
	<b>318tds</b>	03.95-12.99	66/85				1 987 477 067	 ↔ 1631	
	<b>320i</b>	03.95-12.99	110				1 987 477 067	 ↔ 1631	
	<b>323i</b>	10.95-06.99	125				1 987 477 067	 ↔ 1631	
	<b>325tds</b>	09.95-12.99	105				1 987 477 067	 ↔ 1631	
	<b>328i</b>	03.95-12.99	142				1 987 477 067	 ↔ 1631	
									
	<b>316i</b>	01.96-12.99	75				0 986 594 015 <sup>3</sup>		
							0 986 594 016 <sup>4</sup>		
	<b>318i</b>	03.95-12.99	66/85				0 986 594 015 <sup>3</sup>		
	<b>318tds</b>						0 986 594 016 <sup>4</sup>		
	<b>320i</b>	03.95-12.99	110				0 986 594 015 <sup>3</sup>		
							0 986 594 016 <sup>4</sup>		
	<b>323i</b>	10.95-06.99	125				0 986 594 015 <sup>3</sup>		
							0 986 594 016 <sup>4</sup>		
	<b>325tds</b>	09.95-12.99	105				0 986 594 015 <sup>3</sup>		
							0 986 594 016 <sup>4</sup>		
	<b>328i</b>	03.95-12.99	142				0 986 594 015 <sup>3</sup>		
							0 986 594 016 <sup>4</sup>		
<b>Serie 3 Touring [E 46]</b>									
									
	<b>316i</b>	03.02-09.05	85				0 986 473 917	 ← 54	
							0 986 473 918	 → 54	
	<b>318d</b>	10.99-09.05	85/87/105				0 986 473 917	 ← 54	
	<b>318i</b>						0 986 473 918	 → 54	
	<b>320d</b>	10.99-09.05	100/110/				0 986 473 917	 ← 54	
	<b>320i</b>		120-125				0 986 473 918	 → 54	



		S							
	◀ BMW Serie 3 Touring [E 46]								
	323 i	10.98-09.00	125				0986 473 917		← 54
							0986 473 918		→ 54
	325 i	09.00-09.05	137/141				0986 473 917		← 54
	325 xi						0986 473 918		→ 54
	328 i	10.99-09.00	142				0986 473 917		← 54
							0986 473 918		→ 54
	330 d, i, xd, xi	10.99-09.05	135/150/ 170				0986 473 990		← 57
							0986 474 990		→ 57
	316 i	03.02-09.05	85				0986 473 159		← 39,94 F 026 A06 122 <sup>7</sup>
							0986 474 159		→ 39,94 F 026 A06 122 <sup>7</sup>
	318 d	10.99-09.05	85/87/105				0986 473 159		← 39,94 F 026 A06 122 <sup>7</sup>
	318 i						0986 474 159		→ 39,94 F 026 A06 122 <sup>7</sup>
	320 d	10.99-09.05	100/110/				0986 473 159		← 39,94 F 026 A06 122 <sup>7</sup>
	320 i		120-125				0986 474 159		→ 39,94 F 026 A06 122 <sup>7</sup>
	323 i	10.98-09.00	125				0986 473 159		← 39,94 F 026 A06 122 <sup>7</sup>
							0986 474 159		→ 39,94 F 026 A06 122 <sup>7</sup>
	325 i	09.00-09.05	137/141				0986 473 159		← 39,94 F 026 A06 122 <sup>7</sup>
	325 xi						0986 474 159		→ 39,94 F 026 A06 122 <sup>7</sup>
	328 i	10.99-09.00	142				0986 473 159		← 39,94 F 026 A06 122 <sup>7</sup>
							0986 474 159		→ 39,94 F 026 A06 122 <sup>7</sup>
	330 d	10.99-09.05	135/150/				0986 473 160		← F 026 A06 123 <sup>7</sup>
	330 i		170				0986 474 160		→ 41,94 F 026 A06 123 <sup>7</sup>
	316 i	03.02-09.05	85				1987 477 531		→ 1708
							1987 477 532		← 1693
	318 d	10.99-09.05	85/87/105				1987 477 531		→ 1708
	318 i						1987 477 532		← 1693
	320 d	10.99-09.05	100/110/				1987 477 531		→ 1708
	320 i		120-125				1987 477 532		← 1693
	323 i	10.98-09.00	125				1987 477 531		→ 1708
							1987 477 532		← 1693
	325 i	09.00-09.05	137/141				1987 477 531		→ 1708
	325 xi						1987 477 532		← 1693
	328 i	10.99-09.00	142				1987 477 531		→ 1708
							1987 477 532		← 1693
	330 d, i, xd, xi	10.99-09.05	135/150/ 170				1987 477 531		→ 1708
							1987 477 532		← 1693
	316 i	03.02-09.05	85				0986 594 513 <sup>4</sup>		
						LAB	0986 594 527 <sup>3</sup>		
						RAB	0986 594 528 <sup>3</sup>		
	318 d	03.02-09.05	85				0986 594 513 <sup>4</sup>		
						LAB	0986 594 527 <sup>3</sup>		
						RAB	0986 594 528 <sup>3</sup>		
	318 i	10.99-09.00	87				0986 594 017 <sup>4</sup>		
							0986 594 018 <sup>3</sup>		
		10.00-09.01	87				0986 594 513 <sup>4</sup>		
						LAB	0986 594 527 <sup>3</sup>		
						RAB	0986 594 528 <sup>3</sup>		
		09.01-03.05	105				0986 594 513 <sup>4</sup>		
						LAB	0986 594 527 <sup>3</sup>		
						RAB	0986 594 528 <sup>3</sup>		
	320 d	10.99-09.00	100				0986 594 017 <sup>4</sup>		
							0986 594 018 <sup>3</sup>		
		10.00-09.01	100				0986 594 513 <sup>4</sup>		
						LAB	0986 594 527 <sup>3</sup>		
						RAB	0986 594 528 <sup>3</sup>		



		S							
320 d		10.00-09.05	110				0 986 594 513 <sup>4</sup>		
320 i						LAB	0 986 594 527 <sup>3</sup>		
						RAB	0 986 594 528 <sup>3</sup>		
320 i		10.99-09.00	110				0 986 594 017 <sup>4</sup>		
							0 986 594 018 <sup>3</sup>		
		09.00-09.05	120-125				0 986 594 513 <sup>4</sup>		
						LAB	0 986 594 527 <sup>3</sup>		
						RAB	0 986 594 528 <sup>3</sup>		
323 i		10.98-09.00	125				0 986 594 017 <sup>4</sup>		
							0 986 594 018 <sup>3</sup>		
325 i		09.00-09.05	137/141				0 986 594 513 <sup>4</sup>		
						LAB	0 986 594 527 <sup>3</sup>		
						RAB	0 986 594 528 <sup>3</sup>		
328 i		10.99-09.00	142				0 986 594 017 <sup>4</sup>		
							0 986 594 018 <sup>3</sup>		
330 d		10.99-09.00	135				0 986 594 018 <sup>3</sup>		
		10.00-03.03	135			LAB	0 986 594 527 <sup>3</sup>		
						RAB	0 986 594 528 <sup>3</sup>		
		03.03-09.05	150			LAB	0 986 594 527 <sup>3</sup>		
						RAB	0 986 594 528 <sup>3</sup>		
330 i		05.00-09.00	170				0 986 594 018 <sup>3</sup>		
						AG	0 986 594 017 <sup>4</sup>		
		08.00-09.00	170			GS	0 986 594 017 <sup>4</sup>		
		10.00-09.05	170			AG	0 986 594 513 <sup>4</sup>		
						LAB	0 986 594 527 <sup>3</sup>		
						RAB	0 986 594 528 <sup>3</sup>		

**Serie 3 Touring [E 91]**

316 d		09.08-05.12	85/90			PFN	0 986 134 344		← 54
316 i							0 986 135 344		→ 54
318 d		03.06-09.07	90			PFN	0 986 134 063		← 57
							0 986 135 063		→ 57
		09.07-05.12	100-105			PFN	0 986 134 063		← 57
							0 986 135 063		→ 57
318 i		03.06-08.07	95-100				0 986 134 063		← 57
							0 986 135 063		→ 57
		09.07-03.10	95-100				0 986 134 344		← 54
							0 986 135 344		→ 54
						312	0 986 134 063		← 57
							0 986 135 063		→ 57
		09.07-05.12	100-105			NON,PFN	0 986 134 344		← 54
							0 986 135 344		→ 54
						312,ERH,	0 986 134 063		← 57
						PFN	0 986 135 063		→ 57
320 d		09.05-08.07	110			BHO	0 986 134 324		← 57
							0 986 135 324		→ 57
						BHO	0 986 134 063		← 57
							0 986 135 063		→ 57
			120			BHO	0 986 134 324		← 57
							0 986 135 324		→ 57
						BHO	0 986 134 063		← 57
							0 986 135 063		→ 57
		09.07-02.10	130			BHO	0 986 134 324		← 57
							0 986 135 324		→ 57
						312,BHO	0 986 134 063		← 57
							0 986 135 063		→ 57
		03.10-05.12	120-135			ERH,PFN	0 986 134 324		← 57
							0 986 135 324		→ 57
						312,NON,	0 986 134 063		← 57
						PFN	0 986 135 063		→ 57



		S								
	◀ BMW Serie 3 Touring [E 91]									
320 d ed	03.11-05.12	120					0986 134 063		← 57	
							0986 135 063		→ 57	
320 d xDrive	09.08-02.10	120-130			BHO		0986 134 324		← 57	
							0986 135 324		→ 57	
	03.10-05.12	120-135			BHO	312,BHO	0986 134 063		← 57	
							0986 135 063		→ 57	
						312,BHO	0986 134 324		← 57	
							0986 135 324		→ 57	
320 i	09.05-05.12	110-115					0986 134 063		← 57	
	09.07-06.12	120-125					0986 135 063		→ 57	
323 i	09.05-05.12	130					0986 134 063		← 57	
							0986 135 063		→ 57	
325 d	09.06-02.10	145					0986 134 324		← 57	
							0986 135 324		→ 57	
	03.10-05.12	150			NON,PFN			0986 134 324		← 57
								0986 135 324		→ 57
325 i	09.05-09.07	160			NON		0986 134 063		← 57	
							0986 135 063		→ 57	
	09.05-12.10	160			ERH			0986 134 324		← 57
								0986 135 324		→ 57
	09.07-05.12	155-160			ERH	312,NON		0986 134 324		← 57
								0986 135 324		→ 57
312,NON						0986 134 063		← 57		
						0986 135 063		→ 57		
325 i xDrive	09.08-08.11	160			312,NON		0986 134 063		← 57	
							0986 135 063		→ 57	
325 i xDrive	09.05-08.11	160			ERH		0986 134 324		← 57	
							0986 135 324		→ 57	
325 xi	09.07-05.12	160					0986 134 324		← 57	
							0986 135 324		→ 57	
325 xi	09.05-09.07	160			NON		0986 134 063		← 57	
							0986 135 063		→ 57	
	10.07-08.08	160			312,NON			0986 134 063		← 57
								0986 135 063		→ 57
330 d, d xDrive, i, i xDrive, xd, xi	09.05-05.13	170/180/ 190-200					0986 134 324		← 57	
							0986 135 324		→ 57	
316 d	03.10-05.12	85					0986 134 311		←	
							0986 135 311		→	
316 i	09.08-05.12	90			PFN		0986 134 311		←	
							0986 135 311		→	
318 d	03.06-09.07	90			PFN		0986 134 311		←	
							0986 135 311		→	
	09.07-05.12	100-105			PFN			0986 134 311		←
								0986 135 311		→
09.09-05.12	100-105			PFC			0986 134 311		←	
							0986 135 311		→	
318 i	03.06-03.10	95-100					0986 134 311		←	
							0986 135 311		→	
09.07-05.12	100-105			PFN			0986 134 311		←	
							0986 135 311		→	















		S										
<b>320 d</b>	09.05-08.07	110	BHO	0 986 134 311								
				0 986 135 311								
				336,BHO	0 986 134 084		44					
					0 986 135 084		44					
				120	BHO	0 986 134 311						
						0 986 135 311						
	09.07-02.10	130	BHO	0 986 134 311								
					0 986 135 311							
				336,BHO	0 986 134 084		44					
					0 986 135 084		44					
				03.10-05.12	120-135	NON,PFN	0 986 134 311					
								0 986 135 311				
03.10-05.12	120-135	336,ERH, PFN	0 986 134 084		44							
				0 986 135 084		44						
<b>320 d ed</b>	03.11-05.12	120		0 986 134 311								
				0 986 135 311								
<b>320 d xDrive</b>	09.08-02.10	120-130	BHO	0 986 134 311								
					0 986 135 311							
				336,BHO	0 986 134 084		44					
					0 986 135 084		44					
	03.10-05.12	120-135	BHO	0 986 134 311								
					0 986 135 311							
03.10-05.12	120-135	336,BHO	0 986 134 084		44							
				0 986 135 084		44						
<b>320 i</b>	09.05-05.12	110-115		0 986 134 311								
				0 986 135 311								
	09.07-06.12	120-125		0 986 134 311								
				0 986 135 311								
<b>323 i</b>	09.05-05.12	130		0 986 134 311								
				0 986 135 311								
<b>325 d</b>	09.06-02.10	145		0 986 134 084		44						
					0 986 135 084		44					
	03.10-05.12	150	PFN	0 986 134 084		44						
				0 986 135 084		44						
<b>325 i</b>	09.05-12.10	160	336,ERH	0 986 134 084		44						
				0 986 135 084		44						
	09.07-05.12	155-160	NON	0 986 134 311								
				0 986 135 311								
			336,ERH	0 986 134 084		44						
				0 986 135 084		44						
<b>325 i xDrive</b>	09.05-08.11	160	336,ERH	0 986 134 084		44						
<b>325 xi</b>				0 986 135 084		44						
	09.07-05.12	160		0 986 134 084		44						
				0 986 135 084		44						
<b>325 i, i xDrive, xi</b>	09.05-08.11	160	NON	0 986 134 311								
				0 986 135 311								
<b>330 d, d xDrive, i, i xDrive, xd, xi</b>	09.05-05.13	170/180/ 190-200		0 986 134 084		44						
					0 986 135 084		44					
<b>335 d, i, i xDrive, xi</b>	09.06-05.12	210/ 225-240		0 986 134 084		44						
					0 986 135 084		44					
		03.10-05.12	85/90		1 987 477 950		1533					
		09.08-05.12	85/90		1 987 477 950		1533					
		03.06-05.12	90/95-105		1 987 477 950		1533					
		03.06-05.12	90/95-105		1 987 477 950		1533					
		09.05-05.12	110-115/120-135		1 987 477 950		1533					
		03.11-05.12	110-115/120-135		1 987 477 950		1533					
		09.08-05.12	110-115/120-135		1 987 477 950		1533					
		09.05-06.12	110-115/120-135		1 987 477 950		1533					





BMW Serie 3 Touring [E 91]									
323 i	09.05-05.12	130					1987 477 950	↔	1533
325 d	09.06-05.12	145/150/155-160					1987 477 950	↔	1533
325 i	09.05-05.12	145/150/155-160					1987 477 950	↔	1533
325 i xDrive	09.08-05.12	145/150/155-160					1987 477 950	↔	1533
325 xi	09.05-08.08	145/150/155-160					1987 477 950	↔	1533
330 d	09.05-05.12	170/180/190-200					1987 477 950	↔	1533
330 d xDrive	09.08-05.12	170/180/190-200					1987 477 950	↔	1533
330 i	09.05-05.13	170/180/190-200					1987 477 950	↔	1533
330 i xDrive	09.08-05.12	170/180/190-200					1987 477 950	↔	1533
330 xd	09.05-08.08	170/180/190-200					1987 477 950	↔	1533
330 xi	09.05-08.08	170/180/190-200					1987 477 950	↔	1533
335 d	09.06-05.12	210/225-240					1987 477 950	↔	1533
335 i	09.06-05.12	210/225-240					1987 477 950	↔	1533
335 i xDrive	09.08-05.12	210/225-240					1987 477 950	↔	1533
335 xi	03.07-08.08	210/225-240					1987 477 950	↔	1533
<hr/>									
316 d	03.10-05.12	85					0986 594 519 <sup>3</sup>		
				ERH		0986 594 565 <sup>4</sup>			
				NON		0986 594 514 <sup>4</sup>			
316 i	09.08-08.09	90				0986 594 565 <sup>4</sup>			
				09.08-05.12	90	0986 594 519 <sup>3</sup>			
				09.09-05.12	90	0986 594 514 <sup>4</sup>			
318 d	03.06-09.07	90				0986 594 519 <sup>3</sup>			
						0986 594 565 <sup>4</sup>			
				09.07-05.12	100-105	ERH	0986 594 565 <sup>4</sup>		
				NON	0986 594 514 <sup>4</sup>				
318 d, i	09.07-05.12	100-105				0986 594 519 <sup>3</sup>			
318 i	03.06-08.09	95-100				0986 594 565 <sup>4</sup>			
				03.06-03.10	95-100	0986 594 519 <sup>3</sup>			
	09.07-08.09	100-105				0986 594 565 <sup>4</sup>			
				09.09-03.10	95-100	0986 594 514 <sup>4</sup>			
	09.09-05.12	100-105			ERH	0986 594 565 <sup>4</sup>			
					NON	0986 594 514 <sup>4</sup>			
320 d	09.05-08.07	110				0986 594 519 <sup>3</sup>			
						0986 594 565 <sup>4</sup>			
				120		0986 594 519 <sup>3</sup>			
						0986 594 565 <sup>4</sup>			
	09.07-08.09	130			EAL	0986 594 565 <sup>4</sup>			
				09.07-02.10	130	EAL	0986 594 540 <sup>3</sup>		
						0986 594 572 <sup>4</sup>			
					EAL	0986 594 519 <sup>3</sup>			
	09.09-02.10	130			EAL	0986 594 514 <sup>4</sup>			
				03.10-05.12	120-135	BHO	0986 594 565 <sup>4</sup>		
					EAL	0986 594 540 <sup>3</sup>			
					EAL	0986 594 519 <sup>3</sup>			
					BHO	0986 594 514 <sup>4</sup>			
320 d ed	03.11-05.12	120				0986 594 519 <sup>3</sup>			
					ERH	0986 594 565 <sup>4</sup>			
					NON	0986 594 514 <sup>4</sup>			
320 d xDrive	09.08-02.10	120-130				0265 007 669 <sup>3</sup>			
	03.10-05.12	120-135				0265 007 669 <sup>3</sup>			
320 i	09.05-08.09	110-115				0986 594 565 <sup>4</sup>			
				09.05-05.12	110-115	0986 594 519 <sup>3</sup>			
	09.07-08.09	120-125			EAL	0986 594 565 <sup>4</sup>			
				09.07-06.12	120-125	EAL	0986 594 540 <sup>3</sup>		
						0986 594 572 <sup>4</sup>			
					EAL	0986 594 519 <sup>3</sup>			
	09.09-05.12	110-115				0986 594 514 <sup>4</sup>			
09.09-06.12	120-125			EAL	0986 594 514 <sup>4</sup>				
323 i	09.05-05.12	130				0986 594 540 <sup>3</sup>			
						0986 594 572 <sup>4</sup>			
325 d	09.06-05.12	145/150/				0986 594 540 <sup>3</sup>			
325 i		155-160				0986 594 572 <sup>4</sup>			

		S							
325 i		09.05-12.10	160				0 986 594 540 <sup>3</sup>		
							0 986 594 572 <sup>4</sup>		
325 i xDrive, xi		09.05-05.12	160				0 265 007 669 <sup>3</sup>		
330 d		09.05-05.12	170/180				0 986 594 540 <sup>3</sup>		
							0 986 594 572 <sup>4</sup>		
330 d xDrive, xd		09.05-05.12	170/180				0 265 007 669 <sup>3</sup>		
330 i		09.05-02.12	190-200				0 986 594 540 <sup>3</sup>		
							0 986 594 572 <sup>4</sup>		
		09.07-05.13	200				0 986 594 540 <sup>3</sup>		
							0 986 594 572 <sup>4</sup>		
330 i xDrive, xi		09.07-05.12	200				0 265 007 669 <sup>3</sup>		
330 xi		09.05-09.07	190				0 265 007 669 <sup>3</sup>		
335 d		09.06-05.12	210				0 986 594 540 <sup>3</sup>		
							0 986 594 572 <sup>4</sup>		
335 i		09.06-05.12	225-240				0 986 594 540 <sup>3</sup>		
							0 986 594 572 <sup>4</sup>		
335 i xDrive, xi		03.07-05.12	225-240				0 265 007 669 <sup>3</sup>		
<b>Serie 3 Touring [F 31]</b>									
									
	316 d	11.12→	85				1 987 482 491	↔ 1584	
	316 i	03.13→	100		AAK		1 987 482 491	↔ 1584	
	318 d	11.12→	105		AAK		1 987 482 491	↔ 1584	
		07.15→	110				1 987 482 491	↔ 1584	
	318 d xDrive	07.15→	110				1 987 482 491	↔ 1584	
	318 i	07.15→	100				1 987 482 491	↔ 1584	
	320 d	09.12→	135-147		AAK		1 987 482 491	↔ 1584	
		07.15→	140				1 987 482 491	↔ 1584	
	320 d ed	03.13→	120		AAK		1 987 482 491	↔ 1584	
		07.15→	120				1 987 482 491	↔ 1584	
	320 d xDrive	03.13→	135		AAK		1 987 482 491	↔ 1584	
		07.15→	140				1 987 482 491	↔ 1584	
	320 i	11.12→	135		AAK		1 987 482 491	↔ 1584	
		07.15→	135				1 987 482 491	↔ 1584	
	320 i xDrive	03.13→	135				1 987 482 491	↔ 1584	
	325 d	03.13→	160		AAK		1 987 482 491	↔ 1584	
	328 i	09.12→	180				1 987 482 491	↔ 1584	
	328 i xDrive	03.13→	180				1 987 482 491	↔ 1584	
	330 d	09.12→	185/190				1 987 482 491	↔ 1584	
	330 d xDrive	03.13→	185/190				1 987 482 491	↔ 1584	
	330 i	07.15→	185/190				1 987 482 491	↔ 1584	
	330 i xDrive	07.15→	185/190				1 987 482 491	↔ 1584	
	335 d xDrive	11.13→	225/230				1 987 482 491	↔ 1584	
	335 i	03.13→	225/230				1 987 482 491	↔ 1584	
	335 i xDrive	03.13→	225/230				1 987 482 491	↔ 1584	
	340 i	07.15→	240				1 987 482 491	↔ 1584	
	340 i xDrive	07.15→	240				1 987 482 491	↔ 1584	
<b>Serie 4 Cabrio [F 33]</b>									
									
	420 d	03.14→	135		AAK		1 987 482 491	↔ 1584	
		07.15→	140				1 987 482 491	↔ 1584	
	420 i	06.14→	135				1 987 482 491	↔ 1584	
	425 d	06.14→	160				1 987 482 491	↔ 1584	
	428 i	03.14→	180				1 987 482 491	↔ 1584	
	428 i xDrive	03.14→	180				1 987 482 491	↔ 1584	
	430 d	06.14→	190-210				1 987 482 491	↔ 1584	
	435 d	06.14→	225/230				1 987 482 491	↔ 1584	
	435 i	03.14→	225/230				1 987 482 491	↔ 1584	
	435 i xDrive	06.14→	225/230				1 987 482 491	↔ 1584	







◀ BMW

**Serie 4 Coupé [F 32]**



	418 d	03.15→	110		1987 482 491	↔ 1584
	420 d	09.13-02.15	135	AAK	1987 482 491	↔ 1584
		03.15→	140		1987 482 491	↔ 1584
	420 i	11.13→	135	AAK	1987 482 491	↔ 1584
	420 i xDrive	11.13→	135		1987 482 491	↔ 1584
	425 d	03.14→	160	AAK	1987 482 491	↔ 1584
	428 i	09.13→	180		1987 482 491	↔ 1584
	428 i xDrive	09.13→	180		1987 482 491	↔ 1584
	430 d	11.13→	190-210		1987 482 491	↔ 1584
	430 d xDrive	03.14→	190-210		1987 482 491	↔ 1584
	435 d xDrive	11.13→	225/230		1987 482 491	↔ 1584
	435 i	09.13→	225/230		1987 482 491	↔ 1584
	435 i xDrive	09.13→	225/230		1987 482 491	↔ 1584

**Serie 4 GC [E 36]**



	430 d xDrive	06.14→	190-210	AAK	1987 482 491	↔ 1584
--	--------------	--------	---------	-----	--------------	--------

**Serie 4 GC [F 36]**

















































	418 d	05.14→	105	AAK	1987 482 491	↔ 1584
		07.15→	110		1987 482 491	↔ 1584
	418 i	07.15→	100		1987 482 491	↔ 1584
	420 d	05.14-03.15	135	AAK	1987 482 491	↔ 1584
		03.15→	140		1987 482 491	↔ 1584
	420 d xDrive	05.14-02.15	135	AAK	1987 482 491	↔ 1584
		03.15→	140		1987 482 491	↔ 1584
	420 i	05.14→	135	AAK	1987 482 491	↔ 1584
	420 i xDrive	06.14→	135		1987 482 491	↔ 1584
	428 i	05.14→	180		1987 482 491	↔ 1584
	428 i xDrive	05.14→	180		1987 482 491	↔ 1584
	430 d	06.14→	190-210	AAK	1987 482 491	↔ 1584
	435 d xDrive	06.14→	230	AAK	1987 482 491	↔ 1584
	435 i	05.14→	225		1987 482 491	↔ 1584
	435 i xDrive	06.14→	225		1987 482 491	↔ 1584

**Serie 5 [E 34]**













	M 5 3.6	11.90-12.94	232		0986 473 937	👁️ ← 60
					0986 473 938	👁️ → 60
	M 5 3.8	03.92-06.94	240-250	FSB	0986 473 937	👁️ ← 60
					0986 473 938	👁️ → 60
	518 i	09.89-12.95	83/85		0986 474 862	👁️ ← 60
					0986 474 863	👁️ → 60
	520 i	09.89-12.95	110	INB	0986 473 939	👁️ ← 60
					0986 473 940	👁️ → 60
					0986 474 862	👁️ ← 60
					0986 474 863	👁️ → 60
	525 i	09.89-12.95	141		0986 473 939	👁️ ← 60
					0986 473 940	👁️ → 60
					0986 474 862	👁️ ← 60
					0986 474 863	👁️ → 60
	525 td	09.91-12.95	85/105		0986 474 862	👁️ ← 60
					0986 474 863	👁️ → 60

		S							
530i		09.92-12.95	160				0 986 473 939	 ← 60	
							0 986 473 940	 → 60	
535i		01.89-12.94	155				0 986 473 939	 ← 60	
							0 986 473 940	 → 60	
540i		09.92-12.96	210				0 986 473 937	 ← 60	
							0 986 473 938	 → 60	
									
	M 5 3.6	11.90-12.94	232			ATE	0 986 474 888	 ← 40	F 026 A06 122 <sup>7</sup>
	M 5 3.8	03.92-06.94	240-250				0 986 474 888	 ← 40	F 026 A06 122 <sup>7</sup>
	518i	09.89-12.94	83				0 986 473 881	 ← 38	F 026 A06 134 <sup>7</sup>
		09.90-12.95	85				0 986 473 881	 ← 38	
							0 986 473 882	 → 38	F 026 A06 134 <sup>7</sup>
	520i	09.89-12.95	110				0 986 473 881	 ← 38	F 026 A06 134 <sup>7</sup>
							0 986 473 882	 → 38	F 026 A06 134 <sup>7</sup>
	525i	09.89-12.96	141				0 986 473 881	 ← 38	F 026 A06 134 <sup>7</sup>
							0 986 473 882	 → 38	F 026 A06 134 <sup>7</sup>
	525ix	09.91-12.95	141				0 986 473 881	 ← 38	
							0 986 473 882	 → 38	
	525td	09.91-12.95	85/105				0 986 473 881	 ← 38	F 026 A06 134 <sup>7</sup>
	525tds						0 986 473 882	 → 38	F 026 A06 134 <sup>7</sup>
	530i	09.92-12.95	160				0 986 473 881	 ← 38	
							0 986 473 882	 → 38	
	535i	01.89-12.94	155				0 986 473 881	 ← 38	F 026 A06 134 <sup>7</sup>
							0 986 473 882	 → 38	F 026 A06 134 <sup>7</sup>
	540i	09.92-09.95	210			ATE	0 986 474 888	 ← 40	F 026 A06 122 <sup>7</sup>
		09.93-12.96	210				0 986 474 888	 ← 40	F 026 A06 122 <sup>7</sup>
									
	M 5 3.8	03.92-12.95	240-250				1 987 477 071	↔ 1755	
	518i	09.89-12.94	83			SBR	1 987 477 071	↔ 1755	
		09.90-12.95	85				1 987 477 071	↔ 1755	
	520i	09.89-12.95	110				1 987 477 071	↔ 1755	
	525i	09.89-12.95	85/105/141				1 987 477 071	↔ 1755	
	525ix	09.91-12.95	85/105/141				1 987 477 071	↔ 1755	
	525td	03.93-12.95	85/105/141				1 987 477 071	↔ 1755	
	525tds	09.91-12.95	85/105/141				1 987 477 071	↔ 1755	
	530i	09.92-12.95	160				1 987 477 071	↔ 1755	
	540i	09.92-09.95	210				1 987 477 071	↔ 1755	
	M 5 3.8	03.92-12.95	240-250				0 265 001 339 <sup>3</sup>		
	518i	09.89-12.95	83/85				0 265 001 339 <sup>3</sup>		
	520i	09.89-12.95	100/110				0 265 001 339 <sup>3</sup>		
	525i	09.89-12.95	141				0 265 001 339 <sup>3</sup>		
	525ix	09.91-12.95	141				0 265 001 340 <sup>3</sup>		
	525td, tds	09.91-12.95	85/105				0 265 001 339 <sup>3</sup>		
	530i	09.92-12.95	160				0 265 001 339 <sup>3</sup>		
	540i	09.92-09.95	210				0 265 001 339 <sup>3</sup>		
<b>Serie 5 [E 39]</b>									
									
	520d	04.00-07.03	100			BHO	0 986 473 262	 ← 60	
							0 986 474 262	 → 60	
						BHO	0 986 473 090	 ←	
							0 986 474 090	 → 59,93	
	520i	09.95-06.03	100-110				0 986 473 090	 ←	
							0 986 474 090	 → 59,93	



		S							
	◀ BMW Serie 5 [E 39]								
520 i		09.00-07.03	120-125			BHO	0986 473 262		60
							0986 474 262		60
520 i		09.00-07.03	120-125			BHO	0986 473 090		
							0986 474 090		59,93
523 i		09.95-12.02	125/135				0986 473 090		
							0986 474 090		59,93
525 d		04.00-07.03	120/141			BHO	0986 473 262		60
							0986 474 262		60
525 i		04.00-07.03	120/141			BHO	0986 473 090		
							0986 474 090		59,93
525 td		01.96-09.00	85/105				0986 473 090		
525 tds		01.96-09.00	85/105				0986 474 090		59,93
528 i		09.95-09.00	142				0986 473 090		
							0986 474 090		59,93
530 d		08.98-09.00	135-142				0986 473 090		
							0986 474 090		59,93
530 i		09.00-07.03	170				0986 473 262		60
							0986 474 262		60
535 i		01.96-09.97	173-180				0986 473 090		
							0986 474 090		59,93
540 i		01.96-07.03	210				0986 473 262		60
							0986 474 262		60
520 d		09.95-07.03	100-110/			INB	0986 473 117		39,93
							0986 474 117		39,93
520 i		09.95-07.03	120-125			INB	0986 473 124		39,93
							0986 474 124		39,93
523 i		09.95-09.00	125			INB	0986 473 117		39,93
							0986 474 117		39,93
523 i		09.95-09.00	125			INB	0986 473 124		39,93
							0986 474 124		39,93
523 i		09.98-08.00	125				0986 473 117		39,93
							0986 474 117		39,93
523 i		03.99-12.02	135				0986 473 117		39,93
							0986 474 117		39,93
525 d		04.00-07.03	120/141				0986 473 117		39,93
525 i		04.00-07.03	120/141				0986 474 117		39,93
525 td		01.96-09.00	85/105			INB	0986 473 117		39,93
							0986 474 117		39,93
525 tds		01.96-09.00	85/105			INB	0986 473 124		39,93
							0986 474 124		39,93
528 i		09.95-09.00	142				0986 473 117		39,93
							0986 474 117		39,93
530 d		08.98-07.03	135-142/				0986 473 117		39,93
530 i		08.98-07.03	170				0986 474 117		39,93
535 i		01.96-07.03	173-180				0986 473 117		39,93
540 i		01.96-07.03	210				0986 474 117		39,93
540 i		01.96-07.03	210				0986 473 117		39,93
540 i		01.96-07.03	210				0986 474 117		39,93
M 5		10.98-07.03	294				1987 477 693		1924
							1987 477 694		1877
520 d		09.95-07.03	100-110/				1987 477 693		1924
520 i		09.95-07.03	120-125				1987 477 694		1877
523 i		09.95-12.02	125/135				1987 477 693		1924
							1987 477 694		1877













		S							
525 d, i, td, tds		01.96-07.03	85/105/ 120/141				1 987 477 693	← 1924	
							1 987 477 694	→ 1877	
528 i		09.95-09.00	142				1 987 477 693	← 1924	
							1 987 477 694	→ 1877	
530 d		08.98-07.03	135-142/				1 987 477 693	← 1924	
530 i			170				1 987 477 694	→ 1877	
535 i		01.96-07.03	173-180				1 987 477 693	← 1924	
							1 987 477 694	→ 1877	
540 i		01.96-07.03	210				1 987 477 693	← 1924	
							1 987 477 694	→ 1877	
 M 5		10.98-07.03	294				0 986 594 508 <sup>3</sup>		
							0 986 594 509 <sup>4</sup>		
520 d		04.00-07.03	100				0 986 594 508 <sup>3</sup>		
							0 986 594 509 <sup>4</sup>		
520 i		09.95-09.98	100-110				0 986 594 510 <sup>3</sup>		
							0 986 594 511 <sup>4</sup>		
		10.98-06.03	100-110				0 986 594 508 <sup>3</sup>		
							0 986 594 509 <sup>4</sup>		
		09.00-07.03	120-125				0 986 594 508 <sup>3</sup>		
							0 986 594 509 <sup>4</sup>		
523 i		09.95-09.98	125				0 986 594 510 <sup>3</sup>		
							0 986 594 511 <sup>4</sup>		
		10.98-09.00	125				0 986 594 508 <sup>3</sup>		
							0 986 594 509 <sup>4</sup>		
		03.99-12.02	135				0 986 594 508 <sup>3</sup>		
							0 986 594 509 <sup>4</sup>		
525 d		04.00-07.03	120/141				0 986 594 508 <sup>3</sup>		
525 i							0 986 594 509 <sup>4</sup>		
525 td		01.96-09.98	85/105				0 986 594 510 <sup>3</sup>		
525 tds							0 986 594 511 <sup>4</sup>		
		10.98-09.00	85/105				0 986 594 508 <sup>3</sup>		
							0 986 594 509 <sup>4</sup>		
528 i		09.95-09.98	142				0 986 594 510 <sup>3</sup>		
							0 986 594 511 <sup>4</sup>		
		10.98-09.00	142				0 986 594 508 <sup>3</sup>		
							0 986 594 509 <sup>4</sup>		
530 d		08.98-07.03	135-142/				0 986 594 508 <sup>3</sup>		
530 i			170				0 986 594 509 <sup>4</sup>		
535 i		01.96-09.98	173-180				0 986 594 510 <sup>3</sup>		
							0 986 594 511 <sup>4</sup>		
		10.98-07.03	173-180				0 986 594 508 <sup>3</sup>		
							0 986 594 509 <sup>4</sup>		
540 i		01.96-09.98	210				0 986 594 510 <sup>3</sup>		
							0 986 594 511 <sup>4</sup>		
		10.98-07.03	210				0 986 594 508 <sup>3</sup>		
							0 986 594 509 <sup>4</sup>		
<b>Serie 5 [E 60]</b>									
									
 520 d		09.07-02.10	120-130				0 986 473 374	← 60	
							0 986 474 374	→ 60	
520 d		09.05-02.10	110/115/				0 986 473 368	← 60	
520 i			120-125				0 986 473 374	← 60	
							0 986 474 368	→ 60	
							0 986 474 374	→ 60	
520 i		07.03-03.05	125			AG	0 986 473 374	← 60	
							0 986 474 374	→ 60	
						GS	0 986 473 368	← 60	
							0 986 474 368	→ 60	



		S							
	◀ BMW Serie 5 [E 60]								
523 i		03.05-02.10	130			0986 473 368		←	60
				0986 473 374		←	60		
		03.07-02.10	140			0986 474 368		→	60
				0986 474 374		→	60		
525 d		03.07-02.10	145			0986 473 374		←	60
				0986 474 374		→	60		
525 d		09.03-03.07	120/130/			0986 473 368		←	60
525 i			141			0986 473 374		←	60
				0986 474 368		→	60		
		03.05-02.10	160			0986 474 374		→	60
				0986 473 374		←	60		
525 i, Li		03.05-05.10	160			0986 474 374		→	60
525 Li		08.05-05.10	160			0986 473 368		←	60
528 i		03.07-02.10	172			0986 473 374		←	60
				0986 474 374		→	60		
530 d		07.03-02.10	160/170/			0986 473 374		←	60
530 i			173/190-200			0986 474 374		→	60
	520 d	09.05-02.10	110/115/			0986 473 443		←	42
				0986 474 443		→	42		
520 i		07.03-03.05	125			0986 473 443		←	42
				0986 474 443		→	42		
523 i		03.05-02.10	130/140			0986 473 443		←	42
				0986 474 443		→	42		
525 d, d xDrive, i, i xDrive, Li, xd, xi		09.03-05.10	120/130/			0986 473 443		←	42
				0986 474 443		→	42		
528 i		03.07-02.10	172			0986 473 443		←	42
				0986 474 443		→	42		
530 d, d xDrive, i, i xDrive, xd, xi		07.03-02.10	160/170/			0986 473 443		←	42
				0986 474 443		→	42		
	M 5	11.04-12.09	373			1987 477 947		→	1673
				1987 477 948		←	1681		
520 d		09.05-02.10	110/115/			1987 477 947		→	1673
				1987 477 948		←	1681		
520 i		07.03-03.05	125			1987 477 947		→	1673
				1987 477 948		←	1681		
523 i		03.05-02.10	130/140			1987 477 947		→	1673
				1987 477 948		←	1681		
525 d, d xDrive, i, i xDrive, xd, xi		09.03-02.10	120/130/			1987 477 947		→	1673
				1987 477 948		←	1681		
528 i		03.07-02.10	172			1987 477 947		→	1673
				1987 477 948		←	1681		
530 d, d xDrive, i, i xDrive, xd, xi		07.03-02.10	160/170/			1987 477 947		→	1673
				1987 477 948		←	1681		
535 d		09.04-02.10	200/210			1987 477 947		→	1673
				1987 477 948		←	1681		
540 i		09.05-02.10	225			1987 477 947		→	1673
				1987 477 948		←	1681		
545 i		09.03-09.05	245			1987 477 947		→	1673
				1987 477 948		←	1681		
550 i		09.05-02.10	270			1987 477 947		→	1673
				1987 477 948		←	1681		



		S							
	<b>520 d, i</b>	09.05-02.10	110/115/120-130				0 265 007 983 <sup>4</sup>		
	<b>520 i</b>	07.03-03.05	125				0 265 007 983 <sup>4</sup>		
	<b>523 i</b>	03.05-02.10	130/140				0 265 007 983 <sup>4</sup>		
	<b>525 d xDrive, i xDrive, xd, xi</b>	03.05-02.10	145/160				0 265 007 982 <sup>3</sup>		
	<b>525 d, d xDrive, i, i xDrive, Li, xd, xi</b>	03.05-05.10	145/160				0 265 007 983 <sup>4</sup>		
	<b>525 d, i</b>	09.03-03.07	120/130/141				0 265 007 983 <sup>4</sup>		
	<b>528 i</b>	03.07-02.10	172				0 265 007 983 <sup>4</sup>		
	<b>530 d</b>	07.03-09.05	160				0 265 007 983 <sup>4</sup>		
		09.05-03.07	170				0 265 007 983 <sup>4</sup>		
	<b>530 d xDrive, xd</b>	03.07-02.10	173				0 265 007 982 <sup>3</sup>		
	<b>530 d, d xDrive, xd</b>	03.07-02.10	173				0 265 007 983 <sup>4</sup>		
	<b>530 i</b>	07.03-03.05	170				0 265 007 983 <sup>4</sup>		
		03.05-02.10	190-200				0 265 007 983 <sup>4</sup>		
	<b>530 i xDrive</b>	03.05-02.10	190				0 265 007 982 <sup>3</sup>		
	<b>530 xi</b>						0 265 007 983 <sup>4</sup>		
		03.07-02.10	200				0 265 007 982 <sup>3</sup>		
	<b>530 i, i xDrive, xi</b>	03.07-02.10	200				0 265 007 983 <sup>4</sup>		
	<b>530 xd</b>	09.05-03.07	170				0 265 007 982 <sup>3</sup>		
							0 265 007 983 <sup>4</sup>		
	<b>535 d</b>	09.04-02.10	200/210				0 265 007 983 <sup>4</sup>		
	<b>540 i</b>	09.05-02.10	225				0 265 007 983 <sup>4</sup>		
	<b>545 i</b>	09.03-09.05	245				0 265 007 983 <sup>4</sup>		
	<b>550 i</b>	09.05-02.10	270				0 265 007 983 <sup>4</sup>		
<b>Serie 5 [F 10]</b>									
									
	<b>Active Hybrid</b>	11.11→	225-250				0 265 009 227 <sup>3</sup>		
	<b>M 5</b>	09.11→	412				0 265 009 227 <sup>3</sup>		
	<b>518 d</b>	07.13→	105/110				0 265 009 227 <sup>3</sup>		
	<b>520 d</b>	05.10-08.11	135				0 265 007 981 <sup>3</sup>		
		06.14→	140				0 265 009 227 <sup>3</sup>		
	<b>520 d xDrive</b>	07.13-06.14	135				0 265 007 982 <sup>3</sup>		
		06.14→	140				0 265 007 982 <sup>3</sup>		
	<b>520 d, d ed, i</b>	09.11→	135				0 265 009 227 <sup>3</sup>		
	<b>523 i</b>	03.10-08.11	150				0 265 007 981 <sup>3</sup>		
							0 265 009 227 <sup>3</sup>		
	<b>525 d</b>	03.10-08.11	150				0 265 009 227 <sup>3</sup>		
		09.11→	160				0 265 008 036 <sup>4</sup>		
							0 265 009 227 <sup>3</sup>		
	<b>525 d xDrive</b>	09.11→	160				0 265 007 982 <sup>3</sup>		
	<b>528 i</b>	03.10-08.11	190				0 265 007 981 <sup>3</sup>		
		09.11→	180				0 265 009 227 <sup>3</sup>		
	<b>528 i xDrive</b>	09.11→	180				0 265 007 982 <sup>3</sup>		
	<b>530 d</b>	03.10-08.11	180				0 265 007 981 <sup>3</sup>		
		09.11→	190-210				0 265 009 227 <sup>3</sup>		
	<b>530 d xDrive</b>	03.11→	190-210				0 265 007 982 <sup>3</sup>		
	<b>530 i</b>	09.11-06.13	200				0 265 009 227 <sup>3</sup>		
	<b>535 d</b>	09.10-08.11	220				0 265 007 981 <sup>3</sup>		
	<b>535 d xDrive, i xDrive</b>	09.10→	225/230				0 265 007 982 <sup>3</sup>		
	<b>535 d, i</b>	03.10→	225/230				0 265 009 227 <sup>3</sup>		
	<b>550 d xDrive</b>	03.12→	280				0 265 007 982 <sup>3</sup>		
	<b>550 i</b>	03.10-08.11	300				0 265 007 981 <sup>3</sup>		
		09.11-06.13	300				0 265 009 227 <sup>3</sup>		
		07.13→	330				0 265 009 227 <sup>3</sup>		
	<b>550 i xDrive</b>	09.10-06.13	300				0 265 007 982 <sup>3</sup>		
		07.13→	330				0 265 007 982 <sup>3</sup>		



◀ BMW

**Serie 5 GT [F 07]**



	520 d	07.12→	135		0 265 008 036 <sup>4</sup>	
					0 265 009 227 <sup>3</sup>	
	528 i GT	07.13→	180		0 265 008 036 <sup>4</sup>	
					0 265 009 227 <sup>3</sup>	
	530 d	10.09-06.12	180	TW	0 265 007 981 <sup>3</sup>	
					0 265 009 227 <sup>3</sup>	
		09.10-08.11	155		0 265 007 981 <sup>3</sup>	
		09.10-06.12	155		0 265 008 036 <sup>4</sup>	
		09.11-06.12	155		0 265 009 227 <sup>3</sup>	
	530 d xDrive	07.12→	190		0 265 009 227 <sup>3</sup>	
		06.10-06.12	180		0 265 007 982 <sup>3</sup>	
		07.12→	190		0 265 007 982 <sup>3</sup>	
	530 d	10.09-06.12	180		0 265 008 036 <sup>4</sup>	
	530 d xDrive	07.12→	190		0 265 008 036 <sup>4</sup>	
	535 d xDrive, i xDrive	09.10→	220/225/230		0 265 007 982 <sup>3</sup>	
	535 d, d xDrive, i, i xDrive	10.09→	220/225/230		0 265 008 036 <sup>4</sup>	
	535 d, i	10.09→	220/225/230		0 265 009 227 <sup>3</sup>	
	550 i	10.09-08.11	300		0 265 007 981 <sup>3</sup>	
		09.11-06.12	300		0 265 009 227 <sup>3</sup>	
		07.12→	330		0 265 009 227 <sup>3</sup>	
	550 i xDrive	06.10-06.12	300		0 265 007 982 <sup>3</sup>	
		07.12→	330		0 265 007 982 <sup>3</sup>	
	550 i	10.09-06.12	300		0 265 008 036 <sup>4</sup>	
	550 i xDrive	07.12→	330		0 265 008 036 <sup>4</sup>	













**Serie 5 Touring [E 34]**



	M 5	04.92-06.94	240-250	FSB	0 986 473 937	← 60
					0 986 473 938	→ 60
	518 g	03.93-12.96	75-85		0 986 474 862	← 60
	518 i				0 986 474 863	→ 60
	520 i	11.91-12.96	110		0 986 473 939	← 60
					0 986 473 940	→ 60
	525 i, td, tds	11.91-12.96	85/105/		0 986 473 939	← 60
			141		0 986 473 940	→ 60
	530 i	09.92-12.96	160		0 986 473 939	← 60
					0 986 473 940	→ 60
	540 i	10.93-12.96	210		0 986 473 937	← 60
					0 986 473 938	→ 60



	M 5	04.92-06.94	240-250		0 986 474 888	← 40	F 026 A06 122 <sup>7</sup>
					0 986 471 883	← 40	
	518 g	03.93-12.96	75-85		0 986 473 241		
					0 986 471 884	→ 40	
					0 986 474 241		
	520 i	11.91-12.96	110		0 986 471 883	← 40	
					0 986 473 241		
					0 986 471 884	→ 40	
	525 i	11.91-12.96	85/105/		0 986 471 883	← 40	
			141		0 986 473 241		
	525 ix				0 986 473 241		
	525 td				0 986 471 884	→ 40	
	525 tds				0 986 474 241		

		S							
530 i		09.92-12.96	160				0 986 471 883 0 986 473 241 0 986 471 884 0 986 474 241	← 40 → 40	
540 i		10.93-12.96	210			ATE	0 986 474 888	← 40	F 026 A06 122 <sup>7</sup>
									
	<b>M 5</b>	04.92-12.95	240-250				1 987 477 071	↔ 1755	
	518 g	11.95-06.96	75-85				1 987 477 071	↔ 1755	
	518 i	03.93-12.96	75-85				1 987 477 071	↔ 1755	
	520 i	11.91-12.96	110				1 987 477 071	↔ 1755	
	525 i	11.91-12.96	85/105/141				1 987 477 071	↔ 1755	
	525 ix	02.92-12.96	85/105/141				1 987 477 071	↔ 1755	
	525 td	03.93-12.96	85/105/141				1 987 477 071	↔ 1755	
	525 tds	12.91-12.96	85/105/141				1 987 477 071	↔ 1755	
	530 i	09.92-12.96	160				1 987 477 071	↔ 1755	
	540 i	10.93-12.96	210				1 987 477 071	↔ 1755	
	<b>M 5</b>	04.92-12.95	240-250				0 265 001 339 <sup>3</sup>		
	518 g, i	03.93-12.96	75-85				0 265 001 339 <sup>3</sup>		
	520 i	11.91-12.96	110				0 265 001 339 <sup>3</sup>		
	525 i	11.91-12.96	141				0 265 001 339 <sup>3</sup>		
	525 ix	02.92-12.96	141				0 265 001 340 <sup>3</sup>		
	525 td, tds	12.91-12.96	85/105				0 265 001 339 <sup>3</sup>		
	530 i	09.92-12.96	160				0 265 001 339 <sup>3</sup>		
	540 i	10.93-12.96	210				0 265 001 339 <sup>3</sup>		
<b>Serie 5 Touring [E 39]</b>									
									
	520 d	04.00-07.03	100			BHO	0 986 473 262 0 986 474 262	← 60 → 60	
						BHO	0 986 473 090 0 986 474 090	← → 59,93	
	520 i	12.96-12.01	100-110				0 986 473 090 0 986 474 090	← → 59,93	
		09.00-05.04	120-125			BHO	0 986 473 262 0 986 474 262	← 60 → 60	
						BHO	0 986 473 090 0 986 474 090	← → 59,93	
	523 i	01.97-09.00	125				0 986 473 090 0 986 474 090	← → 59,93	
	525 d	04.00-05.04	120/141			BHO	0 986 473 262 0 986 474 262	← 60 → 60	
	525 i					BHO	0 986 473 090 0 986 474 090	← → 59,93	
	525 tds	03.97-09.00	105				0 986 473 090 0 986 474 090	← → 59,93	
	528 i	01.97-09.00	142				0 986 473 090 0 986 474 090	← → 59,93	
	530 d	08.98-09.00	135-142				0 986 473 090 0 986 474 090	← → 59,93	
		10.00-05.04	135-142				0 986 473 262 0 986 474 262	← 60 → 60	
	530 i	09.00-05.04	170				0 986 473 262 0 986 474 262	← 60 → 60	
	540 i	03.97-05.04	210				0 986 473 262 0 986 474 262	← 60 → 60	







◀ BMW Serie 5 Touring [E 39]









































	520 d	12.96-05.04	100-110/	1987 477 693	← 1924
	520 i		120-125	1987 477 694	→ 1877
	523 i	01.97-09.00	125	1987 477 693	← 1924
				1987 477 694	→ 1877
	525 d, i, tds	03.97-05.04	105/120/ 141	1987 477 693	← 1924
				1987 477 694	→ 1877
	528 i	01.97-09.00	142	1987 477 693	← 1924
				1987 477 694	→ 1877
	530 d	08.98-05.04	135-142/	1987 477 693	← 1924
	530 i		170	1987 477 694	→ 1877
	540 i	03.97-05.04	210	1987 477 693	← 1924
				1987 477 694	→ 1877

	520 d	04.00-07.03	100	0986 594 508 <sup>3</sup>	
				0986 594 512 <sup>4</sup>	
	520 i	12.96-09.98	100-110	0986 594 510 <sup>3</sup>	
				0986 594 533 <sup>4</sup>	
		10.98-12.01	100-110	0986 594 508 <sup>3</sup>	
				0986 594 512 <sup>4</sup>	
		09.00-05.04	120-125	0986 594 508 <sup>3</sup>	
				0986 594 512 <sup>4</sup>	
	523 i	01.97-09.98	125	0986 594 510 <sup>3</sup>	
				0986 594 533 <sup>4</sup>	
		10.98-09.00	125	0986 594 508 <sup>3</sup>	
				0986 594 512 <sup>4</sup>	
	525 d	04.00-05.04	120/141	0986 594 508 <sup>3</sup>	
	525 i			0986 594 512 <sup>4</sup>	
	525 tds	03.97-09.98	105	0986 594 510 <sup>3</sup>	
				0986 594 533 <sup>4</sup>	
		10.98-09.00	105	0986 594 508 <sup>3</sup>	
				0986 594 512 <sup>4</sup>	
	528 i	01.97-09.98	142	0986 594 510 <sup>3</sup>	
				0986 594 533 <sup>4</sup>	
		10.98-09.00	142	0986 594 508 <sup>3</sup>	
				0986 594 512 <sup>4</sup>	
	530 d	08.98-05.04	135-142/	0986 594 508 <sup>3</sup>	
	530 i		170	0986 594 512 <sup>4</sup>	
	540 i	03.97-09.98	210	0986 594 510 <sup>3</sup>	
				0986 594 533 <sup>4</sup>	
		10.98-05.04	210	0986 594 508 <sup>3</sup>	
				0986 594 512 <sup>4</sup>	

Serie 5 Touring [E 61]



	520 d	09.07-08.10	120-130	0986 473 374	← 60
				0986 474 374	→ 60
	520 d	09.05-08.10	110/	0986 473 368	← 60
	520 i		120-125	0986 473 374	← 60
				0986 474 368	→ 60
				0986 474 374	→ 60
	523 i	03.05-08.10	130	0986 473 368	← 60
				0986 473 374	← 60
				0986 474 368	→ 60
				0986 474 374	→ 60
		03.07-08.10	140	0986 473 374	← 60
				0986 474 374	→ 60
	525 d	03.07-08.10	145	0986 473 374	← 60
				0986 474 374	→ 60

		S							
525 d		05.04-03.07	120/130/				0 986 473 368		60
525 i			141				0 986 473 374		60
							0 986 474 368		60
							0 986 474 374		60
525 i		03.05-08.10	160				0 986 473 368		60
							0 986 473 374		60
							0 986 474 368		60
							0 986 474 374		60
530 d		05.04-08.10	160/170/				0 986 473 374		60
530 i			173/190-200				0 986 474 374		60
									
	<b>M 5</b>	03.07-08.10	373				1 987 477 947		1673
							1 987 477 948		1681
	520 d	09.05-08.10	110/				1 987 477 947		1673
	520 i		120-130				1 987 477 948		1681
	523 i	03.05-08.10	130/140				1 987 477 947		1673
							1 987 477 948		1681
	525 d, d xDrive, i, i xDrive, xd, xi	05.04-08.10	120/130/141/ 145/160				1 987 477 947		1673
							1 987 477 948		1681
	530 d, d xDrive, i, i xDrive, xd, xi	05.04-08.10	160/170/173/ 190-200				1 987 477 947		1673
							1 987 477 948		1681
	535 d	09.04-08.10	200/210				1 987 477 947		1673
							1 987 477 948		1681
	545 i	05.04-09.05	245				1 987 477 947		1673
							1 987 477 948		1681
	550 i	09.05-08.10	270				1 987 477 947		1673
							1 987 477 948		1681
	520 d, i	09.05-08.10	110/120-130				0 265 007 851 <sup>4</sup>		
	523 i	03.05-08.10	130				0 265 007 851 <sup>4</sup>		
		03.07-08.10	140				0 265 007 851 <sup>4</sup>		
	525 d	05.04-03.07	130				0 265 007 851 <sup>4</sup>		
		12.04-03.07	120				0 265 007 851 <sup>4</sup>		
	525 d xDrive, xd	09.07-08.10	145				0 265 007 982 <sup>3</sup>		
	525 d, d xDrive, xd	03.07-08.10	145				0 265 007 851 <sup>4</sup>		
	525 i	05.04-03.05	141				0 265 007 851 <sup>4</sup>		
		03.05-08.10	160				0 265 007 851 <sup>4</sup>		
	525 i xDrive	09.08-08.10	160				0 265 007 851 <sup>4</sup>		
	525 i xDrive, xi	03.05-08.10	160				0 265 007 982 <sup>3</sup>		
	525 xi	03.05-08.08	160				0 265 007 851 <sup>4</sup>		
	530 d	05.04-09.05	160				0 265 007 851 <sup>4</sup>		
	530 d xDrive, i xDrive, xd	09.05-08.10	170/173/190				0 265 007 982 <sup>3</sup>		
	530 d, d xDrive, i xDrive, xd	09.05-08.10	170/173/190				0 265 007 851 <sup>4</sup>		
	530 i	03.05-03.10	190-200				0 265 007 851 <sup>4</sup>		
	530 i xDrive, xi	03.07-08.10	200				0 265 007 982 <sup>3</sup>		
	530 i, i xDrive, xi	03.07-08.10	200				0 265 007 851 <sup>4</sup>		
	530 xi	03.05-08.08	190-200				0 265 007 851 <sup>4</sup>		
							0 265 007 982 <sup>3</sup>		
	535 d	09.04-03.07	200				0 265 007 851 <sup>4</sup>		
		03.07-08.10	210				0 265 007 851 <sup>4</sup>		
	545 i	05.04-09.05	245				0 265 007 851 <sup>4</sup>		
	550 i	09.05-08.10	270				0 265 007 851 <sup>4</sup>		
<b>Serie 5 Touring [F 11]</b>									
									
	518 d	07.13→	105/110				0 265 008 036 <sup>4</sup>		
							0 265 009 227 <sup>3</sup>		
	520 d	09.10→	135/140				0 265 008 036 <sup>4</sup>		
		07.13→	135/140				0 265 007 982 <sup>3</sup>		
	520 d, i	09.10→	135/140				0 265 009 227 <sup>3</sup>		











































BMW Serie 5 Touring [F 11]				
	520 i	09.11→	135/140	0 265 008 036 <sup>4</sup>
	523 i	09.10-08.11	150	0 265 007 981 <sup>3</sup>
				0 265 008 036 <sup>4</sup>
	525 d	09.10-08.11	150	0 265 007 981 <sup>3</sup>
				0 265 008 036 <sup>4</sup>
		09.11→	160	0 265 009 227 <sup>3</sup>
	525 d xDrive	09.11→	160	0 265 007 982 <sup>3</sup>
	525 d, d xDrive	09.11→	160	0 265 008 036 <sup>4</sup>
	528 i	09.10-08.11	190-200	0 265 007 981 <sup>3</sup>
				0 265 008 036 <sup>4</sup>
		09.11→	180	0 265 009 227 <sup>3</sup>
	528 i xDrive	09.11→	180	0 265 007 982 <sup>3</sup>
	528 i, i xDrive	09.11→	180	0 265 008 036 <sup>4</sup>
	530 d	09.10-08.11	180	0 265 007 981 <sup>3</sup>
				0 265 008 036 <sup>4</sup>
		09.11→	190-210	0 265 009 227 <sup>3</sup>
	530 d xDrive	03.11→	190-210	0 265 007 982 <sup>3</sup>
	530 d, d xDrive	03.11→	190-210	0 265 008 036 <sup>4</sup>
	530 i	09.11-06.13	200	0 265 008 036 <sup>4</sup>
				0 265 009 227 <sup>3</sup>
	535 d	09.10-08.11	220	0 265 007 981 <sup>3</sup>
				0 265 008 036 <sup>4</sup>
	535 d xDrive, i xDrive	09.11→	225/230	0 265 007 982 <sup>3</sup>
	535 d, d xDrive, i, i xDrive	09.10→	225/230	0 265 008 036 <sup>4</sup>
	535 d, i	09.10→	225/230	0 265 009 227 <sup>3</sup>
	550 d xDrive	03.12→	280	0 265 007 982 <sup>3</sup>
				0 265 008 036 <sup>4</sup>
	550 i	03.11-08.11	300	0 265 007 981 <sup>3</sup>
		03.11-06.13	300	0 265 008 036 <sup>4</sup>
		09.11-06.13	300	0 265 009 227 <sup>3</sup>
		07.13→	330	0 265 008 036 <sup>4</sup>
				0 265 009 227 <sup>3</sup>

**Serie 6 Cabrio [E 64]**

	630 i	09.04-07.10	190	0 986 473 374		60
				0 986 474 374		60
	630 i	09.04-07.10	190	0 986 473 443		42
				0 986 474 443		42
	630 i	09.04-07.10	190/200	0 265 007 983 <sup>4</sup>		
	635 d	09.07-07.10	210	0 265 007 983 <sup>4</sup>		
	645 i	04.04-09.05	245	0 265 007 983 <sup>4</sup>		
	650 i	09.05-07.10	270	0 265 007 983 <sup>4</sup>		

**Serie 6 Cabrio [F 12]**

























	640 xDrive	03.13→	235	SBJ	0 986 134 310	
					0 986 135 310	
	650 i	03.11-06.12	300	SBJ	0 986 134 310	
					0 986 135 310	
	M 6	03.12→	412		0 265 009 227 <sup>3</sup>	
	640 d	09.11→	230		0 265 009 227 <sup>3</sup>	
	640 d xDrive	03.12→	230		0 265 007 982 <sup>3</sup>	

								
640 i	03.11-08.11	235				0 265 007 981 <sup>3</sup>		
	09.11→	235				0 265 009 227 <sup>3</sup>		
640 xDrive	03.13→	235				0 265 007 982 <sup>3</sup>		
650 i	03.11→	300/330				0 265 009 227 <sup>3</sup>		
650 i xDrive	09.11→	300/330				0 265 007 982 <sup>3</sup>		
<b>Serie 6 Coupé [F 13]</b>								
								
 M 6	09.12→	412				0 265 009 227 <sup>3</sup>		
640 d xDrive, xDrive	03.12→	230/235				0 265 007 982 <sup>3</sup>		
640 d, i	10.11→	230/235				0 265 009 227 <sup>3</sup>		
650 i	10.11→	300/330				0 265 009 227 <sup>3</sup>		
650 i xDrive	10.11→	300/330				0 265 007 982 <sup>3</sup>		
<b>Serie 6 [E 63]</b>								
								
 630 i	09.04-07.10	190				0 986 473 374	 ← 60	
						0 986 474 374	 → 60	
								
 630 i	09.04-07.10	190				0 986 473 443	 ← 42	
						0 986 474 443	 → 42	
								
 630 i	09.04-07.10	190/200				0 265 007 983 <sup>4</sup>		
635 d	09.07-07.10	210				0 265 007 983 <sup>4</sup>		
645 i	01.04-09.05	245				0 265 007 983 <sup>4</sup>		
650 i	09.05-07.10	270				0 265 007 983 <sup>4</sup>		
<b>Serie 6 GC [F 06]</b>								
								
 M 6	06.13→	412				0 265 009 227 <sup>3</sup>		
640 d xDrive, i xDrive	04.13→	230/235				0 265 007 982 <sup>3</sup>		
640 d, i	05.12→	230/235				0 265 009 227 <sup>3</sup>		
650 i	07.12→	330				0 265 009 227 <sup>3</sup>		
650 i xDrive	07.12→	330				0 265 007 982 <sup>3</sup>		
<b>Serie 7 [E 32]</b>								
								
 730 i, iL	09.86-06.94	136-145		FLR		0 986 473 937	 ← 60	
						0 986 473 938	 → 60	
	12.87-06.94	136-145		FKR		0 986 473 939	 ← 60	
						0 986 473 940	 → 60	
	09.91-10.94	160				0 986 473 939	 ← 60	
						0 986 473 940	 → 60	
740 i, iL	09.91-10.94	210				0 986 473 937	 ← 60	
						0 986 473 938	 → 60	
750 i, iL	09.87-10.94	220		FSB		0 986 473 937	 ← 60	
						0 986 473 938	 → 60	
								
 730 i, iL	09.86-06.94	136-145		FLR		0 986 471 879	← 38	
						0 986 471 880	→ 38	
	12.87-06.94	136-145		FKR		0 986 473 881	 ← 38	F 026 A06 134 <sup>7</sup>
						0 986 473 882	 → 38	F 026 A06 134 <sup>7</sup>
	09.91-10.94	160				0 986 473 881	 ← 38	F 026 A06 134 <sup>7</sup>
						0 986 473 882	 → 38	F 026 A06 134 <sup>7</sup>



		S							
	◀ BMW Serie 7 [E 32]								
	740 i, iL	09.91-10.94	210				0986 474 888	← 40	F 026 A06 1227
	750 i, iL	02.90-10.94	220				0986 474 888	← 40	F 026 A06 1227
	730 i, iL	09.86-10.94	136-145/160		FKR		1987 477 074	↔ 1855	
	740 i, iL	09.91-10.94	210		FKR		1987 477 074	↔ 1855	
	750 i, iL	09.87-10.94	220		FKR		1987 477 074	↔ 1855	
	730 i, iL	09.86-10.94	136-145/160				0 265 001 339 <sup>3</sup>		
	740 i, iL	09.91-10.94	210				0 265 001 339 <sup>3</sup>		
	750 i, iL	09.87-10.94	220				0 265 001 339 <sup>3</sup>		
	<b>Serie 7 [E 38]</b>								
	725 tds	01.96-12.00	105				0986 473 371	←	
							0986 474 371	→	
	728 i, iL	09.95-10.01	142				0986 473 371	←	
							0986 474 371	→	
	730 d	08.98-12.01	135-142				0986 473 371	←	
							0986 474 371	→	
	730 i, iL	06.94-12.96	155-160				0986 473 371	←	
							0986 474 371	→	
	735 i, iL	09.94-10.01	173-175				0986 473 371	←	
							0986 474 371	→	
	740 i, iL	06.94-08.01	210				0986 473 262	← 60	
							0986 474 262	→ 60	
	725 tds	01.96-12.00	105				0986 473 367	← 40	
							0986 474 367	→ 40	
	728 i, iL	09.95-10.01	142				0986 473 367	← 40	
							0986 474 367	→ 40	
	730 d	08.98-12.01	135-142				0986 473 367	← 40	
							0986 474 367	→ 40	
	730 i, iL	06.94-12.96	155-160				0986 473 367	← 40	
							0986 474 367	→ 40	
	735 i, iL	09.94-10.01	173-175				0986 473 367	← 40	
							0986 474 367	→ 40	
	740 i, iL	06.94-08.01	210				0986 473 367	← 40	
							0986 474 367	→ 40	
	725 tds	01.96-12.00	105				1987 477 533	← 1265	
							1987 477 683	→ 1119	
	728 i, iL	09.95-10.01	142				1987 477 533	← 1265	
							1987 477 683	→ 1119	
	730 d	08.98-12.01	135-142				1987 477 533	← 1265	
							1987 477 683	→ 1119	
	730 i, iL	06.94-12.96	155-160				1987 477 533	← 1265	
							1987 477 683	→ 1119	
	735 i, iL	09.94-10.01	173-175				1987 477 533	← 1265	
							1987 477 683	→ 1119	
	740 d	06.94-12.01	180/210				1987 477 533	← 1265	
	740 i, iL						1987 477 683	→ 1119	
	750 i, iL	06.94-08.01	240/241				1987 477 533	← 1265	
							1987 477 683	→ 1119	
	725 tds	10.98-12.00	105				0986 594 531 <sup>4</sup>		
	728 i, iL	10.98-10.01	142				0986 594 531 <sup>4</sup>		
	730 d	08.98-12.01	135-142				0986 594 531 <sup>4</sup>		



		S							
735 i, iL			10.98-10.01	173-175			0 986 594 531 <sup>4</sup>		
740 d, i, iL			10.98-12.01	180/210			0 986 594 531 <sup>4</sup>		
750 i, iL			10.98-08.01	240/241			0 986 594 531 <sup>4</sup>		
<b>Serie 7 [E 65]</b>									
									
	730 d		10.02-10.08	160/170/			0 986 473 374	 ← 60	
	730 i			190			0 986 474 374	 → 60	
	735 i		11.01-03.05	200			0 986 473 374	 ← 60	
							0 986 474 374	 → 60	
									
	730 d		10.02-03.03	160			0 265 007 461 <sup>3</sup>		
							0 265 007 462 <sup>4</sup>		
			04.03-03.05	160			0 265 007 592 <sup>3</sup>		
							0 265 007 845 <sup>4</sup>		
			04.05-10.08	170			0 265 007 845 <sup>4</sup>		
	730 d, i		03.03-09.05	170			0 265 007 592 <sup>3</sup>		
	730 i		03.03-03.05	170			0 265 007 845 <sup>4</sup>		
			04.05-09.05	190			0 265 007 592 <sup>3</sup>		
			04.05-10.08	190			0 265 007 845 <sup>4</sup>		
	735 i		11.01-03.03	200			0 265 007 461 <sup>3</sup>		
							0 265 007 462 <sup>4</sup>		
			04.03-03.05	200			0 265 007 592 <sup>3</sup>		
							0 265 007 845 <sup>4</sup>		
	740 d		10.02-03.03	190			0 265 007 461 <sup>3</sup>		
							0 265 007 462 <sup>4</sup>		
			04.03-03.05	190			0 265 007 592 <sup>3</sup>		
							0 265 007 845 <sup>4</sup>		
	740 i		04.05-09.05	225			0 265 007 592 <sup>3</sup>		
			04.05-10.08	225			0 265 007 845 <sup>4</sup>		
	745 d		03.05-08.05	220			0 265 007 592 <sup>3</sup>		
							0 265 007 845 <sup>4</sup>		
			09.05-10.08	242			0 265 007 845 <sup>4</sup>		
	745 i		11.01-03.03	245			0 265 007 461 <sup>3</sup>		
							0 265 007 462 <sup>4</sup>		
			04.03-03.05	245			0 265 007 592 <sup>3</sup>		
							0 265 007 845 <sup>4</sup>		
	750 i		04.05-09.05	270			0 265 007 592 <sup>3</sup>		
			04.05-10.08	270			0 265 007 845 <sup>4</sup>		
	760 i		12.02-03.03	327			0 265 007 461 <sup>3</sup>		
							0 265 007 462 <sup>4</sup>		
			04.03-09.05	327			0 265 007 592 <sup>3</sup>		
			04.03-10.08	327			0 265 007 845 <sup>4</sup>		
<b>Serie 7 [E 66]</b>									
									
	730 Li		03.03-10.08	170/190			0 986 473 374	 ← 60	
							0 986 474 374	 → 60	
	735 Li		03.02-03.05	200			0 986 473 374	 ← 60	
							0 986 474 374	 → 60	
									
	730 Ld		09.05-10.08	170			0 265 007 845 <sup>4</sup>		
	730 Li		03.03-03.05	170			0 265 007 592 <sup>3</sup>		
							0 265 007 845 <sup>4</sup>		
			04.05-09.05	190			0 265 007 592 <sup>3</sup>		
			04.05-10.08	190			0 265 007 845 <sup>4</sup>		





	◀ BMW Serie 7 [E 66]							
	735 Li	03.02-03.03	200			0 265 007 461 <sup>3</sup>		
						0 265 007 462 <sup>4</sup>		
		04.03-03.05	200			0 265 007 592 <sup>3</sup>		
						0 265 007 845 <sup>4</sup>		
	740 Li	04.05-09.05	225			0 265 007 592 <sup>3</sup>		
		04.05-10.08	225			0 265 007 845 <sup>4</sup>		
	745 Li	03.02-03.03	245			0 265 007 461 <sup>3</sup>		
						0 265 007 462 <sup>4</sup>		
		04.03-03.05	245			0 265 007 592 <sup>3</sup>		
						0 265 007 845 <sup>4</sup>		
	750 Li	04.05-09.05	270			0 265 007 592 <sup>3</sup>		
		04.05-10.08	270			0 265 007 845 <sup>4</sup>		
	760 Li	12.02-03.03	327			0 265 007 461 <sup>3</sup>		
						0 265 007 462 <sup>4</sup>		
		04.03-09.05	327			0 265 007 592 <sup>3</sup>		
		04.03-10.08	327			0 265 007 845 <sup>4</sup>		

**Serie 7 [F 01]**























	730 d	11.08-08.11	180			0 265 007 981 <sup>3</sup>		
		11.08-06.12	180			0 265 007 983 <sup>4</sup>		
		09.11-06.12	180			0 265 009 227 <sup>3</sup>		
	730 d xDrive	07.12→	190			0 265 007 982 <sup>3</sup>		
	730 d, d xDrive, i	09.09→	190			0 265 007 983 <sup>4</sup>		
	730 d, i	09.11→	190			0 265 009 227 <sup>3</sup>		
	730 i	09.09-08.11	190			0 265 007 981 <sup>3</sup>		
	740 d	09.09-08.11	225			0 265 007 981 <sup>3</sup>		
		09.11-06.12	225			0 265 009 227 <sup>3</sup>		
		07.12→	230			0 265 009 227 <sup>3</sup>		
	740 d xDrive	09.10-06.12	225			0 265 007 982 <sup>3</sup>		
		07.12→	230			0 265 007 982 <sup>3</sup>		
	740 d	09.09-06.12	225			0 265 007 983 <sup>4</sup>		
	740 d xDrive	07.12→	230			0 265 007 983 <sup>4</sup>		
	740 i	11.08-08.11	240			0 265 007 981 <sup>3</sup>		
		11.08-06.12	240			0 265 007 983 <sup>4</sup>		
		09.11-06.12	240			0 265 009 227 <sup>3</sup>		
		07.12→	235			0 265 007 983 <sup>4</sup>		
						0 265 009 227 <sup>3</sup>		
	750 d xDrive	07.12→	280			0 265 007 982 <sup>3</sup>		
						0 265 007 983 <sup>4</sup>		
	750 i	11.08-08.11	300			0 265 007 981 <sup>3</sup>		
		09.11-06.12	300			0 265 009 227 <sup>3</sup>		
		07.12→	330			0 265 009 227 <sup>3</sup>		
	750 i xDrive	09.09-06.12	300			0 265 007 982 <sup>3</sup>		
		07.12→	330			0 265 007 982 <sup>3</sup>		
	750 i	11.08-06.12	300			0 265 007 983 <sup>4</sup>		
	750 i xDrive	07.12→	330			0 265 007 983 <sup>4</sup>		
	760 i	09.09→	400			0 265 007 983 <sup>4</sup>		
						0 265 009 227 <sup>3</sup>		

**Serie 7 [F 02]**



	730 Ld	03.09-08.11	180			0 265 007 981 <sup>3</sup>		
		03.09-06.12	180			0 265 007 983 <sup>4</sup>		
		09.11-06.12	180			0 265 009 227 <sup>3</sup>		
	730 Ld	05.09→	190			0 265 007 983 <sup>4</sup>		
	730 Li	09.11→	190			0 265 009 227 <sup>3</sup>		
	730 Li	05.09-08.11	190			0 265 007 981 <sup>3</sup>		
	740 Li	11.08-08.11	240			0 265 007 981 <sup>3</sup>		
		11.08-06.12	240			0 265 007 983 <sup>4</sup>		

























		S							
740 Li		09.11-06.12	240				0 265 009 227 <sup>3</sup>		
		07.12→	235				0 265 009 227 <sup>3</sup>		
740 Li xDrive		07.12→	235				0 265 007 982 <sup>3</sup>		
740 Li, Li xDrive		07.12→	235				0 265 007 983 <sup>4</sup>		
750 Ld xDrive		07.12→	280				0 265 007 982 <sup>3</sup>		
							0 265 007 983 <sup>4</sup>		
750 Li		11.08-08.11	300				0 265 007 981 <sup>3</sup>		
		09.11-06.12	300				0 265 009 227 <sup>3</sup>		
		07.12→	330				0 265 009 227 <sup>3</sup>		
750 Li xDrive		09.09-06.12	300				0 265 007 982 <sup>3</sup>		
		07.12→	330				0 265 007 982 <sup>3</sup>		
750 Li		11.08-06.12	300				0 265 007 983 <sup>4</sup>		
750 Li xDrive		07.12→	330				0 265 007 983 <sup>4</sup>		
760 Li		09.09→	400				0 265 007 983 <sup>4</sup>		
							0 265 009 227 <sup>3</sup>		
<b>Serie 7 [F 04]</b>									
									
	Active Hybrid	04.10-06.12	300-342				0 265 007 982 <sup>3</sup>		
							0 265 007 983 <sup>4</sup>		
	ActiveHybrid L	07.12→	235-260				0 265 007 983 <sup>4</sup>		
							0 265 009 227 <sup>3</sup>		
	AktiveHybrid	07.12→	235-260				0 265 007 983 <sup>4</sup>		
							0 265 009 227 <sup>3</sup>		
<b>BOGDAN</b>									
<b>2110</b>									
									
	211010	12.09→	59,5				0 986 475 795	↔ 20,6	
	211040	12.09→	65,5				0 986 475 795	↔ 20,6	
<b>2111</b>									
									
	211120	12.09→	59,5				0 986 475 795	↔ 20,6	
	211140	12.09→	65,5				0 986 475 795	↔ 20,6	
<b>2310</b>									
									
	231010	12.09→	59,5				0 986 475 795	↔ 20,6	
	231040	12.09→	65,5				0 986 475 795	↔ 20,6	
<b>CHEVROLET</b>									
<b>Aveo</b>									
									
	1.5 i	08.03→	61				F 026 A06 710	↔	
							0 986 475 939	↔ 19,05	
<b>Aveo Hatchback</b>									
									
	1.4 i	04.05-07.10	69						F 026 A06 210 <sup>7</sup>





		S							
◀ CHEVROLET Aveo Hatchback									
	1.5 i	02.03→	62-63				0986 475 939	↔ 19,05	
	1.4 i	04.05-07.10	69				1987 482 082	← 1384	
							1987 482 083	→ 1396	
<b>Aveo Hatchback [T255]</b>									
	1.2	04.08-12.09	55/62						F 026 A06 210 <sup>7</sup>
		01.10-12.11	55/62				0986 134 330	↔ 52	F 026 A06 210 <sup>7</sup>
							0986 135 330	↔ 52	F 026 A06 210 <sup>7</sup>
	1.4	04.08-12.09	74						F 026 A06 210 <sup>7</sup>
		01.10-12.11	74				0986 134 330	↔ 52	F 026 A06 210 <sup>7</sup>
							0986 135 330	↔ 52	F 026 A06 210 <sup>7</sup>
	1.2	04.08-12.11	55/62				0986 475 939	↔ 19,05	
	1.4	04.08-12.11	74				0986 475 939	↔ 19,05	
	1.2	04.08-12.11	55/62				1987 482 082	← 1384	
							1987 482 083	→ 1396	
	1.4	04.08-12.11	74				1987 482 082	← 1384	
							1987 482 083	→ 1396	
<b>Aveo Hatchback [T300]</b>									
	1.2	06.11→	51/63		15Z		F 026 002 000	↔ 20,64	
	1.3D	09.11→	55/70		15Z		F 026 002 000	↔ 20,64	
	1.4, Turbo	06.11→	74/103		15Z		F 026 002 000	↔ 20,64	
	1.6	06.11→	85		15Z		F 026 002 000	↔ 20,64	
	1.2	10.11-01.12	51/63		MI,STB		1987 482 459	1390	
	1.3D	10.11-01.12	55/70		MI,STB		1987 482 459	1390	
	1.4	10.11-01.12	74		MI,STB		1987 482 459	1390	
	1.6	10.11-01.12	85		MI,STB		1987 482 459	1390	
<b>Aveo [T250]</b>									
	1.2 i	02.06-10.08	53						F 026 A06 210 <sup>7</sup>
	1.4 i	02.06-12.09	69						F 026 A06 210 <sup>7</sup>
		02.06-12.12	69						F 026 A06 099 <sup>7</sup>
		01.10→	69				0986 134 330	↔ 52	F 026 A06 210 <sup>7</sup>
							0986 135 330	↔ 52	F 026 A06 210 <sup>7</sup>
		01.13→	69		TW				F 026 A06 099 <sup>7</sup>
	1.2 i	02.06→	53/56				0986 475 939	↔ 19,05	
	1.4 i	02.06-10.08	69				0986 475 939	↔ 19,05	
		02.06→	69		TW		F 026 A06 710	↔	
							0986 475 939	↔ 19,05	



		S							
									
	1.2i	02.06-10.08	53				1 987 482 082	← 1384	
							1 987 482 083	→ 1396	
	1.4i	02.06→	69				1 987 482 082	← 1384	
							1 987 482 083	→ 1396	
<b>Aveo [T255]</b>									
									
	1.2	01.10-12.11	62				0 986 134 330	← 52	F 026 A06 210 <sup>7</sup>
							0 986 135 330	→ 52	F 026 A06 210 <sup>7</sup>
	1.4	04.08-12.09	74						F 026 A06 210 <sup>7</sup>
		01.10-12.11	74				0 986 134 330	← 52	F 026 A06 210 <sup>7</sup>
							0 986 135 330	→ 52	F 026 A06 210 <sup>7</sup>
									
	1.2	04.08-12.11	62				0 986 475 939	↔ 19,05	
	1.4	04.08-12.11	74				0 986 475 939	↔ 19,05	
									
	1.2	04.08-12.11	62				1 987 482 082	← 1384	
							1 987 482 083	→ 1396	
	1.4	04.08-12.11	74				1 987 482 082	← 1384	
							1 987 482 083	→ 1396	
<b>Aveo [T300]</b>									
									
	1.2	06.11→	51/63		15Z		F 026 002 000	↔ 20,64	
	1.3D	09.11→	55/70		15Z		F 026 002 000	↔ 20,64	
	1.4	06.11→	74		15Z		F 026 002 000	↔ 20,64	
	1.6	06.11→	85		15Z		F 026 002 000	↔ 20,64	
									
	1.2	10.11-01.12	51/63		MI		1 987 482 459	1390	
	1.3D	10.11-01.12	55/70		MI		1 987 482 459	1390	
	1.4	10.11-01.12	74		MI		1 987 482 459	1390	
	1.6	10.11-01.12	85		MI		1 987 482 459	1390	
<b>Blazer</b>									
									
	2.5 D	10.97-01.00	74				0 986 AB8 452	←	
							0 986 AB8 453	→	
	2.8 D Electronic	08.05-05.09	103				0 986 AB8 452	←	
							0 986 AB8 453	→	
<b>Calibra</b>									
									
	2.0 16V	10.93-03.96	110,3				1 987 477 130	1498	
	2.0 16V	10.93-03.96	110,3		HLI		0 265 003 094 <sup>4</sup>		
					HRE		0 265 003 093 <sup>4</sup>		



		S							
◀ CHEVROLET									
<b>Captiva [C100]</b>									
	2.0 CDri	10.06-02.11	93/110				1987 482 293	← 1431	
	2.0 CDri 4x4						1987 482 294	→ 1454	
	2.4	10.06-02.11	100-104				1987 482 293	← 1431	
	2.4 4x4						1987 482 294	→ 1454	
	3.2 4x4	10.06-02.11	165-169				1987 482 293	← 1431	
							1987 482 294	→ 1454	
<b>Corsa Wagon</b>									
	1.0 MPFI 16V	04.99-07.02	50				0986 AB8 449	↔	
	1.0 MPFI 16V	04.99-07.02	50				1987 477 309	← 1373	
							1987 477 310	→ 1078	
<b>Corvette Cabrio</b>									
	5.7	09.91-09.01	225		LAB		0265 001 166 <sup>4</sup>		
					RAB		0265 001 165 <sup>4</sup>		
<b>Corvette Coupé</b>									
	5.7	09.91-08.95	302		LAB		0265 001 166 <sup>4</sup>		
					RAB		0265 001 165 <sup>4</sup>		
<b>Cruze Hatchback [J305]</b>									
	1.4	08.13→	74				1987 482 503	← 1812	
	1.4 Turbo	07.12→	103				1987 482 503	← 1812	
		01.13-06.13	103				1987 482 507	← 1810	
							1987 482 508	→ 1803	
	1.6	07.11-12.13	91				1987 482 503	← 1812	
		07.11→	80				1987 482 503	← 1812	
		01.13-06.13	80				1987 482 507	← 1810	
							1987 482 508	→ 1803	
		01.13-12.13	91				1987 482 507	← 1810	
							1987 482 508	→ 1803	
		10.13→	86				1987 482 503	← 1812	
	1.7 CDI	01.12→	96				1987 482 503	← 1812	
		01.13-06.13	96				1987 482 507	← 1810	
							1987 482 508	→ 1803	
		08.13→	81				1987 482 503	← 1812	
	1.8	07.11→	104				1987 482 503	← 1812	
		01.13-06.13	104				1987 482 507	← 1810	
							1987 482 508	→ 1803	
	2.0 CDI	07.11→	120				1987 482 503	← 1812	
		01.13-06.13	120				1987 482 507	← 1810	
							1987 482 508	→ 1803	





**Cruze [J300]**

Icon	Engine	Start	End	Code	Price	Change
	1.6	05.09→	80/83/91		F 026 002 000	↔ 20,64
	1.8	05.09→	104		F 026 002 000	↔ 20,64
	2.0 CDI	05.09→	110/120		F 026 002 000	↔ 20,64
	1.4, Turbo	08.13→	74/103		1 987 482 503	← 1812
	1.6	05.09-12.10	80	STB	1 987 482 504	↔ 1460
			83	STB	1 987 482 504	↔ 1460
		05.09-12.11	80	4SB,TW	1 987 482 507	← 1810
					1 987 482 508	→ 1803
		05.09→	80	STB	1 987 482 506	↔ 206
		10.10-12.10	91	STB	1 987 482 504	↔ 1460
		10.10-12.11	91	4SB,TW	1 987 482 507	← 1810
					1 987 482 508	→ 1803
		10.10-12.13	91	STB	1 987 482 506	↔ 206
		01.12-12.13	91	4SB	1 987 482 503	← 1812
		01.12→	80	4SB	1 987 482 503	← 1812
		01.13-06.13	80	4SB	1 987 482 507	← 1810
					1 987 482 508	→ 1803
		01.13-12.13	91	4SB	1 987 482 507	← 1810
					1 987 482 508	→ 1803
		10.13→	86		1 987 482 503	← 1812
	1.7 CDI	01.12→	96		1 987 482 503	← 1812
					1 987 482 507	← 1810
					1 987 482 508	→ 1803
		08.13→	81		1 987 482 503	← 1812
	1.8	05.09-12.10	104	STB	1 987 482 504	↔ 1460
				05.09-12.11	104	4SB,TW
					1 987 482 508	→ 1803
		05.09→	104	STB	1 987 482 506	↔ 206
		01.12→	104	4SB	1 987 482 503	← 1812
		01.13-06.13	104	4SB	1 987 482 507	← 1810
					1 987 482 508	→ 1803
2.0 CDI	05.09-12.10	110	STB	1 987 482 504	↔ 1460	
			05.09-12.11	110	STB	1 987 482 506
	10.10-12.10	120	STB	1 987 482 504	↔ 1460	
			10.10-12.11	120	4SB,TW	1 987 482 507
					1 987 482 508	→ 1803
		10.10→	120	STB	1 987 482 506	↔ 206
		01.11-12.11	110	4SB	1 987 482 507	← 1810
1 987 482 508					→ 1803	
	01.12→	120	4SB	1 987 482 503	← 1812	
	01.13-06.13	120	4SB	1 987 482 507	← 1810	
				1 987 482 508	→ 1803	

**Cruze Station Wagon [J308]**

	1.4 Turbo	07.12-06.13	103		1 987 482 507	← 1810
					1 987 482 508	→ 1803
	1.6	07.12-12.13	88-91		1 987 482 507	← 1810
					1 987 482 508	→ 1803
	1.7 CDI	07.12-06.13	96		1 987 482 507	← 1810
					1 987 482 508	→ 1803
	1.8	07.12-06.13	104		1 987 482 507	← 1810
					1 987 482 508	→ 1803



		S							
	◀ CHEVROLET Cruze Station Wagon [J308]								
	2.0 CDI		07.12-06.13	120			1987 482 507	← 1810	
							1987 482 508	→ 1803	
<b>Epica [V250]</b>									
	2.0, CDRi		06.06-12.11	105/110					F 026 A06 221 <sup>7</sup>
	2.5		06.06-12.11	115					F 026 A06 221 <sup>7</sup>
<b>Evanda [V200]</b>									
	2.0 i		02.03-09.06	96					F 026 A06 221 <sup>7</sup>
<b>Ipanema</b>									
	1.8 EFI		03.91-12.97	72,8			0986 AB8 417	→	
							0986 AB8 418	←	
						BRB,	0986 AB8 411	→	
						BSY	0986 AB8 412	←	
<b>Kalos Hatchback [T200]</b>									
	1.2		02.05-04.08	53					F 026 A06 210 <sup>7</sup>
	1.4		02.05-04.08	61/69					F 026 A06 210 <sup>7</sup>
	1.2		02.05-04.08	53			0986 475 939	↔ 19,05	
	1.4		02.05-04.08	61/69			0986 475 939	↔ 19,05	
	1.2		02.05-04.08	53			1987 482 082	← 1384	
							1987 482 083	→ 1396	
	1.4		02.05-04.08	61/69			1987 482 082	← 1384	
							1987 482 083	→ 1396	
<b>Kalos [T200]</b>									
	1.2		02.05-08.06	53					F 026 A06 210 <sup>7</sup>
	1.4		02.05-08.06	61/69					F 026 A06 210 <sup>7</sup>
	1.2		02.05-08.06	53			0986 475 939	↔ 19,05	
	1.4		02.05-08.06	61/69			0986 475 939	↔ 19,05	
	1.2		02.05-08.06	53			1987 482 082	← 1384	
							1987 482 083	→ 1396	
	1.4		02.05-08.06	61/69			1987 482 082	← 1384	
							1987 482 083	→ 1396	



		S				?			
<b>Lacetti [J200]</b>									
	1.8	02.05-08.05	90						F 026 A06 099 <sup>7</sup>
	1.4	02.05-04.13	70				1 987 482 353	← 1615	
							1 987 482 354	→ 1567	
	1.6	02.05-04.13	80				1 987 482 353	← 1615	
							1 987 482 354	→ 1567	
	1.8	02.05-04.13	89/90				1 987 482 353	← 1615	
							1 987 482 354	→ 1567	
	2.0D	09.06-04.13	89				1 987 482 353	← 1615	
							1 987 482 354	→ 1567	
	1.4	02.05-12.06	70		LAB		0 265 006 752 <sup>3</sup>		
		02.05-04.13	70		RAB		0 265 006 751 <sup>3</sup>		
	1.6	02.05-12.06	80		LAB		0 265 006 752 <sup>3</sup>		
		02.05-04.13	80		RAB		0 265 006 751 <sup>3</sup>		
	1.8	02.05-12.06	89/90		LAB		0 265 006 752 <sup>3</sup>		
		02.05-04.13	89/90		RAB		0 265 006 751 <sup>3</sup>		
	2.0D	09.06-12.06	89		LAB		0 265 006 752 <sup>3</sup>		
		09.06-04.13	89		RAB		0 265 006 751 <sup>3</sup>		
<b>Lanos</b>									
	1.6i	01.04→	78	Fg.-Nr. →447433			0 986 473 905	← 52	
							0 986 473 906	→ 52	
				Fg.-Nr. 447434→, →594051					F 026 A06 210 <sup>7</sup>
				Fg.-Nr. 594052→					F 026 A06 210 <sup>7</sup>
	1.5i	01.04→	63	Fg.-Nr. →447433			0 986 475 032	↔ 17,46	
				Fg.-Nr. 447434→			0 986 475 143	↔ 19,05	
	1.6i	01.04→	78	Fg.-Nr. →447433			0 986 475 143	↔ 19,05	
				Fg.-Nr. 447434→			0 986 475 890	↔ 17,46	
	1.5i	01.04→	63				1 987 477 717	→ 1587	
							1 987 477 920	← 1655	
	1.6i	01.04→	78				1 987 477 717	→ 1587	
							1 987 477 920	← 1655	
<b>Matiz [M200]</b>									
	0.8i	02.05-12.10	38				0 986 473 450	←	
							0 986 473 506	←	
							0 986 474 450	→	
							0 986 474 506	→	
	1.0i	02.05-12.10	48				0 986 473 450	←	
							0 986 473 506	←	
							0 986 474 450	→	
							0 986 474 506	→	



		S							
◀ CHEVROLET Matiz [M200]									
	0.8 i	02.05-12.10	38				0 986 475 889	↔ 17,5	
	1.0 i	02.05-12.10	48				0 986 475 889	↔ 17,5	
	0.8 i	02.05-12.10	38				1 987 477 718	↔ 2825	
	1.0 i	02.05-12.10	48				1 987 477 718	↔ 2825	
Niva									
	1.7 i	09.02→	58,5				0 986 475 795	↔ 20,6	
Niva [212300]									
	1.7 i	01.08→	58,5				0 986 475 795	↔ 20,6	
Niva [212360]									
	1.8 MT	09.04→	92				0 986 475 795	↔ 20,6	
Nubira [J200]									
	1.8 i	02.05-08.05	90						F 026 A06 099 <sup>7</sup>
	1.4 i	02.05-04.13	70				1 987 482 353	← 1615	
							1 987 482 354	→ 1567	
	1.6 i	02.05-04.13	80				1 987 482 354	← 1615	
							1 987 482 354	→ 1567	
	1.8 i	02.05-04.13	89/90				1 987 482 353	← 1615	
							1 987 482 354	→ 1567	
	2.0 D	09.06-04.13	89				1 987 482 353	← 1615	
							1 987 482 354	→ 1567	
	1.4 i	02.05-12.06	70		LAB		0 265 006 752 <sup>3</sup>		
		02.05-04.13	70		RAB		0 265 006 751 <sup>3</sup>		
	1.6 i	02.05-12.06	80		LAB		0 265 006 752 <sup>3</sup>		
		02.05-04.13	80		RAB		0 265 006 751 <sup>3</sup>		
	1.8 i	02.05-12.06	89/90		LAB		0 265 006 752 <sup>3</sup>		
		02.05-04.13	89/90		RAB		0 265 006 751 <sup>3</sup>		
	2.0 D	09.06-12.06	89		LAB		0 265 006 752 <sup>3</sup>		
		09.06-04.13	89		RAB		0 265 006 751 <sup>3</sup>		
Nubira Wagon [J200]									
	1.8 i	02.05-08.05	90						F 026 A06 099 <sup>7</sup>



		S							
	1.6i	02.05-04.13	80			1 987 482 353	← 1615		
						1 987 482 354	→ 1567		
	1.8i	02.05-04.13	89/90			1 987 482 353	← 1615		
						1 987 482 354	→ 1567		
	2.0D	09.06-04.13	89			1 987 482 353	← 1615		
						1 987 482 354	→ 1567		
	1.6i	02.05-12.06	80		LAB	0 265 006 752 <sup>3</sup>			
		02.05-04.13	80		RAB	0 265 006 751 <sup>3</sup>			
	1.8i	02.05-12.06	89/90		LAB	0 265 006 752 <sup>3</sup>			
		02.05-04.13	89/90		RAB	0 265 006 751 <sup>3</sup>			
	2.0D	09.06-12.06	89		LAB	0 265 006 752 <sup>3</sup>			
		09.06-04.13	89		RAB	0 265 006 751 <sup>3</sup>			
<b>Optra Hatchback [J200]</b>									
	1.6	09.02-08.14	80			F 026 A06 710	↔		
	1.8	01.03-12.07	90			F 026 A06 710	↔		
	1.6	09.02-08.14	80	Fg.-Nr. 086405→	4SB	1 987 482 353	← 1615		
						1 987 482 354	→ 1567		
	1.8	01.03-12.07	90	Fg.-Nr. 086405→	4SB	1 987 482 353	← 1615		
						1 987 482 354	→ 1567		
	1.6	09.02-12.06	80		LAB	0 265 006 752 <sup>3</sup>			
		09.02-08.14	80		RAB	0 265 006 751 <sup>3</sup>			
	1.8	01.03-12.06	90		LAB	0 265 006 752 <sup>3</sup>			
		01.03-12.07	90		RAB	0 265 006 751 <sup>3</sup>			
<b>Rezzo [U100]</b>									
	1.6i	02.05-05.09	74-79						F 026 A06 221 <sup>7</sup>
	2.0i	02.05-05.09	88-90						F 026 A06 221 <sup>7</sup>
<b>Sens [TF698]</b>									
	1.3Si	01.02→	51,5	Fg.-Nr. →447433		0 986 475 032	↔ 17,46		
				Fg.-Nr. 447434→		0 986 475 143	↔ 19,05		
	1.3Si	01.02→	51,5			1 987 477 717	→ 1587		
						1 987 477 920	← 1655		
<b>Serie D</b>									
	10	01.92-12.94	57			0 986 AB8 450	←		
						0 986 AB8 451	→		
	20 Turbo	03.92-08.97	88			0 986 AB8 450	←		
						0 986 AB8 451	→		





		S							
◀ CHEVROLET									
<b>Spark</b>									
	0.8 i	10.03-09.09	37,5				0986 473 450		←
							0986 473 506		←
							0986 474 450		→
							0986 474 506		→
	1.0 i	06.04-09.13	47				0986 473 450		←
							0986 473 506		←
							0986 474 450		→
							0986 474 506		→
	0.8 i	10.03-09.09	37,5				1987 477 718		2825
	1.0 i	06.04-09.13	47				1987 477 718		2825
<b>Spark [M200]</b>									
	0.8 i	02.05-12.10	38				0986 473 450		←
							0986 473 506		←
							0986 474 450		→
							0986 474 506		→
	1.0 i	02.05-12.10	48				0986 473 450		←
							0986 473 506		←
							0986 474 450		→
							0986 474 506		→
	0.8 i	02.05-12.10	38				0986 475 889		↔ 17,5
	1.0 i	02.05-12.10	48				0986 475 889		↔ 17,5
	0.8 i	02.05-12.10	38				1987 477 718		↔ 2825
	1.0 i	02.05-12.10	48				1987 477 718		↔ 2825
<b>Spark [M300]</b>									
	1.0 i	04.12→	50				0986 475 890		↔ 17,46
	1.2 i	04.12→	60				0986 475 890		↔ 17,46
	1.0 i	12.09-06.10	50				1987 482 522		← 1403
							1987 482 523		→ 1445
		01.11-09.11	50				1987 482 522		← 1403
							1987 482 523		→ 1445
	1.2 i	12.09-06.10	60				1987 482 522		← 1403
							1987 482 523		→ 1445
		01.11-09.11	60				1987 482 522		← 1403
							1987 482 523		→ 1445
<b>S10</b>									
	2.2 EFI	03.95-10.97	83	Fg.-Nr. →930666			0986 AB8 495		←
							0986 AB8 496		→
		11.97-10.98	83	Fg.-Nr. 930667→			0986 AB8 452		←
							0986 AB8 453		→



		<b>S</b>							
2.5 D 4x4		10.95-10.97	74	Fg.-Nr. →930666		0 986 <b>AB8 495</b>	←		
		11.97-01.00	74	Fg.-Nr. 930667→		0 986 <b>AB8 496</b>	→		
						0 986 <b>AB8 452</b>	←		
						0 986 <b>AB8 453</b>	→		
4.3 V6 MPFI		08.96-10.97	132	Fg.-Nr. →930666		0 986 <b>AB8 495</b>	←		
		11.97-10.03	132	Fg.-Nr. 930667→		0 986 <b>AB8 496</b>	→		
						0 986 <b>AB8 452</b>	←		
						0 986 <b>AB8 453</b>	→		

**Tavera**

	2.5 D	05.04→	59			0 986 <b>AB8 125</b>	↔ 22,23		
--	-------	--------	----	--	--	----------------------	---------	--	--

**CHRYSLER**

**Concorde [LH]**

	2.7 i 24V	01.98-08.04	149	Fg.-Nr. 16 ZOLL BREMESEN→		0 986 <b>473 194</b>	← 60		
						0 986 <b>474 194</b>	→ 60		
	3.2 i 24V	01.98-08.01	168	Fg.-Nr. 16 ZOLL BREMESEN→		0 986 <b>473 194</b>	← 60		
						0 986 <b>474 194</b>	→ 60		
	3.5 i	01.98-12.04	160	Fg.-Nr. 16 ZOLL BREMESEN→		0 986 <b>473 194</b>	← 60		
						0 986 <b>474 194</b>	→ 60		

**Intrepid [LH]**

	2.7	01.98-12.99	149	Fg.-Nr. 16" ZOLL→	TW	0 986 <b>473 194</b>	← 60		
						0 986 <b>474 194</b>	→ 60		
	3.2	01.98-12.99	168	Fg.-Nr. 16" ZOLL→	TW	0 986 <b>473 194</b>	← 60		
						0 986 <b>474 194</b>	→ 60		

**LHS [LH]**

	3.5 i 24V	09.97-08.01	189			0 986 <b>473 194</b>	← 60		
						0 986 <b>474 194</b>	→ 60		

**PT Cruiser Cabrio [PT]**

	2.0	09.00-12.05	100-104		STB	0 986 <b>134 309</b>	← 57		
						0 986 <b>135 309</b>	→ 57		
	2.4	01.04-12.05	105-112		STB	0 986 <b>134 309</b>	← 57		
						0 986 <b>135 309</b>	→ 57		
		01.07-12.10	105-112		STB	0 986 <b>134 309</b>	← 57		
						0 986 <b>135 309</b>	→ 57		
	2.4 Turbo	01.03-12.05	164		STB	0 986 <b>134 309</b>	← 57		
						0 986 <b>135 309</b>	→ 57		
		01.07-12.09	164		STB	0 986 <b>134 309</b>	← 57		
						0 986 <b>135 309</b>	→ 57		

**PT Cruiser [PT]**

	1.6	10.02-12.05	85		STB	0 986 <b>134 309</b>	← 57		
						0 986 <b>135 309</b>	→ 57		



		S							
	<b>◀ CHRYSLER PT Cruiser [PT]</b>								
	1.6	01.07-12.07	85			STB	0986 134 309		← 57
							0986 135 309		→ 57
	2.0	06.00-12.05	100-104			STB	0986 134 309		← 57
							0986 135 309		→ 57
	2.2 CRD	09.02-12.05	89-112			STB	0986 134 309		← 57
							0986 135 309		→ 57
		01.07-12.09	110			STB	0986 134 309		← 57
							0986 135 309		→ 57
	2.4	06.00-12.05	105-112			STB	0986 134 309		← 57
							0986 135 309		→ 57
		01.07-12.10	105-112			STB	0986 134 309		← 57
							0986 135 309		→ 57
		09.08-08.10	112			STB	0986 134 309		← 57
							0986 135 309		→ 57
	2.4 Turbo	09.02-12.05	164			STB	0986 134 309		← 57
							0986 135 309		→ 57
		01.07-12.09	164			STB	0986 134 309		← 57
							0986 135 309		→ 57
<b>Sebring Convertible [JR]</b>									
	2.7	09.00-09.09	149				F 026 A09 607		↔
<b>Sebring Convertible [JS]</b>									
	2.0, CRD	09.06→	103/115				F 026 A09 607		↔
	2.4	09.06→	129				F 026 A09 607		↔
	2.7	09.06-08.10	141				F 026 A09 607		↔
	3.5	09.06→	175				F 026 A09 607		↔
<b>Sebring [JS]</b>									
	2.0, CRD	09.06→	103/115				F 026 A09 607		↔
	2.4	09.06→	129				F 026 A09 607		↔
	2.7	09.06→	141				F 026 A09 607		↔
	3.5	09.06→	175				F 026 A09 607		↔
<b>Voyager [GS]</b>									
	2.0 i	08.96-12.00	98			4SB,TW	0986 473 194		← 60
							0986 474 194		→ 60
	2.4	08.96-12.00	110			4SB,TW	0986 473 194		← 60
							0986 474 194		→ 60
	2.5 TD	01.95-12.00	85			4SB,TW	0986 473 194		← 60
							0986 474 194		→ 60
	3.3 i	01.95-12.99	116			4SB,TW	0986 473 194		← 60
							0986 474 194		→ 60
	3.8 i AWD	01.97-12.00	122/131			4SB,TW	0986 473 194		← 60
							0986 474 194		→ 60
	2.0 i	08.96-12.00	98				0986 475 878		↔ 19,05
	2.4	08.96-12.00	110				0986 475 878		↔ 19,05
	2.5 TD	01.95-12.00	85				0986 475 878		↔ 19,05
	3.3 i	01.95-12.99	116				0986 475 878		↔ 19,05
	3.8 i AWD	01.97-12.00	122/131				0986 475 878		↔ 19,05



**Voyager [NS]**

	2.4i	01.96-12.00	110			0 986 473 194		← 60
						0 986 474 194		→ 60
	3.0	01.96-12.00	112			0 986 473 194		← 60
						0 986 474 194		→ 60
	3.3 FFV	01.96-12.00	116			0 986 473 194		← 60
						0 986 474 194		→ 60
	3.8i	09.94-12.00	122/131			0 986 473 194		← 60
	3.8i AWD					0 986 474 194		→ 60

	2.4i	01.96-12.00	110			F 026 002 344		↔ 20,64
	3.0	01.96-12.00	112			F 026 002 344		↔ 20,64
	3.3 FFV	01.96-12.00	116			F 026 002 344		↔ 20,64
	3.8i, iAWD	09.94-12.00	122/131			F 026 002 344		↔ 20,64

**Voyager [RS]**

	2.4	08.00-08.03	108			F 026 002 344		↔ 20,64
	3.3	09.99-08.08	128-134			F 026 002 344		↔ 20,64
	3.8i	02.02-12.07	160			F 026 002 344		↔ 20,64
	3.8i AWD	02.02-12.07	160			F 026 002 344		↔ 20,64

**300M [LH]**

	2.7	06.98-12.04	150			0 986 473 194		← 60
						0 986 474 194		→ 60
	3.5	09.98-08.04	185			0 986 473 194		← 60
						0 986 474 194		→ 60

**CITROEN**

**AX**

	Electrique	09.94-12.98	11-20			0 986 471 885		← 45
						0 986 473 885		
						0 986 471 886		→ 45
						0 986 473 886		
	1.0i	07.92-12.98	31-33/37		ATE	0 986 471 885		← 45
						0 986 473 885		
						0 986 471 886		→ 45
	1.1i	06.92-06.98	44		ATE	0 986 471 885		← 45
						0 986 473 885		
						0 986 471 886		→ 45
	1.4D	08.91-12.97	37-39		ATE	0 986 471 885		← 45
						0 986 473 885		
						0 986 471 886		→ 45
					Org.-Nr. 5278→	BSY	0 204 102 289	← 48
							0 986 473 103	
							0 204 102 290	→ 48
							0 986 474 103	
	1.4i	06.88-12.98	55-58		ATE	0 986 471 885		← 45
						0 986 473 885		
						0 986 471 886		→ 45



		S								
	<b>◀ CITROEN AX</b>									
	1.4 i	06.90-12.96	55-58	Org.-Nr. 5278→	BSY	0 204 102 289	← 48	0 204 100 062 <sup>8</sup>		
						0 986 473 103		0 204 104 039 <sup>7</sup>		
		01.93-12.96	55	Org.-Nr. 5278→	BSY	0 204 102 290	→ 48	0 204 100 062 <sup>8</sup>		
						0 986 474 103				
						0 204 102 289	← 48	0 204 100 062 <sup>8</sup>		
						0 986 473 103		0 204 104 039 <sup>7</sup>		
1.5 D	08.94-12.97	40-41/ 42-43	Org.-Nr. 5278→	BSY	0 204 102 290	→ 48	0 204 100 062 <sup>8</sup>			
					0 986 474 103					
					0 204 102 289	← 48	0 204 100 062 <sup>8</sup>			
					0 986 473 103		0 204 104 039 <sup>7</sup>			
	<b>Electrique</b>		09.94-12.98	11-20			F 026 002 128	↔ 19,05		
	1.0 i	ABO	07.92-12.98	31-33/37		F 026 002 206	← 19			
						F 026 002 207	→ 19			
	1.1 i	ABO	06.92-06.98	44		BKR	F 026 002 128	↔ 19,05		
						AA	F 026 002 180	↔ 20,6		
						F 026 002 206	← 19			
						F 026 002 207	→ 19			
	1.4 D	ABS	06.92-06.98	44		BKR	F 026 002 128	↔ 19,05		
						AA	F 026 002 180	↔ 20,6		
	1.4 i	ABO	06.88-12.98	37-39/55-58/ 66/69-74		AA	F 026 002 131	← 19		
						F 026 002 132	→ 19			
	1.4 i	ABO	06.88-12.98	37-39/ 55-58		F 026 002 206	← 19			
						F 026 002 207	→ 19			
						BKR	F 026 002 128	↔ 19,05		
						AA	F 026 002 180	↔ 20,6		
	1.4 i	ABS	06.88-12.98	37-39/55-58/66/69-74		AA	F 026 002 180	↔ 20,6		
						F 026 002 222	← 19			
	1.5 D	ABO	05.91-12.96	66/69-74		AA	F 026 002 222	← 19		
						F 026 002 223	→ 19			
		08.94-12.97	40-41/ 42-43			AA	F 026 002 131	← 19		
F 026 002 132						→ 19				
F 026 002 206						← 19				
F 026 002 207						→ 19				
08.94-12.97	ABO	08.94-12.97	40-41/ 42-43		BKR	F 026 002 128	↔ 19,05			
					AA	F 026 002 180	↔ 20,6			
08.94-12.97	ABS	08.94-12.97	40-41/42-43		AA	F 026 002 180	↔ 20,6			
	1.0 i	07.92-12.98	31-33/37		AA	1 987 477 485	↔ 1395			
	1.1 i	06.92-06.98	44		AA	1 987 477 485	↔ 1395			
	1.4 D	08.91-12.97	37-39/55-58/66/69-74		AA	1 987 477 485	↔ 1395			
	1.4 D, i	06.88-12.98	37-39/55-58/66/69-74		AA	1 987 477 483	1420			
	1.4 i	06.88-12.98	37-39/55-58/66/69-74		AA	1 987 477 485	↔ 1395			
	1.5 D	08.94-12.97	40-41/ 42-43			AA	1 987 477 483	1420		
						AA	1 987 477 485	↔ 1395		
<b>Berlingo</b>										
	1.9 D	10.99→	51			0 986 475 836	↔ 22,2			
<b>Berlingo [B9]</b>										
	<b>Electric</b>	09.12→	42-49			0 986 135 258		→		
						0 986 135 258		→		
	1.6, BlueHDi, HDi, VTi, 16V	05.08→	55-66/68/72/80/82/84/88							

		S							
	<b>Electric</b>	09.12→	42-49				0 986 <b>134 332</b>		← 38
							0 986 <b>135 332</b>		→ 38
	<b>1.6, BlueHDi, HDi, VTi, 16V</b>	05.08→	55-66/68/72/80/82/84/88				0 986 <b>134 332</b>		← 38
							0 986 <b>135 332</b>		→ 38
	<b>Electric</b>	09.12→	42-49				1 987 <b>482 276</b>		↔ 2402
	<b>1.6</b>	05.08-11.11	55-66/68/72/80/82/84/88				1 987 <b>482 276</b>		↔ 2402
	<b>1.6 BlueHDi</b>	12.14→	55-66/68/72/80/82/84/88				1 987 <b>482 276</b>		↔ 2402
	<b>1.6 HDi</b>	05.08→	55-66/68/72/80/82/84/88				1 987 <b>482 276</b>		↔ 2402
	<b>1.6 VTi</b>	11.09→	55-66/68/72/80/82/84/88				1 987 <b>482 276</b>		↔ 2402
	<b>1.6 16V</b>	05.08-11.11	55-66/68/72/80/82/84/88				1 987 <b>482 276</b>		↔ 2402
	<b>Electric</b>	09.12→	42-49				0 265 <b>007 788</b> <sup>3</sup>		
	<b>1.6, HDi, VTi, 16V</b>	05.08→	55-66/68/72/80/82/84				0 265 <b>007 788</b> <sup>3</sup>		
							0 265 <b>007 789</b> <sup>4</sup>		
	<b>1.6 BlueHDi</b>	12.14-11.15	88	Org.-Nr. →14237			0 265 <b>007 788</b> <sup>3</sup>		
		03.15-11.15	55	Org.-Nr. →14237			0 265 <b>007 788</b> <sup>3</sup>		
							0 265 <b>007 789</b> <sup>4</sup>		
	<b>1.6 HDi</b>	05.08→	55				0 265 <b>007 788</b> <sup>3</sup>		
							0 265 <b>007 789</b> <sup>4</sup>		
	<b>1.6 VTi</b>	11.09→	88				0 265 <b>007 788</b> <sup>3</sup>		
							0 265 <b>007 789</b> <sup>4</sup>		
<b>Berlingo [M49]</b>									
	<b>Electricque</b>	10.98-11.02	24			INB BO	0 204 <b>004 451</b>		← 54
							0 204 <b>103 971</b>		
							0 204 <b>004 452</b>		→ 54
						GIR	0 986 <b>473 026</b>		← 54
							0 986 <b>474 026</b>		→ 54
						INB	0 986 <b>473 025</b>		← 54
							0 986 <b>474 025</b>		→ 54
	<b>1.1i</b>	07.96-11.02	44				0 986 <b>473 025</b>		← 54
							0 986 <b>474 025</b>		→ 54
	<b>1.4</b>	07.96-11.02	51/55				0 986 <b>473 025</b>		← 54
	<b>1.4i</b>						0 986 <b>474 025</b>		→ 54
	<b>1.6i 16V</b>	06.00-11.02	80			INB BO	0 204 <b>004 451</b>		← 54
							0 204 <b>103 971</b>		
							0 204 <b>004 452</b>		→ 54
						GIR	0 986 <b>473 026</b>		← 54
							0 986 <b>474 026</b>		→ 54
						INB	0 986 <b>473 025</b>		← 54
							0 986 <b>474 025</b>		→ 54
	<b>1.8 D</b>	07.96-11.02	43-44/66			INB BO	0 204 <b>004 451</b>		← 54
	<b>1.8i</b>						0 204 <b>103 971</b>		
							0 204 <b>004 452</b>		→ 54
						GIR	0 986 <b>473 026</b>		← 54
							0 986 <b>474 026</b>		→ 54
						INB	0 986 <b>473 025</b>		← 54
							0 986 <b>474 025</b>		→ 54
	<b>1.9 D</b>	07.96-11.02	50-51			INB BO	0 204 <b>004 451</b>		← 54
							0 204 <b>103 971</b>		
							0 204 <b>004 452</b>		→ 54
						GIR	0 986 <b>473 026</b>		← 54
							0 986 <b>474 026</b>		→ 54
						INB	0 986 <b>473 025</b>		← 54
							0 986 <b>474 025</b>		→ 54



		S							
	◀ CITROEN Berlingo [M49]								
1.9D		07.98-11.02	52				BO	0 204 004 451	← 54
								0 204 103 971	
								0 204 004 452	→ 54
							GIR	0 986 473 026	← 54
								0 986 474 026	→ 54
2.0 HDi		12.99-11.02	66				BO	0 204 004 451	← 54
								0 204 103 971	
								0 204 004 452	→ 54
							GIR	0 986 473 026	← 54
								0 986 474 026	→ 54
	<b>Electrique</b>	10.98-11.02	24					0 986 475 836	↔ 22,2
	1.1 i	07.96-11.02	44					0 986 475 836	↔ 22,2
	1.4, i	07.96-11.02	51/55					0 986 475 836	↔ 22,2
	1.6 i 16V	06.00-11.02	80					0 986 475 836	↔ 22,2
	1.8 D, i	07.96-11.02	43-44/66					0 986 475 836	↔ 22,2
	1.9 D	07.96-11.02	50-51/52					0 986 475 836	↔ 22,2
	2.0 HDi	12.99-11.02	66					0 986 475 836	↔ 22,2
	1.1 i	07.96-11.99	44	Org.-Nr. →8393				1 987 477 576	← 1745
								1 987 477 577	→ 1818
		12.99-11.02	44	Org.-Nr. 8394→				1 987 477 576	← 1745
								1 987 477 595	→ 1850
		06.00-11.02	44					1 987 477 576	← 1745
								1 987 477 595	→ 1850
	1.4	10.96-11.99	51	Org.-Nr. →8393				1 987 477 576	← 1745
								1 987 477 577	→ 1818
		12.99-11.02	51	Org.-Nr. 8394→				1 987 477 576	← 1745
								1 987 477 595	→ 1850
	1.4 i	07.96-11.99	55	Org.-Nr. →8393				1 987 477 577	→ 1818
		07.96-11.02	55					1 987 477 576	← 1745
								1 987 477 595	→ 1850
	1.6 i 16V	06.00-11.02	80					1 987 477 576	← 1745
								1 987 477 595	→ 1850
	1.8 D	07.96-11.99	43-44/66	Org.-Nr. →8393				1 987 477 576	← 1745
	1.8 i							1 987 477 577	→ 1818
		12.99-11.02	43-44/66	Org.-Nr. 8394→				1 987 477 576	← 1745
								1 987 477 595	→ 1850
	1.9 D	07.96-11.99	50-51	Org.-Nr. →8393				1 987 477 576	← 1745
								1 987 477 577	→ 1818
		07.98-11.99	52	Org.-Nr. →8393				1 987 477 576	← 1745
								1 987 477 577	→ 1818
		12.99-11.02	50-51	Org.-Nr. 8394→				1 987 477 576	← 1745
								1 987 477 595	→ 1850
			52	Org.-Nr. 8394→				1 987 477 576	← 1745
								1 987 477 595	→ 1850
		09.00-11.02	52					1 987 477 576	← 1745
								1 987 477 595	→ 1850
	2.0 HDi	12.99-11.02	66					1 987 477 576	← 1745
								1 987 477 595	→ 1850
	<b>Electrique</b>	10.98-05.01	24	Org.-Nr. →8938				0 265 006 209 <sup>4</sup>	
		10.98-11.02	24					0 265 006 200 <sup>3</sup>	
		06.01-11.02	24	Org.-Nr. 8939→				0 265 006 659 <sup>4</sup>	
	1.1 i	07.96-05.01	44	Org.-Nr. →8938				0 265 006 209 <sup>4</sup>	
		07.96-11.02	44					0 265 006 200 <sup>3</sup>	
		06.01-11.02	44	Org.-Nr. 8939→				0 265 006 659 <sup>4</sup>	



<b>1.4</b>	07.96-05.01	51/55	Org.-Nr. →8938	0 265 006 209 <sup>4</sup>
<b>1.4i</b>	07.96-11.02	51/55		0 265 006 200 <sup>3</sup>
	06.01-11.02	51/55	Org.-Nr. 8939→	0 265 006 659 <sup>4</sup>
<b>1.6 i 16V</b>	06.00-05.01	80	Org.-Nr. →8938	0 265 006 209 <sup>4</sup>
	06.00-11.02	80		0 265 006 200 <sup>3</sup>
	06.01-11.02	80	Org.-Nr. 8939→	0 265 006 659 <sup>4</sup>
<b>1.8 D</b>	07.96-05.01	43-44/66	Org.-Nr. →8938	0 265 006 209 <sup>4</sup>
<b>1.8 i</b>	07.96-11.02	43-44/66		0 265 006 200 <sup>3</sup>
	06.01-11.02	43-44/66	Org.-Nr. 8939→	0 265 006 659 <sup>4</sup>
<b>1.9 D</b>	07.96-05.01	50-51/52	Org.-Nr. →8938	0 265 006 209 <sup>4</sup>
	07.96-11.02	50-51/52		0 265 006 200 <sup>3</sup>
	06.01-11.02	50-51/52	Org.-Nr. 8939→	0 265 006 659 <sup>4</sup>
<b>2.0 HDi</b>	12.99-05.01	66	Org.-Nr. →8938	0 265 006 209 <sup>4</sup>
	12.99-11.02	66		0 265 006 200 <sup>3</sup>
	06.01-11.02	66	Org.-Nr. 8939→	0 265 006 659 <sup>4</sup>

**Berlingo [M59]**



	<b>Electrique</b>	11.02-04.08	28	0 204 004 451	← 54
				0 204 103 971	↻
				0 204 004 452	→ 54
	<b>1.1 i</b>	11.02-04.08	44	0 204 004 451	← 54
				0 204 103 971	↻
				0 204 004 452	→ 54
	<b>1.4 i</b>	11.02-03.10	55	0 204 004 451	← 54
				0 204 103 971	↻
				0 204 004 452	→ 54
	<b>1.6 HDi</b>	07.05-10.11	55	0 204 004 451	← 54
				0 204 103 971	↻
				0 204 004 452	→ 54
	<b>1.6 HDi</b>	MFD 11.02-04.08	66/80	0 204 102 974	→ 54
	<b>1.6 i 16V</b>	OFD 11.02-04.08	66/80	0 204 103 974	↻
				0 204 004 451	← 54
				0 204 103 971	↻
				0 204 004 452	→ 54
	<b>1.9 D</b>	11.02-04.08	52	0 204 004 451	← 54
				0 204 103 971	↻
				0 204 004 452	→ 54
	<b>2.0 HDi</b>	MFD 11.02-04.08	66	0 204 102 974	→ 54
		OFD 11.02-04.08	66	0 204 103 974	↻
				0 204 004 451	← 54
				0 204 103 971	↻
				0 204 004 452	→ 54







































	<b>Electrique</b>	11.02-04.08	28	0 986 475 836	↔ 22,2
	<b>1.1 i</b>	11.02-04.08	44	0 986 475 836	↔ 22,2
	<b>1.4 i</b>	11.02-03.10	55	0 986 475 836	↔ 22,2
	<b>1.6 HDi, i 16V</b>	11.02-10.11	55/66/80	0 986 475 836	↔ 22,2
	<b>1.9 D</b>	11.02-04.08	52	0 986 475 836	↔ 22,2
	<b>2.0 HDi</b>	11.02-04.08	66	0 986 475 836	↔ 22,2

	<b>Electrique</b>	11.02-04.08	28	0 986 134 038	↻ ← 38
				0 986 135 038	↻ → 38
	<b>1.1 i</b>	11.02-04.08	44	0 986 134 038	↻ ← 38
				0 986 135 038	↻ → 38
	<b>1.4 i</b>	11.02-03.10	55	0 986 134 038	↻ ← 38
				0 986 135 038	↻ → 38
	<b>1.6 HDi</b>	11.02-10.11	55/66/80	0 986 134 038	↻ ← 38
	<b>1.6 i 16V</b>			0 986 135 038	↻ → 38





		S							
	◀ CITROEN Berlingo [M59]								
1.9 D	11.02-04.08	52					0986 134 038		← 38
							0986 135 038		→ 38
2.0 HDi	11.02-04.08	66					0986 134 038		← 38
							0986 135 038		→ 38
	<b>Electrique</b>	11.02-04.08	28			HTB	1987 477 576		← 1745
						SBR	1987 477 595		→ 1850
						SBR	1987 482 116		← 1820
						SBR	1987 482 117		→ 1922
1.1 i	11.02-04.08	44				HTB	1987 477 576		← 1745
						SBR	1987 477 595		→ 1850
						SBR	1987 482 116		← 1820
						SBR	1987 482 117		→ 1922
1.4 i	11.02-03.10	55				HTB	1987 477 576		← 1745
						SBR	1987 477 595		→ 1850
						SBR	1987 482 116		← 1820
						SBR	1987 482 117		→ 1922
1.6 HDi	11.02-10.11	55/66/80				HTB	1987 477 576		← 1745
1.6 i 16V						SBR	1987 477 595		→ 1850
						SBR	1987 482 116		← 1820
						SBR	1987 482 117		→ 1922
1.9 D	11.02-04.08	52				HTB	1987 477 576		← 1745
						SBR	1987 477 595		→ 1850
						SBR	1987 482 116		← 1820
						SBR	1987 482 117		→ 1922
2.0 HDi	11.02-04.08	66				HTB	1987 477 576		← 1745
						SBR	1987 477 595		→ 1850
						SBR	1987 482 116		← 1820
						SBR	1987 482 117		→ 1922
	<b>Electrique</b>	11.02-02.03	28	Org.-Nr. →9582			0265 006 659 <sup>4</sup>		
		11.02-11.04	28	Org.-Nr. →10220			0265 006 200 <sup>3</sup>		
		03.03-11.04	28	Org.-Nr. 9583→10220			0265 006 793 <sup>4</sup>		
		12.04-07.05	28	Org.-Nr. 10221→10478	RAB		0265 007 667 <sup>4</sup>		
		12.04-04.08	28	Org.-Nr. 10221→			0265 007 666 <sup>3</sup>		
					LAB		0265 007 668 <sup>4</sup>		
		08.05-04.08	28	Org.-Nr. 10479→	RAB		0265 007 883 <sup>4</sup>		
1.1 i	11.02-02.03	44	Org.-Nr. →9582				0265 006 659 <sup>4</sup>		
	11.02-11.04	44	Org.-Nr. →10220				0265 006 200 <sup>3</sup>		
	03.03-11.04	44	Org.-Nr. 9583→10220				0265 006 793 <sup>4</sup>		
	12.04-07.05	44	Org.-Nr. 10221→10478	RAB			0265 007 667 <sup>4</sup>		
	12.04-04.08	44	Org.-Nr. 10221→				0265 007 666 <sup>3</sup>		
					LAB		0265 007 668 <sup>4</sup>		
	08.05-04.08	44	Org.-Nr. 10479→	RAB			0265 007 883 <sup>4</sup>		
1.4 i	11.02-02.03	55	Org.-Nr. →9582				0265 006 659 <sup>4</sup>		
	11.02-11.04	55	Org.-Nr. →10220				0265 006 200 <sup>3</sup>		
	03.03-11.04	55	Org.-Nr. 9583→10220				0265 006 793 <sup>4</sup>		
	12.04-07.05	55	Org.-Nr. 10221→10478	RAB			0265 007 667 <sup>4</sup>		
	12.04-03.10	55	Org.-Nr. 10221→				0265 007 666 <sup>3</sup>		
					LAB		0265 007 668 <sup>4</sup>		
	08.05-03.10	55	Org.-Nr. 10479→	RAB			0265 007 883 <sup>4</sup>		
1.6 HDi	07.05-10.11	55/66					0265 007 666 <sup>3</sup>		
						LAB	0265 007 668 <sup>4</sup>		
	08.05-10.11	55/66				RAB	0265 007 883 <sup>4</sup>		
1.6 i 16V	11.02-02.03	80	Org.-Nr. →9582			HTB	0265 006 659 <sup>4</sup>		
	11.02-11.04	80	Org.-Nr. →10220			SBR	0265 006 200 <sup>3</sup>		
						SBR	0265 006 732 <sup>4</sup>		
	03.03-11.04	80	Org.-Nr. 9583→10220			HTB	0265 006 793 <sup>4</sup>		
	12.04-07.05	80	Org.-Nr. 10221→10478	RAB			0265 007 667 <sup>4</sup>		

		S							
<b>1.6i 16V</b>		12.04-04.08	80	Org.-Nr. 10221→			0 265 007 666 <sup>3</sup>		
					LAB		0 265 007 668 <sup>4</sup>		
		08.05-04.08	80	Org.-Nr. 10479→	RAB		0 265 007 883 <sup>4</sup>		
<b>1.9D</b>		11.02-02.03	52	Org.-Nr. →9582			0 265 006 659 <sup>4</sup>		
		11.02-11.04	52	Org.-Nr. →10220			0 265 006 200 <sup>3</sup>		
		03.03-11.04	52	Org.-Nr. 9583→10220			0 265 006 793 <sup>4</sup>		
		12.04-07.05	52	Org.-Nr. 10221→10478	RAB		0 265 007 667 <sup>4</sup>		
		12.04-04.08	52	Org.-Nr. 10221→			0 265 007 666 <sup>3</sup>		
					LAB		0 265 007 668 <sup>4</sup>		
		08.05-04.08	52	Org.-Nr. 10479→	RAB		0 265 007 883 <sup>4</sup>		
<b>2.0 HDi</b>		11.02-02.03	66	Org.-Nr. →9582	HTB		0 265 006 659 <sup>4</sup>		
		11.02-11.04	66	Org.-Nr. →10220			0 265 006 200 <sup>3</sup>		
					SBR		0 265 006 732 <sup>4</sup>		
		03.03-11.04	66	Org.-Nr. 9583→10220	HTB		0 265 006 793 <sup>4</sup>		
		12.04-07.05	66	Org.-Nr. 10221→10478	RAB		0 265 007 667 <sup>4</sup>		
		12.04-04.08	66	Org.-Nr. 10221→			0 265 007 666 <sup>3</sup>		
					LAB		0 265 007 668 <sup>4</sup>		
		08.05-04.08	66	Org.-Nr. 10479→	RAB		0 265 007 883 <sup>4</sup>		
<b>BX [X56]</b>									
									
	<b>14</b>	07.86-12.94	50				0 204 102 036	← 50	0 204 100 062 <sup>B</sup>
							0 204 103 036		0 204 104 040 <sup>7</sup>
							0 204 102 037	→ 50	0 204 100 062 <sup>B</sup>
							0 204 103 037		
	<b>15</b>	09.87-12.94	53				0 204 102 036	← 50	0 204 100 062 <sup>B</sup>
							0 204 103 036		0 204 104 040 <sup>7</sup>
							0 204 102 037	→ 50	0 204 100 062 <sup>B</sup>
							0 204 103 037		
	<b>16</b>	07.85-12.94	64/65/67/				0 204 102 036	← 50	0 204 100 062 <sup>B</sup>
	<b>16 i</b>		76				0 204 103 036		0 204 104 040 <sup>7</sup>
							0 204 102 037	→ 50	0 204 100 062 <sup>B</sup>
							0 204 103 037		
	<b>17 D Turbo</b>	02.88-12.94	66				0 204 102 036	← 50	0 204 100 062 <sup>B</sup>
							0 204 103 036		0 204 104 040 <sup>7</sup>
							0 204 102 037	→ 50	0 204 100 062 <sup>B</sup>
							0 204 103 037		
	<b>19 D</b>	03.86-12.94	47/51/				0 204 102 036	← 50	0 204 100 062 <sup>B</sup>
	<b>19 i</b>		75-77/80				0 204 103 036		0 204 104 040 <sup>7</sup>
							0 204 102 037	→ 50	0 204 100 062 <sup>B</sup>
							0 204 103 037		
									
	<b>14</b>	07.86-12.94	50				0 986 473 076	 ↔ 29,94	
							0 986 474 076		
	<b>15</b>	09.87-12.94	53				0 986 473 076	 ↔ 29,94	
							0 986 474 076		
	<b>16</b>	07.85-12.94	64/65/67/76				0 986 473 076	 ↔ 29,94	
							0 986 474 076		
	<b>16 i</b>	03.86-12.94	64/65/67/76				0 986 473 076	 ↔ 29,94	
							0 986 474 076		
	<b>17 D Turbo</b>	02.88-12.94	66				0 986 473 076	 ↔ 29,94	
							0 986 474 076		
	<b>19 D</b>	03.87-12.94	47/51/75-77/80				0 986 473 076	 ↔ 29,94	
							0 986 474 076		
	<b>19 i</b>	03.86-12.94	47/51/75-77/80				0 986 473 076	 ↔ 29,94	
							0 986 474 076		



			S							
◀ CITROEN BX [X56]										
	14	07.86-12.94	50					1987 477 077		1651
	15	09.87-12.94	53					1987 477 077		1651
	16, i	07.85-12.94	64/65/67/76					1987 477 077		1651
	17 D Turbo	02.88-12.94	66					1987 477 077		1651
	19 D, i	03.86-12.94	47/51/75-77/80					1987 477 077		1651
<b>C 15</b>										
	E 1.0	07.88-12.97	32					0986 471 672	← 48	
								0986 473 672		
								0986 472 672	→ 48	
								0986 474 672		
	E 1.1	07.88-12.96	44					0986 471 672	← 48	
	E 1.1 i							0986 473 672		
								0986 472 672	→ 48	
								0986 474 672		
	E 1.4	06.88-12.96	40-46/51	Org.-Nr. 4196→				0986 471 672	← 48	
								0986 473 672		
								0986 472 672	→ 48	
								0986 474 672		
	E 1.4	05.87-12.96	55-58					0986 471 672	← 48	
	E 1.4 i							0986 473 672		
								0986 472 672	→ 48	
							0986 474 672			
1.8 D	07.86-05.00	44					0986 471 672	← 48		
							0986 473 672			
							0986 472 672	→ 48		
							0986 474 672			
1.9 D	06.00-12.05	44-52					0 204 102 289	← 48	0 204 100 062 <sup>8</sup>	
							0986 473 103		0 204 104 039 <sup>7</sup>	
							0 204 102 290	→ 48	0 204 100 062 <sup>8</sup>	
							0986 474 103			
	E 1.0	07.88-12.97	32					F 026 002 080	↔ 22,2	
	E 1.1, i	07.88-12.96	44					F 026 002 080	↔ 22,2	
	E 1.4, i	05.87-12.96	40-46/51/55-58					F 026 002 080	↔ 22,2	
	1.8 D	07.86-05.00	44					F 026 002 080	↔ 22,2	
	1.9 D	06.00-12.05	44-52					F 026 002 080	↔ 22,2	
	E 1.0	07.88-12.97	32			ABM		1987 477 486		1780
	E 1.1, i	07.88-12.96	44			ABM		1987 477 486		1780
	E 1.4, i	05.87-12.96	40-46/51/55-58			ABM		1987 477 486		1780
	1.8 D	07.86-05.00	44			ABM		1987 477 486		1780
	1.9 D	06.00-12.05	44-52			ABM		1987 477 486		1780
<b>C 25</b>										
	E 1.8	01.83-03.94	49-51	Org.-Nr. 15548→		L03		0986 473 776		← 38
								0986 473 777		→ 38
	E 2.0	01.83-03.94	55-63	Org.-Nr. 15548→		L03		0986 473 776		← 38
								0986 473 777		→ 38
	1.9 D	07.87-03.94	51/60	Org.-Nr. 15548→		L03		0986 473 776		← 38
	1.9 D Turbo							0986 473 777		→ 38
	2.5 D	01.83-03.94	54-55/70	Org.-Nr. 15548→		L03		0986 473 776		← 38
2.5 D Turbo							0986 473 777		→ 38	

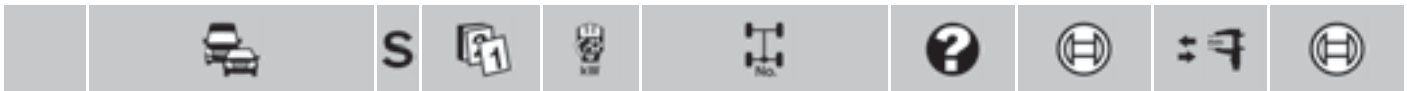

	<b>E 1.8</b>	11.81-03.94	49-51		L02	0 986 <b>475 612</b>	↔ 27	
		02.83-03.94	49-51	Org.-Nr. 73501→	L03	0 986 <b>475 420</b>	↔ 25,4	
	<b>E 2.0</b>	09.81-03.94	55-63		L02	0 986 <b>475 612</b>	↔ 27	
		02.83-03.94	55-63	Org.-Nr. 73501→	L03	0 986 <b>475 420</b>	↔ 25,4	
	<b>1.9 D</b>	07.87-03.94	51/60		L02	0 986 <b>475 612</b>	↔ 27	
	<b>1.9 D Turbo</b>			Org.-Nr. 73501→	L03	0 986 <b>475 420</b>	↔ 25,4	
	<b>2.5 D</b>	07.81-03.94	54-55/70		L02	0 986 <b>475 612</b>	↔ 27	
<b>2.5 D Turbo</b>	02.83-03.94	54-55/70	Org.-Nr. 73501→	L03	0 986 <b>475 420</b>	↔ 25,4		

	<b>E 1.8</b>	11.81-03.94	49-51		ABM, LLE	1 987 <b>477 417</b>	1608	
						1 987 <b>477 419</b>	2338	
					AA	1 987 <b>477 515</b>	↔ 2566	
	<b>E 2.0</b>	09.81-03.94	55-63		ABM, LLE	1 987 <b>477 417</b>	1608	
						1 987 <b>477 419</b>	2338	
					AA	1 987 <b>477 515</b>	↔ 2566	
	<b>1.9 D</b>	07.87-03.94	51/60		AA	1 987 <b>477 515</b>	↔ 2566	
	<b>1.9 D Turbo</b>	04.92-03.94	51/60		AA	1 987 <b>477 515</b>	↔ 2566	
	<b>1.9 D</b>	07.87-03.94	51/60		ABM, LLE	1 987 <b>477 417</b>	1608	
	<b>1.9 D Turbo</b>					1 987 <b>477 419</b>	2338	
	<b>2.5 D</b>	07.81-03.94	54-55/70		AA	1 987 <b>477 515</b>	↔ 2566	
	<b>2.5 D Turbo</b>	08.87-03.94	54-55/70		AA	1 987 <b>477 515</b>	↔ 2566	
	<b>2.5 D</b>	07.81-03.94	54-55/70		ABM, LLE	1 987 <b>477 417</b>	1608	
	<b>2.5 D Turbo</b>					1 987 <b>477 419</b>	2338	

**C-Crosser [I4]**

	<b>2.2 HDi 4x4</b>	09.07-01.13	115			1 987 <b>482 274</b>	← 1627	
						1 987 <b>482 275</b>	→ 1645	
	<b>2.4 4x4</b>	11.07-01.13	125			1 987 <b>482 274</b>	← 1627	
						1 987 <b>482 275</b>	→ 1645	

**C-Elysee**

	<b>1.2 E-VTi</b>	12.14→	60		INB	0 204 <b>004 451</b>	← 54	
						0 204 <b>103 971</b>	↻	
						0 204 <b>004 452</b>	→ 54	
	<b>1.6 BlueHdi</b>	04.15→	73		INB	0 204 <b>004 451</b>	← 54	
						0 204 <b>103 971</b>	↻	
						0 204 <b>004 452</b>	→ 54	
	<b>1.6 HDi</b>	09.12→	68			0 204 <b>004 451</b>	← 54	
						0 204 <b>103 971</b>	↻	
						0 204 <b>004 452</b>	→ 54	
	<b>1.6 VTi</b>	09.12→	85			0 204 <b>004 451</b>	← 54	
						0 204 <b>103 971</b>	↻	
						0 204 <b>004 452</b>	→ 54	

	<b>1.2 E-VTi</b>	ABO 09.12→	52/60			F 026 <b>002 234</b>	← 20,6	
	<b>1.2 VTi</b>					F 026 <b>002 235</b>	→ 20,6	
		ABS 09.12→	52/60			F 026 <b>002 028</b>	↔ 20,6	
	<b>1.6 BlueHdi</b>	ABO 09.12→	68/73/85			F 026 <b>002 234</b>	← 20,6	
	<b>1.6 HDi</b>					F 026 <b>002 235</b>	→ 20,6	
	<b>1.6 VTi</b>	ABS 09.12→	68/73/85			F 026 <b>002 028</b>	↔ 20,6	



		S				?			
◀ CITROEN C-Elysee									
	1.2 VTi	09.12-04.13	52	Org.-Nr. →13292			0 265 008 485 <sup>4</sup>		
	1.6 HDi, VTi	09.12-04.13	68/85	Org.-Nr. →13292			0 265 008 485 <sup>4</sup>		
<b>C1 [B0]</b>									
	1.0	06.05→	50				0 204 004 330 ← 48		
							0 986 134 093 → 48		
							0 204 004 331 ← 48		
							0 986 135 093 → 48		
	1.4 HDi	06.05→	40				0 204 004 330 ← 48		
							0 986 134 093 → 48		
							0 204 004 331 ← 48		
							0 986 135 093 → 48		
	1.0	06.05→	50				F 026 002 607 ↔ 17,46		
	1.4 HDi	06.05→	40				F 026 002 607 ↔ 17,46		
	1.0	06.05→	50				1 987 477 951 → 1478		
							1 987 477 952 ← 1487		
	1.4 HDi	06.05→	40				1 987 477 951 → 1478		
							1 987 477 952 ← 1487		
	1.0	06.05-08.10	50				0 265 007 687 <sup>3</sup>		
							0 265 007 688 <sup>4</sup>		
		09.10-02.12	50	Org.-Nr. →12872			0 265 007 687 <sup>3</sup>		
							0 265 007 688 <sup>4</sup>		
	1.4 HDi	06.05-02.12	40	Org.-Nr. →12872			0 265 007 687 <sup>3</sup>		
							0 265 007 688 <sup>4</sup>		
<b>C1 [B4]</b>									
	1.0	02.14→	50				0 204 004 330 ← 48		
							0 986 134 093 → 48		
							0 204 004 331 ← 48		
							0 986 135 093 → 48		
	1.2 VTi	02.14→	60				0 204 004 330 ← 48		
							0 986 134 093 → 48		
							0 204 004 331 ← 48		
							0 986 135 093 → 48		
<b>C2 [A6]</b>									
	1.1	09.03-12.09	44				0 986 473 107 ← 48		
							0 986 474 107 → 48		
	1.4	09.03-12.09	50/55				0 986 473 107 ← 48		
	1.4 HDi						0 986 474 107 → 48		
	1.4 16V	12.05-12.08	65				0 986 134 003 ← 54		
							0 986 135 003 → 54		
	1.6	09.03-12.09	80			BO	0 204 004 451 ← 54		
							0 204 103 971 → 54		
						LUC	0 986 134 003 ← 54		
							0 986 135 003 → 54		

		S							
		1.6 HDi	07.07-05.09	80			0 204 004 451	← 54	
							0 204 103 971	↻	
							0 204 004 452	→ 54	
		1.6 VTS	10.04-05.09	90			0 204 004 451	← 54	
							0 204 103 971	↻	
							0 204 004 452	→ 54	
		1.1	ABO 09.03-12.09	44			0 986 475 972	← 19,05	
							0 986 475 973	→ 19,05	
			ABS 09.03-12.09	44		BO	F 026 002 463	↔ 20,6	
						LUC	0 986 475 833	↔ 20,6	
		1.4	ABO 09.03-12.09	50/55			0 986 475 972	← 19,05	
		1.4 HDi					0 986 475 973	→ 19,05	
			ABS 09.03-12.09	50/55		BO	F 026 002 463	↔ 20,6	
						LUC	0 986 475 833	↔ 20,6	
		1.4 16V	12.05-12.08	65		BO	F 026 002 463	↔ 20,6	
						LUC	0 986 475 833	↔ 20,6	
		1.4 HDi	09.03-12.09	50			0 986 473 421	↻ ← 38	
							0 986 474 421	↻ → 38	
		1.6, HDi, VTS	09.03-12.09	80/90			0 986 473 421	↻ ← 38	
							0 986 474 421	↻ → 38	
		1.1	09.03-12.09	44			1 987 477 238	↔ 1610	
		1.4	09.03-12.09	50/55/65			1 987 477 238	↔ 1610	
		1.4 HDi	09.03-12.09	50/55/65			1 987 477 238	↔ 1610	
		1.4 16V	12.05-12.08	50/55/65			1 987 477 238	↔ 1610	
		1.6	09.03-12.09	80/90			1 987 477 239	↔ 1702	
		1.6 HDi	07.07-05.09	80/90			1 987 477 239	↔ 1702	
		1.6 VTS	10.04-05.09	80/90			1 987 477 239	↔ 1702	
		1.1	09.03-12.09	44			0 986 594 551 <sup>3</sup>		
							0 986 594 552 <sup>4</sup>		
		1.4, HDi, 16V	09.03-12.09	50/55/65			0 986 594 551 <sup>3</sup>		
							0 986 594 552 <sup>4</sup>		
		1.6, HDi, VTS	09.03-12.09	80/90			0 986 594 551 <sup>3</sup>		
							0 986 594 552 <sup>4</sup>		
<b>C3</b>									
		1.4 8V	07.03-07.12	54			0 986 473 107	↻ ← 48	
							0 986 474 107	↻ → 48	
		1.6 16V	05.03-07.12	81		LUC	0 986 134 003	↻ ← 54	
							0 986 135 003	↻ → 54	
		1.4 Hd	07.03-07.12	52		LUC	0 986 475 909	↔ 20,64	
		1.4 8V	ABO 07.03-07.12	54			0 986 475 907	← 19,05	
							0 986 475 908	→ 19,05	
			ABS 07.03-07.12	54		BO	F 026 002 463	↔ 20,6	
						LUC	0 986 475 833	↔ 20,6	
		1.6 16V	05.03-07.12	81		BO	F 026 002 463	↔ 20,6	
						LUC	0 986 475 833	↔ 20,6	
		1.6 16V	05.03-07.12	81			0 986 473 421	↻ ← 38	
							0 986 474 421	↻ → 38	





















		S							
◀ CITROEN C3									
	1.4 8V		07.03-07.12	54			0986 594 551 <sup>3</sup>		
							0986 594 552 <sup>4</sup>		
	1.6 16V		05.03-07.12	81			0986 594 551 <sup>3</sup>		
							0986 594 552 <sup>4</sup>		
<b>C3 [A8]</b>									
	1.1 i		01.02-08.05	44			0986 473 107		← 48
							0986 474 107		→ 48
	1.4 HDi		01.02-08.05	50/55			0986 473 107		← 48
	1.4 i						0986 474 107		→ 48
	1.4 HDi 16V		01.02-08.05	65/66			0986 134 003		← 54
	1.4 i 16V						0986 135 003		→ 54
	1.6 i		01.02-08.05	80			0986 134 003		← 54
							0986 135 003		→ 54
	1.1 i	ABO	01.02-08.05	44			0986 475 907		← 19,05
							0986 475 908		→ 19,05
		ABS	01.02-08.05	44			0986 475 909		↔ 20,64
	1.4 HDi	ABO	01.02-08.05	50/55			0986 475 907		← 19,05
	1.4 i						0986 475 908		→ 19,05
		ABS	01.02-08.05	50/55			0986 475 909		↔ 20,64
	1.4 i 16V		10.03-08.05	65		BO	F 026 002 463		↔ 20,6
					LUC	0986 475 909		↔ 20,64	
	1.4 HDi 16V		01.02-08.05	66			0986 473 421		← 38
							0986 474 421		→ 38
	1.6 i		01.02-08.05	80			0986 473 421		← 38
							0986 474 421		→ 38
	1.1 i		01.02-08.05	44			1987 477 599		↔ 1716
	1.4 HDi		01.02-08.05	50/55/65			1987 477 599		↔ 1716
	1.4 HDi 16V		01.02-08.05	66			1987 477 600		↔ 1812
	1.4 i		01.02-08.05	50/55/65			1987 477 599		↔ 1716
	1.4 i 16V		10.03-08.05	50/55/65			1987 477 599		↔ 1716
	1.6 i		01.02-08.05	80			1987 477 600		↔ 1812
	1.1 i		01.02-08.05	44			0986 594 551 <sup>3</sup>		
							0986 594 552 <sup>4</sup>		
	1.4 HDi, HDi 16V, i, i 16V		01.02-08.05	50/55/65/ 66			0986 594 551 <sup>3</sup>		
							0986 594 552 <sup>4</sup>		
	1.6 i		01.02-08.05	80			0986 594 551 <sup>3</sup>		
							0986 594 552 <sup>4</sup>		
<b>C3 [A31]</b>									
	1.1 i		09.05-09.09	44			0986 473 107		← 48
							0986 474 107		→ 48
	1.4 HDi		09.05-09.09	50/54			0986 473 107		← 48
	1.4 i						0986 474 107		→ 48
	1.4 i 16V		09.05-09.09	65		BO	0 204 004 451		← 54
							0 204 103 971		
							0 204 004 452		→ 54
					LUC	0986 134 003		← 54	
						0986 135 003		→ 54	

		S														
<b>1.6 HDi</b>		09.05-06.06	80	Org.-Nr. →10800			0 204 102 974	→ 54								
							0 204 103 974									
							09.05-12.09	66		BO	0 204 004 451	← 54				
											0 204 103 971					
											0 204 004 452	→ 54				
							LUC	0 986 134 003		← 54						
								0 986 135 003		→ 54						
07.06-05.09	80	Org.-Nr. 10801→		0 204 004 449	← 54											
				0 204 004 450	→ 54											
<b>1.6 i</b>		09.05-06.06	80	Org.-Nr. →10800	AG		0 204 102 974	→ 54								
							0 204 103 974									
							09.05-05.09	80		GS	BO	0 204 004 451	← 54			
												0 204 103 971				
												0 204 004 452	→ 54			
							LUC	0 986 134 003		← 54						
								0 986 135 003		→ 54						
07.06-05.09	80	Org.-Nr. 10801→	AG	0 204 004 449	← 54											
				0 204 004 450	→ 54											
<b>1.1 i</b>		09.05-09.09	44				0 986 475 972	← 19,05								
							0 986 475 973	→ 19,05								
							ABS	09.05-09.09	44	BO	F 026 002 463	↔ 20,6				
											LUC	0 986 475 833	↔ 20,6			
							1.4 HDi	09.05-09.09	50/54			0 986 475 972	← 19,05			
												0 986 475 973	→ 19,05			
							1.4 i	09.05-09.09	50/54	BO		F 026 002 463	↔ 20,6			
												LUC	0 986 475 833	↔ 20,6		
							1.4 i 16V	09.05-09.09	65	BO		F 026 002 463	↔ 20,6			
												LUC	0 986 475 833	↔ 20,6		
1.6 HDi	09.05-12.09	66	BO		F 026 002 463	↔ 20,6										
					LUC	0 986 475 833	↔ 20,6									
<b>1.6 HDi</b>		09.05-12.09	66/80				0 986 473 421		← 38							
							0 986 474 421		→ 38							
<b>1.1 i</b>		09.05-09.09	44				1 987 477 993	↔ 1693								
							1.4 HDi	09.05-09.09	50/54/65	1 987 477 993	↔ 1693					
							1.4 i	09.05-09.09	50/54/65	1 987 477 993	↔ 1693					
							1.4 i 16V	09.05-09.09	50/54/65	1 987 477 993	↔ 1693					
							1.6 HDi	09.05-05.09	80			1 987 477 993	↔ 1693			
												09.05-12.09	66	SBR	1 987 482 112	↔ 1790
										STB	1 987 477 993	↔ 1693				
							1.6 i	09.05-05.09	80			1 987 482 112	↔ 1790			
							<b>1.1 i</b>		09.05-09.09	44				0 986 594 551 <sup>3</sup>		
														0 986 594 552 <sup>4</sup>		
1.4 HDi, i, i 16V	09.05-09.09	50/54/65			0 986 594 551 <sup>3</sup>											
					0 986 594 552 <sup>4</sup>											
1.6 HDi	09.05-12.09	66/80			0 986 594 551 <sup>3</sup>											
1.6 i					0 986 594 552 <sup>4</sup>											
<b>C3 [A51]</b>																
<b>1.0 VTi</b>		09.12→	50				0 204 004 451	← 54								
							0 204 103 971									
							0 204 004 452	→ 54								
									0 204 104 359 <sup>B</sup>							





		S							
	◀ CITROEN C3 [A51]								
1.1	09.09→	44					0 204 004 451	← 54	
							0 204 103 971		
							0 204 004 452	→ 54	
									0 204 104 359 <sup>8</sup>
1.2 THP	03.12→	60/81					0 204 004 451	← 54	
1.2 VTi							0 204 103 971		
							0 204 004 452	→ 54	
									0 204 104 359 <sup>8</sup>
1.4	06.15→	53					0 204 004 451	← 54	
							0 204 103 971		
							0 204 004 452	→ 54	
1.4	09.09→	54/70-72					0 204 004 451	← 54	
1.4 VTi							0 204 103 971		
1.4 VTi LPG							0 204 004 452	→ 54	
									0 204 104 359 <sup>8</sup>
1.4 HDi	09.09→	50					0 204 004 451	← 54	
							0 204 103 971		
							0 204 004 452	→ 54	
									0 204 104 359 <sup>8</sup>
1.6 HDi	09.09→	55/66/68/					0 204 004 451	← 54	
1.6 VTi		73/82/84/					0 204 103 971		
		88					0 204 004 452	→ 54	
									0 204 104 359 <sup>8</sup>
	1.0 VTi	09.12→	50				F 026 002 282	↔ 20,64	
					T06		F 026 002 671	↔ 20,6	
	1.1	09.09→	44				F 026 002 282	↔ 20,64	
					T06		F 026 002 671	↔ 20,6	
	1.2 THP	03.12→	60/81				F 026 002 282	↔ 20,64	
	1.2 VTi				T06		F 026 002 671	↔ 20,6	
	1.4	06.15→	53				F 026 002 671	↔ 20,6	
	1.4, VTi, VTi LPG	09.09→	54/70-72				F 026 002 282	↔ 20,64	
					T06		F 026 002 671	↔ 20,6	
	1.4 HDi	09.09→	50				F 026 002 282	↔ 20,64	
					T06		F 026 002 671	↔ 20,6	
	1.6 HDi	09.09→	55/66/68/				F 026 002 282	↔ 20,64	
	1.6 VTi		73/88		T06		F 026 002 671	↔ 20,6	
	1.0 VTi	09.12→	50			STB	1 987 482 316	↔ 1706	
						STB,T06	1 987 482 315	↔ 1703	
						4SB	1 987 482 317	↔ 1803	
		09.14→	50			T06	1 987 482 315	↔ 1703	
	1.1	09.09→	44			STB	1 987 482 316	↔ 1706	
						STB,T06	1 987 482 315	↔ 1703	
						4SB	1 987 482 317	↔ 1803	
	1.2 THP	09.14→	81			T06	1 987 482 315	↔ 1703	
						4SB	1 987 482 317	↔ 1803	
	1.2 VTi	03.12→	60			STB	1 987 482 316	↔ 1706	
						STB,T06	1 987 482 315	↔ 1703	
						4SB	1 987 482 317	↔ 1803	
	1.4	09.09→	50/53/54/			STB	1 987 482 316	↔ 1706	
			70-72			STB,T06	1 987 482 315	↔ 1703	
						4SB	1 987 482 317	↔ 1803	
	1.4 HDi	09.09→	50/53/54/			STB	1 987 482 316	↔ 1706	
			70-72			STB,T06	1 987 482 315	↔ 1703	
						4SB	1 987 482 317	↔ 1803	
	1.4 VTi	09.09→	50/53/54/			STB	1 987 482 316	↔ 1706	
			70-72			STB,T06	1 987 482 315	↔ 1703	
						4SB	1 987 482 317	↔ 1803	

	S								
1.4 VTI LPG	06.13→	50/53/54/ 70-72				STB	1 987 482 316	↔ 1706	
						STB,T06	1 987 482 315	↔ 1703	
						4SB	1 987 482 317	↔ 1803	
1.6 HDi	09.09→	55/66/68				STB	1 987 482 316	↔ 1706	
						STB,T06	1 987 482 315	↔ 1703	
						4SB	1 987 482 317	↔ 1803	
	04.14→	73					STB	1 987 482 316	↔ 1706
							STB,T06	1 987 482 315	↔ 1703
							4SB	1 987 482 317	↔ 1803
1.6 VTi	09.09→	82/84/88				T06	1 987 482 315	↔ 1703	
						4SB	1 987 482 317	↔ 1803	
						STB	1 987 482 316	↔ 1706	
						STB,T06	1 987 482 315	↔ 1703	
						4SB	1 987 482 317	↔ 1803	
<b>C3 Picasso [A58]</b>									
									
	1.2 THP	01.15→	81				0 204 004 451	← 54	
							0 204 103 971		
							0 204 004 452	→ 54	
								0 204 104 359 <sup>B</sup>	
1.4	02.09→	70					0 204 004 451	← 54	
							0 204 103 971		
							0 204 004 452	→ 54	
1.4 VTi									
1.4 VTi LPG									
1.4 VTi, VTi LPG	01.10→	70						0 204 104 359 <sup>B</sup>	
1.6	02.09→	84-88						0 204 104 359 <sup>B</sup>	
1.6 BlueHdi	03.10→	68/73					0 204 004 451	← 54	
							0 204 103 971		
							0 204 004 452	→ 54	
								0 204 104 359 <sup>B</sup>	
1.6 HDi	02.09-12.11	66					0 204 004 451	← 54	
							0 204 103 971		
							0 204 004 452	→ 54	
	08.10→	82/84						0 204 004 451	← 54
								0 204 103 971	
								0 204 004 452	→ 54
								0 204 104 359 <sup>B</sup>	
1.6 VTi	01.10→	88					0 204 004 451	← 54	
							0 204 103 971		
							0 204 004 452	→ 54	
								0 204 104 359 <sup>B</sup>	
									
	1.2 THP	01.15→	81				1 987 482 318	↔ 1910	
	1.4	02.09→	70				1 987 482 318	↔ 1910	
	1.4 VTi	01.10→	70				1 987 482 318	↔ 1910	
	1.4 VTi LPG	06.11→	70				1 987 482 318	↔ 1910	
	1.6	02.09→	66/68/73/80/82/84-88				1 987 482 318	↔ 1910	
	1.6 BlueHdi	01.15→	66/68/73/80/82/84-88				1 987 482 318	↔ 1910	
	1.6 HDi	02.09→	66/68/73/80/82/84-88				1 987 482 318	↔ 1910	
	1.6 VTi	01.10→	66/68/73/80/82/84-88				1 987 482 318	↔ 1910	
		1.4	02.09-07.09	70	Org.-Nr. →11920			0 265 007 707 <sup>4</sup>	
			08.09-03.13	70	Org.-Nr. 11921→13264			0 265 008 485 <sup>4</sup>	
1.4 VTi, VTi LPG		01.10-03.13	70	Org.-Nr. →13264			0 265 008 485 <sup>4</sup>		
		1.6	02.09-07.09	84-88	Org.-Nr. →11920			0 265 007 707 <sup>4</sup>	
08.09-03.13			84-88	Org.-Nr. 11921→13264			0 265 008 485 <sup>4</sup>		
1.6 HDi		02.09-07.09	66	Org.-Nr. →11920			0 265 007 707 <sup>4</sup>		
		80	Org.-Nr. →11920			0 265 007 707 <sup>4</sup>			

			S											
<b>CITROEN C3 Picasso [A58]</b>														
	1.6 HDi		08.09-12.11	66	Org.-Nr. 11921→			0 265 008 485 <sup>4</sup>						
											80	Org.-Nr. 11921→	0 265 008 485 <sup>4</sup>	
											03.10-03.13	68	Org.-Nr. →13264	0 265 008 485 <sup>4</sup>
											08.10-03.13	82/84	Org.-Nr. →13264	0 265 008 485 <sup>4</sup>
1.6 VTi		01.10-03.13	88	Org.-Nr. →13264			0 265 008 485 <sup>4</sup>							
<b>C3-Pluriel [A42]</b>														
	1.4	1.4 HDi	05.03-10.12	50/54/55				0986 134 003		← 54				
								0986 135 003		→ 54				
								1.6 16V	05.03-10.12	80	0986 134 003		← 54	
								0986 135 003		→ 54				
	1.4		ABO	05.03-10.12	55			0986 475 907		← 19,05				
								0986 475 908		→ 19,05				
								10.05-10.12	54	0986 475 972		← 19,05		
										0986 475 973		→ 19,05		
		ABS	05.03-10.12	54/55		BO	F 026 002 463		↔ 20,6					
						LUC	0986 475 833		↔ 20,6					
	1.4 HDi		10.03-01.10	50		BO	F 026 002 463		↔ 20,6					
						LUC	0986 475 833		↔ 20,6					
	1.6 16V		05.03-10.12	80				0986 473 421		← 38				
								0986 474 421		→ 38				
	1.4		05.03-11.04	55	Org.-Nr. →10233			1987 477 599		↔ 1716				
								12.04-10.12	55	Org.-Nr. 10234→	1987 477 993		↔ 1693	
								10.05-10.12	54		1987 477 993		↔ 1693	
	1.4 HDi		10.03-11.04	50	Org.-Nr. →10233			1987 477 599		↔ 1716				
								12.04-01.10	50	Org.-Nr. 10234→	1987 477 993		↔ 1693	
	1.6 16V		05.03-11.04	80	Org.-Nr. →10233			1987 477 600		↔ 1812				
								12.04-10.12	80	Org.-Nr. 10234→	1987 482 112		↔ 1790	
		1.4	1.4 HDi	05.03-10.12	50/54/55				0986 594 551 <sup>3</sup>					
0986 594 552 <sup>4</sup>														
1.6 16V									05.03-10.12	80	0986 594 551 <sup>3</sup>			
								0986 594 552 <sup>4</sup>						
<b>C4 [B5]</b>														
	1.4		11.04-09.10	65				0 204 004 451		← 54				
								0 204 103 971						
								0 204 004 452		→ 54				
								0 204 102 974		→ 54				
								0 204 103 974						
	1.6		07.08-09.10	88			AG	0 204 102 974		→ 54				
								0 204 103 974						
	1.6		11.04-07.10	66/80			GS	0 204 004 451		← 54				
								0 204 103 971						
								0 204 004 452		→ 54				
1.6 HDi		11.04-09.10	66/80				0 204 004 451		← 54					
							0 204 103 971							
1.6 i BioFlex		11.04-09.10	66/80				0 204 004 452		→ 54					
							0 204 102 974		→ 54					
							0 204 103 974							
1.6 THP		07.08-09.10	103/110				0 204 102 974		→ 54					
							0 204 103 974							

	S							
2.0	11.04-07.08	100/103				0 204 102 974	→ 54	
						0 204 103 974		
2.0 HDi	11.04-08.08	100/103	Org.-Nr. →11577			0 986 473 451	← 57	
						0 986 474 451	→ 57	
1.4	11.04-09.10	65			BO	0 204 205 113	← 38	
						0 986 473 254		
						0 204 205 114	→ 38	
						0 986 474 254		
				LFS,TW		0 986 473 228	← 38,1	
						0 986 474 228	→	
1.6	11.04-07.08	80			LFS,TW	0 986 473 228	← 38,1	
						0 986 474 228	→	
1.6	11.04-09.10	80			BO	0 204 205 113	← 38	
1.6 HDi						0 986 473 254		
1.6 i BioFlex						0 204 205 114	→ 38	
						0 986 474 254		
1.6	07.08-09.10	88/103/			BO	0 204 205 113	← 38	
1.6 THP		110				0 986 473 254		
						0 204 205 114	→ 38	
						0 986 474 254		
				LFS,TW		0 986 473 228	← 38,1	
						0 986 474 228	→	
1.6 HDi	11.04-07.10	66			BO	0 204 205 113	← 38	
						0 986 473 254		
						0 204 205 114	→ 38	
						0 986 474 254		
				LFS,TW		0 986 473 228	← 38,1	
						0 986 474 228	→	
	11.04-09.10	80			LFS,TW	0 986 473 228	← 38,1	
						0 986 474 228	→	
	04.10→	80			BO	0 204 204 871	←	0 204 0K2 014 <sup>B</sup>
								0 204 0K2 019 <sup>7</sup>
						0 204 204 872	→	0 204 0K2 014 <sup>B</sup>
					LUC	0 986 473 228	← 38,1	
						0 986 474 228	→	
1.6 i BioFlex	09.07-07.08	80			LFS,TW	0 986 473 228	← 38,1	
						0 986 474 228	→	
2.0	11.04-09.10	100/103			BO	0 204 205 113	← 38	
2.0 HDi						0 986 473 254		
						0 204 205 114	→ 38	
						0 986 474 254		
				LFS,TW		0 986 473 228	← 38,1	
						0 986 474 228	→	
1.4	11.04-09.10	65				1 987 477 598	↔ 2035	
1.6	11.04-09.10	66/80/88/103/110				1 987 477 598	↔ 2035	
1.6 HDi	11.04→	66/80/88/103/110				1 987 477 598	↔ 2035	
1.6 i BioFlex	09.07-07.08	66/80/88/103/110				1 987 477 598	↔ 2035	
1.6 THP	07.08-09.10	66/80/88/103/110				1 987 477 598	↔ 2035	
2.0	11.04-07.08	100/103				1 987 477 598	↔ 2035	
2.0 HDi	11.04-09.10	100/103				1 987 477 598	↔ 2035	
1.4	11.04-06.07	65	Org.-Nr. →11164 88		B81	0 265 008 017 <sup>4</sup>		
	11.04-09.10	65			B80	0 265 007 779 <sup>4</sup>		
						0 986 594 559 <sup>3</sup>		
1.6	11.04-06.07	80	Org.-Nr. →11164 88		B81	0 265 008 017 <sup>4</sup>		
1.6, HDi, i BioFlex	11.04-09.10	80			B80	0 265 007 779 <sup>4</sup>		
						0 986 594 559 <sup>3</sup>		



			S							
<b>CITROEN C4 [B5]</b>										
1.6	07.08-09.10	88/103/					B80	0 265 007 779 <sup>4</sup>		
1.6 THP		110						0 986 594 559 <sup>3</sup>		
1.6 HDi	11.04-06.07	80	Org.-Nr. →11164 88				B81	0 265 008 017 <sup>4</sup>		
	11.04-07.10	66						0 265 007 779 <sup>4</sup>		
								0 986 594 559 <sup>3</sup>		
	05.07-06.07	66	Org.-Nr. →11164 88				B81	0 265 008 017 <sup>4</sup>		
	05.07-07.09	66					B80	0 265 007 779 <sup>4</sup>		
								0 986 594 559 <sup>3</sup>		
	04.10→	80						0 265 008 018 <sup>4</sup>		
2.0	11.04-10.05	100						0 265 007 779 <sup>4</sup>		
								0 986 594 559 <sup>3</sup>		
	11.04-06.07	103	Org.-Nr. →11164 88				B81	0 265 008 017 <sup>4</sup>		
	11.04-07.08	103					B80	0 986 594 559 <sup>3</sup>		
2.0, HDi	11.04-09.10	103					B80	0 265 007 779 <sup>4</sup>		
2.0 HDi	11.04-06.07	100	Org.-Nr. →11164 88				B81	0 265 008 017 <sup>4</sup>		
	11.04-01.10	100					B80	0 265 007 779 <sup>4</sup>		
								0 986 594 559 <sup>3</sup>		
	07.08-09.10	103					B80	0 986 594 559 <sup>3</sup>		
<b>C4 [B71]</b>										
	1.2 THP	01.14→	96					0 986 135 258		→
	1.6 BlueHDi, HDi, LPG, THP, VTi, 16V	09.10→	80/82/84/85/88/115					0 986 135 258		→
	1.6 HDi	09.10→	68				FEB	0 986 135 258		→
	2.0, BlueHDi, HDi	09.10→	103/110					0 986 135 258		→
	1.2 THP	01.15→	81/96				249	0 986 473 228		← 38,1
								0 986 474 228		→
	1.4 VTi	09.10→	70				FEB	0 986 473 228		← 38,1
								0 986 474 228		→
	1.6 BlueHDi	04.14→	73				249	0 986 473 228		← 38,1
								0 986 474 228		→
	1.6 HDi	09.10→	68				FEB	0 986 473 228		← 38,1
								0 986 474 228		→
	1.6 HDi, LPG, THP, VTi, 16V	09.10→	80/82/84/88/115				FEB	0 986 473 228		← 38,1
								0 986 474 228		→
	2.0	07.11→	103				FEB	0 986 473 228		← 38,1
								0 986 474 228		→
	1.2 THP	01.14→	96				FEB	1 987 482 372		↔ 829
							FEB	1 987 482 190		↔ 2033
		01.15→	81				FEB	1 987 482 372		↔ 829
	1.4 VTi	09.10→	70				FEB	1 987 482 372		↔ 829
							FEB	1 987 482 190		↔ 2033
	1.6 BlueHDi	04.14→	73/80/82/				FEB	1 987 482 372		↔ 829
			84				FEB	1 987 482 190		↔ 2033
			85				FEB	1 987 482 372		↔ 829
			88				FEB	1 987 482 372		↔ 829
	1.6 HDi	09.10→	68				FEB	1 987 482 372		↔ 829
							FEB	1 987 482 190		↔ 2033
			73/80/82/				FEB	1 987 482 372		↔ 829
			84				FEB	1 987 482 190		↔ 2033
		11.10→	68					1 987 482 372		↔ 829
	1.6 LPG	05.11→	88				FEB	1 987 482 372		↔ 829
							FEB	1 987 482 190		↔ 2033
	1.6 THP	09.10→	115					1 987 482 372		↔ 829
	1.6 VTi	09.10→	88				FEB	1 987 482 372		↔ 829
							FEB	1 987 482 190		↔ 2033

		S							
1.6 16V		11.10→	73/80/82/84				FEB FEB	1 987 482 372 1 987 482 190	↔ 829 ↔ 2033
2.0		07.11→	103					1 987 482 372	↔ 829
2.0 BlueHDi		02.15→	110				FEB	1 987 482 372	↔ 829
2.0 HDi		09.10→	110				FEB	1 987 482 372	↔ 829
<b>C4 Cactus [E3]</b>									
	1.2	01.15→	55			INB		0 204 004 451 0 204 103 971 0 204 004 452	← 54 ↻ → 54
	1.2 THP	06.14→	81					0 204 004 451 0 204 103 971 0 204 004 452	← 54 ↻ → 54
	1.6 Blue HDi 1.6 HDi	02.14→	68/73					0 204 004 451 0 204 103 971 0 204 004 452	← 54 ↻ → 54
	1.2, VTi 1.6 HDi	02.14→	55/60 68					F 026 002 671 F 026 002 671	↔ 20,6 ↔ 20,6
<b>C4 Coupé [B5]</b>									
	1.4	11.04-07.10	65					0 204 004 451 0 204 103 971 0 204 004 452 0 204 102 974 0 204 103 974	← 54 ↻ → 54 → 54 ↻
	1.6	07.08-07.10	88			AG GS		0 204 102 974 0 204 103 974 0 204 004 451 0 204 103 971 0 204 004 452	→ 54 ↻ ← 54 ↻ → 54
	1.6 1.6 HDi	11.04-07.10	66/80					0 204 004 451 0 204 103 971 0 204 004 452 0 204 102 974 0 204 103 974	← 54 ↻ → 54 → 54 ↻
	1.6 THP	07.08-07.10	110					0 204 102 974 0 204 103 974	→ 54 ↻
	2.0	11.04-03.08 11.04-07.08	130 100/103					0 986 473 451 0 986 474 451 0 204 102 974 0 204 103 974	↻ ← 57 ↻ → 57 → 54 ↻
	2.0 HDi	11.04-08.08	100/103			Org.-Nr. →11577		0 986 473 451 0 986 474 451	↻ ← 57 ↻ → 57
	1.4	11.04-07.10	65			BO LFS,TW		0 204 205 113 0 986 473 254 0 204 205 114 0 986 474 254 0 986 473 228 0 986 474 228	← 38 ↻ → 38 ↻ ↻ ← 38,1 ↻ →



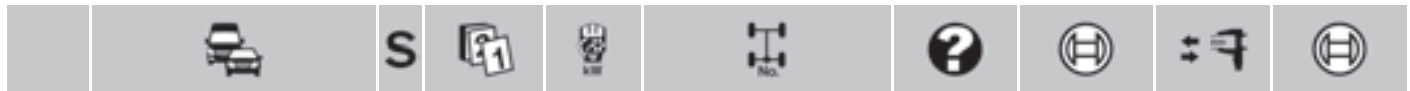

	<b>◀ CITROEN C4 Coupé [B5]</b>							
1.6	11.04-07.10	66/80/88/		BO	0 204 205 113	← 38		
1.6 HDi		110			0 986 473 254			
1.6 THP					0 204 205 114	→ 38		
					0 986 474 254			
				LFS,TW	0 986 473 228	← 38,1		
					0 986 474 228	→		
2.0	11.04-07.10	100/103/		BO	0 204 205 113	← 38		
2.0 HDi		130			0 986 473 254			
					0 204 205 114	→ 38		
					0 986 474 254			
				LFS,TW	0 986 473 228	← 38,1		
					0 986 474 228	→		































	1.4	11.04-07.10	65		1 987 477 598	↔ 2035	
	1.6	11.04-07.10	66/80/88/110		1 987 477 598	↔ 2035	
	1.6 HDi	11.04-07.10	66/80/88/110		1 987 477 598	↔ 2035	
	1.6 THP	07.08-07.10	66/80/88/110		1 987 477 598	↔ 2035	
	2.0	11.04-07.08	100/103/130		1 987 477 598	↔ 2035	
	2.0 HDi	11.04-07.10	100/103/130		1 987 477 598	↔ 2035	

	1.4	11.04-06.07	65	Org.-Nr. →11164 88	B81	0 265 008 017 <sup>4</sup>	
		11.04-07.10	65		B80	0 265 007 779 <sup>4</sup>	
						0 986 594 559 <sup>3</sup>	
	1.6	11.04-06.07	80	Org.-Nr. →11164 88	B81	0 265 008 017 <sup>4</sup>	
	1.6 HDi	11.04-07.10	80		B80	0 265 007 779 <sup>4</sup>	
						0 986 594 559 <sup>3</sup>	
	1.6	07.08-07.10	88/110		B80	0 265 007 779 <sup>4</sup>	
	1.6 THP					0 986 594 559 <sup>3</sup>	
	1.6 HDi	11.04-07.10	66			0 265 007 779 <sup>4</sup>	
						0 986 594 559 <sup>3</sup>	
		05.07-06.07	66	Org.-Nr. →11164 88	B81	0 265 008 017 <sup>4</sup>	
		05.07-07.09	66		B80	0 265 007 779 <sup>4</sup>	
						0 986 594 559 <sup>3</sup>	
	2.0	11.04-10.05	100			0 265 007 779 <sup>4</sup>	
						0 986 594 559 <sup>3</sup>	
		11.04-06.07	103/130	Org.-Nr. →11164 88	B81	0 265 008 017 <sup>4</sup>	
		11.04-07.08	103/130		B80	0 986 594 559 <sup>3</sup>	
	2.0, HDi	11.04-07.10	103/130		B80	0 265 007 779 <sup>4</sup>	
	2.0 HDi	11.04-06.07	100	Org.-Nr. →11164 88	B81	0 265 008 017 <sup>4</sup>	
		11.04-07.09	100		B80	0 265 007 779 <sup>4</sup>	
						0 986 594 559 <sup>3</sup>	
		07.08-07.10	103/130		B80	0 986 594 559 <sup>3</sup>	

**C4 Grand Picasso [B58]**



	1.6	07.08-02.09	88	Org.-Nr. →11766		0 986 134 259	← 60
						0 986 135 259	→ 60
		03.09-04.10	88	Org.-Nr. 11767→		0 986 135 258	→
		04.10→	88			0 986 135 258	→
	1.6 HDi	10.06-02.09	80	Org.-Nr. →11766		0 986 134 259	← 60
						0 986 135 259	→ 60
		03.09-12.11	80	Org.-Nr. 11767→		0 986 135 258	→
		05.10→	82			0 986 135 258	→
	1.6 THP	07.08-07.09	103/110	Org.-Nr. →11920		0 986 134 259	← 60
						0 986 135 259	→ 60
		08.09-12.11	103/110	Org.-Nr. 11921→		0 986 135 258	→
		03.10→	115			0 986 135 258	→
	1.8	10.06-07.08	92			0 986 134 259	← 60
						0 986 135 259	→ 60

		S							
2.0		10.06-10.08	103				0 986 134 259	 ← 60	
							0 986 135 259	 → 60	
2.0 HDi		10.06-07.09	100	Org.-Nr. →11920			0 986 134 259	 ← 60	
							0 986 135 259	 → 60	
		07.09-07.09	110	Org.-Nr. →11920			0 986 134 259	 ← 60	
							0 986 135 259	 → 60	
		08.09-12.11	100	Org.-Nr. 11921→			0 986 135 258	 →	
		08.09→	110	Org.-Nr. 11921→			0 986 135 258	 →	
		09.10→	120				0 986 135 258	 →	
									
	1.6	10.06→	80/82/88/				0 204 207 082	← 38	
	1.6 HDi		103/110/				0 986 134 000		
	1.6 THP		115				0 204 207 083	→ 38	
							0 986 135 000		
1.8		10.06-07.08	92				0 204 207 082	← 38	
							0 986 134 000		
							0 204 207 083	→ 38	
							0 986 135 000		
2.0		10.06→	100/103/				0 204 207 082	← 38	
2.0 HDi			110/120				0 986 134 000		
							0 204 207 083	→ 38	
							0 986 135 000		
									
	1.6	07.08-04.10	88				1 987 482 000	← 928	
							1 987 482 001	→ 959	
		07.08→	88				0 204 080 066		
		04.10-04.11	88	Org.-Nr. →12564			1 987 482 000	← 928	
							1 987 482 001	→ 959	
1.6 HDi		10.06-04.11	80/82	Org.-Nr. →12564			1 987 482 000	← 928	
							1 987 482 001	→ 959	
		10.06→	80/82				0 204 080 066		
1.6 THP		07.08-11.09	103				0 204 080 066		
							1 987 482 000	← 928	
							1 987 482 001	→ 959	
		07.08-04.11	110/115	Org.-Nr. →12564			1 987 482 000	← 928	
							1 987 482 001	→ 959	
		07.08→	110/115				0 204 080 066		
1.8		10.06-07.08	92				0 204 080 066		
							1 987 482 000	← 928	
							1 987 482 001	→ 959	
2.0		10.06-10.08	103				0 204 080 066		
							1 987 482 000	← 928	
							1 987 482 001	→ 959	
2.0 HDi		10.06-04.11	100	Org.-Nr. →12564			1 987 482 000	← 928	
							1 987 482 001	→ 959	
		10.06-12.11	100				0 204 080 066		
		07.09-04.11	110/120	Org.-Nr. →12564			1 987 482 000	← 928	
							1 987 482 001	→ 959	
		07.09→	110/120				0 204 080 066		
									
	1.6, HDi, THP	10.06→	80/82/88/ 103/110/115				0 265 007 788 <sup>3</sup>		
							0 265 007 789 <sup>4</sup>		
1.8		10.06-07.08	92				0 265 007 788 <sup>3</sup>		
							0 265 007 789 <sup>4</sup>		
2.0		10.06→	100/103/				0 265 007 788 <sup>3</sup>		
2.0 HDi			110/120				0 265 007 789 <sup>4</sup>		





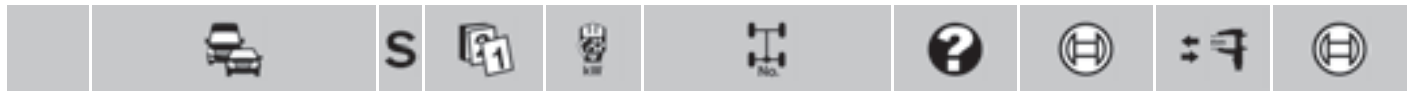

◀ CITROEN

**C4 Picasso [B58]**



	<b>1.6</b>	07.08-02.09	88	Org.-Nr. →11766	0986 <b>134 259</b>	← 60
					0986 <b>135 259</b>	→ 60
		03.09-04.10	88	Org.-Nr. 11767→	0986 <b>135 258</b>	→
		04.10→	88		0986 <b>135 258</b>	→
	<b>1.6 HDi</b>	02.07-02.09	80	Org.-Nr. →11766	0986 <b>134 259</b>	← 60
					0986 <b>135 259</b>	→ 60
		03.09-12.11	80	Org.-Nr. 11767→	0986 <b>135 258</b>	→
		05.10→	82		0986 <b>135 258</b>	→
	<b>1.6 THP</b>	07.08-07.09	103/110	Org.-Nr. →11920	0986 <b>134 259</b>	← 60
					0986 <b>135 259</b>	→ 60
		08.09-12.11	103/110	Org.-Nr. 11921→	0986 <b>135 258</b>	→
		03.10→	115		0986 <b>135 258</b>	→
	<b>1.8</b>	02.07-12.11	92		0986 <b>134 259</b>	← 60
					0986 <b>135 259</b>	→ 60
	<b>2.0</b>	02.07-10.08	103		0986 <b>134 259</b>	← 60
					0986 <b>135 259</b>	→ 60
	<b>2.0 HDi</b>	02.07-07.09	100	Org.-Nr. →11920	0986 <b>134 259</b>	← 60
					0986 <b>135 259</b>	→ 60
		07.09-07.09	110	Org.-Nr. →11920	0986 <b>134 259</b>	← 60
					0986 <b>135 259</b>	→ 60
		08.09-12.11	100	Org.-Nr. 11921→	0986 <b>135 258</b>	→
		08.09→	110	Org.-Nr. 11921→	0986 <b>135 258</b>	→
		09.10→	120		0986 <b>135 258</b>	→



	<b>1.6</b>	02.07→	80/82/88/		0204 <b>207 082</b>	← 38
	<b>1.6 HDi</b>		103/110/		0986 <b>134 000</b>	
	<b>1.6 THP</b>		115		0204 <b>207 083</b>	→ 38
					0986 <b>135 000</b>	
	<b>1.8</b>	02.07-12.11	92		0204 <b>207 082</b>	← 38
					0986 <b>134 000</b>	
					0204 <b>207 083</b>	→ 38
					0986 <b>135 000</b>	
	<b>2.0</b>	02.07→	100/103/		0204 <b>207 082</b>	← 38
	<b>2.0 HDi</b>		110/120		0986 <b>134 000</b>	
					0204 <b>207 083</b>	→ 38
					0986 <b>135 000</b>	















































	<b>1.6</b>	07.08-04.10	88		1987 <b>482 000</b>	← 928
					1987 <b>482 001</b>	→ 959
		07.08→	88		0204 <b>080 066</b>	
		04.10-04.11	88	Org.-Nr. →12564	1987 <b>482 000</b>	← 928
					1987 <b>482 001</b>	→ 959
	<b>1.6 HDi</b>	02.07-04.11	80/82	Org.-Nr. →12564	1987 <b>482 000</b>	← 928
					1987 <b>482 001</b>	→ 959
		02.07→	80/82		0204 <b>080 066</b>	
	<b>1.6 THP</b>	07.08-11.09	103		0204 <b>080 066</b>	
					1987 <b>482 000</b>	← 928
					1987 <b>482 001</b>	→ 959
		07.08-04.11	110/115	Org.-Nr. →12564	1987 <b>482 000</b>	← 928
					1987 <b>482 001</b>	→ 959
		07.08→	110/115		0204 <b>080 066</b>	
	<b>1.8</b>	02.07-12.11	92		0204 <b>080 066</b>	
					1987 <b>482 000</b>	← 928
					1987 <b>482 001</b>	→ 959

		S							
2.0		02.07-10.08	103				0 204 080 066		
							1 987 482 000	← 928	
							1 987 482 001	→ 959	
2.0 HDi		02.07-04.11	100	Org.-Nr. →12564			1 987 482 000	← 928	
							1 987 482 001	→ 959	
		02.07-12.11	100				0 204 080 066		
		07.09-04.11	110/120	Org.-Nr. →12564			1 987 482 000	← 928	
							1 987 482 001	→ 959	
		07.09→	110/120				0 204 080 066		
1.6, HDi, THP		02.07→	80/82/88/ 103/110/115				0 265 007 788 <sup>3</sup>		
							0 265 007 789 <sup>4</sup>		
1.8		02.07-12.11	92				0 265 007 788 <sup>3</sup>		
							0 265 007 789 <sup>4</sup>		
2.0		02.07→	100/103/ 110/120				0 265 007 788 <sup>3</sup>		
2.0 HDi							0 265 007 789 <sup>4</sup>		
<b>C4 Sedan [B5]</b>									
1.6		07.06-12.10	80				0 204 102 974	→ 54	
							0 204 103 974		
1.6 HDi		07.06-11.09	80	Org.-Nr. →12053 77			0 204 102 974	→ 54	
							0 204 103 974		
		07.06-12.10	80	Org.-Nr. 10647 UW→, 10052 88→			0 204 102 974	→ 54	
							0 204 103 974		
2.0		07.06-11.09	103	Org.-Nr. →12053 77			0 204 102 974	→ 54	
							0 204 103 974		
		07.06-12.10	103	Org.-Nr. 10647 UW→, 10052 88→			0 204 102 974	→ 54	
							0 204 103 974		
2.0 HDi		07.06-11.09	80	Org.-Nr. →12053 77			0 204 102 974	→ 54	
							0 204 103 974		
1.6		07.06-12.10	80	Org.-Nr. →11584 88	TW		0 986 473 228	← 38,1	
							0 986 474 228	→	
				Org.-Nr. →12056 77	BO		0 204 204 871	←	0 204 0K2 014 <sup>8</sup>
									0 204 0K2 019 <sup>7</sup>
							0 204 204 872	→	0 204 0K2 014 <sup>8</sup>
				Org.-Nr. 10647 UW→			0 986 473 228	← 38,1	
							0 986 474 228	→	
				Org.-Nr. 11431 88→	TW		0 986 473 228	← 38,1	
							0 986 474 228	→	
				Org.-Nr. 12334 77→	LFS		0 986 473 228	← 38,1	
							0 986 474 228	→	
1.6 HDi		07.06-12.10	80	Org.-Nr. →11584 88	TW		0 986 473 228	← 38,1	
							0 986 474 228	→	
				Org.-Nr. →12056 77	BO		0 204 204 871	←	0 204 0K2 014 <sup>8</sup>
									0 204 0K2 019 <sup>7</sup>
							0 204 204 872	→	0 204 0K2 014 <sup>8</sup>
				Org.-Nr. 10647 UW→			0 986 473 228	← 38,1	
							0 986 474 228	→	
				Org.-Nr. 11431 88→	TW		0 986 473 228	← 38,1	
							0 986 474 228	→	
				Org.-Nr. 12334 77→	LFS		0 986 473 228	← 38,1	
							0 986 474 228	→	
		04.10→	80		BO		0 204 204 871	←	0 204 0K2 014 <sup>8</sup>
									0 204 0K2 019 <sup>7</sup>
							0 204 204 872	→	0 204 0K2 014 <sup>8</sup>
					LUC		0 986 473 228	← 38,1	
							0 986 474 228	→	



<b>CITROEN C4 Sedan [B5]</b>									
	2.0	07.06-12.10	80/103	Org.-Nr. →11584 88	TW	0986 473 228	← 38,1		
	2.0 HDi					0986 474 228	→		
				Org.-Nr. →12056 77	BO	0204 204 871	←	0204 OK2 014 <sup>8</sup>	0204 OK2 019 <sup>7</sup>
						0204 204 872	→		0204 OK2 014 <sup>8</sup>
				Org.-Nr. 10647 UW→		0986 473 228	← 38,1		
						0986 474 228	→		
				Org.-Nr. 11431 88→	TW	0986 473 228	← 38,1		
						0986 474 228	→		
				Org.-Nr. 12334 77→	LFS	0986 473 228	← 38,1		
						0986 474 228	→		
	1.6	07.06-12.10	80			1987 477 775	↔ 2115		
	1.6 HDi	07.06→	80			1987 477 775	↔ 2115		
	2.0	07.06-12.10	80/103			1987 477 775	↔ 2115		
	2.0 HDi	07.06-12.10	80/103			1987 477 775	↔ 2115		
	1.6	07.06-12.10	80	Org.-Nr. 11221 77→	B81	0265 008 018 <sup>4</sup>			
	1.6	07.06-06.07	80	Org.-Nr. →11164 88	B81	0265 008 017 <sup>4</sup>			
	1.6 HDi	07.06-12.10	80		B80	0986 594 559 <sup>3</sup>			
				Org.-Nr. 10073 88→, 10647 UW→	B80	0265 007 779 <sup>4</sup>			
				Org.-Nr. 11018 77→	B80	0265 007 664 <sup>4</sup>			
	1.6 HDi	07.06-12.10	80	Org.-Nr. 11221 77→	B81	0265 008 018 <sup>4</sup>			
		04.10→	80			0265 008 018 <sup>4</sup>			
	2.0	07.06-06.07	80/103	Org.-Nr. →11164 88	B81	0265 008 017 <sup>4</sup>			
	2.0 HDi	07.06-12.10	80/103		B80	0986 594 559 <sup>3</sup>			
				Org.-Nr. 10073 88→, 10647 UW→	B80	0265 007 779 <sup>4</sup>			
			Org.-Nr. 11018 77→	B80	0265 007 664 <sup>4</sup>				
			Org.-Nr. 11221 77→	B81	0265 008 018 <sup>4</sup>				
<b>C5 Break [X3]</b>									
	1.6 HDi	10.04-03.08	80			0204 102 963	← 57	0204 104 251 <sup>7</sup>	
						0986 473 164	→		
						0204 102 964	→ 57	0204 104 251 <sup>7</sup>	
						0986 474 164	→		
	1.8 i	10.04-03.08	85/92			0204 102 963	← 57	0204 104 251 <sup>7</sup>	
						0986 473 164	→		
						0204 102 964	→ 57	0204 104 251 <sup>7</sup>	
						0986 474 164	→		
	2.0 HDi	10.04-03.08	93-100			0204 102 965	← 57	0204 104 251 <sup>7</sup>	
						0204 103 965	→		
						0204 102 966	→ 57	0204 104 251 <sup>7</sup>	
						0204 103 966	→		
	2.0 i	10.04-09.07	103			0204 102 963	← 57	0204 104 251 <sup>7</sup>	
						0986 473 164	→		
						0204 102 964	→ 57	0204 104 251 <sup>7</sup>	
						0986 474 164	→		
	2.2 HDi	10.04-09.05	98			0204 102 965	← 57	0204 104 251 <sup>7</sup>	
						0204 103 965	→		
						0204 102 966	→ 57	0204 104 251 <sup>7</sup>	
						0204 103 966	→		
	04.06-03.08	120-125			0204 102 965	← 57	0204 104 251 <sup>7</sup>		
					0204 103 965	→			
					0204 102 966	→ 57	0204 104 251 <sup>7</sup>		
					0204 103 966	→			

		S								
										
		10.04-04.07	155				0 204 102 965 0 204 103 965	← 57 	0 204 104 251 <sup>7</sup>	
							0 204 102 966 0 204 103 966	→ 57 	0 204 104 251 <sup>7</sup>	
										
		10.04-03.08	80				0 986 473 165	 ← 31,96		
							0 986 474 165	 → 31,96		
		10.04-03.08	85/92				0 986 473 165	 ← 31,96		
							0 986 474 165	 → 31,96		
		10.04-03.08	93-100/ 2.0i 103				0 986 473 165	 ← 31,96		
							0 986 474 165	 → 31,96		
		10.04-09.05	98				0 986 473 165	 ← 31,96		
							0 986 474 165	 → 31,96		
		04.06-03.08	120-125				0 986 473 165	 ← 31,96		
							0 986 474 165	 → 31,96		
		10.04-04.07	155				0 986 473 165	 ← 31,96		
							0 986 474 165	 → 31,96		
										
		10.04-03.08	80				1 987 477 712	↔ 1840		
		10.04-03.08	85/92				1 987 477 712	↔ 1840		
		10.04-03.08	93-100/103				1 987 477 712	↔ 1840		
		10.04-09.07	93-100/103				1 987 477 712	↔ 1840		
		10.04-09.05	98				1 987 477 712	↔ 1840		
		04.06-03.08	120-125				1 987 477 712	↔ 1840		
		10.04-04.07	155				1 987 477 712	↔ 1840		
										
		10.04-03.08	80				0 986 594 568 <sup>4</sup>			
		10.04-03.08	85/92				0 986 594 568 <sup>4</sup>			
		10.04-03.08	93-100/103				0 986 594 568 <sup>4</sup>			
		10.04-09.05	98				0 986 594 568 <sup>4</sup>			
		04.06-03.08	120-125				0 986 594 568 <sup>4</sup>			
		10.04-04.07	155				0 986 594 568 <sup>4</sup>			
<b>C5 Break [X4]</b>										
										
		06.01-09.04	85				0 204 102 963 0 986 473 164	← 57 	0 204 104 251 <sup>7</sup>	
							0 204 102 964 0 986 474 164	→ 57 	0 204 104 251 <sup>7</sup>	
		06.01-09.04	66/79/80/ 2.0 HDi 2.0 HPi 2.0 i 16V 100/103				0 204 102 963 0 986 473 164	← 57 	0 204 104 251 <sup>7</sup>	
							0 204 102 964 0 986 474 164	→ 57 	0 204 104 251 <sup>7</sup>	
		06.01-09.04	98				0 204 102 965 0 204 103 965	← 57 	0 204 104 251 <sup>7</sup>	
							0 204 102 966 0 204 103 966	→ 57 	0 204 104 251 <sup>7</sup>	
		06.01-09.04	150				0 204 102 965 0 204 103 965	← 57 	0 204 104 251 <sup>7</sup>	
							0 204 102 966 0 204 103 966	→ 57 	0 204 104 251 <sup>7</sup>	
										
		06.01-09.04	85				0 986 473 165	 ← 31,96		
							0 986 474 165	 → 31,96		
		06.01-09.04	66/79/80/ 2.0 HDi, HPi, i 16V 100/103				0 986 473 165	 ← 31,96		
							0 986 474 165	 → 31,96		



C

		S							
<b>CITROEN C5 Break [X4]</b>									
		2.2 HDi	06.01-09.04	98			0986 473 165		← 31,96
							0986 474 165		→ 31,96
		3.0i	06.01-09.04	150			0986 473 165		← 31,96
							0986 474 165		→ 31,96
<b>CITROEN C5 [X4]</b>									
		1.8 i 16V	06.01-09.04	85			1987 477 712		↔ 1840
		2.0 HDi	06.01-09.04	66/79/80/100/103			1987 477 712		↔ 1840
		2.0 HPI	06.01-09.04	66/79/80/100/103			1987 477 712		↔ 1840
		2.0 i 16V	06.01-09.04	66/79/80/100/103			1987 477 712		↔ 1840
		2.2 HDi	06.01-09.04	98			1987 477 712		↔ 1840
		3.0i	06.01-09.04	150			1987 477 712		↔ 1840
<b>C5 Tourer [X7]</b>									
		1.6	09.10→	80/82/84/88/110/115/120	FEB		1987 482 409		↔ 2268
		1.6 HDi	04.08→	80/82/84/88/110/115/120	FEB		1987 482 409		↔ 2268
		1.6 THP	09.09→	80/82/84/88/110/115/120	FEB		1987 482 409		↔ 2268
		1.8	04.08-01.11	92	FEB		1987 482 409		↔ 2268
		2.0	04.08-01.10	100-103/110/120/133	FEB		1987 482 409		↔ 2268
		2.0 BlueHDi	03.15→	100-103/110/120/133	FEB		1987 482 409		↔ 2268
		2.0 HDi	04.08→	100-103/110/120/133	FEB		1987 482 409		↔ 2268
		2.2 HDi	04.08-09.09	120-125	FEB		1987 482 409		↔ 2268
			07.10→	150	FEB		1987 482 409		↔ 2268
		2.7 HDi	04.08-07.09	150	FEB		1987 482 409		↔ 2268
		3.0 HDi 24V	07.09→	177	FEB		1987 482 409		↔ 2268
		1.6, HDi, THP	09.09→	82/84/88/ 110/115/120			0986 594 562 <sup>4</sup>		
		1.6 HDi	04.08-07.08	80	Org.-Nr. →11558		0986 594 522 <sup>3</sup>		
			04.08-11.08	80	Org.-Nr. →11682		0986 594 523 <sup>4</sup>		
			08.08-07.10	80	Org.-Nr. 11559→		0986 594 567 <sup>3</sup>		
			12.08-07.10	80	Org.-Nr. 11683→		0986 594 562 <sup>4</sup>		
		1.8	04.08-07.08	92	Org.-Nr. →11558		0986 594 522 <sup>3</sup>		
			04.08-11.08	92	Org.-Nr. →11682		0986 594 523 <sup>4</sup>		
			08.08-01.11	92	Org.-Nr. 11559→		0986 594 567 <sup>3</sup>		
			12.08-01.11	92	Org.-Nr. 11683→		0986 594 562 <sup>4</sup>		
		2.0	04.08-07.08	103	Org.-Nr. →11558		0986 594 522 <sup>3</sup>		
			04.08-11.08	103	Org.-Nr. →11682		0986 594 523 <sup>4</sup>		
			08.08-01.10	103	Org.-Nr. 11559→		0986 594 567 <sup>3</sup>		
			12.08-01.10	103	Org.-Nr. 11683→		0986 594 562 <sup>4</sup>		
		2.0 BlueHDi	09.09→	110/120/			0986 594 562 <sup>4</sup>		
		2.0 HDi		133			0986 594 567 <sup>3</sup>		
		2.0 HDi	04.08-07.08	100-103	Org.-Nr. →11558		0986 594 522 <sup>3</sup>		
			04.08-11.08	100-103	Org.-Nr. →11682		0986 594 523 <sup>4</sup>		
			08.08→	100-103	Org.-Nr. 11559→		0986 594 567 <sup>3</sup>		
			12.08→	100-103	Org.-Nr. 11683→		0986 594 562 <sup>4</sup>		
			12.10→	100-103			0986 594 562 <sup>4</sup>		
							0986 594 567 <sup>3</sup>		
		2.2 HDi	04.08-07.08	120-125	Org.-Nr. →11558		0986 594 522 <sup>3</sup>		
			04.08-11.08	120-125	Org.-Nr. →11682		0986 594 523 <sup>4</sup>		
			08.08-09.09	120-125	Org.-Nr. 11559→		0986 594 567 <sup>3</sup>		
			12.08-09.09	120-125	Org.-Nr. 11683→		0986 594 562 <sup>4</sup>		
			07.10→	150			0986 594 562 <sup>4</sup>		
							0986 594 567 <sup>3</sup>		
		2.7 HDi	04.08-07.08	150	Org.-Nr. →11558		0986 594 522 <sup>3</sup>		
			04.08-11.08	150	Org.-Nr. →11682		0986 594 523 <sup>4</sup>		
			08.08-07.09	150	Org.-Nr. 11559→		0986 594 567 <sup>3</sup>		
			12.08-07.09	150	Org.-Nr. 11683→		0986 594 562 <sup>4</sup>		
		3.0 HDi 24V	07.09→	177			0986 594 562 <sup>4</sup>		
							0986 594 567 <sup>3</sup>		













**C5 [X3]**

Icon	Engine	Period	Power	Part No.	Quantity	Part No.
	<b>1.6 HDi</b>	10.04-03.08	80	0 204 102 963 0 986 473 164	← 57	0 204 104 251 <sup>7</sup>
				0 204 102 964 0 986 474 164	→ 57	0 204 104 251 <sup>7</sup>
	<b>1.8 i</b>	10.04-03.08	85/92	0 204 102 961 0 986 473 452	← 54	0 204 104 250 <sup>7</sup>
				0 204 102 962 0 986 474 452	→ 54	0 204 104 250 <sup>7</sup>
	<b>2.0 HDi</b>	10.04-03.08	93-100	0 204 102 965 0 204 103 965	← 57	0 204 104 251 <sup>7</sup>
				0 204 102 966 0 204 103 966	→ 57	0 204 104 251 <sup>7</sup>
	<b>2.0 i</b>	10.04-03.08	103	0 204 102 963 0 986 473 164	← 57	0 204 104 251 <sup>7</sup>
				0 204 102 964 0 986 474 164	→ 57	0 204 104 251 <sup>7</sup>
	<b>2.2 HDi</b>	10.04-09.05	98	0 204 102 965 0 204 103 965	← 57	0 204 104 251 <sup>7</sup>
				0 204 102 966 0 204 103 966	→ 57	0 204 104 251 <sup>7</sup>
		03.06-03.08	120-125	0 204 102 965 0 204 103 965	← 57	0 204 104 251 <sup>7</sup>
				0 204 102 966 0 204 103 966	→ 57	0 204 104 251 <sup>7</sup>
	<b>3.0 i</b>	10.04-04.07	155	0 204 102 965 0 204 103 965	← 57	0 204 104 251 <sup>7</sup>
				0 204 102 966 0 204 103 966	→ 57	0 204 104 251 <sup>7</sup>
	<b>1.6 HDi</b>	10.04-03.08	80	0 986 473 165	← 31,96	
				0 986 474 165	→ 31,96	
	<b>1.8 i</b>	10.04-03.08	85/92	0 986 473 165	← 31,96	
				0 986 474 165	→ 31,96	
	<b>2.0 HDi</b>	10.04-03.08	93-100/	0 986 473 165	← 31,96	
	<b>2.0 i</b>		103	0 986 474 165	→ 31,96	
	<b>2.2 HDi</b>	10.04-09.05	98	0 986 473 165	← 31,96	
				0 986 474 165	→ 31,96	
		03.06-03.08	120-125	0 986 473 165	← 31,96	
				0 986 474 165	→ 31,96	
	<b>3.0 i</b>	10.04-04.07	155	0 986 473 165	← 31,96	
				0 986 474 165	→ 31,96	
	<b>1.6 HDi</b>	10.04-03.08	80	1 987 477 712	↔ 1840	
	<b>1.8 i</b>	10.04-03.08	85/92	1 987 477 712	↔ 1840	
	<b>2.0 HDi</b>	10.04-03.08	93-100/103	1 987 477 712	↔ 1840	
	<b>2.0 i</b>	10.04-03.08	93-100/103	1 987 477 712	↔ 1840	
	<b>2.2 HDi</b>	10.04-09.05	98	1 987 477 712	↔ 1840	
		03.06-03.08	120-125	1 987 477 712	↔ 1840	
	<b>3.0 i</b>	10.04-04.07	155	1 987 477 712	↔ 1840	
	<b>1.6 HDi</b>	10.04-03.08	80	0 986 594 568 <sup>4</sup>		
	<b>1.8 i</b>	10.04-03.08	85/92	0 986 594 568 <sup>4</sup>		
	<b>2.0 HDi, i</b>	10.04-03.08	93-100/103	0 986 594 568 <sup>4</sup>		
	<b>2.2 HDi</b>	10.04-09.05	98	0 986 594 568 <sup>4</sup>		
		03.06-03.08	120-125	0 986 594 568 <sup>4</sup>		
	<b>3.0 i</b>	10.04-04.07	155	0 986 594 568 <sup>4</sup>		



			S								
◀ CITROEN											
<b>C5 [X4]</b>											
	1.8 i 16V	03.01-09.04	85			0 204 102 961	← 54	0 204 104 250 <sup>7</sup>			
				0986 473 452							
					0 204 102 962	→ 54	0 204 104 250 <sup>7</sup>				
					0986 474 452						
	2.0 HDi	03.01-09.04	66/79/80/	100/103			0 204 102 963	← 57	0 204 104 251 <sup>7</sup>		
					0986 473 164						
	2.0 HPi					0 204 102 964	→ 57	0 204 104 251 <sup>7</sup>			
						0986 474 164					
	2.2 HDi	03.01-09.04	98			0 204 102 965	← 57	0 204 104 251 <sup>7</sup>			
						0 204 103 965					
						0 204 102 966	→ 57	0 204 104 251 <sup>7</sup>			
					0 204 103 966						
3.0 i	03.01-09.04	150			0 204 102 965	← 57	0 204 104 251 <sup>7</sup>				
					0 204 103 965						
					0 204 102 966	→ 57	0 204 104 251 <sup>7</sup>				
				0 204 103 966							
	1.8 i 16V	03.01-09.04	85			0986 473 165	← 31,96				
						0986 474 165	→ 31,96				
	2.0 HDi, HPi, i 16V	03.01-09.04	66/79/80/	100/103			0986 473 165	← 31,96			
							0986 474 165	→ 31,96			
	2.2 HDi	03.01-09.04	98			0986 473 165	← 31,96				
						0986 474 165	→ 31,96				
	3.0 i	03.01-09.04	150			0986 473 165	← 31,96				
						0986 474 165	→ 31,96				
		1.8 i 16V	03.01-09.04	85			1987 477 712	↔ 1840			
2.0 HDi		03.01-09.04	66/79/80/100/103			1987 477 712	↔ 1840				
2.0 HPi		03.01-09.04	66/79/80/100/103			1987 477 712	↔ 1840				
2.0 i 16V		03.01-09.04	66/79/80/100/103			1987 477 712	↔ 1840				
2.2 HDi		03.01-09.04	98			1987 477 712	↔ 1840				
3.0 i		03.01-09.04	150			1987 477 712	↔ 1840				
<b>C5 [X7]</b>											
	1.6 HDi	04.08→	80/82/84/88/110/115/120		FEB	1987 482 409	↔ 2268				
	1.6 THP	09.09→	80/82/84/88/110/115/120		FEB	1987 482 409	↔ 2268				
	1.6 VTi	09.10→	80/82/84/88/110/115/120		FEB	1987 482 409	↔ 2268				
	1.8	04.08-01.11	92		FEB	1987 482 409	↔ 2268				
	2.0	04.08-01.10	100-103/110/120/133		FEB	1987 482 409	↔ 2268				
	2.0 BlueHDi	03.15→	100-103/110/120/133		FEB	1987 482 409	↔ 2268				
	2.0 HDi	04.08→	100-103/110/120/133		FEB	1987 482 409	↔ 2268				
	2.2 HDi	04.08-09.09	120-125		FEB	1987 482 409	↔ 2268				
		07.10→	150		FEB	1987 482 409	↔ 2268				
	2.7 HDi	04.08-07.09	150		FEB	1987 482 409	↔ 2268				
	3.0	04.08-04.09	155		FEB	1987 482 409	↔ 2268				
	3.0 HDi 24V	07.09→	177		FEB	1987 482 409	↔ 2268				
	3.0 24V	04.08-04.09	155		FEB	1987 482 409	↔ 2268				
		1.6 HDi	04.08-07.08	80	Org.-Nr. →11558		0986 594 522 <sup>3</sup>				
			04.08-11.08	80	Org.-Nr. →11682		0986 594 523 <sup>4</sup>				
08.08-07.10			80	Org.-Nr. 11559→		0986 594 567 <sup>3</sup>					
12.08-07.10			80	Org.-Nr. 11683→		0986 594 562 <sup>4</sup>					
1.6 HDi, THP, VTi		09.09→	82/84/88/110/115/120			0986 594 562 <sup>4</sup>					
						0986 594 567 <sup>3</sup>					

		S								
<b>1.8</b>		04.08-07.08	92	Org.-Nr. →11558			0 986 594 522 <sup>3</sup>			
		04.08-11.08	92	Org.-Nr. →11682			0 986 594 523 <sup>4</sup>			
		08.08-01.11	92	Org.-Nr. 11559→			0 986 594 567 <sup>3</sup>			
		12.08-01.11	92	Org.-Nr. 11683→			0 986 594 562 <sup>4</sup>			
<b>2.0</b>		04.08-07.08	103	Org.-Nr. →11558			0 986 594 522 <sup>3</sup>			
		04.08-11.08	103	Org.-Nr. →11682			0 986 594 523 <sup>4</sup>			
		08.08-01.10	103	Org.-Nr. 11559→			0 986 594 567 <sup>3</sup>			
		12.08-01.10	103	Org.-Nr. 11683→			0 986 594 562 <sup>4</sup>			
<b>2.0 BlueHdi</b>		09.09→	110/120/			0 986 594 562 <sup>4</sup>				
<b>2.0 HDi</b>			133			0 986 594 567 <sup>3</sup>				
<b>2.0 HDi</b>		04.08-07.08	100-103	Org.-Nr. →11558			0 986 594 522 <sup>3</sup>			
		04.08-11.08	100-103	Org.-Nr. →11682			0 986 594 523 <sup>4</sup>			
		08.08→	100-103	Org.-Nr. 11559→			0 986 594 567 <sup>3</sup>			
		12.08→	100-103	Org.-Nr. 11683→			0 986 594 562 <sup>4</sup>			
		12.10→	100-103				0 986 594 562 <sup>4</sup>			
<b>2.2 HDi</b>		04.08-07.08	120-125	Org.-Nr. →11558			0 986 594 522 <sup>3</sup>			
		04.08-11.08	120-125	Org.-Nr. →11682			0 986 594 523 <sup>4</sup>			
		08.08-09.09	120-125	Org.-Nr. 11559→			0 986 594 567 <sup>3</sup>			
		12.08-09.09	120-125	Org.-Nr. 11683→			0 986 594 562 <sup>4</sup>			
		07.10→	150				0 986 594 562 <sup>4</sup>			
<b>2.7 HDi</b>		04.08-07.08	150	Org.-Nr. →11558			0 986 594 522 <sup>3</sup>			
		04.08-11.08	150	Org.-Nr. →11682			0 986 594 523 <sup>4</sup>			
		08.08-07.09	150	Org.-Nr. 11559→			0 986 594 567 <sup>3</sup>			
		12.08-07.09	150	Org.-Nr. 11683→			0 986 594 562 <sup>4</sup>			
<b>3.0</b>		04.08-07.08	155	Org.-Nr. →11558			0 986 594 522 <sup>3</sup>			
	<b>3.0 24V</b>	04.08-11.08	155	Org.-Nr. →11682			0 986 594 523 <sup>4</sup>			
		08.08-04.09	155	Org.-Nr. 11559→			0 986 594 567 <sup>3</sup>			
<b>3.0 HDi 24V</b>	12.08-04.09	155	Org.-Nr. 11683→			0 986 594 562 <sup>4</sup>				
	07.09→	177				0 986 594 562 <sup>4</sup>				
						0 986 594 567 <sup>3</sup>				
<b>C6 [X6]</b>										
										
	<b>2.2 HDi</b>	06.06-10.07	120-125	Org.-Nr. →11283			0 986 594 520 <sup>3</sup>			
			11.07-11.08	120-125	Org.-Nr. 11284→11682			0 986 594 521 <sup>4</sup>		
								0 986 594 522 <sup>3</sup>		
			12.08-07.10	120-125	Org.-Nr. 11683→			0 986 594 523 <sup>4</sup>		
						0 986 594 562 <sup>4</sup>				
						0 986 594 567 <sup>3</sup>				
<b>2.7 HDi</b>		11.05-10.07	150	Org.-Nr. →11283			0 986 594 520 <sup>3</sup>			
							0 986 594 521 <sup>4</sup>			
		11.07-11.08	150	Org.-Nr. 11284→11682			0 986 594 522 <sup>3</sup>			
							0 986 594 523 <sup>4</sup>			
		12.08-07.09	150	Org.-Nr. 11683→			0 986 594 562 <sup>4</sup>			
							0 986 594 567 <sup>3</sup>			
<b>3.0</b>		11.05-10.07	155	Org.-Nr. →11283			0 986 594 520 <sup>3</sup>			
							0 986 594 521 <sup>4</sup>			
		11.07-11.08	155	Org.-Nr. 11284→11682			0 986 594 522 <sup>3</sup>			
							0 986 594 523 <sup>4</sup>			
		12.08-02.09	155	Org.-Nr. 11683→			0 986 594 562 <sup>4</sup>			
							0 986 594 567 <sup>3</sup>			
<b>3.0 HDi 24V</b>		07.09→	177				0 986 594 562 <sup>4</sup>			
							0 986 594 567 <sup>3</sup>			





							<b>S</b>				<b>?</b>			
◀ CITROEN														
<b>C8 [V3]</b>														
	<b>2.0 HDi</b>	06.02-02.05	81	Org.-Nr. →10284	LLE	1987 <b>477 713</b>	← 1068							
					RLE	1987 <b>477 714</b>	→ 2360							
							1987 <b>477 713</b>	→ 1068						
							1987 <b>477 714</b>	← 2360						
			06.02-12.06	81			1987 <b>477 565</b>	500						
			03.05-12.06	81	Org.-Nr. 10285→	LLE	1987 <b>477 953</b>	→ 2308						
						1987 <b>477 954</b>	← 1041							
					RLE	1987 <b>477 953</b>	← 2308							
						1987 <b>477 954</b>	→ 1041							
			03.06-05.10	88		1987 <b>482 235</b>	↔ 1255							
				100		1987 <b>482 235</b>	↔ 1255							
	<b>2.0 16V</b>	06.02-02.05	100	Org.-Nr. →10284	LLE	1987 <b>477 713</b>	← 1068							
					RLE	1987 <b>477 714</b>	→ 2360							
							1987 <b>477 713</b>	→ 1068						
						1987 <b>477 714</b>	← 2360							
		06.02-05.06	100			1987 <b>477 565</b>	500							
		03.05-05.06	100	Org.-Nr. 10285→	LLE	1987 <b>477 953</b>	→ 2308							
						1987 <b>477 954</b>	← 1041							
					RLE	1987 <b>477 953</b>	← 2308							
						1987 <b>477 954</b>	→ 1041							
			10.05-05.10	103		1987 <b>477 953</b>	→ 2308							
					LLE,TW	1987 <b>477 954</b>	← 1041							
					RLE,TW	1987 <b>477 953</b>	← 2308							
						1987 <b>477 954</b>	→ 1041							
					TW	1987 <b>477 565</b>	500							
<b>2.2 HDi</b>	06.02-02.05	94/116	Org.-Nr. →10284	LLE	1987 <b>477 713</b>	← 1068								
				RLE	1987 <b>477 714</b>	→ 2360								
						1987 <b>477 713</b>	→ 1068							
						1987 <b>477 714</b>	← 2360							
		03.05-07.06	94/116	Org.-Nr. 10285→	LLE	1987 <b>477 953</b>	→ 2308							
						1987 <b>477 954</b>	← 1041							
					RLE	1987 <b>477 953</b>	← 2308							
						1987 <b>477 954</b>	→ 1041							
			09.07-05.10	120-125		1987 <b>482 235</b>	↔ 1255							
	<b>2.2 HDi, 16V</b>	06.02-07.06	94/116			1987 <b>477 565</b>	500							
	<b>2.2 16V</b>	06.02-02.05	94/116	Org.-Nr. →10284	LLE	1987 <b>477 713</b>	← 1068							
					RLE	1987 <b>477 714</b>	→ 2360							
							1987 <b>477 713</b>	→ 1068						
							1987 <b>477 714</b>	← 2360						
		03.05-05.06	94/116	Org.-Nr. 10285→	LLE	1987 <b>477 953</b>	→ 2308							
						1987 <b>477 954</b>	← 1041							
					RLE	1987 <b>477 953</b>	← 2308							
						1987 <b>477 954</b>	→ 1041							
			10.02-02.05	150	Org.-Nr. →10284	LLE	1987 <b>477 713</b>	← 1068						
						1987 <b>477 714</b>	→ 2360							
					RLE	1987 <b>477 713</b>	→ 1068							
						1987 <b>477 714</b>	← 2360							
			10.02-05.06	150		1987 <b>477 565</b>	500							
		03.05-05.06	150	Org.-Nr. 10285→	LLE	1987 <b>477 953</b>	→ 2308							
					1987 <b>477 954</b>	← 1041								
				RLE	1987 <b>477 953</b>	← 2308								
					1987 <b>477 954</b>	→ 1041								
	<b>2.0 HDi</b>	06.10-07.14	120			0986 <b>594 566</b> <sup>4</sup>								
					LAB	0265 <b>007 130</b> <sup>3</sup>								
					RAB	0265 <b>007 131</b> <sup>3</sup>								
	<b>2.0 HDi</b>	06.02-07.14	81/88/100/			0986 <b>594 566</b> <sup>4</sup>								
	<b>2.0 16V</b>		103			0265 <b>007 083</b> <sup>3</sup>								
					RAB	0265 <b>007 084</b> <sup>3</sup>								



		S							
2.2 HDi		09.07-05.10	120-125				0 986 594 566 <sup>4</sup>		
						LAB	0 265 007 130 <sup>3</sup>		
						RAB	0 265 007 131 <sup>3</sup>		
2.2 HDi		06.02-07.06	94/116				0 986 594 566 <sup>4</sup>		
2.2 16V						LAB	0 265 007 083 <sup>3</sup>		
						RAB	0 265 007 084 <sup>3</sup>		
3.0		10.02-05.06	150				0 986 594 566 <sup>4</sup>		
						LAB	0 265 007 083 <sup>3</sup>		
						RAB	0 265 007 084 <sup>3</sup>		
<b>DS3 [A5]</b>									
	1.6 Blue HDi	01.14→	85				0 204 004 451	← 54	
							0 204 103 971		
							0 204 004 452	→ 54	
									0 204 104 359 <sup>B</sup>
	1.6 Blue HDi	01.14→	85				1 987 482 317	↔ 1803	
<b>DS3 [A55]</b>									
	1.2 THP	06.12→	60/81				0 204 004 451	← 54	
	1.2 VTi						0 204 103 971		
							0 204 004 452	→ 54	
									0 204 104 359 <sup>B</sup>
	1.4 HDi 8V	01.10→	50/70-72				0 204 004 451	← 54	
	1.4 VTi						0 204 103 971		
	1.4 VTi LPG						0 204 004 452	→ 54	
									0 204 104 359 <sup>B</sup>
	1.6 Blue HDi, HDi, THP, THP Racing, VTi	11.09→	55/68/73/82/84/88/110/115/120/121/149/152				0 204 004 451	← 54	
							0 204 103 971		
							0 204 004 452	→ 54	
									0 204 104 359 <sup>B</sup>
	1.2 THP	06.12→	60/81				F 026 002 282	↔ 20,64	
	1.2 VTi					T06	F 026 002 671	↔ 20,6	
	1.4 HDi 8V, VTi, VTi LPG	01.10→	50/70-72				F 026 002 282	↔ 20,64	
						T06	F 026 002 671	↔ 20,6	
	1.6 Blue HDi, HDi, THP	01.10→	55/68/110/121				F 026 002 282	↔ 20,64	
						T06	F 026 002 671	↔ 20,6	
	1.2 THP	04.14→	81			STB	1 987 482 316	↔ 1706	
						STB,T06	1 987 482 315	↔ 1703	
						4SB	1 987 482 317	↔ 1803	
	1.2 VTi	06.12→	60			STB	1 987 482 316	↔ 1706	
						STB,T06	1 987 482 315	↔ 1703	
						4SB	1 987 482 317	↔ 1803	
		03.14→	60				1 987 482 317	↔ 1803	
	1.4 HDi 8V	03.10→	50				1 987 482 316	↔ 1706	
						T06	1 987 482 315	↔ 1703	
	1.4 VTi	01.10→	70-72				1 987 482 316	↔ 1706	
	1.4 VTi LPG	06.11→	70-72				1 987 482 316	↔ 1706	
	1.6 Blue HDi	01.14→	73/82/84/88				1 987 482 317	↔ 1803	



		S															
	<b>◀ CITROEN DS3 [A55]</b>																
<b>1.6 BlueHDi</b>	09.14→	55/68					STB	1987 <b>482 316</b>	↔ 1706								
							STB,T06	1987 <b>482 315</b>	↔ 1703								
							4SB	1987 <b>482 317</b>	↔ 1803								
<b>1.6 HDi</b>	11.09→	73/82/84/88						1987 <b>482 317</b>	↔ 1803								
	01.10→	55/68					STB	1987 <b>482 316</b>	↔ 1706								
							STB,T06	1987 <b>482 315</b>	↔ 1703								
							4SB	1987 <b>482 317</b>	↔ 1803								
<b>1.6 THP</b>	01.10→	110						1987 <b>482 317</b>	↔ 1803								
		115/120						1987 <b>482 317</b>	↔ 1803								
	04.14→	110						STB	1987 <b>482 316</b>	↔ 1706							
								STB,T06	1987 <b>482 315</b>	↔ 1703							
								4SB	1987 <b>482 317</b>	↔ 1803							
		121					STB	1987 <b>482 316</b>	↔ 1706								
							STB,T06	1987 <b>482 315</b>	↔ 1703								
<b>1.6 THP Racing</b>	10.10→	149/152					4SB	1987 <b>482 317</b>	↔ 1803								
<b>1.6 VTi</b>	01.10→	73/82/84/88						1987 <b>482 317</b>	↔ 1803								
<b>DS3 Cabrio [A56]</b>																	
	<b>1.2 THP</b>	07.12→	60/81					0 204 <b>004 451</b>	← 54								
	<b>1.2 VTi</b>							0 204 <b>103 971</b>									
	<b>1.2 VTi</b>							0 204 <b>004 452</b>	→ 54								
									0 204 <b>104 359<sup>8</sup></b>								
<b>1.6 Blue HDi</b>	07.12→	68/73/85/						0 204 <b>004 451</b>	← 54								
								0 204 <b>103 971</b>									
								0 204 <b>004 452</b>	→ 54								
<b>1.6 HDi</b>		88/110/							0 204 <b>104 359<sup>8</sup></b>								
<b>1.6 THP</b>		115/121															
<b>1.6 VTi</b>																	
	<b>1.2 THP</b>	07.12→	60/81					F 026 <b>002 282</b>	↔ 20,64								
	<b>1.2 VTi</b>						T06	F 026 <b>002 671</b>	↔ 20,6								
	<b>1.6 HDi</b>	07.12→	68/110/					F 026 <b>002 282</b>	↔ 20,64								
	<b>1.6 THP</b>		121				T06	F 026 <b>002 671</b>	↔ 20,6								
	<b>1.2 THP</b>	04.14→	81					STB	1987 <b>482 316</b>	↔ 1706							
								STB,T06	1987 <b>482 315</b>	↔ 1703							
								4SB	1987 <b>482 317</b>	↔ 1803							
	<b>1.2 VTi</b>	03.14→	60						1987 <b>482 317</b>	↔ 1803							
									07.12→	60					STB	1987 <b>482 316</b>	↔ 1706
															STB,T06	1987 <b>482 315</b>	↔ 1703
								4SB	1987 <b>482 317</b>	↔ 1803							
	<b>1.6 Blue HDi</b>	01.14→	73/85/88						1987 <b>482 317</b>	↔ 1803							
	<b>1.6 HDi</b>	07.12→	68						STB	1987 <b>482 316</b>	↔ 1706						
									STB,T06	1987 <b>482 315</b>	↔ 1703						
									4SB	1987 <b>482 317</b>	↔ 1803						
		01.14→	73/85/88						1987 <b>482 317</b>	↔ 1803							
	<b>1.6 THP</b>	07.12→	115						1987 <b>482 317</b>	↔ 1803							
			110						1987 <b>482 317</b>	↔ 1803							
		04.14→	110						STB	1987 <b>482 316</b>	↔ 1706						
									STB,T06	1987 <b>482 315</b>	↔ 1703						
									4SB	1987 <b>482 317</b>	↔ 1803						
		121					STB	1987 <b>482 316</b>	↔ 1706								
							STB,T06	1987 <b>482 315</b>	↔ 1703								
<b>1.6 VTi</b>	07.12→	73/85/88					4SB	1987 <b>482 317</b>	↔ 1803								

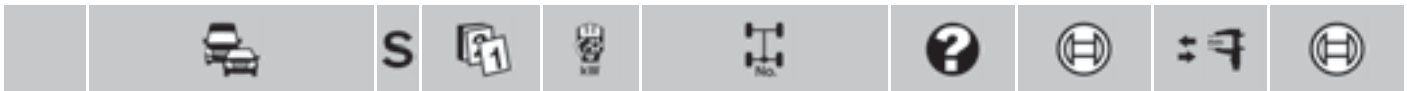

**DS4 [B75]**

	<b>1.2 THP</b>	01.14→	96			0 986 <b>135 258</b>	→
	<b>1.6 HDi, HDi 16V, THP, VTi</b>	03.11→	68/82/84/85/88/110/115/120/121			0 986 <b>135 258</b>	→
	<b>2.0 BlueHDi</b>	09.14→	110			0 986 <b>135 258</b>	→
	<b>2.0 BlueHDi, HDi 16V</b>	03.11→	120/133	302		0 986 <b>135 258</b>	→
	<b>2.0 HDi</b>	09.11→	100	302		0 986 <b>135 258</b>	→

	<b>1.6 BlueHDi, HDi, HDi 16V, THP, VTi</b>	03.11→	68/73/82/84/88/115/147	FEB		0 986 <b>473 228</b>	← 38,1
						0 986 <b>474 228</b>	→
	<b>2.0 BlueHDi</b>	09.14→	110	FEB		0 986 <b>473 228</b>	← 38,1
						0 986 <b>474 228</b>	→
			133	249		0 986 <b>473 228</b>	← 38,1
						0 986 <b>474 228</b>	→

	<b>1.2 THP</b>	01.14→	96	FEB		1 987 <b>482 372</b>	↔ 829
				FEB		1 987 <b>482 190</b>	↔ 2033
	<b>1.6 BlueHDi</b>	05.15→	68/73/82/84	FEB		1 987 <b>482 372</b>	↔ 829
				FEB		1 987 <b>482 190</b>	↔ 2033
	<b>1.6 HDi</b>	03.11→	68/73/82/84	FEB		1 987 <b>482 372</b>	↔ 829
				FEB		1 987 <b>482 190</b>	↔ 2033
		04.14→	85	FEB		1 987 <b>482 372</b>	↔ 829
			88	FEB		1 987 <b>482 372</b>	↔ 829
	<b>1.6 HDi 16V</b>	03.11→	68/73/82/84	FEB		1 987 <b>482 372</b>	↔ 829
				FEB		1 987 <b>482 190</b>	↔ 2033
	<b>1.6 THP</b>	03.11→	110/115/120/121/147	FEB		1 987 <b>482 372</b>	↔ 829
						1 987 <b>482 372</b>	↔ 829
	<b>1.6 VTi</b>	03.11→	88	FEB		1 987 <b>482 372</b>	↔ 829
				FEB		1 987 <b>482 190</b>	↔ 2033
	<b>2.0 BlueHDi</b>	09.14→	100/110/120/133	FEB		1 987 <b>482 372</b>	↔ 829
						1 987 <b>482 372</b>	↔ 829
	<b>2.0 HDi</b>	09.11→	100/110/120	FEB		1 987 <b>482 372</b>	↔ 829
	<b>2.0 HDi 16V</b>	03.11→	100/110/120	FEB		1 987 <b>482 372</b>	↔ 829

**DS5 [B81]**

	<b>1.6 Blue HDi, HDi, THP</b>	09.11→	82/84/85/88/110/115/120-121			0 986 <b>135 258</b>	→
	<b>1.6 THP</b>	01.15→	121	302		0 986 <b>135 258</b>	→
	<b>2.0 BlueHDi, HDi</b>	09.11→	100/110/120/132	302		0 986 <b>135 258</b>	→

	<b>1.6 Blue HDi, HDi, THP</b>	09.11→	82/84/85/88/110/115/120-121/147			1 987 <b>482 429</b>	→ 970
						1 987 <b>482 430</b>	← 935
	<b>2.0 BlueHDi, HDi</b>	09.11→	100/110/120/132			1 987 <b>482 429</b>	→ 970
						1 987 <b>482 430</b>	← 935

**Evasion [U60]**

	<b>1.8 i</b>	09.96-07.02	72-74			0 204 <b>102 521</b>	← 57
						0 204 <b>103 521</b>	
						0 204 <b>102 523</b>	→ 57
						0 204 <b>103 523</b>	
	<b>1.9 D Turbo</b>	10.94-07.02	66/67-68			0 986 <b>473 115</b>	← 57,11
						0 986 <b>474 115</b>	→ 57,11



◀ CITROEN Evasion [U60]								
2.0 HDi, i, i Turbo, i 16V	06.94-07.02	80/81/89-90/ 97-99/100/108-110				0986 473 115		57,11
						0986 474 115		57,11
2.1 D Turbo	04.96-07.02	80-81				0986 473 115		57,11
						0986 474 115		57,11
1.8 i	09.96-07.02	72-74				F 026 002 181		19,05
1.9 D Turbo	10.94-07.02	66/67-68				F 026 002 181		19,05
2.0 HDi, i	06.94-07.02	80/81/89-90				F 026 002 181		19,05
2.1 D Turbo	04.96-07.02	80-81				F 026 002 181		19,05
2.0 i Turbo	06.94-07.02	97-99/100/				0986 473 295		36
2.0 i 16V		108-110				0986 474 295		36
1.8 i	09.96-07.02	72-74				1987 477 565		500
				LLE		1987 477 568		1063
						1987 477 569		2286
				RLE		1987 477 568		1063
						1987 477 773		2368
1.9 D Turbo	10.94-07.02	66/67-68				1987 477 565		500
				LLE		1987 477 568		1063
						1987 477 569		2286
				RLE		1987 477 568		1063
						1987 477 773		2368
2.0 HDi	06.94-07.02	80/81/				1987 477 565		500
2.0 i		89-90			LLE	1987 477 568		1063
						1987 477 569		2286
				RLE		1987 477 568		1063
						1987 477 773		2368
2.0 i Turbo	06.94-07.02	97-99/100/				1987 477 565		500
2.0 i 16V		108-110			LLE	1987 477 524		2205
						1987 477 525		1255
2.1 D Turbo	04.96-07.02	80-81				1987 477 565		500
				LLE		1987 477 568		1063
						1987 477 569		2286
				RLE		1987 477 568		1063
						1987 477 773		2368
1.8 i	06.97-09.97	72-74	Org.-Nr. 7481→7601			0265 006 426 <sup>4</sup>		
	06.97-07.02	72-74	Org.-Nr. 7481→			0265 006 388 <sup>3</sup>		
	10.97-07.02	72-74	Org.-Nr. 7602→			0265 006 504 <sup>4</sup>		
1.9 D Turbo	06.97-09.97	66/67-68	Org.-Nr. 7481→7601			0265 006 426 <sup>4</sup>		
	06.97-07.02	66/67-68	Org.-Nr. 7481→			0265 006 388 <sup>3</sup>		
	10.97-07.02	66/67-68	Org.-Nr. 7602→			0265 006 504 <sup>4</sup>		
2.0 HDi	01.99-07.02	80/81				0265 006 388 <sup>3</sup>		
						0265 006 504 <sup>4</sup>		
2.0 i	06.97-09.97	89-90	Org.-Nr. 7481→7601			0265 006 426 <sup>4</sup>		
	06.97-07.02	89-90	Org.-Nr. 7481→			0265 006 388 <sup>3</sup>		
	10.97-07.02	89-90	Org.-Nr. 7602→			0265 006 504 <sup>4</sup>		
2.0 i Turbo	06.97-09.97	108-110	Org.-Nr. 7481→7601			0265 006 426 <sup>4</sup>		
	06.97-07.02	108-110	Org.-Nr. 7481→			0265 006 388 <sup>3</sup>		
	10.97-07.02	108-110	Org.-Nr. 7602→			0265 006 504 <sup>4</sup>		
2.0 i 16V	05.98-07.02	97-99/100				0265 006 388 <sup>3</sup>		
						0265 006 504 <sup>4</sup>		
2.1 D Turbo	06.97-09.97	80-81	Org.-Nr. 7481→7601			0265 006 426 <sup>4</sup>		
	06.97-07.02	80-81	Org.-Nr. 7481→			0265 006 388 <sup>3</sup>		
	10.97-07.02	80-81	Org.-Nr. 7602→			0265 006 504 <sup>4</sup>		

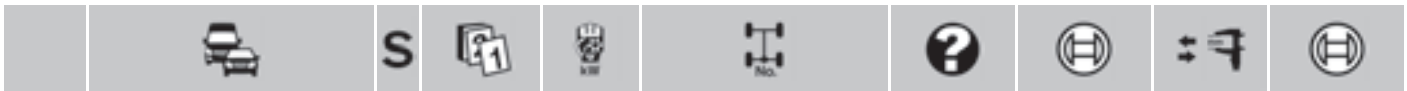

**Jumper**

	2.8 HDi 2.8 T	12.01-09.09	77/93		AIO,L03	0 986 473 161		← 40,4
						0 986 474 161		→ 40,4
					AMI,L02	0 986 473 984		← 45
						0 986 474 984		→ 45
					AMI,L03	0 986 473 985		← 48
						0 986 474 985		→ 48
					AMI,L03	0 986 473 987		← 40
						0 986 474 987		→ 40
					IBA,L02	0 986 473 163		← 48
						0 986 474 163		→ 48
					IBA,L03	0 986 473 162		← 40,4
		ABO	12.01-09.09	77/93	L03	0 986 473 995		← 44
						0 986 474 995		→ 44
		ABS	12.01-09.09	77/93	L03	0 986 134 016		← 44

	2.8 HDi 2.8 T	12.01-09.09	77/93		LOC	0 986 475 906		↔ 26,99
					L02	0 986 475 803		↔ 28,6
					L03	0 986 475 802		↔ 27
					254,L03	0 986 475 801		↔ 25,4

	2.8 HDi 2.8 T	12.01-09.09	77/93			0 986 473 996		← 46
						0 986 474 996		→ 46

	2.8 HDi 2.8 T	12.01-09.09	77/93	Fg.-Nr. 15445358→	LAB	0 265 006 405 <sup>4</sup>		
					RAB	0 265 006 406 <sup>4</sup>		

**Jumper [U5]**

	2.0 HDi 2.0 i	ABO	02.02-05.06	62/80	L03	0 986 473 995		← 44
						0 986 474 995		→ 44
		ABS	02.02-05.06	62/80	L03	0 986 134 016		← 44
						0 986 135 016		→ 44
	2.2 HDi	ABO	02.02-05.06	74	L03	0 986 473 995		← 44
						0 986 474 995		→ 44
		ABS	02.02-05.06	74	L03	0 986 134 016		← 44
						0 986 135 016		→ 44
	2.3 HDi	ABO	02.02-05.06	81	L03	0 986 473 995		← 44
						0 986 474 995		→ 44
		ABS	02.02-05.06	81	L03	0 986 134 016		← 44
						0 986 135 016		→ 44
	2.8 D Turbo 2.8 HDi	ABO	02.02-05.06	90/94/107	L03	0 986 473 995		← 44
						0 986 474 995		→ 44
		ABS	02.02-05.06	90/94/107	L03	0 986 134 016		← 44
						0 986 135 016		→ 44

	2.0 HDi, i 2.2 HDi 2.3 HDi 2.8 D Turbo, HDi	02.02-05.06	62/80		LOC	0 986 475 906		↔ 26,99
		02.02-05.06	74		LOC	0 986 475 906		↔ 26,99
		02.02-05.06	81		LOC	0 986 475 906		↔ 26,99
		02.02-05.06	90/94/107		LOC	0 986 475 906		↔ 26,99

	2.0 HDi 2.0 i	02.02-05.06	62/80			0 986 473 996		← 46
						0 986 474 996		→ 46



		S							
<b>CITROEN Jumper [U5]</b>									
	2.2 HDi	02.02-05.06	74			0986 473 996		←	46
				0986 474 996		→	46		
	2.3 HDi	02.02-05.06	81			0986 473 996		←	46
				0986 474 996		→	46		
	2.8 D Turbo 2.8 HDi	02.02-05.06	90/94/107			0986 473 996		←	46
				0986 474 996		→	46		
<b>Jumper [U6]</b>									
	2.0 HDi	02.02-05.06	62/80	AA	1987 482 003		↔	2715	
				AA,SBR	1987 482 003		↔	2715	
	2.0 HDi 2.0 i	02.02-05.06	62/80	AA	1987 477 114			1059	
				AA	1987 482 004			1170	
	2.0 i	02.02-05.06	62/80	AA	1987 482 003		↔	2715	
				AA,SBR	1987 482 003		↔	2715	
	2.2 HDi	02.02-05.06	74	AA	1987 477 114			1059	
				AA	1987 482 003		↔	2715	
	2.3 HDi	02.02-05.06	81	AA	1987 477 114			1059	
				AA	1987 482 003		↔	2715	
	2.8 D Turbo	02.02-05.06	90/94/107	AA	1987 482 003		↔	2715	
				AA,SBR	1987 482 003		↔	2715	
	2.8 D Turbo 2.8 HDi	02.02-05.06	90/94/107	AA	1987 477 114			1059	
				AA	1987 482 004			1170	
	2.8 HDi	02.02-05.06	90/94/107	AA	1987 482 003		↔	2715	
				AA,SBR	1987 482 003		↔	2715	
				AA,STB	1987 477 263		↔	2827	
				AA,STB	1987 477 263		↔	2827	
<b>Jumper [U9]</b>									
	3.0 HDi	03.11→	130			0986 134 052		←	48
				0986 135 052		→	48		
	3.0 HDi	03.11→	130	SVN	1987 482 214		↔	1485	
				SVN	1987 482 213		↔	1390	
				TW	1987 482 447			2910	
					1987 482 450			1908	
	2.2 HDi	06.06→	74/81/88/ 95/96/110			0986 134 052		←	48
				0986 135 052		→	48		
	3.0 HDi	06.06→	107/115/ 116			0986 134 052		←	48
				0986 135 052		→	48		
	2.2 HDi	06.06→	74/81/88/ 95	SVN	1987 482 214		↔	1485	
				SVN	1987 482 213		↔	1390	
				TW	1987 482 447			2910	
					1987 482 450			1908	

		S										
2.2 HDi		06.11→	96		MPR,TW	1 987 482 447	2910					
						1 987 482 450	1908					
						MPR,TW	1 987 482 447	2910				
							1 987 482 450	1908				
						SVN	1 987 482 214	↔ 1485				
						SVN	1 987 482 213	↔ 1390				
						110	SVN	1 987 482 214	↔ 1485			
							SVN	1 987 482 213	↔ 1390			
							TW	1 987 482 447	2910			
								1 987 482 450	1908			
3.0 HDi		06.06-12.11	116		MPR,TW	1 987 482 447	2910					
							1 987 482 450	1908				
						MPR,TW	1 987 482 447	2910				
							1 987 482 450	1908				
						SVN	1 987 482 214	↔ 1485				
						SVN	1 987 482 213	↔ 1390				
						01.10→	107/115	SVN	1 987 482 214	↔ 1485		
							SVN	1 987 482 213	↔ 1390			
							TW	1 987 482 447	2910			
								1 987 482 450	1908			
<b>Jumper [23]</b>												
	1.9 D	02.94-02.02	51/66-68		AIO,L03	0 986 473 161		← 40,4				
	1.9 D Turbo					0 986 474 161		→ 40,4				
					AMI,L02	0 986 473 984		← 45				
						0 986 474 984		→ 45				
					AMI,L03	0 986 473 985		← 48				
						0 986 474 985		→ 48				
					AMI,L03	0 986 473 987		← 40				
						0 986 474 987		→ 40				
					IBA,L02	0 986 473 163		← 48				
						0 986 474 163		→ 48				
					IBA,L03	0 986 473 162		← 40,4				
2.0		02.94-02.02	62/79/80		AIO,L03	0 986 473 161		← 40,4				
2.0 HDi						0 986 474 161		→ 40,4				
2.0 i					AMI,L02	0 986 473 984		← 45				
						0 986 474 984		→ 45				
					AMI,L03	0 986 473 985		← 48				
						0 986 474 985		→ 48				
					AMI,L03	0 986 473 987		← 40				
						0 986 474 987		→ 40				
					IBA,L02	0 986 473 163		← 48				
						0 986 474 163		→ 48				
					IBA,L03	0 986 473 162		← 40,4				
2.5 D		02.94-02.02	63/76/79		AIO,L03	0 986 473 161		← 40,4				
2.5 D Turbo						0 986 474 161		→ 40,4				
2.5 TDi					AMI,L02	0 986 473 984		← 45				
						0 986 474 984		→ 45				
					AMI,L03	0 986 473 985		← 48				
						0 986 474 985		→ 48				
					AMI,L03	0 986 473 987		← 40				
						0 986 474 987		→ 40				
					IBA,L02	0 986 473 163		← 48				
						0 986 474 163		→ 48				
					IBA,L03	0 986 473 162		← 40,4				
2.8 D		01.99-02.02	64/90/94		AIO,L03	0 986 473 161		← 40,4				
2.8 D Turbo						0 986 474 161		→ 40,4				
2.8 HDi					AMI,L02	0 986 473 984		← 45				
						0 986 474 984		→ 45				
					AMI,L03	0 986 473 985		← 48				
						0 986 474 985		→ 48				





		S							
	◀ CITROEN Jumper [23]								
2.8 D	01.99-02.02	64/90/94				AMI,L03	0986 473 987		← 40
2.8 D Turbo							0986 474 987		→ 40
2.8 HDi						IBA,L02	0986 473 163		← 48
							0986 474 163		→ 48
						IBA,L03	0986 473 162		← 40,4
	1.9 D	02.94-02.02	51/66-68			L02	0986 475 803		↔ 28,6
	1.9 D Turbo					L03	0986 475 802		↔ 27
						254,L03	0986 475 801		↔ 25,4
	2.0	02.94-02.02	62/79/80			L02	0986 475 803		↔ 28,6
	2.0 HDi					L03	0986 475 802		↔ 27
	2.0 i					254,L03	0986 475 801		↔ 25,4
	2.5 D	02.94-02.02	63/76/79			L02	0986 475 803		↔ 28,6
	2.5 D Turbo					L03	0986 475 802		↔ 27
	2.5 TDi					254,L03	0986 475 801		↔ 25,4
	2.8 D	01.99-02.02	64/90/94			L02	0986 475 803		↔ 28,6
	2.8 D Turbo					L03	0986 475 802		↔ 27
	2.8 HDi					254,L03	0986 475 801		↔ 25,4
	2.5 D	02.94-02.02	63/79				0986 473 996		← 46
	2.5 TDi						0986 474 996		→ 46
	1.9 D	02.94-02.02	51/66-68			AA	1987 482 005		4095
	1.9 D Turbo					LLE	1987 477 114		1059
						RLE	1987 482 046		1137
						Fg.-Nr. →16158427	NAA,NNC	1987 477 113	3025
							NAA,VFC	1987 477 115	3045
						Fg.-Nr. 16158428→	NAA,NNC	1987 477 262	2806
							NAA,VFC	1987 482 006	2827
	2.0	02.94-02.02	79/80			LLE	1987 477 114		1059
	2.0 i					RLE	1987 482 046		1137
						Fg.-Nr. →16158427	NNC	1987 477 113	3025
							VFC	1987 477 115	3045
						Fg.-Nr. 16158428→	NNC	1987 477 262	2806
							VFC	1987 482 006	2827
	2.0 HDi	03.01-02.02	62			AA	1987 482 005		4095
						LLE	1987 477 114		1059
						RLE	1987 482 046		1137
						Fg.-Nr. →16158427	NAA,NNC	1987 477 113	3025
							NAA,VFC	1987 477 115	3045
						Fg.-Nr. 16158428→	NAA,NNC	1987 477 262	2806
							NAA,VFC	1987 482 006	2827
	2.5 D	02.94-02.02	63/76/79			AA	1987 482 005		4095
	2.5 D Turbo					LLE	1987 477 114		1059
	2.5 TDi					RLE	1987 482 046		1137
						Fg.-Nr. →16158427	NAA,NNC	1987 477 113	3025
							NAA,VFC	1987 477 115	3045
						Fg.-Nr. 16158428→	NAA,NNC	1987 477 262	2806
							NAA,VFC	1987 482 006	2827
	2.8 D	01.99-02.02	64/90/94			AA	1987 482 005		4095
	2.8 D Turbo					LLE	1987 477 114		1059
	2.8 HDi					RLE	1987 482 046		1137
						Fg.-Nr. →16158427	NAA,NNC	1987 477 113	3025
							NAA,VFC	1987 477 115	3045
						Fg.-Nr. 16158428→	NAA,NNC	1987 477 262	2806
							NAA,VFC	1987 482 006	2827





	1.9 D	02.94-04.00	51/66-68	Fg.-Nr. 15445358→		0 265 006 427 <sup>3</sup>	
	1.9 D Turbo	02.94-02.02	51/66-68	Fg.-Nr. 15445358→	LAB RAB	0 265 006 405 <sup>4</sup> 0 265 006 406 <sup>4</sup>	
	2.0	02.94-04.00	79/80	Fg.-Nr. 15445358→		0 265 006 427 <sup>3</sup>	
	2.0 i	02.94-02.02	79/80	Fg.-Nr. 15445358→	LAB RAB	0 265 006 405 <sup>4</sup> 0 265 006 406 <sup>4</sup>	
	2.0 HDi	03.01-02.02	62	Fg.-Nr. 15445358→	LAB RAB	0 265 006 405 <sup>4</sup> 0 265 006 406 <sup>4</sup>	
	2.5 D	02.94-04.00	63/76/79	Fg.-Nr. 15445358→		0 265 006 427 <sup>3</sup>	
	2.5 D Turbo	02.94-02.02	63/76/79	Fg.-Nr. 15445358→	LAB	0 265 006 405 <sup>4</sup>	
	2.5 TDi				RAB	0 265 006 406 <sup>4</sup>	
	2.8 D	01.99-04.00	64/90	Fg.-Nr. 15445358→		0 265 006 427 <sup>3</sup>	
	2.8 D Turbo	01.99-02.02	64/90	Fg.-Nr. 15445358→	LAB RAB	0 265 006 405 <sup>4</sup> 0 265 006 406 <sup>4</sup>	
	2.8 HDi	09.00-02.02	94	Fg.-Nr. 15445358→	LAB RAB	0 265 006 405 <sup>4</sup> 0 265 006 406 <sup>4</sup>	

**Jumpy [G9]**

	1.6 HDi	02.07-04.11	66	Org.-Nr. →12571	4SB	0 986 134 345	↔ 48
						0 986 135 345	↔ 48
	2.0 HDi	02.07-04.11	88/100/103/120	Org.-Nr. →12571		0 986 134 345	↔ 48
	2.0 16V					0 986 135 345	↔ 48

	1.6 HDi	02.07→	66			0 986 475 950	↔ 22

	1.6 HDi	02.07→	66			0 986 134 346	↔ 41
						0 986 135 346	↔ 41
	2.0 HDi	02.07→	72/88/94/100/103/120			0 986 134 346	↔ 41
	2.0 16V					0 986 135 346	↔ 41

	1.6 HDi	02.07-09.09	66	Org.-Nr. →11986	STB	1 987 482 118	↔ 1495
		02.07→	66		4SB,FKR 4SB,FLR	1 987 482 007 1 987 482 008	↔ 1614 ↔ 1737
	2.0 HDi	02.07→	72/88/94/100/103/120		FKR FLR	1 987 482 007 1 987 482 008	↔ 1614 ↔ 1737
	2.0 16V	02.07→	72/88/94/100/103/120		FKR FLR	1 987 482 007 1 987 482 008	↔ 1614 ↔ 1737

	1.6 HDi	02.07→	66			0 265 007 790 <sup>3</sup>	
						0 265 007 791 <sup>4</sup>	
	2.0 HDi	02.07→	72/88/94/100/103/120			0 265 007 790 <sup>3</sup>	
	2.0 16V					0 265 007 791 <sup>4</sup>	

**Jumpy [U64]**

	1.6 i	10.95-01.07	58		BSY	0 204 102 521	↔ 57	0 204 100 316 <sup>8</sup>
						0 204 103 521	↔	0 204 104 177 <sup>7</sup>
						0 204 102 523	↔ 57	0 204 100 316 <sup>8</sup>
						0 204 103 523	↔	
					GIR	0 986 473 115	↔ 57,11	
						0 986 474 115	↔ 57,11	



		S									
◀ CITROEN Jumpy [U64]											
1.9 D	1.9 D Turbo	10.95-01.07	50-52/66/ 67-68	BSY	0 204 102 521	← 57	0 204 100 316 <sup>8</sup>				
					0 204 103 521		0 204 104 177 <sup>7</sup>				
					0 204 102 523	→ 57	0 204 100 316 <sup>8</sup>				
					0 204 103 523						
				GIR	0 986 473 115	← 57,11					
					0 986 474 115	→ 57,11					
2.0 HDi	2.0 i	10.99-01.07	70/80/81/ 100	BSY	0 204 102 521	← 57	0 204 100 316 <sup>8</sup>				
					0 204 103 521		0 204 104 177 <sup>7</sup>				
					0 204 102 523	→ 57	0 204 100 316 <sup>8</sup>				
					0 204 103 523						
				GIR	0 986 473 115	← 57,11					
					0 986 474 115	→ 57,11					
	1.6 i	10.95-01.07	58		F 026 002 181	↔ 19,05					
	1.9 D, D Turbo	10.95-01.07	50-52/66/67-68		F 026 002 181	↔ 19,05					
	2.0 HDi, i	10.99-01.07	70/80/81/100		F 026 002 181	↔ 19,05					
	1.6 i	10.95-01.07	58		FKR	1 987 477 565	500				
					FLR	1 987 477 774	903				
					LLE	1 987 477 568	← 1063				
						1 987 477 569	→ 2286				
	RLE	1 987 477 568	← 1063								
		1 987 477 773	→ 2368								
	1.9 D	1.9 D Turbo	10.95-01.07	50-52/66/ 67-68		FKR	1 987 477 565	500			
						FLR	1 987 477 774	903			
						LLE	1 987 477 568	← 1063			
							1 987 477 569	→ 2286			
	RLE	1 987 477 568	← 1063								
		1 987 477 773	→ 2368								
2.0 HDi	2.0 i	10.99-01.07	70/80/81/ 100		FKR	1 987 477 565	500				
					FLR	1 987 477 774	903				
					LLE	1 987 477 568	← 1063				
						1 987 477 569	→ 2286				
RLE	1 987 477 568	← 1063									
	1 987 477 773	→ 2368									
	1.6 i	06.97-09.97	58	Org.-Nr. 7481→7601	0 265 006 426 <sup>4</sup>						
		06.97-08.01	58	Org.-Nr. 7481→9050	0 265 006 388 <sup>3</sup>						
		10.97-08.01	58	Org.-Nr. 7602→9050	0 265 006 504 <sup>4</sup>						
		09.01-01.07	58	Org.-Nr. 9051→	0 265 006 730 <sup>3</sup>						
	1.9 D		06.97-09.97	50-52	Org.-Nr. 7481→7601	0 265 006 426 <sup>4</sup>					
			06.97-08.01	50-52	Org.-Nr. 7481→9050	0 265 006 388 <sup>3</sup>					
			10.97-08.01	50-52	Org.-Nr. 7602→9050	0 265 006 504 <sup>4</sup>					
			10.98-08.01	51		0 265 006 388 <sup>3</sup>					
				09.01-01.07	50-52	Org.-Nr. 9051→	0 265 006 730 <sup>3</sup>				
							0 265 006 731 <sup>4</sup>				
					52		0 265 006 730 <sup>3</sup>				
							0 265 006 731 <sup>4</sup>				
	1.9 D Turbo		06.97-09.97	66/67-68	Org.-Nr. 7481→7601	0 265 006 426 <sup>4</sup>					
			06.97-08.01	66/67-68	Org.-Nr. 7481→9050	0 265 006 388 <sup>3</sup>					
			10.97-08.01	66/67-68	Org.-Nr. 7602→9050	0 265 006 504 <sup>4</sup>					
			09.01-01.07	66/67-68	Org.-Nr. 9051→	0 265 006 730 <sup>3</sup>					
2.0 HDi	2.0 i	10.99-08.01	70/80/81/ 100	Org.-Nr. →9050	0 265 006 388 <sup>3</sup>						
		09.01-01.07	70/80/81/ 100	Org.-Nr. 9051→	0 265 006 730 <sup>3</sup>						
					0 265 006 731 <sup>4</sup>						

		S								
<b>Nemo [A9]</b>										
	1.3 HDi	08.10→	55					0 986 475 936	↔ 20,64	
	1.4, HDi	02.08→	50/54					0 986 475 936	↔ 20,64	
	1.3 HDi	08.10→	55					1 987 482 207	→ 1710	
								1 987 482 208	← 1677	
	1.4	02.08→	54					1 987 482 205	→ 1695	
								1 987 482 206	← 1662	
	1.4 HDi	02.08→	50					1 987 482 207	→ 1710	
								1 987 482 208	← 1677	
<b>Picasso</b>										
	1.6 i	06.02-02.07	78					BO 0 204 004 451	← 54	
								0 204 103 971		
								0 204 004 452	→ 54	
								LUC 0 986 473 026	← 54	
								0 986 474 026	→ 54	
	1.6 i	06.02-02.07	78					0 986 475 836	↔ 22,2	
	1.6 i	06.02-02.07	78					1 987 477 590	← 1773	
								1 987 477 591	→ 1864	
	1.6 i	06.02-02.07	78					0 265 006 389 <sup>3</sup>		
								0 265 006 659 <sup>4</sup>		
<b>Saxo [S8]</b>										
	1.0 i	02.96-09.03	33/37					3LO ATE 0 986 471 885	← 45	
								0 986 473 885		
								0 986 471 886	→ 45	
								0 986 473 886		
								4LO BSY 0 204 102 289	← 48	0 204 100 062 <sup>B</sup>
								0 986 473 103		0 204 104 039 <sup>7</sup>
								0 204 102 290	→ 48	0 204 100 062 <sup>B</sup>
								0 986 474 103		
	1.1 i	02.96-09.03	40-44					3LO ATE 0 986 471 885	← 45	
								0 986 473 885		
								0 986 471 886	→ 45	
								0 986 473 886		
								4LO BSY 0 204 102 289	← 48	0 204 100 062 <sup>B</sup>
								0 986 473 103		0 204 104 039 <sup>7</sup>
								0 204 102 290	→ 48	0 204 100 062 <sup>B</sup>
								0 986 474 103		
	1.4 i	02.96-09.03	55					3LO ATE 0 986 471 885	← 45	
								0 986 473 885		
								0 986 471 886	→ 45	
								0 986 473 886		



		S							
◀ CITROEN Saxo [S8]									
1.4 i	02.96-09.03	55	4LO	BSY	0 204 102 289	← 48	0 204 100 062 <sup>8</sup>		
					0 986 473 103		0 204 104 039 <sup>7</sup>		
					0 204 102 290	→ 48	0 204 100 062 <sup>8</sup>		
					0 986 474 103				
1.5 D	07.96-09.03	40/42	3LO	ATE	0 986 471 885	← 45			
					0 986 473 885				
					0 986 471 886	→ 45			
			4LO	BSY	0 204 102 289	← 48	0 204 100 062 <sup>8</sup>		
					0 986 473 103		0 204 104 039 <sup>7</sup>		
					0 204 102 290	→ 48	0 204 100 062 <sup>8</sup>		
1.6 i	02.96-09.03	65-66/74	3LO,INB		0 986 471 885	← 45			
					0 986 473 885				
					0 986 471 886	→ 45			
			4LO,INB		0 986 473 887		← 48		
					0 986 473 888		→ 48		
			4LO,INB		0 204 102 289	← 48	0 204 100 062 <sup>8</sup>		
					0 986 473 103		0 204 104 039 <sup>7</sup>		
					0 204 102 290	→ 48	0 204 100 062 <sup>8</sup>		
					0 986 474 103				
					0 986 473 887		← 48		
			0 986 473 888		→ 48				
1.6 i 16V	07.96-09.03	87-88			0 986 473 887		← 48		
					0 986 473 888		→ 48		
Electrique	01.97-09.03	11-20	3LO	BSY	F 026 002 228	← 19			
					F 026 002 229	→ 19			
	A BO	01.97-09.03	11-20	4LO	BRB, BSY	F 026 002 175	↔ 19		
1.0 i	02.96-09.03	33/37	3LO	BSY	F 026 002 228	← 19			
					F 026 002 229	→ 19			
	A BO	02.96-09.03	33/37	4LO	BRB, BSY	F 026 002 222	← 19		
						F 026 002 223	→ 19		
1.1 i	02.96-01.99	40-44	Org.-Nr. →8095	4LO,GIM	0 986 475 797	↔ 20,6			
					0 204 102 289	← 19			
	02.96-09.03	40-44		3LO	BSY	F 026 002 228	← 19		
						F 026 002 229	→ 19		
	02.99-09.03	40-44	Org.-Nr. 8096→	4LO,GIM		0 986 475 833	↔ 20,6		
						F 026 002 228	← 19		
	03.00-09.03	44		3LO	BSY	F 026 002 228	← 19		
						F 026 002 229	→ 19		
					Org.-Nr. 8096→	4LO,GIM	0 986 475 833	↔ 20,6	
A BO	02.96-09.03	40-44	4LO	BRB, BSY	F 026 002 222	← 19			
					F 026 002 223	→ 19			
1.4 i	02.96-01.99	55	Org.-Nr. →8095	4LO,GIM	0 986 475 797	↔ 20,6			
					0 204 102 289	← 19			
	02.96-09.03	55		3LO	BSY	F 026 002 228	← 19		
						F 026 002 229	→ 19		
	02.99-09.03	55	Org.-Nr. 8096→	4LO,GIM		0 986 475 833	↔ 20,6		
A BO	02.96-09.03	55	4LO	BRB, BSY	F 026 002 222	← 19			
					F 026 002 223	→ 19			
1.5 D	07.96-01.99	40/42	Org.-Nr. →8095	4LO,GIM	0 986 475 797	↔ 20,6			
					0 204 102 289	← 19			
	07.96-09.03	40/42		3LO	BSY	F 026 002 228	← 19		
						F 026 002 229	→ 19		
	02.99-09.03	40/42	Org.-Nr. 8096→	4LO,GIM		0 986 475 833	↔ 20,6		
	A BO	07.96-09.03	40/42	4LO	BRB, BSY	F 026 002 222	← 19		
					F 026 002 223	→ 19			
1.6 i	02.96-01.99	65-66	Org.-Nr. →8095	4LO,GIM	0 986 475 797	↔ 20,6			
					0 204 102 289	← 19			
	02.96-09.03	65-66		3LO	BSY	F 026 002 228	← 19		
						F 026 002 229	→ 19		
	02.99-09.03	65-66	Org.-Nr. 8096→	4LO,GIM		0 986 475 833	↔ 20,6		
	06.00-09.03	74		3LO	BSY	F 026 002 228	← 19		
						F 026 002 229	→ 19		
			Org.-Nr. 8096→	4LO,GIM	0 986 475 833	↔ 20,6			

		S							
1.6i		ABO	02.96-09.03	65-66/74	4LO	BRB, BSY	F 026 002 222 F 026 002 223	← 19 → 19	
1.0i			02.96-09.03	37			0 204 102 075 0 986 134 098 0 204 102 077 0 204 103 077 0 986 135 098	← 30 → 30	0 204 100 062 <sup>B</sup> 0 204 104 068 <sup>9</sup> 0 204 100 062 <sup>B</sup>
1.1i			03.00-09.03	44			0 204 102 075 0 986 134 098 0 204 102 077 0 204 103 077 0 986 135 098	← 30 → 30	0 204 100 062 <sup>B</sup> 0 204 104 068 <sup>9</sup> 0 204 100 062 <sup>B</sup>
1.4i			02.96-09.03	55			0 204 102 075 0 986 134 098 0 204 102 077 0 204 103 077 0 986 135 098	← 30 → 30	0 204 100 062 <sup>B</sup> 0 204 104 068 <sup>9</sup> 0 204 100 062 <sup>B</sup>
1.5D			07.96-09.03	42			0 204 102 075 0 986 134 098 0 204 102 077 0 204 103 077 0 986 135 098	← 30 → 30	0 204 100 062 <sup>B</sup> 0 204 104 068 <sup>9</sup> 0 204 100 062 <sup>B</sup>
1.6i 1.6i 16V			02.96-09.03	65-66/74/ 87-88			0 204 102 075 0 986 134 098 0 204 102 077 0 204 103 077 0 986 135 098	← 30 → 30	0 204 100 062 <sup>B</sup> 0 204 104 068 <sup>9</sup> 0 204 100 062 <sup>B</sup>
1.0i			02.96-09.03	33/37			1 987 477 442	↔ 1442	
1.1i			02.96-09.03	40-44			1 987 477 442	↔ 1442	
1.4i			02.96-09.03	55			1 987 477 442	↔ 1442	
1.5D			07.96-09.03	40/42			1 987 477 442	↔ 1442	
1.6i			02.96-09.03	65-66/74	STB		1 987 477 442	↔ 1442	
1.6i 16V			07.96-09.03	87-88	4SB		1 987 477 574	↔ 1505	
1.1i			02.96-09.03	40-44			0 986 594 020 <sup>3</sup>		
1.4i			02.96-09.03	55			0 986 594 020 <sup>3</sup>		
1.5D			07.96-09.03	40/42			0 986 594 020 <sup>3</sup>		
1.6i, i 16V			02.96-09.03	65-66/74/87-88			0 986 594 020 <sup>3</sup>		
<b>Xantia Break [X1]</b>									
1.8i		ABO	09.95-10.95	70-71/ 74-76	Org.-Nr. →6901		0 204 102 279 0 986 473 289 0 204 102 280 0 986 474 289	← 54 → 54	0 204 100 125 <sup>B</sup> 0 204 104 057 <sup>7</sup> 0 204 100 125 <sup>B</sup>
			11.95-01.98	70-71/ 74-76	Org.-Nr. 6902→		0 204 102 194 0 986 473 289 0 204 102 196 0 986 474 289	← 54 → 54	0 204 100 125 <sup>B</sup> 0 204 104 057 <sup>7</sup> 0 204 100 125 <sup>B</sup>
			04.97-01.98	66			0 204 102 194 0 986 473 289 0 204 102 196 0 986 474 289	← 54 → 54	0 204 100 125 <sup>B</sup> 0 204 104 057 <sup>7</sup> 0 204 100 125 <sup>B</sup>
1.8i 1.8i 16V		ABS	09.95-05.97	66/70-71/ 74-76/81	Org.-Nr. →7482		0 204 102 186 0 986 473 315 0 204 102 188 0 986 474 315	← 57 → 57	0 204 100 125 <sup>B</sup> 0 204 104 051 <sup>7</sup> 0 204 100 125 <sup>B</sup>









































<b>CITROEN Xantia Break [X1]</b>								
<b>1.8 i</b>	ABS	06.97-01.98	66/70-71/ 74-76/81	Org.-Nr. 7483→		0 204 <b>102 194</b>	← 54	0 204 <b>100 125</b> <sup>8</sup>
						0 986 <b>473 289</b>		0 204 <b>104 057</b> <sup>7</sup>
<b>1.8 i 16V</b>						0 204 <b>102 196</b>	→ 54	0 204 <b>100 125</b> <sup>8</sup>
						0 986 <b>474 289</b>		
<b>1.8 i 16V</b>	ABO	04.97-01.98	81			0 204 <b>102 194</b>	← 54	0 204 <b>100 125</b> <sup>8</sup>
						0 986 <b>473 289</b>		0 204 <b>104 057</b> <sup>7</sup>
<b>1.8 i 16V</b>						0 204 <b>102 196</b>	→ 54	0 204 <b>100 125</b> <sup>8</sup>
						0 986 <b>474 289</b>		
<b>1.9 D Turbo</b>		09.95-01.98	55/66/ 67-68			0 204 <b>102 186</b>	← 57	0 204 <b>100 125</b> <sup>8</sup>
						0 986 <b>473 315</b>		0 204 <b>104 051</b> <sup>7</sup>
<b>1.9 D Turbo</b>						0 204 <b>102 188</b>	→ 57	0 204 <b>100 125</b> <sup>8</sup>
						0 986 <b>474 315</b>		
<b>2.0 i Turbo</b>		09.95-01.98	108-110			0 204 <b>102 190</b>	← 57	0 204 <b>104 051</b> <sup>7</sup>
						0 986 <b>473 313</b>		
<b>2.0 i Turbo</b>						0 204 <b>102 192</b>	→ 57	0 204 <b>104 051</b> <sup>7</sup>
						0 986 <b>474 313</b>		
<b>2.0 i</b>		09.95-01.98	89-90/ 91-92/97			0 204 <b>102 186</b>	← 57	0 204 <b>100 125</b> <sup>8</sup>
						0 986 <b>473 315</b>		0 204 <b>104 051</b> <sup>7</sup>
<b>2.0 i 16V</b>						0 204 <b>102 188</b>	→ 57	0 204 <b>100 125</b> <sup>8</sup>
						0 986 <b>474 315</b>		
<b>2.1 D Turbo</b>		06.96-01.98	80-81			0 204 <b>102 190</b>	← 57	0 204 <b>104 051</b> <sup>7</sup>
						0 986 <b>473 313</b>		
<b>2.1 D Turbo</b>						0 204 <b>102 192</b>	→ 57	0 204 <b>104 051</b> <sup>7</sup>
						0 986 <b>474 313</b>		
<b>1.8 i</b>		09.95-01.98	66/70-71/74-76/81			0 986 <b>473 206</b>	↔ 36	
						0 986 <b>474 206</b>	↔ 36	
<b>1.8 i 16V</b>		04.97-01.98	66/70-71/74-76/81			0 986 <b>473 206</b>	↔ 36	
						0 986 <b>474 206</b>	↔ 36	
<b>1.9 D Turbo</b>		09.95-01.98	55/66/67-68			0 986 <b>473 206</b>	↔ 36	
						0 986 <b>474 206</b>	↔ 36	
<b>2.0 i</b>		09.95-01.98	89-90/91-92/97/108-110			0 986 <b>473 206</b>	↔ 36	
						0 986 <b>474 206</b>	↔ 36	
<b>2.0 i Turbo</b>		09.95-01.98	89-90/91-92/97/108-110			0 986 <b>473 206</b>	↔ 36	
						0 986 <b>474 206</b>	↔ 36	
<b>2.0 i 16V</b>		09.95-01.98	89-90/91-92/97/108-110			0 986 <b>473 206</b>	↔ 36	
						0 986 <b>474 206</b>	↔ 36	
<b>2.1 D Turbo</b>		06.96-01.98	80-81			0 986 <b>473 206</b>	↔ 36	
						0 986 <b>474 206</b>	↔ 36	
<b>1.8 i</b>		09.95-01.98	66/70-71/ 74-76/81	AG		1 987 <b>477 439</b>	← 1262	
						1 987 <b>477 440</b>	→ 1333	
<b>1.8 i 16V</b>				GS		1 987 <b>477 440</b>	→ 1333	
						1 987 <b>477 441</b>	← 1313	
<b>1.9 D Turbo</b>		09.95-01.98	55/66/ 67-68	AG		1 987 <b>477 439</b>	← 1262	
						1 987 <b>477 440</b>	→ 1333	
<b>1.9 D Turbo</b>				GS		1 987 <b>477 440</b>	→ 1333	
						1 987 <b>477 441</b>	← 1313	
<b>2.0 i</b>		09.95-01.98	89-90/ 91-92/97/	AG		1 987 <b>477 439</b>	← 1262	
						1 987 <b>477 440</b>	→ 1333	
<b>2.0 i Turbo</b>				GS		1 987 <b>477 440</b>	→ 1333	
						1 987 <b>477 441</b>	← 1313	
<b>2.0 i 16V</b>				GS		1 987 <b>477 440</b>	→ 1333	
						1 987 <b>477 441</b>	← 1313	
<b>2.1 D Turbo</b>		06.96-01.98	80-81	AG		1 987 <b>477 439</b>	← 1262	
						1 987 <b>477 440</b>	→ 1333	
<b>2.1 D Turbo</b>				GS		1 987 <b>477 440</b>	→ 1333	
						1 987 <b>477 441</b>	← 1313	
<b>1.8 i</b>		09.95-10.97	66/70-71/ 74-76/81	Org.-Nr. →7631		0 986 <b>594 021</b> <sup>4</sup>		
						<b>1.8 i 16V</b>		

		S							
<b>1.8i</b>		11.97-01.98	66/70-71/	Org.-Nr. 7632→			0 986 594 019 <sup>4</sup>		
<b>1.8i 16V</b>			74-76/81						
<b>1.9D Turbo</b>		09.95-12.96	67-68	Org.-Nr. →7631			0 986 594 021 <sup>4</sup>		
		09.95-10.97	55/66	Org.-Nr. →7631			0 986 594 021 <sup>4</sup>		
		11.97-01.98	55/66	Org.-Nr. 7632→			0 986 594 019 <sup>4</sup>		
<b>2.0i</b>		09.95-10.97	89-90/	Org.-Nr. →7631			0 986 594 021 <sup>4</sup>		
<b>2.0i Turbo</b>			91-92/97/						
<b>2.0i 16V</b>			108-110						
		11.97-01.98	89-90/	Org.-Nr. 7632→			0 986 594 019 <sup>4</sup>		
			91-92/97/						
			108-110						
<b>2.1D Turbo</b>		06.96-10.97	80-81	Org.-Nr. →7631			0 986 594 021 <sup>4</sup>		
		11.97-01.98	80-81	Org.-Nr. 7632→			0 986 594 019 <sup>4</sup>		
<b>Xantia Break [X2]</b>									
	<b>1.8i</b>	12.97-12.01	66/81				0 204 102 194	← 54	0 204 100 125 <sup>B</sup>
	<b>1.8i 16V</b>						0 986 473 289		0 204 104 057 <sup>7</sup>
							0 204 102 196	→ 54	0 204 100 125 <sup>B</sup>
							0 986 474 289		
	<b>1.9D Turbo</b>	12.97-12.01	55				0 204 102 186	← 57	0 204 100 125 <sup>B</sup>
							0 986 473 315		0 204 104 051 <sup>7</sup>
							0 204 102 188	→ 57	0 204 100 125 <sup>B</sup>
							0 986 474 315		
			66		AG		0 204 102 594	← 60	
							0 204 103 594		
							0 204 102 595	→ 60	
							0 204 103 595		
					GS		0 204 102 186	← 57	0 204 100 125 <sup>B</sup>
							0 986 473 315		0 204 104 051 <sup>7</sup>
							0 204 102 188	→ 57	0 204 100 125 <sup>B</sup>
							0 986 474 315		
	<b>2.0</b>	12.97-12.01	89-90/				0 204 102 186	← 57	0 204 100 125 <sup>B</sup>
	<b>2.0i 16V</b>		97-99				0 986 473 315		0 204 104 051 <sup>7</sup>
							0 204 102 188	→ 57	0 204 100 125 <sup>B</sup>
							0 986 474 315		
	<b>2.0 HDi</b>	10.98-12.01	81				0 204 102 594	← 60	
							0 204 103 594		
							0 204 102 595	→ 60	
							0 204 103 595		
		03.99-12.01	66				0 204 102 186	← 57	0 204 100 125 <sup>B</sup>
							0 986 473 315		0 204 104 051 <sup>7</sup>
							0 204 102 188	→ 57	0 204 100 125 <sup>B</sup>
							0 986 474 315		
	<b>2.0i Turbo</b>	12.97-10.98	108-110	Org.-Nr. →8000			0 204 102 190	← 57	0 204 104 051 <sup>7</sup>
							0 986 473 313		
							0 204 102 192	→ 57	0 204 104 051 <sup>7</sup>
							0 986 474 313		
		11.98-12.01	108-110	Org.-Nr. 8001→			0 204 102 594	← 60	
							0 204 103 594		
							0 204 102 595	→ 60	
							0 204 103 595		
	<b>2.1D Turbo</b>	12.97-10.98	80-81	Org.-Nr. →8000			0 204 102 190	← 57	0 204 104 051 <sup>7</sup>
							0 986 473 313		
							0 204 102 192	→ 57	0 204 104 051 <sup>7</sup>
							0 986 474 313		
		11.98-12.01	80-81	Org.-Nr. 8001→			0 204 102 594	← 60	
							0 204 103 594		
							0 204 102 595	→ 60	
							0 204 103 595		





		S							
	◀ CITROEN Xantia Break [X2]								
	3.0 i	01.98-12.01	140				0 204 102 594	← 60	
							0 204 103 594		
							0 204 102 595	→ 60	
							0 204 103 595		
	1.8 i	12.97-12.01	66/81				0 986 473 206	↔ 36	
	1.8 i 16V						0 986 474 206	↔ 36	
	1.9 D Turbo	12.97-12.01	55/66				0 986 473 206	↔ 36	
							0 986 474 206	↔ 36	
	2.0, HDi, i Turbo, i 16V	12.97-12.01	66/81/89-90/97-99/108-110				0 986 473 206	↔ 36	
							0 986 474 206	↔ 36	
	2.1 D Turbo	12.97-12.01	80-81				0 986 473 206	↔ 36	
							0 986 474 206	↔ 36	
	3.0 i	01.98-12.01	140				0 986 473 206	↔ 36	
							0 986 474 206	↔ 36	
	1.8 i	12.97-12.01	66		GS		1 987 477 439	← 1262	
							1 987 477 440	→ 1333	
	1.8 i 16V	12.97-12.01	81		AG		1 987 477 440	→ 1333	
					GS		1 987 482 115	← 1285	
							1 987 477 439	← 1262	
							1 987 477 440	→ 1333	
	1.9 D Turbo	12.97-12.01	55		GS		1 987 477 439	← 1262	
							1 987 477 440	→ 1333	
			66		AG		1 987 477 440	→ 1333	
							1 987 482 115	← 1285	
					GS		1 987 477 439	← 1262	
							1 987 477 440	→ 1333	
	2.0	12.97-12.01	89-90	Get.-Nr. AI4			1 987 477 440	→ 1333	
				Get.-Nr. HP20			1 987 482 115	← 1285	
							1 987 477 440	→ 1333	
							1 987 477 441	← 1313	
	2.0 HDi	10.98-12.01	81				1 987 477 440	→ 1333	
							1 987 477 441	← 1313	
		03.99-12.01	66		GS		1 987 477 439	← 1262	
							1 987 477 440	→ 1333	
	2.0 i Turbo	12.97-12.01	108-110				1 987 477 440	→ 1333	
							1 987 477 441	← 1313	
	2.0 i 16V	12.97-12.01	97-99		AG		1 987 477 440	→ 1333	
							1 987 482 115	← 1285	
					GS		1 987 477 439	← 1262	
							1 987 477 440	→ 1333	
	2.1 D Turbo	12.97-12.01	80-81				1 987 477 440	→ 1333	
							1 987 477 441	← 1313	
	3.0 i	01.98-12.01	140		LLE		1 987 477 441	← 1313	
					RLE		1 987 477 440	→ 1333	
							1 987 477 441	← 1313	
	1.8 i, i 16V	12.97-12.01	66/81				0 986 594 019 <sup>4</sup>		
	1.9 D Turbo	12.97-12.01	55/66				0 986 594 019 <sup>4</sup>		
	2.0 HDi, i Turbo, i 16V	12.97-12.01	66/81/97-99/108-110				0 986 594 019 <sup>4</sup>		
	2.1 D Turbo	12.97-12.01	80-81				0 986 594 019 <sup>4</sup>		
	3.0 i	01.98-12.01	140				0 986 594 019 <sup>4</sup>		

		S							
<b>Xantia [X1]</b>									
									
	<b>1.6i</b>	03.93-10.95	65-66	Org.-Nr. →6901			0 204 102 279	← 54	0 204 100 125 <sup>B</sup>
							0 986 473 289		0 204 104 057 <sup>7</sup>
							0 204 102 280	→ 54	0 204 100 125 <sup>B</sup>
							0 986 474 289		
		11.95-01.98	65-66	Org.-Nr. 6902→			0 204 102 194	← 54	0 204 100 125 <sup>B</sup>
							0 986 473 289		0 204 104 057 <sup>7</sup>
							0 204 102 196	→ 54	0 204 100 125 <sup>B</sup>
							0 986 474 289		
	<b>1.8i</b>	04.97-01.98	66				0 204 102 194	← 54	0 204 100 125 <sup>B</sup>
							0 986 473 289		0 204 104 057 <sup>7</sup>
							0 204 102 196	→ 54	0 204 100 125 <sup>B</sup>
							0 986 474 289		
	<b>1.8i</b> <b>1.8i 16V</b>	03.93-10.95	70-71/ 74-76/81	Org.-Nr. →6901			0 204 102 279	← 54	0 204 100 125 <sup>B</sup>
							0 986 473 289		0 204 104 057 <sup>7</sup>
							0 204 102 280	→ 54	0 204 100 125 <sup>B</sup>
							0 986 474 289		
		11.95-01.98	70-71/ 74-76/81	Org.-Nr. 6902→			0 204 102 194	← 54	0 204 100 125 <sup>B</sup>
							0 986 473 289		0 204 104 057 <sup>7</sup>
							0 204 102 196	→ 54	0 204 100 125 <sup>B</sup>
							0 986 474 289		
	<b>1.9D</b>	07.93-10.95	50-52	Org.-Nr. →6901			0 204 102 279	← 54	0 204 100 125 <sup>B</sup>
							0 986 473 289		0 204 104 057 <sup>7</sup>
							0 204 102 280	→ 54	0 204 100 125 <sup>B</sup>
							0 986 474 289		
		11.95-01.98	50-52	Org.-Nr. 6902→			0 204 102 194	← 54	0 204 100 125 <sup>B</sup>
							0 986 473 289		0 204 104 057 <sup>7</sup>
							0 204 102 196	→ 54	0 204 100 125 <sup>B</sup>
							0 986 474 289		
	<b>1.9D Turbo</b>	07.93-10.95	66/67-68	Org.-Nr. →6901			0 204 102 279	← 54	0 204 100 125 <sup>B</sup>
							0 986 473 289		0 204 104 057 <sup>7</sup>
							0 204 102 280	→ 54	0 204 100 125 <sup>B</sup>
							0 986 474 289		
		11.95-01.98	66/67-68	Org.-Nr. 6902→			0 204 102 194	← 54	0 204 100 125 <sup>B</sup>
							0 986 473 289		0 204 104 057 <sup>7</sup>
							0 204 102 196	→ 54	0 204 100 125 <sup>B</sup>
							0 986 474 289		
		09.96-01.98	55				0 204 102 194	← 54	0 204 100 125 <sup>B</sup>
							0 986 473 289		0 204 104 057 <sup>7</sup>
							0 204 102 196	→ 54	0 204 100 125 <sup>B</sup>
							0 986 474 289		
	<b>2.0i Turbo</b>	05.95-10.95	108-110	Org.-Nr. →6901			0 204 102 269	← 57	0 204 104 051 <sup>7</sup>
							0 204 103 269		
							0 204 102 270	→ 57	0 204 104 051 <sup>7</sup>
							0 204 103 270		
		11.95-01.98	108-110	Org.-Nr. 6902→			0 204 102 190	← 57	0 204 104 051 <sup>7</sup>
							0 986 473 313		
							0 204 102 192	→ 57	0 204 104 051 <sup>7</sup>
							0 986 474 313		
	<b>2.0i</b> <b>2.0i 16V</b>	03.93-10.95	89-90/ 91-92/97	Org.-Nr. →6901			0 204 102 279	← 54	0 204 100 125 <sup>B</sup>
							0 986 473 289		0 204 104 057 <sup>7</sup>
							0 204 102 280	→ 54	0 204 100 125 <sup>B</sup>
							0 986 474 289		
		11.95-01.98	89-90/ 91-92/97	Org.-Nr. 6902→			0 204 102 194	← 54	0 204 100 125 <sup>B</sup>
							0 986 473 289		0 204 104 057 <sup>7</sup>
							0 204 102 196	→ 54	0 204 100 125 <sup>B</sup>
							0 986 474 289		



<b>CITROEN Xantia [X1]</b>								
2.0 i 16V	03.93-10.95	110-114	Org.-Nr. →6901	0 204 102 279	← 54	0 204 100 125 <sup>8</sup>		
				0 986 473 289		0 204 104 057 <sup>7</sup>		
	11.95-12.98	110-114	Org.-Nr. 6902→	0 204 102 280	→ 54	0 204 100 125 <sup>8</sup>		
				0 986 474 289				
2.1 D Turbo	05.95-10.95	80-81	Org.-Nr. →6901	0 204 102 194	← 54	0 204 100 125 <sup>8</sup>		
				0 986 473 289		0 204 104 057 <sup>7</sup>		
	11.95-01.98	80-81	Org.-Nr. 6902→	0 204 102 196	→ 54	0 204 100 125 <sup>8</sup>		
				0 986 474 289				
3.0 i	10.96-01.98	140		0 204 102 594	← 60			
				0 204 103 594				
				0 204 102 595	→ 60			
				0 204 103 595				
	1.6 i	03.93-01.98	65-66	AG	1 987 477 439	← 1262		
					1 987 477 440	→ 1333		
				GS	1 987 477 440	→ 1333		
					1 987 477 441	← 1313		
1.8 i	03.93-01.98	66/70-71/ 74-76/81		AG	1 987 477 439	← 1262		
					1 987 477 440	→ 1333		
1.8 i 16V				GS	1 987 477 440	→ 1333		
					1 987 477 441	← 1313		
1.9 D	07.93-01.98	50-52/55/ 66/67-68		AG	1 987 477 439	← 1262		
					1 987 477 440	→ 1333		
1.9 D Turbo				GS	1 987 477 440	→ 1333		
					1 987 477 441	← 1313		
2.0 i	03.93-12.98	89-90/ 91-92/97/		AG	1 987 477 439	← 1262		
					1 987 477 440	→ 1333		
2.0 i 16V		108-114		GS	1 987 477 440	→ 1333		
					1 987 477 441	← 1313		
2.1 D Turbo	05.95-01.98	80-81		AG	1 987 477 439	← 1262		
					1 987 477 440	→ 1333		
				GS	1 987 477 440	→ 1333		
					1 987 477 441	← 1313		
3.0 i	10.96-01.98	140		LLE	1 987 477 441	← 1313		
					1 987 477 440	→ 1333		
				RLE	1 987 477 441	← 1313		
1.6 i	03.93-10.97	65-66	Org.-Nr. →7631		0 986 594 021 <sup>4</sup>			
					11.97-01.98	65-66	Org.-Nr. 7632→	0 986 594 019 <sup>4</sup>
1.8 i	03.93-10.97	66/70-71/ 74-76/81	Org.-Nr. →7631		0 986 594 021 <sup>4</sup>			
					11.97-01.98	66/70-71/ 74-76/81	Org.-Nr. 7632→	0 986 594 019 <sup>4</sup>
1.8 i 16V								
1.9 D	07.93-10.97	50-52	Org.-Nr. →7631		0 986 594 021 <sup>4</sup>			
1.9 D Turbo	07.93-12.96	67-68	Org.-Nr. →7631		0 986 594 021 <sup>4</sup>			
					02.94-10.97	55/66	Org.-Nr. →7631	0 986 594 021 <sup>4</sup>
	11.97-01.98	55/66	Org.-Nr. 7632→		0 986 594 019 <sup>4</sup>			
2.0 i	03.93-10.97	89-90/ 91-92/97/	Org.-Nr. →7631		0 986 594 021 <sup>4</sup>			
					11.97-01.98	89-90/ 91-92/97/ 108-110	Org.-Nr. 7632→	0 986 594 019 <sup>4</sup>
2.0 i Turbo								
2.0 i 16V								

		S									
2.0i 16V		03.93-10.97	110-114	Org.-Nr. →7631			0 986 594 021 <sup>4</sup>				
2.1 D Turbo		05.95-10.97	80-81	Org.-Nr. →7631			0 986 594 021 <sup>4</sup>				
		11.97-01.98	80-81	Org.-Nr. 7632→			0 986 594 019 <sup>4</sup>				
3.0i		10.96-10.97	140	Org.-Nr. →7631			0 986 594 021 <sup>4</sup>				
		11.97-01.98	140	Org.-Nr. 7632→			0 986 594 019 <sup>4</sup>				
<b>Xantia [X2]</b>											
1.6i		03.98-12.01	66				0 204 102 194	← 54	0 204 100 125 <sup>B</sup>		
						0 986 473 289		0 204 104 057 <sup>7</sup>			
						0 204 102 196	→ 54	0 204 100 125 <sup>B</sup>			
						0 986 474 289					
1.8i 1.8i 16V		10.97-12.01	66/81				0 204 102 194	← 54	0 204 100 125 <sup>B</sup>		
						0 986 473 289		0 204 104 057 <sup>7</sup>			
						0 204 102 196	→ 54	0 204 100 125 <sup>B</sup>			
						0 986 474 289					
1.9 D Turbo		12.97-12.01	55				0 204 102 194	← 54	0 204 104 057 <sup>7</sup>		
						0 986 473 289					
						0 204 102 196	→ 54	0 204 104 057 <sup>7</sup>			
						0 986 474 289					
			66		AG		0 204 102 594	← 60			
							0 204 103 594				
							0 204 102 595	→ 60			
							0 204 103 595				
						GS		0 204 102 194	← 54	0 204 104 057 <sup>7</sup>	
								0 986 473 289			
						0 204 102 196	→ 54	0 204 104 057 <sup>7</sup>			
						0 986 474 289					
2.0 HDi		10.98-12.01	81				0 204 102 594	← 60			
						0 204 103 594					
						0 204 102 595	→ 60				
						0 204 103 595					
		03.99-12.01	66				0 204 102 194	← 54	0 204 104 057 <sup>7</sup>		
							0 986 473 289				
							0 204 102 196	→ 54	0 204 104 057 <sup>7</sup>		
							0 986 474 289				
2.0i		12.97-12.01	89-90				0 204 102 194	← 54	0 204 100 125 <sup>B</sup>		
						0 986 473 289		0 204 104 057 <sup>7</sup>			
						0 204 102 196	→ 54	0 204 100 125 <sup>B</sup>			
						0 986 474 289					
2.0i Turbo		12.97-10.98	108-110	Org.-Nr. →8000			0 204 102 190	← 57	0 204 104 051 <sup>7</sup>		
							0 986 473 313				
							0 204 102 192	→ 57	0 204 104 051 <sup>7</sup>		
			11.98-12.01	108-110	Org.-Nr. 8001→			0 204 102 594	← 60		
									0 204 103 594		
									0 204 102 595	→ 60	
						0 204 103 595					
2.0i 16V	AFS	12.97-10.98	97-99	Org.-Nr. →8000			0 204 102 190	← 57	0 204 104 051 <sup>7</sup>		
								0 986 473 313			
								0 204 102 192	→ 57	0 204 104 051 <sup>7</sup>	
								0 986 474 313			
			11.98-12.01	97-99	Org.-Nr. 8001→			0 204 102 594	← 60		
									0 204 103 594		
									0 204 102 595	→ 60	
									0 204 103 595		
	OFS	12.97-12.01	97-99				0 204 102 194	← 54	0 204 100 125 <sup>B</sup>		
						0 986 473 289		0 204 104 057 <sup>7</sup>			
						0 204 102 196	→ 54	0 204 100 125 <sup>B</sup>			
						0 986 474 289					



		S																																			
<b>CITROEN Xantia [X2]</b>																																					
	<b>2.1 D Turbo</b>	12.97-10.98	80-81	Org.-Nr. →8000			0 204 <b>102 190</b>	← 57	0 204 <b>104 051</b> <sup>7</sup>																												
							0 986 <b>473 313</b>																														
		11.98-12.01	80-81	Org.-Nr. 8001→				0 204 <b>102 192</b>	→ 57	0 204 <b>104 051</b> <sup>7</sup>																											
								0 986 <b>474 313</b>																													
								0 204 <b>102 594</b>	← 60																												
								0 204 <b>103 594</b>																													
<b>3.0 i</b>	12.97-12.01	140					0 204 <b>102 595</b>	→ 60																													
							0 204 <b>103 595</b>																														
	<b>1.6 i</b>	03.98-12.01	66		GS		1 987 <b>477 439</b>	← 1262																													
							1 987 <b>477 440</b>	→ 1333																													
	<b>1.8 i</b>	10.97-12.01	66		GS		1 987 <b>477 439</b>	← 1262																													
							1 987 <b>477 440</b>	→ 1333																													
	<b>1.8 i 16V</b>	12.97-12.01	81		AG		1 987 <b>477 440</b>	→ 1333																													
							1 987 <b>482 115</b>	← 1285																													
							1 987 <b>477 439</b>	← 1262																													
							1 987 <b>477 440</b>	→ 1333																													
	<b>1.9 D Turbo</b>	12.97-12.01	55		GS		1 987 <b>477 439</b>	← 1262																													
							1 987 <b>477 440</b>	→ 1333																													
		66			AG			1 987 <b>477 440</b>	→ 1333																												
								1 987 <b>482 115</b>	← 1285																												
								1 987 <b>477 439</b>	← 1262																												
								1 987 <b>477 440</b>	→ 1333																												
<b>2.0 HDi</b>	03.99-12.01	66			GS		1 987 <b>477 439</b>	← 1262																													
							1 987 <b>477 440</b>	→ 1333																													
	<b>2.0 HDi</b>	12.97-12.01	81/89-90				1 987 <b>477 440</b>	→ 1333																													
							1 987 <b>477 441</b>	← 1313																													
	<b>2.0 i</b>	12.97-12.01	108-110				1 987 <b>477 440</b>	→ 1333																													
							1 987 <b>477 441</b>	← 1313																													
	<b>2.0 i 16V</b>	12.97-12.01	97-99		AG		1 987 <b>477 440</b>	→ 1333																													
							1 987 <b>482 115</b>	← 1285																													
						GS		1 987 <b>477 439</b>	← 1262																												
								1 987 <b>477 440</b>	→ 1333																												
	<b>2.1 D Turbo</b>	12.97-12.01	80-81				1 987 <b>477 440</b>	→ 1333																													
							1 987 <b>477 441</b>	← 1313																													
	<b>3.0 i</b>	12.97-12.01	140		LLE	RLE	1 987 <b>477 441</b>	← 1313																													
							1 987 <b>477 440</b>	→ 1333																													
							1 987 <b>477 441</b>	← 1313																													
	<b>1.6 i</b>	03.98-12.01	66				0 986 <b>594 019</b> <sup>4</sup>																														
							<b>1.8 i, i 16V</b>	10.97-12.01	66/81					0 986 <b>594 019</b> <sup>4</sup>																							
														<b>1.9 D Turbo</b>	12.97-12.01	55/66					0 986 <b>594 019</b> <sup>4</sup>																
																					<b>2.0 HDi, i, i Turbo, i 16V</b>	12.97-12.01	66/81/89-90/97-99/108-110					0 986 <b>594 019</b> <sup>4</sup>									
																												<b>2.1 D Turbo</b>	12.97-12.01	80-81					0 986 <b>594 019</b> <sup>4</sup>		
																																			<b>3.0 i</b>	12.97-12.01	140
<b>XM [Y3]</b>																																					
	<b>2.0</b>	03.91-06.94	79-81/85/	Org.-Nr. 5229→			0 204 <b>102 269</b>	← 57	0 204 <b>104 051</b> <sup>7</sup>																												
							0 204 <b>103 269</b>																														
							<b>2.0 i</b>	89-96/						0 204 <b>102 270</b>	→ 57	0 204 <b>104 051</b> <sup>7</sup>																					
														0 204 <b>103 270</b>																							
							<b>2.0 i Turbo</b>	104-107						0 204 <b>102 269</b>	← 57	0 204 <b>104 051</b> <sup>7</sup>																					
														0 204 <b>103 269</b>																							
0 204 <b>102 270</b>	→ 57	0 204 <b>104 051</b> <sup>7</sup>																																			
0 204 <b>103 270</b>																																					
	<b>2.1 D</b>	03.91-06.94	60-61/	Org.-Nr. 5229→			0 204 <b>102 269</b>	← 57	0 204 <b>104 051</b> <sup>7</sup>																												
							0 204 <b>103 269</b>																														
	<b>2.1 D Turbo</b>	03.91-06.94	80-81				0 204 <b>102 270</b>	→ 57	0 204 <b>104 051</b> <sup>7</sup>																												
							0 204 <b>103 270</b>																														

		S							
<b>3.0i</b>		06.93-06.94	123-125/	Org.-Nr. 5229→			0 204 <b>102 269</b>	← 57	0 204 <b>104 051</b> <sup>7</sup>
<b>3.0i 24V</b>			147				0 204 <b>103 269</b>		
							0 204 <b>102 270</b>	→ 57	0 204 <b>104 051</b> <sup>7</sup>
							0 204 <b>103 270</b>		
<b>2.0</b>		05.89-06.94	79-81/85/				1 987 <b>477 490</b>	→ 1230	
<b>2.0i</b>			89-96/				1 987 <b>477 491</b>	← 1030	
<b>2.0i Turbo</b>			104-107			LLE	1 987 <b>477 488</b>	1408	
						RLE	1 987 <b>477 489</b>	963	
<b>2.1D</b>		05.89-06.94	60-61/				1 987 <b>477 490</b>	→ 1230	
<b>2.1D Turbo</b>			80-81				1 987 <b>477 491</b>	← 1030	
						LLE	1 987 <b>477 488</b>	1408	
						RLE	1 987 <b>477 489</b>	963	
<b>3.0i</b>		06.93-06.94	123-125				1 987 <b>477 490</b>	→ 1230	
							1 987 <b>477 491</b>	← 1030	
						LLE	1 987 <b>477 488</b>	1408	
						RLE	1 987 <b>477 489</b>	963	
<b>3.0i 24V</b>		06.93-06.94	147			RLE	1 987 <b>477 490</b>	→ 1230	
<b>XM [Y4]</b>									
<b>2.0i</b>		07.94-10.00	90-96/				0 204 <b>102 269</b>	← 57	0 204 <b>104 051</b> <sup>7</sup>
<b>2.0i Turbo</b>			97-99/				0 204 <b>103 269</b>		
<b>2.0i 16V</b>			108-110				0 204 <b>102 270</b>	→ 57	0 204 <b>104 051</b> <sup>7</sup>
							0 204 <b>103 270</b>		
<b>2.1D</b>		07.94-10.00	60-61/				0 204 <b>102 269</b>	← 57	0 204 <b>104 051</b> <sup>7</sup>
<b>2.1D Turbo</b>			80-81				0 204 <b>103 269</b>		
							0 204 <b>102 270</b>	→ 57	0 204 <b>104 051</b> <sup>7</sup>
							0 204 <b>103 270</b>		
<b>2.5D Turbo</b>		07.94-05.97	94-96	Org.-Nr. →7475			0 204 <b>102 269</b>	← 57	0 204 <b>104 051</b> <sup>7</sup>
							0 204 <b>103 269</b>		
							0 204 <b>102 270</b>	→ 57	0 204 <b>104 051</b> <sup>7</sup>
							0 204 <b>103 270</b>		
		06.97-10.00	94-96	Org.-Nr. 7476→			0 204 <b>102 594</b>	← 60	
							0 204 <b>103 594</b>		
							0 204 <b>102 595</b>	→ 60	
							0 204 <b>103 595</b>		
<b>3.0i</b>		07.94-12.97	123-125				0 204 <b>102 269</b>	← 57	0 204 <b>104 051</b> <sup>7</sup>
							0 204 <b>103 269</b>		
							0 204 <b>102 270</b>	→ 57	0 204 <b>104 051</b> <sup>7</sup>
							0 204 <b>103 270</b>		
		06.97-10.00	140-143				0 204 <b>102 594</b>	← 60	
							0 204 <b>103 594</b>		
							0 204 <b>102 595</b>	→ 60	
							0 204 <b>103 595</b>		
<b>3.0i 24V</b>		07.94-12.97	147				0 204 <b>102 269</b>	← 57	0 204 <b>104 051</b> <sup>7</sup>
							0 204 <b>103 269</b>		
							0 204 <b>102 270</b>	→ 57	0 204 <b>104 051</b> <sup>7</sup>
							0 204 <b>103 270</b>		
<b>2.0i</b>		07.94-10.00	90-96/				1 987 <b>477 490</b>	→ 1230	
<b>2.0i Turbo</b>			97-99/				1 987 <b>477 491</b>	← 1030	
<b>2.0i 16V</b>			108-110			LLE	1 987 <b>477 488</b>	1408	
						RLE	1 987 <b>477 489</b>	963	
<b>2.1D</b>		07.94-10.00	60-61/				1 987 <b>477 490</b>	→ 1230	
<b>2.1D Turbo</b>			80-81				1 987 <b>477 491</b>	← 1030	
						LLE	1 987 <b>477 488</b>	1408	
						RLE	1 987 <b>477 489</b>	963	



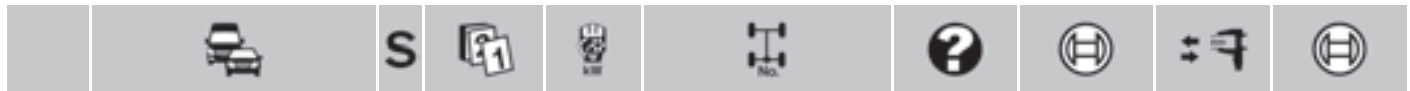













<b>CITROEN XM [Y4]</b>									
2.5 D Turbo	07.94-10.00	94-96					1987 477 490	→ 1230	
							1987 477 491	← 1030	
							LLE	1987 477 488	1408
							RLE	1987 477 489	963
3.0 i	07.94-10.00	123-125/ 140-143					1987 477 490	→ 1230	
							1987 477 491	← 1030	
							LLE	1987 477 488	1408
							RLE	1987 477 489	963
3.0 i 24V	07.94-12.97	147					RLE	1987 477 490	→ 1230

**Xsara Break [N6]**



1.4 i	ABO	04.98-08.00	55				0986 473 887	← 48	
							0986 473 888	→ 48	
	ABS	04.98-08.00	55				BO	0204 102 763	← 54
								0986 473 410	
								0204 102 764	→ 54
								0986 474 410	
							GIR	0986 473 026	← 54
								0986 474 026	→ 54
1.5 D	ABO	10.97-08.00	42				0986 473 887	← 48	
							0986 473 888	→ 48	
	ABS	10.97-08.00	42				BO	0204 102 763	← 54
								0986 473 410	
								0204 102 764	→ 54
								0986 474 410	
							GIR	0986 473 026	← 54
								0986 474 026	→ 54
1.6 i	ABO	10.97-08.00	65-66				0986 473 887	← 48	
							0986 473 888	→ 48	
	ABS	10.97-08.00	65-66				BO	0204 102 763	← 54
								0986 473 410	
								0204 102 764	→ 54
								0986 474 410	
							GIR	0986 473 026	← 54
								0986 474 026	→ 54
1.8 D	ABO	04.98-08.00	44				0986 473 887	← 48	
							0986 473 888	→ 48	
	ABS	04.98-08.00	44				BO	0204 102 763	← 54
								0986 473 410	
								0204 102 764	→ 54
								0986 474 410	
							GIR	0986 473 026	← 54
								0986 474 026	→ 54
1.8 i		04.98-08.00	66/74-75/ 81-82				BO	0204 102 763	← 54
								0986 473 410	
1.8 i 16V								0204 102 764	→ 54
								0986 474 410	
							GIR	0986 473 026	← 54
								0986 474 026	→ 54
1.9 D	ABO	04.98-08.00	50/51				0986 473 887	← 48	
							0986 473 888	→ 48	
	ABS	04.98-08.00	50/51				BO	0204 102 763	← 54
								0986 473 410	
								0204 102 764	→ 54
								0986 474 410	
							GIR	0986 473 026	← 54
								0986 474 026	→ 54

		S								
1.9 D Turbo		04.98-08.00	55/66				BO	0 204 102 763 0 986 473 410	← 54 ↻	
								0 204 102 764 0 986 474 410	→ 54 ↻	
							GIR	0 986 473 026 0 986 474 026	↻ ← 54 ↻ → 54	
2.0 HDi 2.0 i 16V		07.98-08.00	66/97				BO	0 204 102 763 0 986 473 410	← 54 ↻	
								0 204 102 764 0 986 474 410	→ 54 ↻	
							GIR	0 986 473 026 0 986 474 026	↻ ← 54 ↻ → 54	
										
1.4 i		ABO	04.98-08.00	55				F 026 009 179	↔ 20,64	
		ABS	04.98-08.00	55				F 026 002 471	↔ 22	
1.5 D		ABO	10.97-08.00	42				F 026 009 179	↔ 20,64	
		ABS	10.97-08.00	42				F 026 002 471	↔ 22	
1.6 i		ABO	10.97-08.00	65-66				F 026 009 179	↔ 20,64	
		ABS	10.97-08.00	65-66				F 026 002 471	↔ 22	
1.8 D		ABO	04.98-08.00	44				F 026 009 179	↔ 20,64	
		ABS	04.98-08.00	44				F 026 002 471	↔ 22	
1.8 i			04.98-08.00	74-75				F 026 002 471	↔ 22	
1.9 D		ABO	04.98-08.00	50/51				F 026 009 179	↔ 20,64	
		ABS	04.98-08.00	50				F 026 002 471	↔ 22	
1.9 D, D Turbo			04.98-08.00	51/55/66				F 026 002 471	↔ 22	
1.8 i 1.8 i 16V			04.98-08.00	74-75/ 81-82				0 204 102 277 0 204 103 277 0 986 473 983	← 32 ↻ ↻	0 204 100 098 <sup>B</sup> 0 204 104 068 <sup>9</sup>
								0 204 102 278 0 204 103 278 0 986 474 983	→ 32 ↻ ↻	0 204 100 098 <sup>B</sup>
2.0 HDi 2.0 i 16V			07.98-08.00	66/97				0 204 102 277 0 204 103 277 0 986 473 983	← 32 ↻ ↻	0 204 100 098 <sup>B</sup> 0 204 104 068 <sup>9</sup>
								0 204 102 278 0 204 103 278 0 986 474 983	→ 32 ↻ ↻	0 204 100 098 <sup>B</sup>
										
1.4 i			04.98-08.00	55		STB		1 987 477 584 1 987 477 585	← 1610 → 1520	
1.5 D			10.97-08.00	42		STB		1 987 477 584 1 987 477 585	← 1610 → 1520	
1.6 i			10.97-08.00	65-66		STB		1 987 477 584 1 987 477 585	← 1610 → 1520	
1.8 D			04.98-08.00	44/66		STB		1 987 477 584 1 987 477 585	← 1610 → 1520	
1.8 i			04.98-08.00	74-75		SBR		1 987 477 582 1 987 477 583	← 1635 → 1545	
						STB		1 987 477 584 1 987 477 585	← 1610 → 1520	
1.8 i 16V			04.98-08.00	81-82		SBR		1 987 477 582 1 987 477 583	← 1635 → 1545	
1.9 D			04.98-08.00	50/51/55/ 66		STB		1 987 477 584 1 987 477 585	← 1610 → 1520	
1.9 D Turbo								1 987 477 585	→ 1520	
2.0 HDi 2.0 i 16V			07.98-08.00	66/97		SBR		1 987 477 582 1 987 477 583	← 1635 → 1545	





















		S							
◀ CITROEN Xsara Break [N6]									
	1.4 i	04.98-08.00	55			SBR	0 265 006 389 <sup>3</sup>		
						STB	0 265 006 441 <sup>4</sup>		
	1.5 D	10.97-08.00	42			SBR	0 265 006 389 <sup>3</sup>		
						STB	0 265 006 441 <sup>4</sup>		
	1.6 i	10.97-08.00	65-66			SBR	0 265 006 389 <sup>3</sup>		
						STB	0 265 006 441 <sup>4</sup>		
	1.8 D	04.98-08.00	44/66			SBR	0 265 006 389 <sup>3</sup>		
	1.8 i					STB	0 265 006 441 <sup>4</sup>		
	1.8 i	04.98-08.00	74-75			SBR	0 265 006 202 <sup>4</sup>		
							0 265 006 389 <sup>3</sup>		
						STB	0 265 006 441 <sup>4</sup>		
	1.8 i 16V	04.98-08.00	81-82			SBR	0 265 006 202 <sup>4</sup>		
							0 265 006 389 <sup>3</sup>		
	1.9 D	04.98-08.00	50/51/55/			SBR	0 265 006 389 <sup>3</sup>		
1.9 D Turbo		66			STB	0 265 006 441 <sup>4</sup>			
2.0 HDi	07.98-08.00	66/97			SBR	0 265 006 202 <sup>4</sup>			
2.0 i 16V						0 265 006 389 <sup>3</sup>			
Xsara Break [N7]									
	1.4 HDi	09.00-12.05	50/55				0 204 004 451	← 54	
	1.4 i						0 204 103 971		
							0 204 004 452	→ 54	
	1.6 i 16V	09.00-03.10	80				0 204 004 451	← 54	
							0 204 103 971		
							0 204 004 452	→ 54	
	1.9 D	09.00-12.05	52				0 204 004 451	← 54	
							0 204 103 971		
							0 204 004 452	→ 54	
	2.0 HDi	09.00-03.10	66				0 204 004 451	← 54	
							0 204 103 971		
							0 204 004 452	→ 54	
	2.0 HDi	09.00-12.01	80/100	Org.-Nr. →9184			0 986 473 505	← 57	
	2.0 i 16V						0 986 474 505	→ 57	
	01.02-03.10	80/100	Org.-Nr. 9185→			0 204 102 974	→ 54		
						0 204 103 974			
	1.4 HDi, i	09.00-12.05	50/55				F 026 002 471	↔ 22	
	1.9 D	09.00-12.05	52				F 026 002 471	↔ 22	
	1.6 i 16V	09.00-03.10	80				0 204 102 277	← 32	0 204 100 098 <sup>8</sup>
							0 204 103 277		0 204 104 068 <sup>9</sup>
							0 986 473 983		
							0 204 102 278	→ 32	0 204 100 098 <sup>8</sup>
							0 204 103 278		
							0 986 474 983		
2.0 HDi	09.00-03.10	66/80/100				0 204 102 277	← 32	0 204 100 098 <sup>8</sup>	
2.0 i 16V						0 204 103 277		0 204 104 068 <sup>9</sup>	
						0 986 473 983			
						0 204 102 278	→ 32	0 204 100 098 <sup>8</sup>	
						0 204 103 278			
						0 986 474 983			
	1.4 HDi	09.00-12.05	50/55				1 987 477 584	← 1610	
	1.4 i						1 987 477 585	→ 1520	
	1.6 i 16V	09.00-03.10	80				1 987 477 582	← 1635	
							1 987 477 583	→ 1545	

		S							
1.9D		09.00-12.05	52				1 987 477 584	← 1610	
							1 987 477 585	→ 1520	
2.0 HDi		09.00-03.10	66/80/100				1 987 477 582	← 1635	
2.0 i 16V							1 987 477 583	→ 1545	
1.4 HDi		09.00-12.05	50/55				0 265 006 389 <sup>3</sup>		
1.4 i							0 265 006 441 <sup>4</sup>		
1.6 i 16V		09.00-03.10	80				0 265 006 202 <sup>4</sup>		
							0 265 006 389 <sup>3</sup>		
1.9D		09.00-12.05	52				0 265 006 389 <sup>3</sup>		
							0 265 006 441 <sup>4</sup>		
2.0 HDi		09.00-03.10	66/80/100				0 265 006 202 <sup>4</sup>		
2.0 i 16V							0 265 006 389 <sup>3</sup>		
<b>Xsara Coupé [N6]</b>									
1.4 i		ABO 07.97-08.00	55				0 204 102 609	← 48	0 204 100 377 <sup>B</sup>
							0 204 103 609		0 204 104 215 <sup>7</sup>
							0 204 102 610	→ 48	0 204 100 377 <sup>B</sup>
							0 204 103 610		
		ABS 07.97-08.00	55				0 986 473 887	← 48	
							0 986 473 888	→ 48	
1.6		07.97-08.00	65				0 986 473 887	← 48	
							0 986 473 888	→ 48	
1.8 D		07.97-08.00	44/66/74				0 986 473 887	← 48	
1.8 i							0 986 473 888	→ 48	
1.8 i 16V		07.97-08.00	81-82			BO	0 204 102 763	← 54	
							0 986 473 410		
							0 204 102 764	→ 54	
							0 986 474 410		
						GIR	0 986 473 026	← 54	
							0 986 474 026	→ 54	
1.9 D		07.97-08.00	50/51/55/				0 986 473 887	← 48	
1.9 D Turbo			66				0 986 473 888	→ 48	
2.0 HDi		07.97-08.00	66/97			BO	0 204 102 763	← 54	
2.0 i 16V							0 986 473 410		
							0 204 102 764	→ 54	
							0 986 474 410		
						GIR	0 986 473 026	← 54	
							0 986 474 026	→ 54	
2.0 i 16V		07.97-08.00	120-123				0 986 473 505	← 57	
							0 986 474 505	→ 57	
1.4 i		ABO 07.97-08.00	55			BO	F 026 002 234	← 20,6	
							F 026 002 235	→ 20,6	
						GIR	0 986 475 635	▲ → 20,6	
							0 986 475 636	▲ ← 20,6	
		ABS 07.97-08.00	55				0 986 475 797	↔ 20,6	
1.6		ABO 07.97-08.00	65			BO	F 026 002 234	← 20,6	
							F 026 002 235	→ 20,6	
						GIR	0 986 475 635	▲ → 20,6	
							0 986 475 636	▲ ← 20,6	
		ABS 07.97-08.00	65				0 986 475 797	↔ 20,6	
1.8 D		ABO 07.97-08.00	44/66/74			BO	F 026 002 234	← 20,6	
1.8 i							F 026 002 235	→ 20,6	
						GIR	0 986 475 635	▲ → 20,6	
							0 986 475 636	▲ ← 20,6	
		ABS 07.97-08.00	44/66/74				0 986 475 797	↔ 20,6	



		S							
◀ CITROEN Xsara Coupé [N6]									
1.9D	ABO	07.97-08.00	50/51	BO	F 026	<b>002 234</b>	←	20,6	
					F 026	<b>002 235</b>	→	20,6	
	ABS	07.97-08.00	50/51	GIR	0986	<b>475 635</b>	▲ →	20,6	
					0986	<b>475 636</b>	▲ ←	20,6	
1.9D Turbo		07.97-08.00	55/66		0986	<b>475 797</b>	↔	20,6	
	1.8 i	07.97-08.00	74/81-82		0204	<b>102 277</b>	←	32	0 204 <b>100 098</b> <sup>8</sup>
	1.8 i 16V				0204	<b>103 277</b>			0 204 <b>104 068</b> <sup>9</sup>
					0986	<b>473 983</b>			
					0204	<b>102 278</b>	→	32	0 204 <b>100 098</b> <sup>8</sup>
					0204	<b>103 278</b>			
					0986	<b>474 983</b>			
2.0 HDi		07.97-08.00	66/97/		0204	<b>102 277</b>	←	32	0 204 <b>100 098</b> <sup>8</sup>
2.0 i 16V			120-123		0204	<b>103 277</b>			0 204 <b>104 068</b> <sup>9</sup>
					0986	<b>473 983</b>			
					0204	<b>102 278</b>	→	32	0 204 <b>100 098</b> <sup>8</sup>
					0204	<b>103 278</b>			
					0986	<b>474 983</b>			
	1.4 i	07.97-08.00	55	STB	1987	<b>477 580</b>	←	1591	
					1987	<b>477 581</b>	→	1500	
1.6		07.97-08.00	65		1987	<b>477 580</b>	←	1591	
					1987	<b>477 581</b>	→	1500	
1.8D		07.97-08.00	44/66/74	STB	1987	<b>477 580</b>	←	1591	
1.8 i					1987	<b>477 581</b>	→	1500	
1.8 i 16V		07.97-08.00	81-82	SBR	1987	<b>477 582</b>	←	1635	
					1987	<b>477 583</b>	→	1545	
1.9D		07.97-08.00	50/51/55/	STB	1987	<b>477 580</b>	←	1591	
1.9D Turbo			66		1987	<b>477 581</b>	→	1500	
2.0 HDi		07.97-08.00	66/97/	SBR	1987	<b>477 582</b>	←	1635	
2.0 i 16V			120-123		1987	<b>477 583</b>	→	1545	
	1.4 i	07.97-08.00	55	SBR	0265	<b>006 389</b> <sup>3</sup>			
				STB	0265	<b>006 203</b> <sup>4</sup>			
1.6		07.97-08.00	65		0265	<b>006 203</b> <sup>4</sup>			
					0265	<b>006 389</b> <sup>3</sup>			
1.8D		07.97-08.00	44/66/74	SBR	0265	<b>006 389</b> <sup>3</sup>			
1.8 i				STB	0265	<b>006 203</b> <sup>4</sup>			
1.8 i 16V		07.97-08.00	81-82	SBR	0265	<b>006 202</b> <sup>4</sup>			
					0265	<b>006 389</b> <sup>3</sup>			
1.9D		07.97-08.00	50/51/55/	SBR	0265	<b>006 389</b> <sup>3</sup>			
1.9D Turbo			66	STB	0265	<b>006 203</b> <sup>4</sup>			
2.0 HDi		07.97-08.00	66/97/	SBR	0265	<b>006 202</b> <sup>4</sup>			
2.0 i 16V			120-123		0265	<b>006 389</b> <sup>3</sup>			
<b>Xsara Coupé [N7]</b>									
	1.4 HDi	09.00-12.05	50/55		0204	<b>004 451</b>	←	54	
	1.4 i				0204	<b>103 971</b>			
					0204	<b>004 452</b>	→	54	
1.6 i 16V		09.00-12.05	80		0204	<b>004 451</b>	←	54	
					0204	<b>103 971</b>			
					0204	<b>004 452</b>	→	54	
1.9D		09.00-12.05	52		0204	<b>004 451</b>	←	54	
					0204	<b>103 971</b>			
					0204	<b>004 452</b>	→	54	
2.0 HDi		09.00-12.05	66		0204	<b>004 451</b>	←	54	
					0204	<b>103 971</b>			
					0204	<b>004 452</b>	→	54	

		<b>S</b>							
									
									
									
									
									
									
<b>Xsara [N6]</b>									
									
									



		S								
	◀ CITROEN Xsara [N6]									
1.8 D		07.97-08.00	44/66/				0986 473 887		← 48	
1.8 i			74-75				0986 473 888		→ 48	
1.8 i 16V		07.97-08.00	81-82		BO		0204 102 763		← 54	
							0986 473 410			
							0204 102 764		→ 54	
							0986 474 410			
					GIR		0986 473 026		← 54	
							0986 474 026		→ 54	
1.9 D		07.97-08.00	50/51/55/				0986 473 887		← 48	
1.9 D Turbo			66				0986 473 888		→ 48	
2.0 HDi		07.97-08.00	66/97		BO		0204 102 763		← 54	
2.0 i 16V							0986 473 410			
							0204 102 764		→ 54	
							0986 474 410			
					GIR		0986 473 026		← 54	
							0986 474 026		→ 54	
2.0 i 16V		07.97-08.00	120-123				0986 473 505		← 57	
							0986 474 505		→ 57	
	1.4 i	ABO	07.97-08.00	55		BO	F 026 002 234		← 20,6	
							F 026 002 235		→ 20,6	
						GIR	0986 475 635		▲ → 20,6	
							0986 475 636		▲ ← 20,6	
		ABS	07.97-08.00	55			0986 475 797		↔ 20,6	
1.5 D	ABO	07.97-08.00	42		BO		F 026 002 234		← 20,6	
							F 026 002 235		→ 20,6	
						GIR	0986 475 635		▲ → 20,6	
							0986 475 636		▲ ← 20,6	
		ABS	07.97-08.00	42			0986 475 797		↔ 20,6	
1.6 i	ABO	07.97-08.00	65-66		BO		F 026 002 234		← 20,6	
							F 026 002 235		→ 20,6	
						GIR	0986 475 635		▲ → 20,6	
							0986 475 636		▲ ← 20,6	
		ABS	07.97-08.00	65-66			0986 475 797		↔ 20,6	
1.8 D	ABO	07.97-08.00	44/66/		BO		F 026 002 234		← 20,6	
1.8 i			74-75				F 026 002 235		→ 20,6	
						GIR	0986 475 635		▲ → 20,6	
							0986 475 636		▲ ← 20,6	
		ABS	07.97-08.00	44/66/74-75			0986 475 797		↔ 20,6	
1.9 D	ABO	07.97-08.00	50/51		BO		F 026 002 234		← 20,6	
							F 026 002 235		→ 20,6	
						GIR	0986 475 635		▲ → 20,6	
							0986 475 636		▲ ← 20,6	
		ABS	07.97-08.00	50/51			0986 475 797		↔ 20,6	
1.9 D Turbo		07.97-08.00	55/66				0986 475 797		↔ 20,6	
	1.8 i		07.97-08.00	74-75/			0204 102 277		← 32	0204 100 098 <sup>8</sup>
	1.8 i 16V			81-82			0204 103 277			0204 104 068 <sup>9</sup>
							0986 473 983			
							0204 102 278		→ 32	0204 100 098 <sup>8</sup>
							0204 103 278			
							0986 474 983			
2.0 HDi		07.97-08.00	66/97/				0204 102 277		← 32	0204 100 098 <sup>8</sup>
2.0 i 16V			120-123				0204 103 277			0204 104 068 <sup>9</sup>
							0986 473 983			
							0204 102 278		→ 32	0204 100 098 <sup>8</sup>
							0204 103 278			
							0986 474 983			

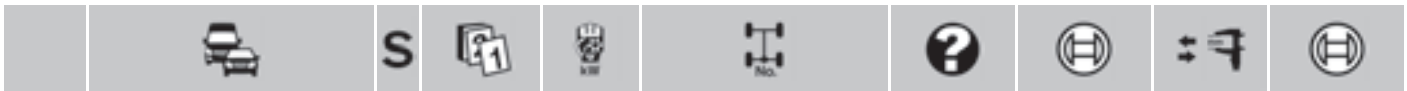

	1.4i	07.97-08.00	55		STB	1 987 477 580	← 1591
						1 987 477 581	→ 1500
	1.5D	07.97-08.00	42		STB	1 987 477 580	← 1591
						1 987 477 581	→ 1500
	1.6i	07.97-08.00	65-66		STB	1 987 477 580	← 1591
						1 987 477 581	→ 1500
	1.8D	07.97-08.00	44/66/		STB	1 987 477 580	← 1591
	1.8i		74-75			1 987 477 581	→ 1500
	1.8i 16V	07.97-08.00	81-82		SBR	1 987 477 582	← 1635
						1 987 477 583	→ 1545
1.9D	07.97-08.00	50/51/55/		STB	1 987 477 580	← 1591	
1.9D Turbo		66			1 987 477 581	→ 1500	
2.0HDi	07.97-08.00	66/97/		SBR	1 987 477 582	← 1635	
2.0i 16V		120-123			1 987 477 583	→ 1545	

	1.4i	07.97-08.00	55		SBR	0 265 006 389 <sup>3</sup>	
					STB	0 265 006 203 <sup>4</sup>	
	1.5D	07.97-08.00	42		SBR	0 265 006 389 <sup>3</sup>	
					STB	0 265 006 203 <sup>4</sup>	
	1.6i	07.97-08.00	65-66		SBR	0 265 006 389 <sup>3</sup>	
					STB	0 265 006 203 <sup>4</sup>	
	1.8D	07.97-08.00	44/66/		SBR	0 265 006 389 <sup>3</sup>	
	1.8i		74-75		STB	0 265 006 203 <sup>4</sup>	
	1.8i 16V	07.97-08.00	81-82		SBR	0 265 006 202 <sup>4</sup>	
						0 265 006 389 <sup>3</sup>	
1.9D	07.97-08.00	50/51/55/		SBR	0 265 006 389 <sup>3</sup>		
1.9D Turbo		66		STB	0 265 006 203 <sup>4</sup>		
2.0HDi	07.97-08.00	66/97/		SBR	0 265 006 202 <sup>4</sup>		
2.0i 16V		120-123			0 265 006 389 <sup>3</sup>		

**Xsara [N7]**



	1.4 HDi	09.00-12.05	50/55			0 204 004 451	← 54
	1.4i					0 204 103 971	↻
						0 204 004 452	→ 54
1.6i 16V	09.00-12.05	80				0 204 004 451	← 54
						0 204 103 971	↻
						0 204 004 452	→ 54
1.9D	09.00-12.05	51-52				0 204 004 451	← 54
						0 204 103 971	↻
						0 204 004 452	→ 54
2.0HDi	09.00-12.05	66				0 204 004 451	← 54
						0 204 103 971	↻
						0 204 004 452	→ 54
2.0HDi	09.00-12.01	80/100	Org.-Nr. →9184			0 986 473 505	↻ ← 57
2.0i 16V						0 986 474 505	↻ → 57
	01.02-12.05	80/100	Org.-Nr. 9185→			0 204 102 974	→ 54
						0 204 103 974	↻



	1.4 HDi	01.03-12.05	50			0 986 475 833	↔ 20,6
	1.4i	09.00-10.00	55	Org.-Nr. →8728		0 986 475 797	↔ 20,6
		11.00-12.05	55	Org.-Nr. 8729→		0 986 475 833	↔ 20,6
	1.9D	09.00-10.00	51-52	Org.-Nr. →8728		0 986 475 797	↔ 20,6
	11.00-12.05	51-52	Org.-Nr. 8729→		0 986 475 833	↔ 20,6	



		S														
◀ CITROEN Xsara [N7]																
	1.6 i 16V	09.00-12.05	80				0 204 102 277	← 32	0 204 100 098 <sup>8</sup>							
							0 204 103 277		0 204 104 068 <sup>9</sup>							
							0 986 473 983									
	2.0 HDi	09.00-12.05	66/80/100					0 204 102 277	← 32	0 204 100 098 <sup>8</sup>						
								0 204 103 277		0 204 104 068 <sup>9</sup>						
								0 986 473 983								
2.0 i 16V	09.00-12.05	66/80/100					0 204 102 278	→ 32	0 204 100 098 <sup>8</sup>							
							0 204 103 278									
							0 986 474 983									
	1.4 HDi	09.00-12.05	50/55				1 987 477 580	← 1591								
							1 987 477 581	→ 1500								
	1.6 i 16V	09.00-12.05	80					1 987 477 582	← 1635							
								1 987 477 583	→ 1545							
	1.9 D	09.00-12.05	51-52					1 987 477 580	← 1591							
								1 987 477 581	→ 1500							
2.0 HDi	09.00-12.05	66/80/100					1 987 477 582	← 1635								
							1 987 477 583	→ 1545								
	1.4 HDi	09.00-12.05	50/55				0 265 006 203 <sup>4</sup>									
							0 265 006 389 <sup>3</sup>									
	1.6 i 16V	09.00-12.05	80					0 265 006 202 <sup>4</sup>								
								0 265 006 389 <sup>3</sup>								
	1.9 D	09.00-12.05	51-52					0 265 006 203 <sup>4</sup>								
								0 265 006 389 <sup>3</sup>								
2.0 HDi	09.00-12.05	66/80/100					0 265 006 202 <sup>4</sup>									
							0 265 006 389 <sup>3</sup>									
<b>Xsara Picasso</b>																
	2.0 i 16V	10.00-06.12	100				LUC	0 986 473 026	← 54							
								0 986 474 026	→ 54							
							MFD	0 204 102 974	→ 54							
	2.0 i 16V	10.00-06.12	100					BO	0 204 103 974							
								OFD	0 204 004 451	← 54						
									0 204 103 971							
							0 204 004 452	→ 54								
	2.0 HDi	10.00-06.12	80					0 986 AB8 494	↔							
								2.0 i 16V	10.00-06.12	100					0 986 AB8 494	↔
															0 986 475 836	↔ 22,2
	2.0 i 16V	10.00-06.12	100					0 986 134 038	← 38							
								0 986 135 038	→ 38							
	2.0 i 16V	10.00-11.04	100					0 265 006 732 <sup>4</sup>								
								10.00-06.12	100		0 265 006 659 <sup>4</sup>					
										0 265 006 389 <sup>3</sup>						
										0 265 007 665 <sup>3</sup>						
			03.03-11.04	100						0 265 006 793 <sup>4</sup>						
			12.04-07.05	100						0 265 007 667 <sup>4</sup>						

		S								
2.0i 16V		12.04-06.12	100	Org.-Nr. 10221→	LAB		0 265 007 668 <sup>4</sup>			
		08.05-06.12	100	Org.-Nr. 10479→	RAB		0 265 007 883 <sup>4</sup>			
<b>Xsara Picasso [N68]</b>										
	1.6 HDi	01.00-04.10	66/74/80				BO	0 204 004 451	← 54	
	1.6 i						0 204 103 971			
	1.6 i 16V						0 204 004 452	→ 54		
							0 204 102 974	→ 54		
							0 204 103 974			
		LUC	0 986 473 026				← 54			
			0 986 474 026				→ 54			
	1.8 i	01.00-04.10	85				BO	0 204 004 451	← 54	
							0 204 103 971			
							0 204 004 452	→ 54		
	0 204 102 974			→ 54						
	0 204 103 974									
	LUC	0 986 473 026	← 54							
		0 986 474 026	→ 54							
2.0 HDi	01.00-04.10	66/100	BO	0 204 004 451	← 54					
2.0 i 16V			0 204 103 971							
			0 204 004 452	→ 54						
			0 204 102 974	→ 54						
			0 204 103 974							
	LUC	0 986 473 026	← 54							
		0 986 474 026	→ 54							
	1.6 i	01.00-04.10	66/74				0 986 475 836	↔ 22,2		
	1.8 i	01.00-04.10	85				0 986 475 836	↔ 22,2		
	2.0 HDi, i 16V	01.00-04.10	66/100				0 986 475 836	↔ 22,2		
	1.6 HDi, i, i 16V	01.00-04.10	66/80				0 986 134 038	← 38		
							0 986 135 038	→ 38		
	1.8 i	01.00-04.10	85				0 986 134 038	← 38		
							0 986 135 038	→ 38		
	2.0 HDi	01.00-04.10	66/100				0 986 134 038	← 38		
							0 986 135 038	→ 38		
2.0 i 16V										
	1.6 HDi	09.05-04.10	66				1 987 482 319	← 1860		
							1 987 482 320	→ 1950		
	1.6 HDi	05.04-04.10	80				1 987 482 319	← 1860		
							1 987 482 320	→ 1950		
	1.6 i	01.00-05.09	66				Org.-Nr. 08820 78→	LLE	1 987 477 590	← 1773
							11864 78, 08365 FV→,		1 987 477 591	→ 1864
							09821 UW→, 11249 CJ→			
			74				Org.-Nr. 08820 78→	LLE	1 987 477 590	← 1773
							11864 78, 08365 FV→,		1 987 477 591	→ 1864
							09821 UW→, 11249 CJ→			
		01.00-04.10	66					RLE	1 987 477 590	← 1773
								1 987 477 591	→ 1864	
			74					RLE	1 987 477 590	← 1773
									1 987 477 591	→ 1864
		06.09-04.10	66				Org.-Nr. 11865 78→	LLE	1 987 482 407	← 1775
					1 987 482 408	→ 1864				
	74			Org.-Nr. 11865 78→	LLE	1 987 482 407	← 1775			
					1 987 482 408	→ 1864				





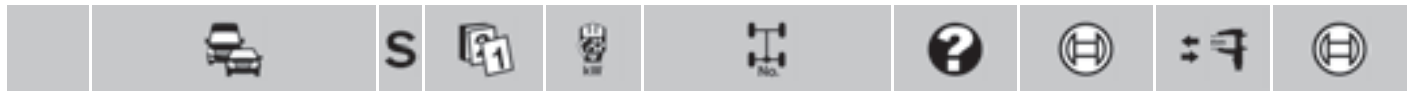









◀ CITROEN Xsara Picasso [N68]

	1.8 i	01.00-04.10	85	RLE,STB	1987 477 590	← 1773						
					1987 477 591	→ 1864						
					SBR	1987 482 319	← 1860					
						1987 482 320	→ 1950					
					Org.-Nr. 08820 78→ 11864 78, 08365 FV→, 09821 UW→, 11249 CJ→	LLE,STB	1987 477 590	← 1773				
							1987 477 591	→ 1864				
						LLE,STB	1987 482 407	← 1775				
						1987 482 408	→ 1864					
					2.0 HDi 2.0 i 16V	01.00-04.10	66/100	RLE,STB	1987 477 590	← 1773		
									1987 477 591	→ 1864		
SBR	1987 482 319	← 1860										
	1987 482 320	→ 1950										
Org.-Nr. 08820 78→ 11864 78, 08365 FV→, 09821 UW→, 11249 CJ→	LLE,STB	1987 477 590	← 1773									
		1987 477 591	→ 1864									
	LLE,STB	1987 482 407	← 1775									
	1987 482 408	→ 1864										
	1.6 HDi	05.04-04.10	80	Org.-Nr. →10220FV, →10312UW, →1031278					0 265 006 389 <sup>3</sup>			
									Org.-Nr. 09492 FV→10220 FV, 09821 UW→10312 UW	0 265 006 732 <sup>4</sup>		
					Org.-Nr. 10221FV→, 10313UW→, 1031378→	0 265 007 665 <sup>3</sup>						
						09.05-04.10	66		0 265 007 665 <sup>3</sup>			
								Org.-Nr. 09492 FV→10220 FV, 09821 UW→10312 UW	0 265 006 732 <sup>4</sup>			
		1.6 HDi 1.6 i	01.00-04.10	66	RAB	Org.-Nr. 10221 FV→ 10458 FV, 10313 UW→ 10458 UW, 10313 78→10458 78	0 265 007 667 <sup>4</sup>					
							Org.-Nr. 11249 CJ→, 10221 FV→, 10313 UW→, 10313 78→	LAB	0 265 007 668 <sup>4</sup>			
						Org.-Nr. 11249 CJ→, 10459 FV→, 10459 UW→, 10459 78→		RAB	0 265 007 883 <sup>4</sup>			
								1.6 HDi 1.6 i 16V	05.04-04.10	80	Org.-Nr. 10221 FV→ 10458 FV, 10313 UW→ 10458 UW, 10313 78→10458 78	RAB
									Org.-Nr. 11249 CJ→, 10221 FV→, 10313 UW→, 10313 78→	LAB	0 265 007 668 <sup>4</sup>	
			Org.-Nr. 11249 CJ→, 10459 FV→, 10459 UW→, 10459 78→	RAB	0 265 007 883 <sup>4</sup>							
1.6 i	01.00-04.10	66	RAB	Org.-Nr. →09582 FV, →09695 78	0 265 006 659 <sup>4</sup>							
					Org.-Nr. →10220FV, →10312UW, →1031278	0 265 006 389 <sup>3</sup>						
				Org.-Nr. 09583 FV→10220 FV, 09821 UW→10312 UW, 09696 78→10312 78		0 265 006 793 <sup>4</sup>						
						Org.-Nr. 10221FV→, 10313UW→, 1031378→	0 265 007 665 <sup>3</sup>					
				74			Org.-Nr. →09582 FV, →09695 78	0 265 006 659 <sup>4</sup>				
							Org.-Nr. →10220FV, →10312UW, →1031278	0 265 006 389 <sup>3</sup>				
							Org.-Nr. 09583 FV→10220 FV, 09821 UW→10312 UW, 09696 78→10312 78	0 265 006 793 <sup>4</sup>				

		<b>S</b>							
<b>1.6i</b>		01.00-04.10	74	Org.-Nr. 10221 FV→ 10458 FV, 10313 UW→ 10458 UW, 10313 78→10458 78	RAB		0 265 <b>007 667</b> <sup>4</sup>		
				Org.-Nr. 10221FV→, 10313UW→, 1031378→			0 265 <b>007 665</b> <sup>3</sup>		
				Org.-Nr. 11249 CJ→, 10221 FV→, 10313 UW→, 10313 78→	LAB		0 265 <b>007 668</b> <sup>4</sup>		
				Org.-Nr. 11249 CJ→, 10459 FV→, 10459 UW→, 10459 78→	RAB		0 265 <b>007 883</b> <sup>4</sup>		
<b>1.6i 16V</b>		03.05-04.10	80				0 265 <b>007 665</b> <sup>3</sup>		
				Org.-Nr. 09492 FV→10220 FV, 09821 UW→10312 UW			0 265 <b>006 732</b> <sup>4</sup>		
<b>1.8i</b>		01.00-04.10	85	Org.-Nr. →09582 FV, →09695 78	STB		0 265 <b>006 659</b> <sup>4</sup>		
				Org.-Nr. →10220FV, →10312UW, →1031278			0 265 <b>006 389</b> <sup>3</sup>		
				Org.-Nr. 09492 FV→ 10220 FV, 09821 UW→ 10312 UW	SBR		0 265 <b>006 732</b> <sup>4</sup>		
				Org.-Nr. 09583 FV→ 10220 FV, 09821 UW→ 10312 UW, 09696 78→10312 78	STB		0 265 <b>006 793</b> <sup>4</sup>		
				Org.-Nr. 10221 FV→ 10458 FV, 10313 UW→ 10458 UW, 10313 78→10458 78	RAB		0 265 <b>007 667</b> <sup>4</sup>		
				Org.-Nr. 10221FV→, 10313UW→, 1031378→			0 265 <b>007 665</b> <sup>3</sup>		
				Org.-Nr. 11249 CJ→, 10221 FV→, 10313 UW→, 10313 78→	LAB		0 265 <b>007 668</b> <sup>4</sup>		
				Org.-Nr. 11249 CJ→, 10459 FV→, 10459 UW→, 10459 78→	RAB		0 265 <b>007 883</b> <sup>4</sup>		
<b>2.0 HDi</b> <b>2.0i 16V</b>		01.00-04.10	66/100	Org.-Nr. →09582 FV, →09695 78	STB		0 265 <b>006 659</b> <sup>4</sup>		
				Org.-Nr. →10220FV, →10312UW, →1031278			0 265 <b>006 389</b> <sup>3</sup>		
				Org.-Nr. 09492 FV→ 10220 FV, 09821 UW→ 10312 UW	SBR		0 265 <b>006 732</b> <sup>4</sup>		
				Org.-Nr. 09583 FV→ 10220 FV, 09821 UW→ 10312 UW, 09696 78→10312 78	STB		0 265 <b>006 793</b> <sup>4</sup>		
				Org.-Nr. 10221 FV→ 10458 FV, 10313 UW→ 10458 UW, 10313 78→10458 78	RAB		0 265 <b>007 667</b> <sup>4</sup>		
				Org.-Nr. 10221FV→, 10313UW→, 1031378→			0 265 <b>007 665</b> <sup>3</sup>		
				Org.-Nr. 11249 CJ→, 10221 FV→, 10313 UW→, 10313 78→	LAB		0 265 <b>007 668</b> <sup>4</sup>		
				Org.-Nr. 11249 CJ→, 10459 FV→, 10459 UW→, 10459 78→	RAB		0 265 <b>007 883</b> <sup>4</sup>		











◀ CITROEN									
<b>ZX</b>									
	1.6 i8V	10.96→	65		INB	GIR	0 986 473 677	← 48	
							0 986 474 677	→ 48	
					INB	BRB, BSY	0 204 102 289	← 48	0 204 100 062 <sup>8</sup>
							0 986 473 103		0 204 104 039 <sup>7</sup>
							0 204 102 290	→ 48	0 204 100 062 <sup>8</sup>
							0 986 474 103		
	1.6 i8V	10.96→	65		GIM		0 986 475 797	↔ 20,6	
				Org.-Nr. 5718→	GIM		0 986 475 619	▲ ← 20,6	
							0 986 475 620	▲ → 20,6	
				Org.-Nr. 5719→	GIM		0 986 475 635	▲ → 20,6	
							0 986 475 636	▲ ← 20,6	
		ABO 10.96→	65	Org.-Nr. →5718		BRB, BSY	F 026 002 230	← 20,6	
							F 026 002 231	→ 20,6	
				Org.-Nr. 5719→		BRB, BSY	F 026 002 234	← 20,6	
							F 026 002 235	→ 20,6	
	1.6 i8V	10.96→	65				1 987 477 079	← 1585	
							1 987 477 323	→ 1493	
	1.6 i8V	10.96→	65				0 265 006 199 <sup>3</sup>		
							0 265 006 203 <sup>4</sup>		
<b>ZX [N20/N21]</b>									
	1.1	03.91-06.97	40-44			BSY	0 204 102 289	← 48	0 204 100 062 <sup>8</sup>
	1.1 i						0 986 473 103		0 204 104 039 <sup>7</sup>
							0 204 102 290	→ 48	0 204 100 062 <sup>8</sup>
							0 986 474 103		
	1.4	08.92-10.97	55			BSY	0 204 102 289	← 48	0 204 100 062 <sup>8</sup>
	1.4 i						0 986 473 103		0 204 104 039 <sup>7</sup>
							0 204 102 290	→ 48	0 204 100 062 <sup>8</sup>
							0 986 474 103		
	1.4D	06.94-06.97	37-39		LIM	BSY	0 204 102 289	← 48	0 204 100 062 <sup>8</sup>
							0 986 473 103		0 204 104 039 <sup>7</sup>
							0 204 102 290	→ 48	0 204 100 062 <sup>8</sup>
							0 986 474 103		
	1.5D	09.96-10.97	42		LIM	BSY	0 204 102 289	← 48	0 204 100 062 <sup>8</sup>
							0 986 473 103		0 204 104 039 <sup>7</sup>
							0 204 102 290	→ 48	0 204 100 062 <sup>8</sup>
							0 986 474 103		
	1.6 i	03.91-12.94	65-66				0 986 473 677	← 48	
							0 986 474 677	→ 48	
		07.92-10.97	65				0 986 473 677	← 48	
							0 986 474 677	→ 48	
		02.96-10.97	65-66			BSY			0 204 104 039 <sup>7</sup>
						GIR	0 986 473 350	→ 42,8	
	1.8D	03.91-10.97	44		LIM	BSY	0 204 102 289	← 48	0 204 100 062 <sup>8</sup>
							0 986 473 103		0 204 104 039 <sup>7</sup>
							0 204 102 290	→ 48	0 204 100 062 <sup>8</sup>
							0 986 474 103		
	1.8 i	07.92-02.98	74-76/81				0 986 473 677	← 48	
	1.8 i 16V						0 986 474 677	→ 48	



		S									
1.9D		03.91-10.97	47-48/50/ 51-52			KOB GIR	0 986 473 677		← 48		
							0 986 474 677		→ 48		
							LIM BSY	0 204 102 289		← 48	0 204 100 062 <sup>B</sup>
								0 986 473 103		↔ 48	0 204 104 039 <sup>7</sup>
								0 204 102 290		→ 48	0 204 100 062 <sup>B</sup>
							0 986 474 103				
1.9D Turbo		03.91-10.97	66/68/88-90/				0 986 473 677		← 48		
1.9i			93-96				0 986 474 677		→ 48		
2.0i		07.92-10.97	89-90				0 986 473 677		← 48		
							0 986 474 677		→ 48		
2.0i 16V		09.96-10.97	120-122				0 986 473 505		← 57		
							0 986 474 505		→ 57		
1.1		03.91-06.97	40-44			KOB BSY	F 026 009 179		↔ 20,64		
		1.1i	08.92-06.97	40-44	Org.-Nr. 5719→	GIM,LIM	0 986 475 635		▲ → 20,6		
							0 986 475 636		▲ ← 20,6		
		ABO	08.92-06.97	40-44	Org.-Nr. 5719→	LIM BSY	F 026 002 234		← 20,6		
							F 026 002 235		→ 20,6		
		ABS	06.95-06.97	40-44	Org.-Nr. 6749→	LIM	0 986 475 797		↔ 20,6		
1.4		08.92-10.97	37-39/55			KOB BSY	F 026 009 179		↔ 20,64		
1.4D					Org.-Nr. 5719→	GIM,LIM	0 986 475 635		▲ → 20,6		
1.4i							0 986 475 636		▲ ← 20,6		
		ABO	08.92-10.97	37-39/55	Org.-Nr. 5719→	LIM BSY	F 026 002 234		← 20,6		
							F 026 002 235		→ 20,6		
		ABS	06.95-10.97	37-39/55	Org.-Nr. 6749→	LIM	0 986 475 797		↔ 20,6		
1.5D		09.96-10.97	42			KOB BSY	F 026 009 179		↔ 20,64		
					Org.-Nr. 5719→	GIM,LIM	0 986 475 635		▲ → 20,6		
							0 986 475 636		▲ ← 20,6		
		ABO	09.96-10.97	42	Org.-Nr. 5719→	LIM BSY	F 026 002 234		← 20,6		
							F 026 002 235		→ 20,6		
		ABS	09.96-10.97	42	Org.-Nr. 6749→	LIM	0 986 475 797		↔ 20,6		
1.6i		03.91-10.97	65-66			KOB BSY	F 026 009 179		↔ 20,64		
		08.92-10.97	65-66	Org.-Nr. 5719→		GIM,LIM	0 986 475 635		▲ → 20,6		
							0 986 475 636		▲ ← 20,6		
		ABO	08.92-10.97	65-66	Org.-Nr. 5719→	LIM BSY	F 026 002 234		← 20,6		
							F 026 002 235		→ 20,6		
		ABS	06.95-10.97	65-66	Org.-Nr. 6749→	LIM	0 986 475 797		↔ 20,6		
1.8D		03.91-10.97	44/74-76			KOB BSY	F 026 009 179		↔ 20,64		
1.8i		08.92-10.97	44/74-76	Org.-Nr. 5719→		GIM,LIM	0 986 475 635		▲ → 20,6		
							0 986 475 636		▲ ← 20,6		
		ABO	08.92-10.97	44/74-76	Org.-Nr. 5719→	LIM BSY	F 026 002 234		← 20,6		
							F 026 002 235		→ 20,6		
		ABS	06.95-10.97	44/74-76	Org.-Nr. 6749→	LIM	0 986 475 797		↔ 20,6		
1.8i 16V		01.96-02.98	81			KOB BSY	F 026 009 179		↔ 20,64		
						LIM	0 986 475 797		↔ 20,6		
1.9D		03.91-10.97	47-48/50/ 51-52			KOB BSY	F 026 009 179		↔ 20,64		
		08.92-10.97	47-48/50/ 51-52	Org.-Nr. 5719→		GIM,LIM	0 986 475 635		▲ → 20,6		
							0 986 475 636		▲ ← 20,6		
		ABO	08.92-10.97	47-48/50/ 51-52	Org.-Nr. 5719→	LIM BSY	F 026 002 234		← 20,6		
							F 026 002 235		→ 20,6		
		ABS	06.95-10.97	50/51-52	Org.-Nr. 6749→	LIM	0 986 475 797		↔ 20,6		
1.6i		03.91-10.97	65-66				0 204 102 075		← 30	0 204 100 062 <sup>B</sup>	
							0 986 134 098			0 204 104 068 <sup>9</sup>	
							0 204 102 077		→ 30	0 204 100 062 <sup>B</sup>	
							0 204 103 077				
							0 986 135 098				



		S							
◀ CITROEN ZX [N20/N21]									
1.8 i		07.92-02.98	74-76/81				0 204 102 075	← 30	0 204 100 062 <sup>8</sup>
1.8 i 16V							0 986 134 098		0 204 104 068 <sup>9</sup>
							0 204 102 077	→ 30	0 204 100 062 <sup>8</sup>
							0 204 103 077		
							0 986 135 098		
1.9 D Turbo		03.91-10.97	66/68/				0 204 102 075	← 30	0 204 100 062 <sup>8</sup>
1.9 i			88-90/				0 986 134 098		0 204 104 068 <sup>9</sup>
			93-96				0 204 102 077	→ 30	0 204 100 062 <sup>8</sup>
							0 204 103 077		
							0 986 135 098		
2.0 i		07.92-10.97	89-90				0 204 102 075	← 30	0 204 100 062 <sup>8</sup>
							0 986 134 098		0 204 104 068 <sup>9</sup>
							0 204 102 077	→ 30	0 204 100 062 <sup>8</sup>
							0 204 103 077		
							0 986 135 098		
2.0 i 16V		07.92-10.97	110-114/ 120-122				0 204 102 277	← 32	0 204 100 062 <sup>8</sup>
							0 204 103 277		0 204 104 068 <sup>9</sup>
							0 986 473 983		
							0 204 102 278	→ 32	0 204 100 062 <sup>8</sup>
							0 204 103 278		
							0 986 474 983		
1.1		03.91-08.96	40-44	Org.-Nr. →7330	KOB,TBR	1 987 477 436	1621		
					LIM,TBR	1 987 477 079	← 1585		
						1 987 477 323	→ 1493		
1.1 i		10.91-12.96	44	Org.-Nr. →7330	KOB,TBR	1 987 477 436	1621		
					LIM,TBR	1 987 477 079	← 1585		
						1 987 477 323	→ 1493		
		01.97-06.97	44	Org.-Nr. 7331→	KOB,TBR	1 987 477 445	← 1520		
						1 987 477 446	→ 1610		
					LIM,TBR	1 987 477 443	← 1582		
						1 987 482 103	→ 1488		
1.4		08.92-12.96	37-39/55	Org.-Nr. →7330	KOB,TBR	1 987 477 436	1621		
1.4 D					LIM,TBR	1 987 477 079	← 1585		
1.4 i						1 987 477 323	→ 1493		
1.4 D		01.97-10.97	37-39/55	Org.-Nr. 7331→	KOB,TBR	1 987 477 445	← 1520		
1.4 i						1 987 477 446	→ 1610		
					LIM,TBR	1 987 477 443	← 1582		
						1 987 482 103	→ 1488		
1.5 D		09.96-12.96	42	Org.-Nr. →7330	KOB,TBR	1 987 477 436	1621		
					LIM,TBR	1 987 477 079	← 1585		
						1 987 477 323	→ 1493		
		01.97-10.97	42	Org.-Nr. 7331→	KOB,TBR	1 987 477 445	← 1520		
						1 987 477 446	→ 1610		
					LIM,TBR	1 987 477 443	← 1582		
						1 987 482 103	→ 1488		
1.6 i		03.91-12.94	65-66	Org.-Nr. →7330	KOB,TBR	1 987 477 436	1621		
					LIM,TBR	1 987 477 079	← 1585		
						1 987 477 323	→ 1493		
		07.92-12.96	65	Org.-Nr. →7330	KOB,TBR	1 987 477 436	1621		
					LIM,TBR	1 987 477 079	← 1585		
						1 987 477 323	→ 1493		
		02.96-12.96	65-66	Org.-Nr. →7330	KOB,TBR	1 987 477 436	1621		
					LIM,TBR	1 987 477 079	← 1585		
						1 987 477 323	→ 1493		
		01.97-10.97	65	Org.-Nr. 7331→	KOB,TBR	1 987 477 445	← 1520		
						1 987 477 446	→ 1610		
					LIM,TBR	1 987 477 443	← 1582		
						1 987 482 103	→ 1488		
			65-66	Org.-Nr. 7331→	KOB,TBR	1 987 477 445	← 1520		
						1 987 477 446	→ 1610		

		S							
<b>1.8D</b>		03.91-12.96	44/74-76	Org.-Nr. →7330	KOB,TBR		1 987 477 436	1621	
							LIM,TBR	1 987 477 079	← 1585
<b>1.8i</b>		01.97-10.97	44/74-76	Org.-Nr. 7331→	KOB,TBR		1 987 477 323	→ 1493	
							LIM,TBR	1 987 477 445	← 1520
							1 987 477 446	→ 1610	
							LIM,TBR	1 987 477 443	← 1582
							1 987 482 103	→ 1488	
<b>1.8i 16V</b>		01.96-12.96	81	Org.-Nr. →7330	KOB,TBR		1 987 477 436	1621	
							LIM,TBR	1 987 477 079	← 1585
		01.97-02.98	81	Org.-Nr. 7331→	KOB,TBR		1 987 477 323	→ 1493	
							LIM,TBR	1 987 477 445	← 1520
							1 987 477 446	→ 1610	
							LIM,TBR	1 987 477 443	← 1582
							1 987 482 103	→ 1488	
							4SB	1 987 482 113	← 1606
							1 987 482 114	→ 1530	
<b>1.9D</b>		03.91-04.94	47-48	Org.-Nr. →7330	KOB,TBR		1 987 477 436	1621	
							LIM,TBR	1 987 477 079	← 1585
		03.91-12.96	50/51-52	Org.-Nr. →7330	KOB,TBR		1 987 477 323	→ 1493	
							LIM,TBR	1 987 477 436	← 1520
		01.97-10.97	50/51-52	Org.-Nr. 7331→	KOB,TBR		1 987 477 445	← 1520	
							LIM,TBR	1 987 477 446	→ 1610
							1 987 477 443	← 1582	
								1 987 482 103	→ 1488
<b>1.9D Turbo</b>		07.92-12.96	66/68	Org.-Nr. →7330	KOB,TBR		1 987 477 436	1621	
							LIM,TBR	1 987 477 079	← 1585
		01.97-10.97	66/68	Org.-Nr. 7331→	KOB,TBR		1 987 477 323	→ 1493	
							LIM,TBR	1 987 477 445	← 1520
							1 987 477 446	→ 1610	
							LIM,TBR	1 987 477 443	← 1582
							1 987 482 103	→ 1488	
							4SB	1 987 482 113	← 1606
							1 987 482 114	→ 1530	
<b>1.9i</b>		01.97-10.97	88-90/ 93-96	Org.-Nr. 7331→	4SB		1 987 482 113	← 1606	
<b>2.0i</b>		01.97-10.97	89-90/ 110-114/ 120-122	Org.-Nr. 7331→	4SB		1 987 482 114	→ 1530	
<b>2.0i 16V</b>							1 987 482 114	→ 1530	
	<b>1.1</b>	03.91-04.95	40-44	Org.-Nr. →6748	LIM,SBR		0 265 006 204 <sup>4</sup>		
							03.91-08.96	40-44	
		05.95-08.96	40-44	Org.-Nr. 6749→	HTB,LIM		0 265 006 204 <sup>4</sup>		
<b>1.1i</b>		10.91-03.94	44				0 265 006 204 <sup>4</sup>		
							10.91-06.97	44	
		04.94-04.95	44	Org.-Nr. →6748	LIM,SBR		0 265 006 204 <sup>4</sup>		
							04.94-06.97	44	
		05.95-06.97	44	Org.-Nr. 6749→	HTB,LIM		0 265 006 203 <sup>4</sup>		
<b>1.4</b>		08.92-04.95	37-39/55	Org.-Nr. →6748	LIM,SBR		0 265 006 204 <sup>4</sup>		
<b>1.4D</b>		08.92-10.97	37-39/55				0 265 006 199 <sup>3</sup>		
<b>1.4i</b>					KOB		0 265 006 204 <sup>4</sup>		
		05.95-10.97	37-39/55	Org.-Nr. 6749→	HTB,LIM		0 265 006 203 <sup>4</sup>		
<b>1.5D</b>		09.96-10.97	42				0 265 006 199 <sup>3</sup>		
							0 265 006 204 <sup>4</sup>		
<b>1.6i</b>		03.91-12.94	65-66	Org.-Nr. 6749→	HTB,LIM		0 265 006 204 <sup>4</sup>		
		07.92-04.95	65	Org.-Nr. →6748	LIM,SBR		0 265 006 204 <sup>4</sup>		
							07.92-10.97	65	
							0 265 006 204 <sup>4</sup>		



		S				?			
<b>CITROEN ZX [N20/N21]</b>									
1.6 i	05.95-10.97	65	Org.-Nr. 6749→	HTB,LIM	0 265 006 203 <sup>4</sup>				
	02.96-10.97	65-66			0 265 006 199 <sup>3</sup>				
			Org.-Nr. 6749→	KOB	0 265 006 204 <sup>4</sup>				
			HTB,LIM	0 265 006 203 <sup>4</sup>					
1.8 D	03.91-04.95	44/74-76	Org.-Nr. →6748	LIM,SBR	0 265 006 204 <sup>4</sup>				
1.8 i	03.91-10.97	44/74-76			0 265 006 199 <sup>3</sup>				
				KOB	0 265 006 204 <sup>4</sup>				
	05.95-10.97	44/74-76	Org.-Nr. 6749→	HTB,LIM	0 265 006 203 <sup>4</sup>				
1.8 i 16V	01.96-02.98	81			0 265 006 199 <sup>3</sup>				
				KOB	0 265 006 204 <sup>4</sup>				
				LIM,SBR	0 265 006 202 <sup>4</sup>				
			Org.-Nr. 6749→	HTB,LIM	0 265 006 203 <sup>4</sup>				
1.9 D	03.91-04.94	47-48			0 265 006 199 <sup>3</sup>				
					0 265 006 204 <sup>4</sup>				
	03.91-04.95	50/51-52	Org.-Nr. →6748	LIM,SBR	0 265 006 204 <sup>4</sup>				
	03.91-10.97	50/51-52			0 265 006 199 <sup>3</sup>				
				KOB	0 265 006 204 <sup>4</sup>				
	05.95-10.97	50/51-52	Org.-Nr. 6749→	HTB,LIM	0 265 006 203 <sup>4</sup>				
1.9 D Turbo	07.92-10.97	66/68			0 265 006 199 <sup>3</sup>				
				KOB	0 265 006 204 <sup>4</sup>				
				LIM,SBR	0 265 006 202 <sup>4</sup>				
	05.95-10.97	66/68	Org.-Nr. 6749→	HTB,LIM	0 265 006 203 <sup>4</sup>				
1.9 i	03.91-10.97	88-90/			0 265 006 199 <sup>3</sup>				
		93-96			0 265 006 204 <sup>4</sup>				
				KOB	0 265 006 204 <sup>4</sup>				
				LIM	0 265 006 202 <sup>4</sup>				
2.0 i	07.92-10.97	89-90/			0 265 006 199 <sup>3</sup>				
2.0 i 16V		110-114			0 265 006 204 <sup>4</sup>				
				KOB	0 265 006 204 <sup>4</sup>				
				LIM	0 265 006 202 <sup>4</sup>				
2.0 i 16V	09.96-10.97	120-122			0 265 006 199 <sup>3</sup>				
				KOB	0 265 006 204 <sup>4</sup>				



**DACIA**

**Dokker [FE/FK]**

	1.2	OFD 07.12→	85		0 986 134 329		← 54		
					0 986 135 329		→ 54		
	1.5 dCi	OFD 07.12→	55/66		0 986 134 329		← 54		
					0 986 135 329		→ 54		
	1.6	OFD 07.12→	61		0 986 134 329		← 54		
					0 986 135 329		→ 54		

	1.2	07.12→	85		F 026 002 573		↔ 22,2				
				1.5 dCi	07.12→	55/66		F 026 002 573		↔ 22,2	
								F 026 002 573		↔ 22,2	
1.6	07.12→	61		F 026 002 573		↔ 22,2					

**Dokker [FE/KE]**

	1.6	OFD 07.12→	61		0 986 134 329		← 54		
					0 986 135 329		→ 54		
	1.6	07.12→	61		F 026 002 573		↔ 22,2		

		S									
<b>Duster [HS]</b>											
	<b>1.2</b>	09.13→	92				TW	0 986 <b>134 329</b>		← 54	
								0 986 <b>135 329</b>		→ 54	
	<b>1.5 dCi</b>	10.09→	63/66/79/				TW	0 986 <b>134 329</b>		← 54	
	<b>1.5 dCi 4x4</b>		80/81					0 986 <b>135 329</b>		→ 54	
	<b>1.6</b>	10.09→	77				TW	0 986 <b>134 329</b>		← 54	
	<b>1.6 4x4</b>							0 986 <b>135 329</b>		→ 54	
	<b>1.2</b>	09.13→	92					F 026 <b>002 572</b>		↔ 19	
	<b>1.5 dCi</b>	10.09→	63					F 026 <b>002 572</b>		↔ 19	
			79					F 026 <b>002 572</b>		↔ 19	
		12.10→	66					F 026 <b>002 572</b>		↔ 19	
	<b>1.5 dCi</b>	10.09→	80/81					0 986 <b>475 987</b>		← 19,05	
	<b>1.5 dCi 4x4</b>							0 986 <b>475 988</b>		→ 19,05	
	<b>1.5 dCi 4x4</b>	12.10→	66					0 986 <b>475 987</b>		← 19,05	
								0 986 <b>475 988</b>		→ 19,05	
	<b>1.6</b>	10.09→	77					F 026 <b>002 572</b>		↔ 19	
			09.13→	77					0 986 <b>475 987</b>		← 19,05
	<b>1.6, 4x4</b>	10.09→	77						0 986 <b>475 988</b>		→ 19,05
	<b>1.6 4x4</b>	10.09→	77						0 986 <b>475 987</b>		← 19,05
	<b>1.2</b>	09.13→	92					1 987 <b>482 410</b>		↔ 1787	
	<b>1.5 dCi</b>	10.09→	63					1 987 <b>482 410</b>		↔ 1787	
			79					1 987 <b>482 410</b>		↔ 1787	
		12.10→	66					1 987 <b>482 410</b>		↔ 1787	
		09.13→	80/81					1 987 <b>482 411</b>		↔ 1720	
	<b>1.5 dCi 4x4</b>	10.09→	80/81					1 987 <b>482 411</b>		↔ 1720	
		12.10→	66					1 987 <b>482 411</b>		↔ 1720	
	<b>1.6</b>	10.09→	77					1 987 <b>482 410</b>		↔ 1787	
			09.13→	77				1 987 <b>482 411</b>		↔ 1720	
	<b>1.6 4x4</b>	10.09→	77					1 987 <b>482 411</b>		↔ 1720	
	<b>1.2</b>	09.13→	92					0 265 <b>008 941</b> <sup>3</sup>			
								LAB	0 265 <b>008 937</b> <sup>4</sup>		
								RAB	0 265 <b>008 936</b> <sup>4</sup>		
									0 265 <b>008 941</b> <sup>3</sup>		
								LAB	0 265 <b>008 937</b> <sup>4</sup>		
								RAB	0 265 <b>008 936</b> <sup>4</sup>		
	<b>1.5 dCi</b>	10.09→	63					0 265 <b>008 941</b> <sup>3</sup>			
								LAB	0 265 <b>008 937</b> <sup>4</sup>		
								RAB	0 265 <b>008 936</b> <sup>4</sup>		
									0 265 <b>008 941</b> <sup>3</sup>		
								LAB	0 265 <b>008 937</b> <sup>4</sup>		
								RAB	0 265 <b>008 936</b> <sup>4</sup>		
	<b>1.5 dCi</b>	10.09→	80/81					0 265 <b>008 941</b> <sup>3</sup>			
								LAB	0 265 <b>008 937</b> <sup>4</sup>		
								RAB	0 265 <b>008 936</b> <sup>4</sup>		
									0 265 <b>008 941</b> <sup>3</sup>		
								LAB	0 265 <b>008 937</b> <sup>4</sup>		
								RAB	0 265 <b>008 936</b> <sup>4</sup>		
<b>1.5 dCi 4x4</b>	12.10→	66					0 265 <b>008 941</b> <sup>3</sup>				
							LAB	0 265 <b>008 937</b> <sup>4</sup>			
							RAB	0 265 <b>008 936</b> <sup>4</sup>			
								0 265 <b>008 941</b> <sup>3</sup>			
							LAB	0 265 <b>008 937</b> <sup>4</sup>			
							RAB	0 265 <b>008 936</b> <sup>4</sup>			
<b>1.6</b>	10.09→	77					0 265 <b>008 941</b> <sup>3</sup>				
							LAB	0 265 <b>008 937</b> <sup>4</sup>			
							RAB	0 265 <b>008 936</b> <sup>4</sup>			
								0 265 <b>008 941</b> <sup>3</sup>			
							LAB	0 265 <b>008 937</b> <sup>4</sup>			
							RAB	0 265 <b>008 936</b> <sup>4</sup>			
<b>1.6, 4x4</b>	10.09→	77					0 265 <b>008 942</b> <sup>4</sup>				
<b>1.6 4x4</b>	10.09→	77					0 265 <b>008 941</b> <sup>3</sup>				





		S									
◀ DACIA											
<b>Lodgy [JS]</b>											
	1.2	OFD	03.12→	85			0986 134 329		← 54		
							0986 135 329		→ 54		
	1.5 dCi	OFD	03.12→	66/79			0986 134 329		← 54		
							0986 135 329		→ 54		
	1.6	OFD	03.12→	61			0986 134 329		← 54		
							0986 135 329		→ 54		
	1.2		03.12→	85			F 026 002 573		↔ 22,2		
	1.5 dCi		03.12→	66/79			F 026 002 573		↔ 22,2		
	1.6		03.12→	61			F 026 002 573		↔ 22,2		
<b>Logan [LS]</b>											
	1.2		07.04→	55	B59		0986 473 677		← 48		
							0986 474 677		→ 48		
							238,B25	0986 473 671		← 48	
								0986 474 671		→ 48	
	1.4		07.04→	55	B59		0986 473 677		← 48		
							0986 474 677		→ 48		
							238,B25	0986 473 671		← 48	
								0986 474 671		→ 48	
	1.5 dCi		06.05→	48/50/55/ 63/65	B59		0986 473 677		← 48		
							0986 474 677		→ 48		
							238,B25	0986 473 671		← 48	
								0986 474 671		→ 48	
1.6 1.6 16V		07.04→	62/64/77	B59		0986 473 677		← 48			
						0986 474 677		→ 48			
						238,B25	0986 473 671		← 48		
							0986 474 671		→ 48		
	1.2		07.04→	55			F 026 002 480		↔ 19,05		
							BSY	F 026 002 249		↔ 17,5	
							TRW	0986 475 837		↔ 17,46	
	1.4		07.04→	55				F 026 002 480		↔ 19,05	
								BSY	F 026 002 249		↔ 17,5
								TRW	0986 475 837		↔ 17,46
	1.5 dCi		06.05→	48/50/55/ 63/65				F 026 002 480		↔ 19,05	
								BSY	F 026 002 249		↔ 17,5
								TRW	0986 475 837		↔ 17,46
	1.6 1.6 16V		07.04→	62/64/77				F 026 002 480		↔ 19,05	
								BSY	F 026 002 249		↔ 17,5
								TRW	0986 475 837		↔ 17,46
	1.2		07.04→	55			1987 477 955		↔ 1680		
							1987 477 956		↔ 1667		
	1.4		07.04→	55				1987 482 233		↔ 1993	
								1987 477 955		↔ 1680	
	1.5 dCi		06.05→	48				1987 477 956		↔ 1667	
								10.05→	50	1987 482 233	
			63				1987 482 233		↔ 1993		



		S							
1.5 dCi		11.10→	55				1 987 477 955	↔ 1680	
			65				1 987 477 956	↔ 1667	
							1 987 477 955	↔ 1680	
							1 987 477 956	↔ 1667	
1.6		07.04→	64/77				1 987 482 233	↔ 1993	
		11.10→	62				1 987 477 955	↔ 1680	
							1 987 477 956	↔ 1667	
1.6 16V		12.05→	64/77				1 987 482 233	↔ 1993	
1.2		07.04-01.08	55		LAB		0 265 007 583 <sup>4</sup>		
					RAB		0 265 007 582 <sup>4</sup>		
		07.04→	55				0 265 008 922 <sup>3</sup>		
		02.08→	55				0 265 008 297 <sup>4</sup>		
1.4		07.04-01.08	55		LAB		0 265 007 583 <sup>4</sup>		
					RAB		0 265 007 582 <sup>4</sup>		
		07.04→	55				0 265 008 922 <sup>3</sup>		
		02.08→	55				0 265 008 297 <sup>4</sup>		
1.5 dCi		06.05-01.08	48/50		LAB		0 265 007 583 <sup>4</sup>		
					RAB		0 265 007 582 <sup>4</sup>		
		06.05→	48/50				0 265 008 922 <sup>3</sup>		
		10.05-01.08	63		LAB		0 265 007 583 <sup>4</sup>		
					RAB		0 265 007 582 <sup>4</sup>		
		10.05→	63				0 265 008 922 <sup>3</sup>		
		02.08→	48/50				0 265 008 297 <sup>4</sup>		
			63				0 265 008 297 <sup>4</sup>		
		11.10→	55				0 265 008 922 <sup>3</sup>		
					LAB		0 265 008 946 <sup>4</sup>		
					RAB		0 265 008 947 <sup>4</sup>		
			65				0 265 008 922 <sup>3</sup>		
					LAB		0 265 008 946 <sup>4</sup>		
					RAB		0 265 008 947 <sup>4</sup>		
1.6		11.10→	62				0 265 008 922 <sup>3</sup>		
					LAB		0 265 008 946 <sup>4</sup>		
					RAB		0 265 008 947 <sup>4</sup>		
1.6		07.04-01.08	64/77		LAB		0 265 007 583 <sup>4</sup>		
1.6 16V					RAB		0 265 007 582 <sup>4</sup>		
		07.04→	64/77				0 265 008 922 <sup>3</sup>		
		02.08→	64/77				0 265 008 297 <sup>4</sup>		
<b>Logan [L8]</b>									
0.9		08.12→	66				F 026 002 249	↔ 17,5	
1.2		08.12→	53/55				F 026 002 249	↔ 17,5	
1.5 dCi		08.12→	55/66				F 026 002 249	↔ 17,5	
0.9		08.12→	66				1 987 477 955	↔ 1680	
1.2		08.12→	53/55				1 987 477 955	↔ 1680	
1.5 dCi		08.12→	55/66				1 987 477 955	↔ 1680	
<b>Logan MCV [KS/FS]</b>									
1.4		01.07→	55		B59		0 986 473 677	↔ 48	
							0 986 474 677	↔ 48	
1.5 dCi		01.07→	50/55/63/		B59		0 986 473 677	↔ 48	
			65				0 986 474 677	↔ 48	
1.6		01.07→	62/64/77		B59		0 986 473 677	↔ 48	
1.6 16V							0 986 474 677	↔ 48	



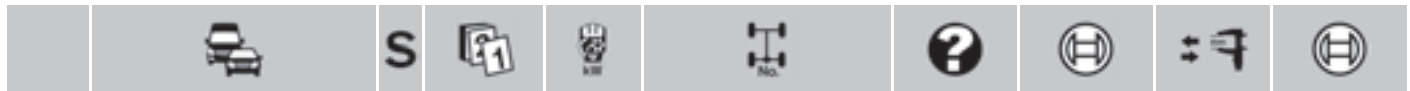

◀ DACIA Logan MCV [KS/FS]



	1.4	ABO 01.07→	55		F 026 <b>002 572</b>	↔ 19
		ABS 01.07→	55		F 026 <b>002 573</b>	↔ 22,2
	1.5 dCi	ABO 01.07→	50/55/63/65		F 026 <b>002 572</b>	↔ 19
		ABS 01.07→	50/55/63/65		F 026 <b>002 573</b>	↔ 22,2
	1.6	ABO 01.07→	62/64/77		F 026 <b>002 572</b>	↔ 19
	1.6 16V	ABS 01.07→	62/64/77		F 026 <b>002 573</b>	↔ 22,2



	1.4	01.07→	55		1987 <b>482 233</b>	↔ 1993
	1.5 dCi	01.07→	50/55/63/65		1987 <b>482 233</b>	↔ 1993
	1.6	01.07→	62/64/77		1987 <b>482 233</b>	↔ 1993
	1.6 16V	01.07→	62/64/77		1987 <b>482 233</b>	↔ 1993

	1.4	01.07→	55		0 265 <b>008 922</b> <sup>3</sup>	
				LAB	0 265 <b>007 583</b> <sup>4</sup>	
				RAB	0 265 <b>007 582</b> <sup>4</sup>	
	1.5 dCi	01.07→	50		0 265 <b>008 922</b> <sup>3</sup>	
				LAB	0 265 <b>007 583</b> <sup>4</sup>	
				RAB	0 265 <b>007 582</b> <sup>4</sup>	
			63		0 265 <b>008 922</b> <sup>3</sup>	
				LAB	0 265 <b>007 583</b> <sup>4</sup>	
				RAB	0 265 <b>007 582</b> <sup>4</sup>	
	1.6	11.10→	55		0 265 <b>008 922</b> <sup>3</sup>	
				LAB	0 265 <b>008 946</b> <sup>4</sup>	
				RAB	0 265 <b>008 947</b> <sup>4</sup>	
65				0 265 <b>008 922</b> <sup>3</sup>		
			LAB	0 265 <b>008 946</b> <sup>4</sup>		
			RAB	0 265 <b>008 947</b> <sup>4</sup>		
1.6	11.10→	62		0 265 <b>008 922</b> <sup>3</sup>		
			LAB	0 265 <b>008 946</b> <sup>4</sup>		
1.6 16V	01.07→	64/77		0 265 <b>008 922</b> <sup>3</sup>		
			RAB	0 265 <b>007 583</b> <sup>4</sup>		
				RAB	0 265 <b>007 582</b> <sup>4</sup>	

Logan MCV [K8]



	0.9	03.13→	66		F 026 <b>002 572</b>	↔ 19
	1.2	03.13→	53/55		F 026 <b>002 572</b>	↔ 19
	1.5 dCi	03.13→	55/66		F 026 <b>002 572</b>	↔ 19

Logan Pick-Up [US]































	1.5 dCi	12.08→	50		0986 <b>134 329</b>	↔ 54
					0986 <b>135 329</b>	↔ 54
					0986 <b>134 329</b>	↔ 54
			63		0986 <b>135 329</b>	↔ 54
					0986 <b>134 329</b>	↔ 54
					0986 <b>135 329</b>	↔ 54
	1.6	12.08→	55		TRW 0986 <b>134 329</b>	↔ 54
					TRW 0986 <b>135 329</b>	↔ 54
					TRW 0986 <b>134 329</b>	↔ 54
			65		TRW 0986 <b>134 329</b>	↔ 54
					TRW 0986 <b>135 329</b>	↔ 54
					TRW 0986 <b>134 329</b>	↔ 54
1.6	12.08→	64		0986 <b>134 329</b>	↔ 54	
				0986 <b>135 329</b>	↔ 54	
		11.10→	62		TRW 0986 <b>134 329</b>	↔ 54
					TRW 0986 <b>135 329</b>	↔ 54

		S							
	1.5 dCi	01.07→	50/55/63/65				F 026 002 573	↔ 22,2	
	1.6	01.07→	62/64				F 026 002 573	↔ 22,2	
	1.5 dCi	01.07→	50/55/63/65				1 987 482 233	↔ 1993	
	1.6	01.07→	62/64				1 987 482 233	↔ 1993	
	1.5 dCi	01.07→	50/55/63/65				0 265 008 922 <sup>3</sup>		
	1.6	01.07→	62/64				0 265 008 922 <sup>3</sup>		
<b>Nova</b>									
	1.6 i	05.96-09.00	53				F 026 002 080	↔ 22,2	
<b>Sandero [BS]</b>									
	1.2	06.08→	55		B59		0 986 473 677	↔ 48	
							0 986 474 677	↔ 48	
					238,B25		0 986 473 671	↔ 48	
							0 986 474 671	↔ 48	
	1.4	06.08→	55		B59		0 986 473 677	↔ 48	
							0 986 474 677	↔ 48	
					238,B25		0 986 473 671	↔ 48	
							0 986 474 671	↔ 48	
	1.5 dCi	06.08→	48/55/63/65		B59		0 986 473 677	↔ 48	
							0 986 474 677	↔ 48	
					238,B25		0 986 473 671	↔ 48	
							0 986 474 671	↔ 48	
	1.6	06.08→	62/64/77		B59		0 986 473 677	↔ 48	
	1.6 16V						0 986 474 677	↔ 48	
					238,B25		0 986 473 671	↔ 48	
							0 986 474 671	↔ 48	
	1.2	06.08→	55				F 026 002 480	↔ 19,05	
						BSY	F 026 002 249	↔ 17,5	
						TRW	0 986 475 837	↔ 17,46	
	1.4	06.08→	55				F 026 002 480	↔ 19,05	
						BSY	F 026 002 249	↔ 17,5	
						TRW	0 986 475 837	↔ 17,46	
	1.5 dCi	06.08→	48				BSY F 026 002 249	↔ 17,5	
			55/63/65				F 026 002 480	↔ 19,05	
						BSY	F 026 002 249	↔ 17,5	
						TRW	0 986 475 837	↔ 17,46	
	1.6	06.08→	62/64				F 026 002 480	↔ 19,05	
						BSY	F 026 002 249	↔ 17,5	
						TRW	0 986 475 837	↔ 17,46	
	1.6 16V	11.10→	77				F 026 002 249	↔ 17,5	
	1.2	06.08→	55				1 987 482 234	↔ 1658	
	1.4	06.08→	55				1 987 482 234	↔ 1658	
	1.5 dCi	06.08→	48/55/63/65				1 987 482 234	↔ 1658	
	1.6	06.08→	62/64/77				1 987 482 234	↔ 1658	
	1.6 16V	11.10→	62/64/77				1 987 482 234	↔ 1658	



		S				?			
◀ DACIA Sandero [BS]									
	1.2	06.08→	55				0 265 008 922 <sup>3</sup>		
						LAB	0 265 008 946 <sup>4</sup>		
						RAB	0 265 008 947 <sup>4</sup>		
	1.4	06.08→	55				0 265 008 922 <sup>3</sup>		
						LAB	0 265 008 946 <sup>4</sup>		
						RAB	0 265 008 947 <sup>4</sup>		
	1.5 dCi	06.08→	48/55/63/ 65				0 265 008 922 <sup>3</sup>		
						LAB	0 265 008 946 <sup>4</sup>		
						RAB	0 265 008 947 <sup>4</sup>		
	1.6	06.08→	62/64/77				0 265 008 922 <sup>3</sup>		
	1.6 16V					LAB	0 265 008 946 <sup>4</sup>		
						RAB	0 265 008 947 <sup>4</sup>		
Sandero [B8]									
	0.9	08.12→	66				F 026 002 249	↔ 17,5	
	1.2	08.12→	53/55				F 026 002 249	↔ 17,5	
	1.5 dCi	08.12→	55/63/66				F 026 002 249	↔ 17,5	
	1.6	08.12→	61				F 026 002 249	↔ 17,5	
Serie 1300									
	1310 1.3	01.79-12.98	40				F 026 002 073	↔ 22	
Solenza									
	1.4 i	04.03-04.05	55				F 026 002 080	↔ 22,2	
DAEWOO									
Cielo									
	1.5 i	08.94-03.01	55/57/59				0986 475 032	↔ 17,46	
	1.5 i	07.95-03.01	59				1987 477 136	1272	
Espero									
	1.5 i	10.90-12.96	66				0986 475 143	↔ 19,05	
Espero [KLEJ]									
	1.5 i	01.95-10.99	66			ATE	0986 473 905	← 52	
							0986 473 906	→ 52	
	1.8 i	01.95-10.99	66-70			ATE	0986 473 905	← 52	
							0986 473 906	→ 52	
	2.0 i	01.95-10.99	77			ATE	0986 473 905	← 52	
							0986 473 906	→ 52	



		S							
									
	1.5 i	01.95-10.99	66				0 986 475 143	↔ 19,05	
	1.8 i	01.95-10.99	66-70				0 986 475 143	↔ 19,05	
	2.0 i	01.95-10.99	77				0 986 475 143	↔ 19,05	
<b>Evanda</b>									
									
	2.0 i	03.03-01.05	96						F 026 A06 221 <sup>7</sup>
<b>Kalos Hatchback [T200]</b>									
									
	1.2	04.03-01.05	53						F 026 A06 210 <sup>7</sup>
	1.4	09.02-01.05	61/69						F 026 A06 210 <sup>7</sup>
									
	1.2	04.03-01.05	53				0 986 475 939	↔ 19,05	
	1.4	09.02-01.05	61/69				0 986 475 939	↔ 19,05	
									
	1.2	04.03-01.05	53				1 987 482 082	← 1384	
							1 987 482 083	→ 1396	
	1.4	09.02-01.05	61/69				1 987 482 082	← 1384	
							1 987 482 083	→ 1396	
<b>Kalos [T200]</b>									
									
	1.4	09.02-01.05	61/69						F 026 A06 210 <sup>7</sup>
									
	1.4	09.02-01.05	61/69				0 986 475 939	↔ 19,05	
									
	1.4	09.02-01.05	61/69				1 987 482 082	← 1384	
							1 987 482 083	→ 1396	
<b>Korando [KJ]</b>									
									
	2.0 i 16V	07.96-12.00	94				0 265 006 343 <sup>4</sup>		
							0 265 006 712 <sup>3</sup>		
	2.3D	07.96-12.00	57/103-105				0 265 006 343 <sup>4</sup>		
	2.3 i 16V						0 265 006 712 <sup>3</sup>		
	2.9D	07.96-12.00	70-73/95				0 265 006 343 <sup>4</sup>		
	2.9TD Intercooler						0 265 006 712 <sup>3</sup>		
	3.2 i 24V	07.96-12.00	162				0 265 006 343 <sup>4</sup>		
							0 265 006 712 <sup>3</sup>		
<b>Lacetti [J200]</b>									
									
	1.6 i	03.04-01.05	80				1 987 482 353	← 1615	
							1 987 482 354	→ 1567	



		S							
<b>DAEWOO Lacetti [J200]</b>									
		1.8 i	03.04-01.05	90			1987 482 353	← 1615	
							1987 482 354	→ 1567	
		1.6 i	03.04-01.05	80	LAB		0 265 006 752 <sup>3</sup>		
					RAB		0 265 006 751 <sup>3</sup>		
		1.8 i	03.04-01.05	90	LAB		0 265 006 752 <sup>3</sup>		
					RAB		0 265 006 751 <sup>3</sup>		
<b>Lacetti [T200]</b>									
		1.4 i	03.04-01.05	70			1987 482 353	← 1615	
							1987 482 354	→ 1567	
		1.4 i	03.04-01.05	70	LAB		0 265 006 752 <sup>3</sup>		
					RAB		0 265 006 751 <sup>3</sup>		
<b>Lanos Hatchback [T100]</b>									
		1.6 i	04.97-09.03	78					F 026 A06 210 <sup>7</sup>
					Fg.-Nr. →447433		0986 473 905	← 52	
							0986 473 906	→ 52	
		1.4 i	04.97-09.03	55	Fg.-Nr. →447433		0986 475 032	↔ 17,46	
					Fg.-Nr. 447434→		0986 475 143	↔ 19,05	
		1.5 i	11.96-09.03	63	Fg.-Nr. →447433		0986 475 032	↔ 17,46	
					Fg.-Nr. 447434→		0986 475 143	↔ 19,05	
		1.6 i	04.97-09.03	78	Fg.-Nr. →447433		0986 475 143	↔ 19,05	
					Fg.-Nr. 447434→		0986 475 890	↔ 17,46	
		1.4 i	04.97-09.03	55			1987 477 717	→ 1587	
							1987 477 920	← 1655	
		1.5 i	11.96-09.03	63			1987 477 717	→ 1587	
							1987 477 920	← 1655	
		1.6 i	04.97-09.03	78			1987 477 717	→ 1587	
							1987 477 920	← 1655	
<b>Lanos [T100]</b>									
		1.6 i	04.97-09.03	78					F 026 A06 210 <sup>7</sup>
					Fg.-Nr. →447433		0986 473 905	← 52	
							0986 473 906	→ 52	
		1.4 i	04.97-09.03	55	Fg.-Nr. →447433		0986 475 032	↔ 17,46	
					Fg.-Nr. 447434→		0986 475 143	↔ 19,05	
		1.5 i	11.96-09.03	63/74	Fg.-Nr. →447433		0986 475 032	↔ 17,46	
					Fg.-Nr. 447434→		0986 475 143	↔ 19,05	
		1.6 i	04.97-09.03	78	Fg.-Nr. →447433		0986 475 143	↔ 19,05	
					Fg.-Nr. 447434→		0986 475 890	↔ 17,46	
		1.4 i	04.97-09.03	55			1987 477 717	→ 1587	
							1987 477 920	← 1655	
		1.5 i	11.96-09.03	63/74			1987 477 717	→ 1587	
							1987 477 920	← 1655	



		S							
1.6i		04.97-09.03	78				1 987 477 717	→ 1587	
							1 987 477 920	← 1655	
<b>Leganza [V100]</b>									
	1.8i	03.97-12.02	66-70/100				0 265 006 414 <sup>3</sup>		
							0 265 006 415 <sup>4</sup>		
	2.0i	03.97-12.02	93/98-117				0 265 006 414 <sup>3</sup>		
							0 265 006 415 <sup>4</sup>		
	2.2i	09.98-12.01	100				0 265 006 414 <sup>3</sup>		
							0 265 006 415 <sup>4</sup>		
<b>Matiz</b>									
	0.8	01.01→	37,5	Fg.-Nr. 393987→			0 986 473 450	←	
							0 986 473 506	←	
							0 986 474 450	→ 48	
	0.8i	11.98-02.02	38		BSB		0 986 473 450	←	
							0 986 473 506	←	
							0 986 474 450	→ 48	
	1.0	01.01→	47	Fg.-Nr. 393987→			0 986 473 450	←	
							0 986 473 506	←	
							0 986 474 450	→ 48	
	0.8	01.01→	37,5				0 986 475 889	↔ 17,5	
	0.8i	11.98-02.02	38				F 026 002 345	↔ 17,46	
	1.0	01.01→	47				0 986 475 889	↔ 17,5	
	0.8	01.01→	37,5				1 987 477 718	2825	
	1.0	01.01→	47				1 987 477 718	2825	
<b>Matiz II</b>									
	0.8i	07.00→	38				0 986 475 889	↔ 17,5	
<b>Matiz [M100]</b>									
	0.8i	04.98-01.05	38	Fg.-Nr. 393987→			0 986 473 450	←	
							0 986 473 506	←	
							0 986 474 450	→ 48	
	1.0i	01.03-01.05	47	Fg.-Nr. 393987→			0 986 473 450	←	
							0 986 473 506	←	
							0 986 474 450	→ 48	
	0.8i	04.98-01.05	38				0 986 475 889	↔ 17,5	
	1.0i	01.03-01.05	47				0 986 475 889	↔ 17,5	
	0.8i	04.98-01.05	38				1 987 477 718	2825	
	1.0i	01.03-01.05	47				1 987 477 718	2825	





		S				?			
◀ DAEWOO									
<b>Musso [FJ]</b>									
	2.0 i 16V	05.96-12.00	100				0 265 006 135 <sup>4</sup>		
							0 265 006 712 <sup>3</sup>		
	2.3 D	07.93-12.00	57/103				0 265 006 135 <sup>4</sup>		
	2.3 i 16V						0 265 006 712 <sup>3</sup>		
	2.9 D	07.93-12.00	72/88				0 265 006 135 <sup>4</sup>		
	2.9 TD Intercooler						0 265 006 712 <sup>3</sup>		
	3.2 i 24V	01.96-12.00	162				0 265 006 135 <sup>4</sup>		
							0 265 006 712 <sup>3</sup>		
<b>New Matiz</b>									
	0.8 i	03.06→	38				0 986 475 889	↔ 17,5	
<b>New Prince</b>									
	2.0 i	04.96-02.97	85				0 265 006 136 <sup>3</sup>		
							0 265 006 293 <sup>4</sup>		
<b>Nexia</b>									
	1.5 i	01.95→	55	Fg.-Nr. →960817			0 986 471 899	← 48	
							0 986 473 899		
							0 986 473 901		
							0 986 471 900	→ 48	
							0 986 473 900		
							0 986 473 902		
				Fg.-Nr. 960818→			0 986 473 899		←
							0 986 473 901		←
							0 986 473 900		→
							0 986 473 902		→
			62,5		TW		0 986 473 905		← 52
							0 986 473 906		→ 52
				Fg.-Nr. →960817	TW		0 986 471 899	← 48	
							0 986 473 899		
							0 986 473 901		
							0 986 471 900	→ 48	
							0 986 473 900		
							0 986 473 902		
				Fg.-Nr. 960818→	TW		0 986 473 899		←
							0 986 473 901		←
							0 986 473 900		→
							0 986 473 902		→
	1.5 i	01.95→	55				0 986 475 032	↔ 17,46	
			62,5				0 986 475 032	↔ 17,46	
							0 986 475 143	↔ 19,05	
	1.6	01.95→	80				0 986 475 032	↔ 17,46	
							0 986 475 143	↔ 19,05	
	1.5 i	01.95→	55/58,9/62,5				1 987 477 136	1272	
	1.6	01.95→	80				1 987 477 136	1272	



**Nexia Hatchback [KLETN]**

	<b>1.5 i</b>	11.94-10.96	66-67		TW	0 986 473 905	52
						0 986 473 906	52
				Fg.-Nr. →960817	TW	0 986 471 899	48
						0 986 473 899	
						0 986 473 901	
						0 986 471 900	48
						0 986 473 900	
						0 986 473 902	
				Fg.-Nr. 960818→	TW	0 986 473 899	
						0 986 473 901	
						0 986 473 900	
						0 986 473 902	
		12.94-08.97	44/52/ 55-57	Fg.-Nr. →960817		0 986 471 899	48
						0 986 473 899	
						0 986 473 901	
						0 986 471 900	48
						0 986 473 900	
						0 986 473 902	
				Fg.-Nr. 960818→		0 986 473 899	
						0 986 473 901	
						0 986 473 900	
						0 986 473 902	



































	<b>1.5 i</b>	11.94-10.96	66-67			0 986 475 032	17,46
						0 986 475 143	19,05
		12.94-08.97	44/52/55-57			0 986 475 032	17,46

	<b>1.5 i</b>	11.94-08.97	44/52/55-57/ 66-67			1 987 477 136	1272
--	--------------	-------------	-----------------------	--	--	---------------	------

**Nexia [KLETN]**

	<b>1.5 i</b>	11.94-10.96	66-67		TW	0 986 473 905	52
						0 986 473 906	52
				Fg.-Nr. →960817	TW	0 986 471 899	48
						0 986 473 899	
						0 986 473 901	
						0 986 471 900	48
						0 986 473 900	
						0 986 473 902	
				Fg.-Nr. 960818→	TW	0 986 473 899	
						0 986 473 901	
						0 986 473 900	
						0 986 473 902	
		12.94-08.97	44/52/ 55-57	Fg.-Nr. →960817		0 986 471 899	48
						0 986 473 899	
						0 986 473 901	
						0 986 471 900	48
						0 986 473 900	
						0 986 473 902	
				Fg.-Nr. 960818→		0 986 473 899	
						0 986 473 901	
						0 986 473 900	
						0 986 473 902	



								
◀ DAEWOO Nexia [KLETN]								
								
 1.5 i	11.94-10.96	66-67				0986 475 032	↔ 17,46	
	12.94-08.97	44/52/55-57				0986 475 143	↔ 19,05	
						0986 475 032	↔ 17,46	
								
 1.5 i	11.94-08.97	44/52/55-57/ 66-67				1987 477 136	1272	
<b>Nubira Hatchback [J100]</b>								
								
 1.6 i	09.97-09.99	78						F 026 A06 099 <sup>7</sup>
 2.0 i	09.97-09.99	98						F 026 A06 099 <sup>7</sup>
								
 1.6 i	09.97-09.99	78				0986 475 890	↔ 17,46	
 2.0 i	09.97-09.99	98				0986 475 890	↔ 17,46	
								
 1.6 i	09.97-09.99	78			HTB	1987 482 172	← 1654	
			Fg.-Nr. →452729		4SB	1987 482 173	→ 1578	
						1987 482 174	← 1603	
 2.0 i	09.97-09.99	98			Fg.-Nr. →452729	4SB	1987 482 173	→ 1578
						1987 482 174	← 1603	
 1.6 i	09.97-09.99	78			LAB	0265 006 593 <sup>3</sup>		
					RAB	0265 006 594 <sup>3</sup>		
 2.0 i	09.97-09.99	98			LAB	0265 006 593 <sup>3</sup>		
					RAB	0265 006 594 <sup>3</sup>		
<b>Nubira [J100]</b>								
								
 1.6 i	09.97-09.99	78						F 026 A06 099 <sup>7</sup>
 2.0 i	09.97-09.99	98						F 026 A06 099 <sup>7</sup>
								
 1.6 i	09.97-09.99	78				0986 475 890	↔ 17,46	
 2.0 i	09.97-09.99	98				0986 475 890	↔ 17,46	
								
 1.6 i	09.97-09.99	78			HTB	1987 482 172	← 1654	
			Fg.-Nr. →452729		4SB	1987 482 173	→ 1578	
						1987 482 174	← 1603	
 2.0 i	09.97-09.99	98			Fg.-Nr. →452729	4SB	1987 482 173	→ 1578
						1987 482 174	← 1603	
 1.6 i	09.97-09.99	78			LAB	0265 006 593 <sup>3</sup>		
					RAB	0265 006 594 <sup>3</sup>		
 2.0 i	09.97-09.99	98			LAB	0265 006 593 <sup>3</sup>		
					RAB	0265 006 594 <sup>3</sup>		



		S							
<b>Nubira [J150]</b>									
	1.6 i	10.99-06.03	76-78						F 026 A06 099 <sup>7</sup>
	2.0 i	10.99-06.03	79/98						F 026 A06 099 <sup>7</sup>
	1.6 i	10.99-06.03	76-78				0 986 475 890	↔ 17,46	
	2.0 i	10.99-06.03	79/98				0 986 475 890	↔ 17,46	
	1.6 i	10.99-06.03	76-78			HTB	1 987 482 172	← 1654	
				Fg.-Nr. →452729		4SB	1 987 482 173	→ 1578	
							1 987 482 174	← 1603	
	2.0 i	10.99-06.03	79/98			HTB	1 987 482 172	← 1654	
				Fg.-Nr. →452729		4SB	1 987 482 173	→ 1578	
							1 987 482 174	← 1603	
		1.6 i	10.99-06.03	76-78		LAB	0 265 006 593 <sup>3</sup>		
						RAB	0 265 006 594 <sup>4</sup>		
						RAB	0 265 006 594 <sup>4</sup>		
						RAB	0 265 006 594 <sup>4</sup>		
	2.0 i	10.99-06.03	79/98			LAB	0 265 006 593 <sup>3</sup>		
						RAB	0 265 006 594 <sup>4</sup>		
						RAB	0 265 006 594 <sup>4</sup>		
						RAB	0 265 006 594 <sup>4</sup>		
<b>Nubira [J200]</b>									
	1.6 i	07.03-01.05	80				1 987 482 353	← 1615	
							1 987 482 354	→ 1567	
	1.8 i	07.03-01.05	90				1 987 482 353	← 1615	
							1 987 482 354	→ 1567	
		1.6 i	07.03-01.05	80		LAB	0 265 006 752 <sup>3</sup>		
						RAB	0 265 006 751 <sup>3</sup>		
	1.8 i	07.03-01.05	90			LAB	0 265 006 752 <sup>3</sup>		
						RAB	0 265 006 751 <sup>3</sup>		
<b>Nubira Station Wagon [J100]</b>									
	1.6 i	09.97-09.99	78						F 026 A06 099 <sup>7</sup>
	2.0 i	09.97-09.99	98						F 026 A06 099 <sup>7</sup>
	1.6 i	09.97-09.99	78				0 986 475 890	↔ 17,46	
	2.0 i	09.97-09.99	98				0 986 475 890	↔ 17,46	
	1.6 i	09.97-09.99	78			HTB	1 987 482 172	← 1654	
				Fg.-Nr. →452729		4SB	1 987 482 173	→ 1578	
							1 987 482 174	← 1603	
	2.0 i	09.97-09.99	98			Fg.-Nr. →452729	1 987 482 173	→ 1578	
							1 987 482 174	← 1603	
		1.6 i	09.97-09.99	78		LAB	0 265 006 593 <sup>3</sup>		
						RAB	0 265 006 594 <sup>3</sup>		



			S							
	◀ DAEWOO Nubira Station Wagon [J100]									
	2.0i		09.97-09.99	98			LAB	0 265 006 593 <sup>3</sup>		
							RAB	0 265 006 594 <sup>3</sup>		
<b>Nubira Station Wagon [J150]</b>										
	1.6i		10.99-06.03	76-78						F 026 A06 099 <sup>7</sup>
	2.0i		08.99-06.03	98						F 026 A06 099 <sup>7</sup>
	1.6i		10.99-06.03	76-78				0 986 475 890	↔ 17,46	
	2.0i		08.99-06.03	98				0 986 475 890	↔ 17,46	
	1.6i		10.99-06.03	76-78			HTB	1 987 482 172	← 1654	
					Fg.-Nr. →452729		4SB	1 987 482 173	→ 1578	
								1 987 482 174	← 1603	
	2.0i		08.99-06.03	98			HTB	1 987 482 172	← 1654	
					Fg.-Nr. →452729		4SB	1 987 482 173	→ 1578	
								1 987 482 174	← 1603	
		1.6i	10.99-06.03	76-78			LAB	0 265 006 593 <sup>3</sup>		
								0 265 006 595 <sup>4</sup>		
							RAB	0 265 006 594 <sup>3</sup>		
								0 265 006 596 <sup>4</sup>		
	2.0i		08.99-06.03	98			LAB	0 265 006 593 <sup>3</sup>		
								0 265 006 595 <sup>4</sup>		
							RAB	0 265 006 594 <sup>3</sup>		
								0 265 006 596 <sup>4</sup>		
<b>Nubira Station Wagon [J200]</b>										
	1.6i		03.04-01.05	80				1 987 482 353	← 1615	
								1 987 482 354	→ 1567	
	1.8i		03.04-01.05	90				1 987 482 353	← 1615	
								1 987 482 354	→ 1567	
		1.6i	03.04-01.05	80			LAB	0 265 006 752 <sup>3</sup>		
								0 265 006 751 <sup>3</sup>		
	1.8i		03.04-01.05	90			LAB	0 265 006 752 <sup>3</sup>		
								0 265 006 751 <sup>3</sup>		
<b>Prince</b>										
	1.8i		09.92-12.95	78				0 986 475 045	↔ 22,2	
	2.0i		01.91-12.95	85				0 986 475 045	↔ 22,2	
	1.8i		09.92-03.96	78				0 265 006 136 <sup>3</sup>		
								0 265 006 137 <sup>4</sup>		
	2.0i		01.91-03.96	85				0 265 006 136 <sup>3</sup>		
								0 265 006 137 <sup>4</sup>		
<b>Rezzo [U100]</b>										
	1.6i		09.00-01.05	74-77						F 026 A06 221 <sup>7</sup>
	1.8i		09.00-01.05	71-77						F 026 A06 221 <sup>7</sup>

D

		S							
	2.0i	09.00-01.05	88-89						F 026 A06 2217
	1.6i	09.00-01.05	74-77				F 026 A05 988	↔	
	1.8i	09.00-01.05	71-77				F 026 A05 988	↔	
	2.0i	09.00-01.05	88-89				F 026 A05 988	↔	
<b>Sens [TF698]</b>									
	1.3 Si	01.02→	51,5	Fg.-Nr. →447433			0 986 475 032	↔ 17,46	
				Fg.-Nr. 447434→			0 986 475 143	↔ 19,05	
	1.3 Si	01.02→	51,5				1 987 477 717	→ 1587	
							1 987 477 920	← 1655	
<b>Super Salon</b>									
	2.0i	09.91-12.95	81-85				0 986 475 045	↔ 22,2	
	2.0i	09.91-12.95	81-85				0 265 006 136 <sup>3</sup>		
							0 265 006 137 <sup>4</sup>		
<b>Tico [KLY3]</b>									
	0.8	06.91-01.05	30-35				F 026 002 345	→ 17,46	
							F 026 002 346	← 17,46	
<b>Tico [Y3S11]</b>									
	0.8	05.91-03.01	30				F 026 002 345	→ 17,46	
							F 026 002 346	← 17,46	
<b>DAIHATSU</b>									
<b>Applause</b>									
	1.6	06.89-07.97	66-67				0 986 475 699	← 17,48	
							0 986 475 700	→ 17,48	
	1.6i	09.97-04.00	73				0 986 475 699	→ 17,48	
							0 986 475 700	← 17,48	
	1.6i	06.89-07.97	77				0 986 475 699	← 17,48	
	1.6i 4WD						0 986 475 700	→ 17,48	
<b>Charade</b>									
	1.3 VVT	03.11→	73				0 986 475 936	↔ 20,64	



		S									
◀ DAIHATSU Charade											
	1.3 WT	03.11→	73	STB		1987 477 090	→	1600			
						1987 482 221	←	1556			
	4SB	1987 477 070	→	1678							
		1987 482 222	←	1634							
<b>Charade [G2]</b>											
	1.0	05.93-12.95	36,4			F 026 A02 356	→				
						F 026 A02 357	←				
	1.5 i	06.94-09.00	66			0986 475 687	←	17,5			
						0986 475 688	→	17,5			
<b>Charade Hatchback [G2]</b>											
	1.0	05.93-10.95	38			0986 475 687	←	17,5			
						0986 475 688	→	17,5			
	1.3 i	01.93-09.00	44-62			0986 475 687	←	17,5			
						0986 475 688	→	17,5			
<b>Cuore [L2]</b>											
	1.0 i	MFD 04.07→	51			0986 475 881	←	17,46			
						0986 475 882	→	17,46			
<b>Feroza</b>											
	1.6 i 16V 4WD	10.88-10.99	70		INB	0986 473 066		←	53,8		
						0986 474 066		→	53,8		
						INB	0986 473 065		←	53,8	
						0986 474 065		→	53,8		
			05.92-10.99	70			0986 474 066		←	53,8	
							0986 473 066		→	53,8	
							INB	0986 473 066		←	53,8
							0986 474 066		→	53,8	
1.6 4WD	10.88-10.99	63			INB	0986 473 066		←	53,8		
						0986 474 066		→	53,8		
<b>Materia</b>											
	1.3	09.06→	67			0986 475 881	←	17,46			
						0986 475 882	→	17,46			
	1.5	09.06→	76			0986 475 881	←	17,46			
						0986 475 882	→	17,46			
<b>Rocky</b>											
	2.2 4WD	05.93-06.01	67-69			0986 473 066		←	53,8		
						0986 474 066		→	53,8		
	2.8 D Turbo 4WD	05.93-03.02	54/72-75			INB	0986 473 066		←	53,8	
							0986 474 066		→	53,8	
	2.8 D 4WD						0986 473 066		←	53,8	
							0986 474 066		→	53,8	



		S								
<b>Sirion II [M3]</b>										
	1.0	10.04→	51				0 986 475 881	← 17,46		
							0 986 475 882	→ 17,46		
	1.3	10.04→	67-75				0 986 475 881	← 17,46		
							0 986 475 882	→ 17,46		
	1.5	06.07→	76				0 986 475 881	← 17,46		
							0 986 475 882	→ 17,46		
<b>Terios [J1]</b>										
	1.3 i	03.97-12.05	61/63				0 986 475 982	← 20,64		
	1.3 i 4WD						0 986 475 983	→ 20,64		
<b>Terios [J2]</b>										
	1.3 i 4WD	01.06→	63				0 986 475 931	↔ 19,05		
	1.5 i, i 4WD	01.06→	77				0 986 475 931	↔ 19,05		
										<b>DODGE</b>
<b>Avenger [JS]</b>										
	2.0, CRD	09.07-08.11	103/115				F 026 A09 607	↔		
	2.4	09.07-08.11	129				F 026 A09 607	↔		
	2.7 FlexFuel	09.07-08.10	139				F 026 A09 607	↔		
	3.5, 4x4	09.07-08.10	173				F 026 A09 607	↔		
<b>Caliber [PM]</b>										
	1.8	09.06-08.10	110				F 026 A09 607	↔		
	2.0, CRD	09.06-12.10	88/103/115				F 026 A09 607	↔		
	2.2 CRD	09.09-12.10	120				F 026 A09 607	↔		
	2.4, SRT-4, 4x4	09.06-08.11	125/213-217				F 026 A09 607	↔		
<b>Caliber [P3]</b>										
	1.8	09.06-08.07	110				F 026 A09 607	↔		
	2.0	09.06-08.07	115				F 026 A09 607	↔		
<b>Caravan [AS]</b>										
	2.5	09.88-08.95					F 026 002 372	↔ 19,5		
<b>Caravan [NS]</b>										
	2.0	01.95-03.01	98			4SB,TW	0 986 473 194	← 60		
							0 986 474 194	→ 60		
	2.4	09.94-08.00	111				0 986 473 194	← 60		
							0 986 474 194	→ 60		





		S							
	<b>◀ DODGE Caravan [NS]</b>								
	2.5 TD	01.95-08.03	85		4SB,TW		0986 473 194		← 60
							0986 474 194		→ 60
	3.0	01.95-03.01	112				0986 473 194		← 60
							0986 474 194		→ 60
	3.3	09.95-09.00	121				0986 473 194		← 60
							0986 474 194		→ 60
	3.8	09.94-03.01	122/124/				0986 473 194		← 60
	3.8 AWD		130-134				0986 474 194		→ 60
	2.0	01.95-03.01	98				0986 475 878		↔ 19,05
	2.4	09.94-08.00	111				F 026 A02 403		↔
	2.5 TD	01.95-08.03	85				0986 475 878		↔ 19,05
	3.0	01.95-03.01	112				F 026 A02 403		↔
	3.3	09.95-09.00	121				F 026 A02 403		↔
	3.8, AWD	09.94-03.01	122/124/130-134				F 026 A02 403		↔
<b>Caravan [RS]</b>									
	2.4	09.00-08.02	111				F 026 A02 403		↔
		09.02-08.07	111				F 026 002 344		↔ 20,64
	3.3	09.00-08.02	128-134				F 026 A02 403		↔
		09.02-08.07	128-134				F 026 002 344		↔ 20,64
	3.5	01.01-12.01	128-132				F 026 A02 403		↔
	3.8	09.01-08.02	160				F 026 A02 403		↔
		09.02-08.07	160				F 026 002 344		↔ 20,64
<b>Dakota [AN]</b>									
	2.5	09.95-12.99	89		T09		F 026 002 372		↔ 19,5
	3.9	09.96-12.99	131-134		T09		F 026 002 372		↔ 19,5
	5.2	09.91-08.99	164-172		T09		F 026 002 372		↔ 19,5
	5.9	09.97-12.99	183-187		T09		F 026 002 372		↔ 19,5
<b>Durango [DN]</b>									
	5.2	09.98-12.98	172				0986 475 872		← 22,2
							0986 475 873		→ 22,2
<b>Grand Caravan [AS]</b>									
	3.0i	01.88-08.95	107				F 026 002 372		↔ 19,5
<b>Intrepid [LH]</b>									
	2.7	01.98-08.04	138		16Z		0986 473 194		← 60
							0986 474 194		→ 60
	3.2	01.98-08.01	164-168		16Z		0986 473 194		← 60
							0986 474 194		→ 60
	3.5	01.98-08.04	160		16Z		0986 473 194		← 60
	3.5i						0986 474 194		→ 60



		S							
<b>Stratus [JS]</b>									
	2.0 CRD, i 16V	09.06-08.07	103/115				F 026 A09 607	↔	
	2.4	09.06-08.07	125				F 026 A09 607	↔	
	2.7	09.06-08.07	141				F 026 A09 607	↔	
<b>FERRARI</b>									
<b>456</b>									
	GT/GTR 48V	03.96-12.04	325				0 265 006 252 <sup>3</sup>		
							0 265 006 253 <sup>4</sup>		
<b>512</b>									
	TR	11.92-10.94	315				0 265 006 116 <sup>3</sup>		
							0 265 006 117 <sup>4</sup>		
<b>FIAT</b>									
<b>Albea [172]</b>									
	1.2 i.e. 8V	01.02-10.06	44/57-59						F 02D 030 295 <sup>7</sup>
	1.2 i.e. 16V	11.06-12.12	44/57-59				0 204 902 040	←	0 204 104 370 <sup>B</sup>
	1.2 i.e. 16V LPG						0 204 902 041	→	0 204 104 370 <sup>B</sup>
	1.3 JTD 16V	07.03-10.06	52						F 02D 030 295 <sup>7</sup>
		11.06-12.12	52				0 204 902 040	←	0 204 104 370 <sup>B</sup>
							0 204 902 041	→	0 204 104 370 <sup>B</sup>
	1.4 i.e. 8V	07.06-10.06	57						F 02D 030 295 <sup>7</sup>
		11.06-12.12	57				0 204 902 040	←	0 204 104 370 <sup>B</sup>
							0 204 902 041	→	0 204 104 370 <sup>B</sup>
	1.6 i.e. 16V	01.02-10.06	76						F 02D 030 295 <sup>7</sup>
		11.06-12.12	76				0 204 902 040	←	0 204 104 370 <sup>B</sup>
							0 204 902 041	→	0 204 104 370 <sup>B</sup>
	1.2 i.e. 8V, i.e. 16V, i.e. 16V LPG	01.02-12.12	44/57-59				0 986 475 941	↔	20,6
	1.3 JTD 16V	07.03-12.12	52	Ricam.Nr →6499757			0 986 475 941	↔	20,6
				Ricam.Nr 6499758 →			0 986 475 936	↔	20,64
	1.4 i.e. 8V	07.06-12.12	57	Ricam.Nr →6499757			0 986 475 941	↔	20,6
				Ricam.Nr 6499758 →			0 986 475 936	↔	20,64
	1.6 i.e. 16V	01.02-12.12	76				0 986 475 941	↔	20,6
	1.2 i.e. 8V, i.e. 16V, i.e. 16V LPG	01.02-12.12	44/57-59				1 987 477 968	→	1511
							1 987 477 969	←	1501
	1.3 JTD 16V	07.03-12.12	52				1 987 477 968	→	1511
							1 987 477 969	←	1501
	1.4 i.e. 8V	07.06-12.12	57				1 987 477 968	→	1511
							1 987 477 969	←	1501
	1.6 i.e. 16V	01.02-12.12	76				1 987 477 968	→	1511
							1 987 477 969	←	1501



			S							
◀ FIAT Albea [172]										
	1.2 i.e. 16V	01.02-12.12	57-59							0 265 007 126 <sup>4</sup>
	1.2 i.e. 16V LPG								LAB	0 265 007 102 <sup>3</sup>
									RAB	0 265 007 103 <sup>3</sup>
	1.3 JTD 16V	07.03-12.12	52							0 265 007 126 <sup>4</sup>
									LAB	0 265 007 102 <sup>3</sup>
									RAB	0 265 007 103 <sup>3</sup>
	1.4 i.e. 8V	07.06-12.12	57							0 265 007 126 <sup>4</sup>
									LAB	0 265 007 102 <sup>3</sup>
									RAB	0 265 007 103 <sup>3</sup>
	1.6 i.e. 16V	01.02-12.12	76							0 265 007 126 <sup>4</sup>
									LAB	0 265 007 102 <sup>3</sup>
									RAB	0 265 007 103 <sup>3</sup>
<b>Barchetta [183]</b>										
	1.8 i.e. 16V	01.95-03.97	96	Ricam.Nr →26125	MIH	0 204 102 544	← 54	0 204 104 237 <sup>7</sup>		
						0 204 103 532				
						0 204 102 545	→ 54	0 204 104 237 <sup>7</sup>		
						0 204 103 533				
					MIH	0 204 102 532	← 54	0 204 104 234 <sup>7</sup>		
						0 204 103 532				
						0 204 102 533	→ 54	0 204 104 234 <sup>7</sup>		
						0 204 103 533				
		04.97-02.05	96	Ricam.Nr 26126→	MIH	0 204 102 570	← 54	0 204 104 208 <sup>8</sup>		
						0 204 102 571	→ 54	0 204 104 208 <sup>8</sup>		
					MIH	0 204 902 103	← 54	0 204 104 208 <sup>8</sup>		
						0 204 103 502				
						0 204 902 104	→ 54	0 204 104 208 <sup>8</sup>		
						0 204 103 503				
	1.8 i.e. 16V	ABO	01.95-07.95	96	Ricam.Nr →7852	0 986 471 009	→ 34	1 987 470 028 <sup>7</sup>		
						0 986 474 077				
						0 986 471 010	← 34	1 987 470 028 <sup>7</sup>		
						0 986 473 077				
		08.95-06.97	96	Ricam.Nr 7853→	MIH	0 986 473 121	← 33,9	1 987 470 028 <sup>7</sup>		
						0 986 474 121	→ 33,9	1 987 470 028 <sup>7</sup>		
		ABS	01.95-07.95	96	Ricam.Nr →8300	MIH	0 986 471 009	→ 34	1 987 470 028 <sup>7</sup>	
						0 986 474 077				
						0 986 471 010	← 34	1 987 470 028 <sup>7</sup>		
						0 986 473 077				
		08.95-06.97	96	Ricam.Nr 8301→	MIH	0 986 473 121	← 33,9			
						0 986 474 121	→ 33,9			
					MIH	0 986 473 121	← 33,9	1 987 470 028 <sup>7</sup>		
						0 986 474 121	→ 33,9	1 987 470 028 <sup>7</sup>		
	1.8 i.e. 16V	01.95-02.05	96					1 987 482 109	1521	
	1.8 i.e. 16V	01.95-05.99	96	Ricam.Nr →0043319	RAB	0 265 006 211 <sup>4</sup>				
				Ricam.Nr →43319		0 265 006 138 <sup>3</sup>				
					LAB	0 265 006 210 <sup>4</sup>				
		06.99-09.00	96	Ricam.Nr 43320→	LAB	0 265 007 024 <sup>3</sup>				
						0 265 007 026 <sup>4</sup>				
					RAB	0 265 007 025 <sup>3</sup>				
						0 265 007 027 <sup>4</sup>				



		S							
1.8 i.e. 16V		10.00-02.05	96			LAB	0 265 007 024 <sup>3</sup>		
							0 265 007 026 <sup>4</sup>		
						RAB	0 265 007 025 <sup>3</sup>		
							0 265 007 027 <sup>4</sup>		
<b>Brava</b>									
	1.6 MPI 16V	04.00-06.03	78				0 204 102 570	← 54	0 204 104 208 <sup>B</sup>
							0 204 102 571	→ 54	0 204 104 208 <sup>B</sup>
	1.6 MPI 16V	04.00-06.03	78				0 986 AB8 445	↔	
	1.6 MPI 16V	04.00-06.03	78				1 987 477 825	→ 1404	
							1 987 482 180	← 1459	
	1.6 MPI 16V	04.00-06.03	78			HLI	0 265 007 032 <sup>4</sup>		
						HRE	0 265 007 033 <sup>4</sup>		
						VLI	0 265 007 034 <sup>3</sup>		
						VRE	0 265 007 035 <sup>3</sup>		
<b>Brava [182 MY 95]</b>									
	1.4 12V	10.95-10.98	55/59			MIH	0 204 102 569	→ 54	
							0 986 135 317		
							0 986 134 317	← 54	
						MIH	0 204 902 101	←	0 204 104 208 <sup>B</sup>
							0 204 103 499		
							0 986 134 317		
							0 204 902 102	→	0 204 104 208 <sup>B</sup>
							0 204 103 500		
							0 986 135 317		
1.6 16V		10.95-10.98	66			MIH	0 204 102 569	→ 54	
							0 986 135 317		
							0 986 134 317	← 54	
						MIH	0 204 902 101	←	0 204 104 208 <sup>B</sup>
							0 204 103 499		
							0 986 134 317		
							0 204 902 102	→	0 204 104 208 <sup>B</sup>
							0 204 103 500		
							0 986 135 317		
			75/76			AG,MIH	0 204 102 570	← 54	0 204 104 208 <sup>B</sup>
							0 204 102 571	→ 54	0 204 104 208 <sup>B</sup>
						AG,MIH	0 204 902 103	← 54	0 204 104 208 <sup>B</sup>
							0 204 103 502		
							0 204 902 104	→ 54	0 204 104 208 <sup>B</sup>
							0 204 103 503		
						GS,MIH	0 204 102 569	→ 54	
							0 986 135 317		
							0 986 134 317	← 54	
						GS,MIH	0 204 902 101	←	0 204 104 208 <sup>B</sup>
							0 204 103 499		
							0 986 134 317		
							0 204 902 102	→	0 204 104 208 <sup>B</sup>
							0 204 103 500		
							0 986 135 317		



		S									
◀ FIAT Brava [182 MY 95]											
1.8 16V		10.95-10.98	83			MIH	0 204 102 570	← 54	0 204 104 208 <sup>8</sup>		
							0 204 102 571	→ 54	0 204 104 208 <sup>8</sup>		
							MIH	0 204 902 103	← 54	0 204 104 208 <sup>8</sup>	
							0 204 103 502				
							0 204 902 104	→ 54	0 204 104 208 <sup>8</sup>		
							0 204 103 503				
1.9 D		10.95-10.98	48/55			MIH	0 204 102 569	→ 54			
							0 986 135 317				
1.9 TD						MIH	0 986 134 317	← 54			
							0 204 902 101	←	0 204 104 208 <sup>8</sup>		
							0 204 103 499				
							0 986 134 317				
							0 204 902 102	→	0 204 104 208 <sup>8</sup>		
							0 204 103 500				
							0 986 135 317				
1.9 TD		03.96-10.98	73,6			MIH	0 204 102 570	← 54	0 204 104 208 <sup>8</sup>		
							0 204 102 571	→ 54	0 204 104 208 <sup>8</sup>		
							MIH	0 204 902 103	← 54	0 204 104 208 <sup>8</sup>	
							0 204 103 502				
							0 204 902 104	→ 54	0 204 104 208 <sup>8</sup>		
							0 204 103 503				
1.4 12V		09.96-10.98	55/59	Ricom.Nr	4255656→		0 986 475 827	↔ 22,2			
							ABO 10.95-08.96	55/59	Ricom.Nr →4255655	0 986 475 827	↔ 22,2
							ABS 10.95-08.96	55/59	Ricom.Nr →4255655	F 026 002 434	↔ 22
1.6 16V		09.96-10.98	66/75/76	Ricom.Nr	4255656→		0 986 475 827	↔ 22,2			
							ABO 10.95-08.96	66/75/76	Ricom.Nr →4255655	0 986 475 827	↔ 22,2
							ABS 10.95-08.96	66/75/76	Ricom.Nr →4255655	F 026 002 434	↔ 22
1.8 16V		09.96-10.98	83	Ricom.Nr	4255656→		0 986 475 827	↔ 22,2			
							ABO 10.95-08.96	83	Ricom.Nr →4255655	0 986 475 827	↔ 22,2
							ABS 10.95-08.96	83	Ricom.Nr →4255655	F 026 002 434	↔ 22
1.9 D		09.96-10.98	48/55/ 73,6	Ricom.Nr	4255656→		0 986 475 827	↔ 22,2			
							ABO 10.95-08.96	48/55/ 73,6	Ricom.Nr →4255655	0 986 475 827	↔ 22,2
1.9 D		ABS 10.95-08.96	48/55/ 73,6	Ricom.Nr →4255655			F 026 002 434	↔ 22			
1.9 TD											
1.9 TD		09.96-10.98	48/55/ 73,6	Ricom.Nr	4255656→		0 986 475 827	↔ 22,2			
							ABO 03.96-08.96	48/55/ 73,6	Ricom.Nr →4255655	0 986 475 827	↔ 22,2
1.4 12V		10.95-10.98	55/59				1 987 477 385	385			
							1 987 477 827	→ 1370			
							1 987 477 828	← 1424			
1.6 16V		10.95-10.98	66/75				1 987 477 385	385			
							1 987 477 552	← 1428			
							1 987 477 826	→ 1383			
			76				1 987 477 385	385			
1.8 16V		10.95-10.98	83				1 987 477 385	385			
							1 987 477 552	← 1428			
							1 987 477 826	→ 1383			
1.9 D		10.95-10.98	48				1 987 477 385	385			
							1 987 477 827	→ 1370			
							1 987 477 828	← 1424			
		ABS 10.95-10.98	48				1 987 477 552	← 1428			
							1 987 477 826	→ 1383			
1.9 TD		03.96-10.98	55/73,6				1 987 477 385	385			
							1 987 477 552	← 1428			
							1 987 477 826	→ 1383			

		S							
<b>Brava [182 MY 98]</b>									
	1.2 16V	11.98-09.01	60		MIH	0 204 102 569 0 986 135 317 0 986 134 317	→ 54 ↻ ↻ ← 54		
					MIH	0 204 902 101 0 204 103 499 0 986 134 317	← ↻ ↻	0 204 104 208 <sup>B</sup>	
						0 204 902 102 0 204 103 500 0 986 135 317	→ ↻ ↻	0 204 104 208 <sup>B</sup>	
	1.6 16V	11.98-09.01	75		AG,MIH	0 204 102 570 0 204 102 571	← 54 → 54	0 204 104 208 <sup>B</sup> 0 204 104 208 <sup>B</sup>	
					AG,MIH	0 204 902 103 0 204 103 502 0 204 902 104 0 204 103 503	← 54 ↻ → 54 ↻	0 204 104 208 <sup>B</sup> 0 204 104 208 <sup>B</sup>	
					GS,MIH	0 204 102 569 0 986 135 317 0 986 134 317	→ 54 ↻ ↻ ← 54		
					GS,MIH	0 204 902 101 0 204 103 499 0 986 134 317	← ↻ ↻	0 204 104 208 <sup>B</sup>	
						0 204 902 102 0 204 103 500 0 986 135 317	→ ↻ ↻	0 204 104 208 <sup>B</sup>	
			77		MIH	0 204 102 569 0 986 135 317 0 986 134 317	→ 54 ↻ ↻ ← 54		
					MIH	0 204 902 101 0 204 103 499 0 986 134 317	← ↻ ↻	0 204 104 208 <sup>B</sup>	
						0 204 902 102 0 204 103 500 0 986 135 317	→ ↻ ↻	0 204 104 208 <sup>B</sup>	
		01.99-12.01	75		MIH	0 204 102 570 0 204 102 571	← 54 → 54	0 204 104 208 <sup>B</sup> 0 204 104 208 <sup>B</sup>	
					MIH	0 204 902 103 0 204 103 502 0 204 902 104 0 204 103 503	← 54 ↻ → 54 ↻	0 204 104 208 <sup>B</sup> 0 204 104 208 <sup>B</sup>	
	1.8 16V	11.98-09.01	83		MIH	0 204 102 570 0 204 102 571	← 54 → 54	0 204 104 208 <sup>B</sup> 0 204 104 208 <sup>B</sup>	
					MIH	0 204 902 103 0 204 103 502 0 204 902 104 0 204 103 503	← 54 ↻ → 54 ↻	0 204 104 208 <sup>B</sup> 0 204 104 208 <sup>B</sup>	
	1.9 JTD 1.9 TD	11.98-09.01	74/77		MIH	0 204 102 570 0 204 102 571	← 54 → 54	0 204 104 208 <sup>B</sup> 0 204 104 208 <sup>B</sup>	
					MIH	0 204 902 103 0 204 103 502 0 204 902 104 0 204 103 503	← 54 ↻ → 54 ↻	0 204 104 208 <sup>B</sup> 0 204 104 208 <sup>B</sup>	
	1.9 TD	11.98-09.01	55		MIH	0 204 102 569 0 986 135 317 0 986 134 317	→ 54 ↻ ↻ ← 54		



		S							
◀ FIAT Brava [182 MY 98]									
1.9 TD		11.98-09.01	55			MIH	0 204 902 101 0 204 103 499 0 986 134 317	←	0 204 104 208 <sup>8</sup>
							0 204 902 102 0 204 103 500 0 986 135 317	→	0 204 104 208 <sup>8</sup>
1.2 16V		11.98-04.00	60				0 986 475 827	↔ 22,2	
		05.00-09.01	60				0 986 475 904	↔ 22	
1.6 16V		11.98-04.00	75/77				0 986 475 827	↔ 22,2	
		05.00-12.01	75/77				0 986 475 904	↔ 22	
1.8 16V		11.98-04.00	83				0 986 475 827	↔ 22,2	
		05.00-09.01	83				0 986 475 904	↔ 22	
1.9 JTD		11.98-04.00	77				0 986 475 827	↔ 22,2	
		05.00-09.01	77				0 986 475 904	↔ 22	
1.9 JTD, TD		05.00-09.01	74				0 986 475 904	↔ 22	
1.9 TD		11.98-04.00	55				0 986 475 827	↔ 22,2	
			74				0 986 475 827	↔ 22,2	
		05.00-09.01	55				0 986 475 904	↔ 22	
1.2 16V		11.98-09.01	60				1 987 477 552	← 1428	
							1 987 477 826	→ 1383	
		ABO 11.98-09.01	60				1 987 477 827	→ 1370	
							1 987 477 828	← 1424	
1.6 16V		11.98-12.01	75/77				1 987 477 552	← 1428	
							1 987 477 826	→ 1383	
1.8 16V		11.98-09.01	83				1 987 477 552	← 1428	
							1 987 477 826	→ 1383	
1.9 JTD		11.98-09.01	55/74/77				1 987 477 552	← 1428	
1.9 TD							1 987 477 826	→ 1383	
<b>Bravo [182 MY95]</b>									
1.4 12V		10.95-10.98	55/59			MIH	0 204 102 569 0 986 135 317	→ 54	
							0 986 134 317	← 54	
						MIH	0 204 902 101 0 204 103 499 0 986 134 317	←	0 204 104 208 <sup>8</sup>
							0 204 902 102 0 204 103 500 0 986 135 317	→	0 204 104 208 <sup>8</sup>
1.6 16V		10.95-10.98	66/75			AG,MIH	0 204 102 570	← 54	0 204 104 208 <sup>8</sup>
							0 204 102 571	→ 54	0 204 104 208 <sup>8</sup>
						AG,MIH	0 204 902 103 0 204 103 502	← 54	0 204 104 208 <sup>8</sup>
							0 204 902 104 0 204 103 503	→ 54	0 204 104 208 <sup>8</sup>
						GS,MIH	0 204 102 569 0 986 135 317	→ 54	
							0 986 134 317	← 54	
						GS,MIH	0 204 902 101 0 204 103 499 0 986 134 317	←	0 204 104 208 <sup>8</sup>
							0 204 902 102 0 204 103 500 0 986 135 317	→	0 204 104 208 <sup>8</sup>

1.8 16V	10.95-10.98	83	MIH			0 204 102 570	← 54	0 204 104 208 <sup>B</sup>	
						0 204 102 571	→ 54	0 204 104 208 <sup>B</sup>	
						MIH 0 204 902 103	← 54	0 204 104 208 <sup>B</sup>	
						0 204 103 502			
						0 204 902 104	→ 54	0 204 104 208 <sup>B</sup>	
						0 204 103 503			
1.9 D 1.9 TD	10.95-10.98	48/55	MIH			0 204 102 569	→ 54		
						0 986 135 317			
						0 986 134 317		← 54	
			MIH			0 204 902 101	←	0 204 104 208 <sup>B</sup>	
						0 204 103 499			
						0 986 134 317			
						0 204 902 102	→	0 204 104 208 <sup>B</sup>	
						0 204 103 500			
						0 986 135 317			
1.9 TD	03.96-10.98	73,6	MIH			0 204 102 570	← 54	0 204 104 208 <sup>B</sup>	
						0 204 102 571	→ 54	0 204 104 208 <sup>B</sup>	
						MIH 0 204 902 103	← 54	0 204 104 208 <sup>B</sup>	
						0 204 103 502			
						0 204 902 104	→ 54	0 204 104 208 <sup>B</sup>	
						0 204 103 503			
2.0 20V	10.95-10.98	108	MIH			0 204 102 572	← 54		
						0 204 102 573	→ 54		
						MIH 0 204 102 506	← 54	0 204 104 208 <sup>B</sup>	
						0 204 103 506			
						0 986 134 005			
						0 204 102 507	→ 54	0 204 104 208 <sup>B</sup>	
						0 204 103 507			
1.4 12V	09.96-10.98	55/59	Ricam.Nr 4255656→			0 986 475 827	↔ 22,2		
	ABO 10.95-08.96	55/59	Ricam.Nr →4255655			0 986 475 827	↔ 22,2		
	ABS 10.95-08.96	55/59	Ricam.Nr →4255655			F 026 002 434	↔ 22		
1.6 16V	09.96-10.98	66/75	Ricam.Nr 4255656→			0 986 475 827	↔ 22,2		
	ABO 10.95-08.96	66/75	Ricam.Nr →4255655			0 986 475 827	↔ 22,2		
	ABS 10.95-08.96	66/75	Ricam.Nr →4255655			F 026 002 434	↔ 22		
1.8 16V	09.96-10.98	83	Ricam.Nr 4255656→			0 986 475 827	↔ 22,2		
	ABO 10.95-08.96	83	Ricam.Nr →4255655			0 986 475 827	↔ 22,2		
	ABS 10.95-08.96	83	Ricam.Nr →4255655			F 026 002 434	↔ 22		
1.9 D	09.96-10.98	48/55/ 73,6	Ricam.Nr 4255656→			0 986 475 827	↔ 22,2		
	ABO 10.95-08.96	48/55/ 73,6	Ricam.Nr →4255655			0 986 475 827	↔ 22,2		
1.9 D	ABS 10.95-08.96	48/55/ 73,6	Ricam.Nr →4255655			F 026 002 434	↔ 22		
1.9 TD	09.96-10.98	48/55/ 73,6	Ricam.Nr 4255656→			0 986 475 827	↔ 22,2		
	ABO 03.96-08.96	48/55/ 73,6	Ricam.Nr →4255655			0 986 475 827	↔ 22,2		
2.0 20V	10.95-03.97	108	MIH			0 986 473 121		← 33,9	
						0 986 474 121		→ 33,9	
						MIH 0 986 473 121		← 33,9	1 987 470 028 <sup>7</sup>
						0 986 474 121		→ 33,9	1 987 470 028 <sup>7</sup>
1.4 12V	10.95-10.98	55/59				1 987 477 385		385	
						1 987 477 827	→	1370	
						1 987 477 828	←	1424	































◀ FIAT Bravo [182 MY95]							
1.6 16V	10.95-10.98	66/75		1987 477 385	385		
				1987 477 552	← 1428		
				1987 477 826	→ 1383		
1.8 16V	10.95-10.98	83		1987 477 385	385		
				1987 477 552	← 1428		
				1987 477 826	→ 1383		
1.9 D	10.95-10.98	48		1987 477 385	385		
				1987 477 552	← 1428		
				1987 477 826	→ 1383		
				1987 477 827	→ 1370		
				1987 477 828	← 1424		
1.9 TD	03.96-10.98	55/73,6		1987 477 385	385		
				1987 477 552	← 1428		
				1987 477 826	→ 1383		
2.0 20V	10.95-10.98	108		1987 477 385	385		
				Ricam.Nr →4232771, →6039672	1987 482 179	→ 1454	
				Ricam.Nr 4232772→, 6039673→	1987 477 824	→ 1502	

**Bravo [182 MY98]**

	1.2 16V	11.98-09.01	60	MIH	0 204 102 569	→ 54		
					0986 135 317			
					0986 134 317	← 54		
					MIH	0 204 902 101	←	0 204 104 208 <sup>8</sup>
						0 204 103 499		
						0986 134 317		
						0 204 902 102	→	0 204 104 208 <sup>8</sup>
						0 204 103 500		
						0986 135 317		
						1.6 16V	11.98-09.01	75
	0 204 102 571	→ 54	0 204 104 208 <sup>8</sup>					
AG,MIH	0 204 902 103	← 54	0 204 104 208 <sup>8</sup>					
	0 204 103 502							
GS,MIH	0 204 902 104	→ 54	0 204 104 208 <sup>8</sup>					
	0 204 103 503							
GS,MIH	0 204 102 569	→ 54						
	0986 135 317							
	0986 134 317	← 54						
GS,MIH	0 204 902 101	←	0 204 104 208 <sup>8</sup>					
	0 204 103 499							
	0986 134 317							
MIH	0 204 902 102	→	0 204 104 208 <sup>8</sup>					
	0 204 103 500							
	0986 135 317							
MIH	0 204 102 570	← 54	0 204 104 208 <sup>8</sup>					
	0 204 102 571	→ 54	0 204 104 208 <sup>8</sup>					
MIH	0 204 902 103	← 54	0 204 104 208 <sup>8</sup>					
	0 204 103 502							
MIH	0 204 902 104	→ 54	0 204 104 208 <sup>8</sup>					
	0 204 103 503							
08.00-09.01	75			MIH	0 204 102 569	→ 54		
						0986 135 317		
				MIH	0986 134 317	← 54		
						0 204 902 101	←	0 204 104 208 <sup>8</sup>
					0 204 103 499			
					0986 134 317			
					0 204 902 102	→	0 204 104 208 <sup>8</sup>	
					0 204 103 500			
					0986 135 317			

		S								
1.8 16V		11.98-09.01	83			MIH	0 204 102 570	← 54	0 204 104 208 <sup>B</sup>	
							0 204 102 571	→ 54	0 204 104 208 <sup>B</sup>	
							MIH	0 204 902 103	← 54	0 204 104 208 <sup>B</sup>
							0 204 103 502			
							0 204 902 104	→ 54	0 204 104 208 <sup>B</sup>	
0 204 103 503										
1.9 JTD 1.9 TD		11.98-09.01	74/77			MIH	0 204 102 570	← 54	0 204 104 208 <sup>B</sup>	
							0 204 102 571	→ 54	0 204 104 208 <sup>B</sup>	
							MIH	0 204 902 103	← 54	0 204 104 208 <sup>B</sup>
							0 204 103 502			
							0 204 902 104	→ 54	0 204 104 208 <sup>B</sup>	
0 204 103 503										
1.9 TD		11.98-09.01	55			MIH	0 204 102 569	→ 54		
							0 986 135 317			
							0 986 134 317	← 54		
							MIH	0 204 902 101	←	0 204 104 208 <sup>B</sup>
							0 204 103 499			
							0 986 134 317			
							0 204 902 102	→	0 204 104 208 <sup>B</sup>	
							0 204 103 500			
0 986 135 317										
2.0 20V		11.98-09.01	113			MIH	0 204 102 572	← 54		
							0 204 102 573	→ 54		
							MIH	0 204 102 506	← 54	0 204 104 208 <sup>B</sup>
							0 204 103 506			
							0 986 134 005			
0 204 102 507	→ 54	0 204 104 208 <sup>B</sup>								
0 204 103 507										
										
	1.2 16V	ABO	11.98-09.01	60			0 986 475 827	↔ 22,2		
		ABS	05.00-09.01	60			0 986 475 904	↔ 22		
1.6 16V			11.98-04.00	75			0 986 475 827	↔ 22,2		
			05.00-09.01	75			0 986 475 904	↔ 22		
1.8 16V			11.98-04.00	83			0 986 475 827	↔ 22,2		
			05.00-09.01	83			0 986 475 904	↔ 22		
1.9 JTD			11.98-04.00	77			0 986 475 827	↔ 22,2		
			05.00-09.01	77			0 986 475 904	↔ 22		
1.9 JTD, TD			05.00-09.01	74			0 986 475 904	↔ 22		
1.9 TD			11.98-04.00	55			0 986 475 827	↔ 22,2		
				74			0 986 475 827	↔ 22,2		
			05.00-09.01	55			0 986 475 904	↔ 22		
										
	1.2 16V		11.98-09.01	60			1 987 477 385	385		
							1 987 477 552	← 1428		
1.6 16V			11.98-09.01	75			1 987 477 826	→ 1383		
							1 987 477 828	← 1424		
							1 987 477 385	385		
1.8 16V			11.98-09.01	83			1 987 477 552	← 1428		
							1 987 477 826	→ 1383		
							1 987 477 385	385		
1.9 JTD 1.9 TD			11.98-09.01	55/74/77			1 987 477 385	385		
							1 987 477 552	← 1428		
2.0 20V			11.98-09.01	113			1 987 477 826	→ 1383		
							1 987 477 385	385		
							1 987 482 179	→ 1454		



		S							
◀ FIAT									
<b>Bravo [198]</b>									
	1.6 Multijet	10.13→	77		BSR	0 204 001 967	← 54	0 204 104 282 <sup>8</sup>	
						0 986 473 997			
						0 204 001 968	→ 54	0 204 104 282 <sup>8</sup>	
						0 986 474 997			
					BSR	F 026 700 012	←	0 204 104 370 <sup>8</sup>	
						F 026 700 013	→	0 204 104 370 <sup>8</sup>	
	1.6 Multijet	10.13→	77			1 987 477 910	← 1786		
						1 987 477 911	→ 1668		
	1.6 Multijet	10.13→	77			0 265 008 002 <sup>3</sup>			
						0 265 008 003 <sup>4</sup>			
<b>Bravo [198 MY07]</b>									
	1.4 Turbo 16V	07.07-12.09	110		VSP	0 204 001 969	← 57	0 204 104 282 <sup>8</sup>	
						0 204 001 970	→ 57	0 204 104 282 <sup>8</sup>	
		10.07-12.09	88			0 204 001 967	← 54	0 204 104 282 <sup>8</sup>	
						0 986 473 997			
						0 204 001 968	→ 54	0 204 104 282 <sup>8</sup>	
						0 986 474 997			
	1.4 16V	03.07-12.09	66			0 204 001 965	← 54	0 204 104 279 <sup>7</sup>	
	1.4 16V LPG					0 204 001 966	→ 54	0 204 104 279 <sup>7</sup>	
	1.6 Multijet	10.07-12.09	66/77/85/ 88			0 204 001 967	← 54	0 204 104 282 <sup>8</sup>	
						0 986 473 997			
						0 204 001 968	→ 54	0 204 104 282 <sup>8</sup>	
						0 986 474 997			
	1.9 Multijet	03.07-12.09	66/85/88			0 204 001 967	← 54	0 204 104 282 <sup>8</sup>	
						0 986 473 997			
						0 204 001 968	→ 54	0 204 104 282 <sup>8</sup>	
						0 986 474 997			
		04.07-12.09	110		VSP	0 204 001 969	← 57	0 204 104 282 <sup>8</sup>	
						0 204 001 970	→ 57	0 204 104 282 <sup>8</sup>	
	2.0 Multijet	10.08-12.09	120/121		VSP	0 204 001 969	← 57	0 204 104 282 <sup>8</sup>	
						0 204 001 970	→ 57	0 204 104 282 <sup>8</sup>	
					VSP			0 204 104 282 <sup>8</sup>	
	1.4 Turbo 16V	07.07-12.09	110		VSP	0 204 004 437	← 38		
						0 986 134 006			
						0 204 004 438	→ 38		
						0 986 135 006			
	1.4 Turbo 16V	03.07-12.09	66/88			0 204 004 437	← 38		
	1.4 16V					0 986 134 006			
	1.4 16V LPG					0 204 004 438	→ 38		
						0 986 135 006			
	1.6 Multijet	10.07-12.09	66/77/85/ 88			0 204 004 437	← 38		
						0 986 134 006			
						0 204 004 438	→ 38		
						0 986 135 006			
	1.9 Multijet	03.07-12.09	66/85/88			0 204 004 437	← 38		
						0 986 134 006			
						0 204 004 438	→ 38		
						0 986 135 006			







		S												
1.9 Multijet		04.07-12.09	110			VSP	0 204 004 437	← 38						
							0 986 134 006							
							0 204 004 438	→ 38						
							0 986 135 006							
2.0 Multijet		10.08-12.09	120/121			VSP	0 204 004 437	← 38						
							0 986 134 006							
							0 204 004 438	→ 38						
							0 986 135 006							
	1.4 Turbo 16V, 16V, 16V LPG	03.07-12.09	66/88/110				1 987 477 910	← 1786						
							1 987 477 911	→ 1668						
	1.6 Multijet	10.07-12.09	66/77/85/88				1 987 477 910	← 1786						
							1 987 477 911	→ 1668						
	1.9 Multijet	03.07-12.09	66/85/88/110				1 987 477 910	← 1786						
							1 987 477 911	→ 1668						
	2.0 Multijet	10.08-12.09	120/121				1 987 477 910	← 1786						
							1 987 477 911	→ 1668						
	1.4 Turbo 16V, 16V, 16V LPG	03.07-12.09	66/88/110				0 265 008 003 <sup>3</sup>							
							0 265 008 003 <sup>4</sup>							
	1.6 Multijet	10.07-12.09	66/77/85/88				0 265 008 003 <sup>3</sup>							
							0 265 008 003 <sup>4</sup>							
	1.9 Multijet	03.07-12.09	66/85/88/110				0 265 008 003 <sup>3</sup>							
							0 265 008 003 <sup>4</sup>							
	2.0 Multijet	10.08-12.09	120/121				0 265 008 003 <sup>3</sup>							
							0 265 008 003 <sup>4</sup>							
<b>Bravo [198 MY10]</b>														
	1.4	03.10→	66				0 204 001 965	← 54	0 204 104 279 <sup>7</sup>					
	1.4 LPG						0 204 001 966	→ 54	0 204 104 279 <sup>7</sup>					
	1.4 Turbo		03.10-05.10	103		BSR	0 204 001 970	→ 57	0 204 104 282 <sup>B</sup>					
				110		BSR	0 204 001 970	→ 57	0 204 104 282 <sup>B</sup>					
	03.10→	88				BSR	0 204 001 967	← 54	0 204 104 282 <sup>B</sup>					
							0 986 473 997							
							0 204 001 968	→ 54	0 204 104 282 <sup>B</sup>					
							0 986 474 997							
							BSR	F 026 700 012	←	0 204 104 370 <sup>B</sup>				
								F 026 700 013	→	0 204 104 370 <sup>B</sup>				
	103					BSR	0 204 001 969	← 57	0 204 104 282 <sup>B</sup>					
							BSR	F 026 700 012	←	0 204 104 370 <sup>B</sup>				
	110					BSR	0 204 001 969	← 57	0 204 104 282 <sup>B</sup>					
							BSR	F 026 700 012	←	0 204 104 370 <sup>B</sup>				
						BSR	F 026 700 013	→	0 204 104 370 <sup>B</sup>					
								F 026 700 013	→	0 204 104 370 <sup>B</sup>				
1.6 Multijet	01.10→	66/77			BSR	0 204 001 967	← 54	0 204 104 282 <sup>B</sup>						
						0 986 473 997								
						0 204 001 968	→ 54	0 204 104 282 <sup>B</sup>						
						0 986 474 997								
						BSR	F 026 700 012	←	0 204 104 370 <sup>B</sup>					
							F 026 700 013	→	0 204 104 370 <sup>B</sup>					
						03.10→	88				BHO,BSR	0 204 001 969	← 57	0 204 104 282 <sup>B</sup>
												BHO,BSR	0 204 001 967	← 54
												0 986 473 997		
												0 204 001 968	→ 54	0 204 104 282 <sup>B</sup>
					BSR	0 986 474 997								
						F 026 700 012	←	0 204 104 370 <sup>B</sup>						
						F 026 700 013	→	0 204 104 370 <sup>B</sup>						

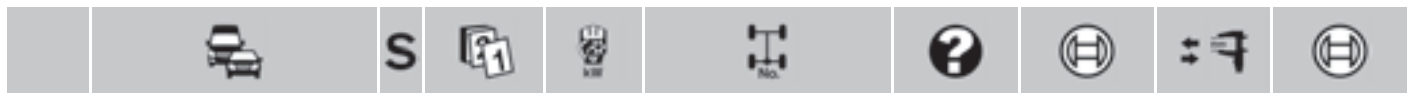

<b>FIAT Bravo [198 MY10]</b>								
	2.0 Multijet	03.10-05.10	120		BSR	0 204 001 970	→ 57	0 204 104 282 <sup>8</sup>
		03.10→	120		BSR	0 204 001 969	← 57	0 204 104 282 <sup>8</sup>
					BSR	F 026 700 012	←	0 204 104 370 <sup>8</sup>
						F 026 700 013	→	0 204 104 370 <sup>8</sup>
<hr/>								
	1.4, LPG, Turbo	03.10→	66/88/103/110			1 987 477 910	← 1786	
						1 987 477 911	→ 1668	
	1.6 Multijet	01.10→	66/77/88			1 987 477 910	← 1786	
						1 987 477 911	→ 1668	
	2.0 Multijet	03.10→	120			1 987 477 910	← 1786	
						1 987 477 911	→ 1668	
<hr/>								
	1.4, LPG, Turbo	03.10→	66/88/103/110			0 265 008 002 <sup>3</sup>		
						0 265 008 003 <sup>4</sup>		
	1.6 Multijet	01.10→	66/77/88			0 265 008 002 <sup>3</sup>		
						0 265 008 003 <sup>4</sup>		
	2.0 Multijet	03.10→	120			0 265 008 002 <sup>3</sup>		
						0 265 008 003 <sup>4</sup>		
<hr/>								
<b>Cinquecento [170]</b>								
<hr/>								
	1.1 i.e	10.94-07.98	40	Fg.-Nr. →1066590	MIH	0 204 103 494	←	
						0 986 134 007	←	
						0 204 103 495	→ 48	
						0 204 102 824	← 48	
						0 204 103 494		
		0 986 134 007						
		0 204 102 825	→ 48					
		0 204 103 495						
		0 986 135 007						
		MIH	0 204 902 006	← 48	0 204 104 203 <sup>7</sup>			
		0 204 103 822						
		0 204 902 007	→	0 204 104 203 <sup>7</sup>				
		0 204 103 823						
		0 986 135 007						
	700	10.92-07.98	22	Fg.-Nr. →1066590	MIH	0 204 103 494	←	
						0 986 134 007	←	
						0 204 103 495	→ 48	
						0 204 102 824	← 48	
						0 204 103 494		
		0 986 134 007						
0 204 102 825		→ 48						
0 204 103 495								
0 986 135 007								
MIH		0 204 902 006	← 48	0 204 104 203 <sup>7</sup>				
	0 204 103 822							
	0 204 902 007	→	0 204 104 203 <sup>7</sup>					
	0 204 103 823							
	0 986 135 007							
900 900 i.e	07.91-07.98	29/30/31	Fg.-Nr. →1066590	MIH	0 204 103 494	←		
					0 986 134 007	←		
					0 204 103 495	→ 48		
					0 204 102 824	← 48		
					0 204 103 494			
	0 986 134 007							
	0 204 102 825	→ 48						
	0 204 103 495							
	0 986 135 007							
	MIH	0 204 902 006	← 48	0 204 104 203 <sup>7</sup>				
	0 204 103 822							
	0 204 902 007	→	0 204 104 203 <sup>7</sup>					
	0 204 103 823							
	0 986 135 007							



										
<hr/>										
	<b>900</b>		07.91-07.98	29/30/31	Fg.-Nr. 1066591→	MHH		0 204 <b>902 006</b>	← 48	0 204 <b>104 203</b> <sup>7</sup>
	<b>900 i.e</b>							0 204 <b>103 822</b>	↻	
								0 204 <b>902 007</b>	→	0 204 <b>104 203</b> <sup>7</sup>
								0 204 <b>103 823</b>	↻	
								0 986 <b>135 007</b>	↻	
<hr/>										
										
	<b>1.1 i.e</b>		10.94-07.98	40				F 026 <b>002 454</b>	↔ 19,05	
	<b>700</b>		10.92-07.98	22				F 026 <b>002 454</b>	↔ 19,05	
	<b>900 i.e</b>		07.91-07.98	29/30/31				F 026 <b>002 454</b>	↔ 19,05	
<hr/>										
										
	<b>1.1 i.e</b>		10.94-10.97	40				1 987 <b>477 381</b>	2988	
			11.97-07.98	40				1 987 <b>477 553</b>	2670	
	<b>700</b>		10.92-10.97	22				1 987 <b>477 381</b>	2988	
			11.97-07.98	22				1 987 <b>477 553</b>	2670	
	<b>900</b>		07.91-10.97	29/30/31				1 987 <b>477 381</b>	2988	
	<b>900 i.e</b>		11.97-07.98	29/30/31				1 987 <b>477 553</b>	2670	
<hr/>										
<b>Coupé [175 MY93]</b>										
<hr/>										
										
	<b>1.8 i16V</b>		03.96-09.96	96				0 204 <b>102 506</b>	← 54	0 204 <b>104 208</b> <sup>B</sup>
								0 204 <b>102 507</b>	→ 54	0 204 <b>104 208</b> <sup>B</sup>
								0 204 <b>103 507</b>	↻	
	<b>2.0 i16V</b>		04.94-09.96	104				0 204 <b>102 506</b>	← 54	0 204 <b>104 208</b> <sup>B</sup>
								0 204 <b>103 506</b>	↻	
								0 986 <b>134 005</b>	↻	
								0 204 <b>102 507</b>	→ 54	0 204 <b>104 208</b> <sup>B</sup>
								0 204 <b>103 507</b>	↻	
						RLE		0 204 <b>102 506</b>	← 54	0 204 <b>104 208</b> <sup>B</sup>
								0 204 <b>103 506</b>	↻	
								0 986 <b>134 005</b>	↻	
								0 204 <b>102 507</b>	→ 54	0 204 <b>104 208</b> <sup>B</sup>
								0 204 <b>103 507</b>	↻	
					Ricam.Nr 0023589→	LLE		0 204 <b>102 506</b>	← 54	0 204 <b>104 208</b> <sup>B</sup>
								0 204 <b>103 506</b>	↻	
								0 986 <b>134 005</b>	↻	
								0 204 <b>102 507</b>	→ 54	0 204 <b>104 208</b> <sup>B</sup>
								0 204 <b>103 507</b>	↻	
	<b>2.0 i16V Turbo</b>		02.94-09.96	143	Ricam.Nr 0023589→	LLE		0 204 <b>102 506</b>	← 54	0 204 <b>104 208</b> <sup>B</sup>
								0 204 <b>103 506</b>	↻	
								0 986 <b>134 005</b>	↻	
								0 204 <b>102 507</b>	→ 54	0 204 <b>104 208</b> <sup>B</sup>
								0 204 <b>103 507</b>	↻	
			04.94-09.96	143		RLE		0 204 <b>102 506</b>	← 54	0 204 <b>104 208</b> <sup>B</sup>
								0 204 <b>103 506</b>	↻	
								0 986 <b>134 005</b>	↻	
								0 204 <b>102 507</b>	→ 54	0 204 <b>104 208</b> <sup>B</sup>
								0 204 <b>103 507</b>	↻	
<hr/>										
										
	<b>1.8 i16V</b>		03.96-09.96	96				0 986 <b>473 121</b>	↻ ← 33,9	1 987 <b>470 028</b> <sup>7</sup>
								0 986 <b>474 121</b>	↻ → 33,9	1 987 <b>470 028</b> <sup>7</sup>
	<b>2.0 i16V</b>		02.94-07.95	104/143				0 986 <b>473 077</b>	↻ ← 33,9	1 987 <b>470 028</b> <sup>7</sup>
	<b>2.0 i16V Turbo</b>							0 986 <b>474 077</b>	↻ → 33,9	1 987 <b>470 028</b> <sup>7</sup>
			08.95-09.96	104/143				0 986 <b>473 121</b>	↻ ← 33,9	1 987 <b>470 028</b> <sup>7</sup>
								0 986 <b>474 121</b>	↻ → 33,9	1 987 <b>470 028</b> <sup>7</sup>



<b>FIAT Coupé [175 MY93]</b>																
	1.8 i 16V	03.96-09.96	96					1987 477 382	↔	1517						
	2.0 i 16V	04.94-09.96	104/143					1987 477 382	↔	1517						
	2.0 i 16V Turbo	04.94-09.96	104/143					1987 477 382	↔	1517						
	1.8 i 16V	03.96-09.96	96					0 265 006 197 <sup>4</sup>								
								0 265 006 212 <sup>3</sup>								
	2.0 i 16V	04.94-09.96	104					0 265 006 197 <sup>4</sup>								
								0 265 006 212 <sup>3</sup>								
	2.0 i 16V Turbo	02.94-09.96	143					0 265 006 162 <sup>3</sup>								
								0 265 006 197 <sup>4</sup>								
<b>Coupé [175 MY96]</b>																
	1.8 16V	10.96-09.00	96				MIH	0 204 102 572	←	54						
								0 204 102 573	→	54						
								0 204 102 506	←	54	0 204 104 208 <sup>8</sup>					
								0 204 103 506								
								0 986 134 005								
								0 204 102 507	→	54	0 204 104 208 <sup>8</sup>					
							0 204 103 507									
	2.0 20V	10.96-09.00	108/113				MIH	0 204 102 572	←	54						
													0 204 102 573	→	54	
													0 204 102 506	←	54	0 204 104 208 <sup>8</sup>
							0 204 103 506									
							0 986 134 005									
							0 204 102 507	→	54	0 204 104 208 <sup>8</sup>						
							0 204 103 507									
	1.8 16V	10.96-09.00	96					0 986 473 121		←	33,9	1 987 470 028 <sup>7</sup>				
								0 986 474 121		→	33,9	1 987 470 028 <sup>7</sup>				
	2.0 20V	10.96-03.98	108					0 986 473 121		←	33,9	1 987 470 028 <sup>7</sup>				
								0 986 474 121		→	33,9	1 987 470 028 <sup>7</sup>				
	2.0 20V Turbo	10.96-09.00	162				Ricam.Nr →0047168	NOR	0 986 473 121		←	33,9	1 987 470 028 <sup>7</sup>			
								0 986 474 121		→	33,9	1 987 470 028 <sup>7</sup>				
<b>Croma [154 MY90]</b>																
	1.9 TD i.d.	11.92-03.95	69				MIH	0 204 102 540	←	54	0 204 104 237 <sup>7</sup>					
								0 204 102 541	→	54	0 204 104 237 <sup>7</sup>					
	2.0 i.e.	05.91-12.96	86					MIH	0 204 102 469	←	54	0 204 104 237 <sup>7</sup>				
									0 204 103 469							
									0 204 102 470	→	54	0 204 104 237 <sup>7</sup>				
								0 204 103 470								



	S																								
	2.0 i.e.	05.91-12.96	86	MIH		0 204 102 471	← 54	0 204 100 392 <sup>B</sup>																	
						0 204 103 471		0 204 104 237 <sup>7</sup>																	
						0 204 102 472	→ 54	0 204 100 392 <sup>B</sup>																	
						0 204 103 472																			
		11.92-12.96	85	MIH		0 204 102 469	← 54	0 204 104 237 <sup>7</sup>																	
						0 204 103 469																			
						0 204 102 470	→ 54	0 204 104 237 <sup>7</sup>																	
						0 204 103 470																			
						0 204 102 560	→ 54																		
			0 204 102 561	← 54																					
			86	MIH			0 204 102 471	← 54	0 204 100 392 <sup>B</sup>																
							0 204 103 471		0 204 104 237 <sup>7</sup>																
							0 204 102 472	→ 54	0 204 100 392 <sup>B</sup>																
							0 204 103 472																		
0 204 102 540	→ 54																								
12.92-12.96	86	GRF,MIH		0 204 102 469	← 54	0 204 104 237 <sup>7</sup>																			
				0 204 103 469																					
				0 204 102 470	→ 54	0 204 104 237 <sup>7</sup>																			
				0 204 103 470																					
				0 204 102 471	← 54	0 204 100 392 <sup>B</sup>																			
	2.0 i.e. 16V	11.92-12.96	101	MIH		0 204 102 560	→ 54																		
						0 204 102 561	← 54																		
						MIH	0 204 102 540	→ 54																	
							0 204 102 541	← 54																	
							2.5 TD 2.5 TDI	11.92-03.95	85	MIH		0 204 102 540	← 54	0 204 104 237 <sup>7</sup>											
												0 204 102 541	→ 54	0 204 104 237 <sup>7</sup>											
													1.9 TD i.d.	ABS	11.92-12.96	69		0 986 473 027	← 38						
												0 986 474 027						→ 38							
												2.0 i.e.						ABO	05.91-12.96	85/86/101/ 110/117	MIH		0 204 102 452	← 36	
																							0 204 103 452		
																							0 204 102 453	→ 36	
																							0 204 103 453		
																							MIH	0 204 102 440	← 36
																		0 204 103 440							
																		0 204 102 441	→ 36						
	0 204 103 441																								
2.5 i.e., TD, TDI	ABS	05.91-12.96	85/86/101/ 110/117									0 986 473 027						← 38							
												0 986 474 027						→ 38							
												0 986 473 027						← 38							
						0 986 474 027	→ 38																		
	2.0 i.e.	11.92-12.96	85 86			1 987 477 390	2950																		
						1 987 477 390	2950																		
						2.0 i.e. Turbo, i.e. 16V	11.92-12.96	101/110/117	1 987 477 390	2950															
						2.5 i.e.	06.93-12.96	119	1 987 477 390	2950															
							1.9 TD i.d.	11.92-01.94	69	Ricam.Nr →0001448		0 265 003 075 <sup>4</sup>													
11.92-12.96	69	0 265 006 262 <sup>3</sup>																							
02.94-12.96	69	Ricam.Nr 0001449→	0 265 006 238 <sup>4</sup>																						





		S							
<b>FIAT Croma [154 MY90]</b>									
		2.0 i.e.	05.91-01.94	85/86/101/	Ricam.Nr →0001448		0 265 003 075 <sup>4</sup>		
		2.0 i.e. Turbo		110/117					
		2.0 i.e. 16V	05.91-12.96	85/86/101/			0 265 006 262 <sup>3</sup>		
				110/117					
			02.94-12.96	85/86/101/	Ricam.Nr 0001449→		0 265 006 238 <sup>4</sup>		
				110/117					
		2.5 i.e.	11.92-01.94	85/119	Ricam.Nr →0001448		0 265 003 075 <sup>4</sup>		
		2.5 TD	11.92-12.96	85/119			0 265 006 262 <sup>3</sup>		
		2.5 TDI	02.94-12.96	85/119	Ricam.Nr 0001449→		0 265 006 238 <sup>4</sup>		
<b>Croma [194 MY05]</b>									
		1.8 i.e.	04.06-12.10	103			0 986 134 018		← 57
							0 986 135 018		→ 57
		1.9 JTD 8V	04.06-12.10	85/88			0 986 134 018		← 57
							0 986 135 018		→ 57
		1.9 JTD 16V	06.05-12.10	100/110	Fg.-Nr. 2060169→		0 986 134 018		← 57
							0 986 135 018		→ 57
		2.2 i.e.	04.06-12.10	108			0 986 134 018		← 57
							0 986 135 018		→ 57
		1.8 i.e.	06.05-12.10	103			0 986 134 235		← 41
							0 986 135 235		→ 41
		1.9 JTD 8V	06.05-12.10	85/88			0 986 134 235		← 41
							0 986 135 235		→ 41
		1.9 JTD 16V	06.05-06.08	100/110			0 986 134 231		←
							0 986 135 231		→
			07.08-12.10	100/110			0 986 134 235		← 41
							0 986 135 235		→ 41
		2.2 i.e.	06.05-12.10	108			0 986 134 235		← 41
							0 986 135 235		→ 41
		2.4 JTD	06.05-06.08	147			0 986 134 231		←
							0 986 135 231		→
		1.8 i.e.	06.05-12.10	103			1 987 482 147		1627
		1.9 JTD 8V, JTD 16V	06.05-12.10	85/88/100/110			1 987 482 147		1627
		2.2 i.e.	06.05-12.10	108			1 987 482 147		1627
		2.4 JTD	06.05-12.10	147			1 987 482 147		1627
<b>Doblo</b>									
		1.9 D	11.03-01.06	46		MIH	0 986 473 125		← 54
							0 986 474 125		→ 54
		1.9 D	11.03-01.06	46			0 986 475 901		↔ 20,64
<b>Doblo Cargo [223..]</b>									
		1.2 i.e. 8V	07.00-09.05	48		MIH	0 986 473 125		← 54
							0 986 474 125		→ 54
		1.3 JTD 16V	02.04-09.05	51		MIH	0 986 473 125		← 54
							0 986 474 125		→ 54



		S																					
<b>1.3</b> Multijet	10.05-12.10	55/62	KOB,NNC	0 204 004 566 0 986 134 077	← 54 ↻	↻	→ 54	↻	↻														
										Ricam.Nr →5749151	KOB,VAN, VFC	0 204 004 564 0 986 473 487	← 54 ↻	↻	→ 54	↻							
																	Ricam.Nr 5749152→	KOB,VAN, VFC	0 204 902 119 0 986 473 487	← 54 ↻	↻	→ 54	↻
				0 204 004 567 0 986 135 077	→ 54 ↻	↻	↻																
								0 204 004 566 0 986 134 077	← 54 ↻	↻	↻												
												0 204 902 119 0 986 473 487	← 54 ↻	↻	→ 54	↻							
																	0 204 902 120 0 986 474 487	← 54 ↻	↻	→ 54	↻		
				0 986 473 125 0 986 474 125	↻ ← 54 ↻ → 54	↻	↻																
								0 986 473 125 0 986 474 125	↻ ← 54 ↻ → 54	↻	↻												
												0 986 473 125 0 986 474 125	↻ ← 54 ↻ → 54	↻	↻								
																0 204 004 564 0 986 473 487	← 54 ↻	↻	→ 54	↻			
0 204 004 565 0 986 474 487	→ 54 ↻	↻	↻																				
				0 204 004 566 0 986 134 077	← 54 ↻	↻	→ 54	↻															
									0 204 004 567 0 986 135 077	→ 54 ↻	↻	↻											
													0 204 004 564 0 986 473 487	← 54 ↻	↻	→ 54	↻						
0 204 004 565 0 986 474 487	→ 54 ↻	↻	↻																				
				0 204 902 119 0 986 473 487	← 54 ↻	↻	→ 54	↻															
									0 204 902 120 0 986 474 487	→ 54 ↻	↻	↻											
													0 204 004 566 0 986 134 077	← 54 ↻	↻	→ 54	↻						
0 204 004 567 0 986 135 077	→ 54 ↻	↻	↻																				
				0 204 004 564 0 986 473 487	← 54 ↻	↻	→ 54	↻															
									0 204 004 565 0 986 474 487	→ 54 ↻	↻	↻											
													0 204 902 119 0 986 473 487	← 54 ↻	↻	→ 54	↻						
0 204 902 120 0 986 474 487	→ 54 ↻	↻	↻																				
				0 986 475 901	↻ ↔ 20,64	↻	↻																
								LOC 0 986 475 816	↻ ↔ 20,64	↻	↻												
												ATE 0 986 475 901	↻ ↔ 20,64	↻	↻								
LOC 0 986 475 816	↻ ↔ 20,64	↻	↻																				



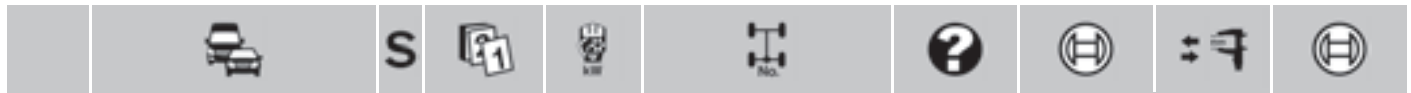

**FIAT Doblo Cargo [223..]**

1.3 Multijet	10.05-12.10	55/62		0986 475 936	↔ 20,64
1.4 i.e.	10.05→	55-57		0986 475 936	↔ 20,64
1.6 i.e. 16V	10.01-09.05	76		0986 475 901	↔ 20,64
	02.04-09.05	76	LOC	0986 475 816	↔ 20,64
1.6 i.e. 16V Bipower	01.03-09.05	68-76	ATE	0986 475 901	↔ 20,64
	02.04-09.05	68-76	LOC	0986 475 816	↔ 20,64
1.9 D	07.00-09.05	46		0986 475 901	↔ 20,64
	02.04-09.05	46	LOC	0986 475 816	↔ 20,64
1.9 JTD	10.01-01.04	74		0986 475 901	↔ 20,64
	11.02-09.05	77	ATE	0986 475 901	↔ 20,64
	02.04-09.05	77	LOC	0986 475 816	↔ 20,64
1.9 Multijet	10.05-12.10	74		0986 475 936	↔ 20,64
		77		0986 475 936	↔ 20,64
		88		0986 475 936	↔ 20,64

**F**

1.2 i.e. 8V	07.00-09.05	48	KOB	1987 477 723	→ 1810
			KOB	1987 477 723	→ 1810
1.3 JTD 16V	02.04-09.05	51	FLR,VAN	1987 482 287	→ 2140
				1987 482 288	← 2140
1.3 Multijet	10.05-12.10	55/62	KOB	1987 477 723	→ 1810
				1987 482 287	→ 2140
1.4 i.e.	10.05→	55-57	TW	1987 482 287	→ 2140
				1987 482 288	← 2140
1.6 i.e. 16V	10.01-09.05	76	KOB	1987 477 723	→ 1810
1.9 D	07.00-09.05	46	KOB	1987 477 723	→ 1810
1.9 JTD	10.01-09.05	74/77	KOB	1987 477 723	→ 1810
1.9 Multijet	10.05-12.10	74/77	FLR,VAN	1987 482 287	→ 2140
				1987 482 288	← 2140
			KOB	1987 477 723	→ 1810
			FLR,VAN	1987 482 287	→ 2140
		88	FLR,VAN	1987 482 288	← 2140
			KOB	1987 477 723	→ 1810

**Doblo Cargo [223]**

**F**





























1.6 i.e. 16V Bipower	10.05-12.10	76		0 204 004 564	← 54
				0986 473 487	↔
				0 204 004 565	→ 54
				0986 474 487	↔

1.6 i.e. 16V Bipower	10.05-12.10	76		0986 475 936	↔ 20,64
----------------------	-------------	----	--	--------------	---------

**Doblo Cargo [263]**

**F**

1.3 Multijet	02.10→	55/66	D84	0 204 004 566	← 54
				0986 134 077	↔
				0 204 004 567	→ 54
				0986 135 077	↔
1.4 1.4 Natural Power	02.10→	70/88	D84	0 204 004 566	← 54
				0986 134 077	↔
				0 204 004 567	→ 54
				0986 135 077	↔
1.6 Multijet	02.10→	66/74/77	D84	0 204 004 566	← 54
				0986 134 077	↔
				0 204 004 567	→ 54
				0986 135 077	↔

		S							
									
		2.0 Multijet	02.10→	99		D84	0 204 004 566 0 986 134 077	← 54 	
							0 204 004 567 0 986 135 077	→ 54 	
		1.3 Multijet	02.10→	55/66		254,452	0 986 475 971	↔ 25,4	
						452	0 986 475 940	↔ 19,05	
						822	0 986 475 936	↔ 20,64	
		1.4	02.10→	70/88		254,452	0 986 475 971	↔ 25,4	
		1.4 Natural Power				452	0 986 475 940	↔ 19,05	
						822	0 986 475 936	↔ 20,64	
		1.6 Multijet	02.10→	66/74/77		254,452	0 986 475 971	↔ 25,4	
						452	0 986 475 940	↔ 19,05	
						822	0 986 475 936	↔ 20,64	
		2.0 Multijet	02.10→	99		254,452	0 986 475 971	↔ 25,4	
						452	0 986 475 940	↔ 19,05	
						822	0 986 475 936	↔ 20,64	
<b>Doblo [Fase I]</b>									
									
		1.3 MPI 16V	11.01-01.06	59		MIH	0 986 473 125 0 986 474 125	 ← 54  → 54	
		1.3 MPI 16V	11.01-01.06	59			0 986 475 901	↔ 20,64	
<b>Doblo [223 MY00]</b>									
									
		1.2 i.e. 8V	07.00-09.05	48		MIH	0 986 473 125 0 986 474 125	 ← 54  → 54	
		1.3 JTD 16V	02.04-09.05	51		MIH	0 986 473 125 0 986 474 125	 ← 54  → 54	
		1.6 i.e. 16V	10.01-09.05	68-76		MIH	0 986 473 125	 ← 54	
		1.6 i.e. 16V Bipower					0 986 474 125	 → 54	
		1.9 D	07.00-09.05	46/74/77		MIH	0 986 473 125	 ← 54	
		1.9 JTD					0 986 474 125	 → 54	
		1.2 i.e. 8V	07.00-09.05	48			0 986 475 901	↔ 20,64	
			02.04-09.05	48		LOC	0 986 475 816	↔ 20,64	
		1.3 JTD 16V	02.04-09.05	51		ATE	0 986 475 901	↔ 20,64	
						LOC	0 986 475 816	↔ 20,64	
		1.6 i.e. 16V	10.01-09.05	76			0 986 475 901	↔ 20,64	
			02.04-09.05	76		LOC	0 986 475 816	↔ 20,64	
		1.6 i.e. 16V Bipower	01.03-09.05	68-76		ATE	0 986 475 901	↔ 20,64	
			02.04-09.05	68-76		LOC	0 986 475 816	↔ 20,64	
		1.9 D	07.00-09.05	46			0 986 475 901	↔ 20,64	
			02.04-09.05	46		LOC	0 986 475 816	↔ 20,64	
		1.9 JTD	10.01-01.04	74			0 986 475 901	↔ 20,64	
			11.02-09.05	77		ATE	0 986 475 901	↔ 20,64	
			02.04-09.05	77		LOC	0 986 475 816	↔ 20,64	
		1.2 i.e. 8V	07.00-09.05	48			1 987 477 723	→ 1810	
		1.3 JTD 16V	02.04-09.05	51			1 987 477 723	→ 1810	
		1.6 i.e. 16V	10.01-09.05	76			1 987 477 723	→ 1810	





FIAT Doblo [223 MY00]  
 1.9 D, JTD 07.00-09.05 46/74/77 1987 477 723 → 1810

**Doblo [223 MY05]**

	1.3 Multijet	10.05-12.10	55/62	TRQ	0 204 004 566 0 986 134 077	← 54	
					0 204 004 567 0 986 135 077	→ 54	
	1.4 i.e.	10.05-01.10	55-57	TW	0 204 004 567 0 986 135 077	→ 54	
		10.05→	55-57	TW	0 204 004 566 0 986 134 077	← 54	
					0 204 902 119 0 986 473 487	← 54	
	1.6 i.e. 16V Bipower	10.05-12.10	76	Ricam.Nr →5749151	0 204 004 564 0 986 473 487	← 54	
					0 204 004 565 0 986 474 487	→ 54	
				Ricam.Nr 5749152→	0 204 902 119 0 986 473 487	← 54	
					0 204 902 120 0 986 474 487	→ 54	
	1.9 Multijet	10.05-12.10	74/77/88	TRQ	0 204 004 566 0 986 134 077	← 54	
					0 204 004 567 0 986 135 077	→ 54	

**F**

	1.3 Multijet	10.05-12.10	55/62		0 986 475 936	↔ 20,64	
	1.4 i.e.	10.05→	55-57		0 986 475 936	↔ 20,64	
	1.6 i.e. 16V Bipower	10.05-12.10	76		0 986 475 936	↔ 20,64	
	1.9 Multijet	10.05-12.10	74/77/88		0 986 475 936	↔ 20,64	

	1.3 Multijet	10.05-12.10	55/62		1 987 477 723	→ 1810	
	1.4 i.e.	10.05→	55-57	TW	1 987 477 723	→ 1810	
	1.6 i.e. 16V Bipower	10.05-12.10	76		1 987 477 723	→ 1810	
	1.9 Multijet	10.05-12.10	74/77/88		1 987 477 723	→ 1810	

**Doblo [263]**











	1.3 Multijet	02.10→	66	D84	0 204 004 566 0 986 134 077	← 54	
	1.3 Multijet DPF				0 204 004 567 0 986 135 077	→ 54	
	1.4	02.10→	70/88	D84	0 204 004 566 0 986 134 077	← 54	
	1.4 Natural Power				0 204 004 567 0 986 135 077	→ 54	
	1.6 Multijet	02.10→	66/74/77	D84	0 204 004 566 0 986 134 077	← 54	
					0 204 004 567 0 986 135 077	→ 54	
	2.0 Multijet	02.10→	99	D84	0 204 004 566 0 986 134 077	← 54	
					0 204 004 567 0 986 135 077	→ 54	

		S							
	<b>1.3 Multijet</b> <b>1.3 Multijet DPF</b>	02.10→	66				254,452 452 822	0 986 <b>475 971</b> 0 986 <b>475 940</b> 0 986 <b>475 936</b>	↔ 25,4 ↔ 19,05 ↔ 20,64
	<b>1.4</b> <b>1.4 Natural Power</b>	02.10→	70/88				254,452 452 822	0 986 <b>475 971</b> 0 986 <b>475 940</b> 0 986 <b>475 936</b>	↔ 25,4 ↔ 19,05 ↔ 20,64
	<b>1.6 Multijet</b>	02.10→	66/74/77				254,452 452 822	0 986 <b>475 971</b> 0 986 <b>475 940</b> 0 986 <b>475 936</b>	↔ 25,4 ↔ 19,05 ↔ 20,64
	<b>2.0 Multijet</b>	02.10→	99				254,452 452 822	0 986 <b>475 971</b> 0 986 <b>475 940</b> 0 986 <b>475 936</b>	↔ 25,4 ↔ 19,05 ↔ 20,64
<b>Ducato</b>									
	<b>2.8 D Turbo</b> <b>2.8 D Turbo Interc.</b>	ABO 05.02-05.05	90/103,3				0 986 <b>473 995</b>	← 44	
		ABS 05.02-05.05	90/103,3				0 986 <b>474 995</b>	→ 44	
							0 986 <b>134 016</b>	← 44	
							0 986 <b>135 016</b>	→ 44	
	<b>2.5 D</b> <b>2.8 D Turbo, D Turbo Interc.</b>	11.97-12.99 04.99-04.02	62 90/103,3				0 986 <b>475 802</b> 0 986 <b>475 802</b>	↔ 27 ↔ 27	
	<b>2.5 D</b> <b>2.8 D Turbo</b> <b>2.8 D Turbo Interc.</b>	11.97-12.99 04.99-04.02 05.02-05.05 10.99-04.02	62 90 90 103,3				1 987 <b>477 114</b> 1 987 <b>477 114</b> 1 987 <b>482 002</b> 1 987 <b>477 114</b>	1059 1059 1078 1059	
<b>Ducato Cargo</b>									
	<b>2.8 JTD</b>	ABO 06.05-08.09	93				0 986 <b>473 995</b>	← 44	
		ABS 06.05-08.09	93				0 986 <b>474 995</b>	→ 44	
							0 986 <b>134 016</b>	← 44	
							0 986 <b>135 016</b>	→ 44	
	<b>2.5 D</b> <b>2.8 D Turbo</b>	11.97-05.05 04.99-04.02	62 90				0 986 <b>475 803</b> 0 986 <b>475 803</b>	↔ 28,6 ↔ 28,6	
	<b>2.5 D</b> <b>2.8 D Turbo</b> <b>2.8 JTD</b>	11.97-05.05 04.99-04.02 05.02-05.05 01.04-05.05 06.05-08.09	62 90 90 90 93				1 987 <b>477 114</b> 1 987 <b>477 114</b> 1 987 <b>482 002</b> 1 987 <b>482 003</b> 1 987 <b>482 003</b>	1059 1059 1078 2715 2715	
	<b>2.8 D Turbo</b> <b>2.8 JTD</b>	01.04-08.09	90/93				0 265 <b>006 673</b> <sup>3</sup>		
						LAB	0 265 <b>006 688</b> <sup>4</sup>		
						RAB	0 265 <b>006 689</b> <sup>4</sup>		



◀ FIAT										
<b>Ducato Minibus</b>										
	2.8 JTD	ABO	06.05-08.09	93			0986 473 995		← 44	
							0986 474 995		→ 44	
		ABS	06.05-08.09	93			0986 134 016		← 44	
							0986 135 016		→ 44	
	2.8 JTD		06.05-08.09	93			1987 482 003		2715	
	2.8 JTD		06.05-08.09	93			0 265 006 673 <sup>3</sup>			
					LAB	0 265 006 688 <sup>4</sup>				
					RAB	0 265 006 689 <sup>4</sup>				
<b>Ducato 10 [230]</b>										
	1.9 D	ABO	03.94-10.01	50/51/59/			0986 473 161		← 40,4	
							0986 474 161		→ 40,4	
	1.9 TD				60/66			0986 473 987		← 40
								0986 474 987		→ 40
	1.9 TD CAT	ABS	03.94-10.01	50/51/59/				0986 473 161		← 40,4
					63/79/80			0986 474 161		→ 40,4
	2.0	ABO	03.94-03.02	63/79/80			0986 473 987		← 40	
	2.0 i.e.						0986 474 987		→ 40	
	2.0 i.e. Bipower CNG 4x4	ABS	03.94-03.02	63/79/80			0986 473 987		← 40	
	2.0 JTD						0986 474 987		→ 40	
	2.5 D	ABO	03.94-03.98	62				0986 473 161		← 40,4
								0986 474 161		→ 40,4
			ABS	03.94-03.98	62			0986 473 987		← 40
							0986 474 987		→ 40	
	2.5 TD ECO	ABO	03.94-03.98	80/85			0986 473 162		← 40,4	
	2.5 TD EGR						0986 474 162		→ 40,4	
	2.5 TD EGR 4x4	ABS	03.94-03.98	80/85			0986 473 985		← 48	
	2.5 TD 4x4						0986 474 985		→ 48	
	2.8 D	ABO	04.98-03.02	64				0986 473 161		← 40,4
							0986 474 161		→ 40,4	
		ABS	04.98-03.02	64			0986 473 987		← 40	
						0986 474 987		→ 40		
2.8 JTD EGR 4x4, JTD 4x4, TD, TD EGR, TD EGR 4x4, TD 4x4	ABO	10.97-03.02	90/94				0986 473 162		← 40,4	
							0986 474 162		→ 40,4	
		ABS	10.97-03.02	90/94			0986 473 985		← 48	
						0986 474 985		→ 48		
	1.9 D, TD, TD CAT		03.94-10.01	50/51/59/60/66			0986 475 802		↔ 27	
	2.0, i.e., i.e. Bipower CNG 4x4		03.94-03.02	79/80			0986 475 802		↔ 27	
	2.5 D		03.94-03.98	62			0986 475 802		↔ 27	
	2.5 TD ECO		03.94-03.98	80		KOB	0986 475 801		↔ 25,4	
						KW	0986 475 802		↔ 27	
	2.5 TD EGR		03.94-03.98	85		KOB	0986 475 801		↔ 25,4	
						KW	0986 475 802		↔ 27	
	2.5 TD EGR 4x4, TD 4x4		03.94-03.98	85			0986 475 802		↔ 27	
	2.8 D		04.98-03.02	64			0986 475 802		↔ 27	
	2.8 JTD EGR 4x4, JTD 4x4, TD EGR 4x4, TD 4x4		10.97-03.02	90/94			0986 475 802		↔ 27	
	2.8 JTD, JTD EGR, TD, TD EGR		10.97-03.02	90/94		254	0986 475 801		↔ 25,4	



									
									
	<b>1.9D</b>	04.98-10.01	50				LLE	1 987 477 114	1059
							RLE	1 987 482 046	1137
						Fg.-Nr. →6158428	FEN	1 987 477 113	3025
	<b>1.9D</b>	03.94-10.01	51/59/60/				LLE	1 987 477 114	1059
	<b>1.9TD</b>		66				RLE	1 987 482 046	1137
	<b>1.9TD CAT</b>					Fg.-Nr. →6158428	FEN	1 987 477 113	3025
							FEV	1 987 477 115	3045
	<b>2.0</b>	03.94-11.01	79				LLE	1 987 477 114	1059
							RLE	1 987 482 046	1137
						Fg.-Nr. 6158429→	FEN	1 987 477 262	2806
		03.94-03.02	79			Fg.-Nr. →6158428	FEN	1 987 477 113	3025
		12.01-03.02	79				SBR	1 987 482 003	2715
							TBR	1 987 477 263	2827
	<b>2.0 i.e.</b>	03.94-11.01	80				LLE	1 987 477 114	1059
						Fg.-Nr. 6158429→	FEN	1 987 477 262	2806
		03.94-03.02	80			Fg.-Nr. →6158428	FEN	1 987 477 113	3025
		12.01-03.02	80				TBR	1 987 477 263	2827
	<b>2.0 i.e. Bipower CNG 4x4</b>	03.94-11.01	80				FEV	1 987 477 115	3045
							FMR	1 987 477 113	3025
							LLE	1 987 477 114	1059
		12.01-03.02	80				TBR	1 987 477 263	2827
	<b>2.0 i.e.</b>	03.94-11.01	80				RLE	1 987 482 046	1137
	<b>2.0 i.e. Bipower CNG 4x4</b>	12.01-03.02	80				LLE	1 987 482 002	1078
							RLE	1 987 482 004	1170
							SBR	1 987 482 003	2715
	<b>2.0 JTD</b>	10.01-11.01	63				LLE	1 987 477 114	1059
							RLE	1 987 482 046	1137
		10.01-03.02	63			Fg.-Nr. →6158428	FEN	1 987 477 113	3025
							FEV	1 987 477 115	3045
	<b>2.5D</b>	03.94-03.98	62/80				LLE	1 987 477 114	1059
	<b>2.5TD ECO</b>						RLE	1 987 482 046	1137
						Fg.-Nr. →6158428	FEN	1 987 477 113	3025
						Fg.-Nr. 6158429→	FEN	1 987 477 262	2806
	<b>2.5TD EGR</b>	03.94-03.98	85				RLE	1 987 482 046	1137
						Fg.-Nr. →6158428	FEN	1 987 477 113	3025
							FEV	1 987 477 115	3045
						Fg.-Nr. 6158429→	FEN	1 987 477 262	2806
							FEV	1 987 482 006	2827
	<b>2.5TD EGR, TD EGR 4x4, TD 4x4</b>	03.94-03.98	85				LLE	1 987 477 114	1059
	<b>2.5TD EGR 4x4</b>	03.94-03.98	85				FEV	1 987 477 115	3045
	<b>2.5TD EGR 4x4</b>	03.94-03.98	85				FMR	1 987 477 113	3025
	<b>2.5TD 4x4</b>						RLE	1 987 482 046	1137
	<b>2.5TD 4x4</b>	03.94-03.98	85			Fg.-Nr. →6158428	FEV	1 987 477 115	3045
	<b>2.8D</b>	04.98-11.01	64				LLE	1 987 477 114	1059
							RLE	1 987 482 046	1137
						Fg.-Nr. 6158429→	FEN	1 987 477 262	2806
		04.98-03.02	64			Fg.-Nr. →6158428	FEN	1 987 477 113	3025
		12.01-03.02	64				LLE	1 987 482 002	1078
							RLE	1 987 482 004	1170
							SBR	1 987 482 003	2715
							TBR	1 987 477 263	2827
	<b>2.8 JTD EGR 4x4</b>	08.00-11.01	94				FEV	1 987 477 115	3045
	<b>2.8 JTD 4x4</b>						FMR	1 987 477 113	3025
	<b>2.8 JTD</b>	08.00-11.01	94			Fg.-Nr. 6158429→	FEN	1 987 477 262	2806
	<b>2.8 JTD EGR</b>						FEV	1 987 482 006	2827
		08.00-03.02	94			Fg.-Nr. →6158428	FEN	1 987 477 113	3025
							FEV	1 987 477 115	3045





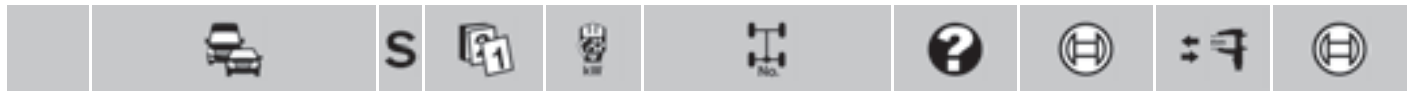

FIAT Ducato 10 [230]

2.8 JTD	08.00-11.01	94		LLE		1987 477 114	1059
2.8 JTD EGR				RLE		1987 482 046	1137
2.8 JTD EGR 4x4	12.01-03.02	94		LLE		1987 482 002	1078
2.8 JTD 4x4				RLE		1987 482 004	1170
				SBR		1987 482 003	2715
				TBR		1987 477 263	2827
2.8 TD	10.97-03.02	90	Fg.-Nr. →6158428	FEV		1987 477 115	3045
2.8 TD EGR 4x4	10.97-11.01	90		FEV		1987 477 115	3045
2.8 TD 4x4				FMR		1987 477 113	3025
2.8 TD	10.97-11.01	90	Fg.-Nr. 6158429→			1987 477 262	2806
2.8 TD EGR	10.97-03.02	90	Fg.-Nr. →6158428			1987 477 113	3025
2.8 TD	10.97-11.01	90		LLE		1987 477 114	1059
2.8 TD EGR				RLE		1987 482 046	1137
2.8 TD EGR 4x4	12.01-03.02	90		LLE		1987 482 002	1078
2.8 TD 4x4				RLE		1987 482 004	1170
				SBR		1987 482 003	2715
				TBR		1987 477 263	2827

	1.9 D	04.98-10.01	50	Fg.-Nr. 5445359→	LAB	BO	0 265 006 405 <sup>4</sup>	
					RAB	BO	0 265 006 406 <sup>4</sup>	
				Fg.-Nr. 5445359→5946342		BO	0 265 006 427 <sup>3</sup>	
				Fg.-Nr. 5946343→		BSY	0 265 006 673 <sup>3</sup>	
	1.9 D	08.97-03.98	51/59/60	Fg.-Nr. 5445359→	LAB	BO	0 265 006 405 <sup>4</sup>	
	1.9 TD				RAB	BO	0 265 006 406 <sup>4</sup>	
	1.9 TD CAT			Fg.-Nr. 5445359→5946342		BO	0 265 006 427 <sup>3</sup>	
	1.9 TD	04.98-10.01	66	Fg.-Nr. 5445359→	LAB	BO	0 265 006 405 <sup>4</sup>	
					RAB	BO	0 265 006 406 <sup>4</sup>	
				Fg.-Nr. 5445359→5946342		BO	0 265 006 427 <sup>3</sup>	
				Fg.-Nr. 5946343→		BSY	0 265 006 673 <sup>3</sup>	
	2.0	12.01-03.02	79/80		LAB		0 265 006 688 <sup>4</sup>	
	2.0 i.e.				RAB		0 265 006 689 <sup>4</sup>	
	2.0	03.94-03.02	79/80	Fg.-Nr. 5946343→		BSY	0 265 006 673 <sup>3</sup>	
	2.0 i.e.	08.97-11.01	79/80	Fg.-Nr. 5445359→	LAB	BO	0 265 006 405 <sup>4</sup>	
	2.0 i.e. Bipower CNG 4x4				RAB	BO	0 265 006 406 <sup>4</sup>	
		08.97-03.02	79/80	Fg.-Nr. 5445359→5946342		BO	0 265 006 427 <sup>3</sup>	
	2.0 JTD	10.01-11.01	63	Fg.-Nr. 5445359→	LAB	BO	0 265 006 405 <sup>4</sup>	
					RAB	BO	0 265 006 406 <sup>4</sup>	
		10.01-03.02	63	Fg.-Nr. 5946343→		BSY	0 265 006 673 <sup>3</sup>	
		12.01-03.02	63		LAB		0 265 006 688 <sup>4</sup>	
					RAB		0 265 006 689 <sup>4</sup>	
	2.5 D, TD ECO, TD EGR, TD EGR 4x4, TD 4x4	08.97-03.98	62/80/85	Fg.-Nr. 5445359→	LAB	BO	0 265 006 405 <sup>4</sup>	
					RAB	BO	0 265 006 406 <sup>4</sup>	
				Fg.-Nr. 5445359→5946342		BO	0 265 006 427 <sup>3</sup>	
	2.8 D	10.97-11.01	64/90	Fg.-Nr. 5445359→	LAB	BO	0 265 006 405 <sup>4</sup>	
	2.8 TD				RAB	BO	0 265 006 406 <sup>4</sup>	
	2.8 TD EGR	10.97-03.02	64/90	Fg.-Nr. 5445359→5946342		BO	0 265 006 427 <sup>3</sup>	
	2.8 TD EGR 4x4			Fg.-Nr. 5946343→		BSY	0 265 006 673 <sup>3</sup>	
	2.8 TD 4x4	12.01-03.02	64/90		LAB		0 265 006 688 <sup>4</sup>	
					RAB		0 265 006 689 <sup>4</sup>	
	2.8 JTD EGR 4x4, JTD 4x4	08.00-03.02	94	Fg.-Nr. 5445359→5946342		BO	0 265 006 427 <sup>3</sup>	
	2.8 JTD	08.00-11.01	94	Fg.-Nr. 5445359→	LAB	BO	0 265 006 405 <sup>4</sup>	
	2.8 JTD EGR				RAB	BO	0 265 006 406 <sup>4</sup>	
	2.8 JTD EGR 4x4	08.00-03.02	94	Fg.-Nr. 5946343→		BSY	0 265 006 673 <sup>3</sup>	
	2.8 JTD 4x4	12.01-03.02	94		LAB		0 265 006 688 <sup>4</sup>	
					RAB		0 265 006 689 <sup>4</sup>	























Ducato 10 [290]

	1.9 D	07.90-02.94	52/60		MMH		0 986 473 776	38
	1.9 TD						0 986 473 777	38
	2.0	07.90-02.94	55/63		MMH		0 986 473 776	38
							0 986 473 777	38

		S							
2.5 TD		07.90-02.94	70			MIH	0 986 473 776		← 38
							0 986 473 777		→ 38
	1.9 D, TD	07.90-02.94	52/60				0 986 475 420		↔ 25,4
	2.0	07.90-02.94	55/63				0 986 475 420		↔ 25,4
	2.5 TD	07.90-02.94	70				0 986 475 420		↔ 25,4
	1.9 D	07.90-02.94	52/60				1 987 477 515		2566
	1.9 TD					FKR, LLE	1 987 477 417		1608
						FKR, RLE	1 987 477 420		1888
						FLR, LLE	1 987 477 419		2338
						FLR, RLE	1 987 477 421		2620
	2.0	07.90-02.94	55/63				1 987 477 515		2566
						FKR, LLE	1 987 477 417		1608
						FKR, RLE	1 987 477 420		1888
						FLR, LLE	1 987 477 419		2338
						FLR, RLE	1 987 477 421		2620
	2.5 TD	07.90-02.94	70				1 987 477 515		2566
						FKR, LLE	1 987 477 417		1608
						FKR, RLE	1 987 477 420		1888
						FLR, LLE	1 987 477 419		2338
						FLR, RLE	1 987 477 421		2620
<b>Ducato 11 [244]</b>									
	2.0 i.e.	ABO 04.02-08.06	81			MIH	0 986 473 995		← 44
							0 986 474 995		→ 44
		ABS 04.02-08.06	81			MIH	0 986 134 016		← 44
	2.0 i.e., i.e. 4x4	ABS 04.02-07.03	81			MIH	0 986 135 016		→ 44
	2.0 i.e. 4x4	ABO 04.02-08.06	81			MIH	0 986 473 995		← 44
							0 986 474 995		→ 44
		ABS 04.02-08.06	81			MIH	0 986 134 016		← 44
	2.0 JTD	ABO 04.02-08.06	62			MIH	0 986 473 995		← 44
							0 986 474 995		→ 44
		ABS 04.02-07.03	62			MIH	0 986 135 016		→ 44
		04.02-08.06	62			MIH	0 986 134 016		← 44
	2.3 JTD	ABO 04.02-08.06	81			MIH	0 986 473 995		← 44
							0 986 474 995		→ 44
		ABS 04.02-08.06	81			MIH	0 986 134 016		← 44
	2.3 JTD EGR	ABO 04.02-08.06	81			MIH	0 986 473 995		← 44
							0 986 474 995		→ 44
		ABS 04.02-08.06	81			MIH	0 986 134 016		← 44
	2.3 JTD, JTD EGR	ABS 04.02-07.03	81			MIH	0 986 135 016		→ 44
	2.8 JTD	ABO 04.02-08.06	94			MIH	0 986 473 995		← 44
							0 986 474 995		→ 44
		ABS 04.02-08.06	94			MIH	0 986 134 016		← 44
	2.8 JTD EGR	ABO 04.02-08.06	94			MIH	0 986 473 995		← 44
							0 986 474 995		→ 44
		ABS 04.02-08.06	94			MIH	0 986 134 016		← 44
	2.8 JTD EGR 4x4	ABO 04.02-08.06	94			MIH	0 986 473 995		← 44
							0 986 474 995		→ 44
		ABS 04.02-08.06	94			MIH	0 986 134 016		← 44
	2.8 JTD, JTD EGR, JTD EGR 4x4	ABS 04.02-07.03	94			MIH	0 986 135 016		→ 44
	2.8 JTD 4x4	ABO 04.02-08.06	94			MIH	0 986 473 995		← 44
							0 986 474 995		→ 44
		ABS 04.02-08.06	94			MIH	0 986 134 016		← 44
							0 986 135 016		→ 44











		S									
<b>FIAT Ducato 11 [244]</b>											
	2.8 TD	ABO	10.02-08.06	90		MHH	0986 473 995		← 44		
							0986 474 995		→ 44		
			ABS	10.02-08.06	90		MHH	0986 134 016		← 44	
	2.8 TD EGR	ABO	10.02-08.06	90		MHH	0986 473 995		← 44		
							0986 474 995		→ 44		
			ABS	10.02-08.06	90		MHH	0986 134 016		← 44	
	2.8 TD EGR 4x4	ABO	10.02-08.06	90		MHH	0986 473 995		← 44		
							0986 474 995		→ 44		
			ABS	10.02-08.06	90		MHH	0986 134 016		← 44	
	2.8 TD, TD EGR, TD EGR 4x4	ABS	10.02-07.03	90		MHH	0986 135 016		→ 44		
	2.0 i.e., JTD		04.02-08.06	62/81			LOC	0986 475 906		↔ 26,99	
	2.3 JTD, JTD EGR		04.02-08.06	81			LOC	0986 475 906		↔ 26,99	
	2.8 JTD, JTD EGR, TD, TD EGR		04.02-08.06	90/94			LOC	0986 475 906		↔ 26,99	
	2.0 i.e.		04.02-08.06	81			SBR	1987 482 003		2715	
							TBR	1987 477 263		2827	
	2.0 i.e. 4x4		04.02-08.06	81				1987 482 003		2715	
	2.0 JTD		04.02-08.06	62				SBR	1987 482 003		2715
								TBR	1987 477 263		2827
	2.3 JTD		04.02-08.06	81				SBR	1987 482 003		2715
								TBR	1987 477 263		2827
									1987 477 263		2827
			01.08-12.11	81				1987 477 263		2827	
								1987 482 002		1078	
	2.3 JTD EGR		04.02-08.06	81				SBR	1987 482 003		2715
								TBR	1987 477 263		2827
	2.8 JTD EGR 4x4		04.02-08.06	90/94				1987 482 003		2715	
	2.8 JTD, JTD EGR		04.02-08.06	90/94				SBR	1987 482 003		2715
	2.8 JTD, JTD EGR, TD, TD EGR		04.02-08.06	90/94				TBR	1987 477 263		2827
2.8 JTD 4x4, TD, TD EGR		04.02-08.06	90/94				SBR	1987 482 003		2715	
2.8 TD EGR 4x4		10.02-08.06	90/94					1987 482 003		2715	
	2.0 i.e., i.e. 4x4, JTD		04.02-08.06	62/81				0265 006 673 <sup>3</sup>			
	2.0 i.e.		04.02-08.06	62/81			LAB	0265 006 688 <sup>4</sup>			
	2.0 JTD						RAB	0265 006 689 <sup>4</sup>			
	2.3 JTD		04.02-08.06	81					0265 006 673 <sup>3</sup>		
									0265 006 688 <sup>4</sup>		
									0265 006 689 <sup>4</sup>		
			01.08-12.11	81				0265 006 673 <sup>3</sup>			
								LAB	0265 006 688 <sup>4</sup>		
								RAB	0265 006 689 <sup>4</sup>		
	2.3 JTD EGR		04.02-08.06	81					0265 006 673 <sup>3</sup>		
									0265 006 688 <sup>4</sup>		
								RAB	0265 006 689 <sup>4</sup>		
2.8 JTD, JTD EGR, JTD EGR 4x4, JTD 4x4, TD, TD EGR, TD EGR 4x4		04.02-08.06	90/94					0265 006 673 <sup>3</sup>			
2.8 JTD, JTD EGR, TD, TD EGR		04.02-08.06	90/94				LAB	0265 006 688 <sup>4</sup>			
							RAB	0265 006 689 <sup>4</sup>			
<b>Ducato 11 [250]</b>											
	100 Multijet		06.06-12.14	74				0204 902 000		← 48	
								0986 134 052			
								0204 902 001		→ 48	
								0986 135 052			

		S							
<b>120</b> Multijet		06.06-12.14	88				0 204 902 000	← 48	
							0 986 134 052		
							0 204 902 001	→ 48	
							0 986 135 052		
<b>130</b> Multijet		06.06-12.14	96				0 204 902 000	← 48	
							0 986 134 052		
							0 204 902 001	→ 48	
							0 986 135 052		
<b>160</b> Multijet		06.06-12.14	116				0 204 902 000	← 48	
							0 986 134 052		
							0 204 902 001	→ 48	
							0 986 135 052		
									
 <b>100</b> Multijet		06.06-12.14	74		MPR,TW		1 987 482 447	2910	
							1 987 482 450	1908	
					MPR,TW		1 987 482 447	2910	
							1 987 482 450	1908	
					SVN		1 987 482 214	↔ 1485	
					SVN		1 987 482 213	↔ 1390	
<b>120</b> Multijet		06.06-12.14	88		MPR,TW		1 987 482 447	2910	
							1 987 482 450	1908	
					MPR,TW		1 987 482 447	2910	
							1 987 482 450	1908	
					SVN		1 987 482 214	↔ 1485	
					SVN		1 987 482 213	↔ 1390	
<b>130</b> Multijet		06.06-12.14	96		MPR,TW		1 987 482 447	2910	
							1 987 482 450	1908	
					MPR,TW		1 987 482 447	2910	
							1 987 482 450	1908	
					SVN		1 987 482 214	↔ 1485	
					SVN		1 987 482 213	↔ 1390	
<b>160</b> Multijet		06.06-12.14	116		MPR,TW		1 987 482 447	2910	
							1 987 482 450	1908	
					MPR,TW		1 987 482 447	2910	
							1 987 482 450	1908	
					SVN		1 987 482 214	↔ 1485	
					SVN		1 987 482 213	↔ 1390	
									
<b>100</b> Multijet		06.06-12.14	74				0 265 007 685 <sup>3</sup>		
						SVN	0 265 007 833 <sup>4</sup>		
						SVN	0 265 007 980 <sup>4</sup>		
<b>120</b> Multijet		06.06-12.14	88				0 265 007 685 <sup>3</sup>		
						SVN	0 265 007 833 <sup>4</sup>		
						SVN	0 265 007 980 <sup>4</sup>		
<b>130</b> Multijet		06.06-12.14	96				0 265 007 685 <sup>3</sup>		
						SVN	0 265 007 833 <sup>4</sup>		
						SVN	0 265 007 980 <sup>4</sup>		
<b>160</b> Multijet		06.06-12.14	116				0 265 007 685 <sup>3</sup>		
						SVN	0 265 007 833 <sup>4</sup>		
						SVN	0 265 007 980 <sup>4</sup>		
<b>Ducato 12 [290]</b>									
									
 <b>2.0</b> 4x4		07.90-02.94	63		MIH		0 986 473 776	 ← 38	
							0 986 473 777	 → 38	
<b>2.5 D</b> 4x4		07.90-02.94	55				0 986 473 776	 ← 38	
							0 986 473 777	 → 38	



		S							
◀ FIAT Ducato 12 [290]									
	2.0 4x4	07.90-02.94	63				0986 475 420	↔ 25,4	
	2.0 4x4	07.90-02.94	63		LLE		1987 477 417	1608	
					RLE		1987 477 420	1888	
	2.5 D 4x4	07.90-02.94	55/70		LLE		1987 477 417	1608	
	2.5 TD 4x4				RLE		1987 477 420	1888	
<b>Ducato 14 [230]</b>									
	1.9 TD	ABO	03.94-10.01	59/60/66			0986 473 161	← 40,4	
	1.9 TD CAT						0986 474 161	→ 40,4	
		ABS	03.94-10.01	59/60/66			0986 473 987	← 40	
							0986 474 987	→ 40	
	2.0	ABO	03.94-03.02	63/79/80			0986 473 161	← 40,4	
	2.0 i.e.						0986 474 161	→ 40,4	
	2.0 i.e. Bipower CNG 4x4	ABS	03.94-03.02	63/79/80			0986 473 987	← 40	
	2.0 JTD						0986 474 987	→ 40	
	2.5 D	ABO	03.94-03.98	62			0986 473 161	← 40,4	
							0986 474 161	→ 40,4	
		ABS	03.94-03.98	62			0986 473 987	← 40	
							0986 474 987	→ 40	
	2.5 TD, TD ECO, TD ECO 4x4, TD EGR, TD EGR 4x4	ABO	03.94-03.02	80/85			0986 473 162	← 40,4	
							0986 474 162	→ 40,4	
		ABS	03.94-03.02	80/85			0986 473 985	← 48	
							0986 474 985	→ 48	
	2.8 D	ABO	04.98-03.02	64			0986 473 161	← 40,4	
							0986 474 161	→ 40,4	
		ABS	04.98-03.02	64			0986 473 987	← 40	
							0986 474 987	→ 40	
	2.8 JTD EGR 4x4, JTD 4x4, TD, TD EGR, TD EGR 4x4, TD 4x4	ABO	10.97-03.02	90/94			0986 473 162	← 40,4	
							0986 474 162	→ 40,4	
		ABS	10.97-03.02	90/94			0986 473 985	← 48	
							0986 474 985	→ 48	
	1.9 TD, TD CAT	03.94-10.01	59/60/66				0986 475 802	↔ 27	
	2.0, i.e., i.e. Bipower CNG 4x4	03.94-03.02	79/80				0986 475 802	↔ 27	
	2.5 D	03.94-03.98	62				0986 475 802	↔ 27	
	2.5 TD ECO 4x4	03.94-03.98	80/85				0986 475 802	↔ 27	
	2.5 TD EGR	03.94-03.98	80/85		KW		0986 475 802	↔ 27	
	2.5 TD EGR 4x4	03.94-03.98	80/85				0986 475 802	↔ 27	
	2.5 TD, TD ECO	03.94-03.02	80/85		KW		0986 475 802	↔ 27	
	2.5 TD, TD ECO, TD EGR	03.94-03.02	80/85		KOB		0986 475 801	↔ 25,4	
	2.8 D	04.98-03.02	64				0986 475 802	↔ 27	
	2.8 JTD EGR 4x4, JTD 4x4, TD EGR 4x4, TD 4x4	10.97-03.02	90/94				0986 475 802	↔ 27	
	2.8 JTD, JTD EGR, TD, TD EGR	10.97-03.02	90/94		254		0986 475 801	↔ 25,4	
	1.9 TD	03.94-10.01	59/60/66		LLE		1987 477 114	1059	
	1.9 TD CAT				RLE		1987 482 046	1137	
				Fg.-Nr. →6158428	FEN		1987 477 113	3025	
					FEV		1987 477 115	3045	
	2.0	03.94-11.01	79		LLE		1987 477 114	1059	
					RLE		1987 482 046	1137	

		<b>S</b>							
<b>2.0</b>		03.94-03.02	79	Fg.-Nr. →6158428	FEN	1 987 477 113	3025		
					FEV	1 987 477 115	3045		
<b>2.0 i.e.</b>		03.94-11.01	80		RLE	1 987 482 046	1137		
				Fg.-Nr. 6158429→	FEN	1 987 477 262	2806		
					FEV	1 987 482 006	2827		
		03.94-03.02	80	Fg.-Nr. →6158428	FEN	1 987 477 113	3025		
					FEV	1 987 477 115	3045		
		12.01-03.02	80		TBR	1 987 477 263	2827		
<b>2.0 i.e. Bipower CNG 4x4</b>		03.94-11.01	80		FEV	1 987 477 115	3045		
					FMR	1 987 477 113	3025		
					RLE	1 987 482 046	1137		
		12.01-03.02	80		TBR	1 987 477 263	2827		
<b>2.0 i.e.</b>		03.94-11.01	80		LLE	1 987 477 114	1059		
<b>2.0 i.e. Bipower CNG 4x4</b>		12.01-03.02	80		LLE	1 987 482 002	1078		
					RLE	1 987 482 004	1170		
					SBR	1 987 482 003	2715		
<b>2.0 JTD</b>		10.01-11.01	63		LLE	1 987 477 114	1059		
					RLE	1 987 482 046	1137		
		10.01-03.02	63			1 987 477 263	2827		
				Fg.-Nr. →6158428	FEN	1 987 477 113	3025		
					FEV	1 987 477 115	3045		
<b>2.5 D</b>		03.94-03.98	62		LLE	1 987 477 114	1059		
					RLE	1 987 482 046	1137		
				Fg.-Nr. →6158428	FEN	1 987 477 113	3025		
					FEV	1 987 477 115	3045		
				Fg.-Nr. 6158429→	FEN	1 987 477 262	2806		
					FEV	1 987 482 006	2827		
<b>2.5 TD</b>		03.94-11.01	85	Fg.-Nr. 6158429→	FEV	1 987 482 006	2827		
		12.01-03.02	85		LLE	1 987 482 002	1078		
					RLE	1 987 482 004	1170		
					SBR	1 987 482 003	2715		
					TBR	1 987 477 263	2827		
<b>2.5 TD ECO</b>		03.94-03.98	80		RLE	1 987 482 046	1137		
				Fg.-Nr. →6158428	FEN	1 987 477 113	3025		
				Fg.-Nr. 6158429→	FEN	1 987 477 262	2806		
					FEV	1 987 482 006	2827		
<b>2.5 TD ECO</b>		03.94-03.98	80		LLE	1 987 477 114	1059		
<b>2.5 TD ECO 4x4</b>				Fg.-Nr. →6158428	FEV	1 987 477 115	3045		
<b>2.5 TD ECO 4x4</b>		03.94-03.98	80		FMR	1 987 477 113	3025		
					RLE	1 987 482 046	1137		
<b>2.5 TD EGR</b>		03.94-03.98	85	Fg.-Nr. 6158429→	FEV	1 987 482 006	2827		
<b>2.5 TD EGR 4x4</b>		03.94-03.98	85		FEV	1 987 477 115	3045		
					FMR	1 987 477 113	3025		
<b>2.5 TD</b>		03.94-11.01	85	Fg.-Nr. 6158429→	FEN	1 987 477 262	2806		
<b>2.5 TD EGR</b>		03.94-03.02	85	Fg.-Nr. →6158428	FEN	1 987 477 113	3025		
					FEV	1 987 477 115	3045		
<b>2.5 TD, TD EGR, TD EGR 4x4</b>		03.94-11.01	85		LLE	1 987 477 114	1059		
					RLE	1 987 482 046	1137		
<b>2.8 D</b>		04.98-11.01	64		LLE	1 987 477 114	1059		
					RLE	1 987 482 046	1137		
				Fg.-Nr. 6158429→	FEN	1 987 477 262	2806		
					FEV	1 987 482 006	2827		
		04.98-03.02	64	Fg.-Nr. →6158428	FEN	1 987 477 113	3025		
					FEV	1 987 477 115	3045		
		12.01-03.02	64		LLE	1 987 482 002	1078		
					RLE	1 987 482 004	1170		
					SBR	1 987 482 003	2715		
					TBR	1 987 477 263	2827		
<b>2.8 JTD EGR 4x4</b>		08.00-11.01	90/94		FEV	1 987 477 115	3045		
<b>2.8 JTD 4x4</b>					FMR	1 987 477 113	3025		
<b>2.8 JTD</b>		08.00-03.02	90/94	Fg.-Nr. →6158428	FEN	1 987 477 113	3025		
<b>2.8 JTD EGR</b>					FEV	1 987 477 115	3045		



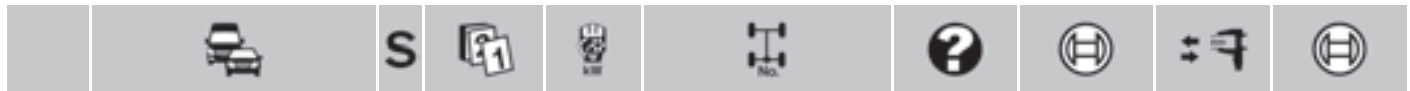

















































FIAT Ducato 14 [230]									
2.8 JTD, JTD EGR, JTD EGR 4x4, JTD 4x4, TD, TD EGR, TD EGR 4x4, TD 4x4	10.97-11.01	90/94		LLE		1987	<b>477 114</b>		1059
				RLE		1987	<b>482 046</b>		1137
	12.01-03.02	90/94		LLE		1987	<b>482 002</b>		1078
				RLE		1987	<b>482 004</b>		1170
				SBR		1987	<b>482 003</b>		2715
				TBR		1987	<b>477 263</b>		2827
2.8 JTD, JTD EGR, TD, TD EGR	10.97-11.01	90/94	Fg.-Nr. 6158429→	FEN		1987	<b>477 262</b>		2806
				FEV		1987	<b>482 006</b>		2827
2.8 TD EGR 4x4	10.97-11.01	90/94		FEV		1987	<b>477 115</b>		3045
2.8 TD 4x4				FMR		1987	<b>477 113</b>		3025
2.8 TD	10.97-03.02	90/94	Fg.-Nr. →6158428	FEN		1987	<b>477 113</b>		3025
2.8 TD EGR				FEV		1987	<b>477 115</b>		3045
1.9 TD	04.98-10.01	66	Fg.-Nr. 5445359→	LAB	BO	0 265	<b>006 405<sup>4</sup></b>		
				RAB	BO	0 265	<b>006 406<sup>4</sup></b>		
								BO	0 265
			Fg.-Nr. 5445359→5946342						
			Fg.-Nr. 5946343→			BSY	0 265	<b>006 673<sup>3</sup></b>	
1.9 TD	08.97-03.98	59/60	Fg.-Nr. 5445359→	LAB	BO	0 265	<b>006 405<sup>4</sup></b>		
1.9 TD CAT				RAB	BO	0 265	<b>006 406<sup>4</sup></b>		
			Fg.-Nr. 5445359→5946342			BO	0 265	<b>006 427<sup>3</sup></b>	
2.0	12.01-03.02	79/80		LAB		0 265	<b>006 688<sup>4</sup></b>		
2.0 i.e.				RAB		0 265	<b>006 689<sup>4</sup></b>		
2.0	03.94-03.02	79/80	Fg.-Nr. 5946343→			BSY	0 265	<b>006 673<sup>3</sup></b>	
2.0 i.e.	08.97-11.01	79/80	Fg.-Nr. 5445359→	LAB	BO	0 265	<b>006 405<sup>4</sup></b>		
2.0 i.e. Bipower CNG 4x4				RAB	BO	0 265	<b>006 406<sup>4</sup></b>		
	08.97-03.02	79/80	Fg.-Nr. 5445359→5946342			BO	0 265	<b>006 427<sup>3</sup></b>	
2.0 JTD	10.01-11.01	63	Fg.-Nr. 5445359→	LAB	BO	0 265	<b>006 405<sup>4</sup></b>		
				RAB	BO	0 265	<b>006 406<sup>4</sup></b>		
	10.01-03.02	63	Fg.-Nr. 5946343→			BSY	0 265	<b>006 673<sup>3</sup></b>	
	12.01-03.02	63		LAB		0 265	<b>006 688<sup>4</sup></b>		
				RAB		0 265	<b>006 689<sup>4</sup></b>		
2.5 D	08.97-03.98	62/80	Fg.-Nr. 5445359→	LAB	BO	0 265	<b>006 405<sup>4</sup></b>		
2.5 TD ECO				RAB	BO	0 265	<b>006 406<sup>4</sup></b>		
2.5 TD ECO 4x4			Fg.-Nr. 5445359→5946342			BO	0 265	<b>006 427<sup>3</sup></b>	
2.5 TD	12.01-03.02	85		LAB		0 265	<b>006 688<sup>4</sup></b>		
				RAB		0 265	<b>006 689<sup>4</sup></b>		
2.5 TD	08.97-11.01	85	Fg.-Nr. 5445359→	LAB	BO	0 265	<b>006 405<sup>4</sup></b>		
2.5 TD EGR				RAB	BO	0 265	<b>006 406<sup>4</sup></b>		
2.5 TD EGR 4x4	08.97-03.02	85	Fg.-Nr. 5445359→5946342			BO	0 265	<b>006 427<sup>3</sup></b>	
2.8 D	10.97-11.01	64/90	Fg.-Nr. 5445359→	LAB	BO	0 265	<b>006 405<sup>4</sup></b>		
2.8 TD				RAB	BO	0 265	<b>006 406<sup>4</sup></b>		
2.8 TD EGR	10.97-03.02	64/90	Fg.-Nr. 5445359→5946342			BO	0 265	<b>006 427<sup>3</sup></b>	
2.8 TD EGR 4x4			Fg.-Nr. 5946343→			BSY	0 265	<b>006 673<sup>3</sup></b>	
2.8 TD 4x4	12.01-03.02	64/90		LAB		0 265	<b>006 688<sup>4</sup></b>		
				RAB		0 265	<b>006 689<sup>4</sup></b>		
2.8 JTD EGR 4x4, JTD 4x4	08.00-03.02	94	Fg.-Nr. 5445359→5946342			BO	0 265	<b>006 427<sup>3</sup></b>	
2.8 JTD	08.00-11.01	94	Fg.-Nr. 5445359→	LAB	BO	0 265	<b>006 405<sup>4</sup></b>		
2.8 JTD EGR				RAB	BO	0 265	<b>006 406<sup>4</sup></b>		
2.8 JTD EGR 4x4	08.00-03.02	94	Fg.-Nr. 5946343→			BSY	0 265	<b>006 673<sup>3</sup></b>	
2.8 JTD 4x4	12.01-03.02	94		LAB		0 265	<b>006 688<sup>4</sup></b>		
				RAB		0 265	<b>006 689<sup>4</sup></b>		

**Ducato 14 [290]**

1.9 TD	07.90-02.94	60		MIH		0 986	<b>473 776</b>		38
									38
2.0	07.90-02.94	55/63		MIH		0 986	<b>473 776</b>		38
									38
2.5 D	07.90-02.94	55/70		MIH		0 986	<b>473 776</b>		38
									38
2.5 TD						0 986	<b>473 777</b>		38

									
									
	1.9 TD		07.90-02.94	60			0 986 475 420	↔ 25,4	
	2.0		07.90-02.94	55/63			0 986 475 420	↔ 25,4	
	2.5 D, TD		07.90-02.94	55/70			0 986 475 420	↔ 25,4	
									
	1.9 TD		07.90-02.94	60			1 987 477 515	2566	
						FKR, LLE	1 987 477 417	1608	
						FKR, RLE	1 987 477 420	1888	
						FLR, LLE	1 987 477 419	2338	
						FLR, RLE	1 987 477 421	2620	
	2.0		07.90-02.94	55/63			1 987 477 515	2566	
						FKR, LLE	1 987 477 417	1608	
						FKR, RLE	1 987 477 420	1888	
						FLR, LLE	1 987 477 419	2338	
						FLR, RLE	1 987 477 421	2620	
	2.5 D		07.90-02.94	55/70			1 987 477 515	2566	
	2.5 TD					FKR, LLE	1 987 477 417	1608	
						FKR, RLE	1 987 477 420	1888	
						FLR, LLE	1 987 477 419	2338	
						FLR, RLE	1 987 477 421	2620	
<b>Ducato 15 [244]</b>									
									
	2.0 i.e.	ABO	04.02-08.06	81		MIH	0 986 473 995	 ← 44	
							0 986 474 995	 → 44	
		ABS	04.02-08.06	81		MIH	0 986 134 016	 ← 44	
	2.0 i.e. Bipower CNG	ABO	04.02-08.06	71-81		MIH	0 986 473 995	 ← 44	
							0 986 474 995	 → 44	
		ABS	04.02-08.06	71-81		MIH	0 986 134 016	 ← 44	
	2.0 i.e. Bipower CNG, i.e. Bipower CNG 4x4, i.e. Bipower LPG, i.e. Bipower LPG 4x4	ABS	04.02-07.03	71-81		MIH	0 986 135 016	 → 44	
	2.0 i.e. Bipower CNG 4x4	ABO	04.02-08.06	71-81		MIH	0 986 473 995	 ← 44	
							0 986 474 995	 → 44	
		ABS	04.02-08.06	71-81		MIH	0 986 134 016	 ← 44	
	2.0 i.e. Bipower LPG	ABO	04.02-08.06	71-81		MIH	0 986 473 995	 ← 44	
							0 986 474 995	 → 44	
		ABS	04.02-08.06	71-81		MIH	0 986 134 016	 ← 44	
	2.0 i.e. Bipower LPG 4x4	ABO	04.02-08.06	71-81		MIH	0 986 473 995	 ← 44	
							0 986 474 995	 → 44	
		ABS	04.02-08.06	71-81		MIH	0 986 134 016	 ← 44	
	2.0 i.e., i.e. 4x4	ABS	04.02-07.03	81		MIH	0 986 135 016	 → 44	
	2.0 i.e. 4x4	ABO	04.02-08.06	81		MIH	0 986 473 995	 ← 44	
							0 986 474 995	 → 44	
		ABS	04.02-08.06	81		MIH	0 986 134 016	 ← 44	
	2.0 JTD	ABO	04.02-08.06	62		MIH	0 986 473 995	 ← 44	
							0 986 474 995	 → 44	
		ABS	04.02-07.03	62		MIH	0 986 135 016	 → 44	
			04.02-08.06	62		MIH	0 986 134 016	 ← 44	
	2.3 JTD	ABO	04.02-08.06	81		MIH	0 986 473 995	 ← 44	
							0 986 474 995	 → 44	
		ABS	04.02-08.06	81		MIH	0 986 134 016	 ← 44	
	2.3 JTD EGR	ABO	04.02-08.06	81		MIH	0 986 473 995	 ← 44	
							0 986 474 995	 → 44	
		ABS	04.02-08.06	81		MIH	0 986 134 016	 ← 44	
	2.3 JTD, JTD EGR	ABS	04.02-07.03	81		MIH	0 986 135 016	 → 44	
	2.8 JTD	ABO	04.02-08.06	94		MIH	0 986 473 995	 ← 44	
							0 986 474 995	 → 44	
		ABS	04.02-08.06	94		MIH	0 986 134 016	 ← 44	





		S										
	FIAT Ducato 15 [244]											
2.8 JTD CGV	ABO	04.04-08.06	107			MHH	0986 473 995		← 44			
							0986 474 995		→ 44			
2.8 JTD EGR	ABO	04.02-08.06	94			MHH	0986 134 016		← 44			
							0986 473 995		← 44			
2.8 JTD EGR 4x4	ABO	04.02-08.06	94			MHH	0986 474 995		→ 44			
							0986 134 016		← 44			
2.8 JTD, JTD EGR, JTD EGR 4x4, JTD 4x4	ABS	04.02-07.03	94			MHH	0986 473 995		← 44			
							0986 134 016		← 44			
2.8 JTD 4x4	ABO	04.02-08.06	94			MHH	0986 473 995		← 44			
							0986 474 995		→ 44			
2.8 TD	ABO	10.02-08.06	90			MHH	0986 134 016		← 44			
							0986 473 995		← 44			
2.8 TD EGR	ABO	10.02-08.06	90			MHH	0986 473 995		← 44			
							0986 474 995		→ 44			
2.8 TD EGR 4x4	ABO	10.02-08.06	90			MHH	0986 134 016		← 44			
							0986 473 995		← 44			
2.8 TD, TD EGR, TD EGR 4x4, TD 4x4	ABS	10.02-07.03	90			MHH	0986 473 995		← 44			
							0986 134 016		← 44			
2.8 TD 4x4	ABO	10.02-08.06	90			MHH	0986 473 995		← 44			
							0986 474 995		→ 44			
	ABS	10.02-08.06	90			MHH	0986 134 016		← 44			
							0986 473 995		← 44			
		2.0 i.e., i.e. Bipower CNG, i.e. Bipower LPG, JTD	04.02-08.06	62/71-81			LOC	0986 475 906		↔ 26,99		
		2.3 JTD, JTD EGR	04.02-08.06	81				LOC	0986 475 906		↔ 26,99	
		2.8 JTD, JTD CGV, JTD EGR, TD, TD EGR, TD 4x4	04.02-08.06	90/94/107				LOC	0986 475 906		↔ 26,99	
		2.0 i.e.	04.02-08.06	81			SBR	1987 482 003		2715		
								TBR	1987 477 263		2827	
		2.0 i.e. Bipower CNG, i.e. Bipower LPG, JTD	04.02-08.06	62/71-81				SBR	1987 482 003		2715	
								TBR	1987 477 263		2827	
		2.0 i.e. 4x4	04.02-08.06	81					1987 482 003		2715	
		2.3 JTD	04.02-08.06	81				SBR	1987 482 003		2715	
		2.3 JTD EGR		01.08-12.11	81				TBR	1987 477 263		2827
										1987 477 263		2827
		2.8 JTD CGV	ABO	04.04-08.06	107				SBR	1987 482 003		2715
									TBR	1987 477 263		2827
		2.8 JTD EGR 4x4, JTD 4x4	ABO	04.02-08.06	90/94					1987 482 003		2715
		2.8 JTD, JTD EGR	ABO	04.02-08.06	90/94				SBR	1987 482 003		2715
		2.8 JTD, JTD EGR, TD, TD EGR	ABS	04.02-08.06	90/94				TBR	1987 477 263		2827
		2.8 TD EGR 4x4, TD 4x4	ABS	10.02-08.06	90/94					1987 482 003		2715
2.8 TD, TD EGR	ABS	10.02-08.06	90/94				SBR	1987 482 003		2715		
		2.0 i.e., i.e. Bipower CNG, i.e. Bipower CNG 4x4, i.e. Bipower LPG, i.e. Bipower LPG 4x4, i.e. 4x4, JTD	04.02-08.06	62/71-81				0 265 006 673 <sup>3</sup>				
		2.0 i.e., i.e. Bipower CNG, i.e. Bipower LPG, JTD	04.02-08.06	62/71-81				LAB	0 265 006 688 <sup>4</sup>			
							RAB	0 265 006 689 <sup>4</sup>				

		<b>S</b>							
<b>2.3 JTD</b>	04.02-08.06	81					0 265 <b>006 673</b> <sup>3</sup>		
						LAB	0 265 <b>006 688</b> <sup>4</sup>		
						RAB	0 265 <b>006 689</b> <sup>4</sup>		
	01.08-12.11	81					0 265 <b>006 673</b> <sup>3</sup>		
						LAB	0 265 <b>006 688</b> <sup>4</sup>		
						RAB	0 265 <b>006 689</b> <sup>4</sup>		
<b>2.3 JTD EGR</b>	04.02-08.06	81					0 265 <b>006 673</b> <sup>3</sup>		
						LAB	0 265 <b>006 688</b> <sup>4</sup>		
						RAB	0 265 <b>006 689</b> <sup>4</sup>		
	01.08-12.11	81					0 265 <b>006 673</b> <sup>3</sup>		
						LAB	0 265 <b>006 688</b> <sup>4</sup>		
						RAB	0 265 <b>006 689</b> <sup>4</sup>		
<b>2.8 JTD, JTD CGV, JTD EGR, JTD EGR 4x4, JTD 4x4, TD, TD EGR, TD EGR 4x4, TD 4x4</b>	04.02-08.06	90/94/107					0 265 <b>006 673</b> <sup>3</sup>		
<b>2.8 JTD, JTD CGV, JTD EGR, TD, TD EGR</b>	04.02-08.06	90/94/107				LAB	0 265 <b>006 688</b> <sup>4</sup>		
						RAB	0 265 <b>006 689</b> <sup>4</sup>		































**Ducato 15 [250]**

	<b>100 Multijet</b>	06.06-12.14	74				0 204 <b>902 000</b>	← 48	
							0 986 <b>134 052</b>		
							0 204 <b>902 001</b>	→ 48	
							0 986 <b>135 052</b>		
	<b>120 Multijet</b>	06.06-12.14	88				0 204 <b>902 000</b>	← 48	
							0 986 <b>134 052</b>		
							0 204 <b>902 001</b>	→ 48	
							0 986 <b>135 052</b>		
	<b>130 Multijet</b>	06.06-12.14	96				0 204 <b>902 000</b>	← 48	
							0 986 <b>134 052</b>		
							0 204 <b>902 001</b>	→ 48	
							0 986 <b>135 052</b>		
	<b>160 Multijet</b>	06.06-12.14	116				0 204 <b>902 000</b>	← 48	
							0 986 <b>134 052</b>		
							0 204 <b>902 001</b>	→ 48	
							0 986 <b>135 052</b>		

	<b>100 Multijet</b>	06.06-12.14	74			MPR,TW	1 987 <b>482 447</b>	2910	
							1 987 <b>482 450</b>	1908	
						MPR,TW	1 987 <b>482 447</b>	2910	
							1 987 <b>482 450</b>	1908	
						SVN	1 987 <b>482 214</b>	↔ 1485	
						SVN	1 987 <b>482 213</b>	↔ 1390	
	<b>120 Multijet</b>	06.06-12.14	88			MPR,TW	1 987 <b>482 447</b>	2910	
							1 987 <b>482 450</b>	1908	
						MPR,TW	1 987 <b>482 447</b>	2910	
							1 987 <b>482 450</b>	1908	
						SVN	1 987 <b>482 214</b>	↔ 1485	
						SVN	1 987 <b>482 213</b>	↔ 1390	
	<b>130 Multijet</b>	06.06-12.14	96			MPR,TW	1 987 <b>482 447</b>	2910	
							1 987 <b>482 450</b>	1908	
						MPR,TW	1 987 <b>482 447</b>	2910	
							1 987 <b>482 450</b>	1908	
						SVN	1 987 <b>482 214</b>	↔ 1485	
						SVN	1 987 <b>482 213</b>	↔ 1390	
	<b>160 Multijet</b>	06.06-12.14	116			MPR,TW	1 987 <b>482 447</b>	2910	
							1 987 <b>482 450</b>	1908	
						MPR,TW	1 987 <b>482 447</b>	2910	
							1 987 <b>482 450</b>	1908	















		S							
<b>FIAT Ducato 15 [250]</b>									
	160 Multijet	06.06-12.14	116			SVN	1987 482 214	↔ 1485	
						SVN	1987 482 213	↔ 1390	
	100 Multijet	06.06-12.14	74				0 265 007 685 <sup>3</sup>		
						SVN	0 265 007 833 <sup>4</sup>		
						SVN	0 265 007 980 <sup>4</sup>		
	120 Multijet	06.06-12.14	88				0 265 007 685 <sup>3</sup>		
						SVN	0 265 007 833 <sup>4</sup>		
						SVN	0 265 007 980 <sup>4</sup>		
	130 Multijet	06.06-12.14	96				0 265 007 685 <sup>3</sup>		
						SVN	0 265 007 833 <sup>4</sup>		
						SVN	0 265 007 980 <sup>4</sup>		
	160 Multijet	06.06-12.14	116				0 265 007 685 <sup>3</sup>		
						SVN	0 265 007 833 <sup>4</sup>		
						SVN	0 265 007 980 <sup>4</sup>		
<b>Ducato 17 [250]</b>									
	100 Multijet	06.06-12.14	74				0 204 902 000	← 48	
							0 986 134 052		
							0 204 902 001	→ 48	
							0 986 135 052		
	120 Multijet	06.06-12.14	88				0 204 902 000	← 48	
	120 Multijet Maxi						0 986 134 052		
							0 204 902 001	→ 48	
							0 986 135 052		
	130 Multijet	06.06-12.14	96				0 204 902 000	← 48	
	130 Multijet Maxi						0 986 134 052		
							0 204 902 001	→ 48	
							0 986 135 052		
	140 Natural Power	06.06-12.14	100				0 204 902 000	← 48	
							0 986 134 052		
							0 204 902 001	→ 48	
							0 986 135 052		
	150 Multijet	04.10-12.14	107				0 204 902 000	← 48	
							0 986 134 052		
							0 204 902 001	→ 48	
							0 986 135 052		
	160 Multijet	06.06-12.14	116				0 204 902 000	← 48	
	160 Multijet Maxi						0 986 134 052		
							0 204 902 001	→ 48	
							0 986 135 052		
	100 Multijet	06.06-12.14	74			MPR,TW	1987 482 447	2910	
							1987 482 450	1908	
						MPR,TW	1987 482 447	2910	
							1987 482 450	1908	
						SVN	1987 482 214	↔ 1485	
						SVN	1987 482 213	↔ 1390	
	120 Multijet	06.06-12.14	88			SVN	1987 482 214	↔ 1485	
						SVN	1987 482 213	↔ 1390	
	120 Multijet Maxi	06.06-12.14	88			SVN	1987 482 214	↔ 1485	
						SVN	1987 482 213	↔ 1390	
	120 Multijet	06.06-12.14	88			MPR,TW	1987 482 447	2910	
	120 Multijet Maxi						1987 482 450	1908	
						MPR,TW	1987 482 447	2910	
							1987 482 450	1908	
	130 Multijet	06.06-12.14	96			SVN	1987 482 214	↔ 1485	
						SVN	1987 482 213	↔ 1390	

								
<b>130</b> Multijet Maxi	06.06-12.14	96			SVN	1 987 482 214	↔ 1485	
					SVN	1 987 482 213	↔ 1390	
<b>130</b> Multijet	06.06-12.14	96			MPR,TW	1 987 482 447	2910	
<b>130</b> Multijet Maxi						1 987 482 450	1908	
					MPR,TW	1 987 482 447	2910	
						1 987 482 450	1908	
<b>150</b> Multijet	04.10-12.14	107			MPR,TW	1 987 482 447	2910	
						1 987 482 450	1908	
					MPR,TW	1 987 482 447	2910	
						1 987 482 450	1908	
					SVN	1 987 482 214	↔ 1485	
					SVN	1 987 482 213	↔ 1390	
<b>160</b> Multijet	06.06-12.14	116			SVN	1 987 482 214	↔ 1485	
					SVN	1 987 482 213	↔ 1390	
<b>160</b> Multijet Maxi	06.06-12.14	116			SVN	1 987 482 214	↔ 1485	
					SVN	1 987 482 213	↔ 1390	
<b>160</b> Multijet	06.06-12.14	116			MPR,TW	1 987 482 447	2910	
<b>160</b> Multijet Maxi						1 987 482 450	1908	
					MPR,TW	1 987 482 447	2910	
						1 987 482 450	1908	
 <b>100</b> Multijet	06.06-12.14	74				0 265 007 685 <sup>3</sup>		
					SVN	0 265 007 833 <sup>4</sup>		
					SVN	0 265 007 980 <sup>4</sup>		
<b>120</b> Multijet	06.06-12.14	88				0 265 007 685 <sup>3</sup>		
<b>120</b> Multijet Maxi					SVN	0 265 007 833 <sup>4</sup>		
					SVN	0 265 007 980 <sup>4</sup>		
<b>130</b> Multijet	06.06-12.14	96				0 265 007 685 <sup>3</sup>		
<b>130</b> Multijet Maxi					SVN	0 265 007 833 <sup>4</sup>		
					SVN	0 265 007 980 <sup>4</sup>		
<b>140</b> Natural Power	06.06-12.14	100				0 265 007 685 <sup>3</sup>		
					SVN	0 265 007 833 <sup>4</sup>		
					SVN	0 265 007 980 <sup>4</sup>		
<b>150</b> Multijet	04.10-12.14	107				0 265 007 685 <sup>3</sup>		
					SVN	0 265 007 833 <sup>4</sup>		
					SVN	0 265 007 980 <sup>4</sup>		
<b>160</b> Multijet	06.06-12.14	116				0 265 007 685 <sup>3</sup>		
<b>160</b> Multijet Maxi					SVN	0 265 007 833 <sup>4</sup>		
					SVN	0 265 007 980 <sup>4</sup>		
<b>Ducato 18 [230]</b>								
								
 <b>2.0</b> i.e. Bipower CNG	ABO	03.94-03.02	80			0 986 473 163	 ← 48	
						0 986 474 163	 → 48	
	ABS	03.94-03.02	80			0 986 473 984	 ← 45	
						0 986 474 984	 → 45	
<b>2.5</b> D	ABS	03.94-03.98	62		MIH	0 986 474 984	 → 45	
<b>2.5</b> D, D 4x4, TD, TD ECO, TD 4x4	ABO	03.94-03.02	62/80/85		MIH	0 986 473 163	 ← 48	
						0 986 474 163	 → 48	
<b>2.5</b> D 4x4	ABS	03.94-03.98	62			0 986 473 984	 ← 45	
						0 986 474 984	 → 45	
<b>2.5</b> TD	ABS	03.94-03.02	85		MIH	0 986 474 984	 → 45	
<b>2.5</b> TD ECO	ABS	03.94-03.98	80		MIH	0 986 474 984	 → 45	
<b>2.5</b> TD 4x4	ABS	03.94-03.02	85			0 986 473 984	 ← 45	
						0 986 474 984	 → 45	
<b>2.8</b> D	ABS	04.98-03.02	64/90/94		MIH	0 986 474 984	 → 45	
<b>2.8</b> D, D 4x4, TD, TD EGR, TD EGR 4x4, TD 4x4	ABO	10.97-03.02	64/90		MIH	0 986 473 163	 ← 48	
						0 986 474 163	 → 48	
<b>2.8</b> D 4x4	ABS	04.98-03.02	64/90/94			0 986 474 984	 → 45	
<b>2.8</b> D 4x4, JTD EGR 4x4, JTD 4x4, TD EGR 4x4, TD 4x4	ABS	10.97-03.02	64/90/94			0 986 473 984	 ← 45	



		S							
<b>FIAT Ducato 18 [230]</b>									
<b>2.8 JTD EGR 4x4</b>		ABO	08.00-03.02	94			0986 <b>473 162</b>		← 40,4
							0986 <b>474 162</b>		→ 40,4
<b>2.8 JTD EGR 4x4, JTD 4x4</b>		ABS	08.00-03.02	64/90/94			0986 <b>474 984</b>		→ 45
<b>2.8 JTD, JTD EGR</b>		ABS	08.00-03.02	64/90/94		MMH	0986 <b>474 984</b>		→ 45
<b>2.8 JTD, JTD EGR, JTD EGR 4x4, JTD 4x4</b>		ABO	08.00-03.02	94		MMH	0986 <b>473 163</b>		← 48
							0986 <b>474 163</b>		→ 48
<b>2.8 TD EGR 4x4, TD 4x4</b>		ABS	10.97-03.02	64/90/94			0986 <b>474 984</b>		→ 45
<b>2.8 TD, TD EGR</b>		ABS	10.97-03.02	64/90/94		MMH	0986 <b>474 984</b>		→ 45
<b>2.0 i.e. Bipower CNG</b>			03.94-03.02	80			0986 <b>475 803</b>		↔ 28,6
<b>2.5 D, D 4x4, TD, TD ECO, TD 4x4</b>			03.94-03.02	62/80/85			0986 <b>475 803</b>		↔ 28,6
<b>2.8 D, D 4x4, JTD, JTD EGR, TD, TD EGR, TD EGR 4x4, TD 4x4</b>			10.97-03.02	64/90/94			0986 <b>475 803</b>		↔ 28,6
<b>2.0 i.e. Bipower CNG</b>			03.94-11.01	80		LLE	1987 <b>477 114</b>		1059
						RLE	1987 <b>482 046</b>		1137
					Fg.-Nr. 6158429→	FEN	1987 <b>477 262</b>		2806
						FEV	1987 <b>482 006</b>		2827
			03.94-03.02	80	Fg.-Nr. →6158428	FEN	1987 <b>477 113</b>		3025
						FEV	1987 <b>477 115</b>		3045
			12.01-03.02	80		LLE	1987 <b>482 002</b>		1078
						RLE	1987 <b>482 004</b>		1170
						SBR	1987 <b>482 003</b>		2715
						TBR	1987 <b>477 263</b>		2827
<b>2.5 D</b>			03.94-03.98	62	Fg.-Nr. →6158428	FEN	1987 <b>477 113</b>		3025
						FEV	1987 <b>477 115</b>		3045
<b>2.5 D</b>			03.94-03.98	62		LLE	1987 <b>477 114</b>		1059
<b>2.5 D 4x4</b>						RLE	1987 <b>482 046</b>		1137
<b>2.5 D 4x4</b>			03.94-03.98	62		FEV	1987 <b>477 115</b>		3045
						FMR	1987 <b>477 113</b>		3025
<b>2.5 TD ECO</b>			03.94-03.98	80		LLE	1987 <b>477 114</b>		1059
						RLE	1987 <b>482 046</b>		1137
					Fg.-Nr. →6158428	FEN	1987 <b>477 113</b>		3025
						FEV	1987 <b>477 115</b>		3045
					Fg.-Nr. 6158429→	FEN	1987 <b>477 262</b>		2806
						FEV	1987 <b>482 006</b>		2827
<b>2.5 TD</b>			03.94-11.01	85		LLE	1987 <b>477 114</b>		1059
<b>2.5 TD 4x4</b>						RLE	1987 <b>482 046</b>		1137
					Fg.-Nr. 6158429→	FEN	1987 <b>477 262</b>		2806
						FEV	1987 <b>482 006</b>		2827
			03.94-03.02	85	Fg.-Nr. →6158428	FEN	1987 <b>477 113</b>		3025
						FEV	1987 <b>477 115</b>		3045
			12.01-03.02	85		LLE	1987 <b>482 002</b>		1078
						RLE	1987 <b>482 004</b>		1170
						SBR	1987 <b>482 003</b>		2715
						TBR	1987 <b>477 263</b>		2827
<b>2.8 D</b>			04.98-11.01	64		LLE	1987 <b>477 114</b>		1059
<b>2.8 D 4x4</b>						RLE	1987 <b>482 046</b>		1137
					Fg.-Nr. 6158429→	FEN	1987 <b>477 262</b>		2806
						FEV	1987 <b>482 006</b>		2827
			04.98-03.02	64	Fg.-Nr. →6158428	FEN	1987 <b>477 113</b>		3025
						FEV	1987 <b>477 115</b>		3045
			12.01-03.02	64		LLE	1987 <b>482 002</b>		1078
						RLE	1987 <b>482 004</b>		1170
						SBR	1987 <b>482 003</b>		2715
						TBR	1987 <b>477 263</b>		2827
<b>2.8 JTD EGR 4x4</b>			08.00-11.01	90/94		FEV	1987 <b>477 115</b>		3045
<b>2.8 JTD 4x4</b>						FMR	1987 <b>477 113</b>		3025
<b>2.8 JTD</b>			08.00-03.02	90/94	Fg.-Nr. →6158428	FEN	1987 <b>477 113</b>		3025
<b>2.8 JTD EGR</b>						FEV	1987 <b>477 115</b>		3045

		S								
2.8 JTD, JTD EGR, JTD EGR 4x4, JTD 4x4, TD, TD EGR, TD EGR 4x4, TD 4x4	10.97-11.01	90/94				LLE	1 987 477 114	1059		
						RLE	1 987 482 046	1137		
	12.01-03.02	90/94				LLE	1 987 482 002	1078		
						RLE	1 987 482 004	1170		
						SBR	1 987 482 003	2715		
2.8 JTD, JTD EGR, TD, TD EGR	10.97-11.01	90/94	Fg.-Nr. 6158429→			TBR	1 987 477 263	2827		
						FEN	1 987 477 262	2806		
2.8 TD EGR 4x4	10.97-11.01	90/94				FEV	1 987 482 006	2827		
						FEV	1 987 477 115	3045		
2.8 TD 4x4						FMR	1 987 477 113	3025		
2.8 TD	10.97-03.02	90/94	Fg.-Nr. →6158428			FEN	1 987 477 113	3025		
2.8 TD EGR						FEV	1 987 477 115	3045		
 2.0 i.e. Bipower CNG	03.94-03.02	80	Fg.-Nr. 5946343→			BSY	0 265 006 673 <sup>3</sup>			
	08.97-11.01	80	Fg.-Nr. 5445359→			LAB	BO 0 265 006 405 <sup>4</sup>			
						RAB	BO 0 265 006 406 <sup>4</sup>			
	08.97-03.02	80	Fg.-Nr. 5445359→5946342			BO	0 265 006 427 <sup>3</sup>			
	12.01-03.02	80				LAB	0 265 006 688 <sup>4</sup>			
						RAB	0 265 006 689 <sup>4</sup>			
	2.5 D	08.97-03.98	62	Fg.-Nr. 5445359→			BO	0 265 006 427 <sup>3</sup>		
	2.5 D	08.97-03.98	62	Fg.-Nr. 5445359→			LAB	BO 0 265 006 405 <sup>4</sup>		
	2.5 D 4x4						RAB	BO 0 265 006 406 <sup>4</sup>		
	2.5 D 4x4	08.97-03.98	62	Fg.-Nr. 5445359→5946342			BO	0 265 006 427 <sup>3</sup>		
	2.5 TD	08.97-03.02	85	Fg.-Nr. 5445359→			BO	0 265 006 427 <sup>3</sup>		
	2.5 TD ECO	08.97-03.98	80	Fg.-Nr. 5445359→			BO	0 265 006 427 <sup>3</sup>		
						LAB	BO 0 265 006 405 <sup>4</sup>			
						RAB	BO 0 265 006 406 <sup>4</sup>			
2.5 TD	08.97-11.01	85	Fg.-Nr. 5445359→			LAB	BO 0 265 006 405 <sup>4</sup>			
2.5 TD 4x4						RAB	BO 0 265 006 406 <sup>4</sup>			
	12.01-03.02	85				LAB	0 265 006 688 <sup>4</sup>			
						RAB	0 265 006 689 <sup>4</sup>			
2.5 TD 4x4	08.97-03.02	85	Fg.-Nr. 5445359→5946342			BO	0 265 006 427 <sup>3</sup>			
2.8 D	10.97-11.01	64/90	Fg.-Nr. 5445359→			LAB	BO 0 265 006 405 <sup>4</sup>			
2.8 D 4x4						RAB	BO 0 265 006 406 <sup>4</sup>			
2.8 TD	10.97-03.02	64/90	Fg.-Nr. 5445359→5946342			BO	0 265 006 427 <sup>3</sup>			
2.8 TD EGR			Fg.-Nr. 5946343→			BSY	0 265 006 673 <sup>3</sup>			
2.8 TD EGR 4x4	12.01-03.02	64/90				LAB	0 265 006 688 <sup>4</sup>			
2.8 TD 4x4						RAB	0 265 006 689 <sup>4</sup>			
2.8 JTD EGR 4x4, JTD 4x4	08.00-03.02	94	Fg.-Nr. 5445359→5946342			BO	0 265 006 427 <sup>3</sup>			
2.8 JTD	08.00-11.01	94	Fg.-Nr. 5445359→			LAB	BO 0 265 006 405 <sup>4</sup>			
2.8 JTD EGR						RAB	BO 0 265 006 406 <sup>4</sup>			
2.8 JTD EGR 4x4	08.00-03.02	94	Fg.-Nr. 5946343→			BSY	0 265 006 673 <sup>3</sup>			
2.8 JTD 4x4	12.01-03.02	94				LAB	0 265 006 688 <sup>4</sup>			
						RAB	0 265 006 689 <sup>4</sup>			
<b>Ducato 18 [244]</b>										
										
 2.0 i.e., i.e. Bipower CNG, i.e. Bipower LPG	04.02-08.06	71-81				LOC	0 986 475 906	↔ 26,99		
	2.3 JTD	04.02-08.06	81			LOC	0 986 475 906	↔ 26,99		
	2.8 JTD, JTD CGV, JTD EGR, TD	04.02-08.06	90/94/107			LOC	0 986 475 906	↔ 26,99		
										
 2.0 i.e.	04.02-08.06	81				SBR	1 987 482 003	2715		
						TBR	1 987 477 263	2827		
	2.0 i.e. Bipower CNG	04.02-08.06	71-81			SBR	1 987 482 003	2715		
	2.0 i.e. Bipower LPG					TBR	1 987 477 263	2827		
	2.0 i.e. 4x4	04.02-08.06	81					1 987 482 003	2715	
	2.3 JTD	04.02-08.06	81			SBR	1 987 482 003	2715		
						TBR	1 987 477 263	2827		

		S							
<b>FIAT Ducato 18 [244]</b>									
	2.3 JTD	01.08-12.11	81				1987 482 002	1078	
							1987 482 003	2715	
	2.3 JTD EGR	01.08-12.11	81				1987 482 002	1078	
							1987 482 003	2715	
	2.8 JTD CGV	04.04-08.06	107			SBR	1987 482 003	2715	
						TBR	1987 477 263	2827	
	2.8 JTD EGR 4x4, JTD 4x4	04.02-08.06	90/94				1987 482 003	2715	
	2.8 JTD, JTD EGR	04.02-08.06	90/94			SBR	1987 482 003	2715	
2.8 JTD, JTD EGR, TD	04.02-08.06	90/94			TBR	1987 477 263	2827		
2.8 TD	10.02-08.06	90/94			SBR	1987 482 003	2715		
2.8 TD 4x4	10.02-08.06	90/94				1987 482 003	2715		
	2.0 i.e., i.e. Bipower CNG, i.e. Bipower CNG 4x4, i.e. Bipower LPG, i.e. Bipower LPG 4x4, i.e. 4x4	04.02-08.06	71-81				0 265 006 673 <sup>3</sup>		
	2.0 i.e., i.e. Bipower CNG, i.e. Bipower LPG	04.02-08.06	71-81			LAB	0 265 006 688 <sup>4</sup>		
						RAB	0 265 006 689 <sup>4</sup>		
	2.3 JTD	04.02-08.06	81				0 265 006 673 <sup>3</sup>		
						LAB	0 265 006 688 <sup>4</sup>		
						RAB	0 265 006 689 <sup>4</sup>		
		01.08-12.11	81				0 265 006 673 <sup>3</sup>		
						LAB	0 265 006 688 <sup>4</sup>		
						RAB	0 265 006 689 <sup>4</sup>		
	2.3 JTD EGR	01.08-12.11	81				0 265 006 673 <sup>3</sup>		
						LAB	0 265 006 688 <sup>4</sup>		
						RAB	0 265 006 689 <sup>4</sup>		
2.8 JTD, JTD CGV, JTD EGR, JTD EGR 4x4, JTD 4x4, TD, TD 4x4	04.02-08.06	90/94/107				0 265 006 673 <sup>3</sup>			
2.8 JTD, JTD CGV, JTD EGR, TD	04.02-08.06	90/94/107			LAB	0 265 006 688 <sup>4</sup>			
					RAB	0 265 006 689 <sup>4</sup>			
<b>Ducato 18 [290]</b>									
	2.5 D Maxi	07.90-02.94	55			MH	0 986 473 776	← 38	
							0 986 473 777	→ 38	
	2.0 Maxi	07.90-02.94	63				0 986 475 612	↔ 27	
	2.5 D Maxi, TD Maxi	07.90-02.94	55/70				0 986 475 612	↔ 27	
	2.0 Maxi	07.90-02.94	63				1987 477 515	2566	
						FKR,LLE	1987 477 417	1608	
						FKR,RLE	1987 477 420	1888	
						FLR,LLE	1987 477 419	2338	
						FLR,RLE	1987 477 421	2620	
	2.5 D Maxi	07.90-02.94	55/70				1987 477 515	2566	
	2.5 TD Maxi					FKR,LLE	1987 477 417	1608	
						FKR,RLE	1987 477 420	1888	
					FLR,LLE	1987 477 419	2338		
					FLR,RLE	1987 477 421	2620		
<b>Ducato 20 [250]</b>									
	120 Multijet Maxi	06.06-12.14	88				0 204 902 000	← 48	
							0 986 134 052		
							0 204 902 001	→ 48	
							0 986 135 052		

		S							
<b>130</b> Multijet Maxi	06.06-12.14	96					0 204 902 000	← 48	
							0 986 134 052		
							0 204 902 001	→ 48	
							0 986 135 052		
<b>140</b> Natural Power	09.09-12.14	100					0 204 902 000	← 48	
							0 986 134 052		
							0 204 902 001	→ 48	
							0 986 135 052		
<b>150</b> Multijet	09.10-12.14	107					0 204 902 000	← 48	
							0 986 134 052		
							0 204 902 001	→ 48	
							0 986 135 052		
<b>160</b> Multijet	06.06-12.14	115/116					0 204 902 000	← 48	
<b>160</b> Multijet Maxi							0 986 134 052		
							0 204 902 001	→ 48	
							0 986 135 052		
<b>120</b> Multijet Maxi	06.06-12.14	88				MPR,TW	1 987 482 447	2910	
							1 987 482 450	1908	
						MPR,TW	1 987 482 447	2910	
							1 987 482 450	1908	
						SVN	1 987 482 214	↔ 1485	
						SVN	1 987 482 213	↔ 1390	
<b>130</b> Multijet Maxi	06.06-12.14	96				MPR,TW	1 987 482 447	2910	
							1 987 482 450	1908	
						MPR,TW	1 987 482 447	2910	
							1 987 482 450	1908	
						SVN	1 987 482 214	↔ 1485	
						SVN	1 987 482 213	↔ 1390	
<b>150</b> Multijet	09.10-12.14	107				MPR,TW	1 987 482 447	2910	
							1 987 482 450	1908	
						MPR,TW	1 987 482 447	2910	
							1 987 482 450	1908	
						SVN	1 987 482 214	↔ 1485	
						SVN	1 987 482 213	↔ 1390	
<b>160</b> Multijet	09.10-12.14	115/116				SVN	1 987 482 214	↔ 1485	
						SVN	1 987 482 213	↔ 1390	
<b>160</b> Multijet Maxi	06.06-12.14	115/116				SVN	1 987 482 214	↔ 1485	
						SVN	1 987 482 213	↔ 1390	
<b>160</b> Multijet	06.06-12.14	115/116				MPR,TW	1 987 482 447	2910	
<b>160</b> Multijet Maxi							1 987 482 450	1908	
						MPR,TW	1 987 482 447	2910	
							1 987 482 450	1908	
<b>120</b> Multijet Maxi	06.06-12.14	88					0 265 007 685 <sup>3</sup>		
						SVN	0 265 007 833 <sup>4</sup>		
						SVN	0 265 007 980 <sup>4</sup>		
<b>130</b> Multijet Maxi	06.06-12.14	96					0 265 007 685 <sup>3</sup>		
						SVN	0 265 007 833 <sup>4</sup>		
						SVN	0 265 007 980 <sup>4</sup>		
<b>140</b> Natural Power	09.09-12.14	100					0 265 007 685 <sup>3</sup>		
						SVN	0 265 007 833 <sup>4</sup>		
						SVN	0 265 007 980 <sup>4</sup>		
<b>150</b> Multijet	09.10-12.14	107					0 265 007 685 <sup>3</sup>		
						SVN	0 265 007 833 <sup>4</sup>		
						SVN	0 265 007 980 <sup>4</sup>		
<b>160</b> Multijet	06.06-12.14	115/116					0 265 007 685 <sup>3</sup>		
<b>160</b> Multijet Maxi						SVN	0 265 007 833 <sup>4</sup>		
						SVN	0 265 007 980 <sup>4</sup>		





		S							
◀ FIAT									
<b>Ducato 110 [250]</b>									
	2.3 Multijet	10.11-12.14	83				0 204 902 000	← 48	
							0 986 134 052		
							0 204 902 001	→ 48	
							0 986 135 052		
	2.3 Multijet	10.11-12.14	83		SVN	1987 482 214	↔ 1485		
					SVN	1987 482 213	↔ 1390		
					TW	1987 482 447	2910		
						1987 482 450	1908		
	2.3 Multijet	10.11-12.14	83			0 265 007 685 <sup>3</sup>			
					NAD,SVN	0 265 007 833 <sup>4</sup>			
					NAD,SVN	0 265 007 980 <sup>4</sup>			
<b>Ducato 115 [250]</b>									
	2.0 Multijet	06.11-12.14	85			0 204 902 000	← 48		
						0 986 134 052			
						0 204 902 001	→ 48		
						0 986 135 052			
	2.0 Multijet	06.11-12.14	85		SVN	1987 482 214	↔ 1485		
					SVN	1987 482 213	↔ 1390		
					TW	1987 482 447	2910		
						1987 482 450	1908		
	2.0 Multijet	06.11-12.14	85			0 265 007 685 <sup>3</sup>			
					NAD,SVN	0 265 007 833 <sup>4</sup>			
					NAD,SVN	0 265 007 980 <sup>4</sup>			
<b>Ducato 130 [250]</b>									
	2.3 Multijet	06.11-12.14	96			0 204 902 000	← 48		
						0 986 134 052			
						0 204 902 001	→ 48		
						0 986 135 052			
	2.3 Multijet	06.11-12.14	96		SVN	1987 482 214	↔ 1485		
					SVN	1987 482 213	↔ 1390		
					TW	1987 482 447	2910		
						1987 482 450	1908		
	2.3 Multijet	06.11-12.14	96			0 265 007 685 <sup>3</sup>			
					NAD,SVN	0 265 007 833 <sup>4</sup>			
					NAD,SVN	0 265 007 980 <sup>4</sup>			
<b>Ducato 140 [290]</b>									
	3.0 Natual power	10.14→	100			0 265 007 685 <sup>3</sup>			
					NAD,SVN	0 265 007 833 <sup>4</sup>			
					NAD,SVN	0 265 007 980 <sup>4</sup>			































		S							
<b>Ducato 150 [250]</b>									
	2.3 Multijet	06.11-12.14	109				0 204 902 000	← 48	
							0 986 134 052		
							0 204 902 001	→ 48	
							0 986 135 052		
	2.3 Multijet	06.11-12.14	109			SVN	1 987 482 214	↔ 1485	
						SVN	1 987 482 213	↔ 1390	
						TW	1 987 482 447	2910	
							1 987 482 450	1908	
		2.3 Multijet	06.11-12.14	109			0 265 007 685 <sup>3</sup>		
						NAD,SVN	0 265 007 833 <sup>4</sup>		
						NAD,SVN	0 265 007 980 <sup>4</sup>		
<b>Ducato 180 [250..]</b>									
	3.0 Multijet	06.11-12.14	130				0 204 902 000	← 48	
							0 986 134 052		
							0 204 902 001	→ 48	
							0 986 135 052		
	3.0 Multijet	06.11-12.14	130			SVN	1 987 482 214	↔ 1485	
						SVN	1 987 482 213	↔ 1390	
						TW	1 987 482 447	2910	
							1 987 482 450	1908	
		3.0 Multijet	06.11-12.14	130			0 265 007 685 <sup>3</sup>		
						NAD,SVN	0 265 007 833 <sup>4</sup>		
						NAD,SVN	0 265 007 980 <sup>4</sup>		
<b>Ducato [290]</b>									
	110 Multijet	05.14→	83			SVN	1 987 482 213	↔ 1390	
						TW	1 987 482 447	2910	
							1 987 482 450	1908	
	115 Multijet	05.14→	85			SVN	1 987 482 213	↔ 1390	
						TW	1 987 482 447	2910	
							1 987 482 450	1908	
	130 Multijet	05.14→	96			SVN	1 987 482 213	↔ 1390	
						TW	1 987 482 447	2910	
							1 987 482 450	1908	
	150 Multijet	05.14→	109			SVN	1 987 482 213	↔ 1390	
						TW	1 987 482 447	2910	
							1 987 482 450	1908	
	180 Multijet	05.14→	130			SVN	1 987 482 213	↔ 1390	
						TW	1 987 482 447	2910	
							1 987 482 450	1908	
		110 Multijet	05.14→	83			0 265 007 685 <sup>3</sup>		
						NAD,SVN	0 265 007 833 <sup>4</sup>		
						NAD,SVN	0 265 007 980 <sup>4</sup>		
	115 Multijet	05.14→	85				0 265 007 685 <sup>3</sup>		
						NAD,SVN	0 265 007 833 <sup>4</sup>		
						NAD,SVN	0 265 007 980 <sup>4</sup>		





































		S							
<b>FIAT Ducato [290]</b>									
	<b>130</b> Multijet	05.14→	96				0 265 <b>007 685</b> <sup>3</sup>		
						NAD,SVN	0 265 <b>007 833</b> <sup>4</sup>		
						NAD,SVN	0 265 <b>007 980</b> <sup>4</sup>		
	<b>150</b> Multijet	05.14→	109				0 265 <b>007 685</b> <sup>3</sup>		
						NAD,SVN	0 265 <b>007 833</b> <sup>4</sup>		
						NAD,SVN	0 265 <b>007 980</b> <sup>4</sup>		
	<b>180</b> Multijet	05.14→	130				0 265 <b>007 685</b> <sup>3</sup>		
						NAD,SVN	0 265 <b>007 833</b> <sup>4</sup>		
						NAD,SVN	0 265 <b>007 980</b> <sup>4</sup>		
<b>Fiorino Furgao</b>									
	<b>1.0</b>	01.94-07.95	35				0 986 <b>134 064</b>	← 54	
							0 986 <b>135 064</b>	→ 54	
	<b>1.3</b> MPI	01.03-12.13	49				0 986 <b>134 064</b>	← 54	
	<b>1.3</b> MPI 8V						0 986 <b>135 064</b>	→ 54	
	<b>1.7</b> D	01.04-12.08	52				0 986 <b>134 064</b>	← 54	
							0 986 <b>135 064</b>	→ 54	
	<b>1.0</b>	01.94-07.95	35				0 986 <b>AB8 445</b>	↔	
	<b>1.3</b> MPI 8V	01.04-12.13	49				0 986 <b>AB8 445</b>	↔	
	<b>1.7</b> D	01.04-12.08	52				0 986 <b>AB8 445</b>	↔	
	<b>1.0</b>	01.94-07.95	35				1 987 <b>477 989</b>	3105	
	<b>1.3</b> MPI, MPI 8V	01.03-12.13	49				1 987 <b>477 989</b>	3105	
	<b>1.7</b> D	01.04-12.08	52				1 987 <b>477 989</b>	3105	
<b>Fiorino [146..]</b>									
	<b>1.3</b>	09.93-12.01	49			MIH	0 986 <b>134 064</b>	← 54	
							0 986 <b>135 064</b>	→ 54	
	<b>1.4</b> i.e.	09.93-12.01	49/52			MIH	0 986 <b>134 064</b>	← 54	
							0 986 <b>135 064</b>	→ 54	
	<b>1.6</b> i.e.	09.93-12.01	55			MIH	0 986 <b>134 064</b>	← 54	
							0 986 <b>135 064</b>	→ 54	
	<b>1.7</b> D	09.93-12.01	43/46			MIH	0 986 <b>134 064</b>	← 54	
	<b>1.7</b> TDS						0 986 <b>135 064</b>	→ 54	
	<b>1.3</b>	09.93-12.01	49			BSY	0 986 <b>475 867</b>	↔ 20,64	
	<b>1.4</b> i.e.	09.93-12.01	49/52			BSY	0 986 <b>475 867</b>	↔ 20,64	
	<b>1.6</b> i.e.	09.93-12.01	55			BSY	0 986 <b>475 867</b>	↔ 20,64	
	<b>1.7</b> D, TDS	09.93-12.01	43/46			BSY	0 986 <b>475 867</b>	↔ 20,64	
	<b>1.3</b>	09.93-12.01	49				1 987 <b>477 989</b>	3105	
	<b>1.4</b> i.e.	09.93-12.01	49/52				1 987 <b>477 989</b>	3105	
	<b>1.6</b> i.e.	09.93-12.01	55				1 987 <b>477 989</b>	3105	
	<b>1.7</b> D, TDS	09.93-12.01	43/46				1 987 <b>477 989</b>	3105	
	<b>1.3</b>	09.93-12.01	49			LAB	0 265 <b>006 538</b> <sup>3</sup>		
							0 265 <b>006 539</b> <sup>4</sup>		
						RAB	0 265 <b>006 537</b> <sup>3</sup>		
							0 265 <b>006 540</b> <sup>4</sup>		

F

		S							
1.4 i.e.		09.93-12.01	49/52				LAB 0 265 006 538 <sup>3</sup> 0 265 006 539 <sup>4</sup>		
							RAB 0 265 006 537 <sup>3</sup> 0 265 006 540 <sup>4</sup>		
1.6 i.e.		09.93-12.01	55				LAB 0 265 006 538 <sup>3</sup> 0 265 006 539 <sup>4</sup>		
							RAB 0 265 006 537 <sup>3</sup> 0 265 006 540 <sup>4</sup>		
1.7 D 1.7 TDS		09.93-12.01	43/46				LAB 0 265 006 538 <sup>3</sup> 0 265 006 539 <sup>4</sup>		
							RAB 0 265 006 537 <sup>3</sup> 0 265 006 540 <sup>4</sup>		
<b>Fiorino [225..]</b>									
									
 1.3 Multijet		12.07→	55				0 204 902 119 0 986 473 487	← 54 	
		09.10→	70				0 986 474 487 0 204 004 566 0 986 134 077	 → 54 ← 54 	
		03.15→	59				0 204 902 119 0 986 473 487	← 54 	
							0 986 474 487	 → 54	
1.4 1.4 Natural Power		12.07→	51-57				0 204 902 032 0 986 473 487	← 54 	
							0 986 474 487	 → 54	
									
 1.3 Multijet		12.07→	55/59/70				0 986 475 936	↔ 20,64	
1.4, Natural Power		12.07→	51-57				0 986 475 936	↔ 20,64	
									
 1.3 Multijet		12.07→	55/59/70				1 987 482 207 1 987 482 208	→ 1710 ← 1677	
1.4		12.07→	54-57				1 987 482 205 1 987 482 206	→ 1695 ← 1662	
1.4 Natural Power		10.09→	51-57				1 987 482 207 1 987 482 208	→ 1710 ← 1677	
<b>Freemont [JC]</b>									
									
 2.0 JTD		06.11→	100-103/				1 987 482 403	→ 2302	
2.0 JTD 4x4			120-125				1 987 482 404	← 1177	
2.4		02.13→	125				1 987 482 403 1 987 482 404	→ 2302 ← 1177	
3.6 4x4		08.11→	206				1 987 482 403 1 987 482 404	→ 2302 ← 1177	
<b>Grande Punto [199]</b>									
									
 1.3 Multijet		07.08-12.11	51				0 204 902 119 0 986 473 487	← 54 	
		04.10-12.11	62				0 986 474 487 0 204 004 566 0 986 134 077	 → 54 ← 54 	



		S							
◀ FIAT Grande Punto [199]									
	1.3 Multijet	07.08-12.11	51/62				0986 475 936	↔ 20,64	
	1.3 Multijet	07.08-12.11	51/62				1987 477 975	→ 1689	
							1987 477 976	← 1674	
	1.3 Multijet	07.08-12.11	51/62				0265 004 136 <sup>3</sup>		
							0265 007 896 <sup>4</sup>		
Idea [350]									
	1.2 16V	01.04-12.12	59/70				0204 001 965	← 54	0204 104 279 <sup>7</sup>
							0204 001 966	→ 54	0204 104 279 <sup>7</sup>
	1.3 Miltijet	11.04-12.12	66/70				0204 004 338	← 54	0204 104 279 <sup>7</sup>
	1.3 Multijet						0986 134 339		
							0204 004 339	→ 54	0204 104 279 <sup>7</sup>
							0986 135 339		
	1.3 Multijet	01.04-11.10	51				0204 001 965	← 54	0204 104 279 <sup>7</sup>
							0204 001 966	→ 54	0204 104 279 <sup>7</sup>
	1.4 16V, 8V, 8V LPG	01.04-12.12	57/66				0204 001 965	← 54	0204 104 279 <sup>7</sup>
							0204 001 966	→ 54	0204 104 279 <sup>7</sup>
	1.6 Multijet	04.08-12.12	88				0204 004 338	← 54	0204 104 279 <sup>7</sup>
							0986 134 339		
							0204 004 339	→ 54	0204 104 279 <sup>7</sup>
							0986 135 339		
	1.9 Multijet	01.04-12.12	74				0204 004 338	← 54	0204 104 279 <sup>7</sup>
							0986 134 339		
							0204 004 339	→ 54	0204 104 279 <sup>7</sup>
							0986 135 339		
	1.2 16V	01.04-07.05	59/70				0986 475 937	↔ 22,2	
		08.05-12.12	59/70				0986 475 940	↔ 19,05	
	1.3 Miltijet	11.04-07.05	66		LOC		0986 475 816	↔ 20,64	
		08.05-11.10	66				0986 475 936	↔ 20,64	
	1.3 Multijet	01.04-07.05	51				0986 475 937	↔ 22,2	
		08.05-11.10	51				0986 475 940	↔ 19,05	
		05.08-12.12	70				0986 475 936	↔ 20,64	
	1.4 16V, 8V	01.04-07.05	57/66				0986 475 937	↔ 22,2	
	1.4 16V, 8V, 8V LPG	08.05-12.12	57/66				0986 475 940	↔ 19,05	
	1.9 Multijet	01.04-07.05	74		LOC		0986 475 816	↔ 20,64	
		08.05-12.12	74				0986 475 936	↔ 20,64	
	1.2 16V	01.04-12.12	59/70			Ricam.Nr →166650	1987 477 928	↔ 1535	
						Ricam.Nr 166651→	1987 477 925	↔ 1557	
	1.3 Miltijet	11.04-11.10	66/70				1987 477 925	↔ 1557	
	1.3 Multijet	01.04-11.10	51			Ricam.Nr →166650	1987 477 928	↔ 1535	
						Ricam.Nr 166651→	1987 477 925	↔ 1557	
		05.08-12.12	66/70				1987 477 925	↔ 1557	
	1.4 16V	01.04-12.12	57/66			Ricam.Nr →166650	1987 477 928	↔ 1535	
						Ricam.Nr 166651→	1987 477 925	↔ 1557	
	1.4 8V	11.04-12.12	57/66			Ricam.Nr →166650	1987 477 928	↔ 1535	
						Ricam.Nr 166651→	1987 477 925	↔ 1557	
	1.4 8V LPG	09.08-12.12	57/66			Ricam.Nr →166650	1987 477 928	↔ 1535	
						Ricam.Nr 166651→	1987 477 925	↔ 1557	

		S							
	1.6 Multijet	04.08-12.12	88				1 987 482 238	↔ 1618	
	1.9 Multijet	01.04-12.12	74				1 987 477 925	↔ 1557	
	1.2 16V	01.04-03.07	59/70				0 265 007 503 <sup>4</sup>		
							0 265 007 830 <sup>3</sup>		
	1.3 Miltijet	01.04-03.07	51/66				0 265 007 503 <sup>4</sup>		
	1.3 Multijet						0 265 007 830 <sup>3</sup>		
	1.4 16V	01.04-03.07	57/66				0 265 007 503 <sup>4</sup>		
	1.4 8V						0 265 007 830 <sup>3</sup>		
	1.9 Multijet	01.04-03.07	74				0 265 007 503 <sup>4</sup>		
							0 265 007 830 <sup>3</sup>		
<b>Linea [110]</b>									
									
	1.3 JTD	12.08→	63				0 204 004 564	← 54	
							0 986 473 487		
							0 204 004 565	→ 54	
							0 986 474 487		
	1.4 16V	11.08→	66				0 204 004 564	← 54	
							0 986 473 487		
							0 204 004 565	→ 54	
							0 986 474 487		
									
	1.3 JTD	12.08→	63				0 986 475 936	↔ 20,64	
	1.4 16V	11.08→	66				0 986 475 936	↔ 20,64	
<b>Linea [323]</b>									
									
	1.3 Multijet	03.07→	66				0 204 902 032	← 54	
							0 986 473 487		
							0 204 902 033	→ 54	
							0 986 474 487		
		09.09→	70	Fg.-Nr. →3104687			0 204 902 032	← 54	
							0 986 473 487		
							0 204 902 033	→ 54	
							0 986 474 487		
				Fg.-Nr. 3104688→			0 204 902 032	← 54	
							0 986 473 487		
							0 204 902 033	→ 54	
							0 986 474 487		
	1.4	03.07→	57	Fg.-Nr. →3104687			0 204 902 032	← 54	
							0 986 473 487		
							0 204 902 033	→ 54	
							0 986 474 487		
				Fg.-Nr. 3104688→			0 204 902 032	← 54	
							0 986 473 487		
							0 204 902 033	→ 54	
							0 986 474 487		
	1.4 Turbo	03.07→	88				0 204 004 566	← 54	
							0 986 134 077		
							0 204 004 567	→ 54	
							0 986 135 077		
	1.6	07.08→	80				0 204 004 566	← 54	
							0 986 134 077		
	1.6 Multijet	10.08→	77		EU4		0 204 004 566	← 54	
							0 986 134 077		
							0 204 004 567	→ 54	
							0 986 135 077		



		S							
	◀ FIAT Linea [323]								
	1.6 Multijet	10.08→	77			EU5	0 204 004 566 0 986 134 077	← 54	
	1.3 Multijet	03.07→	66/70				0 986 475 936	↔ 20,64	
	1.4	03.07→	57				0 986 475 936	↔ 20,64	
	1.4 Turbo	03.07→	88				0 986 473 251	← 38	
							0 986 474 251	→ 38	
	1.6	07.08→	80				0 986 473 251	← 38	
							0 986 474 251	→ 38	
	1.6 Multijet	10.08→	77			EU4	0 986 473 251	← 38	
							0 986 474 251	→ 38	
	1.3 Multijet	03.07→	66/70			LLE	1 987 482 203	→ 1725	
							1 987 482 204	← 1712	
	1.4	03.07→	57			LLE	1 987 482 203	→ 1725	
							1 987 482 204	← 1712	
	1.4 Turbo	03.07-06.11	88				1 987 482 289	→ 1528	
							1 987 482 290	← 1520	
		07.11→	88			GS	1 987 482 289	→ 1528	
							1 987 482 290	← 1520	
	1.6	07.08-06.11	77/80				1 987 482 289	→ 1528	
	1.6 Multijet						1 987 482 290	← 1520	
		07.11→	77/80			GS	1 987 482 289	→ 1528	
							1 987 482 290	← 1520	
	<b>Marea</b>								
	1.8 MPI 16V	08.99-12.07	97				0 204 102 570	← 54	0 204 104 208 <sup>8</sup>
							0 204 102 571	→ 54	0 204 104 208 <sup>8</sup>
	2.0 MPI 20V	05.98-10.99	104				0 204 102 572	← 54	
							0 204 102 573	→ 54	
	1.8 MPI 16V	08.99-12.07	97				0 986 475 871	↔ 20,64	
	1.8 MPI 16V	08.99-12.07	97				1 987 477 825	→ 1404	
							1 987 482 180	← 1459	
	2.0 MPI 20V	05.98-09.00	104				1 987 477 385	385	
							1 987 477 824	← 1502	
							1 987 482 179	→ 1454	
	1.8 MPI 16V	08.99-12.07	97			HLI	0 265 007 032 <sup>4</sup>		
						HRE	0 265 007 033 <sup>4</sup>		
						VLI	0 265 007 034 <sup>3</sup>		
						VRE	0 265 007 035 <sup>3</sup>		
	2.0 MPI 20V	10.98-09.00	104			HLI	0 265 007 032 <sup>4</sup>		
						HRE	0 265 007 033 <sup>4</sup>		
						VLI	0 265 007 034 <sup>3</sup>		
						VRE	0 265 007 035 <sup>3</sup>		

F

		S							
<b>Marea Weekend</b>									
	1.8 MPI 16V	08.99-12.07	97				0 204 102 570	← 54	0 204 104 208 <sup>B</sup>
							0 204 102 571	→ 54	0 204 104 208 <sup>B</sup>
	1.8 MPI 16V	08.99-12.07	97				0 986 475 871	↔ 20,64	
	1.8 MPI 16V	08.99-12.07	97				1 987 477 825	→ 1404	
							1 987 482 180	← 1459	
	1.8 MPI 16V	08.99-12.07	97			HLI	0 265 007 032 <sup>4</sup>		
						HRE	0 265 007 033 <sup>4</sup>		
						VLI	0 265 007 034 <sup>3</sup>		
						VRE	0 265 007 035 <sup>3</sup>		
<b>Marea [185]</b>									
	1.2 i16V	03.99-09.02	60			KOB,MIH	0 204 102 570	← 54	0 204 104 208 <sup>B</sup>
							0 204 102 571	→ 54	0 204 104 208 <sup>B</sup>
						KOB,MIH	0 204 902 103	← 54	0 204 104 208 <sup>B</sup>
							0 204 103 502		
							0 204 902 104	→ 54	0 204 104 208 <sup>B</sup>
							0 204 103 503		
						LIM,MIH	0 204 102 569	→ 54	
							0 986 135 317		
							0 986 134 317	← 54	
						LIM,MIH	0 204 902 101	←	0 204 104 208 <sup>B</sup>
							0 204 103 499		
							0 986 134 317		
							0 204 902 102	→	0 204 104 208 <sup>B</sup>
							0 204 103 500		
							0 986 135 317		
	1.4 i12V	10.96-02.99	59			KOB,MIH	0 204 102 570	← 54	0 204 104 208 <sup>B</sup>
							0 204 102 571	→ 54	0 204 104 208 <sup>B</sup>
						KOB,MIH	0 204 902 103	← 54	0 204 104 208 <sup>B</sup>
							0 204 103 502		
							0 204 902 104	→ 54	0 204 104 208 <sup>B</sup>
							0 204 103 503		
						LGS,MIH	0 204 102 569	→ 54	
							0 986 135 317		
							0 986 134 317	← 54	
						LGS,MIH	0 204 902 101	←	0 204 104 208 <sup>B</sup>
							0 204 103 499		
							0 986 134 317		
							0 204 902 102	→	0 204 104 208 <sup>B</sup>
							0 204 103 500		
							0 986 135 317		
	1.6 i16V	10.96-02.99	76			AG,MIH	0 204 102 570	← 54	0 204 104 208 <sup>B</sup>
							0 204 102 571	→ 54	0 204 104 208 <sup>B</sup>
		10.96-09.02	76			AG,MIH	0 204 902 103	← 54	0 204 104 208 <sup>B</sup>
							0 204 103 502		
							0 204 902 104	→ 54	0 204 104 208 <sup>B</sup>
							0 204 103 503		
						KOB,MIH	0 204 102 570	← 54	0 204 104 208 <sup>B</sup>
							0 204 102 571	→ 54	0 204 104 208 <sup>B</sup>













<div style="display: flex; align-items: center;"> <span>FIAT Marea [185]</span> </div>								
1.6 i 16V	10.96-09.02	76	KOB,MIH	0 204 902 103	← 54	0 204 104 208 <sup>8</sup>		
				0 204 103 502				
				0 204 902 104	→ 54			
			LGS,MIH	0 204 103 503				
				0 204 102 569	→ 54			
				0 986 135 317				
	10.98-09.02	76	LGS,MIH	0 986 134 317		0 204 104 208 <sup>8</sup>		
				0 204 902 101	←			
				0 204 103 499				
			MIH	0 986 134 317				
				0 204 902 102	→	0 204 104 208 <sup>8</sup>		
				0 204 103 500				
0 986 135 317								
1.6 i 16V BI-Power	10.99-12.02	76	MIH	0 204 102 569	→ 54	0 204 104 208 <sup>8</sup>		
				0 986 135 317				
				0 986 134 317			0 204 104 208 <sup>8</sup>	
			MIH	0 204 902 101	←			
				0 204 103 499				
				0 986 134 317				
	10.97-02.99	68-76	MIH	0 204 902 102	→	0 204 104 208 <sup>8</sup>		
				0 204 103 500				
				0 986 135 317				
			MIH	0 204 102 570	← 54	0 204 104 208 <sup>8</sup>		
				0 204 102 571	→ 54			
				0 204 103 503				
1.8 i 16V	03.99-09.02	68-76	MIH	0 204 902 103	← 54	0 204 104 208 <sup>8</sup>		
				0 204 103 502				
				0 204 902 104	→ 54			
			MIH	0 204 103 503				
				0 204 102 569	→ 54	0 204 104 208 <sup>8</sup>		
				0 986 135 317				
	0 986 134 317		0 204 104 208 <sup>8</sup>					
	10.96-09.02	83		MIH	0 204 902 101	←	0 204 104 208 <sup>8</sup>	
					0 204 103 499			
			0 986 134 317					
			MIH	0 204 902 102	→	0 204 104 208 <sup>8</sup>		
				0 204 103 500				
0 986 135 317								
1.9 JTD	10.96-09.02	73,6/74/77/81	MIH	0 204 102 570	← 54	0 204 104 208 <sup>8</sup>		
				0 204 102 571	→ 54			
				0 204 103 503				
			MIH	0 204 902 103	← 54	0 204 104 208 <sup>8</sup>		
				0 204 103 502				
				0 204 902 104	→ 54			
	1.9 JTD S.W.	10.96-09.02	77/81	MIH	0 204 103 503		0 204 104 208 <sup>8</sup>	
					0 204 902 103	← 54		
					0 204 103 502			
				MIH	0 204 902 104	→ 54	0 204 104 208 <sup>8</sup>	
					0 204 103 503			
					0 204 102 569	→ 54		
1.9 TD	10.96-09.02	55,1	MIH	0 986 135 317				
				0 204 102 569	→ 54			
				0 986 134 317		0 204 104 208 <sup>8</sup>		
1.9 TD	10.96-09.02	55,1	MIH	0 986 134 317			0 204 104 208 <sup>8</sup>	
				0 204 102 569	→ 54			
				0 986 135 317				



	S							
<b>1.9 TD</b>	10.96-09.02	55,1			MIH	0 204 902 101 0 204 103 499 0 986 134 317	←  	0 204 104 208 <sup>B</sup>
						0 204 902 102 0 204 103 500 0 986 135 317	→  	0 204 104 208 <sup>B</sup>
<b>2.0 i 20V</b>	10.96-12.02	108/110/ 113			MIH	0 204 102 572 0 204 102 573	← 54 → 54	
					MIH	0 204 102 506 0 204 103 506 0 986 134 005 0 204 102 507 0 204 103 507	← 54   → 54 	0 204 104 208 <sup>B</sup>
<b>2.4 JTD</b>	03.99-09.02	100			MIH	0 204 102 506 0 204 103 506 0 986 134 005 0 204 102 507 0 204 103 507	← 54   → 54 	0 204 104 208 <sup>B</sup>
<b>2.4 TD</b>	10.96-02.99	91			MIH	0 204 102 572 0 204 102 573	← 54 → 54	
					MIH	0 204 102 506 0 204 103 506 0 986 134 005 0 204 102 507 0 204 103 507	← 54   → 54 	0 204 104 208 <sup>B</sup>
	<b>1.2 i 16V</b>	03.99-04.00 60 05.00-09.02 60				0 986 475 827 0 986 475 904	↔ 22,2 ↔ 22	
	<b>1.4 i 12V</b>	10.96-02.97 59 03.97-02.99 59				F 026 002 434 0 986 475 827	↔ 22 ↔ 22,2	
	<b>1.6 i 16V</b>	10.96-02.97 76 10.96-04.97 76 03.97-04.00 76 05.97-09.02 76 10.98-02.99 76 03.99-04.00 76 10.99-12.02 76 05.00-09.02 76			LIM KOB LIM KOB LIM LIM LOC LIM	F 026 002 434 F 026 002 158 0 986 475 827 0 986 475 871 F 026 002 434 0 986 475 827 0 986 475 871 0 986 475 904	↔ 22 ↔ 20,6 ↔ 22,2 ↔ 20,64 ↔ 22 ↔ 22,2 ↔ 20,64 ↔ 22 ↔ 22	
	<b>1.6 i 16V BI-Power</b>	10.97-09.02 68-76			LOC	0 986 475 871	↔ 20,64	
	<b>1.8 i 16V</b>	10.96-02.97 83 10.96-04.97 83 03.97-04.00 83 05.97-09.02 83 05.00-09.02 83			LIM KOB LIM KOB LIM	F 026 002 434 F 026 002 158 0 986 475 827 0 986 475 871 0 986 475 904	↔ 22 ↔ 20,6 ↔ 22,2 ↔ 20,64 ↔ 22	
	<b>1.9 JTD</b>	03.99-04.00 77 03.99-09.02 77 08.00-09.02 81			LIM KOB KOB	0 986 475 827 0 986 475 871 0 986 475 871	↔ 22,2 ↔ 20,64 ↔ 20,64	
	<b>1.9 JTD S.W.</b>	10.01-09.02 74			KOB	0 986 475 871	↔ 20,64	
	<b>1.9 TD</b>	10.96-02.97 55,1/73,6 10.96-04.97 55,1/73,6 03.97-04.00 55,1/73,6 05.97-09.02 55,1/73,6			LIM KOB LIM KOB	F 026 002 434 F 026 002 158 0 986 475 827 0 986 475 871	↔ 22 ↔ 20,6 ↔ 22,2 ↔ 20,64	
	<b>2.0 i 20V</b>	10.96-03.97 108			MIH	0 986 473 121 0 986 474 121	← 33,9 → 33,9	
					MIH	0 986 473 121 0 986 474 121	← 33,9 → 33,9	1 987 470 028 <sup>7</sup>
	<b>2.4 TD</b>	10.96-03.97 91			MIH	0 986 473 121 0 986 474 121	← 33,9 → 33,9	1 987 470 028 <sup>7</sup>



			S															
◀ FIAT Marea [185]																		
	1.2 i 16V	03.99-09.02	60					1987 477 385	385									
								1987 477 552	← 1428									
								1987 477 826	→ 1383									
1.4 i 12V	10.96-02.99	59						1987 477 385	385									
								1987 477 552	← 1428									
								1987 477 826	→ 1383									
1.6 i 16V	10.96-09.02	76					KOB	1987 477 825	→ 1404									
								1987 482 180	← 1459									
								LIM	1987 477 552	← 1428								
									1987 477 826	→ 1383								
									10.96-12.02	76		1987 477 385	385					
10.99-12.02	76		1987 477 552	← 1428														
								1987 477 826	→ 1383									
1.6 i 16V BI-Power	10.97-09.02	68-76						1987 477 385	385									
								1987 477 552	← 1428									
								1987 477 826	→ 1383									
1.8 i 16V	10.96-09.02	83					KOB	1987 477 385	385									
								1987 477 825	→ 1404									
								1987 482 180	← 1459									
								LIM	1987 477 552	← 1428								
1987 477 826	→ 1383																	
1.9 JTD	03.99-09.02	77/81					KOB	1987 477 385	385									
								1987 477 825	→ 1404									
								1987 482 180	← 1459									
								LIM	1987 477 552	← 1428								
1987 477 826	→ 1383																	
1.9 JTD S.W.	10.01-09.02	74					KOB	1987 477 825	→ 1404									
								1987 482 180	← 1459									
								LIM	1987 477 552	← 1428								
									1987 477 826	→ 1383								
1.9 TD	10.96-09.02	55,1/73,6					KOB	1987 477 385	385									
								1987 477 825	→ 1404									
								1987 482 180	← 1459									
								LIM	1987 477 552	← 1428								
									1987 477 826	→ 1383								
								2.0 i 20V	10.96-02.99	108						1987 477 385	385	
1987 477 824	← 1502																	
1987 482 179	→ 1454																	
03.99-12.02	113						1987 477 385									385		
							1987 477 824									← 1502		
							1987 482 179									→ 1454		
08.00-09.02	110					AG,KOB	1987 477 552									← 1428		
							1987 477 826									→ 1383		
							LIM									1987 477 824	← 1502	
																1987 482 179	→ 1454	
08.00-12.02	110						1987 477 385	385										
05.01-12.02	110						1987 477 824	← 1502										
								1987 482 179	→ 1454									
2.4 JTD	10.96-09.02	91/100						1987 477 385	385									
2.4 TD								1987 477 824	← 1502									
								1987 482 179	→ 1454									
	1.2 i 16V	03.99-03.01	60				RAB	0 265 007 035 <sup>3</sup>										
								03.99-09.02	60				LAB	0 265 007 032 <sup>4</sup>				
														0 265 007 073 <sup>3</sup>				
															RAB	0 265 007 033 <sup>4</sup>		
								04.01-09.02	60						RAB	0 265 007 074 <sup>3</sup>		

										
<b>1.4 i 12V</b>	10.96-02.99	59	Ricam.Nr 0172273→, 5054835→	LAB,LLE	0 265 007 034 <sup>3</sup>					
			Ricam.Nr 0176273→, 5054835→	LAB,LLE	0 265 007 032 <sup>4</sup>					
				LLE,RAB	0 265 007 033 <sup>4</sup>					
<b>1.6 i 16V</b>	10.96-02.99	76	Ricam.Nr 0172273→, 5054835→	LAB,LLE	0 265 007 034 <sup>3</sup>					
			Ricam.Nr 0176273→, 5054835→	LAB,LLE	0 265 007 032 <sup>4</sup>					
				LLE,RAB	0 265 007 033 <sup>4</sup>					
					0 265 007 035 <sup>3</sup>					
			Ricam.Nr 0180748→	LAB,RLE	0 265 007 032 <sup>4</sup>					
					0 265 007 034 <sup>3</sup>					
				RAB,RLE	0 265 007 033 <sup>4</sup>					
					0 265 007 035 <sup>3</sup>					
			03.99-03.01	76		RAB	0 265 007 035 <sup>3</sup>			
			03.99-12.02	76		LAB	0 265 007 032 <sup>4</sup>			
				0 265 007 073 <sup>3</sup>						
			RAB	0 265 007 033 <sup>4</sup>						
04.01-12.02	76		RAB	0 265 007 074 <sup>3</sup>						
<b>1.6 i 16V BI-Power</b>	10.97-02.99	68-76	Ricam.Nr 0172273→, 5054835→	LAB,LLE	0 265 007 034 <sup>3</sup>					
			Ricam.Nr 0176273→, 5054835→	LAB,LLE	0 265 007 032 <sup>4</sup>					
				LLE,RAB	0 265 007 033 <sup>4</sup>					
					0 265 007 035 <sup>3</sup>					
			03.99-03.01	68-76		RAB	0 265 007 035 <sup>3</sup>			
			03.99-09.02	68-76		LAB	0 265 007 032 <sup>4</sup>			
							0 265 007 073 <sup>3</sup>			
			RAB	0 265 007 033 <sup>4</sup>						
04.01-09.02	68-76		RAB	0 265 007 074 <sup>3</sup>						
<b>1.8 i 16V</b>	10.96-02.99	83	Ricam.Nr 0172273→, 5054835→	LAB,LLE	0 265 007 034 <sup>3</sup>					
			Ricam.Nr 0176273→, 5054835→	LAB,LLE	0 265 007 032 <sup>4</sup>					
				LLE,RAB	0 265 007 033 <sup>4</sup>					
					0 265 007 035 <sup>3</sup>					
			Ricam.Nr 0180748→	LAB,RLE	0 265 007 032 <sup>4</sup>					
					0 265 007 034 <sup>3</sup>					
				RAB,RLE	0 265 007 033 <sup>4</sup>					
					0 265 007 035 <sup>3</sup>					
			03.99-03.01	83		RAB	0 265 007 035 <sup>3</sup>			
			03.99-09.02	83		LAB	0 265 007 032 <sup>4</sup>			
				0 265 007 073 <sup>3</sup>						
			RAB	0 265 007 033 <sup>4</sup>						
04.01-09.02	83		RAB	0 265 007 074 <sup>3</sup>						
<b>1.9 JTD</b>	03.99-03.01	77/81		RAB	0 265 007 035 <sup>3</sup>					
				LAB	0 265 007 032 <sup>4</sup>					
					0 265 007 073 <sup>3</sup>					
				RAB	0 265 007 033 <sup>4</sup>					
04.01-09.02	77/81		RAB	0 265 007 074 <sup>3</sup>						
<b>1.9 JTD S.W.</b>	10.01-09.02	74		LAB	0 265 007 032 <sup>4</sup>					
					0 265 007 073 <sup>3</sup>					
				RAB	0 265 007 033 <sup>4</sup>					
				0 265 007 074 <sup>3</sup>						
<b>1.9 TD</b>	10.96-02.99	55,1	Ricam.Nr 0172273→, 5054835→	LAB,LLE	0 265 007 034 <sup>3</sup>					
			Ricam.Nr 0176273→, 5054835→	LLE,RAB	0 265 007 035 <sup>3</sup>					
			Ricam.Nr 0180748→	LAB,RLE	0 265 007 034 <sup>3</sup>					
				RAB,RLE	0 265 007 035 <sup>3</sup>					
			73,6	Ricam.Nr 0172273→, 5054835→	LAB,LLE	0 265 007 034 <sup>3</sup>				
				Ricam.Nr 0176273→, 5054835→	LLE,RAB	0 265 007 035 <sup>3</sup>				



		S							
<b>FIAT Marea [185]</b>									
1.9 TD		10.96-02.99	73,6	Ricam.Nr 0180748→	LAB,RLE	0 265 007 034 <sup>3</sup>			
					RAB,RLE	0 265 007 035 <sup>3</sup>			
		03.99-03.01	55,1		RAB	0 265 007 035 <sup>3</sup>			
		03.99-09.02	55,1		LAB	0 265 007 032 <sup>4</sup>			
						0 265 007 073 <sup>3</sup>			
					RAB	0 265 007 033 <sup>4</sup>			
2.0 i 20V		10.96-02.99	108	Ricam.Nr 0172273→, 5054835→	LAB,LLE	0 265 007 034 <sup>3</sup>			
				Ricam.Nr 0176273→, 5054835→	LAB,LLE	0 265 007 032 <sup>4</sup>			
					LLE,RAB	0 265 007 033 <sup>4</sup>			
						0 265 007 035 <sup>3</sup>			
		03.99-03.01	110/113		RAB	0 265 007 035 <sup>3</sup>			
		03.99-12.02	110/113		LAB	0 265 007 032 <sup>4</sup>			
				0 265 007 073 <sup>3</sup>					
			RAB	0 265 007 033 <sup>4</sup>					
2.4 JTD		04.01-12.02	110/113		RAB	0 265 007 074 <sup>3</sup>			
		03.99-03.01	100		RAB	0 265 007 035 <sup>3</sup>			
		03.99-09.02	100		LAB	0 265 007 032 <sup>4</sup>			
						0 265 007 073 <sup>3</sup>			
			RAB	0 265 007 033 <sup>4</sup>					
2.4 TD		04.01-09.02	100		RAB	0 265 007 074 <sup>3</sup>			
		10.96-02.99	91	Ricam.Nr 0172273→, 5054835→	LAB,LLE	0 265 007 034 <sup>3</sup>			
				Ricam.Nr 0176273→, 5054835→	LLE,RAB	0 265 007 035 <sup>3</sup>			
				Ricam.Nr 0180748→	LAB,RLE	0 265 007 034 <sup>3</sup>			
				RAB,RLE	0 265 007 035 <sup>3</sup>				
<b>Marengo [259..]</b>									
1.9 D		04.93-12.96	48			0 204 102 530	← 54	0 204 104 237 <sup>7</sup>	
						0 204 103 530			
						0 204 102 531	→ 54	0 204 104 237 <sup>7</sup>	
						0 204 103 531			
1.9 D Turbo		04.93-12.96	66			0 204 102 532	← 54	0 204 104 237 <sup>7</sup>	
						0 204 103 532			
						0 204 102 533	→ 54	0 204 104 237 <sup>7</sup>	
						0 204 103 533			
1.9 D 1.9 D Turbo		ABO	04.93-12.96	48/66		F 026 002 158	↔ 20,6		
1.9 D		02.90-12.96	48			0 986 471 009	→ 34	1 987 470 028 <sup>7</sup>	
						0 986 474 077			
						0 986 471 010	← 34	1 987 470 028 <sup>7</sup>	
						0 986 473 077			
1.9 D Turbo		02.90-12.96	66		MH	0 986 471 009	→ 34	1 987 470 028 <sup>7</sup>	
						0 986 474 077			
						0 986 471 010	← 34	1 987 470 028 <sup>7</sup>	
						0 986 473 077			
1.9 D 1.9 D Turbo		02.90-12.96	48 66			1 987 477 375	→ 1460		
						1 987 477 382	← 1517		
						1 987 477 375	→ 1460		
						1 987 477 382	← 1517		
1.9 D, D Turbo			02.90-12.96	48/66		TBR	1 987 477 089	1405	

		S									
	1.9D	04.93-12.96	48				0 265 001 215 <sup>3</sup>				
				LAB		0 265 001 216 <sup>4</sup>					
	1.9D Turbo	02.90-12.96	66		LAB		0 265 001 216 <sup>4</sup>				
		04.93-12.96	66		RAB		0 265 001 217 <sup>4</sup>				
<b>Marengo [285..]</b>											
	1.9JTD	01.97-09.02	73,6/77/		MIH		0 204 102 570	← 54	0 204 104 208 <sup>B</sup>		
							0 204 102 571	→ 54	0 204 104 208 <sup>B</sup>		
	1.9TD		81		MIH		0 204 902 103	← 54	0 204 104 208 <sup>B</sup>		
							0 204 103 502				
							0 204 902 104	→ 54	0 204 104 208 <sup>B</sup>		
							0 204 103 503				
	1.9TD	01.97-09.02	55/55,1		MIH		0 204 102 569	→ 54			
							0 986 135 317				
							0 986 134 317	← 54			
						MIH		0 204 902 101	←	0 204 104 208 <sup>B</sup>	
							0 204 103 499				
							0 986 134 317				
							0 204 902 102	→	0 204 104 208 <sup>B</sup>		
							0 204 103 500				
							0 986 135 317				
	1.9JTD	03.99-09.02	77/81				0 986 475 871	↔ 20,64			
		1.9TD	01.97-04.97	55,1/73,6				F 026 002 158	↔ 20,6		
	05.97-09.02		55,1/73,6				0 986 475 871	↔ 20,64			
		03.99-09.02	55				0 986 475 871	↔ 20,64			
	1.9JTD	01.97-09.02	55/55,1/				1 987 477 385	385			
			73,6/77/				1 987 477 825	→ 1404			
	1.9TD		81				1 987 482 180	← 1459			
	1.9JTD	03.99-03.01	77/81		RAB		0 265 007 035 <sup>3</sup>				
				03.99-09.02	77/81		LAB		0 265 007 032 <sup>4</sup>		
									0 265 007 073 <sup>3</sup>		
						RAB		0 265 007 033 <sup>4</sup>			
		04.01-09.02	77/81		RAB		0 265 007 074 <sup>3</sup>				
	1.9TD	01.97-02.99	55,1	Ricam.Nr 0172273→, 5054835→	LAB,LLE		0 265 007 034 <sup>3</sup>				
			73,6	Ricam.Nr 0172273→, 5054835→	LAB,LLE		0 265 007 034 <sup>3</sup>				
				Ricam.Nr 0176273→, 5054835→	LAB,LLE		0 265 007 032 <sup>4</sup>				
					LLE,RAB		0 265 007 033 <sup>4</sup>				
							0 265 007 035 <sup>3</sup>				
		01.97-09.02	55,1	Ricam.Nr 0176273→, 5054835→	LAB,LLE		0 265 007 032 <sup>4</sup>				
					LLE,RAB		0 265 007 033 <sup>4</sup>				
							0 265 007 035 <sup>3</sup>				
		03.99-03.01	55		RAB		0 265 007 035 <sup>3</sup>				
		03.99-09.02	55		LAB		0 265 007 032 <sup>4</sup>				
					0 265 007 073 <sup>3</sup>						
						0 265 007 033 <sup>4</sup>					
						0 265 007 035 <sup>3</sup>					
			55,1		LAB,LLE		0 265 007 073 <sup>3</sup>				
	04.01-09.02	55		RAB		0 265 007 074 <sup>3</sup>					



	S									
◀ FIAT										
<b>Multipla [186..]</b>										
	1.6 Blupower 1.6 16V 1.6 16V Bipower CNG 1.6 16V LPG	01.99-12.10	68-76	Fg.-Nr. →2232223	MIH	0 204 102 572	← 54			
						0 204 102 573	→ 54			
						0 204 102 506	← 54	0 204 104 208 <sup>8</sup>		
						0 204 103 506				
						0 986 134 005				
						0 204 102 507	→ 54	0 204 104 208 <sup>8</sup>		
					Fg.-Nr. 2232224→	MIH	0 204 004 338	← 54	0 204 104 279 <sup>7</sup>	
							0 986 134 339			
							0 204 004 339	→ 54	0 204 104 279 <sup>7</sup>	
							0 986 135 339			
							0 204 102 572	← 54		
							0 204 102 573	→ 54		
1.9 JTD	01.99-12.10	77/81/85	Fg.-Nr. →2232223	MIH	0 204 102 572	← 54				
					0 204 102 573	→ 54				
					0 204 102 506	← 54	0 204 104 208 <sup>8</sup>			
					0 204 103 506					
					0 986 134 005					
					0 204 102 507	→ 54	0 204 104 208 <sup>8</sup>			
				Fg.-Nr. 2232224→	MIH	0 204 004 338	← 54	0 204 104 279 <sup>7</sup>		
						0 986 134 339				
						0 204 004 339	→ 54	0 204 104 279 <sup>7</sup>		
						0 986 135 339				
						0 204 004 338	← 54	0 204 104 279 <sup>7</sup>		
						0 986 134 339				
	10.05-12.10	88		MIH	0 204 004 338	← 54	0 204 104 279 <sup>7</sup>			
					0 986 134 339					
					0 204 004 339	→ 54	0 204 104 279 <sup>7</sup>			
					0 986 135 339					
	1.6 Blupower, 16V, 16V Bipower CNG, 16V LPG	01.99-12.10	68-76			0 986 475 871	↔ 20,64			
						0 986 475 871	↔ 20,64			
	1.9 JTD	01.99-12.10	77/81/85/88				0 986 475 871	↔ 20,64		
							0 986 475 871	↔ 20,64		
		1.6 Blupower 1.6 16V 1.6 16V Bipower CNG 1.6 16V LPG	09.00-06.07	68-76	Fg.-Nr. 2249334→		0 204 004 437	← 38		
							0 986 134 006			
							0 204 004 438	→ 38		
							0 986 135 006			
							0 204 001 971	← 38		
							0 986 473 310			
			09.00-12.10	68-76	Fg.-Nr. →2249333			0 204 001 972	→ 38	
								0 986 474 310		
0 204 004 437								← 38		
0 986 134 006										
0 204 004 438								→ 38		
0 986 135 006										
1.9 JTD	04.02-06.07	85	Fg.-Nr. 2249334→			0 204 004 437	← 38			
						0 986 134 006				
						0 204 004 438	→ 38			
						0 986 135 006				
						0 204 001 971	← 38			
						0 986 473 310				
		04.02-12.10	85	Fg.-Nr. →2249333			0 204 001 972	→ 38		
							0 986 474 310			
							0 204 004 437	← 38		
							0 986 134 006			
							0 204 004 438	→ 38		
							0 986 135 006			
	1.6 Blupower	01.99-03.02	70			1 987 477 728	← 1143			
						1 987 477 729	→ 2063			
						1 987 477 728	← 1143			
						1 987 477 729	→ 2063			
						1 987 477 728	← 1143			
						1 987 477 729	→ 2063			
		04.02-12.10	70	Ricam.Nr 2151656→			1 987 477 728	← 1143		
							1 987 477 729	→ 2063		
							1 987 477 728	← 1143		
							1 987 477 729	→ 2063		
							1 987 477 728	← 1143		
							1 987 477 729	→ 2063		



		S								
<b>1.6 16V</b>	01.99-12.10	76				LLE	1 987 477 557	→ 2014		
							1 987 477 562	← 1165		
						RLE	1 987 477 558	→ 1211		
								1 987 477 559	← 2266	
	MFD	09.00-12.10	76				LLE	1 987 482 181	→ 2081	
								1 987 482 182	← 1220	
	OFD	09.00-03.02	76				LLE	1 987 477 557	→ 2014	
								1 987 477 562	← 1165	
							RLE	1 987 477 558	→ 1211	
								1 987 477 559	← 2266	
		09.00-12.10	76		Ricam.Nr 2151656→		LLE	1 987 477 557	→ 2014	
								1 987 477 562	← 1165	
							RLE	1 987 477 558	→ 1211	
								1 987 477 559	← 2266	
		04.02-12.10	76		Ricam.Nr →2151655		LLE	1 987 482 181	→ 2081	
							1 987 482 182	← 1220		
						RLE	1 987 482 185	← 2326		
							1 987 482 186	→ 1271		
<b>1.6 16V Bipower CNG</b>	01.99-10.00	68-76					1 987 477 728	← 1143		
							1 987 477 729	→ 2063		
	MFD	01.01-12.10	68-76				1 987 482 181	→ 2081		
							1 987 482 182	← 1220		
	OFD	01.01-03.02	68-76				1 987 477 728	← 1143		
							1 987 477 729	→ 2063		
	01.01-12.10	68-76		Ricam.Nr 2151656→			1 987 477 728	← 1143		
							1 987 477 729	→ 2063		
<b>1.6 16V LPG</b>	01.01-03.02	68-76					1 987 477 728	← 1143		
							1 987 477 729	→ 2063		
	01.01-12.10	68-76		Ricam.Nr 2151656→			1 987 477 728	← 1143		
							1 987 477 729	→ 2063		
<b>1.9 JTD</b>	01.99-03.02	77/81				LLE	1 987 477 557	→ 2014		
							1 987 477 562	← 1165		
						RLE	1 987 477 558	→ 1211		
								1 987 477 559	← 2266	
	MFD	04.02-12.10	85/88				LLE	1 987 482 181	→ 2081	
								1 987 482 182	← 1220	
	OFD	04.02-12.10	85		Ricam.Nr →2151655		LLE	1 987 482 181	→ 2081	
								1 987 482 182	← 1220	
							RLE	1 987 482 185	← 2326	
								1 987 482 186	→ 1271	
					Ricam.Nr 2151656→		LLE	1 987 477 557	→ 2014	
								1 987 477 562	← 1165	
							RLE	1 987 477 558	→ 1211	
								1 987 477 559	← 2266	
		10.05-12.10	88		Ricam.Nr 2151656→		LLE	1 987 477 557	→ 2014	
							1 987 477 562	← 1165		
						RLE	1 987 477 558	→ 1211		
							1 987 477 559	← 2266		
	<b>1.6 Blupower</b>	01.99-03.02	68-76				LAB	0 265 007 038 <sup>3</sup>		
	<b>1.6 16V Bipower CNG</b>						RAB	0 265 007 039 <sup>3</sup>		
		01.01-12.10	68-76		Ricam.Nr →2152664		LAB	0 265 007 038 <sup>3</sup>		
							RAB	0 265 007 039 <sup>3</sup>		
<b>1.6 Blupower</b>		01.99-03.02	68-76				LAB	0 265 007 036 <sup>4</sup>		
<b>1.6 16V Bipower CNG</b>							RAB	0 265 007 037 <sup>4</sup>		
<b>1.6 16V LPG</b>		01.01-12.10	68-76		Ricam.Nr 2152665→		LAB	0 265 007 561 <sup>3</sup>		
							RAB	0 265 007 563 <sup>4</sup>		
								0 265 007 560 <sup>3</sup>		
								0 265 007 562 <sup>4</sup>		
		04.02-12.10	68-76		Ricam.Nr →2152664		LAB	0 265 007 551 <sup>4</sup>		
							RAB	0 265 007 550 <sup>4</sup>		





		S							
<b>FIAT Multipla [186..]</b>									
	1.6 16V	01.99-12.10	76			LAB	0 265 007 036 <sup>4</sup>		
							RAB	0 265 007 038 <sup>3</sup>	
							0 265 007 037 <sup>4</sup>		
							0 265 007 039 <sup>3</sup>		
		09.00-12.10	76	Ricam.Nr 2152665→		LAB	0 265 007 561 <sup>3</sup>		
						RAB	0 265 007 563 <sup>4</sup>		
							0 265 007 560 <sup>3</sup>		
							0 265 007 562 <sup>4</sup>		
		04.02-12.10	76	Ricam.Nr →2152664		LAB	0 265 007 551 <sup>4</sup>		
						RAB	0 265 007 550 <sup>4</sup>		
	1.6 16V LPG	01.01-12.10	68-76	Ricam.Nr →2152664		LAB	0 265 007 038 <sup>3</sup>		
						RAB	0 265 007 039 <sup>3</sup>		
	1.9 JTD	01.99-03.02	77/81			LAB	0 265 007 036 <sup>4</sup>		
						RAB	0 265 007 038 <sup>3</sup>		
							0 265 007 037 <sup>4</sup>		
							0 265 007 039 <sup>3</sup>		
		04.02-12.10	85/88	Ricam.Nr →2152664		LAB	0 265 007 038 <sup>3</sup>		
						RAB	0 265 007 551 <sup>4</sup>		
							0 265 007 039 <sup>3</sup>		
							0 265 007 550 <sup>4</sup>		
				Ricam.Nr 2152665→		LAB	0 265 007 561 <sup>3</sup>		
						RAB	0 265 007 563 <sup>4</sup>		
							0 265 007 560 <sup>3</sup>		
							0 265 007 562 <sup>4</sup>		

**Palio**

	1.3 MPI 16V	01.03-12.07	59				0 986 473 125		← 54	
							0 986 474 125		→ 54	
	1.3 MPI 16V	ABO	01.03-12.07	59			0 986 BB3 009		↔	
		ABS	01.03-12.07	59			0 986 BB3 011		↔	
		1.7 D	ABO	02.97-08.01	52		0 986 BB3 009		↔	
		1.7 TD	ABS	02.97-08.01	52		0 986 BB3 011		↔	
	1.3 MPI 16V	01.03-12.07	59				1 987 477 724		↔ 1400	
	1.3 MPI 16V	01.03-12.07	59				0 265 007 051 <sup>4</sup>			
							LAB	0 265 007 102 <sup>3</sup>		
							RAB	0 265 007 103 <sup>3</sup>		

**Palio [Fase I]**

	1.0 MPI 8V	12.98-02.03	45/51,5				0 986 473 125		← 54					
							0 986 474 125		→ 54					
							1.3 MPI 16V	03.00-02.03	59			0 986 473 125		← 54
												0 986 474 125		→ 54
	1.0 MPI 8V	06.96-08.98	45				0 986 AB8 488		↔					
		ABO	09.98-02.03	45/51,5			0 986 BB3 009		↔					
		ABS	09.98-02.03	45/51,5			0 986 BB3 011		↔					
		1.3 MPI 16V	ABO	03.00-02.03	59		0 986 BB3 009		↔					
			ABS	03.00-02.03	59		0 986 BB3 011		↔					

		S							
	1.0 MPI 8V	06.96-08.01	45/51,5				1 987 477 724	↔ 1400	
	1.0 MPI 16V	08.00-02.03	45/51,5				1 987 477 724	↔ 1400	
	1.3 MPI 16V	03.00-02.03	59				1 987 477 724	↔ 1400	
	1.0 MPI 8V	06.96-08.01	45				0 265 006 249 <sup>4</sup>		
						LAB	0 265 006 163 <sup>3</sup>		
						RAB	0 265 006 164 <sup>3</sup>		
	1.0 MPI 16V	08.00-02.03	51,5				0 265 007 051 <sup>4</sup>		
						LAB	0 265 007 102 <sup>3</sup>		
						RAB	0 265 007 103 <sup>3</sup>		
	1.3 MPI 16V	03.00-09.00	59				0 265 006 249 <sup>4</sup>		
						LAB	0 265 006 163 <sup>3</sup>		
						RAB	0 265 006 164 <sup>3</sup>		
		10.00-02.03	59				0 265 007 051 <sup>4</sup>		
						LAB	0 265 007 102 <sup>3</sup>		
						RAB	0 265 007 103 <sup>3</sup>		
<b>Palio [Fase II]</b>									
	1.3 MPI 16V	10.04-12.07	59				0 986 473 125	↔ 54	
							0 986 474 125	↔ 54	
	1.3 MPI 16V	10.04-12.07	59				1 987 477 724	↔ 1400	
	1.3 MPI 16V	10.04-12.07	59				0 265 007 051 <sup>4</sup>		
						LAB	0 265 007 102 <sup>3</sup>		
						RAB	0 265 007 103 <sup>3</sup>		
<b>Palio Weekend [Fase I]</b>									
	1.0 MPI 16V	09.00-02.03	51				0 986 473 125	↔ 54	
							0 986 474 125	↔ 54	
	1.3 MPI 16V	03.00-02.03	59				0 986 473 125	↔ 54	
							0 986 474 125	↔ 54	
	1.5 MPI 8V	03.98-04.99	56				0 986 473 125	↔ 54	
							0 986 474 125	↔ 54	
	1.6 MPI 16V	05.97-02.03	78				0 986 473 125	↔ 54	
							0 986 474 125	↔ 54	
	1.0 MPI 16V	09.00-02.03	51				0 986 AB8 445	↔	
	1.3 MPI 16V	03.00-02.03	59				0 986 AB8 445	↔	
	1.5 MPI 8V	02.97-04.97	56				0 986 AB8 445	↔	
		05.97-08.98	56				0 986 475 871	↔ 20,64	
		09.98-04.99	56				0 986 AB8 445	↔	
	1.6 MPI 16V	05.97-06.97	78				0 986 AB8 445	↔	
		07.97-08.98	78				0 986 475 871	↔ 20,64	
		09.98-02.03	78				0 986 AB8 445	↔	
	1.0 MPI 16V	09.00-02.03	51				1 987 477 550	↔ 1515	
							1 987 477 551	↔ 1465	
	1.3 MPI 16V	03.00-02.03	59				1 987 477 550	↔ 1515	
							1 987 477 551	↔ 1465	



			S								
◀ FIAT Palio Weekend [Fase I]											
1.5 MPI 8V	02.97-04.99	56						1987 477 550	← 1515		
								1987 477 551	→ 1465		
1.6 MPI 16V	05.97-02.03	78						1987 477 724	↔ 1400		
1.0 MPI 16V	09.00-02.03	51						0265 007 052 <sup>4</sup>			
								0265 007 102 <sup>3</sup>			
								RAB	0265 007 053 <sup>4</sup>		
1.3 MPI 16V	03.00-09.00	59						0265 006 163 <sup>3</sup>			
								0265 006 364 <sup>4</sup>			
								RAB	0265 006 164 <sup>3</sup>		
	10.00-02.03	59						0265 006 365 <sup>4</sup>			
								0265 007 052 <sup>4</sup>			
								0265 007 102 <sup>3</sup>			
								0265 007 053 <sup>4</sup>			
1.5 MPI 8V	02.97-04.99	56						0265 006 163 <sup>3</sup>			
								0265 006 364 <sup>4</sup>			
								RAB	0265 006 164 <sup>3</sup>		
								0265 006 365 <sup>4</sup>			
1.6 MPI 16V	05.97-09.00	78						0265 006 163 <sup>3</sup>			
								0265 006 364 <sup>4</sup>			
								RAB	0265 006 164 <sup>3</sup>		
	10.00-02.03	78						0265 006 365 <sup>4</sup>			
								0265 007 052 <sup>4</sup>			
								0265 007 102 <sup>3</sup>			
								0265 007 053 <sup>4</sup>			
								0265 007 103 <sup>3</sup>			
<b>Palio Weekend [178..]</b>											
1.2 i.e.	08.00-02.02	44						0986 473 125	← 54		
								0986 474 125	→ 54		
1.2 i.e. 8V	03.99-09.01	44						AEL,MIH	0986 473 125	← 54	
									0986 474 125	→ 54	
								FHL,MIH	0986 473 125	← 54	
									0986 474 125	→ 54	
									0986 473 125	← 54	
	10.99-09.01	44						0986 474 125	→ 54		
	10.01-12.08	44						0986 473 125	← 54		
								0986 474 125	→ 54		
1.2 i.e. 16V	10.01-12.08	59						0986 473 125	← 54		
								0986 474 125	→ 54		
1.2 MPI 16V	07.03-03.04	59						0986 473 125	← 54		
								0986 474 125	→ 54		
1.4 i.e.	04.98-02.99	51						Fg.-Nr. 0582136→	MIH	0986 473 125	← 54
									0986 474 125	→ 54	
	09.98-06.01	51						MIH	0986 473 125	← 54	
									0986 474 125	→ 54	
1.6 i.e. 8V	02.00→	69/74						MIH	0986 473 125	← 54	
1.6 i.e. 16V									0986 474 125	→ 54	
1.6 i.e. 16V	11.97-09.02	76						MIH	0986 473 125	← 54	
									0986 474 125	→ 54	
									0986 473 125	← 54	
	10.01-12.08	76						0986 474 125	→ 54		
								0986 473 125	← 54		
								0986 474 125	→ 54		
1.7 TD	04.98-12.98	51						Fg.-Nr. 0582136→	MIH	0986 473 125	← 54
									0986 474 125	→ 54	
									0986 473 125	← 54	
	01.99-10.00	51						Fg.-Nr. →2175112, →6903945	MIH	0986 473 125	← 54
										0986 474 125	→ 54
	08.00-02.02	46						MIH	0986 473 125	← 54	
										0986 474 125	→ 54

	S							
1.7 TD	08.00-02.02	51			MIH	0 986 473 125		54
						0 986 474 125		54
1.9 D	11.00-12.08	46/48/51/			MIH	0 986 473 125		54
1.9 JTD		57/80				0 986 474 125		54
75 1.2 i.e.	04.98-12.98	54	Fg.-Nr. 0582136→		MIH	0 986 473 125		54
						0 986 474 125		54
	01.99-09.01	54	Fg.-Nr. →2175112, →6903945		MIH	0 986 473 125		54
						0 986 474 125		54
	08.00-09.01	54			MIH	0 986 473 125		54
						0 986 474 125		54
75 1.2 i.e. 8V	10.01-09.04	54			MIH	0 986 473 125		54
						0 986 474 125		54
85 1.2 i.e. 16V	10.01-09.04	63			MIH	0 986 473 125		54
						0 986 474 125		54
100 1.6 i.e. 16V	09.97-09.04	76			MIH	0 986 473 125		54
						0 986 474 125		54
	1.2 i.e.	08.00-02.02	44			0 986 475 871		20,64
	1.2 i.e. 8V	03.99-09.01	44			0 986 475 871		20,64
		10.01-12.08	44		BO	0 986 475 867		20,64
					LOC	0 986 475 871		20,64
	1.2 i.e. 16V	10.01-12.08	59		BO	0 986 475 867		20,64
	1.2 MPI 16V				LOC	0 986 475 871		20,64
	1.4 i.e.	11.97-06.01	51			0 986 475 871		20,64
	1.6 i.e. 8V	06.01-09.02	69			0 986 475 871		20,64
	1.6 i.e. 16V	11.97-09.02	76			0 986 475 871		20,64
		10.01-12.08	76		BO	0 986 475 867		20,64
					LOC	0 986 475 871		20,64
		ABO 02.00→	74			0 986 475 871		20,64
		ABS 02.00→	74			0 986 475 871		20,64
1.7 TD	09.97-10.00	51			BSY	0 986 475 867		20,64
					LOC	0 986 475 871		20,64
	08.00-02.02	46				0 986 475 871		20,64
		51				0 986 475 871		20,64
1.9 D	11.00-09.01	46			BSY	0 986 475 867		20,64
					LOC	0 986 475 871		20,64
1.9 D	10.01-12.08	48/51/57/			BO	0 986 475 867		20,64
1.9 JTD		80			LOC	0 986 475 871		20,64
75 1.2 i.e.	09.97-09.01	54			BSY	0 986 475 867		20,64
75 1.2 i.e. 8V	10.01-09.04	54			BO	0 986 475 867		20,64
75 1.2 i.e., 1.2 i.e. 8V	09.97-09.04	54			LOC	0 986 475 871		20,64
85 1.2 i.e. 16V	10.01-09.04	63			BO	0 986 475 867		20,64
					LOC	0 986 475 871		20,64
100 1.6 i.e. 16V	09.97-09.01	76			BSY	0 986 475 867		20,64
	09.97-09.04	76			LOC	0 986 475 871		20,64
	10.01-09.04	76			BO	0 986 475 867		20,64
	1.2 i.e., i.e. 8V, i.e. 16V, MPI 16V	03.99-12.08	44/59			1 987 477 550		1515
						1 987 477 551		1465
	1.4 i.e.	11.97-06.01	51			1 987 477 550		1515
						1 987 477 551		1465
	1.6 i.e. 8V	11.97→	69/74/76			1 987 477 550		1515
	1.6 i.e. 16V					1 987 477 551		1465
	1.7 TD	09.97-02.02	46/51			1 987 477 550		1515
						1 987 477 551		1465
	1.9 D	11.00-12.08	46/48/51/			1 987 477 550		1515
	1.9 JTD		57/80			1 987 477 551		1465
	75 1.2 i.e.	09.97-09.04	54			1 987 477 550		1515
	75 1.2 i.e. 8V					1 987 477 551		1465



			S							
◀ FIAT Palio Weekend [178..]										
85	1.2 i.e. 16V		10.01-09.04	63				1987 477 550	← 1515	
								1987 477 551	→ 1465	
100	1.6 i.e. 16V		09.97-09.04	76				1987 477 550	← 1515	
								1987 477 551	→ 1465	
	1.2 i.e.		08.00-02.02	44			RAB	0 265 006 365 <sup>4</sup>		
	1.2 i.e.		03.99-02.02	44			LAB	0 265 006 163 <sup>3</sup>		
	1.2 i.e. 8V							0 265 006 364 <sup>4</sup>		
							RAB	0 265 006 164 <sup>3</sup>		
	1.2 i.e. 8V		03.99-09.01	44			RAB	0 265 006 365 <sup>4</sup>		
			10.01-12.08	44			LAB	0 265 007 052 <sup>4</sup>		
								0 265 007 102 <sup>3</sup>		
							RAB	0 265 007 053 <sup>4</sup>		
								0 265 007 103 <sup>3</sup>		
	1.2 i.e. 16V		10.01-12.08	59			LAB	0 265 007 052 <sup>4</sup>		
	1.2 MPI 16V							0 265 007 102 <sup>3</sup>		
							RAB	0 265 007 053 <sup>4</sup>		
								0 265 007 103 <sup>3</sup>		
	1.4 i.e.		11.97-06.01	51			LAB	0 265 006 163 <sup>3</sup>		
								0 265 006 364 <sup>4</sup>		
							RAB	0 265 006 164 <sup>3</sup>		
								0 265 006 365 <sup>4</sup>		
	1.6 i.e. 8V		02.00→	69/74			LAB	0 265 006 163 <sup>3</sup>		
	1.6 i.e. 16V							0 265 006 364 <sup>4</sup>		
							RAB	0 265 006 164 <sup>3</sup>		
								0 265 006 365 <sup>4</sup>		
	1.6 i.e. 16V		11.97-09.02	76			LAB	0 265 006 163 <sup>3</sup>		
								0 265 006 364 <sup>4</sup>		
							RAB	0 265 006 164 <sup>3</sup>		
								0 265 006 365 <sup>4</sup>		
			10.01-12.08	76			LAB	0 265 007 052 <sup>4</sup>		
								0 265 007 102 <sup>3</sup>		
							RAB	0 265 007 053 <sup>4</sup>		
								0 265 007 103 <sup>3</sup>		
	1.7 TD		09.97-02.02	46/51			LAB	0 265 006 163 <sup>3</sup>		
								0 265 006 364 <sup>4</sup>		
							RAB	0 265 006 164 <sup>3</sup>		
								0 265 006 365 <sup>4</sup>		
	1.9 D		11.00-09.01	46				0 265 006 249 <sup>4</sup>		
							LAB	0 265 006 163 <sup>3</sup>		
							RAB	0 265 006 164 <sup>3</sup>		
	1.9 D		10.01-12.08	48/51/57/			LAB	0 265 007 052 <sup>4</sup>		
	1.9 JTD			80				0 265 007 102 <sup>3</sup>		
							RAB	0 265 007 053 <sup>4</sup>		
								0 265 007 103 <sup>3</sup>		
	75 1.2 i.e.		09.97-09.01	54			LAB	0 265 006 163 <sup>3</sup>		
								0 265 006 364 <sup>4</sup>		
							RAB	0 265 006 164 <sup>3</sup>		
								0 265 006 365 <sup>4</sup>		
	75 1.2 i.e. 8V		10.01-09.04	54			LAB	0 265 007 052 <sup>4</sup>		
								0 265 007 102 <sup>3</sup>		
							RAB	0 265 007 053 <sup>4</sup>		
								0 265 007 103 <sup>3</sup>		
	85 1.2 i.e. 16V		10.01-09.04	63			LAB	0 265 007 052 <sup>4</sup>		
								0 265 007 102 <sup>3</sup>		
							RAB	0 265 007 053 <sup>4</sup>		
								0 265 007 103 <sup>3</sup>		
	100 1.6 i.e. 16V		09.97-09.01	76			LAB	0 265 006 163 <sup>3</sup>		
								0 265 006 364 <sup>4</sup>		
							RAB	0 265 006 164 <sup>3</sup>		
								0 265 006 365 <sup>4</sup>		



100 1.6 i.e. 16V	10.01-09.04	76			LAB	0 265 007 052 <sup>4</sup>		
					RAB	0 265 007 102 <sup>3</sup>		
						0 265 007 053 <sup>4</sup>		
						0 265 007 103 <sup>3</sup>		
<b>Palio [178..]</b>								
	1.2 i.e. 8V	11.99-09.01	54		MIH ATE	0 986 473 125	↔ 54	
						0 986 474 125	↔ 54	
		05.00-08.02	44		MIH ATE	0 986 473 125	↔ 54	
						0 986 474 125	↔ 54	
		07.01-12.11	46			0 986 473 125	↔ 54	
						0 986 474 125	↔ 54	
		10.01-12.11	44		TW ATE	0 986 473 125	↔ 54	
						0 986 474 125	↔ 54	
					BO	0 204 004 607	↔ 54	0 204 104 282 <sup>B</sup>
						0 204 004 608	↔ 54	0 204 104 282 <sup>B</sup>
						0 204 902 040	↔	0 204 104 370 <sup>B</sup>
						0 204 902 041	↔	0 204 104 370 <sup>B</sup>
	1.2 i.e. 16V	10.01-12.11	59		AG,TW	0 986 473 125	↔ 54	
						0 986 474 125	↔ 54	
					GS,TW	0 986 473 125	↔ 54	
						0 986 474 125	↔ 54	
					BO	0 204 004 607	↔ 54	0 204 104 282 <sup>B</sup>
						0 204 004 608	↔ 54	0 204 104 282 <sup>B</sup>
					TW BO	0 204 902 040	↔	0 204 104 370 <sup>B</sup>
						0 204 902 041	↔	0 204 104 370 <sup>B</sup>
	1.3 JTD 16V	07.03-12.11	52		TW	0 986 473 125	↔ 54	
						0 986 474 125	↔ 54	
	1.4 i.e.	03.98-09.01	51		MIH ATE	0 986 473 125	↔ 54	
						0 986 474 125	↔ 54	
		07.03-12.11	57		TW ATE	0 986 473 125	↔ 54	
						0 986 474 125	↔ 54	
					BO	0 204 004 607	↔ 54	0 204 104 282 <sup>B</sup>
						0 204 004 608	↔ 54	0 204 104 282 <sup>B</sup>
						0 204 902 040	↔	0 204 104 370 <sup>B</sup>
						0 204 902 041	↔	0 204 104 370 <sup>B</sup>
	1.6 i.e. 16V	03.98-09.01	76		MIH ATE	0 986 473 125	↔ 54	
						0 986 474 125	↔ 54	
		07.01-02.04	74		MIH ATE	0 986 473 125	↔ 54	
						0 986 474 125	↔ 54	
		10.01-12.11	76			0 986 473 125	↔ 54	
						0 986 474 125	↔ 54	
	1.6 i.e. 16V Sport	10.01-12.11	76			0 986 473 125	↔ 54	
						0 986 474 125	↔ 54	
	1.2 i.e. 8V	11.99-09.01	54			0 986 475 966	↔ 19	
		03.00-12.00	54		Ricam.Nr →6230892	0 986 AB8 488	↔	
		05.00-08.02	44		Ricam.Nr 6230893→	0 986 475 966	↔ 19	
		01.01-12.11	44			0 986 475 966	↔ 19	
	1.2 i.e. 16V	10.01-12.11	59			0 986 475 966	↔ 19	
	1.3 JTD 16V	07.03-12.11	52			0 986 475 966	↔ 19	
	1.4 i.e.	03.98-09.01	51		Ricam.Nr 6230893→	0 986 475 966	↔ 19	
		07.03-12.11	57			0 986 475 966	↔ 19	
	1.6 i.e. 16V	03.98-09.01	76		Ricam.Nr 6230893→	0 986 475 966	↔ 19	
		10.01-12.11	76			0 986 475 966	↔ 19	
	1.6 i.e. 16V Sport	10.01-12.11	76			0 986 475 966	↔ 19	





FIAT Palio [178..]



	1.2 i.e. 8V	11.99-09.01	54		1987 477 724	↔ 1400
		05.00-08.02	44		1987 477 724	↔ 1400
		07.01-12.11	46	TW	1987 477 724	↔ 1400
		10.01-12.11	44	TW	1987 477 724	↔ 1400
	1.2 i.e. 16V	10.01-12.11	59	TW	1987 477 724	↔ 1400
	1.3 JTD 16V	07.03-12.11	52	TW	1987 477 724	↔ 1400
	1.4 i.e.	03.98-09.01	51		1987 477 724	↔ 1400
		07.03-12.11	57	TW	1987 477 724	↔ 1400
	1.6 i.e. 16V	03.98-09.01	76		1987 477 724	↔ 1400
		07.01-02.04	74		1987 477 724	↔ 1400
10.01-12.11		76	TW	1987 477 724	↔ 1400	
1.6 i.e. 16V Sport	10.01-12.11	76	TW	1987 477 724	↔ 1400	
1.9 D	01.03-06.05	48		1987 477 724	↔ 1400	

	1.2 i.e. 8V	11.99-09.01	54		0 265 006 249 <sup>4</sup>	
				LAB	0 265 006 163 <sup>3</sup>	
		09.00-08.02	44		0 265 006 164 <sup>3</sup>	
				RAB	0 265 006 164 <sup>3</sup>	
		01.01-08.02	44		0 265 006 249 <sup>4</sup>	
				LAB	0 265 006 163 <sup>3</sup>	
		07.01-12.11	46		0 265 007 051 <sup>4</sup>	
				LAB	0 265 007 102 <sup>3</sup>	
		10.01-12.11	44		0 265 007 103 <sup>3</sup>	
				RAB	0 265 007 103 <sup>3</sup>	
	1.2 i.e. 16V	10.01-12.11	59		0 265 007 051 <sup>4</sup>	
				LAB	0 265 007 102 <sup>3</sup>	
	1.3 JTD 16V	07.03-12.11	52		0 265 007 103 <sup>3</sup>	
				RAB	0 265 007 103 <sup>3</sup>	
	1.4 i.e.	03.98-09.01	51		0 265 007 051 <sup>4</sup>	
				LAB	0 265 006 249 <sup>4</sup>	
		07.03-12.11	57		0 265 006 163 <sup>3</sup>	
				RAB	0 265 006 164 <sup>3</sup>	
	1.6 i.e. 16V	03.98-09.01	76		0 265 007 051 <sup>4</sup>	
				LAB	0 265 007 102 <sup>3</sup>	
07.01-02.04		74		0 265 006 163 <sup>3</sup>		
			RAB	0 265 006 164 <sup>3</sup>		
10.01-12.11	76		0 265 007 051 <sup>4</sup>			
		LAB	0 265 007 102 <sup>3</sup>			
1.6 i.e. 16V Sport	10.01-12.11	76		0 265 007 103 <sup>3</sup>		
1.6 i.e. 16V	10.01-12.11	76	LAB	0 265 007 102 <sup>3</sup>		
1.6 i.e. 16V Sport			RAB	0 265 007 103 <sup>3</sup>		
1.9 D	01.03-06.05	48		0 265 007 051 <sup>4</sup>		
			LAB	0 265 007 102 <sup>3</sup>		
			RAB	0 265 007 103 <sup>3</sup>		





























Panda Cross [312]



	0.9 4x4	09.14→	66		1987 482 527	→ 1550
					1987 482 528	← 1548
	1.3 Multijet 4x4	09.14→	59		1987 482 527	→ 1550
					1987 482 528	← 1548



**Panda [141..]**

Model	Period	Days	Code	Part No.	Qty	Notes
						
 <b>750 fire</b>	07.90-03.03	25	MIH	0 204 102 447	← 48	
				0 986 474 999		
				0 204 102 448	→ 48	
				0 986 473 999		
			MIH	0 204 102 447	← 48	0 204 104 184
				0 986 473 104		
				0 204 102 448	→ 48	0 204 104 184
				0 986 474 104		
<b>900 i.e.</b>	04.92-09.03	29	MIH	0 204 102 447	← 48	
				0 986 474 999		
				0 204 102 448	→ 48	
				0 986 473 999		
			MIH	0 204 102 447	← 48	0 204 104 184
				0 986 473 104		
				0 204 102 448	→ 48	0 204 104 184
				0 986 474 104		
<b>1000</b> <b>1000 i.e.</b>	07.90-09.03	33	MIH	0 204 102 447	← 48	
				0 986 474 999		
				0 204 102 448	→ 48	
				0 986 473 999		
			MIH	0 204 102 447	← 48	0 204 104 184
				0 986 473 104		
				0 204 102 448	→ 48	0 204 104 184
				0 986 474 104		
<b>1000 Selecta</b>	07.90-03.97	35	MIH	0 204 102 548	← 48	
				0 204 102 549	→ 48	
			MIH	0 204 102 524	← 48	
				0 204 103 524		
				0 204 102 525	→ 48	
				0 204 103 525		
<b>1000 4x4</b>	07.90-12.95	37	MIH	0 204 102 447	← 48	
				0 986 474 999		
				0 204 102 448	→ 48	
				0 986 473 999		
			MIH	0 204 102 447	← 48	0 204 104 184
				0 986 473 104		
				0 204 102 448	→ 48	0 204 104 184
				0 986 474 104		
<b>1100 i.e.</b>	01.93-03.97	37	MIH	0 204 102 447	← 48	0 204 104 184
				0 986 473 104		
				0 204 102 448	→ 48	0 204 104 184
				0 986 474 104		
	12.00-09.03	37	MIH	0 204 102 447	← 48	0 204 104 184
				0 986 473 104		
				0 204 102 448	→ 48	0 204 104 184
				0 986 474 104		
<b>1100 i.e. Selecta</b>	01.93-03.97	37	MIH	0 204 102 548	← 48	
				0 204 102 549	→ 48	
			MIH	0 204 102 524	← 48	
				0 204 103 524		
				0 204 102 525	→ 48	
				0 204 103 525		
	01.95-09.03	40	MIH	0 204 102 548	← 48	
				0 204 102 549	→ 48	
			MIH	0 204 102 524	← 48	0 204 104 234 <sup>7</sup>
				0 204 103 524		
				0 204 102 525	→ 48	0 204 104 234 <sup>7</sup>
				0 204 103 525		





		S							
<b>FIAT Panda [141..]</b>									
	1100 i.e. 4x4	01.93-12.94	37			MIH	0 204 102 447	← 48	0 204 104 184
							0 986 473 104		
							0 204 102 448	→ 48	0 204 104 184
							0 986 474 104		
		12.00-09.03	37			MIH	0 204 102 447	← 48	0 204 104 184
							0 986 473 104		
							0 204 102 448	→ 48	0 204 104 184
							0 986 474 104		
	1100 i.e.	01.93-03.97	37			MIH	0 204 102 447	← 48	
	1100 i.e. 4x4						0 986 474 999		
							0 204 102 448	→ 48	
							0 986 473 999		
		01.95-09.03	40			MIH	0 204 102 447	← 48	
							0 986 474 999		
							0 204 102 448	→ 48	
						MIH	0 204 102 447	← 48	0 204 104 184
							0 986 473 104		
							0 204 102 448	→ 48	0 204 104 184
							0 986 474 104		
	750 fire	07.90-03.03	25				F 026 002 454	↔ 19,05	
	900 i.e.	04.92-09.03	29				F 026 002 454	↔ 19,05	
	1000, i.e., Selecta, 4x4	07.90-09.03	33/35/37				F 026 002 454	↔ 19,05	
	1100 i.e., i.e. Selecta, i.e. 4x4	01.93-09.03	37/40				F 026 002 454	↔ 19,05	
	750 fire	07.90-03.03	25				1 987 477 331		2385
	900 i.e.	04.92-09.03	29				1 987 477 331		2385
	1000, i.e., Selecta	07.90-09.03	33/35				1 987 477 331		2385
	1000 4x4	07.90-12.95	37				1 987 477 086		2668
	1100 i.e.	01.93-03.97	37				1 987 477 651		2385
		12.00-09.03	37				1 987 477 331		2385
	1100 i.e. Selecta	01.93-03.97	37				1 987 477 651		2385
	1100 i.e. 4x4	01.93-12.94	37				1 987 477 651		2385
		12.00-09.03	37				1 987 477 651		2385
	1100 i.e., i.e. Selecta, i.e. 4x4	01.95-09.03	40				1 987 477 651		2385
<b>Panda [169..]</b>									
	1.1	01.09-12.11	39				0 204 902 090	→ 48	
							0 986 135 007		
							0 986 134 007		
	1.1 i.e.	10.03-07.07	40				0 204 102 494	← 48	0 204 104 203 <sup>7</sup>
							0 204 103 494		
							0 204 103 822		
							0 204 102 495	→ 48	0 204 104 203 <sup>7</sup>
							0 204 103 495		
							0 986 135 007		
		08.07-12.09	40				0 204 902 090	→ 48	
							0 986 135 007		
	1.2	01.09-12.11	44				0 986 134 007		← 48
		09.10-12.12	51				0 204 902 090	→ 48	
							0 986 135 007		
							0 986 134 007		← 48
	1.2	08.07-12.11	44				0 204 902 090	→ 48	
	1.2 i.e.						0 986 135 007		

		S							
1.2 i.e.	10.03-07.07	44					0 204 102 494 0 204 103 494 0 204 103 822	← 48  	0 204 104 203 <sup>7</sup>
							0 204 102 495 0 204 103 495 0 986 135 007	→ 48  	0 204 104 203 <sup>7</sup>
1.2 i.e. LPG	12.06-12.09	38-44					0 204 902 090 0 986 135 007	→ 48 	
1.2 i.e. Natural Power	12.06-07.07	38-44					0 986 473 429 0 986 474 429	← 48 → 48	
	08.07-12.09	38-44					0 204 902 064 0 204 902 065	← →	
1.2 i.e. 4x4	10.04-07.07	44					0 986 473 429 0 986 474 429	← 48 → 48	
	08.07-12.09	44					0 204 902 064 0 204 902 065	← →	
1.2 Natural Power	01.09-12.10	38					0 204 902 064 0 204 902 065	← →	
1.2 4x4	09.10-12.12	51					0 204 902 064 0 204 902 065	← →	
1.3 JTD	01.04-07.07	52					0 986 473 429 0 986 474 429	← 48 → 48	
	05.06-07.07	55					0 986 473 429 0 986 474 429	← 48 → 48	
	08.07-12.09	52					0 204 902 064 0 204 902 065	← →	
		55					0 204 902 064 0 204 902 065	← →	
	01.09-09.10	52				PAJ	0 204 902 064 0 204 902 065	← →	
1.3 JTD	01.09-09.10	52				PAJ	0 204 902 032	← 54	
1.3 JTD 4x4							0 986 473 487		
1.3 JTD 4x4	09.05-12.09	52		Ricam.Nr →971810		MOJ	0 204 902 018 0 204 902 019	← →	
						MOJ	0 204 902 119 0 986 473 487	← 54 	
							0 204 902 120 0 986 474 487	→ 54 	
				Ricam.Nr 971811→		MOJ	0 204 902 119 0 986 473 487	← 54 	
							0 204 902 120 0 986 474 487	→ 54 	
	01.09-09.10	52				PAJ	0 204 902 119 0 986 473 487	← 54 	
							0 204 902 120 0 986 474 487	→ 54 	
1.3 Multijet	03.10-12.12	55					0 204 902 064 0 204 902 065	← →	
1.3 Multijet 4x4	03.10-12.12	55					0 204 902 119 0 986 473 487 0 986 474 487	← 54  → 54	
1.4	01.09-09.10	74				PAJ	0 204 902 032 0 986 473 487	← 54 	
						PAJ	0 204 902 119 0 986 473 487	← 54 	
							0 204 902 120 0 986 474 487	→ 54 	
1.4 i.e. 16V	10.06-12.09	74		Ricam.Nr →971810		PAJ	0 204 004 564 0 986 473 487 0 204 004 565 0 986 474 487	← 54  → 54 	

















			S							
1.4 i.e. 16V			10.06-12.09	74	Ricam.Nr 971811→	PAJ	0 204 902 066	←	54	
						PAJ	0 986 473 487	↔		
							0 204 902 119	←	54	
							0 986 473 487	↔		
							0 204 902 120	→	54	
							0 986 474 487	↔		
1.4 Natural Power			09.10-12.12	51-57			0 204 902 064	←		
							0 204 902 065	→		
1.1	ABS		01.09-05.10	39		BSY	F 026 002 474	↔	20,64	
			06.10-12.11	39		LOC	0 986 475 974	↔	20,64	
1.1, i.e.	ABO		10.03-12.11	39/40		LOC	0 986 475 816	↔	20,64	
1.1 i.e.	ABS		10.03-12.09	40		BSY	F 026 002 474	↔	20,64	
1.2	ABS		06.10-12.11	44		LOC	0 986 475 974	↔	20,64	
			09.10-12.12	51		LOC	0 986 475 974	↔	20,64	
1.2	ABO		10.03-12.12	44/51		LOC	0 986 475 816	↔	20,64	
1.2 i.e.	ABS		10.03-05.10	44		BSY	F 026 002 474	↔	20,64	
1.2 i.e. Natural Power, Natural Power			12.06-12.10	38-44			0 986 475 936	↔	20,64	
1.3 JTD	ABO		01.04-09.10	52/55		LOC	0 986 475 816	↔	20,64	
	ABS		01.04-05.10	52		BSY	F 026 002 474	↔	20,64	
			05.06-12.09	55		BSY	F 026 002 474	↔	20,64	
			06.10-09.10	52		LOC	0 986 475 974	↔	20,64	
1.3 Multijet			03.10-12.12	55		LOC	0 986 475 974	↔	20,64	
1.4 Natural Power			09.10-12.12	51-57			0 986 475 936	↔	20,64	
1.1			01.09-12.11	39			1 987 482 199	→	1450	
							1 987 482 200	←	1425	
1.1 i.e.			10.03-12.09	40			1 987 477 926	→	1435	
							1 987 477 927	←	1405	
1.2			01.09-12.11	44			1 987 482 199	→	1450	
							1 987 482 200	←	1425	
			09.10-12.12	51			1 987 482 199	→	1450	
							1 987 482 200	←	1425	
1.2 i.e.			10.03-12.09	44			1 987 477 926	→	1435	
							1 987 477 927	←	1405	
1.2 i.e. LPG			12.06-12.09	38-44			1 987 477 926	→	1435	
							1 987 477 927	←	1405	
1.2 i.e. Natural Power			12.06-12.09	38-44			1 987 482 236	→	1457	
							1 987 482 237	←	1437	
1.2 i.e. 4x4			10.04-12.09	44			1 987 477 970	→	1471	
							1 987 477 971	←	1485	
1.2 Natural Power			01.09-12.10	38			1 987 482 236	→	1457	
							1 987 482 237	←	1437	
1.2 4x4			09.10-12.12	51			1 987 477 970	→	1471	
							1 987 477 971	←	1485	
1.3 JTD			01.04-12.09	52			1 987 477 926	→	1435	
							1 987 477 927	←	1405	
			05.06-12.09	55			1 987 482 389	→	1430	
							1 987 482 390	←	1403	
			01.09-09.10	52			1 987 482 199	→	1450	
							1 987 482 200	←	1425	
1.3 JTD 4x4			09.05-09.10	52			1 987 477 970	→	1471	
							1 987 477 971	←	1485	
1.3 Multijet			03.10-12.12	55			1 987 482 389	→	1430	
							1 987 482 390	←	1403	
1.3 Multijet 4x4			03.10-12.12	55			1 987 477 970	→	1471	
							1 987 477 971	←	1485	
1.4			10.06-09.10	74			1 987 482 201	→	1506	
1.4 i.e. 16V							1 987 482 202	←	1491	

		S							
1.4 Natural Power		09.10-12.12	51-57				1 987 482 236	→ 1457	
							1 987 482 237	← 1437	
1.1		01.09-12.11	39				0 265 007 448 <sup>3</sup>		
						VSP	0 265 008 005 <sup>4</sup>		
						VSP	0 265 007 711 <sup>4</sup>		
1.1 i.e.		10.03-12.09	40				0 265 007 448 <sup>3</sup>		
							0 265 008 005 <sup>4</sup>		
1.2		01.09-12.11	44			VSP	0 265 008 005 <sup>4</sup>		
						VSP	0 265 007 711 <sup>4</sup>		
		09.10-12.12	51				0 265 007 448 <sup>3</sup>		
							0 265 008 005 <sup>4</sup>		
1.2, i.e.		10.03-12.11	44				0 265 007 448 <sup>3</sup>		
1.2 i.e.		10.03-12.09	44				0 265 008 005 <sup>4</sup>		
1.2 i.e. LPG		12.06-12.09	38-44				0 265 007 448 <sup>3</sup>		
							0 265 008 005 <sup>4</sup>		
1.2 i.e. Natural Power		12.06-12.09	38-44				0 265 007 639 <sup>3</sup>		
							0 265 008 035 <sup>4</sup>		
1.2 i.e. 4x4		10.04-12.09	44				0 265 007 639 <sup>3</sup>		
							0 265 008 006 <sup>4</sup>		
1.2 Natural Power		01.09-12.10	38			VSP	0 265 007 639 <sup>3</sup>		
							0 265 008 035 <sup>4</sup>		
						VSP	0 265 007 448 <sup>3</sup>		
							0 265 007 711 <sup>4</sup>		
1.2 4x4		09.10-12.12	51				0 265 007 639 <sup>3</sup>		
							0 265 008 006 <sup>4</sup>		
1.3 JTD		01.04-12.09	52				0 265 008 005 <sup>4</sup>		
		01.04-09.10	52				0 265 007 448 <sup>3</sup>		
		05.06-12.09	55				0 265 007 448 <sup>3</sup>		
							0 265 008 005 <sup>4</sup>		
		01.09-09.10	52			VSP	0 265 008 005 <sup>4</sup>		
						VSP	0 265 007 711 <sup>4</sup>		
1.3 JTD 4x4		09.05-09.10	52				0 265 007 639 <sup>3</sup>		
							0 265 008 006 <sup>4</sup>		
1.3 Multijet		03.10-12.12	55				0 265 007 448 <sup>3</sup>		
							0 265 008 005 <sup>4</sup>		
1.3 Multijet 4x4		03.10-12.12	55				0 265 007 639 <sup>3</sup>		
							0 265 008 006 <sup>4</sup>		
1.4		10.06-09.10	74				0 265 007 448 <sup>3</sup>		
1.4 i.e. 16V							0 265 007 711 <sup>4</sup>		
1.4 Natural Power		09.10-12.12	51-57				0 265 007 639 <sup>3</sup>		
							0 265 008 035 <sup>4</sup>		
<b>Panda [169]</b>									
1.2 LPG		01.09-12.12	44				0 204 902 090	→ 48	
							0 986 135 007		
							0 986 134 007	← 48	
1.2 4x4		01.09-12.10	44				0 204 902 064	←	
							0 204 902 065	→	
1.2 LPG	ABO	01.09-12.12	44			LOC	0 986 475 816	↔ 20,64	
	ABS	01.09-05.10	44			BSY	F 026 002 474	↔ 20,64	
		06.10-12.12	44			LOC	0 986 475 974	↔ 20,64	
1.2 LPG		01.09-12.12	44				1 987 482 199	→ 1450	
							1 987 482 200	← 1425	



		S							
	◀ FIAT Panda [169]								
	1.2 4x4	01.09-12.10	44				1987 477 970	→ 1471	
							1987 477 971	← 1485	
	1.2 LPG	01.09-12.12	44			VSP	0 265 008 005 <sup>4</sup>		
						TW	0 265 007 448 <sup>3</sup>		
							0 265 007 639 <sup>3</sup>		
						VSP	0 265 007 711 <sup>4</sup>		
	1.2 4x4	01.09-12.10	44				0 265 007 639 <sup>3</sup>		
							0 265 008 006 <sup>4</sup>		
<b>Panda [312..]</b>									
	0.9, Natural Power	02.12→	44/48/57-63				0 986 475 936	↔ 20,64	
	1.2, LPG	02.12→	51				0 986 475 936	↔ 20,64	
	1.3	02.12→	55				0 986 475 936	↔ 20,64	
	0.9	02.12→	44/48/				1 987 482 391	→ 1437	
	0.9 Natural Power		57-63				1 987 482 392	← 1427	
	0.9 4x4	06.12→	63				1 987 482 527	→ 1550	
							1 987 482 528	← 1548	
	1.2	02.12→	51				1 987 482 391	→ 1437	
	1.2 LPG						1 987 482 392	← 1427	
	1.3	02.12→	55				1 987 482 391	→ 1437	
							1 987 482 392	← 1427	
	1.3 Multijet 4x4	06.12→	55				1 987 482 527	→ 1550	
							1 987 482 528	← 1548	
<b>Petra [172..]</b>									
	1.2 i.e. 8V	04.04-06.06	44				1 987 477 724	↔ 1400	
<b>Punto Cabrio [176]</b>									
	60 1.2 i.e.	05.95-04.97	43			AG,MIH	0 204 102 550	← 48	
							0 204 102 551	→ 48	
						AG,MIH	0 204 102 524	← 48	
							0 204 103 524		
							0 204 102 525	→ 48	
							0 204 103 525		
		05.97-03.98	44			GS,MIH	0 204 102 492	← 48	
							0 204 103 494		
							0 986 134 007		
							0 204 102 493	→ 48	
							0 204 103 495		
							0 986 135 007		
		05.97-08.99	44			AG,MIH			0 204 104 208 <sup>8</sup>
						GS,MIH	0 204 102 494	← 48	0 204 104 203 <sup>7</sup>
							0 204 103 494		
							0 204 103 822		
							0 204 102 495	→ 48	0 204 104 203 <sup>7</sup>
							0 204 103 495		
							0 986 135 007		

								
60 1.2 i.e.	ABO	04.94-04.97	44		MIH	0 204 <b>102 492</b> 0 204 <b>103 494</b> 0 986 <b>134 007</b>	← 48 ↻ ↻	0 204 <b>104 203</b> <sup>7</sup>
		05.95-04.97	43		GS,MIH	0 204 <b>102 492</b> 0 204 <b>103 494</b> 0 986 <b>134 007</b>	← 48 ↻ ↻	0 204 <b>104 203</b> <sup>7</sup>
	ABS	04.94-12.94	44			0 204 <b>102 493</b> 0 204 <b>103 495</b> 0 986 <b>135 007</b>	→ 48 ↻ ↻	0 204 <b>104 203</b> <sup>7</sup>
		01.95-04.97	44		GS,MIH	0 204 <b>102 524</b> 0 204 <b>103 524</b>	← 48 ↻	
		05.95-04.97	43		GS,MIH	0 204 <b>102 525</b> 0 204 <b>103 525</b>	→ 48 ↻	0 204 <b>104 234</b> <sup>7</sup>
		05.95-04.97	43		GS,MIH	0 204 <b>102 524</b> 0 204 <b>103 524</b>	← 48 ↻	
		05.95-04.97	43		GS,MIH	0 204 <b>102 525</b> 0 204 <b>103 525</b>	→ 48 ↻	
85 1.2 i.e. 16V		05.97-08.99	63		MIH			0 204 <b>104 208</b> <sup>8</sup>
90 1.6 i.e.		04.94-04.97	65		MIH	0 204 <b>102 550</b> 0 204 <b>102 551</b>	← 48 → 48	
					MIH	0 204 <b>102 524</b> 0 204 <b>103 524</b>	← 48 ↻	0 204 <b>104 234</b> <sup>7</sup>
						0 204 <b>102 525</b> 0 204 <b>103 525</b>	→ 48 ↻	0 204 <b>104 234</b> <sup>7</sup>
								
	60 1.2 i.e.	04.94-08.99	43/44		BSY	F 026 <b>002 157</b>	↔ 20,6	
					LOC	0 986 <b>475 816</b>	↔ 20,64	
	85 1.2 i.e. 16V	05.97-08.99	63		BSY	F 026 <b>002 157</b>	↔ 20,6	
					LOC	0 986 <b>475 816</b>	↔ 20,64	
	90 1.6 i.e.	04.94-04.97	65		LOC	0 986 <b>475 816</b>	↔ 20,64	
								
	60 1.2 i.e.	04.94-08.99	43/44			1 987 <b>477 383</b>	→ 1469	
						1 987 <b>477 384</b>	← 1456	
	85 1.2 i.e. 16V	05.97-08.99	63			1 987 <b>477 383</b>	→ 1469	
						1 987 <b>477 384</b>	← 1456	
	90 1.6 i.e.	04.94-04.97	65			1 987 <b>477 383</b>	→ 1469	
						1 987 <b>477 384</b>	← 1456	
	60 1.2 i.e.	04.94-08.99	43/44		LAB	0 265 <b>006 139</b> <sup>4</sup>		
					RAB	0 265 <b>006 140</b> <sup>4</sup>		
					ZE	0 265 <b>001 387</b> <sup>3</sup>		
	85 1.2 i.e. 16V	05.97-08.99	63		LAB	0 265 <b>006 139</b> <sup>4</sup>		
					RAB	0 265 <b>006 140</b> <sup>4</sup>		
					ZE	0 265 <b>001 387</b> <sup>3</sup>		
	90 1.6 i.e.	04.94-04.97	65		LAB	0 265 <b>006 139</b> <sup>4</sup>		
					RAB	0 265 <b>006 140</b> <sup>4</sup>		
					ZE	0 265 <b>001 387</b> <sup>3</sup>		



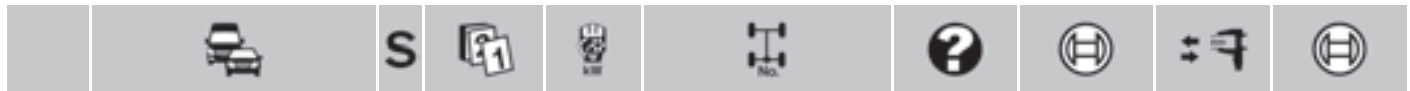

FIAT

Punto Evo [199]



	1.2 8V	10.09-04.10	48	BSR	0 204 902 119	← 54
					0986 473 487	→ 54
					0 204 902 120	→ 54
					0986 474 487	→ 54
		10.09-12.11	48	BSR	0986 473 487	← 54
		09.10-12.11	50-51	BSR	0986 473 487	← 54
	1.3 Multijet	10.09-04.10	51/55	BSR	0 204 902 119	← 54
					0986 473 487	→ 54
					0 204 902 120	→ 54
					0986 474 487	→ 54
		10.09-12.11	51/55	BSR	0986 473 487	← 54
			62/66/		0 204 004 566	← 54
			70-93		0986 134 077	→ 54
		05.10-12.11	55-56	BSR	0986 473 487	← 54
	1.4 LPG	10.09-04.10	55/56-66/	BSR	0 204 902 119	← 54
	1.4 16V		77		0986 473 487	→ 54
	1.4 8V				0 204 902 120	→ 54
	1.4 8V Natural				0986 474 487	→ 54
		10.09-12.11	55/56-66/77	BSR	0986 473 487	← 54
	1.4 16V	12.09-12.11	99	BSR	0 204 004 566	← 54
					0986 134 077	→ 54
	1.6 Multijet	10.09-12.11	88	BSR	0 204 004 566	← 54
					0986 134 077	→ 54



	1.2 8V	10.09-12.11	48/50-51		0986 475 936	↔ 20,64
	1.3 Multijet	10.09-12.11	51/55-56/62/66/70-93		0986 475 936	↔ 20,64
	1.4 LPG, 16V, 8V, 8V Natural	10.09-12.11	55/56-66/77/99		0986 475 936	↔ 20,64
	1.6 Multijet	10.09-12.11	88		0986 475 936	↔ 20,64



	1.2 8V	10.09-12.11	48/50-51		1987 477 973	→ 1660
					1987 477 974	← 1642
	1.3 Multijet	10.09-12.11	51/55-56/62/66/70-93		1987 477 975	→ 1689
					1987 477 976	← 1674
					1987 477 975	→ 1689
	1.4 LPG	10.09-12.11	55/56-66/	HTB	1987 477 976	← 1674
	1.4 16V		77/99		1987 477 977	→ 1673
	1.4 8V			4SB	1987 477 978	← 1654
	1.4 8V Natural				1987 477 977	→ 1673
	1.6 Multijet	10.09-12.11	88		1987 477 978	← 1654
					1987 477 977	→ 1673



1.2 8V	10.09-12.11	48/50-51			0 265 004 136 <sup>3</sup>		
					HTB	0 265 007 896 <sup>4</sup>	
					4SB	0 265 007 769 <sup>4</sup>	
1.3 Multijet	10.09-12.11	51/55-56/62/66/70-93				0 265 004 136 <sup>3</sup>	
					HTB	0 265 007 896 <sup>4</sup>	
					4SB	0 265 007 769 <sup>4</sup>	
1.4 Abarth	06.10-12.12	120			0 265 004 136 <sup>3</sup>		
					0 265 007 769 <sup>4</sup>		
1.4 LPG, 16V, 8V, 8V Natural	10.09-12.11	55/56-66/77/99				0 265 004 136 <sup>3</sup>	
					HTB	0 265 007 896 <sup>4</sup>	
					4SB	0 265 007 769 <sup>4</sup>	
1.6 Multijet	10.09-12.11	88				0 265 004 136 <sup>3</sup>	
					HTB	0 265 007 896 <sup>4</sup>	
					4SB	0 265 007 769 <sup>4</sup>	

		S							
<b>Punto Grande Abarth SS [199]</b>									
	1.4	10.07-12.10	132			BSR, TW	0 204 004 568	← 36	
							0 986 134 342		
							0 204 004 569	→ 36	
							0 986 135 342		
						BSR, TW	0 204 902 070	←	
							0 204 902 071	→	
	1.4	10.07-12.10	132				1 987 477 977	→ 1673	
							1 987 477 978	← 1654	
	1.4	10.07-12.10	132				0 265 004 136 <sup>3</sup>		
							0 265 007 769 <sup>4</sup>		
<b>Punto Grande Abarth [199]</b>									
	1.4	10.07-12.10	114			BSR, TW	0 204 004 568	← 36	
							0 986 134 342		
							0 204 004 569	→ 36	
							0 986 135 342		
						BSR, TW	0 204 902 070	←	
							0 204 902 071	→	
	1.4	10.07-12.10	114				1 987 477 977	→ 1673	
							1 987 477 978	← 1654	
	1.4	10.07-12.10	114				0 265 004 136 <sup>3</sup>		
							0 265 007 769 <sup>4</sup>		
<b>Punto Grande [199]</b>									
	1.2	10.05-12.11	48			TW	0 204 902 030	←	
							0 204 902 031	→	
							0 204 902 119	← 54	
							0 986 473 487		
							0 986 474 487	→ 54	
		09.10-12.11	51				0 204 902 119	← 54	
							0 986 473 487		
							0 204 902 120	→ 54	
							0 986 474 487		
	1.3 Multijet	10.05-12.09	66				0 204 004 566	← 54	
							0 986 134 077		
							0 204 004 567	→ 54	
							0 986 135 077		
	1.3 Multijet	10.05-12.11	55				0 204 902 119	← 54	
							0 986 473 487		
							0 986 474 487	→ 54	
	1.4	06.07-12.09	88				0 204 004 566	← 54	
							0 986 134 077		
							0 204 004 567	→ 54	
							0 986 135 077		
	1.4	10.05-12.11	55/56/57/				0 204 902 119	← 54	
	1.4 CNG		70				0 986 473 487		
	1.4 LPG						0 986 474 487	→ 54	





		S							
	◀ FIAT Punto Grande [199]								
	1.6 Multijet	08.08-12.09	88				0 204 004 566	←	54
							0 986 134 077		
	1.9 Multijet	10.05-12.09	85/88/96				0 204 004 567	→	54
							0 986 135 077		
	1.2	10.05-12.11	48/51				0 986 475 936	↔	20,64
	1.3 Multijet, Multijet	10.05-12.11	55/66				0 986 475 936	↔	20,64
	1.4, CNG, LPG	10.05-12.11	55/56/57/70				0 986 475 936	↔	20,64
	1.4	03.06-12.11	56/70/88				0 204 004 568	←	36
							0 986 134 342		
	1.4 CNG						0 204 004 569	→	36
							0 986 135 342		
	1.6 Multijet	08.08-12.09	88				0 204 004 568	←	36
							0 986 134 342		
	1.9 Multijet	10.05-12.09	85/88/96				0 204 004 569	→	36
							0 986 135 342		
	1.6 Multijet	08.08-12.09	88				0 204 004 568	←	36
							0 986 134 342		
	1.9 Multijet	10.05-12.09	85/88/96				0 204 004 568	←	36
							0 986 134 342		
	1.9 Multijet	10.05-12.09	85/88/96				0 204 004 569	→	36
							0 986 135 342		
	1.2	10.05-12.11	48/51				1 987 477 973	→	1660
							1 987 477 974	←	1642
	1.3 Multijet	10.05-12.11	55/66				1 987 477 975	→	1689
							1 987 477 976	←	1674
	1.3 Multijet	10.05-12.11	57				1 987 477 975	→	1689
							1 987 477 976	←	1674
	1.4	10.05-12.11	70		HTB		1 987 477 975	→	1689
							1 987 477 976	←	1674
	1.4	03.06-12.09	70		4SB		1 987 477 977	→	1673
							1 987 477 978	←	1654
	1.4	06.06-12.11	55				1 987 477 975	→	1689
							1 987 477 976	←	1674
	1.4	06.07-12.09	88				1 987 477 977	→	1673
							1 987 477 978	←	1654
	1.4 CNG	09.08-12.11	56		HTB		1 987 477 975	→	1689
							1 987 477 976	←	1674
	1.4 CNG	09.08-12.11	56		4SB		1 987 477 977	→	1673
							1 987 477 978	←	1654
	1.4 LPG	09.08-12.11	56				1 987 477 975	→	1689
							1 987 477 976	←	1674
	1.6 Multijet	08.08-12.09	88				1 987 477 977	→	1673
							1 987 477 978	←	1654
	1.9 Multijet	10.05-12.09	85/88/96				1 987 477 977	→	1673
							1 987 477 978	←	1654
	1.2	10.05-12.11	48/51				0 265 004 136 <sup>3</sup>		
							0 265 007 896 <sup>4</sup>		
	1.3 Multijet	10.05-12.11	55/66				0 265 004 136 <sup>3</sup>		
							0 265 007 896 <sup>4</sup>		
	1.3 Multijet	10.05-12.11	57				0 265 004 136 <sup>3</sup>		
							0 265 007 896 <sup>4</sup>		

		S							
1.4		03.06-12.09	70/88						0 265 004 136 <sup>3</sup>
							HTB		0 265 007 896 <sup>4</sup>
		06.06-12.11	55						0 265 007 769 <sup>4</sup>
									0 265 004 136 <sup>3</sup>
1.4 CNG		09.08-12.11	56						0 265 007 896 <sup>4</sup>
							4SB		0 265 007 769 <sup>4</sup>
1.4 CNG, LPG		09.08-12.11	56						0 265 004 136 <sup>3</sup>
1.4 LPG		09.08-12.11	56						0 265 007 896 <sup>4</sup>
1.6 Multijet		08.08-12.09	88						0 265 004 136 <sup>3</sup>
									0 265 007 769 <sup>4</sup>
1.9 Multijet		10.05-12.09	88/96						0 265 004 136 <sup>3</sup>
									0 265 007 769 <sup>4</sup>
									0 265 004 136 <sup>3</sup>
									0 265 007 896 <sup>4</sup>
		06.06-12.08	85						0 265 004 136 <sup>3</sup>
							HTB		0 265 007 896 <sup>4</sup>
							4SB		0 265 007 769 <sup>4</sup>

**Punto GT [176]**



























	1.4 i.e. Turbo	08.93-04.97	98			MIH			0 204 102 544	← 54	0 204 104 237 <sup>7</sup>		
									0 204 103 532				
									0 204 102 545	→ 54	0 204 104 237 <sup>7</sup>		
									0 204 103 533				
									MIH		0 204 102 532	← 54	0 204 104 234 <sup>7</sup>
											0 204 103 532		
		03.96-04.97	96			MIH			0 204 102 544	← 54	0 204 104 237 <sup>7</sup>		
									0 204 103 532				
									0 204 102 545	→ 54	0 204 104 237 <sup>7</sup>		
									0 204 103 533				
									MIH		0 204 102 532	← 54	0 204 104 234 <sup>7</sup>
											0 204 103 532		
05.97-08.99	96			MIH			0 204 102 533	→ 54	0 204 104 234 <sup>7</sup>				
							0 204 103 533						
							0 204 902 103	← 54	0 204 104 208 <sup>8</sup>				
							0 204 103 502						
							0 204 902 104	→ 54	0 204 104 208 <sup>8</sup>				
							0 204 103 503						
		Ricam.Nr 26126→		MIH			0 204 102 570	← 54	0 204 104 208 <sup>8</sup>				
							0 204 102 571	→ 54	0 204 104 208 <sup>8</sup>				

	1.4 i.e. Turbo	08.93-02.94	98						0 986 471 009	→ 34	1 987 470 028 <sup>7</sup>		
									0 986 471 010	← 34	1 987 470 028 <sup>7</sup>		
		03.94-07.95	98			Ricam.Nr →0209360					0 986 471 010	← 34	1 987 470 028 <sup>7</sup>
											0 986 473 077		
		08.95-04.97	98			Ricam.Nr 0209361→					0 986 473 121	← 33,9	1 987 470 028 <sup>7</sup>
											0 986 474 121	→ 33,9	1 987 470 028 <sup>7</sup>
03.96-04.97	96			Ricam.Nr 0209361→					0 986 473 121	← 33,9	1 987 470 028 <sup>7</sup>		
									0 986 474 121	→ 33,9	1 987 470 028 <sup>7</sup>		

	1.4 i.e. Turbo	08.93-08.99	96/98						1 987 477 730	↔ 1527	
									LAB		0 265 006 139 <sup>4</sup>
									RAB		0 265 006 140 <sup>4</sup>
									ZE		0 265 001 387 <sup>3</sup>



			S							
◀ FIAT										
<b>Punto Van [276]</b>										
	1.1 i.e.	05.97-08.99	40			MIH	0 204 102 492	← 48		
							0 204 103 494			
							0 986 134 007			
							0 204 102 493	→ 48		
							0 204 103 495			
							0 986 135 007			
						MIH	0 204 102 494	← 48	0 204 104 203 <sup>7</sup>	
							0 204 103 494			
							0 204 103 822			
							0 204 102 495	→ 48	0 204 104 203 <sup>7</sup>	
							0 204 103 495			
							0 986 135 007			
	1.7 D	05.97-08.99	42			MIH	0 204 102 492	← 48		
							0 204 103 494			
							0 986 134 007			
							0 204 102 493	→ 48		
							0 204 103 495			
							0 986 135 007			
						MIH	0 204 102 494	← 48	0 204 104 203 <sup>7</sup>	
							0 204 103 494			
							0 204 103 822			
							0 204 102 495	→ 48	0 204 104 203 <sup>7</sup>	
							0 204 103 495			
							0 986 135 007			
	1.7 TD, TD SOFT	05.97-08.99	46/51/53			MIH				0 204 104 208 <sup>8</sup>
	1.1 i.e.	05.97-08.99	40			BSY	F 026 002 157	↔ 20,6		
						LOC	0 986 475 816	↔ 20,64		
	1.7 D, TD, TD SOFT	ABO 05.97-08.99	42/46/51/53				F 026 002 558	↔ 20,64		
		ABS 05.97-08.99	42/46/51/53			BSY	F 026 002 157	↔ 20,6		
	1.1 i.e.	05.97-08.99	40				1 987 477 383	→ 1469		
							1 987 477 384	← 1456		
	1.7 D, TD, TD SOFT	05.97-08.99	42/46/53				1 987 477 383	→ 1469		
							1 987 477 384	← 1456		
	1.1 i.e.	05.97-08.99	40			LAB	0 265 006 139 <sup>4</sup>			
						RAB	0 265 006 140 <sup>4</sup>			
						ZE	0 265 001 387 <sup>3</sup>			
	1.7 D	05.97-08.99	42/46/51/			LAB	0 265 006 139 <sup>4</sup>			
	1.7 TD		53			RAB	0 265 006 140 <sup>4</sup>			
	1.7 TD SOFT					ZE	0 265 001 387 <sup>3</sup>			
<b>Punto Van [288]</b>										
	1.2 Bipower	07.03-12.10	44				0 204 102 494	← 48	0 204 104 203 <sup>7</sup>	
							0 204 103 494			
							0 204 103 822			
							0 204 102 495	→ 48	0 204 104 203 <sup>7</sup>	
							0 204 103 495			
							0 986 135 007			

											
1.2 i 8V	07.99-06.03	44			MIH	0 204 102 492	← 48				
						0 204 103 494					
						0 986 134 007					
						0 204 102 493	→ 48				
						0 204 103 495					
						0 986 135 007					
	07.03-12.10	44				MIH	0 204 102 494	← 48	0 204 104 203 <sup>7</sup>		
							0 204 103 494				
							0 204 103 822				
							0 204 102 495	→ 48	0 204 104 203 <sup>7</sup>		
							0 204 103 495				
							0 986 135 007				
1.2 LPG	08.07-12.10	44				0 204 902 090	→ 48				
						0 986 135 007					
						0 986 134 007					
						0 204 102 495	→ 48	0 204 104 203 <sup>7</sup>			
1.3 MJTD 16V	07.03-12.10	51				0 204 902 103	← 54	0 204 104 208 <sup>8</sup>			
						0 204 103 502					
						0 204 902 104	→ 54	0 204 104 208 <sup>8</sup>			
						0 204 103 503					
1.9 D	05.99-06.03	44			MIH	0 204 102 570	← 54	0 204 104 208 <sup>8</sup>			
						0 204 102 571	→ 54	0 204 104 208 <sup>8</sup>			
						0 204 902 103	← 54	0 204 104 208 <sup>8</sup>			
					MIH	0 204 103 502					
						0 204 902 104	→ 54	0 204 104 208 <sup>8</sup>			
						0 204 103 503					
1.9 JTD	05.99-06.03	63			MIH	0 204 102 570	← 54	0 204 104 208 <sup>8</sup>			
						0 204 102 571	→ 54	0 204 104 208 <sup>8</sup>			
					MIH	0 204 902 103	← 54	0 204 104 208 <sup>8</sup>			
						0 204 103 502					
1.9 JTD 8V	07.03-12.10	63				0 204 902 104	→ 54	0 204 104 208 <sup>8</sup>			
						0 204 103 503					
						0 204 902 103	← 54	0 204 104 208 <sup>8</sup>			
						0 204 103 502					
1.2 Bipower, i 8V, LPG	07.99-12.10	44				0 986 475 874	↔ 20,6				
						0 986 475 885	↔ 22				
						0 986 475 885	↔ 22				
1.2 Bipower	07.03-12.10	44				1 987 477 561	↔ 1456				
						1.2 i 8V	07.99-12.10	44	1 987 477 561	↔ 1456	
						1.2 LPG	08.07-12.10	44	1 987 477 561	↔ 1456	
						1.3 MJTD 16V	07.03-12.10	51	1 987 477 561	↔ 1456	
						1.9 D	05.99-06.03	44/63	1 987 477 561	↔ 1456	
						1.9 JTD	05.99-06.03	44/63	1 987 477 561	↔ 1456	
						1.9 JTD 8V	07.03-12.10	44/63	1 987 477 561	↔ 1456	
						1.2 Bipower	07.03-12.10	44	LAB	0 265 007 610 <sup>3</sup>	
1.2 i 8V			RAB	0 265 007 831 <sup>4</sup>							
1.2 LPG					0 265 007 518 <sup>3</sup>						
					0 265 007 519 <sup>4</sup>						



<b>FIAT Punto Van [288]</b>								
	07.99-05.02	44	Ricom.Nr →284749, →4546420, →5171879	LAB	0 265 <b>007 069</b> <sup>3</sup>			
					RAB	0 265 <b>007 072</b> <sup>4</sup>		
	06.02-06.03	44	Ricom.Nr 284750→, 4546421→, 5171880→	LAB	0 265 <b>007 070</b> <sup>3</sup>			
RAB				0 265 <b>007 071</b> <sup>4</sup>				
<b>1.3 MJTD 16V</b>	07.03-12.10	51		LAB	0 265 <b>007 510</b> <sup>3</sup>			
				RAB	0 265 <b>007 512</b> <sup>4</sup>			
	05.99-05.02	44	Ricom.Nr →284749, →4546420, →5171879	LAB	0 265 <b>007 513</b> <sup>4</sup>			
RAB				0 265 <b>007 518</b> <sup>3</sup>				
<b>1.9 D</b>	06.02-06.03	44	Ricom.Nr 284750→, 4546421→, 5171880→	LAB	0 265 <b>007 519</b> <sup>4</sup>			
				RAB	0 265 <b>007 610</b> <sup>3</sup>			
<b>1.3 MJTD 16V</b>	07.03-12.10	51		LAB	0 265 <b>007 831</b> <sup>4</sup>			
				RAB	0 265 <b>007 518</b> <sup>3</sup>			
<b>1.9 D</b>	05.99-05.02	44	Ricom.Nr →284749, →4546420, →5171879	LAB	0 265 <b>007 069</b> <sup>3</sup>			
				RAB	0 265 <b>007 072</b> <sup>4</sup>			
	06.02-06.03	44	Ricom.Nr 284750→, 4546421→, 5171880→	LAB	0 265 <b>007 070</b> <sup>3</sup>			
RAB				0 265 <b>007 071</b> <sup>4</sup>				
<b>1.9 JTD</b>	05.99-05.02	63	Ricom.Nr →284749, →4546420, →5171879	LAB	0 265 <b>007 510</b> <sup>3</sup>			
				RAB	0 265 <b>007 512</b> <sup>4</sup>			
	06.02-06.03	63	Ricom.Nr 284750→, 4546421→, 5171880→	LAB	0 265 <b>007 511</b> <sup>3</sup>			
RAB				0 265 <b>007 513</b> <sup>4</sup>				
<b>1.9 JTD 8V</b>	07.03-12.10	63		LAB	0 265 <b>007 510</b> <sup>3</sup>			
				RAB	0 265 <b>007 512</b> <sup>4</sup>			
	05.99-05.02	63	Ricom.Nr →284749, →4546420, →5171879	LAB	0 265 <b>007 513</b> <sup>4</sup>			
RAB				0 265 <b>007 610</b> <sup>3</sup>				
<b>1.9 JTD 8V</b>	07.03-12.10	63		LAB	0 265 <b>007 831</b> <sup>4</sup>			
				RAB	0 265 <b>007 518</b> <sup>3</sup>			
	06.02-06.03	63	Ricom.Nr 284750→, 4546421→, 5171880→	LAB	0 265 <b>007 519</b> <sup>4</sup>			
RAB				0 265 <b>007 513</b> <sup>4</sup>				
<b>Punto [176]</b>								
	ABO	08.93-04.97	42	MIH	0 204 <b>102 492</b>	← 48	0 204 <b>104 203</b> <sup>7</sup>	
					0 204 <b>103 494</b>			
	08.93-03.96	42	ABS	MIH	0 986 <b>134 007</b>			
				MIH	0 204 <b>102 493</b>	→ 48	0 204 <b>104 203</b> <sup>7</sup>	
	08.93-03.96	42	ABS	MIH	0 204 <b>103 495</b>			
				MIH	0 986 <b>135 007</b>			
	08.93-03.96	42	ABS	MIH	0 204 <b>102 494</b>	← 48	0 204 <b>104 203</b> <sup>7</sup>	
				MIH	0 204 <b>103 494</b>			
	08.93-03.96	42	ABS	MIH	0 204 <b>103 822</b>			
				MIH	0 204 <b>102 495</b>	→ 48	0 204 <b>104 203</b> <sup>7</sup>	
	08.93-03.96	42	ABS	MIH	0 204 <b>103 495</b>			
				MIH	0 986 <b>135 007</b>			
	08.93-03.96	42	ABS	MIH	0 204 <b>102 550</b>	← 48		
				MIH	0 204 <b>102 551</b>	→ 48		
	08.93-03.96	42	ABS	MIH	0 204 <b>102 524</b>	← 48		
				MIH	0 204 <b>103 524</b>			
	08.93-03.96	42	ABS	MIH	0 204 <b>102 525</b>	→ 48		
				MIH	0 204 <b>103 525</b>			
	04.96-04.97	42		MIH	0 204 <b>102 492</b>	← 48		
				MIH	0 204 <b>103 494</b>			
	04.96-04.97	42		MIH	0 986 <b>134 007</b>			
				MIH	0 204 <b>102 493</b>	→ 48		
	04.96-04.97	42		MIH	0 204 <b>103 495</b>			
				MIH	0 986 <b>135 007</b>			

		S							
1.7 D	ABS	04.96-04.97	42		MIH		0 204 102 494 0 204 103 494 0 204 103 822	← 48  	0 204 104 203 <sup>7</sup>
							0 204 102 495 0 204 103 495 0 986 135 007	→ 48  	0 204 104 203 <sup>7</sup>
1.7 TD		08.93-04.97	46/51		MIH		0 204 102 550 0 204 102 551	← 48 → 48	
					MIH		0 204 102 524 0 204 103 524 0 204 102 525 0 204 103 525	← 48  → 48 	
			51-53		MIH		0 204 102 550 0 204 102 551	← 48 → 48	
					MIH		0 204 102 524 0 204 103 524 0 204 102 525 0 204 103 525	← 48  → 48 	
		05.97-08.99	46/51		MIH				0 204 104 208 <sup>8</sup>
55 1.1 i.e.		04.96-04.97	40		MIH		0 204 102 492 0 204 103 494 0 986 134 007	← 48  	
							0 204 102 493 0 204 103 495 0 986 135 007	→ 48  	
		04.96-08.99	40		MIH		0 204 102 494 0 204 103 494 0 204 103 822	← 48  	0 204 104 203 <sup>7</sup>
							0 204 102 495 0 204 103 495 0 986 135 007	→ 48  	0 204 104 203 <sup>7</sup>
		05.97-08.99	40	Ricam.Nr →2617716	MIH		0 204 102 492 0 204 103 494 0 986 134 007	← 48  	
							0 204 102 493 0 204 103 495 0 986 135 007	→ 48  	
	ABO	08.93-03.96	40		MIH		0 204 102 494 0 204 103 494 0 204 103 822	← 48  	0 204 104 203 <sup>7</sup>
							0 204 102 495 0 204 103 495 0 986 135 007	→ 48  	0 204 104 203 <sup>7</sup>
		08.93-04.97	40		MIH		0 204 102 492 0 204 103 494 0 986 134 007	← 48  	0 204 104 203 <sup>7</sup>
							0 204 102 493 0 204 103 495 0 986 135 007	→ 48  	0 204 104 203 <sup>7</sup>
	ABS	08.93-04.97	40		MIH		0 204 102 550 0 204 102 551	← 48 → 48	
					MIH		0 204 102 524 0 204 103 524 0 204 102 525 0 204 103 525	← 48  → 48 	0 204 104 234 <sup>7</sup>
									0 204 104 234 <sup>7</sup>
		01.95-03.96	40		GS,MIH		0 204 102 550 0 204 102 551	← 48 → 48	
					GS,MIH		0 204 102 524 0 204 103 524 0 204 102 525 0 204 103 525	← 48  → 48 	0 204 104 234 <sup>7</sup>



60 1.2 i.e.	06.95-04.97	44	AG,MIH			0 204 102 550	← 48			
						0 204 102 551	→ 48			
	05.97-03.98	44	GS,MIH			0 204 102 524	← 48	0 204 104 234 <sup>7</sup>		
						0 204 103 524				
						0 204 102 525	→ 48	0 204 104 234 <sup>7</sup>		
						0 204 103 525				
	05.97-03.98	44	GS,MIH			0 204 102 492	← 48			
						0 204 103 494				
						0 986 134 007				
						0 204 102 493	→ 48			
						0 204 103 495				
						0 986 135 007				
	05.97-08.99	44	AG,MIH					0 204 104 208 <sup>8</sup>		
						GS,MIH	0 204 102 494	← 48	0 204 104 203 <sup>7</sup>	
						Ricam.Nr →2617716		0 204 103 494		
								0 204 103 822		
								0 204 102 495	→ 48	0 204 104 203 <sup>7</sup>
								0 204 103 495		
ABO	08.93-05.94	43	MIH			0 204 102 492	← 48	0 204 104 203 <sup>7</sup>		
						0 204 103 494				
						0 986 134 007				
								0 204 102 493	→ 48	0 204 104 203 <sup>7</sup>
								0 204 103 495		
								0 986 135 007		
	06.95-03.96	44	GS,MIH			0 204 102 492	← 48	0 204 104 203 <sup>7</sup>		
						0 204 103 494				
						0 986 134 007				
								0 204 102 493	→ 48	0 204 104 203 <sup>7</sup>
								0 204 103 495		
								0 986 135 007		
ABS	08.93-05.94	43	MIH			0 204 102 550	← 48			
						0 204 102 551	→ 48			
			MIH			0 204 102 524	← 48	0 204 104 234 <sup>7</sup>		
						0 204 103 524				
						0 204 102 525	→ 48	0 204 104 234 <sup>7</sup>		
						0 204 103 525				
	06.95-03.96	44	GS,MIH			0 204 102 550	← 48			
						0 204 102 551	→ 48			
			GS,MIH			0 204 102 524	← 48	0 204 104 234 <sup>7</sup>		
						0 204 103 524				
						0 204 102 525	→ 48	0 204 104 234 <sup>7</sup>		
						0 204 103 525				
60 1.2 i.e. Selecta	06.94-04.97	44	MIH			0 204 102 550	← 48			
						0 204 102 551	→ 48			
			MIH			0 204 102 524	← 48	0 204 104 234 <sup>7</sup>		
						0 204 103 524				
						0 204 102 525	→ 48	0 204 104 234 <sup>7</sup>		
						0 204 103 525				



		S									
75 1.2 i.e.	04.96-04.97	54	MIH	0 204 102 492	← 48						
				0 204 103 494							
				0 986 134 007							
				0 204 102 493	→ 48						
				0 204 103 495							
				0 986 135 007							
	04.96-08.99	54	MIH	0 204 102 494	← 48	0 204 104 203 <sup>7</sup>					
				0 204 103 494							
				0 204 103 822							
				0 204 102 495	→ 48	0 204 104 203 <sup>7</sup>					
				0 204 103 495							
				0 986 135 007							
05.97-08.99	54	Ricam.Nr →2617716	MIH	0 204 102 492	← 48						
				0 204 103 494							
				0 986 134 007							
				0 204 102 493	→ 48						
				0 204 103 495							
				0 986 135 007							
ABO 08.93-03.96	54	MIH	0 204 102 492	← 48	0 204 104 203 <sup>7</sup>						
			0 204 103 494								
			0 986 134 007								
			0 204 102 493	→ 48	0 204 104 203 <sup>7</sup>						
			0 204 103 495								
			0 986 135 007								
		MIH	0 204 102 494	← 48	0 204 104 203 <sup>7</sup>						
			0 204 103 494								
			0 204 103 822								
			0 204 102 495	→ 48	0 204 104 203 <sup>7</sup>						
			0 204 103 495								
			0 986 135 007								
ABS 08.93-03.96	54	GS,MIH	0 204 102 550	← 48							
			0 204 102 551	→ 48							
		GS,MIH	0 204 102 524	← 48	0 204 104 234 <sup>7</sup>						
			0 204 103 524								
			0 204 102 525	→ 48	0 204 104 234 <sup>7</sup>						
			0 204 103 525								
85 1.2 i.e. 16V	05.97-08.99	63	MIH			0 204 104 208 <sup>8</sup>					
90 1.6 i.e.	01.94-04.97	65	MIH	0 204 102 550	← 48						
				0 204 102 551	→ 48						
			MIH	0 204 102 524	← 48	0 204 104 234 <sup>7</sup>					
				0 204 103 524							
				0 204 102 525	→ 48	0 204 104 234 <sup>7</sup>					
				0 204 103 525							
		08.93-04.97	42	BSY	F 026 002 157	↔ 20,6					
					LOC	0 986 475 816	↔ 20,64				
				1.7 TD	08.93-04.97	51	BSY	F 026 002 157	↔ 20,6		
								LOC	0 986 475 816	↔ 20,64	
					51-53	BSY	F 026 002 157	↔ 20,6			
							LOC	0 986 475 816	↔ 20,64		
				06.96-04.97	46	BSY	F 026 002 157	↔ 20,6			
							LOC	0 986 475 816	↔ 20,64		
				ABO 05.97-08.99	46/51			F 026 002 558	↔ 20,64		
				ABS 05.97-08.99	46	BSY	F 026 002 157	↔ 20,6			
							BSY	F 026 002 157	↔ 20,6		
				55 1.1 i.e.	08.93-08.99	40	BSY	F 026 002 157	↔ 20,6		
								LOC	0 986 475 816	↔ 20,64	
				60 1.2 i.e.	08.93-08.99	43/44		BSY	F 026 002 157	↔ 20,6	
				60 1.2 i.e. Selecta	08.93-08.99	54	BSY	F 026 002 157	↔ 20,6		
								LOC	0 986 475 816	↔ 20,64	
				75 1.2 i.e.	08.93-08.99	54	BSY	F 026 002 157	↔ 20,6		
								LOC	0 986 475 816	↔ 20,64	





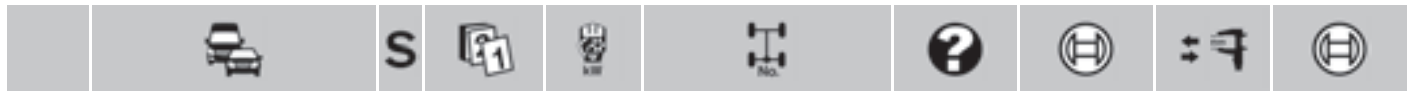













































	FIAT Punto [176]							
85 1.2 i.e. 16V	05.97-08.99	63		BSY	F 026 <b>002 157</b>	↔ 20,6		
				LOC	0986 <b>475 816</b>	↔ 20,64		
90 1.6 i.e.	01.94-04.97	65		BSY	F 026 <b>002 157</b>	↔ 20,6		
				LOC	0986 <b>475 816</b>	↔ 20,64		

1.7 D	08.93-08.99	42/46/			1987 <b>477 383</b>	→ 1469		
1.7 TD		51-53			1987 <b>477 384</b>	← 1456		
55 1.1 i.e.	08.93-08.99	40			1987 <b>477 383</b>	→ 1469		
					1987 <b>477 384</b>	← 1456		
60 1.2 i.e.	08.93-08.99	43/44			1987 <b>477 383</b>	→ 1469		
60 1.2 i.e. Selecta					1987 <b>477 384</b>	← 1456		
75 1.2 i.e.	08.93-08.99	54			1987 <b>477 383</b>	→ 1469		
					1987 <b>477 384</b>	← 1456		
85 1.2 i.e. 16V	05.97-08.99	63			1987 <b>477 383</b>	→ 1469		
					1987 <b>477 384</b>	← 1456		
90 1.6 i.e.	01.94-04.97	65			1987 <b>477 383</b>	→ 1469		
					1987 <b>477 384</b>	← 1456		

1.7 D	08.93-08.99	42/46/		LAB	0 265 <b>006 139</b> <sup>4</sup>			
1.7 TD		51-53		RAB	0 265 <b>006 140</b> <sup>4</sup>			
				ZE	0 265 <b>001 387</b> <sup>3</sup>			
55 1.1 i.e.	08.93-08.99	40		LAB	0 265 <b>006 139</b> <sup>4</sup>			
				RAB	0 265 <b>006 140</b> <sup>4</sup>			
				ZE	0 265 <b>001 387</b> <sup>3</sup>			
60 1.2 i.e.	08.93-05.94	43		LAB	0 265 <b>006 139</b> <sup>4</sup>			
				RAB	0 265 <b>006 140</b> <sup>4</sup>			
				ZE	0 265 <b>001 387</b> <sup>3</sup>			
	06.95-08.99	44		LAB	0 265 <b>006 139</b> <sup>4</sup>			
				RAB	0 265 <b>006 140</b> <sup>4</sup>			
				ZE	0 265 <b>001 387</b> <sup>3</sup>			
75 1.2 i.e.	08.93-08.99	54		LAB	0 265 <b>006 139</b> <sup>4</sup>			
				RAB	0 265 <b>006 140</b> <sup>4</sup>			
				ZE	0 265 <b>001 387</b> <sup>3</sup>			
85 1.2 i.e. 16V	05.97-08.99	63		LAB	0 265 <b>006 139</b> <sup>4</sup>			
				RAB	0 265 <b>006 140</b> <sup>4</sup>			
				ZE	0 265 <b>001 387</b> <sup>3</sup>			
90 1.6 i.e.	01.94-04.97	65		LAB	0 265 <b>006 139</b> <sup>4</sup>			
				RAB	0 265 <b>006 140</b> <sup>4</sup>			
				ZE	0 265 <b>001 387</b> <sup>3</sup>			









**Punto [188]**

1.2 Bipower	07.03-12.10	44			0 204 <b>102 494</b>	← 48	0 204 <b>104 203</b> <sup>7</sup>	
					0 204 <b>103 494</b>			
					0 204 <b>103 822</b>			
					0 204 <b>102 495</b>	→ 48	0 204 <b>104 203</b> <sup>7</sup>	
					0 204 <b>103 495</b>			
					0986 <b>135 007</b>			
1.2 i8V	07.99-06.03	44		MIH	0 204 <b>102 492</b>	← 48		
					0 204 <b>103 494</b>			
					0986 <b>134 007</b>			
					0 204 <b>102 493</b>	→ 48		
					0 204 <b>103 495</b>			
					0986 <b>135 007</b>			
				MIH	0 204 <b>102 494</b>	← 48	0 204 <b>104 203</b> <sup>7</sup>	
					0 204 <b>103 494</b>			
					0 204 <b>103 822</b>			
					0 204 <b>102 495</b>	→ 48	0 204 <b>104 203</b> <sup>7</sup>	
					0 204 <b>103 495</b>			
					0986 <b>135 007</b>			

									
1.2i 8V Bipower	11.02-06.03	59	MIH	0 204 102 492	← 48				
				0 204 103 494					
				0 986 134 007					
				0 204 102 493	→ 48				
				0 204 103 495					
				0 986 135 007					
				MIH	0 204 102 494	← 48	0 204 104 203 <sup>7</sup>		
				0 204 103 494					
				0 204 103 822					
				0 204 102 495	→ 48	0 204 104 203 <sup>7</sup>			
0 204 103 495									
0 986 135 007									
1.2i 16V	07.99-06.03	59	AG,MIH	0 204 102 569	→ 54				
				0 986 135 317					
				0 986 134 317					
			AG,MIH	0 204 902 101	←	0 204 104 208 <sup>B</sup>			
				0 204 103 499					
				0 986 134 317					
			GS,MIH	0 204 902 102	→	0 204 104 208 <sup>B</sup>			
				0 204 103 500					
				0 986 135 317					
						0 204 104 208 <sup>B</sup>			
1.2i.e. 8V	07.03-12.10	44		0 204 102 494	← 48	0 204 104 203 <sup>7</sup>			
				0 204 103 494					
				0 204 103 822					
				0 204 102 495	→ 48	0 204 104 203 <sup>7</sup>			
				0 204 103 495					
				0 986 135 007					
1.2i.e. 16V	07.03-12.10	59	AG	0 204 902 101	←	0 204 104 208 <sup>B</sup>			
				0 204 103 499					
				0 986 134 317					
				0 204 902 102	→	0 204 104 208 <sup>B</sup>			
			0 204 103 500						
			0 986 135 317						
			GS			0 204 104 208 <sup>B</sup>			
1.2 LPG	08.07-12.10	44		0 204 902 090	→ 48				
				0 986 135 007					
				0 986 134 007		← 48			
1.3 MJTD 16V	07.03-12.10	52		0 204 902 103	← 54	0 204 104 208 <sup>B</sup>			
				0 204 103 502					
				0 204 902 104	→ 54	0 204 104 208 <sup>B</sup>			
0 204 103 503									
1.4i.e. 16V	07.03-12.10	70		0 204 902 103	← 54	0 204 104 208 <sup>B</sup>			
				0 204 103 502					
				0 204 902 104	→ 54	0 204 104 208 <sup>B</sup>			
0 204 103 503									
1.8i.e. 16V	07.03-12.10	96		0 204 102 854	← 54	0 204 104 208 <sup>B</sup>			
				0 204 103 854					
				0 204 102 855	→ 54	0 204 104 208 <sup>B</sup>			
				0 204 103 855					
1.9D	07.99-06.03	44	MIH	0 204 102 569	→ 54				
				0 986 135 317					
				0 986 134 317		← 54			
			MIH	0 204 902 101	←	0 204 104 208 <sup>B</sup>			
				0 204 103 499					
				0 986 134 317					
				0 204 902 102	→	0 204 104 208 <sup>B</sup>			
				0 204 103 500					
				0 986 135 317					





































<b>FIAT Punto [188]</b>																																
	<b>1.9 JTD</b>	07.99-06.03	59		MIH	0 204 102 570	← 54	0 204 104 208 <sup>8</sup>																								
						0 204 102 571	→ 54	0 204 104 208 <sup>8</sup>																								
						0 204 902 103	← 54	0 204 104 208 <sup>8</sup>																								
		06.01-06.03	63		MIH	0 204 103 502		→ 54	0 204 104 208 <sup>8</sup>																							
						0 204 902 104		→ 54	0 204 104 208 <sup>8</sup>																							
						0 204 103 503																										
	0 204 102 570					← 54	0 204 104 208 <sup>8</sup>																									
	0 204 102 571					→ 54	0 204 104 208 <sup>8</sup>																									
	0 204 902 103					← 54	0 204 104 208 <sup>8</sup>																									
	<b>1.9 JTD 8V</b>	07.03-12.10	63				0 204 902 103	← 54	0 204 104 208 <sup>8</sup>																							
							0 204 103 502																									
							0 204 902 104	→ 54	0 204 104 208 <sup>8</sup>																							
0 204 103 503																																
0 204 102 854							← 54	0 204 104 208 <sup>8</sup>																								
0 204 103 854																																
74							0 204 102 855	→ 54	0 204 104 208 <sup>8</sup>																							
							0 204 103 855																									
								<b>1.2 Bipower, i 8V, i.e. 8V, LPG</b>	07.99-12.10	44			0 986 475 874	↔ 20,6																		
													<b>1.2 i 8V Bipower</b>	11.02-06.03	59				0 986 475 874	↔ 20,6												
																			<b>1.2 i 16V</b>	07.99-06.03	59		AG	0 986 475 885	↔ 22							
GS	0 986 475 874	↔ 20,6																														
<b>F</b>																																
										<b>1.2 i.e. 16V</b>	07.03-12.10	59																				
																		<b>1.3 MJTD 16V</b>	07.03-12.10	52												
										<b>1.4 i.e. 16V</b>	07.03-07.05	70																				
																		08.05-12.10	70													
										<b>1.9 D, JTD, JTD 8V</b>	07.99-12.10	44/59/63																				
																	<b>1.9 JTD 8V</b>	07.03-07.05	74		ADE	0 986 475 925	↔ 20,64									
										08.05-12.10	74	ADE	0 986 475 936	↔ 20,64																		
																		<b>1.2 Bipower</b>	07.03-12.10	44/59												
																										<b>1.2 i 8V</b>	07.99-06.03	44/59				
																		<b>1.2 i 8V Bipower</b>	11.02-06.03	44/59												
<b>1.2 i 16V</b>	07.99-06.03	44/59																														
								<b>1.2 i.e. 8V</b>	07.03-12.10									44/59														
<b>1.2 i.e. 16V</b>	07.03-12.10	44/59																														
								<b>1.2 LPG</b>	08.07-12.10									44/59														
<b>1.3 MJTD 16V</b>	07.03-12.10	52																														
								<b>1.4 i.e. 16V</b>	07.03-12.10									70														
<b>1.8 i 16V</b>	07.99-06.03	96																														
								<b>1.8 i.e. 16V</b>	07.03-12.10									96														
<b>1.9 D</b>	07.99-06.03	44/59/63																														
								<b>1.9 JTD</b>	07.99-06.03									44/59/63														
<b>1.9 JTD 8V</b>	07.03-12.10	44/59/63																														
								74												SBR	1 987 477 722	↔ 1588										
TBR	1 987 477 972	↔ 1465																														
																		<b>1.2 Bipower</b>	07.03-12.10	44												
																										<b>1.2 i.e. 8V</b>						
																		<b>1.2 i 8V</b>	07.99-05.02	44	Ricam.Nr →284749, →4546420, →5171879		LAB	0 265 007 610 <sup>3</sup>								
																				RAB	0 265 007 831 <sup>4</sup>											
														0 265 007 518 <sup>3</sup>																		
																					0 265 007 519 <sup>4</sup>											
														0 265 007 069 <sup>3</sup>																		
					0 265 007 072 <sup>4</sup>																											
											RAB	0 265 007 070 <sup>3</sup>																				
					0 265 007 071 <sup>4</sup>																											

								
<b>1.2 i 8V</b>	06.02-06.03	44	Ricam.Nr 284750→, 4546421→, 5171880→	LAB	0 265 007 510 <sup>3</sup>			
				RAB	0 265 007 512 <sup>4</sup>			
<b>1.2 i 8V Bipower</b>	11.02-06.03	59		LAB	0 265 007 511 <sup>3</sup>			
				RAB	0 265 007 513 <sup>3</sup>			
<b>1.2 i 16V</b>	07.99-05.02	59	Ricam.Nr →284749, →4546420, →5171879	LAB	0 265 007 514 <sup>4</sup>			
				RAB	0 265 007 510 <sup>3</sup>			
<b>1.2 i 16V</b>	06.02-06.03	59	Ricam.Nr 284750→, 4546421→, 5171880→	LAB	0 265 007 069 <sup>3</sup>			
				RAB	0 265 007 072 <sup>4</sup>			
<b>1.2 i.e. 16V</b>	07.03-12.10	59		LAB	0 265 007 070 <sup>3</sup>			
				RAB	0 265 007 071 <sup>4</sup>			
<b>1.2 i.e. 16V</b>	07.03-12.10	59		LAB	0 265 007 510 <sup>3</sup>			
				RAB	0 265 007 512 <sup>4</sup>			
<b>1.2 i.e. 16V</b>	07.03-12.10	59		LAB	0 265 007 513 <sup>3</sup>			
				RAB	0 265 007 514 <sup>4</sup>			
<b>1.3 MJTD 16V</b>	07.03-12.10	52		LAB	0 265 007 610 <sup>3</sup>			
				RAB	0 265 007 831 <sup>4</sup>			
<b>1.3 MJTD 16V</b>	07.03-12.10	52		LAB	0 265 007 518 <sup>3</sup>			
				RAB	0 265 007 519 <sup>4</sup>			
<b>1.4 i.e. 16V</b>	07.03-12.10	70		LAB	0 265 007 610 <sup>3</sup>			
				RAB	0 265 007 831 <sup>4</sup>			
<b>1.4 i.e. 16V</b>	07.03-12.10	70		LAB	0 265 007 518 <sup>3</sup>			
				RAB	0 265 007 519 <sup>4</sup>			
<b>1.8 i 16V</b>	07.99-06.00	96	Ricam.Nr →0134146	LAB	0 265 007 610 <sup>3</sup>			
				RAB	0 265 007 831 <sup>4</sup>			
<b>1.8 i 16V</b>	07.99-06.03	96		LAB	0 265 007 072 <sup>4</sup>			
				RAB	0 265 007 071 <sup>4</sup>			
<b>1.8 i 16V</b>	07.99-06.03	96		LAB	0 265 007 069 <sup>3</sup>			
				RAB	0 265 007 070 <sup>3</sup>			
<b>1.8 i 16V</b>	07.00-06.03	96	Ricam.Nr 0134147→	LAB	0 265 007 100 <sup>4</sup>			
				RAB	0 265 007 101 <sup>4</sup>			
<b>1.8 i.e. 16V</b>	07.03-11.04	96	Ricam.Nr →0568433, →4972620	LAB	0 265 007 521 <sup>4</sup>			
				RAB	0 265 007 521 <sup>4</sup>			
<b>1.8 i.e. 16V</b>	07.03-12.10	96		LAB	0 265 007 610 <sup>3</sup>			
				RAB	0 265 007 518 <sup>3</sup>			
<b>1.8 i.e. 16V</b>	12.04-12.10	96	Ricam.Nr 0568434→, 4972621→	LAB	0 265 007 520 <sup>4</sup>			
				RAB	0 265 007 832 <sup>4</sup>			
<b>1.9 D</b>	07.99-05.02	44/59	Ricam.Nr →284749, →4546420, →5171879	LAB	0 265 007 069 <sup>3</sup>			
				RAB	0 265 007 072 <sup>4</sup>			
<b>1.9 JTD</b>	06.02-06.03	44/59	Ricam.Nr 284750→, 4546421→, 5171880→	LAB	0 265 007 070 <sup>3</sup>			
				RAB	0 265 007 071 <sup>4</sup>			
<b>1.9 JTD</b>	06.02-06.03	44/59	Ricam.Nr 284750→, 4546421→, 5171880→	LAB	0 265 007 510 <sup>3</sup>			
				RAB	0 265 007 512 <sup>4</sup>			
<b>1.9 JTD</b>	06.01-05.02	63	Ricam.Nr →284749, →4546420, →5171879	LAB	0 265 007 511 <sup>3</sup>			
				RAB	0 265 007 513 <sup>3</sup>			
<b>1.9 JTD</b>	06.01-05.02	63	Ricam.Nr →284749, →4546420, →5171879	LAB	0 265 007 514 <sup>4</sup>			
				RAB	0 265 007 069 <sup>3</sup>			
<b>1.9 JTD</b>	06.02-06.03	63	Ricam.Nr 284750→, 4546421→, 5171880→	LAB	0 265 007 072 <sup>4</sup>			
				RAB	0 265 007 070 <sup>3</sup>			
<b>1.9 JTD</b>	06.02-06.03	63	Ricam.Nr 284750→, 4546421→, 5171880→	LAB	0 265 007 071 <sup>4</sup>			
				RAB	0 265 007 510 <sup>3</sup>			
<b>1.9 JTD 8V</b>	07.03-12.10	63		LAB	0 265 007 512 <sup>4</sup>			
				RAB	0 265 007 511 <sup>3</sup>			
<b>1.9 JTD 8V</b>	07.03-12.10	63		LAB	0 265 007 513 <sup>3</sup>			
				RAB	0 265 007 514 <sup>4</sup>			
<b>1.9 JTD 8V</b>	07.03-12.10	63		LAB	0 265 007 610 <sup>3</sup>			
				RAB	0 265 007 831 <sup>4</sup>			
<b>1.9 JTD 8V</b>	07.03-12.10	63		LAB	0 265 007 518 <sup>3</sup>			
				RAB	0 265 007 519 <sup>4</sup>			



		S							
	◀ FIAT Punto [188]								
	1.9 JTD 8V	07.03-12.10	74		LAB		0 265 007 610 <sup>3</sup>		
					RAB		0 265 007 518 <sup>3</sup>		
					RAB,SBR		0 265 007 520 <sup>4</sup>		
					RAB,TBR		0 265 007 519 <sup>4</sup>		
				Ricam.Nr →0568433, →4972620	LAB,SBR		0 265 007 521 <sup>4</sup>		
				Ricam.Nr 0568434→, 4972621→	LAB,TBR		0 265 007 831 <sup>4</sup>		
		12.04-12.10	74	Ricam.Nr 0568434→, 4972621→	LAB,SBR		0 265 007 832 <sup>4</sup>		
<b>Punto [199]</b>									
	1.2	01.12→	48/49/51		TW		0 204 902 119	← 54	
							0 986 473 487		
							0 204 902 120	→ 54	
							0 986 474 487		
	1.3 Multijet	01.12-07.12	62				0 204 004 566	← 54	
							0 986 134 077		
		01.12→	55		TW		0 204 902 119	← 54	
							0 986 473 487		
							0 204 902 120	→ 54	
							0 986 474 487		
			70				0 204 004 566	← 54	
							0 986 134 077		
	1.4	01.12→	99		BSR		0 204 004 566	← 54	
							0 986 134 077		
	1.4	01.12→	51-57/77		TW		0 204 902 119	← 54	
	1.4 LPG						0 986 473 487		
	1.4 Natural Power						0 204 902 120	→ 54	
							0 986 474 487		
	0.9	03.12→	57-62,5/74				0 986 475 936	↔ 20,64	
	0.9	11.13→	72-77				0 986 475 936	↔ 20,64	
	1.2	01.12→	48/49/51				0 986 475 936	↔ 20,64	
	1.3 Multijet, Multijet	01.12→	55/59/62/70				0 986 475 936	↔ 20,64	
	1.4, LPG	01.12→	55/57/77				0 986 475 936	↔ 20,64	
	0.9	03.12→	57-62,5/74				1 987 477 973	→ 1660	
							1 987 477 974	← 1642	
	0.9	11.13→	72-77				1 987 477 973	→ 1660	
							1 987 477 974	← 1642	
	1.2	01.12→	48/49/51				1 987 477 973	→ 1660	
							1 987 477 974	← 1642	
	1.3 Multijet	01.12→	55/59/62/70				1 987 477 975	→ 1689	
	1.3 Multijet						1 987 477 976	← 1674	
	1.4, Abarth, Abarth SS	01.12→	99/120/132				1 987 477 977	→ 1673	
							1 987 477 978	← 1654	
	1.4	01.12→	55/57/77				1 987 477 975	→ 1689	
	1.4 LPG						1 987 477 976	← 1674	
	1.4 Natural Power	01.12→	51-57				1 987 477 977	→ 1673	
							1 987 477 978	← 1654	
	0.9	03.12→	57-62,5/74				0 265 004 136 <sup>3</sup>		
							0 265 007 896 <sup>4</sup>		
	0.9	11.13→	72-77				0 265 004 136 <sup>3</sup>		
							0 265 007 896 <sup>4</sup>		

		S							
1.2		01.12→	48/49/51				0 265 004 136 <sup>3</sup>		
							0 265 007 896 <sup>4</sup>		
1.3 Miltijet		01.12→	55/59/62/70				0 265 004 136 <sup>3</sup>		
1.3 Multijet							0 265 007 896 <sup>4</sup>		
1.4, Abarth, Abarth SS		01.12→	99/120/132				0 265 004 136 <sup>3</sup>		
							0 265 007 769 <sup>4</sup>		
1.4		01.12→	55/57/77				0 265 004 136 <sup>3</sup>		
1.4 LPG							0 265 007 896 <sup>4</sup>		
1.4 Natural Power		01.12→	51-57				0 265 004 136 <sup>3</sup>		
							0 265 007 769 <sup>4</sup>		
<b>Qubo [300..]</b>									
									
 1.3 Multijet		09.08→	55				0 204 902 119	← 54	
							0 986 473 487		
							0 986 474 487	 → 54	
		09.10→	70				0 204 004 566	← 54	
							0 986 134 077		
		03.15→	59				0 204 902 119	← 54	
							0 986 473 487		
							0 986 474 487	 → 54	
1.4		09.08→	51-57				0 204 902 032	← 54	
1.4 Natural Power							0 986 473 487		
							0 986 474 487	 → 54	
									
 1.3 Multijet		09.08→	55/59/70				0 986 475 936	↔ 20,64	
1.4, Natural Power		09.08→	51-57				0 986 475 936	↔ 20,64	
									
 1.3 Multijet		09.08→	55/59/70				1 987 482 207	→ 1710	
							1 987 482 208	← 1677	
1.4		09.08→	54-57				1 987 482 205	→ 1695	
							1 987 482 206	← 1662	
1.4 Natural Power		10.09→	51-57				1 987 482 207	→ 1710	
							1 987 482 208	← 1677	
<b>Scudo [222..]</b>									
									
 1.6 i		10.95-05.00	58			BSY	0 204 102 521	← 57	0 204 100 316 <sup>8</sup>
							0 204 103 521		0 204 104 177 <sup>7</sup>
							0 204 102 523	→ 57	0 204 100 316 <sup>8</sup>
							0 204 103 523		
						GIR	0 986 473 115	 ← 57,11	
							0 986 474 115	 → 57,11	
1.9D		10.95-08.01	51			BSY	0 204 102 521	← 57	0 204 100 316 <sup>8</sup>
							0 204 103 521		0 204 104 177 <sup>7</sup>
							0 204 102 523	→ 57	0 204 100 316 <sup>8</sup>
							0 204 103 523		
						GIR	0 986 473 115	 ← 57,11	
							0 986 474 115	 → 57,11	
		09.01-05.04	52			BSY	0 204 102 521	← 57	0 204 100 316 <sup>8</sup>
							0 204 103 521		0 204 104 177 <sup>7</sup>
							0 204 102 523	→ 57	0 204 100 316 <sup>8</sup>
							0 204 103 523		
						GIR	0 986 473 115	 ← 57,11	
							0 986 474 115	 → 57,11	



		S							
1.9D		06.04-01.07	51			BSY	0 204 102 521	← 57	0 204 104 177 <sup>7</sup>
							0 204 103 521		
							0 204 102 523	→ 57	0 204 104 177 <sup>7</sup>
							0 204 103 523		
1.9 TD		10.95-05.00	66/68			BSY	0 204 102 521	← 57	0 204 100 316 <sup>8</sup>
							0 204 103 521		0 204 104 177 <sup>7</sup>
							0 204 102 523	→ 57	0 204 100 316 <sup>8</sup>
							0 204 103 523		
						GIR	0 986 473 115	← 57,11	
							0 986 474 115	→ 57,11	
2.0 16V		10.99-05.04	70/81/100			BSY	0 204 102 521	← 57	0 204 100 316 <sup>8</sup>
2.0 16V JTD							0 204 103 521		
2.0 8V JTD							0 204 102 523	→ 57	0 204 100 316 <sup>8</sup>
							0 204 103 523		
						GIR	0 986 473 115	← 57,11	
							0 986 474 115	→ 57,11	
		10.99-01.07	70/81/100			BSY	0 204 102 521	← 57	0 204 104 177 <sup>7</sup>
							0 204 103 521		
		06.04-01.07	70/81/100			BSY	0 204 102 523	→ 57	0 204 104 177 <sup>7</sup>
							0 204 103 523		
1.6 i		10.95-05.00	58				F 026 002 181	↔ 19,05	
1.9 D, TD		10.95-01.07	51/52/66/68				F 026 002 181	↔ 19,05	
2.0 16V, 16V JTD, 8V JTD		10.99-01.07	70/81/100				F 026 002 181	↔ 19,05	
1.6 i		10.95-05.00	58			FKR	1 987 477 565	500	
						FLR	1 987 477 774	903	
						LLE	1 987 477 569	→ 2286	
1.9 D		10.95-01.07	51/52/66/			FKR	1 987 477 565	500	
1.9 TD			68			FLR	1 987 477 774	903	
						LLE	1 987 477 569	→ 2286	
2.0 16V		10.99-01.07	70/81/100			FKR	1 987 477 565	500	
2.0 16V JTD						FLR	1 987 477 774	903	
2.0 8V JTD						LLE	1 987 477 569	→ 2286	
1.6 i		05.97-09.97	58	Ricam.Nr 7480→7608			0 265 006 426 <sup>4</sup>		
		06.97-05.00	58	Ricam.Nr 7480→9050			0 265 006 388 <sup>3</sup>		
		09.97-05.00	58	Ricam.Nr 7609→9050			0 265 006 504 <sup>4</sup>		
1.9 D		05.97-09.97	51/66/68	Ricam.Nr 7480→7608			0 265 006 426 <sup>4</sup>		
1.9 TD		06.97-08.01	51/66/68	Ricam.Nr 7480→9050			0 265 006 388 <sup>3</sup>		
		09.97-08.01	51/66/68	Ricam.Nr 7609→9050			0 265 006 504 <sup>4</sup>		
2.0 16V, 16V JTD, 8V JTD		10.99-08.01	70/81/100	Ricam.Nr 7480→9050			0 265 006 388 <sup>3</sup>		
				Ricam.Nr 7609→9050			0 265 006 504 <sup>4</sup>		
<b>Scudo [270]</b>									
1.6 Multijet		03.12→	66				0 986 475 950	↔ 22	
1.6 Multijet		03.12→	66				0 986 134 346	← 41	
							0 986 135 346	→ 41	
1.6 Multijet		03.12→	66			HTB	1 987 482 118	↔ 1495	
						4SB,FKR	1 987 482 007	↔ 1614	
						4SB,FLR	1 987 482 008	↔ 1737	

		S							
	1.6 Multijet	03.12→	66				0 265 007 790 <sup>3</sup>		
							0 265 007 791 <sup>4</sup>		
<b>Scudo [272..]</b>									
	1.6 Multijet	01.07→	66				0 986 475 950	↔ 22	
	1.6 Multijet	01.07→	66				0 986 134 346	↻ ← 41	
							0 986 135 346	↻ → 41	
	2.0 Multijet	01.07→	88/94/100/ 120				0 986 134 346	↻ ← 41	
							0 986 135 346	↻ → 41	
	1.6 Multijet	01.07→	66			HTB	1 987 482 118	↔ 1495	
						4SB,FKR	1 987 482 007	↔ 1614	
						4SB,FLR	1 987 482 008	↔ 1737	
	2.0 Multijet	01.07→	88/94/100/ 120			FKR	1 987 482 007	↔ 1614	
						FLR	1 987 482 008	↔ 1737	
	1.6 Multijet	01.07→	66				0 265 007 790 <sup>3</sup>		
							0 265 007 791 <sup>4</sup>		
	2.0 Multijet	01.07→	88/94/100/ 120				0 265 007 790 <sup>3</sup>		
							0 265 007 791 <sup>4</sup>		
<b>Sedici [189]</b>									
	1.6, 4x4	05.06-08.09	79				0 986 475 951	↔ 19,05	
	1.9 JTD, JTD 4x4	05.06-09.09	88				0 986 475 951	↔ 19,05	
	1.6	05.06-08.09	79				1 987 482 434	→ 1797	
	1.6 4x4						1 987 482 435	← 1787	
		08.09→	88				1 987 482 465	→ 1638	
							1 987 482 466	← 1638	
	1.9 JTD	05.06-09.09	88				1 987 482 434	→ 1797	
	1.9 JTD 4x4						1 987 482 435	← 1787	
	2.0 JTD	08.09→	99				1 987 482 465	→ 1638	
	2.0 JTD 4x4						1 987 482 466	← 1638	
<b>Seicento [187..]</b>									
	Elettra	10.98-12.03					0 204 102 530	← 54	0 204 104 237 <sup>7</sup>
							0 204 103 530	↻	
							0 204 102 531	→ 54	0 204 104 237 <sup>7</sup>
							0 204 103 531	↻	
	900	03.98-12.03	29	Fg.-Nr. →957278	MIH		0 204 102 824	← 48	
							0 204 103 494	↻	
							0 986 134 007	↻	
							0 204 102 825	→ 48	
							0 204 103 495	↻	
							0 986 135 007	↻	
					MIH		0 204 902 006	← 48	0 204 104 203 <sup>7</sup>
							0 204 103 822	↻	
							0 204 902 007	→	0 204 104 203 <sup>7</sup>
							0 204 103 823	↻	
							0 986 135 007	↻	





































		S																				
◀ FIAT Seicento [187..]																						
	900	03.98-12.03	29	Fg.-Nr. 957279→	MIH	0 204 102 492	← 48															
						0 204 103 494																
						0 986 134 007																
						0 204 102 493	→ 48															
						0 204 103 495																
						0 986 135 007																
	1100	03.98-09.07	40	Fg.-Nr. 957279→	MIH	0 204 102 494	← 48															
						0 204 103 494																
						0 204 103 822																
						0 204 102 495	→ 48															
						0 204 103 495																
						0 986 135 007																
	1100	03.98-12.10	40	Fg.-Nr. →957278	MIH	0 204 102 824	← 48															
						0 204 103 494																
						0 986 134 007																
						0 204 102 825	→ 48															
						0 204 103 495																
						0 986 135 007																
	1100	10.07-12.10	40	Fg.-Nr. 957279→	MIH	0 204 902 006	← 48	0 204 104 203 <sup>7</sup>														
						0 204 103 822																
						0 204 902 007	→	0 204 104 203 <sup>7</sup>														
						0 204 103 823																
						0 986 135 007																
						0 204 102 492	← 48															
	900	08.00-12.03	29	ABO	03.98-08.00	29	F 026 002 565	↔ 19,05														
							F 026 002 454	↔ 19,05														
							1100	08.00-12.10	40	ABO	03.98-08.00	40	F 026 002 565	↔ 19,05								
													F 026 002 454	↔ 19,05								
														900	03.98-12.03	29	LAB	03.98-08.00	29	0 265 007 045 <sup>4</sup>		
																				0 265 007 043 <sup>3</sup>		
0 265 007 044 <sup>3</sup>																						
1100	03.98-12.10	40	LAB	03.98-08.00	40	0 265 007 045 <sup>4</sup>																
						0 265 007 043 <sup>3</sup>																
						0 265 007 044 <sup>3</sup>																
						<b>Siena</b>																
							1.3 MPI 16V	01.04-12.07	59				0 986 473 125	← 54								
													0 986 474 125	→ 54								



		S							
	1.3 MPI 16V	ABO	01.04-12.07	59			0 986 <b>BB3 009</b>	↔	
		ABS	01.04-12.07	59			0 986 <b>BB3 011</b>	↔	
	1.3 MPI 16V		01.04-12.07	59			1 987 <b>477 724</b>	↔ 1400	
	1.3 MPI 16V		01.04-12.07	59			0 265 <b>007 051</b> <sup>4</sup>		
		LAB					0 265 <b>007 102</b> <sup>3</sup>		
		RAB					0 265 <b>007 103</b> <sup>3</sup>		
<b>Siena [Fase I]</b>									
	1.0 MPI 16V		03.00-02.03	52			0 986 <b>473 125</b>	↔ 54	
							0 986 <b>474 125</b>	↔ 54	
	1.3 MPI 16V		03.00-02.03	59			0 986 <b>473 125</b>	↔ 54	
							0 986 <b>474 125</b>	↔ 54	
	1.0 MPI 16V	ABO	03.00-02.03	52			0 986 <b>BB3 009</b>	↔	
		ABS	03.00-02.03	52			0 986 <b>BB3 011</b>	↔	
	1.3 MPI 16V	ABO	03.00-02.03	59			0 986 <b>BB3 009</b>	↔	
		ABS	03.00-02.03	59			0 986 <b>BB3 011</b>	↔	
	1.0 MPI 16V		03.00-02.03	52			1 987 <b>477 724</b>	↔ 1400	
	1.3 MPI 16V		03.00-02.03	59			1 987 <b>477 724</b>	↔ 1400	
	1.0 MPI 16V		03.00-02.03	52			0 265 <b>007 051</b> <sup>4</sup>		
		LAB					0 265 <b>007 102</b> <sup>3</sup>		
		RAB					0 265 <b>007 103</b> <sup>3</sup>		
	1.3 MPI 16V		03.00-09.00	59			0 265 <b>006 249</b> <sup>4</sup>		
		LAB					0 265 <b>006 163</b> <sup>3</sup>		
		RAB					0 265 <b>006 164</b> <sup>3</sup>		
			10.00-02.03	59			0 265 <b>007 051</b> <sup>4</sup>		
		LAB					0 265 <b>007 102</b> <sup>3</sup>		
		RAB					0 265 <b>007 103</b> <sup>3</sup>		
<b>Siena [172..]</b>									
	1.2 i.e. 8V		01.02-03.04	44			1 987 <b>477 724</b>	↔ 1400	
	1.6 i.e. 16V		01.02-03.04	76			1 987 <b>477 724</b>	↔ 1400	
	1.2 i.e. 8V		01.02-03.04	44			0 265 <b>007 051</b> <sup>4</sup>		
		LAB					0 265 <b>007 102</b> <sup>3</sup>		
		RAB					0 265 <b>007 103</b> <sup>3</sup>		
	1.6 i.e. 16V		01.02-03.04	76			0 265 <b>007 051</b> <sup>4</sup>		
		LAB					0 265 <b>007 102</b> <sup>3</sup>		
		RAB					0 265 <b>007 103</b> <sup>3</sup>		
<b>Siena [178..]</b>									
	1.2 i.e. 8V		07.98-12.01	44	MIH		0 986 <b>473 125</b>	↔ 54	
							0 986 <b>474 125</b>	↔ 54	



		S							
<b>FIAT Siena [178..]</b>									
	1.2 i.e. 8V	05.99-12.01	44		MIH	ATE	0986 473 125		← 54
							0986 474 125		→ 54
		01.00-12.01	54		MIH	ATE	0986 473 125		← 54
							0986 474 125		→ 54
	1.4 i.e.	04.98-06.01	51	Fg.-Nr. 0582136→	MIH		0986 473 125		← 54
							0986 474 125		→ 54
		03.00-06.01	51		MIH		0986 473 125		← 54
							0986 474 125		→ 54
	1.6 i.e. 16V	04.98-08.01	76	Fg.-Nr. 0582136→	MIH		0986 473 125		← 54
							0986 474 125		→ 54
		05.98-12.01	76		MIH	ATE	0986 473 125		← 54
							0986 474 125		→ 54
		01.00-12.01	76		MIH		0986 473 125		← 54
							0986 474 125		→ 54
	1.7 TD	05.99-12.01	46/47		MIH	ATE	0986 473 125		← 54
							0986 474 125		→ 54
	1.2 i.e. 8V	01.98-10.01	44				0986 475 966		↔ 19
							0986 475 966		↔ 19
		01.00-12.01	54				0986 475 966		↔ 19
							0986 475 966		↔ 19
		03.00-12.01	44	Ricam.Nr 6230893→			0986 475 966		↔ 19
							0986 475 966		↔ 19
	1.4 i.e.	04.97-02.99	51	Ricam.Nr 3037317→, 6230893→			0986 475 966		↔ 19
							0986 475 966		↔ 19
		05.98-06.01	51	Ricam.Nr 6230893→			0986 475 966		↔ 19
							0986 475 966		↔ 19
	1.6 i.e. 16V	04.97-12.01	76	Ricam.Nr 3037317→, 6230893→			0986 475 966		↔ 19
							0986 475 966		↔ 19
		05.98-12.01	76	Ricam.Nr 6230893→			0986 475 966		↔ 19
							0986 475 966		↔ 19
	1.7 TD	01.00-12.01	47	Ricam.Nr 3037317→, 6230893→			0986 475 966		↔ 19
							0986 475 966		↔ 19
		05.99-05.00	46				0986 475 966		↔ 19
							0986 475 966		↔ 19
	1.2 i.e. 8V	01.98-12.01	44/54				1987 477 724		↔ 1400
							1987 477 724		← 1400
	1.4 i.e.	04.97-06.01	51				1987 477 724		← 1400
							1987 477 724		→ 1400
		05.98-06.01	51				1987 477 724		→ 1400
							1987 477 724		↔ 1400
	1.6 i.e. 16V	04.97-12.01	76				1987 477 724		↔ 1400
							1987 477 724		↔ 1400
	1.7 TD	05.99-12.01	46/47				1987 477 724		↔ 1400
							1987 477 724		↔ 1400
	1.2 i.e. 8V	03.99-12.01	44/54				0265 006 249 <sup>4</sup>		
							0265 006 163 <sup>3</sup>		
							0265 006 164 <sup>3</sup>		
							0265 006 164 <sup>3</sup>		
	1.4 i.e.	04.97-06.01	51				0265 006 249 <sup>4</sup>		
							0265 006 163 <sup>3</sup>		
		07.97-06.01	51				0265 006 164 <sup>3</sup>		
							0265 006 164 <sup>3</sup>		
	1.6 i.e. 16V	04.97-12.01	76				0265 006 249 <sup>4</sup>		
							0265 006 163 <sup>3</sup>		
		07.97-12.01	76				0265 006 164 <sup>3</sup>		
							0265 006 164 <sup>3</sup>		
	1.7 TD	05.99-12.01	46/47				0265 006 249 <sup>4</sup>		
							0265 006 163 <sup>3</sup>		
							0265 006 163 <sup>3</sup>		
							0265 006 164 <sup>3</sup>		
<b>Stilo</b>									
	1.8 MPI 8V	06.02-09.05	76				0986 AB8 445		↔
							0986 AB8 445		↔
	1.8 MPI 8V	ABS	06.02-09.05	76		4SB	1987 477 910		← 1786
							1987 477 911		→ 1668
	1.8 MPI 16V		01.04-12.07	97			1987 477 910		← 1786
							1987 477 911		→ 1668

		S							
1.9 JTD		06.02-12.07	85				1 987 477 910	← 1786	
							1 987 477 911	→ 1668	
2.4 MPI 20V		06.02-12.08	123				1 987 477 910	← 1786	
							1 987 477 911	→ 1668	
 1.8 MPI 8V		06.02-12.07	76/97				0 265 007 400 <sup>4</sup>		
1.8 MPI 16V							0 265 007 401 <sup>3</sup>		
1.9 JTD		06.02-12.07	85				0 265 007 400 <sup>4</sup>		
							0 265 007 401 <sup>3</sup>		
2.4 MPI 20V		06.02-12.08	123				0 265 007 400 <sup>4</sup>		
							0 265 007 401 <sup>3</sup>		
<b>Stilo Multi Wagon [192..]</b>									
									
 1.4 16V		01.04-12.07	66/70				0 204 001 967	← 54	0 204 104 282 <sup>B</sup>
							0 986 473 997		
							0 204 001 968	→ 54	0 204 104 282 <sup>B</sup>
							0 986 474 997		
1.6 16V		10.02-12.07	76/77				0 204 001 967	← 54	0 204 104 282 <sup>B</sup>
1.6 16V Natural Power							0 986 473 997		
							0 204 001 968	→ 54	0 204 104 282 <sup>B</sup>
							0 986 474 997		
1.8 16V		10.02-12.07	98				0 204 001 967	← 54	0 204 104 282 <sup>B</sup>
							0 986 473 997		
							0 204 001 968	→ 54	0 204 104 282 <sup>B</sup>
							0 986 474 997		
1.9 JTD 8V		10.02-12.07	59/66/74/ 85/88				0 204 001 967	← 54	0 204 104 282 <sup>B</sup>
							0 986 473 997		
							0 204 001 968	→ 54	0 204 104 282 <sup>B</sup>
							0 986 474 997		
1.9 JTD 16V		01.04-12.07	93/100/ 103/110				0 204 001 969	← 57	0 204 104 282 <sup>B</sup>
							0 204 001 970	→ 57	0 204 104 282 <sup>B</sup>
2.4 20V		01.04-12.07	125				0 204 001 969	← 57	0 204 104 282 <sup>B</sup>
							0 204 001 970	→ 57	0 204 104 282 <sup>B</sup>
									
 1.4 16V		01.04-11.04	66/70				0 204 001 971	← 38	
							0 986 473 310		
							0 204 001 972	→ 38	
							0 986 474 310		
		12.04-12.07	66/70				0 204 004 437	← 38	
							0 986 134 006		
							0 204 004 438	→ 38	
							0 986 135 006		
1.6 16V		10.02-11.04	76				0 204 001 971	← 38	
							0 986 473 310		
							0 204 001 972	→ 38	
							0 986 474 310		
		12.04-12.07	76				0 204 004 437	← 38	
							0 986 134 006		
		07.05-12.07	77				0 204 004 437	← 38	
							0 986 134 006		
							0 204 004 438	→ 38	
							0 986 135 006		
1.6 16V Natural Power		04.06-12.07	76				0 204 004 437	← 38	
							0 986 134 006		
1.6 16V		12.04-12.07	76				0 204 004 438	→ 38	
1.6 16V Natural Power							0 986 135 006		





FIAT Stilo Multi Wagon [192..]					
1.8 16V	10.02-11.04 98	0 204 001 971	← 38		
		0 986 473 310	↻		
		0 204 001 972	→ 38		
		0 986 474 310	↻		
	12.04-12.07 98	0 204 004 437	← 38		
		0 986 134 006	↻		
		0 204 004 438	→ 38		
		0 986 135 006	↻		
	1.9 JTD 8V	10.02-11.04 59	0 204 001 971	← 38	
			0 986 473 310	↻	
			0 204 001 972	→ 38	
			0 986 474 310	↻	
74/85		0 204 001 971	← 38		
		0 986 473 310	↻		
		0 204 001 972	→ 38		
		0 986 474 310	↻		
12.04-12.07 59		0 204 004 437	← 38		
		0 986 134 006	↻		
		0 204 004 438	→ 38		
		0 986 135 006	↻		
74/85	0 204 004 437	← 38			
	0 986 134 006	↻			
	0 204 004 438	→ 38			
	0 986 135 006	↻			
07.05-12.07 88	0 204 004 437	← 38			
	0 986 134 006	↻			
	0 204 004 438	→ 38			
	0 986 135 006	↻			
10.05-12.07 66	0 204 004 437	← 38			
	0 986 134 006	↻			
	0 204 004 438	→ 38			
	0 986 135 006	↻			
1.9 JTD 16V	01.04-11.04 93/100/103	0 204 001 971	← 38		
		0 986 473 310	↻		
		0 204 001 972	→ 38		
		0 986 474 310	↻		
	12.04-12.07 93/100/103	0 204 004 437	← 38		
		0 986 134 006	↻		
		0 204 004 438	→ 38		
		0 986 135 006	↻		
	07.05-12.07 110	0 204 004 437	← 38		
		0 986 134 006	↻		
		0 204 004 438	→ 38		
		0 986 135 006	↻		
2.4 20V	01.04-11.04 125	0 204 001 971	← 38		
		0 986 473 310	↻		
		0 204 001 972	→ 38		
	12.04-12.07 125	0 986 474 310	↻		
		0 204 004 437	← 38		
		0 986 134 006	↻		
1.4 16V	01.04-12.07 66/70	1 987 477 910	← 1786		
		1 987 477 911	→ 1668		
	1.6 16V	10.02-12.07 76/77	1 987 477 910	← 1786	
			1 987 477 911	→ 1668	
	1.6 16V Natural Power	10.02-12.07 98	1 987 477 910	← 1786	
			1 987 477 911	→ 1668	
1.9 JTD 8V	10.02-12.07 59/66/74/85/88/93/	1 987 477 910	← 1786		
		1 987 477 911	→ 1668		
1.9 JTD 16V	100/103/110	1 987 477 910	← 1786		
		1 987 477 911	→ 1668		

		S							
2.4 20V		01.04-12.07	125				1 987 477 910	← 1786	
							1 987 477 911	→ 1668	
1.4 16V		01.04-12.07	66/70				0 265 007 401 <sup>3</sup>		
							0 265 008 003 <sup>4</sup>		
1.6 16V		10.02-12.07	76/77				0 265 007 401 <sup>3</sup>		
1.6 16V Natural Power							0 265 008 003 <sup>4</sup>		
1.8 16V		10.02-12.07	98				0 265 007 401 <sup>3</sup>		
							0 265 008 003 <sup>4</sup>		
1.9 JTD 8V		10.02-12.07	59/66/74/85/88/93/				0 265 007 401 <sup>3</sup>		
1.9 JTD 16V			100/103/110				0 265 008 003 <sup>4</sup>		
2.4 20V		01.04-12.07	125				0 265 007 401 <sup>3</sup>		
							0 265 008 003 <sup>4</sup>		
<b>Stilo [192..]</b>									
1.2 16V		10.01-12.03	59				0 204 001 965	← 54	0 204 104 279 <sup>7</sup>
							0 204 001 966	→ 54	0 204 104 279 <sup>7</sup>
1.4 16V		01.04-12.07	66/70				0 204 001 965	← 54	0 204 104 279 <sup>7</sup>
							0 204 001 966	→ 54	0 204 104 279 <sup>7</sup>
1.6 16V		10.01-12.07	76/77				0 204 001 965	← 54	0 204 104 279 <sup>7</sup>
							0 204 001 966	→ 54	0 204 104 279 <sup>7</sup>
1.8 16V		10.01-12.07	98				0 204 001 967	← 54	0 204 104 282 <sup>8</sup>
							0 986 473 997		
							0 204 001 968	→ 54	0 204 104 282 <sup>8</sup>
							0 986 474 997		
1.9 JTD 8V		10.01-12.07	59/66/74/ 85/88				0 204 001 967	← 54	0 204 104 282 <sup>8</sup>
							0 986 473 997		
							0 204 001 968	→ 54	0 204 104 282 <sup>8</sup>
							0 986 474 997		
1.9 JTD 16V		01.04-12.07	93/100/ 103/110				0 204 001 969	← 57	0 204 104 282 <sup>8</sup>
							0 204 001 970	→ 57	0 204 104 282 <sup>8</sup>
2.4 20V		10.01-12.07	125				0 204 001 969	← 57	0 204 104 282 <sup>8</sup>
							0 204 001 970	→ 57	0 204 104 282 <sup>8</sup>
1.2 16V		10.01-12.03	59				0 204 001 971	← 38	
							0 986 473 310		
							0 204 001 972	→ 38	
							0 986 474 310		
1.4 16V		01.04-11.04	66/70				0 204 001 971	← 38	
							0 986 473 310		
							0 204 001 972	→ 38	
							0 986 474 310		
		12.04-12.07	66/70				0 204 004 437	← 38	
							0 986 134 006		
							0 204 004 438	→ 38	
							0 986 135 006		
1.6 16V		10.01-11.04	76				0 204 001 971	← 38	
							0 986 473 310		
							0 204 001 972	→ 38	
							0 986 474 310		
		12.04-12.07	76				0 204 004 437	← 38	
							0 986 134 006		
							0 204 004 438	→ 38	
							0 986 135 006		
		07.05-12.07	77				0 204 004 437	← 38	
							0 986 134 006		
							0 204 004 438	→ 38	
							0 986 135 006		





FIAT Stilo [192..]					
1.8 16V	10.01-11.04 98	0 204 001 971	← 38		
		0 986 473 310	↻		
		0 204 001 972	→ 38		
		0 986 474 310	↻		
	12.04-12.07 98	0 204 004 437	← 38		
		0 986 134 006	↻		
		0 204 004 438	→ 38		
		0 986 135 006	↻		
	1.9 JTD 8V	10.01-11.04 59	0 204 001 971	← 38	
			0 986 473 310	↻	
			0 204 001 972	→ 38	
			0 986 474 310	↻	
74/85		0 204 001 971	← 38		
		0 986 473 310	↻		
		0 204 001 972	→ 38		
		0 986 474 310	↻		
12.04-12.07 59		0 204 004 437	← 38		
		0 986 134 006	↻		
		0 204 004 438	→ 38		
		0 986 135 006	↻		
74/85	0 204 004 437	← 38			
	0 986 134 006	↻			
	0 204 004 438	→ 38			
	0 986 135 006	↻			
07.05-12.07 88	0 204 004 437	← 38			
	0 986 134 006	↻			
	0 204 004 438	→ 38			
	0 986 135 006	↻			
10.05-12.07 66	0 204 004 437	← 38			
	0 986 134 006	↻			
	0 204 004 438	→ 38			
	0 986 135 006	↻			
1.9 JTD 16V	01.04-11.04 93/100/103	0 204 001 971	← 38		
		0 986 473 310	↻		
		0 204 001 972	→ 38		
		0 986 474 310	↻		
	12.04-12.07 93/100/103	0 204 004 437	← 38		
		0 986 134 006	↻		
		0 204 004 438	→ 38		
		0 986 135 006	↻		
	07.05-12.07 110	0 204 004 437	← 38		
		0 986 134 006	↻		
		0 204 004 438	→ 38		
		0 986 135 006	↻		
2.4 20V	10.01-11.04 125	0 204 001 971	← 38		
		0 986 473 310	↻		
		0 204 001 972	→ 38		
		0 986 474 310	↻		
	12.04-12.07 125	0 204 004 437	← 38		
		0 986 134 006	↻		
1.2 16V	10.01-12.03 59	1 987 477 910	← 1786		
		1 987 477 911	→ 1668		
	1.4 16V	01.04-12.07 66/70	1 987 477 910	← 1786	
			1 987 477 911	→ 1668	
	1.6 16V	10.01-12.07 76/77	1 987 477 910	← 1786	
			1 987 477 911	→ 1668	
	1.8 16V	10.01-12.07 98	1 987 477 910	← 1786	
			1 987 477 911	→ 1668	

	S							
1.9 JTD 8V	10.01-12.07	59/66/74/85/88/93/				1 987 477 910	← 1786	
1.9 JTD 16V		100/103/110				1 987 477 911	→ 1668	
2.4 20V	10.01-12.07	125				1 987 477 910	← 1786	
						1 987 477 911	→ 1668	
1.2 16V	10.01-12.03	59				0 265 007 401 <sup>3</sup>		
			Fg.-Nr. 312323→			0 265 008 003 <sup>4</sup>		
			Ricam.Nr →312322			0 265 007 400 <sup>4</sup>		
1.4 16V	01.04-12.07	66/70				0 265 007 401 <sup>3</sup>		
						0 265 008 003 <sup>4</sup>		
1.6 16V	10.01-12.03	76	Fg.-Nr. 312323→			0 265 008 003 <sup>4</sup>		
			Ricam.Nr →312322			0 265 007 400 <sup>4</sup>		
	10.01-12.07	76				0 265 007 401 <sup>3</sup>		
	01.04-12.07	76				0 265 008 003 <sup>4</sup>		
	07.05-12.07	77				0 265 007 401 <sup>3</sup>		
						0 265 008 003 <sup>4</sup>		
1.8 16V	10.01-12.03	98	Fg.-Nr. 312323→			0 265 008 003 <sup>4</sup>		
			Ricam.Nr →312322			0 265 007 400 <sup>4</sup>		
	10.01-12.07	98				0 265 007 401 <sup>3</sup>		
	01.04-12.07	98				0 265 008 003 <sup>4</sup>		
1.9 JTD 8V	10.01-12.03	59	Fg.-Nr. 312323→			0 265 008 003 <sup>4</sup>		
			Ricam.Nr →312322			0 265 007 400 <sup>4</sup>		
		85	Fg.-Nr. 312323→			0 265 008 003 <sup>4</sup>		
			Ricam.Nr →312322			0 265 007 400 <sup>4</sup>		
	10.01-12.07	59				0 265 007 401 <sup>3</sup>		
		85				0 265 007 401 <sup>3</sup>		
	01.04-12.07	59				0 265 008 003 <sup>4</sup>		
		66/74				0 265 007 401 <sup>3</sup>		
						0 265 008 003 <sup>4</sup>		
		85				0 265 008 003 <sup>4</sup>		
1.9 JTD 8V	01.04-12.07	88/93/100/				0 265 007 401 <sup>3</sup>		
1.9 JTD 16V		103/110				0 265 008 003 <sup>4</sup>		
2.4 20V	10.01-12.03	125	Fg.-Nr. 312323→			0 265 008 003 <sup>4</sup>		
			Ricam.Nr →312322			0 265 007 400 <sup>4</sup>		
	10.01-12.07	125				0 265 007 401 <sup>3</sup>		
	01.04-12.07	125				0 265 008 003 <sup>4</sup>		
<b>Strada</b>								
1.7 D Turbo	07.99-12.04	52				0 986 473 125	👁️ ← 54	
						0 986 474 125	👁️ → 54	
1.7 D Turbo	07.99-12.04	52				0 986 AB8 445	↔	
1.7 D Turbo	07.99-12.04	52				1 987 477 829	→ 1710	
						1 987 477 830	← 1710	
1.7 D Turbo	07.99-12.04	52		LAB		0 265 007 054 <sup>4</sup>		
						0 265 007 102 <sup>3</sup>		
				RAB		0 265 007 055 <sup>4</sup>		
						0 265 007 103 <sup>3</sup>		





		S							
◀ FIAT									
<b>Strada [Fase I]</b>									
	1.5 MPI 8V	10.98-01.02	56				0986 473 125		← 54
							0986 474 125		→ 54
	1.5 MPI 8V	10.98-02.03	56				0986 AB8 445		↔
	1.5 MPI 8V	10.98-02.03	56				1987 477 829		→ 1710
							1987 477 830		← 1710
	1.5 MPI 8V	10.98-02.03	56			LAB	0265 007 049 <sup>3</sup>		
							0265 007 054 <sup>4</sup>		
						RAB	0265 007 050 <sup>3</sup>		
							0265 007 055 <sup>4</sup>		
<b>Strada [Fase II]</b>									
	1.7 D Turbo	01.05-12.08	52				0986 473 125		← 54
							0986 474 125		→ 54
	1.7 D Turbo	01.05-12.08	52				0986 AB8 445		↔
	1.7 D Turbo	01.05-12.08	52				1987 477 829		→ 1710
							1987 477 830		← 1710
	1.7 D Turbo	01.05-12.08	52			LAB	0265 007 054 <sup>4</sup>		
							0265 007 102 <sup>3</sup>		
						RAB	0265 007 055 <sup>4</sup>		
							0265 007 103 <sup>3</sup>		
<b>Strada [278]</b>									
	1.2 MPI 8V	03.99-06.05	44/54			MIH	0986 473 125		← 54
							0986 474 125		→ 54
	1.3 JTD	07.05-12.11	63			MIH	0986 473 125		← 54
							0986 474 125		→ 54
	1.7 TDS	03.99-03.03	51			MIH	0986 473 125		← 54
							0986 474 125		→ 54
	1.9 D	11.00-06.05	46/59			MIH	0986 473 125		← 54
	1.9 JTD						0986 474 125		→ 54
	1.3 Multijet	12.11→	70			ADV	0986 475 901		↔ 20,64
						FKR,NAV	0986 475 867		↔ 20,64
						FLR,NAV	0986 475 901		↔ 20,64

F

		S										
	1.2 MPI 8V	03.99-06.05	44/54				1 987 477 829	→ 1710				
							1 987 477 830	← 1710				
	1.3 JTD	07.05→	63/70				1 987 477 829	→ 1710				
	1.3 Multijet						1 987 477 830	← 1710				
	1.7 TDS	03.99-03.03	51				1 987 477 829	→ 1710				
							1 987 477 830	← 1710				
	1.9 D	11.00-06.05	46/59				1 987 477 829	→ 1710				
	1.9 JTD						1 987 477 830	← 1710				
	1.2 MPI 8V	03.99-03.05	44			LAB	0 265 007 049 <sup>3</sup>					
							0 265 007 054 <sup>4</sup>					
							RAB	0 265 007 050 <sup>3</sup>				
								0 265 007 055 <sup>4</sup>				
			05.01-03.03	54			LAB	0 265 007 049 <sup>3</sup>				
							RAB	0 265 007 050 <sup>3</sup>				
			05.01-06.05	54			LAB	0 265 007 054 <sup>4</sup>				
							RAB	0 265 007 055 <sup>4</sup>				
			04.03-06.05	54			ATJ,LAB	0 265 007 102 <sup>3</sup>				
							ATJ,RAB	0 265 007 103 <sup>3</sup>				
							ATN,LAB	0 265 007 049 <sup>3</sup>				
							ATN,RAB	0 265 007 050 <sup>3</sup>				
		1.3 JTD	07.05-12.11	63			LAB	0 265 007 054 <sup>4</sup>				
								0 265 007 102 <sup>3</sup>				
							RAB	0 265 007 055 <sup>4</sup>				
								0 265 007 103 <sup>3</sup>				
		1.3 Multijet	12.11→	70			ATJ,LAB	0 265 007 054 <sup>4</sup>				
									0 265 007 102 <sup>3</sup>			
									ATJ,RAB	0 265 007 055 <sup>4</sup>		
										0 265 007 103 <sup>3</sup>		
						AUB,FKR,	0 265 007 054 <sup>4</sup>					
						LAB	0 265 007 102 <sup>3</sup>					
						AUB,FKR,	0 265 007 055 <sup>4</sup>					
						RAB	0 265 007 103 <sup>3</sup>					
	1.7 TDS	03.99-03.03	51			LAB	0 265 007 049 <sup>3</sup>					
								0 265 007 054 <sup>4</sup>				
						RAB	0 265 007 050 <sup>3</sup>					
							0 265 007 055 <sup>4</sup>					
	1.9 D	11.00-06.05	46/59			LAB	0 265 007 049 <sup>3</sup>					
								0 265 007 054 <sup>4</sup>				
						RAB	0 265 007 050 <sup>3</sup>					
							0 265 007 055 <sup>4</sup>					
<b>Talento</b>												
	1.9 D	03.88-02.94	51				0 986 473 776	← 38				
							0 986 473 777	→ 38				
	2.0	07.90-02.94	55				0 986 473 776	← 38				
								0 986 473 777	→ 38			
	1.9 D	03.88-12.94	51				0 986 475 056	↔ 22,2				
	2.0	07.90-12.94	55				0 986 475 056	↔ 22,2				
<b>Tempra</b>												
	2.0 SPI 8V	11.92-12.98	71/81				0 986 AB8 445	↔				
	2.0 8V											



			S							
◀ FIAT Tempra										
	2.0 SPI 8V	05.94-12.98	81					0 265 006 402 <sup>3</sup>		
								0 265 006 403 <sup>4</sup>		
<b>Tempra SW [159]</b>										
	1.4	04.93-12.96	51/56			MIH		0 204 102 530	← 54	0 204 104 237 <sup>7</sup>
	1.4 i.e.							0 204 103 530		
								0 204 102 531	→ 54	0 204 104 237 <sup>7</sup>
								0 204 103 531		
	1.6	04.93-12.96	62/66			MIH		0 204 102 530	← 54	0 204 104 237 <sup>7</sup>
	1.6 i.e.							0 204 103 530		
								0 204 102 531	→ 54	0 204 104 237 <sup>7</sup>
								0 204 103 531		
	1.6 i.e.	04.93-12.96	55					0 204 102 530	← 54	0 204 104 237 <sup>7</sup>
								0 204 103 530		
								0 204 102 531	→ 54	0 204 104 237 <sup>7</sup>
								0 204 103 531		
	1.6 i.e. Selecta	04.93-12.96	55			MIH		0 204 102 530	← 54	0 204 104 237 <sup>7</sup>
								0 204 103 530		
								0 204 102 531	→ 54	0 204 104 237 <sup>7</sup>
								0 204 103 531		
	1.8 i.e.	04.93-12.96	66/71/77					0 204 102 532	← 54	0 204 104 237 <sup>7</sup>
								0 204 103 532		
								0 204 102 533	→ 54	0 204 104 237 <sup>7</sup>
								0 204 103 533		
	1.9 D	04.93-12.96	48					0 204 102 530	← 54	0 204 104 237 <sup>7</sup>
								0 204 103 530		
								0 204 102 531	→ 54	0 204 104 237 <sup>7</sup>
								0 204 103 531		
	1.9 TD	04.93-12.96	66					0 204 102 532	← 54	0 204 104 237 <sup>7</sup>
								0 204 103 532		
								0 204 102 533	→ 54	0 204 104 237 <sup>7</sup>
								0 204 103 533		
	1.4, i.e.	04.93-12.96	51/56					F 026 002 158	↔ 20,6	
	1.6, i.e., i.e. Selecta	04.93-12.96	55/62/66					F 026 002 158	↔ 20,6	
	1.8 i.e.	ABO 04.93-12.96	66/71/77					F 026 002 158	↔ 20,6	
	1.9 D, TD	ABO 04.93-12.96	48/66					F 026 002 158	↔ 20,6	
	1.4	04.93-12.96	51/56	Ricam.Nr → VETT.6090901	GIM			0 986 471 009	→ 34	1 987 470 028 <sup>7</sup>
	1.4 i.e.							0 986 474 077		
								0 986 471 010	← 34	1 987 470 028 <sup>7</sup>
								0 986 473 077		
				Ricam.Nr VETT.6090902 →	GIM			0 986 473 121	← 33,9	1 987 470 028 <sup>7</sup>
								0 986 474 121	→ 33,9	1 987 470 028 <sup>7</sup>
	1.6	04.93-12.96	55/62/66	Ricam.Nr → VETT.6090901	GIM			0 986 471 009	→ 34	1 987 470 028 <sup>7</sup>
	1.6 i.e.							0 986 474 077		
	1.6 i.e. Selecta							0 986 471 010	← 34	1 987 470 028 <sup>7</sup>
								0 986 473 077		
				Ricam.Nr VETT.6090902 →	GIM			0 986 473 121	← 33,9	1 987 470 028 <sup>7</sup>
								0 986 474 121	→ 33,9	1 987 470 028 <sup>7</sup>
	1.6 i.e.	ABS 04.93-12.96	55					0 986 471 009	→ 34	1 987 470 028 <sup>7</sup>
								0 986 474 077		
								0 986 471 010	← 34	1 987 470 028 <sup>7</sup>
								0 986 473 077		



		S									
1.8 i.e.		04.93-12.96	66/71/77	Ricam.Nr →VETT.6090901	GIM		0 986 471 009	→ 34	1 987 470 028 <sup>7</sup>		
							0 986 474 077				
							0 986 471 010	← 34	1 987 470 028 <sup>7</sup>		
							0 986 473 077				
							Ricam.Nr VETT.6090902 →	GIM	0 986 473 121	← 33,9	1 987 470 028 <sup>7</sup>
							0 986 474 121	→ 33,9	1 987 470 028 <sup>7</sup>		
2.0 i.e. 2.0 i.e. 4x4		04.93-12.96	83-85	Ricam.Nr →VETT.6090901	GIM		0 986 471 009	→ 34	1 987 470 028 <sup>7</sup>		
							0 986 474 077				
							0 986 471 010	← 34	1 987 470 028 <sup>7</sup>		
							0 986 473 077				
							Ricam.Nr VETT.6090902 →	GIM	0 986 473 121	← 33,9	1 987 470 028 <sup>7</sup>
							0 986 474 121	→ 33,9	1 987 470 028 <sup>7</sup>		
		03.94-12.96	83-85	Ricam.Nr VETT.7490102 →	GIM,MIH		0 986 471 009	→ 34	1 987 470 028 <sup>7</sup>		
							0 986 474 077				
							0 986 471 010	← 34	1 987 470 028 <sup>7</sup>		
							0 986 473 077				
							ABO 04.93-02.94	83-85	Ricam.Nr →VETT.7490101	MIH	BSY
					0 204 103 475						
						0 204 102 476	→ 36	0 204 104 238 <sup>7</sup>			
						0 204 103 476					
	1.4 1.4 i.e.	04.93-12.95	51/56		SBR		1 987 477 375	→ 1460			
							1 987 477 376	← 1495			
							04.93-12.96	51/56		TBR	1 987 477 832
								1 987 477 089	→ 1405		
								1 987 482 149	← 1445		
				01.96-12.96	51/56			1 987 477 375	→ 1460		
								1 987 477 382	← 1517		
		1.6 1.6 i.e.	04.93-12.95	62/66			SBR		1 987 477 375	→ 1460	
									1 987 477 376	← 1495	
									04.93-12.96	62/66	
								1 987 477 089	→ 1405		
								1 987 482 149	← 1445		
				01.96-12.96	62/66			1 987 477 375	→ 1460		
								1 987 477 382	← 1517		
		1.6 i.e.	04.93-12.96	55					1 987 477 375	→ 1460	
1 987 477 382	← 1517										
1.6 i.e. Selecta	04.93-12.95	55			SBR		1 987 477 375	→ 1460			
							1 987 477 376	← 1495			
		01.96-12.96	55				1 987 477 375	→ 1460			
							1 987 477 382	← 1517			
1.6 i.e. 1.6 i.e. Selecta	04.93-12.96	55					1 987 477 832	406			
							TBR	1 987 477 089	→ 1405		
							1 987 482 149	← 1445			
1.8 i.e.	04.93-12.96	66/71/77					1 987 477 832	406			
							SBR	1 987 477 375	→ 1460		
							1 987 477 382	← 1517			
							TBR	1 987 477 089	→ 1405		
							1 987 482 149	← 1445			
1.9D 1.9TD	04.93-12.96	48/66					1 987 477 375	→ 1460			
							1 987 477 382	← 1517			
							TBR	1 987 477 089	1405		
2.0 i.e.	04.93-12.95	83-85					1 987 477 375	→ 1460			
							1 987 477 382	← 1517			
							04.93-12.96	83-85			1 987 477 832
		01.96-12.96	83-85				1 987 477 382	1517			
	1.4 1.4 i.e.	04.93-03.96	51/56				0 265 001 215 <sup>3</sup>				
							LAB	0 265 001 216 <sup>4</sup>			
							RAB	0 265 001 217 <sup>4</sup>			



		S							
<b>FIAT Tempra SW [159]</b>									
1.4		04.96-12.96	51/56				0 265 006 197 <sup>4</sup>		
1.4 i.e.							0 265 006 212 <sup>3</sup>		
1.6		04.93-03.96	55/62/66				0 265 001 215 <sup>3</sup>		
1.6 i.e.						LAB	0 265 001 216 <sup>4</sup>		
1.6 i.e. Selecta						RAB	0 265 001 217 <sup>4</sup>		
		04.96-12.96	55/62/66				0 265 006 197 <sup>4</sup>		
							0 265 006 212 <sup>3</sup>		
1.8 i.e.		04.93-03.96	66/71/77				0 265 001 215 <sup>3</sup>		
						LAB	0 265 001 216 <sup>4</sup>		
						RAB	0 265 001 217 <sup>4</sup>		
		04.96-12.96	66/71/77				0 265 006 197 <sup>4</sup>		
							0 265 006 212 <sup>3</sup>		
1.9D		04.93-12.96	48/66				0 265 001 215 <sup>3</sup>		
1.9 TD						LAB	0 265 001 216 <sup>4</sup>		
						RAB	0 265 001 217 <sup>4</sup>		
2.0 i.e.		04.93-03.96	83-85				0 265 001 215 <sup>3</sup>		
						LAB	0 265 001 216 <sup>4</sup>		
						RAB	0 265 001 217 <sup>4</sup>		
		04.96-12.96	83-85				0 265 006 197 <sup>4</sup>		
							0 265 006 212 <sup>3</sup>		
2.0 i.e. 4x4		04.93-12.96	83-85				0 265 001 215 <sup>3</sup>		
							0 265 001 304 <sup>4</sup>		

**Tempra [159]**

1.4		ABO	04.93-12.96	51/56		MHH			0 204 104 237 <sup>7</sup>
1.4 i.e.		ABS	04.93-12.96	51/56		MHH	0 204 102 530	← 54	0 204 104 237 <sup>7</sup>
							0 204 103 530		
							0 204 102 531	→ 54	0 204 104 237 <sup>7</sup>
							0 204 103 531		
1.6		ABO	04.93-12.96	55/62/66		MHH			0 204 104 237 <sup>7</sup>
1.6 i.e.		ABS	04.93-12.96	62/66		MHH	0 204 102 530	← 54	0 204 104 237 <sup>7</sup>
							0 204 103 530		
							0 204 102 531	→ 54	0 204 104 237 <sup>7</sup>
							0 204 103 531		
1.6 i.e.		ABS	04.93-12.96	55		MHH	0 204 102 530	← 54	0 204 104 237 <sup>7</sup>
							0 204 103 530		
							0 204 102 531	→ 54	0 204 104 237 <sup>7</sup>
							0 204 103 531		
1.6 i.e. Selecta			04.93-12.96	55			0 204 102 530	← 54	0 204 104 237 <sup>7</sup>
							0 204 103 530		
							0 204 102 531	→ 54	0 204 104 237 <sup>7</sup>
							0 204 103 531		
1.8 i.e.			04.93-12.96	66/71/77			0 204 102 530	← 54	0 204 104 237 <sup>7</sup>
							0 204 103 530		
							0 204 102 531	→ 54	0 204 104 237 <sup>7</sup>
							0 204 103 531		
1.9D			04.93-12.96	48			0 204 102 530	← 54	
							0 204 103 530		
							0 204 102 531	→ 54	
							0 204 103 531		
1.9 TD			04.93-12.96	66			0 204 102 530	← 54	0 204 104 237 <sup>7</sup>
							0 204 103 530		
							0 204 102 531	→ 54	0 204 104 237 <sup>7</sup>
							0 204 103 531		
1.4 i.e.			04.93-12.96	51/56			F 026 002 178	↔ 22,2	
1.6 i.e.			04.93-12.96	62/66			F 026 002 178	↔ 22,2	
1.6 i.e.			04.93-12.96	55			F 026 002 178	↔ 22,2	
1.6 i.e. Selecta			04.93-12.96	55			F 026 002 158	↔ 20,6	

				S							
<b>1.8 i.e.</b>	ABO	04.93-12.96	66/71/77						F 026 <b>002 158</b>	↔ 20,6	
<b>1.9 D</b>	ABO	04.93-12.96	48						F 026 <b>002 178</b>	↔ 22,2	
<b>1.9 TD</b>	ABO	04.93-12.96	66						F 026 <b>002 158</b>	↔ 20,6	
	<b>1.4</b>	04.93-12.96	51/56	Ricam.Nr → VETT.6090901	GIM				0 986 <b>471 009</b>	→ 34	1 987 <b>470 028</b> <sup>7</sup>
	<b>1.4 i.e.</b>								0 986 <b>474 077</b>	↔	
									0 986 <b>471 010</b>	← 34	1 987 <b>470 028</b> <sup>7</sup>
									0 986 <b>473 077</b>	↔	
					Ricam.Nr VETT.6090902 →	GIM			0 986 <b>473 121</b>	↔ 33,9	1 987 <b>470 028</b> <sup>7</sup>
									0 986 <b>474 121</b>	↔ 33,9	1 987 <b>470 028</b> <sup>7</sup>
	<b>1.6</b>	04.93-12.96	55/62/66	Ricam.Nr → VETT.6090901	GIM				0 986 <b>471 009</b>	→ 34	1 987 <b>470 028</b> <sup>7</sup>
	<b>1.6 i.e.</b>								0 986 <b>474 077</b>	↔	
	<b>1.6 i.e. Selecta</b>								0 986 <b>471 010</b>	← 34	1 987 <b>470 028</b> <sup>7</sup>
									0 986 <b>473 077</b>	↔	
					Ricam.Nr VETT.6090902 →	GIM			0 986 <b>473 121</b>	↔ 33,9	1 987 <b>470 028</b> <sup>7</sup>
									0 986 <b>474 121</b>	↔ 33,9	1 987 <b>470 028</b> <sup>7</sup>
<b>1.8 i.e.</b>	04.93-12.96	66/71/77	Ricam.Nr → VETT.6090901	GIM				0 986 <b>471 009</b>	→ 34	1 987 <b>470 028</b> <sup>7</sup>	
								0 986 <b>474 077</b>	↔		
								0 986 <b>471 010</b>	← 34	1 987 <b>470 028</b> <sup>7</sup>	
								0 986 <b>473 077</b>	↔		
				Ricam.Nr VETT.6090902 →	GIM			0 986 <b>473 121</b>	↔ 33,9	1 987 <b>470 028</b> <sup>7</sup>	
								0 986 <b>474 121</b>	↔ 33,9	1 987 <b>470 028</b> <sup>7</sup>	
<b>2.0 i.e.</b>	04.93-12.96	83-85	Ricam.Nr → VETT.6090901	GIM				0 986 <b>471 009</b>	→ 34	1 987 <b>470 028</b> <sup>7</sup>	
								0 986 <b>474 077</b>	↔		
								0 986 <b>471 010</b>	← 34	1 987 <b>470 028</b> <sup>7</sup>	
								0 986 <b>473 077</b>	↔		
				Ricam.Nr VETT.6090902 →	GIM			0 986 <b>473 121</b>	↔ 33,9	1 987 <b>470 028</b> <sup>7</sup>	
								0 986 <b>474 121</b>	↔ 33,9	1 987 <b>470 028</b> <sup>7</sup>	
		03.94-12.96	83-85	Ricam.Nr VETT.7490102 →	GIM, MIH			0 986 <b>471 009</b>	→ 34	1 987 <b>470 028</b> <sup>7</sup>	
								0 986 <b>474 077</b>	↔		
								0 986 <b>471 010</b>	← 34	1 987 <b>470 028</b> <sup>7</sup>	
								0 986 <b>473 077</b>	↔		
	ABO	04.93-02.94	83-85	Ricam.Nr → VETT.7490101	MIH BSY			0 204 <b>102 475</b>	← 36	0 204 <b>104 238</b> <sup>7</sup>	
								0 204 <b>103 475</b>	↔		
								0 204 <b>102 476</b>	→ 36	0 204 <b>104 238</b> <sup>7</sup>	
								0 204 <b>103 476</b>	↔		
	<b>1.4</b>	04.93-12.95	51/56		SBR				1 987 <b>477 375</b>	→ 1460	
	<b>1.4 i.e.</b>								1 987 <b>477 376</b>	← 1495	
						TBR			1 987 <b>477 087</b>	← 1415	
									1 987 <b>477 088</b>	→ 1375	
		04.93-12.96	51/56						1 987 <b>477 832</b>	406	
		01.96-12.96	51/56						1 987 <b>477 375</b>	→ 1460	
									1 987 <b>477 382</b>	← 1517	
	<b>1.6</b>	04.93-12.95	62/66		SBR				1 987 <b>477 375</b>	→ 1460	
	<b>1.6 i.e.</b>								1 987 <b>477 376</b>	← 1495	
						TBR			1 987 <b>477 087</b>	← 1415	
									1 987 <b>477 088</b>	→ 1375	
		04.93-12.96	62/66						1 987 <b>477 832</b>	406	
		01.96-12.96	62/66						1 987 <b>477 375</b>	→ 1460	
									1 987 <b>477 382</b>	← 1517	
	<b>1.6 i.e.</b>	04.93-12.95	55		TBR				1 987 <b>477 087</b>	← 1415	
									1 987 <b>477 088</b>	→ 1375	
		04.93-12.96	55						1 987 <b>477 832</b>	406	
	<b>1.6 i.e. Selecta</b>	04.93-12.96	55						1 987 <b>477 832</b>	406	
						TBR			1 987 <b>477 089</b>	→ 1405	
									1 987 <b>482 149</b>	← 1445	
<b>1.6 i.e.</b>	04.93-12.95	55		SBR				1 987 <b>477 375</b>	→ 1460		
<b>1.6 i.e. Selecta</b>								1 987 <b>477 376</b>	← 1495		
	01.96-12.96	55						1 987 <b>477 375</b>	→ 1460		
								1 987 <b>477 382</b>	← 1517		





	◀ FIAT Tempra [159]				
1.8 i.e.	04.93-12.96	66		1987 477 832	406
			SBR	1987 477 375	→ 1460
				1987 477 382	← 1517
			TBR	1987 477 089	→ 1405
				1987 482 149	← 1445
		77		1987 477 832	406
			SBR	1987 477 375	→ 1460
				1987 477 382	← 1517
			TBR	1987 477 089	→ 1405
				1987 482 149	← 1445
	03.95-12.96	71		1987 477 375	→ 1460
				1987 477 382	← 1517
				1987 477 832	406
			TBR	1987 477 089	→ 1405
				1987 482 149	← 1445
1.9 D	04.93-12.96	48/66		1987 477 375	→ 1460
1.9 TD				1987 477 382	← 1517
			TBR	1987 477 089	1405
2.0 i.e.	04.93-12.95	83-85		1987 477 375	→ 1460
				1987 477 382	← 1517
	04.93-12.96	83-85		1987 477 832	406
	01.96-12.96	83-85		1987 477 382	1517

	1.4	04.93-03.96	51/56		0 265 001 215 <sup>3</sup>
	1.4 i.e.			LAB	0 265 001 216 <sup>4</sup>
				RAB	0 265 001 217 <sup>4</sup>
		04.96-12.96	51/56		0 265 006 197 <sup>4</sup>
					0 265 006 212 <sup>3</sup>
	1.6	04.93-03.96	55/62/66		0 265 001 215 <sup>3</sup>
	1.6 i.e.			LAB	0 265 001 216 <sup>4</sup>
	1.6 i.e. Selecta			RAB	0 265 001 217 <sup>4</sup>
		04.96-12.96	55/62/66		0 265 006 197 <sup>4</sup>
					0 265 006 212 <sup>3</sup>
	1.8 i.e.	04.93-03.96	66/71		0 265 001 215 <sup>3</sup>
				LAB	0 265 001 216 <sup>4</sup>
				RAB	0 265 001 217 <sup>4</sup>
			77		0 265 001 215 <sup>3</sup>
		04.93-12.96	77	LAB	0 265 001 216 <sup>4</sup>
				RAB	0 265 001 217 <sup>4</sup>
		04.96-12.96	66/71		0 265 006 197 <sup>4</sup>
					0 265 006 212 <sup>3</sup>
			77		0 265 006 197 <sup>4</sup>
					0 265 006 212 <sup>3</sup>
	1.9 D	04.93-12.96	48/66		0 265 001 215 <sup>3</sup>
	1.9 TD			LAB	0 265 001 216 <sup>4</sup>
				RAB	0 265 001 217 <sup>4</sup>
	2.0 i.e.	04.93-03.96	83-85		0 265 001 215 <sup>3</sup>
				LAB	0 265 001 216 <sup>4</sup>
				RAB	0 265 001 217 <sup>4</sup>
		04.96-12.96	83-85		0 265 006 197 <sup>4</sup>
					0 265 006 212 <sup>3</sup>

**Tipo**

	1.6 MPI 8V	12.95-05.97	66		1987 477 087	← 1415
					1987 477 088	→ 1375

		S				?			
<b>Tipo [160..]</b>									
	<b>1.1 i.e.</b>	ABO	10.94-12.94	37	Ricam.Nr →4926731	MIH	BSY		0 204 <b>104 237</b> <sup>7</sup>
			01.95-10.95	37	Ricam.Nr 4926732→	MIH	BSY	0 204 <b>102 530</b>	← 54 0 204 <b>104 237</b> <sup>7</sup>
								0 204 <b>103 530</b>	
								0 204 <b>102 531</b>	→ 54 0 204 <b>104 237</b> <sup>7</sup>
								0 204 <b>103 531</b>	
		ABS	10.94-10.95	37			BSY	0 204 <b>102 530</b>	← 54 0 204 <b>104 194</b> <sup>7</sup>
								0 204 <b>103 530</b>	
								0 204 <b>102 531</b>	→ 54 0 204 <b>104 194</b> <sup>7</sup>
								0 204 <b>103 531</b>	
<b>1.4</b>		ABO	10.94-12.94	51/52	Ricam.Nr →4926731	MIH	BSY		0 204 <b>104 237</b> <sup>7</sup>
<b>1.4 i.e.</b>			01.95-10.95	51/52	Ricam.Nr 4926732→	MIH	BSY	0 204 <b>102 530</b>	← 54 0 204 <b>104 237</b> <sup>7</sup>
								0 204 <b>103 530</b>	
								0 204 <b>102 531</b>	→ 54 0 204 <b>104 237</b> <sup>7</sup>
								0 204 <b>103 531</b>	
		ABS	03.93-10.95	51/52			BSY	0 204 <b>102 530</b>	← 54 0 204 <b>104 194</b> <sup>7</sup>
								0 204 <b>103 530</b>	
								0 204 <b>102 531</b>	→ 54 0 204 <b>104 194</b> <sup>7</sup>
								0 204 <b>103 531</b>	
						MIH	BSY	0 204 <b>102 564</b>	← 54 0 204 <b>104 237</b> <sup>7</sup>
								0 204 <b>103 530</b>	
								0 204 <b>102 565</b>	→ 54 0 204 <b>104 237</b> <sup>7</sup>
<b>1.6</b>		ABO	10.94-12.94	56/58	Ricam.Nr →4926731	MIH	BSY		0 204 <b>104 237</b> <sup>7</sup>
<b>1.6 i.e.</b>			01.95-10.95	56/58	Ricam.Nr 4926732→	MIH	BSY	0 204 <b>102 530</b>	← 54 0 204 <b>104 237</b> <sup>7</sup>
								0 204 <b>103 530</b>	
								0 204 <b>102 531</b>	→ 54 0 204 <b>104 237</b> <sup>7</sup>
								0 204 <b>103 531</b>	
		ABS	03.93-10.95	56/58			BSY	0 204 <b>102 530</b>	← 54 0 204 <b>104 194</b> <sup>7</sup>
								0 204 <b>103 530</b>	
								0 204 <b>102 531</b>	→ 54 0 204 <b>104 194</b> <sup>7</sup>
								0 204 <b>103 531</b>	
						MIH	BSY	0 204 <b>102 564</b>	← 54 0 204 <b>104 237</b> <sup>7</sup>
								0 204 <b>103 530</b>	
								0 204 <b>102 565</b>	→ 54 0 204 <b>104 237</b> <sup>7</sup>
<b>1.6 i.e. Selecta</b>			03.93-10.95	56			BSY	0 204 <b>102 530</b>	← 54 0 204 <b>104 237</b> <sup>7</sup>
								0 204 <b>103 530</b>	
								0 204 <b>102 531</b>	→ 54 0 204 <b>104 237</b> <sup>7</sup>
								0 204 <b>103 531</b>	
<b>1.7 D</b>			12.94-10.95	42	Ricam.Nr 4926732→		BSY	0 204 <b>102 530</b>	← 54 0 204 <b>104 237</b> <sup>7</sup>
								0 204 <b>103 530</b>	
								0 204 <b>102 531</b>	→ 54 0 204 <b>104 237</b> <sup>7</sup>
								0 204 <b>103 531</b>	
<b>1.8 i.e.</b>			03.93-10.95	66/71/77			BSY	0 204 <b>102 530</b>	← 54 0 204 <b>104 237</b> <sup>7</sup>
								0 204 <b>103 530</b>	
								0 204 <b>102 531</b>	→ 54 0 204 <b>104 237</b> <sup>7</sup>
								0 204 <b>103 531</b>	
		ABS	03.93-10.95	77		MIH	BSY	0 204 <b>102 564</b>	← 54 0 204 <b>104 237</b> <sup>7</sup>
								0 204 <b>103 530</b>	
								0 204 <b>102 565</b>	→ 54 0 204 <b>104 237</b> <sup>7</sup>
<b>1.9 D</b>			12.94-10.95	48	Ricam.Nr 4926732→		BSY	0 204 <b>102 530</b>	← 54 0 204 <b>104 237</b> <sup>7</sup>
								0 204 <b>103 530</b>	
								0 204 <b>102 531</b>	→ 54 0 204 <b>104 237</b> <sup>7</sup>
								0 204 <b>103 531</b>	
<b>2.0 i.e.</b>			03.93-10.95	85			BSY	0 204 <b>102 532</b>	← 54 0 204 <b>104 237</b> <sup>7</sup>
								0 204 <b>103 532</b>	
								0 204 <b>102 533</b>	→ 54 0 204 <b>104 237</b> <sup>7</sup>
								0 204 <b>103 533</b>	







FIAT Tipo [160..]













	1.4, i.e.	03.93-10.95	51/52	F 026 <b>002 178</b>	↔ 22,2	
	1.6	03.93-10.95	58	F 026 <b>002 178</b>	↔ 22,2	
	1.6 i.e.	03.93-10.95	56	F 026 <b>002 178</b>	↔ 22,2	
	1.6 i.e. Selecta	03.93-10.95	56	F 026 <b>002 158</b>	↔ 20,6	
	1.7 D	03.93-10.95	42	F 026 <b>002 178</b>	↔ 22,2	
	1.8 i.e.	03.93-10.95	66/71/77	F 026 <b>002 158</b>	↔ 20,6	
	1.9 D	03.93-10.95	48	F 026 <b>002 178</b>	↔ 22,2	
	1.9 D Turbo	03.93-10.95	65/68	F 026 <b>002 158</b>	↔ 20,6	

	1.1 i.e.	ABS	10.94-10.95	37	0986 <b>471 009</b>	→ 34	1987 <b>470 028<sup>7</sup></b>	
					0986 <b>474 077</b>			
	1.4	ABS	03.93-06.94	51/52	0986 <b>472 828</b>	← 34	1987 <b>470 028<sup>7</sup></b>	
					0986 <b>473 077</b>			
	1.4 i.e.					0986 <b>472 829</b>	→ 34	1987 <b>470 028<sup>7</sup></b>
						0986 <b>474 077</b>		
						0986 <b>471 009</b>	→ 34	1987 <b>470 028<sup>7</sup></b>
						0986 <b>474 077</b>		
				06.94-10.95	51/52	0986 <b>471 010</b>	← 34	1987 <b>470 028<sup>7</sup></b>
						0986 <b>473 077</b>		
						0986 <b>472 829</b>	→ 34	1987 <b>470 028<sup>7</sup></b>
						0986 <b>474 077</b>		
1.6	ABS	03.93-06.94	56/58	0986 <b>472 828</b>	← 34	1987 <b>470 028<sup>7</sup></b>		
				0986 <b>473 077</b>				
1.6 i.e.					0986 <b>472 829</b>	→ 34	1987 <b>470 028<sup>7</sup></b>	
					0986 <b>474 077</b>			
1.6 i.e. Selecta			06.94-10.95	56/58	0986 <b>471 009</b>	→ 34	1987 <b>470 028<sup>7</sup></b>	
					0986 <b>474 077</b>			
					0986 <b>471 010</b>	← 34	1987 <b>470 028<sup>7</sup></b>	
					0986 <b>473 077</b>			
					0986 <b>472 828</b>	← 34	1987 <b>470 028<sup>7</sup></b>	
					0986 <b>473 077</b>			
1.7 D	ABS	03.93-06.94	42	0986 <b>472 828</b>	← 34	1987 <b>470 028<sup>7</sup></b>		
				0986 <b>473 077</b>				
					0986 <b>472 829</b>	→ 34	1987 <b>470 028<sup>7</sup></b>	
					0986 <b>474 077</b>			
					0986 <b>471 009</b>	→ 34	1987 <b>470 028<sup>7</sup></b>	
					0986 <b>474 077</b>			
			06.94-10.95	42	0986 <b>471 010</b>	← 34	1987 <b>470 028<sup>7</sup></b>	
					0986 <b>473 077</b>			
					0986 <b>472 829</b>	→ 34	1987 <b>470 028<sup>7</sup></b>	
					0986 <b>474 077</b>			
1.8 i.e.	ABS	06.94-10.95	66/71/77	0986 <b>471 009</b>	→ 34	1987 <b>470 028<sup>7</sup></b>		
				0986 <b>474 077</b>				
					0986 <b>471 010</b>	← 34	1987 <b>470 028<sup>7</sup></b>	
					0986 <b>473 077</b>			
					0986 <b>472 828</b>	← 34	1987 <b>470 028<sup>7</sup></b>	
1.9 D	ABS	03.93-06.94	48/65/68	0986 <b>472 828</b>	← 34	1987 <b>470 028<sup>7</sup></b>		
				0986 <b>473 077</b>				
1.9 D Turbo					0986 <b>472 829</b>	→ 34	1987 <b>470 028<sup>7</sup></b>	
					0986 <b>474 077</b>			
					0986 <b>471 009</b>	→ 34	1987 <b>470 028<sup>7</sup></b>	
					0986 <b>474 077</b>			
			06.94-10.95	48/65/68	0986 <b>471 010</b>	← 34	1987 <b>470 028<sup>7</sup></b>	
					0986 <b>473 077</b>			
					0986 <b>472 829</b>	→ 34	1987 <b>470 028<sup>7</sup></b>	
2.0 i.e.		03.93-10.95	85/104	0986 <b>471 009</b>	→ 34	1987 <b>470 028<sup>7</sup></b>		
				0986 <b>474 077</b>				
2.0 i.e. 16V					0986 <b>471 010</b>	← 34	1987 <b>470 028<sup>7</sup></b>	
					0986 <b>473 077</b>			



















	1.1 i.e.	10.94-10.95	37	SBR	1987 <b>477 375</b>	→ 1460	
					1987 <b>477 382</b>	← 1517	
				TBR	1987 <b>477 087</b>	← 1415	
					1987 <b>477 088</b>	→ 1375	

		S							
<b>1.4</b>		03.93-10.95	51/52			SBR	1 987 477 375	→ 1460	
<b>1.4 i.e.</b>							1 987 477 382	← 1517	
						TBR	1 987 477 087	← 1415	
							1 987 477 088	→ 1375	
<b>1.6</b>		03.93-10.95	58			SBR	1 987 477 375	→ 1460	
							1 987 477 382	← 1517	
						TBR	1 987 477 087	← 1415	
							1 987 477 088	→ 1375	
<b>1.6 i.e.</b>		03.93-10.95	56			SBR	1 987 477 382	← 1517	
						TBR	1 987 477 087	← 1415	
							1 987 477 088	→ 1375	
<b>1.6 i.e. Selecta</b>		03.93-10.95	56			SBR	1 987 477 382	← 1517	
						TBR	1 987 477 089	→ 1405	
							1 987 482 149	← 1445	
<b>1.6 i.e., i.e. Selecta</b>		03.93-10.95	56			SBR	1 987 477 375	→ 1460	
<b>1.7 D</b>		03.93-10.95	42			SBR	1 987 477 375	→ 1460	
							1 987 477 382	← 1517	
						TBR	1 987 477 087	← 1415	
							1 987 477 088	→ 1375	
<b>1.8 i.e.</b>		03.93-10.95	66/71/77			SBR	1 987 477 375	→ 1460	
							1 987 477 382	← 1517	
						TBR	1 987 477 089	→ 1405	
							1 987 482 149	← 1445	
<b>1.9 D</b>		03.93-10.95	48			SBR	1 987 477 375	→ 1460	
							1 987 477 382	← 1517	
						TBR	1 987 477 087	← 1415	
							1 987 477 088	→ 1375	
<b>1.9 D Turbo</b>		03.93-10.95	65/68			SBR	1 987 477 375	→ 1460	
							1 987 477 382	← 1517	
						TBR	1 987 477 089	→ 1405	
							1 987 482 149	← 1445	
<b>2.0 i.e.</b>		03.93-10.95	85/104			SBR	1 987 477 375	→ 1460	
<b>2.0 i.e. 16V</b>							1 987 477 382	← 1517	
	<b>1.1 i.e.</b>	10.94-10.95	37				0 265 001 215 <sup>3</sup>		
						LAB	0 265 001 216 <sup>4</sup>		
						RAB	0 265 001 217 <sup>4</sup>		
	<b>1.4</b>	03.93-10.95	51/52				0 265 001 215 <sup>3</sup>		
	<b>1.4 i.e.</b>					LAB	0 265 001 216 <sup>4</sup>		
						RAB	0 265 001 217 <sup>4</sup>		
	<b>1.6</b>	03.93-10.95	56/58				0 265 001 215 <sup>3</sup>		
	<b>1.6 i.e.</b>					LAB	0 265 001 216 <sup>4</sup>		
	<b>1.6 i.e. Selecta</b>					RAB	0 265 001 217 <sup>4</sup>		
	<b>1.7 D</b>	03.93-10.95	42				0 265 001 215 <sup>3</sup>		
						LAB	0 265 001 216 <sup>4</sup>		
						RAB	0 265 001 217 <sup>4</sup>		
	<b>1.8 i.e.</b>	03.93-10.95	66/71/77				0 265 001 215 <sup>3</sup>		
						LAB	0 265 001 216 <sup>4</sup>		
						RAB	0 265 001 217 <sup>4</sup>		
	<b>1.9 D</b>	03.93-10.95	48/65/68				0 265 001 215 <sup>3</sup>		
	<b>1.9 D Turbo</b>					LAB	0 265 001 216 <sup>4</sup>		
						RAB	0 265 001 217 <sup>4</sup>		
	<b>2.0 i.e.</b>	03.93-10.95	85/104				0 265 001 215 <sup>3</sup>		
	<b>2.0 i.e. 16V</b>					LAB	0 265 001 216 <sup>4</sup>		
						RAB	0 265 001 217 <sup>4</sup>		
<b>Ulysse [179..]</b>									
									
	<b>2.0 16V</b>	10.02-01.05	100	Ricam.Nr →10285		LLE	1 987 477 713	← 1068	
							1 987 477 714	→ 2360	
						RLE	1 987 477 713	→ 1068	
							1 987 477 714	← 2360	



		S								
<b>FIAT Ulysse [179..]</b>										
2.0 16V	02.05-10.05	100	Ricam.Nr 10286→	LLE			1987 477 953	→ 2308		
							1987 477 954	← 1041		
				RLE			1987 477 953	← 2308		
							1987 477 954	→ 1041		
2.0 16V JTD	10.02-01.05	79/80	Ricam.Nr →10285	LLE			1987 477 713	← 1068		
							1987 477 714	→ 2360		
					RLE			1987 477 713	→ 1068	
								1987 477 714	← 2360	
	02.05-01.06	79/80	Ricam.Nr 10286→	LLE				1987 477 953	→ 2308	
								1987 477 954	← 1041	
				RLE			1987 477 953	← 2308		
							1987 477 954	→ 1041		
02.06-12.10	88						1987 482 235	1255		
							1987 477 928	1535		
	100						1987 482 235	1255		
							1987 477 928	1535		
2.2 16V JTD	10.02-01.05	94	Ricam.Nr →10285	LLE			1987 477 713	← 1068		
							1987 477 714	→ 2360		
					RLE			1987 477 713	→ 1068	
								1987 477 714	← 2360	
	02.05-09.07	94	Ricam.Nr 10286→	LLE				1987 477 953	→ 2308	
								1987 477 954	← 1041	
				RLE			1987 477 953	← 2308		
							1987 477 954	→ 1041		
10.07-12.10	125			LLE			1987 477 953	→ 2308		
							1987 477 954	← 1041		
				RLE			1987 477 953	← 2308		
							1987 477 954	→ 1041		
3.0 V6 24V	01.03-01.05	150	Ricam.Nr →10285	LLE			1987 477 713	← 1068		
							1987 477 714	→ 2360		
					RLE			1987 477 713	→ 1068	
								1987 477 714	← 2360	
	02.05-10.05	150	Ricam.Nr 10286→	LLE				1987 477 953	→ 2308	
								1987 477 954	← 1041	
				RLE			1987 477 953	← 2308		
							1987 477 954	→ 1041		
2.0 16V	10.02-12.10	79/80/88/					0986 594 566 <sup>4</sup>			
							0265 007 083 <sup>3</sup>			
2.0 16V JTD		100					0265 007 084 <sup>3</sup>			
							0265 007 084 <sup>3</sup>			
2.2 16V JTD	10.02-09.07	94					0986 594 566 <sup>4</sup>			
							0265 007 083 <sup>3</sup>			
	10.07-12.10	125						0986 594 566 <sup>4</sup>		
								0265 007 131 <sup>3</sup>		
3.0 V6 24V	01.03-10.05	150					0986 594 566 <sup>4</sup>			
							0265 007 083 <sup>3</sup>			
							0265 007 084 <sup>3</sup>			
<b>Ulysse [220..]</b>										
1.8 i.e.	05.96-05.00	75					0204 102 521	← 57	0204 100 316 <sup>8</sup>	
							0204 103 521		0204 104 177 <sup>7</sup>	
							0204 102 523	→ 57	0204 100 316 <sup>8</sup>	
							0204 103 523			
1.9 TD	01.95-12.99	66					0986 473 115	← 57,11		
							0986 474 115	→ 57,11		
2.0 i.e., i.e. Turbo, i.e. 16V, JTD 8V, JTD 16V	09.94-09.02	80/90/97/					0986 473 115	← 57,11		
							0986 474 115	→ 57,11		
2.1 TD	05.96-10.99	80					0986 473 115	← 57,11		
							0986 474 115	→ 57,11		

		S							
									
	1.8 i.e.	05.96-05.00	75				F 026 <b>002 181</b>	↔ 19,05	
	1.9 TD	01.95-12.99	66				F 026 <b>002 181</b>	↔ 19,05	
	2.0 i.e., JTD 8V, JTD 16V	09.94-09.02	80/90				F 026 <b>002 181</b>	↔ 19,05	
	2.1 TD	05.96-10.99	80				F 026 <b>002 181</b>	↔ 19,05	
									
	1.8 i.e.	05.96-05.00	75				1 987 <b>477 565</b>	500	
						LLE,SBR	1 987 <b>477 524</b>	→ 2205	
							1 987 <b>477 525</b>	← 1255	
						LLT	1 987 <b>477 569</b>	→ 2286	
	1.9 TD	01.95-12.99	66				1 987 <b>477 565</b>	500	
						LLE,SBR	1 987 <b>477 524</b>	→ 2205	
							1 987 <b>477 525</b>	← 1255	
						LLT	1 987 <b>477 569</b>	→ 2286	
	2.0 i.e. Turbo	09.94-09.02	97/100/				1 987 <b>477 565</b>	500	
	2.0 i.e. 16V		110			LLE,SBR	1 987 <b>477 524</b>	→ 2205	
							1 987 <b>477 525</b>	← 1255	
	2.0 i.e.	09.94-09.02	80/90				1 987 <b>477 565</b>	500	
	2.0 JTD 8V					LLE,SBR	1 987 <b>477 524</b>	→ 2205	
	2.0 JTD 16V						1 987 <b>477 525</b>	← 1255	
						LLT	1 987 <b>477 569</b>	→ 2286	
	2.1 TD	05.96-10.99	80				1 987 <b>477 565</b>	500	
						LLE,SBR	1 987 <b>477 524</b>	→ 2205	
							1 987 <b>477 525</b>	← 1255	
						LLT	1 987 <b>477 569</b>	→ 2286	
	1.8 i.e.	06.97-09.97	75	Ricam.Nr 7480→7609		BO	0 265 <b>006 426</b> <sup>4</sup>		
		06.97-05.00	75	Ricam.Nr 7480→9050			0 265 <b>006 388</b> <sup>3</sup>		
		10.97-05.00	75	Ricam.Nr 7610→		BO	0 265 <b>006 504</b> <sup>4</sup>		
	1.9 TD	06.97-09.97	66	Ricam.Nr 7480→7609		BO	0 265 <b>006 426</b> <sup>4</sup>		
		06.97-12.99	66	Ricam.Nr 7480→9050			0 265 <b>006 388</b> <sup>3</sup>		
		10.97-12.99	66	Ricam.Nr 7610→		BO	0 265 <b>006 504</b> <sup>4</sup>		
	2.0 i.e.	06.97-09.97	90	Ricam.Nr 7480→7609		BO	0 265 <b>006 426</b> <sup>4</sup>		
		06.97-05.00	90	Ricam.Nr 7480→9050			0 265 <b>006 388</b> <sup>3</sup>		
		10.97-05.00	90	Ricam.Nr 7610→		BO	0 265 <b>006 504</b> <sup>4</sup>		
	2.0 i.e. Turbo	06.97-09.97	110	Ricam.Nr 7480→7609		BO	0 265 <b>006 426</b> <sup>4</sup>		
		06.97-05.00	110	Ricam.Nr 7480→9050			0 265 <b>006 388</b> <sup>3</sup>		
		10.97-05.00	110	Ricam.Nr 7610→		BO	0 265 <b>006 504</b> <sup>4</sup>		
	2.0 i.e. 16V	05.98-08.01	97/100	Ricam.Nr 7480→9050			0 265 <b>006 388</b> <sup>3</sup>		
		05.98-09.02	97/100	Ricam.Nr 7610→		BO	0 265 <b>006 504</b> <sup>4</sup>		
	2.0 JTD 8V	07.99-08.01	80	Ricam.Nr 7480→9050			0 265 <b>006 388</b> <sup>3</sup>		
	2.0 JTD 16V	07.99-09.02	80	Ricam.Nr 7610→		BO	0 265 <b>006 504</b> <sup>4</sup>		
	2.1 TD	06.97-09.97	80	Ricam.Nr 7480→7609		BO	0 265 <b>006 426</b> <sup>4</sup>		
		06.97-10.99	80	Ricam.Nr 7480→9050			0 265 <b>006 388</b> <sup>3</sup>		
		10.97-10.99	80	Ricam.Nr 7610→		BO	0 265 <b>006 504</b> <sup>4</sup>		
<b>Uno [Fase I]</b>									
									
	1.5 SPI	03.92-01.96	49			ATE	F 026 <b>002 454</b>	↔ 19,05	
									
	1.5 SPI	03.92-01.96	49				1 987 <b>477 296</b>	2833	



		S				?			
◀ FIAT									
<b>Uno Furgoneta</b>									
	1.3 MPI 8V	01.04-12.13	48		ATE	F 026 <b>002 454</b>		↔ 19,05	
<b>Uno Furgoneta [Fase I]</b>									
	1.5 MPI 8V	04.97-12.00	56		ATE	F 026 <b>002 454</b>		↔ 19,05	
<b>Uno Mille [Fase I]</b>									
	1.0 Eletronic 1.0 SPI	05.93-06.01	41/42		ATE	F 026 <b>002 454</b>		↔ 19,05	
	1.0 Eletronic	05.93-11.95	41			1 987 <b>477 296</b>		2833	
<b>Uno Van [246..]</b>									
	0.9	09.89-03.94	33		MIH	0 204 <b>102 447</b> 0 986 <b>473 104</b>	← 48	0 204 <b>104 184</b>	
						0 204 <b>102 448</b> 0 986 <b>474 104</b>	→ 48	0 204 <b>104 184</b>	
	1.0 i.e.	09.89-03.94	33		MIH	0 204 <b>102 447</b> 0 986 <b>473 104</b>	← 48	0 204 <b>104 184</b>	
						0 204 <b>102 448</b> 0 986 <b>474 104</b>	→ 48	0 204 <b>104 184</b>	
	1.7 D	01.91-03.94	42		MIH	0 204 <b>102 524</b> 0 204 <b>103 524</b>	← 48	0 204 <b>104 234<sup>7</sup></b>	
					MIH	0 204 <b>102 524</b> 0 204 <b>103 524</b>	← 48	0 204 <b>104 234<sup>7</sup></b>	
						0 204 <b>102 525</b> 0 204 <b>103 525</b>	→ 48	0 204 <b>104 234<sup>7</sup></b>	
	0.9	09.89-03.94	33			F 026 <b>002 454</b>		↔ 19,05	
	1.0 i.e.	09.89-03.94	33			F 026 <b>002 454</b>		↔ 19,05	
	1.7 D	01.91-03.94	42			F 026 <b>002 454</b>		↔ 19,05	
	0.9	09.89-03.94	33	Ricam.Nr →7767870, →7466388		1 987 <b>477 091</b> 1 987 <b>477 289</b>	← 521 → 2018		
				Ricam.Nr 7767871→, 7466389→		1 987 <b>477 377</b> 1 987 <b>482 108</b>	→ 2016 ← 523		
	1.0 i.e.	09.89-03.94	33	Ricam.Nr →7767870, →7466388		1 987 <b>477 091</b> 1 987 <b>477 289</b>	← 521 → 2018		
				Ricam.Nr 7767871→, 7466389→		1 987 <b>477 377</b> 1 987 <b>482 108</b>	→ 2016 ← 523		
	1.7 D	01.91-03.94	42	Ricam.Nr →7767870, →7466388		1 987 <b>477 091</b> 1 987 <b>477 289</b>	← 521 → 2018		
				Ricam.Nr 7767871→, 7466389→		1 987 <b>477 377</b> 1 987 <b>482 108</b>	→ 2016 ← 523		



		S							
<b>Uno [146..]</b>									
	<b>1.0</b>	09.89-03.94	33			MIH	0 204 102 447 0 986 473 104	← 48	0 204 104 184
							0 204 102 448 0 986 474 104	→ 48	0 204 104 184
		01.98-01.99	33				0 204 102 447 0 986 473 104	← 48	0 204 104 184
							0 204 102 448 0 986 474 104	→ 48	0 204 104 184
	<b>1.0, Base, i.e.</b>	09.89-03.94	33			MIH	0 204 102 447	← 48	
							0 204 102 928	→ 48	
	<b>1.0 Base</b>	09.89-03.94	33			MIH	0 204 102 447 0 986 473 104	← 48	0 204 104 184
							0 204 102 448 0 986 474 104	→ 48	0 204 104 184
	<b>1.0 DAV-15</b>	09.89-03.94	32			MIH	0 204 102 447	← 48	
	<b>1.0 Trend</b>						0 204 102 928	→ 48	
						MIH	0 204 102 447 0 986 473 104	← 48	0 204 104 184
							0 204 102 448 0 986 474 104	→ 48	0 204 104 184
	<b>1.0 i.e.</b>	09.89-03.94	33			MIH	0 204 102 447 0 986 473 104	← 48	0 204 104 184
							0 204 102 448 0 986 474 104	→ 48	0 204 104 184
		01.96-12.02	33				0 204 102 447 0 986 473 104	← 48	0 204 104 184
							0 204 102 448 0 986 474 104	→ 48	0 204 104 184
	<b>1.1</b>	01.98-12.03	40			MIH	0 204 102 447 0 986 473 104	← 48	0 204 104 184
							0 204 102 448 0 986 474 104	→ 48	0 204 104 184
	<b>1.1</b>	09.90-12.00	41			MIH	0 204 102 447	← 48	
	<b>1.1 Espresso</b>						0 204 102 928	→ 48	
						MIH	0 204 102 447 0 986 473 104	← 48	0 204 104 184
							0 204 102 448 0 986 474 104	→ 48	0 204 104 184
	<b>1.1 i.e.</b>	09.89-03.94	36/37,5			MIH	0 204 102 447	← 48	
							0 204 102 928	→ 48	
						MIH	0 204 102 447 0 986 473 104	← 48	0 204 104 184
							0 204 102 448 0 986 474 104	→ 48	0 204 104 184
	<b>1.4 DAV-15</b>	09.89-03.94	52				0 204 102 447	← 48	0 204 104 184
							0 204 102 928	→ 48	0 204 104 184
	<b>1.4 i</b>	05.90-12.00	52			MIH	0 204 102 447	← 48	
							0 204 102 928	→ 48	
						MIH	0 204 102 447 0 986 473 104	← 48	0 204 104 184
							0 204 102 448 0 986 474 104	→ 48	0 204 104 184
	<b>1.4 i.e.</b>	09.89-03.94	51			MIH	0 204 102 447 0 986 473 104	← 48	0 204 104 184
							0 204 102 448 0 986 474 104	→ 48	0 204 104 184
	<b>1.4 Turbo i.e.</b>	ABO 05.90-03.94	85			MIH	0 204 102 528	← 48	



	◀ FIAT Uno [146..]									
1.5 i.e.	09.89-03.94	55	GS,MIH	0 204 102 447	← 48	0 204 104 184				
				0 986 473 104						
				0 204 102 448	→ 48	0 204 104 184				
				0 986 474 104						
1.5 i.e. Selecta	05.92-03.94	55	AG,MIH	0 204 102 524	← 48					
				0 204 102 547	→ 48					
			AG,MIH	0 204 102 524	← 48	0 204 104 234 <sup>7</sup>				
				0 204 103 524						
				0 204 102 525	→ 48	0 204 104 234 <sup>7</sup>				
				0 204 103 525						
1.7 D	09.89-03.94	42	MIH	0 204 102 524	← 48					
				0 204 102 547	→ 48					
			MIH	0 204 102 524	← 48	0 204 104 234 <sup>7</sup>				
				0 204 103 524						
				0 204 102 525	→ 48	0 204 104 234 <sup>7</sup>				
				0 204 103 525						
	01.96-04.99	46		0 204 102 524	← 48	0 204 104 234 <sup>7</sup>				
				0 204 103 524						
				0 204 102 525	→ 48	0 204 104 234 <sup>7</sup>				
				0 204 103 525						
1.9 D	09.89-03.94	44	MIH	0 204 102 524	← 48					
				0 204 102 547	→ 48					
			MIH	0 204 102 524	← 48	0 204 104 234 <sup>7</sup>				
				0 204 103 524						
				0 204 102 525	→ 48	0 204 104 234 <sup>7</sup>				
				0 204 103 525						
		1.0	09.89-03.94	33		F 026 002 454	↔ 19,05			
			01.98-01.99	33		F 026 002 454	↔ 19,05			
		1.0 Base	09.89-03.94	33		F 026 002 454	↔ 19,05			
		1.0 DAV-15, Trend	09.89-03.94	32		F 026 002 454	↔ 19,05			
		1.0 i.e.	01.96-12.02	33		F 026 002 454	↔ 19,05			
		1.1	01.98-12.03	40		F 026 002 454	↔ 19,05			
		1.1 i.e.	09.89-03.94	36/37,5		F 026 002 454	↔ 19,05			
		1.7 D	09.89-03.94	42		F 026 002 454	↔ 19,05			
			01.96-04.99	46		F 026 002 454	↔ 19,05			
		1.9 D	09.89-03.94	44		F 026 002 454	↔ 19,05			
				1.4 Turbo i.e.	05.90-12.98	85	0 986 473 014		←	
							0 986 473 013		→	
				1.0	09.89-03.94	33	Ricam.Nr 7767871→, 7466389→	1 987 477 377	→ 2016	
1 987 482 108	← 523									
								1 987 477 377	→ 2016	
								1 987 482 108	← 523	
1.0, Base, i.e.	09.89-03.94			33	Ricam.Nr →7767870, →7466388	1 987 477 091	← 521			
						1 987 477 289	→ 2018			
1.0 Base	09.89-03.94			33	Ricam.Nr 7767871→, 7466389→	1 987 477 377	→ 2016			
						1 987 482 108	← 523			
1.0 DAV-15	09.89-03.94			32	Ricam.Nr →7767870, →7466388	1 987 477 289	→ 2018			
1.0 DAV-15, Trend	09.89-03.94			32	Ricam.Nr →7767870, →7466388	1 987 477 091	← 521			
1.0 i.e.	09.89-03.94			33	Ricam.Nr 7767871→, 7466389→	1 987 477 377	→ 2016			
						1 987 482 108	← 523			
						1 987 477 377	→ 2016			
						1 987 482 108	← 523			
1.0 Trend	07.90-03.94			32	Ricam.Nr →7767870, →7466388 Ricam.Nr 7767871→, 7466389→	1 987 477 289	→ 2018			
						1 987 477 377	→ 2016			
				1 987 482 108	← 523					

		S							
1.1		01.98-12.03	40				1 987 477 377	→ 2016	
							1 987 482 108	← 523	
1.1 i.e.		09.89-03.94	36/37,5	Ricam.Nr →7767870, →7466388			1 987 477 091	← 521	
				Ricam.Nr 7767871→, 7466389→			1 987 477 289	→ 2018	
							1 987 477 377	→ 2016	
							1 987 482 108	← 523	
1.2 i		04.00-03.04	44				1 987 477 377	→ 2016	
							1 987 482 108	← 523	
1.4 DAV-15		09.89-03.94	51/52	Ricam.Nr →7767870, →7466388			1 987 477 091	← 521	
1.4 i.e.				Ricam.Nr 7767871→, 7466389→			1 987 477 289	→ 2018	
							1 987 477 377	→ 2016	
							1 987 482 108	← 523	
1.5 i.e.		09.89-03.94	55	Ricam.Nr →7767870, →7466388			1 987 477 091	← 521	
1.5 i.e. Selecta				Ricam.Nr 7767871→, 7466389→			1 987 477 289	→ 2018	
							1 987 477 377	→ 2016	
							1 987 482 108	← 523	
1.7 D		09.89-03.94	42	Ricam.Nr →7767870, →7466388			1 987 477 091	← 521	
				Ricam.Nr 7767871→, 7466389→			1 987 477 289	→ 2018	
							1 987 477 377	→ 2016	
							1 987 482 108	← 523	
		01.96-04.99	46				1 987 477 377	→ 2016	
							1 987 482 108	← 523	
		01.98-03.04	42				1 987 477 377	→ 2016	
							1 987 482 108	← 523	
1.9 D		09.89-03.94	44	Ricam.Nr →7767870, →7466388			1 987 477 091	← 521	
				Ricam.Nr 7767871→, 7466389→			1 987 477 289	→ 2018	
							1 987 477 377	→ 2016	
							1 987 482 108	← 523	
<b>Uno [158..]</b>									
	1.4	01.98-12.10	51	MIH			0 204 102 447	← 48	
				MIH			0 204 102 928	→ 48	
							0 204 102 447	← 48	0 204 104 184
							0 986 473 104		
							0 204 102 448	→ 48	0 204 104 184
							0 986 474 104		
	1.4	01.98-12.10	51				F 026 002 454	↔ 19,05	
	1.4	01.98-12.10	51				1 987 477 377	→ 2016	
							1 987 482 108	← 523	
<b>500 [312]</b>									
	0.9	10.13→	77	BSR			0 204 902 119	← 54	
							0 986 473 487		
							0 204 902 120	→ 54	
							0 986 474 487		
				BSR			0 986 473 487	← 54	
1.2		07.07-04.13	51	FBJ			0 204 902 090	→ 48	
1.2 LPG							0 986 135 007		
1.3 MJTD		07.07-12.12	55				0 204 902 064	←	
							0 204 902 065	→	





		S							
	◀ FIAT 500 [312]								
1.3 Multijet		01.10→	70				0 204 902 119	← 54	
							0 986 473 487		
							0 204 902 120	→ 54	
							0 986 474 487		
1.4		07.07-01.13	74			FBJ	0 204 902 033	→ 54	
							0 986 474 487		
						KZR	0 986 473 487	← 54	
1.4 Abarth		05.08-12.12	132			BSR	0 204 004 566	← 54	
							0 986 134 077		
							0 204 004 567	→ 54	
							0 986 135 077		
		05.08→	99/103			TW	0 204 004 566	← 54	
							0 986 134 077		
	0.9	09.10→	44/48/59/62,5/77			LOC	0 986 475 974	↔ 20,64	
	1.2	07.07-05.10	51			BSY	F 026 002 474	↔ 20,64	
		06.10→	51			LOC	0 986 475 974	↔ 20,64	
	1.2 LPG	09.10→	51			LOC	0 986 475 974	↔ 20,64	
	1.3 MJTD	07.07-05.10	55/70			BSY	F 026 002 474	↔ 20,64	
	1.3 Multijet	06.10→	55/70			LOC	0 986 475 974	↔ 20,64	
	0.9	09.10→	44/48/59/62,5				1 987 482 199	→ 1450	
							1 987 482 200	← 1425	
	1.2	07.07→	51				1 987 482 199	→ 1450	
	1.2 LPG						1 987 482 200	← 1425	
	1.3 MJTD	07.07→	55/70				1 987 482 199	→ 1450	
	1.3 Multijet						1 987 482 200	← 1425	
	1.4	07.07→	74/99/103/				1 987 482 201	→ 1506	
	1.4 Abarth		132				1 987 482 202	← 1491	
<b>500C [312]</b>									
	0.9	10.13→	77			BSR	0 204 902 119	← 54	
							0 986 473 487		
							0 204 902 120	→ 54	
							0 986 474 487		
						BSR	0 986 473 487	← 54	
	1.2	07.09-04.13	51			FBJ	0 204 902 064	←	
							0 204 902 065	→	
	1.3 Multijet	07.09-12.12	55				0 204 902 064	←	
							0 204 902 065	→	
		01.10→	70				0 204 902 119	← 54	
							0 986 473 487		
							0 204 902 120	→ 54	
							0 986 474 487		
	1.4	07.09-01.13	74			FBJ	0 204 902 033	→ 54	
							0 986 474 487		
						KZR	0 986 473 487	← 54	
	1.4 Abarth	09.09→	103			TW	0 204 004 566	← 54	
							0 986 134 077		
		07.10→	99			TW	0 204 004 566	← 54	
							0 986 134 077		
							0 204 004 567	→ 54	
							0 986 135 077		



	<b>0.9</b>	09.10→	44/48/59/62,5/77		LOC	0 986 475 974	↔	20,64
	<b>1.2</b>	07.09-05.10	51		BSY	F 026 002 474	↔	20,64
		06.10→	51		LOC	0 986 475 974	↔	20,64
	<b>1.3 Multijet</b>	07.09-05.10	55/70		BSY	F 026 002 474	↔	20,64
		06.10→	55/70		LOC	0 986 475 974	↔	20,64

	<b>Abarth 1.4</b>	03.12→	132			1 987 482 201	→	1506
						1 987 482 202	←	1491
	<b>0.9</b>	09.10→	44/48/59/62,5			1 987 482 199	→	1450
						1 987 482 200	←	1425
	<b>1.2</b>	07.09→	51			1 987 482 199	→	1450
						1 987 482 200	←	1425
	<b>1.3 Multijet</b>	07.09→	55/70			1 987 482 199	→	1450
						1 987 482 200	←	1425
	<b>1.4</b>	07.09→	74/99/103			1 987 482 201	→	1506
	<b>1.4 Abarth</b>					1 987 482 202	←	1491

**500L [199]**

	<b>0.9</b>	09.12→	59-62,5/77		BSR	0 204 004 566	←	54
	<b>0.9 Natural Power</b>					0 986 134 077	↔	
						0 204 004 567	→	54
						0 986 135 077	↔	
	<b>1.3 Multijet</b>	09.12→	62			0 204 004 566	←	54
						0 986 134 077	↔	
						0 204 004 567	→	54
						0 986 135 077	↔	
	<b>1.4</b>	09.12→	70			0 204 004 566	←	54
						0 986 134 077	↔	
						0 204 004 567	→	54
						0 986 135 077	↔	
	<b>1.6 Multijet</b>	03.13→	77		BSR	0 204 004 566	←	54
						0 986 134 077	↔	
						0 204 004 567	→	54
						0 986 135 077	↔	

	<b>0.9</b>	09.12→	59-62,5/77		HTB	1 987 482 526	↔	1719
					4SB	1 987 482 509	↔	1778
	<b>0.9 Natural Power</b>	02.13→	59-62,5/77		HTB	1 987 482 526	↔	1719
					4SB	1 987 482 509	↔	1778
	<b>1.3 Multijet</b>	09.12→	62		HTB	1 987 482 526	↔	1719
					4SB	1 987 482 509	↔	1778
	<b>1.4</b>	09.12→	70		HTB	1 987 482 526	↔	1719
					4SB	1 987 482 509	↔	1778
		01.14→	88			1 987 482 509	↔	1778
	<b>1.4 LPG</b>	02.14→	88			1 987 482 509	↔	1778
	<b>1.6 Multijet</b>	03.13→	77/88			1 987 482 509	↔	1778

**FORD**

**B-Max [12]**

	<b>1.0 EcoBoost</b>	08.12→	74/88-92			0 986 475 989	↔	20,6
	<b>1.4</b>	08.12→	63/66			0 986 475 989	↔	20,6



































		S							
<b>FORD B-Max [12]</b>									
		1.5 TDCi	08.12→	55			0986 475 989	↔ 20,6	
		1.6 TDCi, Ti-VCT	08.12→	70/77			0986 475 989	↔ 20,6	
<b>U</b>									
		1.0 EcoBoost	08.12→	74/88-92		MI	1987 482 453	1362	
		1.4	08.12→	63/66		MI	1987 482 453	1362	
		1.5 TDCi	08.12→	55		MI	1987 482 453	1362	
		1.6 TDCi, Ti-VCT	08.12→	70/77		MI	1987 482 453	1362	
<b>T</b>									
		1.0 EcoBoost	08.12-01.13	74/88-92			0265 009 270 <sup>3</sup>		
			02.13→	74/88-92			0265 009 534 <sup>3</sup>		
		1.4	08.12-01.13	66			0265 009 270 <sup>3</sup>		
			02.13→	66			0265 009 534 <sup>3</sup>		
			03.14→	63			0265 009 534 <sup>3</sup>		
		1.5 TDCi	08.12-01.13	55			0265 009 270 <sup>3</sup>		
			02.13→	55			0265 009 534 <sup>3</sup>		
		1.6 TDCi	08.12-01.13	70/77			0265 009 270 <sup>3</sup>		
		1.6 Ti-VCT	02.13→	70/77			0265 009 534 <sup>3</sup>		
<b>C-MAX [07]</b>									
		1.6	03.07-07.10	66/74/80			0986 473 385	👁️ ← 56,95	1987 470 506 <sup>8</sup>
		1.6 TDCi					0986 474 385	👁️ → 56,95	1987 470 506 <sup>8</sup>
		1.8, FFV, TDCi	03.07-07.10	85/90-92			0986 473 385	👁️ ← 56,95	1987 470 506 <sup>8</sup>
							0986 474 385	👁️ → 56,95	1987 470 506 <sup>8</sup>
		2.0, CNG, LPG, TDCi	03.07-07.10	81/93-107			0986 473 385	👁️ ← 56,95	1987 470 506 <sup>8</sup>
							0986 474 385	👁️ → 56,95	1987 470 506 <sup>8</sup>
<b>F</b>									
		1.6	03.07-07.10	66/74/80			0986 473 173	👁️ ← 37,93	
		1.6 TDCi					0986 474 173	👁️ → 37,93	
		1.8, FFV, TDCi	03.07-07.10	85/90-92			0986 473 173	👁️ ← 37,93	
							0986 474 173	👁️ → 37,93	
		2.0, CNG, LPG, TDCi	03.07-07.10	81/93-107			0986 473 173	👁️ ← 37,93	
							0986 474 173	👁️ → 37,93	
<b>U</b>									
		1.6	03.07-07.10	66/74/80			1987 482 189	1860	
		1.6 TDCi				TW	1987 482 188	337	
							1987 482 279	360	
		1.8	03.07-07.10	85/90-92			1987 482 189	1860	
		1.8 FFV				TW	1987 482 188	337	
		1.8 TDCi					1987 482 279	360	
		2.0, CNG, LPG, TDCi	03.07-07.10	81/93-107			1987 482 189	1860	
						TW	1987 482 188	337	
							1987 482 279	360	
<b>T</b>									
		1.6	03.07-07.10	66/74/80			0986 594 554 <sup>4</sup>		
		1.6 TDCi	MFD 03.07-07.10	66/74/80			0986 594 556 <sup>3</sup>		
			OFD 03.07-07.10	66/74/80			0986 594 555 <sup>3</sup>		
		1.8	03.07-07.10	85/90-92			0986 594 554 <sup>4</sup>		
		1.8 FFV	MFD 03.07-07.10	85/90-92			0986 594 556 <sup>3</sup>		
		1.8 TDCi	OFD 03.07-07.10	85/90-92			0986 594 555 <sup>3</sup>		
		2.0, CNG, LPG, TDCi	03.07-07.10	81/93-107			0986 594 554 <sup>4</sup>		
			MFD 03.07-07.10	81/93-107			0986 594 556 <sup>3</sup>		
			OFD 03.07-07.10	81/93-107			0986 594 555 <sup>3</sup>		

		S				?			
<b>C-MAX [11]</b>									
	<b>1.0 EcoBoost</b>	10.12→	74/92				0 986 <b>473 385</b>	← 56,95	1 987 <b>470 506<sup>B</sup></b>
							0 986 <b>474 385</b>	→ 56,95	1 987 <b>470 506<sup>B</sup></b>
	<b>1.6 EcoBoost, TDCi, Ti-VCT, Ti-VCT FlexiFuel</b>	08.10→	63/70/77/85/86-88/92/110/132-134				0 986 <b>473 385</b>	← 56,95	1 987 <b>470 506<sup>B</sup></b>
							0 986 <b>474 385</b>	→ 56,95	1 987 <b>470 506<sup>B</sup></b>
	<b>2.0 TDCi</b>	08.10→	85/100/103/120				0 986 <b>473 385</b>	← 56,95	1 987 <b>470 506<sup>B</sup></b>
							0 986 <b>474 385</b>	→ 56,95	1 987 <b>470 506<sup>B</sup></b>
	<b>1.0 EcoBoost</b>	10.12→	74/92		FLR		1 987 <b>482 494</b>		1992
					TW		1 987 <b>482 188</b>		337
							1 987 <b>482 371</b>		367
	<b>1.6 EcoBoost, TDCi, Ti-VCT, Ti-VCT FlexiFuel</b>	08.10→	70/77/85/86-88/92/110/132-134		FLR		1 987 <b>482 494</b>		1992
					TW		1 987 <b>482 188</b>		337
							1 987 <b>482 371</b>		367
	<b>1.6 Ti-VCT</b>	08.11→	63		TW		1 987 <b>482 188</b>		337
							1 987 <b>482 371</b>		367
	<b>2.0 TDCi</b>	08.10→	85/100/103/120		FLR		1 987 <b>482 494</b>		1992
					TW		1 987 <b>482 188</b>		337
							1 987 <b>482 371</b>		367
	<b>1.6 EcoBoost, TDCi, Ti-VCT, Ti-VCT FlexiFuel</b>	08.10-11.10	70/77/85/86-88/92/110/132-134				0 986 <b>594 555<sup>3</sup></b>		
		08.10-12.10	70/77/85/86-88/92/110/132-134		FPA		0 986 <b>594 554<sup>4</sup></b>		
	<b>2.0 TDCi</b>	08.10-11.10	85/100/103/120				0 986 <b>594 555<sup>3</sup></b>		
		08.10-12.10	85/100/103/120		FPA		0 986 <b>594 554<sup>4</sup></b>		
<b>Cougar</b>									
	<b>2.0 i</b>	08.98-12.00	96						1 987 <b>470 034<sup>7</sup></b>
									1 987 <b>470 506<sup>B</sup></b>
	<b>2.5 i</b>	08.98-12.00	125/						1 987 <b>470 034<sup>7</sup></b>
	<b>2.5 i ST200</b>		147-151						1 987 <b>470 506<sup>B</sup></b>
	<b>2.0 i</b>	08.98-12.00	96				0 204 <b>102 859</b>	← 36	
							0 986 <b>473 281</b>		
							0 204 <b>102 860</b>	→ 36	
							0 986 <b>474 281</b>		
	<b>2.5 i</b>	08.98-12.00	125/				0 204 <b>102 859</b>	← 36	
	<b>2.5 i ST200</b>		147-151				0 986 <b>473 281</b>		
							0 204 <b>102 860</b>	→ 36	
							0 986 <b>474 281</b>		
	<b>2.0 i</b>	08.98-12.00	96				1 987 <b>477 631</b>		270
							1 987 <b>477 836</b>		1462
	<b>2.5 i</b>	08.98-12.00	125/				1 987 <b>477 631</b>		270
	<b>2.5 i ST200</b>		147-151				1 987 <b>477 836</b>		1462
<b>Courier</b>									
	<b>1.3 i</b>	07.97-08.99	44				0 986 <b>BB3 014</b>	↔	
	<b>1.4 i 16V</b>	07.97-08.99	66				0 986 <b>BB3 014</b>	↔	



		S				?			
◀ FORD									
<b>Econovan</b>									
	2.0D	02.86-12.99	41				F 026 <b>A02 213</b>	→	
							F 026 <b>A02 214</b>	←	
<b>EcoSport</b>									
	1.0 EcoBoost	10.13→	92						1 987 <b>470 506<sup>8</sup></b>
	1.5 TDCi, Ti-VCT	10.13→	67/82						1 987 <b>470 506<sup>8</sup></b>
	1.0 EcoBoost	10.13→	92				0 265 <b>009 271<sup>4</sup></b>		
	1.5 TDCi, Ti-VCT	10.13→	67/82				0 265 <b>009 271<sup>4</sup></b>		
<b>Escort</b>									
	1.8 D	01.95-11.01	44				F 026 <b>002 581</b>	↔ 20,64	
<b>Escort [Fase I]</b>									
	1.6 i	03.94-09.96	60			BRB, 0 986 <b>AB8 443</b>		←	
						BSY, 0 986 <b>AB8 444</b>		→	
	1.8 i	01.94-09.96	66			BRB, 0 986 <b>AB8 443</b>		←	
						BSY, 0 986 <b>AB8 444</b>		→	
	2.0 iXR3	01.92-09.96	85/88		STB	BRB, 0 986 <b>AB8 443</b>		←	
						BSY, 0 986 <b>AB8 444</b>		→	
<b>Escort [Fase II]</b>									
	1.8 i 16V	09.96-10.02	85				F 026 <b>002 581</b>	↔ 20,64	
							0 986 <b>AB8 424</b>	←	
							0 986 <b>AB8 425</b>	→	
	1.8 i 16V	09.96-10.02	85				1 987 <b>477 834</b>		1705
<b>Escort Hobby</b>									
	1.0	04.93-01.96	38				0 986 <b>AB8 424</b>	←	
							0 986 <b>AB8 425</b>	→	
	1.6	04.93-01.96	56				0 986 <b>AB8 424</b>	←	
							0 986 <b>AB8 425</b>	→	
<b>Escort Sedan [Fase II]</b>									
	1.8 i 16V	09.96-02.00	85				F 026 <b>002 581</b>	↔ 20,64	
							0 986 <b>AB8 424</b>	←	
							0 986 <b>AB8 425</b>	→	



		S							
									
	1.8i16V	09.96-02.00	85				1 987 477 834	1705	
<b>Escort SW</b>									
									
	1.6i	11.00-10.02	80				F 026 002 581	↔ 20,64	
							0 986 AB8 443	←	
							0 986 AB8 444	→	
	1.8i16V	09.96-10.02	85				F 026 002 581	↔ 20,64	
							0 986 AB8 443	←	
							0 986 AB8 444	→	
									
	1.6i	11.00-10.02	80				1 987 477 834	1705	
	1.8i16V	09.96-10.02	85				1 987 477 834	1705	
<b>Escort VII Cabrio [95]</b>									
									
	1.4i	01.95-09.01	54				0 204 102 922	← 54	0 204 104 161 <sup>7</sup>
							0 204 103 931		
							0 986 134 095		
							0 204 102 923	→ 54	0 204 104 161 <sup>7</sup>
							0 204 103 924		
							0 986 135 095		
	1.8TD	01.95-09.01	51/66				0 204 102 922	← 54	0 204 104 161 <sup>7</sup>
							0 204 103 931		
							0 986 134 095		
							0 204 102 923	→ 54	0 204 104 161 <sup>7</sup>
							0 204 103 924		
							0 986 135 095		
									
	1.4i	01.95-09.01	54				F 026 002 581	↔ 20,64	
							0 986 475 739	↔ 22,2	
							0 986 475 776	↔ 19	
	1.8TD	01.95-09.01	51/66				F 026 002 581	↔ 20,64	
							0 986 475 739	↔ 22,2	
							0 986 475 776	↔ 19	
	1.8TD	01.95-09.01	51/66				0 986 473 094	 ← 32,95	
							0 986 474 094	 → 32,95	
									
	1.4i	01.95-05.99	54				1 987 477 522	281	
		01.95-09.01	54			LLE	1 987 477 834	1705	
						RLE	1 987 477 835	1650	
	1.8TD	01.95-05.99	66				1 987 477 522	281	
		01.95-09.01	66			LLE	1 987 477 834	1705	
						RLE	1 987 477 835	1650	
		10.95-05.99	51				1 987 477 522	281	
		10.95-09.01	51			LLE	1 987 477 834	1705	
						RLE	1 987 477 835	1650	
	1.4i	08.95-09.01	54				0 986 594 029 <sup>3</sup>		
	1.8TD	08.95-09.01	51/66				0 986 594 029 <sup>3</sup>		



		S				?			
◀ FORD									
<b>Escort VII Express [95]</b>									
	1.4i55 1.4i75	01.95-09.01	54				0 204 102 922 0 204 103 931 0 986 134 095	← 54  	0 204 104 161 <sup>7</sup>
							0 204 102 923 0 204 103 924 0 986 135 095	→ 54  	0 204 104 161 <sup>7</sup>
	1.8D 55 1.8D 75 1.8TD	01.95-09.01	44/51				0 204 102 922 0 204 103 931 0 986 134 095	← 54  	0 204 104 161 <sup>7</sup>
							0 204 102 923 0 204 103 924 0 986 135 095	→ 54  	0 204 104 161 <sup>7</sup>
	1.4i55, i75 1.8D 55, D 75, TD	01.95-09.01	54 44/51				0 986 475 739 0 986 475 739	↔ 22,2 ↔ 22,2	
	1.4i55 1.4i75 1.8D 55, D 75, TD	01.95-02.99 01.95-09.01 01.95-02.99	54 54 44/51				1 987 477 522 1 987 482 123 1 987 477 522	281 1751 281	
		01.95-09.01	44/51				1 987 482 123	1751	
	1.4i55, i75 1.8D 55, D 75, TD	08.95-09.01	54 44/51				0 986 594 029 <sup>3</sup> 0 986 594 029 <sup>3</sup>		
<b>Escort VII RS Cosworth [95]</b>									
	2.0i4x4	01.95-12.95	162						1 987 470 034 <sup>7</sup> 1 987 470 506 <sup>8</sup>
	2.0i4x4	01.95-12.95	162				0 986 474 152 0 986 474 152	→ 42,79 	
<b>Escort VII RS [95]</b>									
	2000 2000 4x4	01.95-08.96	110						1 987 470 034 <sup>7</sup> 1 987 470 506 <sup>8</sup>
	2000 2000 4x4	01.95-08.96	110				0 986 475 739	↔ 22,2	
	2000 2000 4x4	01.95-08.96	110				0 986 473 094 0 986 474 094	← 32,95 → 32,95	
	2000 2000, 4x4	08.95-05.96 01.95-08.96	110 110			LLE RLE	1 987 477 834 1 987 477 835 1 987 477 522	1705 1650 281	



































		S							
	<b>2000</b> 2000 4x4	08.95-08.96	110				0 986 594 029 <sup>3</sup>		
<b>Escort VII Turnier [95]</b>									
	<b>1.3i</b>	01.95-09.01	44				0 204 102 922 0 204 103 931 0 986 134 095	← 54	0 204 104 161 <sup>7</sup>
							0 204 102 923 0 204 103 924 0 986 135 095	→ 54	0 204 104 161 <sup>7</sup>
	<b>1.4i</b>	01.95-09.01	54				0 204 102 922 0 204 103 931 0 986 134 095	← 54	0 204 104 161 <sup>7</sup>
							0 204 102 923 0 204 103 924 0 986 135 095	→ 54	0 204 104 161 <sup>7</sup>
	<b>1.6i 16V</b>	01.95-09.01	65/66				0 204 102 922 0 204 103 931 0 986 134 095	← 54	0 204 104 161 <sup>7</sup>
							0 204 102 923 0 204 103 924 0 986 135 095	→ 54	0 204 104 161 <sup>7</sup>
	<b>1.8D</b> <b>1.8i 16V</b> <b>1.8TD</b>	01.95-09.01	44/51/66/ 77/85				0 204 102 922 0 204 103 931 0 986 134 095	← 54	0 204 104 161 <sup>7</sup>
							0 204 102 923 0 204 103 924 0 986 135 095	→ 54	0 204 104 161 <sup>7</sup>
	<b>1.3i</b>	01.95-09.01	44				F 026 002 581 0 986 475 739 0 986 475 776	↔ 20,64 ↔ 22,2 ↔ 19	
	<b>1.4i</b>	01.95-09.01	54				F 026 002 581 0 986 475 739 0 986 475 776	↔ 20,64 ↔ 22,2 ↔ 19	
	<b>1.6i 16V</b>	01.95-09.01	65/66				F 026 002 581 0 986 475 739 0 986 475 776	↔ 20,64 ↔ 22,2 ↔ 19	
	<b>1.8D</b> <b>1.8i 16V</b> <b>1.8TD</b>	01.95-09.01	44/51/66/ 77/85				F 026 002 581 0 986 475 739 0 986 475 776	↔ 20,64 ↔ 22,2 ↔ 19	
	<b>1.6i 16V</b>	01.95-09.01	65/66				0 986 473 094 0 986 474 094	← 32,95 → 32,95	
	<b>1.8D, i 16V, TD</b>	01.95-09.01	44/51/66/ 77/85				0 986 473 094 0 986 474 094	← 32,95 → 32,95	
	<b>1.3i</b>	01.95-05.99 01.95-09.01	44 44			LLE RLE	1 987 477 522 1 987 477 834 1 987 477 835	281 1705 1650	
	<b>1.4i</b>	01.95-05.99 01.95-09.01	54 54			LLE RLE	1 987 477 522 1 987 477 834 1 987 477 835	281 1705 1650	
	<b>1.6i 16V</b>	01.95-05.99 01.95-09.01	65 66 65			LLE RLE	1 987 477 522 1 987 477 522 1 987 477 834 1 987 477 835	281 281 1705 1650	







































		S							
<b>◀ FORD Escort VII Turnier [95]</b>									
1.6 i 16V		01.95-09.01	66			LLE	1987 477 834		1705
						RLE	1987 477 835		1650
1.8 D		01.95-05.99	44				1987 477 522		281
		01.95-09.01	44			LLE	1987 477 834		1705
1.8 i 16V		01.95-05.99	77				1987 477 522		281
		01.95-09.01	77			LLE	1987 477 834		1705
1.8 TD		09.95-05.99	85				1987 477 522		281
		09.95-09.01	85			LLE	1987 477 834		1705
						RLE	1987 477 835		1650
1.3 i		08.95-09.01	44				0986 594 029 <sup>3</sup>		
		08.95-09.01	54				0986 594 029 <sup>3</sup>		
1.4 i		08.95-09.01	65/66				0986 594 029 <sup>3</sup>		
1.6 i 16V		08.95-09.01	44/51/66/77/85				0986 594 029 <sup>3</sup>		
1.8 D, i 16V, TD		08.95-09.01					0986 594 029 <sup>3</sup>		
<b>Escort VII XR3i Cabrio [95]</b>									
1.6 i		01.95-09.01	65-66				0 204 102 922	← 54	0 204 104 161 <sup>7</sup>
							0 204 103 931		
							0986 134 095		
							0 204 102 923	→ 54	0 204 104 161 <sup>7</sup>
1.8 i		01.95-08.95	96						1987 470 034 <sup>7</sup>
									1987 470 506 <sup>8</sup>
		01.95-09.01	77/85				0 204 102 922	← 54	0 204 104 161 <sup>7</sup>
							0 204 103 931		
					0986 134 095				
					0 204 102 923	→ 54	0 204 104 161 <sup>7</sup>		
					0 204 103 924				
					0986 135 095				
1.6 i		01.95-09.01	65-66				F 026 002 581	↔ 20,64	
							0986 475 739	↔ 22,2	
							0986 475 776	↔ 19	
1.8 i		01.95-09.01	77/85/96				F 026 002 581	↔ 20,64	
							0986 475 739	↔ 22,2	
							0986 475 776	↔ 19	
1.6 i		01.95-09.01	65-66				0986 473 094	← 32,95	
							0986 474 094	→ 32,95	
1.8 i		01.95-09.01	77/85/96				0986 473 094	← 32,95	
							0986 474 094	→ 32,95	
1.6 i		01.95-05.99	65				1987 477 522		281
			65-66				1987 477 522		281
			66				1987 477 522		281
		01.95-09.01	65			LLE	1987 477 834		1705
						RLE	1987 477 835		1650

		S								
1.6i		01.95-09.01	65-66				LLE	1 987 477 834	1705	
							RLE	1 987 477 835	1650	
1.8i		01.95-08.95	96					1 987 477 522	281	
		01.95-05.99	77						1 987 477 522	281
		01.95-09.01	77					LLE	1 987 477 834	1705
								RLE	1 987 477 835	1650
		08.95-08.95	96					LLE	1 987 477 834	1705
								RLE	1 987 477 835	1650
09.95-05.99	85						1 987 477 522	281		
09.95-09.01	85					LLE	1 987 477 834	1705		
						RLE	1 987 477 835	1650		
	1.6i	08.95-09.01	65-66				0 986 594 029 <sup>3</sup>			
	1.8i	08.95-09.01	77/85/96				0 986 594 029 <sup>3</sup>			
<b>Escort VII [95]</b>										
										
	1.3i	01.95-09.01	44				0 204 102 922	← 54	0 204 104 161 <sup>7</sup>	
							0 204 103 931			
							0 986 134 095			
							0 204 102 923	→ 54	0 204 104 161 <sup>7</sup>	
							0 204 103 924			
							0 986 135 095			
	1.4i	01.95-09.01	54				0 204 102 922	← 54	0 204 104 161 <sup>7</sup>	
							0 204 103 931			
							0 986 134 095			
							0 204 102 923	→ 54	0 204 104 161 <sup>7</sup>	
							0 204 103 924			
							0 986 135 095			
	1.6i 16V	01.95-09.01	65/66				0 204 102 922	← 54	0 204 104 161 <sup>7</sup>	
	1.6i 16V 4x4						0 204 103 931			
							0 986 134 095			
							0 204 102 923	→ 54	0 204 104 161 <sup>7</sup>	
							0 204 103 924			
							0 986 135 095			
	1.8D	01.95-09.01	44/51/66/ 77/85				0 204 102 922	← 54	0 204 104 161 <sup>7</sup>	
	1.8i 16V						0 204 103 931			
	1.8TD						0 986 134 095			
							0 204 102 923	→ 54	0 204 104 161 <sup>7</sup>	
							0 204 103 924			
							0 986 135 095			
										
	1.3i	01.95-09.01	44				F 026 002 581	↔ 20,64		
							0 986 475 739	↔ 22,2		
							0 986 475 776	↔ 19		
	1.4i	01.95-09.01	54				F 026 002 581	↔ 20,64		
							0 986 475 739	↔ 22,2		
							0 986 475 776	↔ 19		
	1.6i 16V	01.95-09.01	65/66				F 026 002 581	↔ 20,64		
	1.6i 16V 4x4						0 986 475 739	↔ 22,2		
							0 986 475 776	↔ 19		
	1.8D	01.95-09.01	44/51/66/ 77/85				F 026 002 581	↔ 20,64		
	1.8i 16V						0 986 475 739	↔ 22,2		
	1.8TD						0 986 475 776	↔ 19		
	1.6i 16V	01.95-09.01	65/66				0 986 473 094	 ← 32,95		
	1.6i 16V 4x4						0 986 474 094	 → 32,95		



		S									
<b>FORD Escort VII [95]</b>											
	1.8D, i16V, TD	01.95-09.01	44/51/66/77/85			0986 473 094		← 32,95			
						0986 474 094		→ 32,95			
	1.3 i	01.95-05.99	44			1987 477 522		281			
		01.95-09.01	44	LLE		1987 477 834		1705			
				RLE		1987 477 835		1650			
	1.4 i	01.95-05.99	54			1987 477 522		281			
		01.95-09.01	54	LLE		1987 477 834		1705			
				RLE		1987 477 835		1650			
	1.6 i 16V	01.95-05.99	65			1987 477 522		281			
			66			1987 477 522		281			
		01.95-09.01	65	LLE		1987 477 834		1705			
			66	RLE		1987 477 835		1650			
				LLE		1987 477 834		1705			
				RLE		1987 477 835		1650			
	1.6 i 16V 4x4	01.95-05.99	66			1987 477 522		281			
	1.8D	01.95-05.99	44			1987 477 522		281			
		01.95-09.01	44	LLE		1987 477 834		1705			
				RLE		1987 477 835		1650			
	1.8 i 16V	01.95-05.99	77			1987 477 522		281			
		01.95-09.01	77	LLE		1987 477 834		1705			
				RLE		1987 477 835		1650			
		09.95-05.99	85			1987 477 522		281			
				LLE		1987 477 834		1705			
				RLE		1987 477 835		1650			
	1.8 TD	01.95-05.99	66			1987 477 522		281			
		01.95-09.01	66	LLE		1987 477 834		1705			
				RLE		1987 477 835		1650			
		10.95-05.99	51			1987 477 522		281			
				LLE		1987 477 834		1705			
				RLE		1987 477 835		1650			
	1.3 i	08.95-09.01	44			0986 594 029 <sup>3</sup>					
		1.4 i	08.95-09.01	54			0986 594 029 <sup>3</sup>				
				1.6 i 16V, i 16V 4x4	08.95-09.01	65/66			0986 594 029 <sup>3</sup>		
				1.8D, i 16V, TD	08.95-09.01	44/51/66/77/85			0986 594 029 <sup>3</sup>		
<b>Escort V/VI Cabrio [91]</b>											
	1.4 i	08.90-12.94	52/54-55			0204 102 922		← 54	0204 104 161 <sup>7</sup>		
						0204 103 931					
						0986 134 095					
						0204 102 923		→ 54	0204 104 161 <sup>7</sup>		
				0204 103 924							
				0986 135 095							
	1.6 i 16V	02.93-12.94	65/66			0204 102 922		← 54	0204 104 161 <sup>7</sup>		
						0204 103 931					
						0986 134 095					
						0204 102 923		→ 54	0204 104 161 <sup>7</sup>		
				0204 103 924							
				0986 135 095							
	1.4 i	ABO	08.90-12.94	52			0986 475 776		↔ 19		
			07.93-12.94	54-55	AG		0986 475 776		↔ 19		
					GS		F 026 002 581		↔ 20,64		
		ABS	08.90-12.94	52/54-55			0986 475 739		↔ 22,2		
		1.6 i 16V	ABO	02.93-12.94	65/66			0986 475 776		↔ 19	
				ABS	02.93-12.94	65/66			0986 475 739		↔ 22,2

		S							
	1.4i	08.90-12.94	52/54-55				0 986 473 094	 ← 32,95	
							0 986 474 094	 → 32,95	
	1.6i 16V	02.93-12.94	65/66				0 986 473 094	 ← 32,95	
							0 986 474 094	 → 32,95	
	1.4i	08.90-12.94	52/54-55				1 987 477 367		151
		02.94-12.94	52/54-55				1 987 477 232		1602
	1.6i 16V	02.93-12.94	65/66				1 987 477 367		151
		02.94-12.94	65/66				1 987 477 232		1602
<b>Escort V/VI Express [91]</b>									
	1.3	08.90-12.94	46				0 204 102 922	← 54	0 204 104 161 <sup>7</sup>
							0 204 103 931		
							0 986 134 095		
							0 204 102 923	→ 54	0 204 104 161 <sup>7</sup>
							0 204 103 924		
							0 986 135 095		
	1.4i	08.90-12.94	52				0 204 102 922	← 54	0 204 104 161 <sup>7</sup>
							0 204 103 931		
							0 986 134 095		
							0 204 102 923	→ 54	0 204 104 161 <sup>7</sup>
1.8D	08.90-12.94	44				0 204 102 922	← 54	0 204 104 161 <sup>7</sup>	
						0 204 103 931			
						0 986 134 095			
						0 204 102 923	→ 54	0 204 104 161 <sup>7</sup>	
						0 204 103 924			
						0 986 135 095			
	1.3	08.90-12.94	46				0 986 475 739	↔ 22,2	
	1.4i	08.90-12.94	52				0 986 475 739	↔ 22,2	
	1.8D	08.90-12.94	44				0 986 475 739	↔ 22,2	
	1.3	08.90-12.94	46				0 986 473 094	 ← 32,95	
							0 986 474 094	 → 32,95	
	1.4i	08.90-12.94	52				0 986 473 094	 ← 32,95	
							0 986 474 094	 → 32,95	
1.8D	08.90-12.94	44				0 986 473 094	 ← 32,95		
						0 986 474 094	 → 32,95		
	1.3	08.90-12.94	46				1 987 477 234		3400
							1 987 477 367		151
	1.4i	08.90-12.94	52				1 987 477 234		3400
							1 987 477 367		151
	1.8D	08.90-12.94	44				1 987 477 234		3400
							1 987 477 367		151
<b>Escort V/VI RS [91]</b>									
	2.0i Cosworth	04.92-12.94	162						1 987 470 506 <sup>8</sup>
	2000	05.91-12.94	110						1 987 470 034 <sup>7</sup>
									1 987 470 506 <sup>8</sup>



◀ FORD Escort V/VI RS [91]								
	2.0 i Cosworth	04.92-12.94	162			0986 474 152	→ 42,79	
	2000	05.91-12.94	110			0986 474 152		
						0986 473 094	← 32,95	
						0986 474 094	→ 32,95	
	2000	05.91-12.94	110			1987 477 367	151	
Escort V/VI Turnier [91]								
	1.3	08.90-12.94	44			0 204 102 922	← 54	0 204 104 161 <sup>7</sup>
	1.3 i					0 204 103 931		
						0986 134 095		
						0 204 102 923	→ 54	0 204 104 161 <sup>7</sup>
						0 204 103 924		
						0986 135 095		
	1.4 i	08.90-12.94	52/54-55			0 204 102 922	← 54	0 204 104 161 <sup>7</sup>
						0 204 103 931		
						0986 134 095		
						0 204 102 923	→ 54	0 204 104 161 <sup>7</sup>
						0 204 103 924		
						0986 135 095		
	1.6	08.90-12.94	65/66			0 204 102 922	← 54	0 204 104 161 <sup>7</sup>
	1.6 i 16V					0 204 103 931		
						0986 134 095		
						0 204 102 923	→ 54	0 204 104 161 <sup>7</sup>
						0 204 103 924		
						0986 135 095		
	1.8 D	08.90-12.94	44/66/77			0 204 102 922	← 54	0 204 104 161 <sup>7</sup>
	1.8 i 16V					0 204 103 931		
	1.8 TD					0986 134 095		
						0 204 102 923	→ 54	0 204 104 161 <sup>7</sup>
						0 204 103 924		
						0986 135 095		
	1.8 i 16V	02.92-12.94	96					1987 470 034 <sup>7</sup>
								1987 470 506 <sup>8</sup>
	1.3	ABO	08.90-12.94	44		0986 475 776	↔ 19	
	1.3 i	ABS	08.90-12.94	44		0986 475 739	↔ 22,2	
	1.4 i	ABO	08.90-12.94	52/54-55		0986 475 776	↔ 19	
		ABS	08.90-12.94	52/54-55		0986 475 739	↔ 22,2	
	1.6	ABO	08.90-12.94	65/66		0986 475 776	↔ 19	
	1.6 i 16V	ABS	08.90-12.94	65/66		0986 475 739	↔ 22,2	
	1.8 D, i 16V, TD	ABO	08.90-12.94	44/66/77		0986 475 776	↔ 19	
		ABS	08.90-12.94	44/66/77/96		0986 475 739	↔ 22,2	
	1.3		08.90-12.94	44		0986 473 094	← 32,95	
	1.3 i					0986 474 094	→ 32,95	
	1.4 i		08.90-12.94	52/54-55		0986 473 094	← 32,95	
						0986 474 094	→ 32,95	
	1.6		08.90-12.94	65/66		0986 473 094	← 32,95	
	1.6 i 16V					0986 474 094	→ 32,95	
	1.8 D, i 16V, TD		08.90-12.94	44/66/77/ 96		0986 473 094	← 32,95	
						0986 474 094	→ 32,95	



		S							
	1.3		08.90-12.94	44			1 987 477 367		151
	1.3i		02.94-12.94	44			1 987 477 232		1602
	1.4i		08.90-12.94	52/54-55			1 987 477 367		151
			02.94-12.94	52/54-55			1 987 477 232		1602
	1.6		08.90-12.94	65/66			1 987 477 367		151
	1.6i 16V		02.94-12.94	65/66			1 987 477 232		1602
	1.8D, i 16V, TD		08.90-12.94	44/66/77			1 987 477 367		151
			02.94-12.94	44/66/77			1 987 477 232		1602
	1.8i 16V		02.92-12.94	96			1 987 477 367		151
<b>Escort V/VI XR3i Cabrio [91]</b>									
	1.8i		02.92-12.94	77			0 204 102 922	← 54	0 204 104 161 <sup>7</sup>
							0 204 103 931		
							0 986 134 095		
							0 204 102 923	→ 54	0 204 104 161 <sup>7</sup>
							0 204 103 924		
							0 986 135 095		
				96					1 987 470 034 <sup>7</sup>
									1 987 470 506 <sup>8</sup>
	1.8i	ABO	02.92-12.94	77			0 986 475 776	↔ 19	
		ABS	02.92-12.94	77/96			0 986 475 739	↔ 22,2	
	1.8i		02.92-12.94	77/96			0 986 473 094	← 32,95	
							0 986 474 094	→ 32,95	
	1.8i		02.92-12.94	77			1 987 477 367		151
				96			1 987 477 367		151
			02.94-12.94	77			1 987 477 232		1602
<b>Escort V/VI XR3i [91]</b>									
	1.8i		02.92-12.94	77			0 204 102 922	← 54	0 204 104 161 <sup>7</sup>
							0 204 103 931		
							0 986 134 095		
							0 204 102 923	→ 54	0 204 104 161 <sup>7</sup>
							0 204 103 924		
							0 986 135 095		
				96					1 987 470 034 <sup>7</sup>
									1 987 470 506 <sup>8</sup>
	1.8i	ABO	02.92-12.94	77			0 986 475 776	↔ 19	
		ABS	02.92-12.94	77/96			0 986 475 739	↔ 22,2	
	1.8i		02.92-12.94	77/96			0 986 473 094	← 32,95	
							0 986 474 094	→ 32,95	
	1.8i		02.92-12.94	77			1 987 477 367		151
				96			1 987 477 367		151
			02.94-12.94	77			1 987 477 232		1602





◀ FORD

Escort V/VI [91]



	1.1	ABO 08.90-12.94 40				0 204 104 161 <sup>7</sup>	
		ABS 08.90-12.94 40			0 204 102 922 ← 54	0 204 104 161 <sup>7</sup>	
					0 204 103 931 0 986 134 095		
						0 204 102 923 → 54	0 204 104 161 <sup>7</sup>
						0 204 103 924 0 986 135 095	
	1.3	08.92-12.94 44/46			0 204 102 922 ← 54	0 204 104 161 <sup>7</sup>	
	1.3i				0 204 103 931 0 986 134 095		
					0 204 102 923 → 54	0 204 104 161 <sup>7</sup>	
					0 204 103 924 0 986 135 095		
	1.4	08.90-12.94 52/54-55			0 204 102 922 ← 54	0 204 104 161 <sup>7</sup>	
	1.4i				0 204 103 931 0 986 134 095		
					0 204 102 923 → 54	0 204 104 161 <sup>7</sup>	
					0 204 103 924 0 986 135 095		
	1.6	08.90-12.94 65/66			0 204 102 922 ← 54	0 204 104 161 <sup>7</sup>	
	1.6i 16V				0 204 103 931 0 986 134 095		
					0 204 102 923 → 54	0 204 104 161 <sup>7</sup>	
					0 204 103 924 0 986 135 095		
	1.8D	08.90-12.94 44/66/77			0 204 102 922 ← 54	0 204 104 161 <sup>7</sup>	
	1.8i 16V				0 204 103 931 0 986 134 095		
	1.8TD				0 204 102 923 → 54	0 204 104 161 <sup>7</sup>	
					0 204 103 924 0 986 135 095		



	1.1	ABO 08.90-12.94 40			F 026 002 581 ↔ 20,64
		ABS 08.90-12.94 40			0 986 475 739 ↔ 22,2
	1.3	08.90-12.94 44/46			F 026 002 581 ↔ 20,64
	1.3i	08.90-12.94 44/46			0 986 475 739 ↔ 22,2
	1.4	08.90-12.94 52/54-55	AG		0 986 475 776 ↔ 19
	1.4i		GS		F 026 002 581 ↔ 20,64
		ABS 08.90-12.94 52/54-55			0 986 475 739 ↔ 22,2
	1.6	08.90-12.94 65/66			0 986 475 776 ↔ 19
	1.6i 16V	08.90-12.94 65/66			0 986 475 739 ↔ 22,2
	1.8D, i16V, TD	08.90-12.94 44/66/77			0 986 475 776 ↔ 19
		ABS 08.90-12.94 44/66/77			0 986 475 739 ↔ 22,2

	1.1	08.90-12.94 40			0 986 473 094 ← 32,95
					0 986 474 094 → 32,95
	1.3	08.90-12.94 44/46			0 986 473 094 ← 32,95
	1.3i				0 986 474 094 → 32,95
	1.4	08.90-12.94 52/54-55			0 986 473 094 ← 32,95
	1.4i				0 986 474 094 → 32,95
	1.6	08.90-12.94 65/66			0 986 473 094 ← 32,95
	1.6i 16V				0 986 474 094 → 32,95
	1.8D, i16V, TD	08.90-12.94 44/66/77			0 986 473 094 ← 32,95
					0 986 474 094 → 32,95

		S							
	1.1	08.90-12.94	40				1 987 477 367	151	
		02.94-12.94	40				1 987 477 232	1602	
	1.3	08.90-12.94	44/46				1 987 477 367	151	
	1.3i	02.94-12.94	44/46				1 987 477 232	1602	
	1.4	08.90-12.94	52/54-55				1 987 477 367	151	
	1.4i	02.94-12.94	52/54-55				1 987 477 232	1602	
	1.6	08.90-12.94	65/66				1 987 477 367	151	
	1.6i 16V	02.94-12.94	65/66				1 987 477 232	1602	
	1.8D, i 16V, TD	08.90-12.94	44/66/77				1 987 477 367	151	
		02.94-12.94	44/66/77				1 987 477 232	1602	
<b>Fairlane [NC II]</b>									
	4.0i	03.92-02.95	148						F 026 A08 086 <sup>6</sup>
<b>Fairlane [NL]</b>									
	4.0i	11.96-02.99	162						F 026 A08 167
	4.0i	09.96-02.99	162				0 204 B08 425	←	
							0 204 B08 428	→	
	4.0i	09.96-02.99	162				0 265 006 230 <sup>3</sup>		
<b>Falcon</b>									
	4.0i	04.96→	157				0 204 B08 425	←	
							0 204 B08 428	→	
	4.0i	ABS 08.98-10.01	157			LIM,RAB	0 265 006 482 <sup>3</sup>		
<b>Falcon [EF]</b>									
	4.0i	09.94-09.95	157				0 204 B08 425	←	
							0 204 B08 428	→	
<b>Falcon Utility [XG]</b>									
	4.0	03.97→	148/157						F 026 A08 167
	4.0	03.97→	148/157						F 026 A08 086 <sup>6</sup>





		S							
◀ FORD									
<b>Fiesta</b>									
	1.4i	10.98-02.00	55				0986 473 897	← 48	1987 470 506 <sup>8</sup>
							0986 473 898	→ 48	1987 470 506 <sup>8</sup>
					INB		0986 473 897	← 48	
							0986 473 898	→ 48	
		03.00-12.04	55		INB		0986 134 286	← 48	
							0986 135 286	→ 48	
<b>Fiesta [Fase II]</b>									
	1.4i 16V	04.96-08.99	66				0986 AB8 491	↔	
	1.6i	09.99-04.05	70				0986 AB8 491	↔	
<b>Fiesta [Fase III]</b>									
	1.6i	ABO 05.02-04.11	72				0986 473 909	← 54	
							0986 473 909		
							0986 473 910	→ 54	
							0986 473 910		
	1.6i	05.02-04.11	72				0986 BB3 011	↔	
<b>Fiesta III Courier [89]</b>									
	1.3	09.91-10.95	44						1987 470 506 <sup>8</sup>
	1.3i	11.95-08.96	44				0986 473 909	← 54	1987 470 506 <sup>8</sup>
							0986 473 910	→ 54	1987 470 506 <sup>8</sup>
	1.8D	09.91-10.95	44						1987 470 506 <sup>8</sup>
		11.95-08.96	44				0986 473 909	← 54	1987 470 506 <sup>8</sup>
							0986 473 910	→ 54	1987 470 506 <sup>8</sup>
	1.3	09.91-12.94	44				F 026 002 401	↔ 22	
	1.3i	01.95-08.96	44				0986 475 739	↔ 22,2	
	1.8D	09.91-12.94	44				F 026 002 401	↔ 22	
		01.95-08.96	44				0986 475 739	↔ 22,2	
	1.3	09.91-08.96	44		ABM		1987 477 233		3930
	1.3i						1987 477 367		151
	1.8D	09.91-08.96	44		ABM		1987 477 233		3930
							1987 477 367		151
<b>Fiesta III [89]</b>									
	1.0	03.89-10.95	33		INB				1987 470 506 <sup>8</sup>
		03.89-12.96	33		INB		0986 473 897	← 48	1987 470 506 <sup>8</sup>
							0986 473 898	→ 48	1987 470 506 <sup>8</sup>
		11.95-12.96	33		INB		0986 473 909	← 54	1987 470 506 <sup>8</sup>
							0986 473 910	→ 54	1987 470 506 <sup>8</sup>





















































		S									
	<b>FORD Fiesta III [89]</b>										
1.6 XR2i	11.95-12.96	81		INB			0986 <b>473 909</b>	← 54	1987 <b>470 506</b> <sup>8</sup>		
							0986 <b>473 910</b>	→ 54	1987 <b>470 506</b> <sup>8</sup>		
1.8 D	03.89-10.95	44		INB					1987 <b>470 506</b> <sup>8</sup>		
							03.89-12.96	44	INB		
	11.95-12.96	44		INB			0986 <b>473 898</b>	→ 48	1987 <b>470 506</b> <sup>8</sup>		
							0986 <b>473 909</b>	← 54	1987 <b>470 506</b> <sup>8</sup>		
1.8 i 16V	02.92-12.96	77		INB			0986 <b>473 897</b>	← 48	1987 <b>470 506</b> <sup>8</sup>		
							0986 <b>473 898</b>	→ 48	1987 <b>470 506</b> <sup>8</sup>		
1.8 i 16V	02.92-10.95	77		INB					1987 <b>470 506</b> <sup>8</sup>		
1.8 XR2i 16V	11.95-12.96	77		INB			0986 <b>473 909</b>	← 54	1987 <b>470 506</b> <sup>8</sup>		
							0986 <b>473 910</b>	→ 54	1987 <b>470 506</b> <sup>8</sup>		
1.8 XR2i 16V	02.92-10.95	93-96		INB					1987 <b>470 506</b> <sup>8</sup>		
							02.92-12.96	77	INB	0986 <b>473 897</b>	← 48
	11.95-12.96	93-96		INB			0986 <b>473 898</b>	→ 48	1987 <b>470 506</b> <sup>8</sup>		
							0986 <b>473 897</b>	← 48	1987 <b>470 506</b> <sup>8</sup>		
1.8 XR2i 16V	11.95-12.96	93-96		INB			0986 <b>473 909</b>	← 54	1987 <b>470 506</b> <sup>8</sup>		
							0986 <b>473 910</b>	→ 54	1987 <b>470 506</b> <sup>8</sup>		
1.0	03.89-01.94	33					F 026 <b>002 396</b>	↔ 17,5			
							03.89-12.96	33	F 026 <b>002 401</b>	↔ 22	
							02.94-12.96	33	F 026 <b>002 397</b>	↔ 19,05	
1.1	03.89-01.94	36-37/40					F 026 <b>002 396</b>	↔ 17,5			
1.1 i	03.89-12.96	36-37/40					F 026 <b>002 401</b>	↔ 22			
							02.94-12.96	36-37/40	F 026 <b>002 397</b>	↔ 19,05	
1.3	06.91-01.94	43-44					F 026 <b>002 396</b>	↔ 17,5			
1.3 i	06.91-12.96	43-44					F 026 <b>002 401</b>	↔ 22			
							02.94-12.96	43-44	F 026 <b>002 397</b>	↔ 19,05	
1.4	03.89-01.94	52/54-55					F 026 <b>002 396</b>	↔ 17,5			
1.4 i	03.89-12.96	52/54-55					F 026 <b>002 401</b>	↔ 22			
							02.94-12.96	52/54-55	F 026 <b>002 397</b>	↔ 19,05	
1.6, i 16V, Turbo, XR2i	03.89-12.96	65-66/76/ 81/96-98					F 026 <b>002 398</b>	↔ 19			
							F 026 <b>002 401</b>	↔ 22			
1.8 D	03.89-01.94	44					F 026 <b>002 396</b>	↔ 17,5			
							03.89-12.96	44	F 026 <b>002 401</b>	↔ 22	
1.8 i 16V	02.92-12.96	77/93-96					F 026 <b>002 398</b>	↔ 19			
1.8 XR2i 16V							F 026 <b>002 401</b>	↔ 22			
1.0	03.89-08.96	33		KW			1987 <b>477 233</b>		3930		
							03.89-12.96	33	1987 <b>477 367</b>		151
							02.94-12.96	33	1987 <b>477 372</b>		3255
1.1	03.89-08.96	36-37/40		KW			1987 <b>477 233</b>		3930		
1.1 i	03.89-12.96	36-37/40					1987 <b>477 367</b>		151		
							02.94-12.96	36-37/40	1987 <b>477 372</b>		3255
1.3	06.91-08.96	43-44		KW			1987 <b>477 233</b>		3930		
1.3 i	06.91-12.96	43-44					1987 <b>477 367</b>		151		
							02.94-12.96	43-44	1987 <b>477 372</b>		3255
1.4	03.89-08.96	52/54-55		KW			1987 <b>477 233</b>		3930		
1.4 i	03.89-12.96	52/54-55					1987 <b>477 367</b>		151		
							02.94-12.96	52/54-55	1987 <b>477 372</b>		3255
1.6, i 16V, Turbo, XR2i	03.89-12.96	65-66/76/81/96-98					1987 <b>477 367</b>		151		
							02.94-12.96	65-66/76/81/96-98	1987 <b>477 372</b>		3255
1.8 D	03.89-08.96	44		KW			1987 <b>477 233</b>		3930		
							03.89-12.96	44	1987 <b>477 367</b>		151
							02.94-12.96	44	1987 <b>477 372</b>		3255
1.8 i 16V	02.92-12.96	77/93-96					1987 <b>477 367</b>		151		
1.8 XR2i 16V	02.94-12.96	77/93-96					1987 <b>477 372</b>		3255		

		S				?				
<b>Fiesta IV Courier [96]</b>										
	1.3i	11.95-02.00	44		239	0 986 473 909		← 54	1 987 470 506 <sup>B</sup>	
						0 986 473 910		→ 54	1 987 470 506 <sup>B</sup>	
		ABO	03.00-12.02	44		239	0 986 134 286		← 48	1 987 470 506 <sup>B</sup>
							0 986 135 286		→ 48	1 987 470 506 <sup>B</sup>
		ABS	03.00-12.02	44			0 986 473 275		← 54	1 987 470 506 <sup>B</sup>
							0 986 474 275		→ 54	1 987 470 506 <sup>B</sup>
	1.4i	01.96-02.00	66		239	0 986 473 909		← 54	1 987 470 506 <sup>B</sup>	
							0 986 473 910		→ 54	1 987 470 506 <sup>B</sup>
		ABO	03.00-12.00	66		239	0 986 134 286		← 48	1 987 470 506 <sup>B</sup>
							0 986 135 286		→ 48	1 987 470 506 <sup>B</sup>
	ABS	03.00-12.00	66			0 986 473 275		← 54	1 987 470 506 <sup>B</sup>	
						0 986 474 275		→ 54	1 987 470 506 <sup>B</sup>	
1.8D	10.95-02.00	44/55		239	0 986 473 909		← 54	1 987 470 506 <sup>B</sup>		
1.8TD						0 986 473 910		→ 54	1 987 470 506 <sup>B</sup>	
	ABO	03.00-12.02	44/55		239	0 986 134 286		← 48	1 987 470 506 <sup>B</sup>	
						0 986 135 286		→ 48	1 987 470 506 <sup>B</sup>	
	ABS	03.00-12.02	44/55			0 986 473 275		← 54	1 987 470 506 <sup>B</sup>	
						0 986 474 275		→ 54	1 987 470 506 <sup>B</sup>	
	1.3i	11.95-12.02	44			0 986 475 739		↔ 22,2		
	1.4i	01.96-12.00	66			0 986 475 739		↔ 22,2		
	1.8D, TD	10.95-12.02	44/55			0 986 475 739		↔ 22,2		
	1.3i	11.95-12.02	44			1 987 477 517		312		
	1.4i	01.96-12.00	66			1 987 477 517		312		
	1.8D, TD	10.95-12.02	44/55			1 987 477 517		312		
	1.3i	11.95-12.02	44			0 986 594 023 <sup>3</sup>				
	1.4i	01.96-12.00	66			0 986 594 023 <sup>3</sup>				
	1.8D, TD	10.95-12.02	44/55			0 986 594 023 <sup>3</sup>				
<b>Fiesta IV [96]</b>										
	1.3i	11.95-02.00	37/44		INB	0 986 473 897		← 48	1 987 470 506 <sup>B</sup>	
						0 986 473 898		→ 48	1 987 470 506 <sup>B</sup>	
					239, INB	0 986 473 909		← 54	1 987 470 506 <sup>B</sup>	
						0 986 473 910		→ 54	1 987 470 506 <sup>B</sup>	
			ABO	03.00-12.02	37/44	239	0 986 134 286		← 48	1 987 470 506 <sup>B</sup>
						0 986 135 286		→ 48	1 987 470 506 <sup>B</sup>	
		ABS	03.00-12.02	37/44			0 986 473 275		← 54	1 987 470 506 <sup>B</sup>
							0 986 474 275		→ 54	1 987 470 506 <sup>B</sup>
	1.4i 16V	01.96-02.00	66		INB	0 986 473 897		← 48	1 987 470 506 <sup>B</sup>	
						0 986 473 898		→ 48	1 987 470 506 <sup>B</sup>	
					239, INB	0 986 473 909		← 54	1 987 470 506 <sup>B</sup>	
						0 986 473 910		→ 54	1 987 470 506 <sup>B</sup>	
		ABO	03.00-12.00	66	239	0 986 134 286		← 48	1 987 470 506 <sup>B</sup>	
						0 986 135 286		→ 48	1 987 470 506 <sup>B</sup>	
		ABS	03.00-12.00	66			0 986 473 275		← 54	1 987 470 506 <sup>B</sup>
						0 986 474 275		→ 54	1 987 470 506 <sup>B</sup>	
1.6i 16V	02.00-12.02	76				0 986 473 275		← 54	1 987 470 506 <sup>B</sup>	
						0 986 474 275		→ 54	1 987 470 506 <sup>B</sup>	
				239		0 986 134 286		← 48	1 987 470 506 <sup>B</sup>	
						0 986 135 286		→ 48	1 987 470 506 <sup>B</sup>	



		S														
<b>FORD Fiesta IV [96]</b>																
	1.8 D	10.95-02.00	44/55	INB			0986 473 897		← 48	1987 470 506 <sup>8</sup>						
							0986 473 898		→ 48	1987 470 506 <sup>8</sup>						
	1.8 TD				239,INB			0986 473 909		← 54	1987 470 506 <sup>8</sup>					
								0986 473 910		→ 54	1987 470 506 <sup>8</sup>					
	ABO	03.00-12.02	44/55		239			0986 134 286		← 48	1987 470 506 <sup>8</sup>					
								0986 135 286		→ 48	1987 470 506 <sup>8</sup>					
	ABS	03.00-12.02	44/55					0986 473 275		← 54	1987 470 506 <sup>8</sup>					
								0986 474 275		→ 54	1987 470 506 <sup>8</sup>					
	1.25 i 16V	11.95-02.00	55		INB			0986 473 897		← 48	1987 470 506 <sup>8</sup>					
								0986 473 898		→ 48	1987 470 506 <sup>8</sup>					
		239,INB							0986 473 909		← 54	1987 470 506 <sup>8</sup>				
									0986 473 910		→ 54	1987 470 506 <sup>8</sup>				
ABO		03.00-12.02	55		239			0986 134 286		← 48	1987 470 506 <sup>8</sup>					
								0986 135 286		→ 48	1987 470 506 <sup>8</sup>					
ABS		03.00-12.02	55					0986 473 275		← 54	1987 470 506 <sup>8</sup>					
								0986 474 275		→ 54	1987 470 506 <sup>8</sup>					
	1.3 i	11.95-02.00	37/44	D77,GS	F 026	002 502				↔ 17,5						
										11.95-12.02	37/44	AG	0986 475 776	↔ 19		
										03.00-12.02	37/44	GS	0986 475 905	↔ 19,05		
	1.4 i 16V	01.96-02.00	66	D77,GS	F 026	002 502					↔ 17,5					
											01.96-12.00	66	AG	0986 475 776	↔ 19	
											03.00-12.00	66	GS	0986 475 905	↔ 19,05	
	1.6 i 16V	02.00-02.00	76	D77,GS	F 026	002 502					↔ 17,5					
											02.00-12.02	76	AG	0986 475 776	↔ 19	
											03.00-12.02	76	GS	0986 475 905	↔ 19,05	
	1.8 D	10.95-02.00	44/55	D77,GS	F 026	002 502					↔ 17,5					
	1.8 TD	10.95-12.02	44/55	AG							↔ 19					
												03.00-12.02	44/55	GS	0986 475 905	↔ 19,05
	1.25 i 16V	11.95-02.00	55	D77,GS	F 026	002 502					↔ 17,5					
												11.95-12.02	55	AG	0986 475 776	↔ 19
												03.00-12.02	55	GS	0986 475 905	↔ 19,05
	1.3 i	11.95-12.02	37/44							1987 477 301	1627					
										1987 477 517	312					
	1.4 i 16V	01.96-12.00	66								1987 477 301	1627				
											1987 477 517	312				
	1.6 i 16V	02.00-12.02	76								1987 477 301	1627				
											1987 477 517	312				
	1.8 D	10.95-12.02	44/55								1987 477 301	1627				
	1.8 TD										1987 477 517	312				
	1.25 i 16V	11.95-12.02	55									1987 477 301	1627			
												1987 477 517	312			
	1.3 i	11.95-12.02	37/44							0986 594 023 <sup>3</sup>						
	1.4 i 16V	01.96-12.00	66							0986 594 023 <sup>3</sup>						
	1.6 i 16V	02.00-12.02	76							0986 594 023 <sup>3</sup>						
	1.8 D, TD	10.95-12.02	44/55							0986 594 023 <sup>3</sup>						
	1.25 i 16V	11.95-12.02	55							0986 594 023 <sup>3</sup>						
<b>Fiesta V [02]</b>																
	1.3 i	11.01-09.08	44/51							0986 473 275		← 54	1987 470 506 <sup>8</sup>			
										0986 474 275		→ 54	1987 470 506 <sup>8</sup>			
	1.4 i	11.01-09.08	50/56-59								0986 473 275		← 54	1987 470 506 <sup>8</sup>		
											0986 474 275		→ 54	1987 470 506 <sup>8</sup>		
	1.6 i	11.01-09.08	66/74								0986 473 275		← 54	1987 470 506 <sup>8</sup>		
1.6 TDCi										0986 474 275		→ 54	1987 470 506 <sup>8</sup>			

							
	<b>1.25 i</b>	12.02-09.08	51/55		0 986 473 275	 ← 54	1 987 470 506 <sup>B</sup>
					0 986 474 275	 → 54	1 987 470 506 <sup>B</sup>
	<b>2.0 i ST150</b>	11.04-09.08	110	BSR			1 987 470 506 <sup>B</sup>
		04.08-09.08	110	BSR			1 987 470 506 <sup>B</sup>
	<b>1.3 i</b>	11.01-09.08	44/51		0 986 475 926	 ↔ 19,05	
	<b>1.4 i, TDCi</b>	11.01-09.08	50/56-59		0 986 475 926	 ↔ 19,05	
	<b>1.6 i, TDCi</b>	11.01-09.08	66/74		0 986 475 926	 ↔ 19,05	
	<b>1.25 i</b>	12.02-09.08	51/55		0 986 475 926	 ↔ 19,05	
	<b>2.0 i ST150</b>	11.04-09.08	110	BSR	0 986 134 087	 ← 34	
					0 986 135 087	 → 34	
	<b>1.3 i</b>	11.01-09.08	44/51		1 987 477 906	 ↔ 175	
					1 987 482 132	300	
				MI	1 987 477 732	1445	
	<b>1.4 i</b>	11.01-09.08	50/56-59		1 987 477 906	 ↔ 175	
	<b>1.4 i</b>	11.01-09.08	50/56-59		1 987 482 132	300	
	<b>1.4 TDCi</b>			MI	1 987 477 732	1445	
	<b>1.4 TDCi</b>	11.01-09.08	50/56-59		1 987 477 906	 ↔ 175	
	<b>1.6 i</b>	11.01-09.08	66/74		1 987 477 906	 ↔ 175	
	<b>1.6 i</b>	11.01-09.08	66/74		1 987 482 132	300	
	<b>1.6 TDCi</b>			MI	1 987 477 732	1445	
	<b>1.6 TDCi</b>	11.04-09.08	66/74		1 987 477 906	 ↔ 175	
	<b>1.25 i</b>	12.02-09.08	51/55		1 987 477 906	 ↔ 175	
					1 987 482 132	300	
				MI	1 987 477 732	1445	
	<b>2.0 i ST150</b>	11.04-09.08	110		1 987 477 906	 ↔ 175	
					1 987 482 132	300	
	<b>1.3 i</b>	11.01-09.08	44/51		0 986 594 516 <sup>3</sup>		
	<b>1.4 i, TDCi</b>	11.01-09.08	50/56-59		0 986 594 516 <sup>3</sup>		
	<b>1.6 i, TDCi</b>	11.01-09.08	66/74		0 986 594 516 <sup>3</sup>		
	<b>1.25 i</b>	12.02-09.08	51/55		0 986 594 516 <sup>3</sup>		
	<b>2.0 i ST150</b>	11.04-09.08	110		0 986 594 516 <sup>3</sup>		
<b>Fiesta VI [08]</b>							
	<b>1.4 i, LPG, TDCi</b>	07.08-11.12	50/51/ 68-71		0 986 134 276	 ← 54	
					0 986 135 276	 → 54	
	<b>1.6 TDCi, TDCi ECOnetic, Ti-VCT, Ti-VCT Sport S</b>	07.08-11.12	55/66/70/ 88/99		0 986 134 276	 ← 54	
					0 986 135 276	 → 54	
	<b>1.25 i</b>	07.08-11.12	44/60		0 986 134 276	 ← 54	
					0 986 135 276	 → 54	
	<b>1.4 i, LPG, TDCi</b>	07.08-11.12	50/51/68-71		0 986 475 970	 ↔ 19	
	<b>1.6 TDCi, TDCi ECOnetic, Ti-VCT, Ti-VCT Sport S</b>	07.08-11.12	55/66/70/88/99		0 986 475 970	 ↔ 19	
	<b>1.25 i</b>	07.08-11.12	44/60		0 986 475 970	 ↔ 19	
	<b>1.4 i</b>	07.08-11.12	50/51/68-71		1 987 482 278	 ↔ 162	
	<b>1.4 i, LPG, TDCi</b>	07.08-11.12	50/51/ 68-71		1 987 482 240	1430	
				MI	1 987 482 453	1362	
	<b>1.4 LPG</b>	05.09-11.12	50/51/68-71		1 987 482 278	 ↔ 162	
	<b>1.4 TDCi</b>	07.08-11.12	50/51/68-71		1 987 482 278	 ↔ 162	



		S							
	◀ FORD Fiesta VI [08]								
	1.6 TDCi	07.08-11.12	55/66/70/88/99				1987 482 278	↔ 162	
	1.6 TDCi ECOnetic	02.12-11.12	55/66/70/88/99				1987 482 278	↔ 162	
	1.6 TDCi, TDCi ECOnetic, Ti-VCT, Ti-VCT Sport S	07.08-11.12	55/66/70/88/99		MI		1987 482 240	1430	
	1.6 Ti-VCT	07.08-11.12	55/66/70/88/99				1987 482 278	↔ 162	
	1.6 Ti-VCT Sport S	01.11-11.12	55/66/70/88/99				1987 482 278	↔ 162	
	1.25 i	07.08-11.12	44/60				1987 482 240	1430	
					MI		1987 482 278	↔ 162	
							1987 482 453	1362	
	1.4 i, LPG, TDCi	07.08-11.12	50/51/68-71				0 265 009 270 <sup>3</sup>		
							0 265 009 271 <sup>4</sup>		
	1.6 TDCi, TDCi ECOnetic, Ti-VCT, Ti-VCT Sport S	07.08-11.12	55/66/70/88/99				0 265 009 270 <sup>3</sup>		
							0 265 009 271 <sup>4</sup>		
	1.25 i	07.08-11.12	44/60				0 265 009 270 <sup>3</sup>		
							0 265 009 271 <sup>4</sup>		
Fiesta VII [13]									
	1.0 EcoBoost	11.12→	48/59/74/92/103				0986 134 276	👁️ ← 54	
	1.0 GDI		92/103				0986 135 276	👁️ → 54	
	1.4	11.12→	68-71				0986 134 276	👁️ ← 54	
							0986 135 276	👁️ → 54	
	1.5 TDCi	11.12→	55				0986 134 276	👁️ ← 54	
							0986 135 276	👁️ → 54	
	1.6 TDCi, TDCi ECOnetic, Ti-VCT	11.12→	70/77				0986 134 276	👁️ ← 54	
							0986 135 276	👁️ → 54	
	1.25	11.12→	44/60				0986 134 276	👁️ ← 54	
							0986 135 276	👁️ → 54	
	1.0 EcoBoost, GDI	11.12→	48/59/74/92/103				0986 475 970	↔ 19	
	1.4	11.12→	68-71				0986 475 970	↔ 19	
	1.5 TDCi	11.12→	55				0986 475 970	↔ 19	
	1.6 TDCi, TDCi ECOnetic, Ti-VCT	11.12→	70/77				0986 475 970	↔ 19	
	1.25	11.12→	44/60				0986 475 970	↔ 19	
	1.0 EcoBoost, GDI	11.12→	48/59/74/92/103		MI		1987 482 453	1362	
	1.4	11.12→	68-71		MI		1987 482 453	1362	
	1.5 TDCi	11.12→	55		MI		1987 482 453	1362	
	1.6 TDCi, TDCi ECOnetic, Ti-VCT	11.12→	70/77		MI		1987 482 453	1362	
	1.25	11.12→	44/60		MI		1987 482 453	1362	
	1.0 EcoBoost	11.12→	48/59/74/92/103		GSO		0 265 009 271 <sup>4</sup>		
	1.0 GDI		92/103		TW		0 265 009 270 <sup>3</sup>		
		02.13→	48/59/74/92/103		TW		0 265 009 534 <sup>3</sup>		
	1.4	11.12→	68-71		GSO		0 265 009 271 <sup>4</sup>		
					TW		0 265 009 270 <sup>3</sup>		
		02.13→	68-71		TW		0 265 009 534 <sup>3</sup>		
	1.5 TDCi	11.12→	55		GSO		0 265 009 271 <sup>4</sup>		
					TW		0 265 009 270 <sup>3</sup>		
		02.13→	55		TW		0 265 009 534 <sup>3</sup>		
	1.6 EcoBoost	01.13→	134		TW		0 265 009 270 <sup>3</sup>		
		02.13→	134		TW		0 265 009 534 <sup>3</sup>		
	1.6 TDCi	11.12→	70/77		GSO		0 265 009 271 <sup>4</sup>		
	1.6 TDCi ECOnetic				TW		0 265 009 270 <sup>3</sup>		
	1.6 Ti-VCT	02.13→	70/77		TW		0 265 009 534 <sup>3</sup>		

		S							
1.25		11.12→	44/60			GSO	0 265 009 271 <sup>4</sup>		
						TW	0 265 009 270 <sup>3</sup>		
		02.13→	44/60			TW	0 265 009 534 <sup>3</sup>		

**Focus C-MAX [04]**

	1.6, TDCi, Ti-VCT	06.03-03.07	66/74/80/ 85				0 986 473 385	← 56,95	1 987 470 506 <sup>B</sup>
							0 986 474 385	→ 56,95	1 987 470 506 <sup>B</sup>
	1.8, FFV, TDCi	06.03-03.07	85/88/ 90-92				0 986 473 385	← 56,95	1 987 470 506 <sup>B</sup>
							0 986 474 385	→ 56,95	1 987 470 506 <sup>B</sup>
	2.0, CNG, TDCi	06.03-03.07	93-107				0 986 473 385	← 56,95	1 987 470 506 <sup>B</sup>
							0 986 474 385	→ 56,95	1 987 470 506 <sup>B</sup>

	1.6, TDCi, Ti-VCT	06.03-03.07	66/74/80/ 85				0 986 473 173	← 37,93	1 987 470 506 <sup>B</sup>
							0 986 474 173	→ 37,93	1 987 470 506 <sup>B</sup>
	1.8, FFV, TDCi	06.03-03.07	85/88/ 90-92				0 986 473 173	← 37,93	1 987 470 506 <sup>B</sup>
							0 986 474 173	→ 37,93	1 987 470 506 <sup>B</sup>
	2.0, CNG, TDCi	06.03-03.07	93-107				0 986 473 173	← 37,93	1 987 470 506 <sup>B</sup>
							0 986 474 173	→ 37,93	1 987 470 506 <sup>B</sup>

	1.6, TDCi, Ti-VCT	06.03-03.07	66/74/80/85		FEB		1 987 477 216		1830
		12.05-03.07	66/74/80/85				1 987 482 188		337
	1.8	06.03-05.04	88		FEB		1 987 477 216		1830
	1.8	04.04-03.07	90-92		FEB		1 987 477 216		1830
	1.8 FFV	12.05-03.07	90-92				1 987 482 188		337
	1.8 TDCi	04.05-03.07	85		FEB		1 987 477 216		1830
		12.05-03.07	85				1 987 482 188		337
	2.0, CNG, TDCi	06.03-03.07	93-107		FEB		1 987 477 216		1830
		12.05-03.07	93-107				1 987 482 188		337

	1.6	06.03-04.05	66/74/80/85				0 986 594 555 <sup>3</sup>		
	1.6 TDCi	06.03-03.07	66/74/80/85				0 986 594 554 <sup>4</sup>		
	1.6 Ti-VCT	05.05-03.07	66/74/80/85				0 986 594 556 <sup>3</sup>		
	1.8	06.03-05.04	88				0 986 594 554 <sup>4</sup>		
		04.04-04.05	90-92				0 986 594 555 <sup>3</sup>		
		04.04-03.07	90-92				0 986 594 554 <sup>4</sup>		
		05.05-03.07	90-92				0 986 594 556 <sup>3</sup>		
	1.8 FFV	05.05-03.07	92				0 986 594 554 <sup>4</sup>		
							0 986 594 556 <sup>3</sup>		
	1.8 TDCi	04.05-04.05	85				0 986 594 555 <sup>3</sup>		
		04.05-03.07	85				0 986 594 554 <sup>4</sup>		
		05.05-03.07	85				0 986 594 556 <sup>3</sup>		
	2.0	06.03-04.05	98-100/107				0 986 594 555 <sup>3</sup>		
	2.0 TDCi	06.03-03.07	98-100/107				0 986 594 554 <sup>4</sup>		
		05.05-03.07	98-100/107				0 986 594 556 <sup>3</sup>		
	2.0 CNG	11.05-03.07	93-107				0 986 594 554 <sup>4</sup>		
							0 986 594 556 <sup>3</sup>		

**Focus ECO IV [15]**

	1.0 EcoBoost	10.14→	74				0 986 473 385	← 56,95	1 987 470 506 <sup>B</sup>
							0 986 474 385	→ 56,95	1 987 470 506 <sup>B</sup>





		S				?			
◀ FORD Focus ECO IV [15]									
	1.0 EcoBoost	10.14→	74				0986 475 989	↔ 20,6	
	1.0 EcoBoost	10.14→	74		HTB		1987 482 370	↔ 230	
<b>Focus [Fase I]</b>									
	1.6 i8V	09.03→	75						1987 470 006 <sup>7</sup>
	1.8 i16V	09.00-07.04	85						1987 470 006 <sup>7</sup>
	2.0 i16V	07.00-05.05	96-97						1987 470 006 <sup>7</sup>
	1.6 i8V	09.03→	75				F 026 002 581	↔ 20,64	
	1.8 i16V	09.00-07.04	85		STB		F 026 002 581	↔ 20,64	
	2.0 i16V	07.00-05.05	96-97		STB		F 026 002 581	↔ 20,64	
	1.8 i16V	09.00-07.04	85				0986 473 080	← 33,9	
							0986 474 080	→ 33,9	
	2.0 i16V	07.00-05.05	96-97				0986 473 080	← 33,9	
							0986 474 080	→ 33,9	
<b>Focus [Fase II]</b>									
	2.0 i16V	10.08→	107				0986 473 385	← 56,95	
							0986 474 385	→ 56,95	
	2.0 i16V	10.08→	107				1987 482 189	1860	
<b>Focus [GA]</b>									
	2.0 i	10.98-01.02	96				0986 473 079	← 53,94	1987 470 006 <sup>7</sup>
							0986 473 079	← 53,94	1987 470 506 <sup>8</sup>
							0986 473 079	← 53,94	
							0986 474 079	→ 53,94	1987 470 006 <sup>7</sup>
							0986 474 079	→ 53,94	
	2.0 i	10.98-01.02	96				0986 473 080	← 33,9	
							0986 474 080	→ 33,9	
	2.0 i	10.98-01.02	96				0986 594 518 <sup>3</sup>		
<b>Focus I Turnier [99]</b>									
	1.4 i	11.98-05.05	55				0986 473 079	← 53,94	1987 470 006 <sup>7</sup>
							0986 473 079	← 53,94	1987 470 506 <sup>8</sup>
							0986 474 079	→ 53,94	1987 470 006 <sup>7</sup>



		S							
<b>1.6i</b>		11.98-05.05	72/74-77				0 986 473 079	← 53,94	1 987 470 006 <sup>7</sup>
<b>1.6i</b> FFV							0 986 473 079	← 53,94	1 987 470 506 <sup>8</sup>
							0 986 474 079	→ 53,94	1 987 470 006 <sup>7</sup>
<b>1.8i</b>		11.98-05.05	55/66/74/				0 986 473 079	← 53,94	1 987 470 006 <sup>7</sup>
<b>1.8</b> TDCi			85				0 986 473 079	← 53,94	1 987 470 506 <sup>8</sup>
<b>1.8</b> TDDi							0 986 474 079	→ 53,94	1 987 470 006 <sup>7</sup>
<b>2.0i</b>		11.98-05.05	96				0 986 473 079	← 53,94	1 987 470 006 <sup>7</sup>
							0 986 473 079	← 53,94	1 987 470 506 <sup>8</sup>
							0 986 474 079	→ 53,94	1 987 470 006 <sup>7</sup>
	<b>1.4i</b>	10.00-05.05	55				0 986 475 739	↔ 22,2	
	<b>1.6i</b>	11.98-05.05	72/74-77	AG			F 026 002 581	↔ 20,64	
	<b>1.6i</b> FFV	10.00-05.05	72/74-77	GS			0 986 475 739	↔ 22,2	
	<b>1.8i</b> , TDCi, TDDi	11.98-05.05	55/66/74/85				F 026 002 581	↔ 20,64	
	<b>2.0i</b>	11.98-05.05	96				F 026 002 581	↔ 20,64	
	<b>1.4i</b>	11.98-05.05	55				0 986 473 080	← 33,9	
							0 986 474 080	→ 33,9	
	<b>1.6i</b>	11.98-05.05	72/74-77				0 986 473 080	← 33,9	
	<b>1.6i</b> FFV						0 986 474 080	→ 33,9	
	<b>1.8i</b> , TDCi, TDDi	11.98-05.05	55/66/74/				0 986 473 080	← 33,9	
			85				0 986 474 080	→ 33,9	
	<b>2.0i</b>	11.98-05.05	96/127				0 986 473 080	← 33,9	
	<b>2.0i</b> ST170						0 986 474 080	→ 33,9	
	<b>1.4i</b>	11.98-09.01	55				1 987 477 929	326	
				MI,STB			1 987 477 930	1480	
				4SB,MI			1 987 477 931	1770	
		11.98-05.05	55				1 987 477 906	175	
		10.01-05.05	55				1 987 482 121	330	
				MI,STB			1 987 477 932	1483	
				4SB,MI			1 987 477 933	1770	
	<b>1.6i</b>	11.98-09.01	74				1 987 477 929	326	
				MI,STB			1 987 477 930	1480	
				4SB,MI			1 987 477 931	1770	
		11.98-05.05	74				1 987 477 906	175	
		10.01-05.05	74				1 987 482 121	330	
				MI,STB			1 987 477 932	1483	
				4SB,MI			1 987 477 933	1770	
		09.02-05.05	72				1 987 477 906	175	
							1 987 482 121	330	
				MI,STB			1 987 477 932	1483	
				4SB,MI			1 987 477 933	1770	
	<b>1.6i</b> FFV	10.01-05.05	74-77				1 987 477 906	175	
							1 987 482 121	330	
				MI,STB			1 987 477 932	1483	
				4SB,MI			1 987 477 933	1770	
	<b>1.8i</b>	11.98-09.01	85				1 987 477 929	326	
	<b>1.8i</b>	11.98-09.01	85	4SB,MI			1 987 477 931	1770	
	<b>1.8</b> TDCi	11.98-05.05	85				1 987 477 906	175	
		10.01-05.05	85				1 987 482 121	330	
				MI,STB			1 987 477 932	1483	
				4SB,MI			1 987 477 933	1770	
	<b>1.8</b> TDCi	05.01-09.01	85				1 987 477 929	326	
				MI,STB			1 987 477 930	1480	
		08.02-05.05	74				1 987 477 906	175	
							1 987 482 121	330	
				MI,STB			1 987 477 932	1483	
				4SB,MI			1 987 477 933	1770	























	◀ FORD Focus I Turnier [99]			
1.8 TDDi	01.99-09.01	55/66	1987 477 929	326
			MI,STB	1987 477 930
			4SB,MI	1987 477 931
	01.99-05.05	55/66	1987 477 906	175
	10.01-05.05	55/66	1987 482 121	330
			MI,STB	1987 477 932
			4SB,MI	1987 477 933
2.0 i	11.98-09.01	96	1987 477 929	326
			MI,STB	1987 477 930
			4SB,MI	1987 477 931
	11.98-05.05	96	1987 477 906	175
	10.01-05.05	96	1987 482 121	330
			MI,STB	1987 477 932
			4SB,MI	1987 477 933
2.0 iST170	02.02-05.05	127	1987 477 906	175
			1987 482 121	330

	1.4 i	11.98-05.05	55	0986 594 518 <sup>3</sup>	
				LAB,TBR	0986 594 515 <sup>4</sup>
				RAB,TBR	0986 594 517 <sup>4</sup>
				SBR	0986 594 515 <sup>4</sup>
	1.6 i	11.98-05.05	72/74-77	0986 594 518 <sup>3</sup>	
	1.6 iFFV			LAB,TBR	0986 594 515 <sup>4</sup>
				RAB,TBR	0986 594 517 <sup>4</sup>
				SBR	0986 594 515 <sup>4</sup>
	1.8 i	11.98-05.05	55/66/74/	0986 594 518 <sup>3</sup>	
	1.8 TDCi		85	LAB,TBR	0986 594 515 <sup>4</sup>
	1.8 TDDi			RAB,TBR	0986 594 517 <sup>4</sup>
				SBR	0986 594 515 <sup>4</sup>
	2.0 i	11.98-05.05	96	0986 594 518 <sup>3</sup>	
				LAB,TBR	0986 594 515 <sup>4</sup>
				RAB,TBR	0986 594 517 <sup>4</sup>
				SBR	0986 594 515 <sup>4</sup>
	2.0 iST170	02.02-05.05	127	0986 594 515 <sup>4</sup>	
				0986 594 518 <sup>3</sup>	

**Focus I [99]**

	1.4 i	08.98-05.05	55	0986 473 079	← 53,94	1987 470 006 <sup>7</sup>
				0986 473 079	← 53,94	1987 470 506 <sup>8</sup>
				0986 474 079	→ 53,94	1987 470 006 <sup>7</sup>
	1.6 i	08.98-05.05	72/74-77	0986 473 079	← 53,94	1987 470 006 <sup>7</sup>
	1.6 iFFV			0986 473 079	← 53,94	1987 470 506 <sup>8</sup>
				0986 474 079	→ 53,94	1987 470 006 <sup>7</sup>
	1.8 i	08.98-05.05	55/66/74/	0986 473 079	← 53,94	1987 470 006 <sup>7</sup>
	1.8 TDCi		85	0986 473 079	← 53,94	1987 470 506 <sup>8</sup>
	1.8 TDDi			0986 474 079	→ 53,94	1987 470 006 <sup>7</sup>
	2.0 i	08.98-05.05	96	0986 473 079	← 53,94	1987 470 006 <sup>7</sup>
				0986 473 079	← 53,94	1987 470 506 <sup>8</sup>
				0986 474 079	→ 53,94	1987 470 006 <sup>7</sup>

	1.4 i	08.98-05.05	55	F 026 002 581	↔ 20,64
	1.6 i, iFFV	08.98-05.05	72/74-77	F 026 002 581	↔ 20,64
	1.8 i	08.98-05.05	85	F 026 002 581	↔ 20,64
	1.8 TDCi	05.01-05.05	85	0986 475 776	↔ 19
	1.8 TDCi, TDDi	10.00-05.05	55/66/74	0986 475 776	↔ 19
	2.0 i	08.98-05.05	96	F 026 002 581	↔ 20,64

		<b>S</b>							
	<b>1.4i</b>	08.98-05.05	55				0 986 <b>473 080</b>	 ← 33,9	
							0 986 <b>474 080</b>	 → 33,9	
	<b>1.6i</b>	08.98-05.05	72/74-77				0 986 <b>473 080</b>	 ← 33,9	
	<b>1.6i</b> FFV						0 986 <b>474 080</b>	 → 33,9	
	<b>1.8i</b> , TDCi, TDDi	08.98-05.05	55/66/74/85				0 986 <b>473 080</b>	 ← 33,9	
							0 986 <b>474 080</b>	 → 33,9	
	<b>2.0i</b> , iRS, iST170	08.98-05.05	96/127/158				0 986 <b>473 080</b>	 ← 33,9	
							0 986 <b>474 080</b>	 → 33,9	
	<b>1.4i</b>	08.98-09.01	55				1 987 <b>477 929</b>	326	
							MI,STB	1 987 <b>477 930</b>	1480
							4SB,MI	1 987 <b>477 931</b>	1770
		08.98-05.05	55				1 987 <b>477 906</b>	175	
		10.01-05.05	55				1 987 <b>482 121</b>	330	
							MI,STB	1 987 <b>477 932</b>	1483
							4SB,MI	1 987 <b>477 933</b>	1770
	<b>1.6i</b>	08.98-09.01	74				1 987 <b>477 929</b>	326	
							MI,STB	1 987 <b>477 930</b>	1480
							4SB,MI	1 987 <b>477 931</b>	1770
		08.98-05.05	74				1 987 <b>477 906</b>	175	
		10.01-05.05	74				1 987 <b>482 121</b>	330	
							MI,STB	1 987 <b>477 932</b>	1483
							4SB,MI	1 987 <b>477 933</b>	1770
		09.02-05.05	72				1 987 <b>477 906</b>	175	
							1 987 <b>482 121</b>	330	
							MI,STB	1 987 <b>477 932</b>	1483
							4SB,MI	1 987 <b>477 933</b>	1770
	<b>1.6i</b> FFV	10.01-05.05	74-77				1 987 <b>477 906</b>	175	
							1 987 <b>482 121</b>	330	
							MI,STB	1 987 <b>477 932</b>	1483
							4SB,MI	1 987 <b>477 933</b>	1770
	<b>1.8i</b>	08.98-09.01	85				1 987 <b>477 929</b>	326	
	<b>1.8i</b> TDCi						MI,STB	1 987 <b>477 930</b>	1480
							4SB,MI	1 987 <b>477 931</b>	1770
		08.98-05.05	85				1 987 <b>477 906</b>	175	
		10.01-05.05	85				1 987 <b>482 121</b>	330	
							MI,STB	1 987 <b>477 932</b>	1483
							4SB,MI	1 987 <b>477 933</b>	1770
	<b>1.8i</b> TDCi	08.02-05.05	74				1 987 <b>477 906</b>	175	
						1 987 <b>482 121</b>	330		
						MI,STB	1 987 <b>477 932</b>	1483	
						4SB,MI	1 987 <b>477 933</b>	1770	
<b>1.8i</b> TDDi	01.99-09.01	55/66				1 987 <b>477 929</b>	326		
						MI,STB	1 987 <b>477 930</b>	1480	
						4SB,MI	1 987 <b>477 931</b>	1770	
	01.99-05.05	55/66				1 987 <b>477 906</b>	175		
	10.01-05.05	55/66				1 987 <b>482 121</b>	330		
						MI,STB	1 987 <b>477 932</b>	1483	
						4SB,MI	1 987 <b>477 933</b>	1770	
<b>2.0i</b>	08.98-09.01	96				1 987 <b>477 929</b>	326		
						MI,STB	1 987 <b>477 930</b>	1480	
						4SB,MI	1 987 <b>477 931</b>	1770	
	08.98-05.05	96				1 987 <b>477 906</b>	175		
	10.01-05.05	96				1 987 <b>482 121</b>	330		
						MI,STB	1 987 <b>477 932</b>	1483	
						4SB,MI	1 987 <b>477 933</b>	1770	
<b>2.0i</b> RS	02.02-05.05	127/158				1 987 <b>477 906</b>	175		
<b>2.0i</b> ST170						1 987 <b>482 121</b>	330		





◀ FORD Focus I [99]















	1.4 i	08.98-05.05	55		0 986 594 518 <sup>3</sup>		
				LAB,TBR	0 986 594 515 <sup>4</sup>		
				RAB,TBR	0 986 594 517 <sup>4</sup>		
				SBR	0 986 594 515 <sup>4</sup>		
	1.6 i	08.98-05.05	72/74-77		0 986 594 518 <sup>3</sup>		
	1.6 i FFV			LAB,TBR	0 986 594 515 <sup>4</sup>		
				RAB,TBR	0 986 594 517 <sup>4</sup>		
				SBR	0 986 594 515 <sup>4</sup>		
	1.8 i	08.98-05.05	55/66/74/		0 986 594 518 <sup>3</sup>		
	1.8 TDCi		85	LAB,TBR	0 986 594 515 <sup>4</sup>		
	1.8 TDDi			RAB,TBR	0 986 594 517 <sup>4</sup>		
				SBR	0 986 594 515 <sup>4</sup>		
	2.0 i	08.98-05.05	96		0 986 594 518 <sup>3</sup>		
				LAB,TBR	0 986 594 515 <sup>4</sup>		
				RAB,TBR	0 986 594 517 <sup>4</sup>		
				SBR	0 986 594 515 <sup>4</sup>		
	2.0 i RS	02.02-05.05	127/158		0 986 594 515 <sup>4</sup>		
	2.0 i ST170				0 986 594 518 <sup>3</sup>		

Focus II Cabriolet [06]

	1.6 i	07.06-07.10	74		0 986 473 385	56,95	1 987 470 506 <sup>8</sup>
					0 986 474 385	56,95	1 987 470 506 <sup>8</sup>
	2.0 i	07.06-07.10	100/107		0 986 473 385	56,95	1 987 470 506 <sup>8</sup>
	2.0 TDCi				0 986 474 385	56,95	1 987 470 506 <sup>8</sup>
	1.6 i	07.06-07.10	74		0 986 473 173	37,93	1 987 470 506 <sup>8</sup>
					0 986 474 173	37,93	1 987 470 506 <sup>8</sup>
	2.0 i	07.06-07.10	100/107		0 986 473 173	37,93	1 987 470 506 <sup>8</sup>
	2.0 TDCi				0 986 474 173	37,93	1 987 470 506 <sup>8</sup>
	1.6 i	07.06-07.10	74		1 987 477 216		1830
					1 987 482 188		337
	2.0 i	07.06-07.10	100/107		1 987 477 216		1830
	2.0 TDCi				1 987 482 188		337
	1.6 i	07.06-07.10	74		0 986 594 554 <sup>4</sup>		
		MFD 07.06-07.10	74		0 986 594 556 <sup>3</sup>		
		OFD 07.06-07.10	74		0 986 594 555 <sup>3</sup>		
	2.0 i	07.06-07.10	100/107		0 986 594 554 <sup>4</sup>		
	2.0 TDCi	MFD 07.06-07.10	100/107		0 986 594 556 <sup>3</sup>		
		OFD 07.06-07.10	100/107		0 986 594 555 <sup>3</sup>		















Focus II Turnier [04]

	1.4 i	07.04-01.08	59		0 986 473 385	56,95	1 987 470 506 <sup>8</sup>
					0 986 474 385	56,95	1 987 470 506 <sup>8</sup>
	1.6 i, TDCi, Ti-VCT	07.04-01.08	66/74-80/		0 986 473 385	56,95	1 987 470 506 <sup>8</sup>
			85		0 986 474 385	56,95	1 987 470 506 <sup>8</sup>
1.8 FFV, i, TDCi	04.05-01.08	85/92		0 986 473 385	56,95	1 987 470 506 <sup>8</sup>	
					0 986 474 385	56,95	1 987 470 506 <sup>8</sup>
2.0 i	07.04-01.08	98-100/		0 986 473 385	56,95	1 987 470 506 <sup>8</sup>	
2.0 TDCi		107		0 986 474 385	56,95	1 987 470 506 <sup>8</sup>	

		S							
									
	1.4i	07.04-01.08	59				0 986 475 927	↔ 20,64	
	1.6i, TDCi, Ti-VCT	07.04-01.08	66/74-80/85				0 986 475 927	↔ 20,64	
	1.8 FFV, i, TDCi	04.05-01.08	85/92				0 986 475 927	↔ 20,64	
	1.4i	07.04-12.07	59				0 986 474 173	👁️ → 37,93	1 987 470 506 <sup>B</sup>
		07.04-01.08	59				0 986 473 173	👁️ ← 37,93	1 987 470 506 <sup>B</sup>
	1.6i	07.04-12.07	74				0 986 474 173	👁️ → 37,93	1 987 470 506 <sup>B</sup>
		07.04-01.08	74				0 986 473 173	👁️ ← 37,93	1 987 470 506 <sup>B</sup>
	1.6 TDCi	07.04-12.07	66				0 986 474 173	👁️ → 37,93	1 987 470 506 <sup>B</sup>
			74-80				0 986 474 173	👁️ → 37,93	1 987 470 506 <sup>B</sup>
		07.04-01.08	66				0 986 473 173	👁️ ← 37,93	1 987 470 506 <sup>B</sup>
			74-80				0 986 473 173	👁️ ← 37,93	1 987 470 506 <sup>B</sup>
	1.6 Ti-VCT	07.04-12.07	85				0 986 474 173	👁️ → 37,93	1 987 470 506 <sup>B</sup>
		07.04-01.08	85				0 986 473 173	👁️ ← 37,93	1 987 470 506 <sup>B</sup>
	1.8 FFV	05.05-01.08	92				0 986 473 173	👁️ ← 37,93	1 987 470 506 <sup>B</sup>
	1.8 FFV, i	05.05-12.07	92				0 986 474 173	👁️ → 37,93	1 987 470 506 <sup>B</sup>
	1.8i	05.05-01.08	92				0 986 473 173	👁️ ← 37,93	1 987 470 506 <sup>B</sup>
	1.8 TDCi	04.05-12.07	85				0 986 474 173	👁️ → 37,93	1 987 470 506 <sup>B</sup>
		04.05-01.08	85				0 986 473 173	👁️ ← 37,93	1 987 470 506 <sup>B</sup>
	2.0i	07.04-12.07	107				0 986 474 173	👁️ → 37,93	1 987 470 506 <sup>B</sup>
		07.04-01.08	107				0 986 473 173	👁️ ← 37,93	1 987 470 506 <sup>B</sup>
	2.0 TDCi	07.04-12.07	98-100				0 986 474 173	👁️ → 37,93	1 987 470 506 <sup>B</sup>
		07.04-01.08	98-100				0 986 473 173	👁️ ← 37,93	1 987 470 506 <sup>B</sup>
									
	1.4i	07.04-03.07	59		SBR		1 987 477 216	1830	
		07.04-01.08	59		HTB		1 987 482 122	↔ 228	
					HTB,MI		1 987 477 222	1450	
		12.05-01.08	59				1 987 482 188	337	
		04.07-01.08	59		SBR		1 987 482 189	1860	
	1.6i	07.04-01.08	66/74-80/85		HTB		1 987 482 122	↔ 228	
	1.6i	07.04-03.07	66/74-80/85		SBR		1 987 477 216	1830	
	1.6 TDCi	07.04-01.08	66/74-80/85		HTB,MI		1 987 477 222	1450	
	1.6 Ti-VCT	12.05-01.08	66/74-80/85				1 987 482 188	337	
		04.07-01.08	66/74-80/85		SBR		1 987 482 189	1860	
	1.6 TDCi	07.04-01.08	66/74-80/85		HTB		1 987 482 122	↔ 228	
	1.6 Ti-VCT	07.04-01.08	66/74-80/85		HTB		1 987 482 122	↔ 228	
	1.8 FFV	05.05-01.08	85/92		HTB		1 987 482 122	↔ 228	
	1.8 FFV	04.05-03.07	85/92		SBR		1 987 477 216	1830	
	1.8i	04.05-01.08	85/92		HTB,MI		1 987 477 222	1450	
	1.8 TDCi	12.05-01.08	85/92				1 987 482 188	337	
		04.07-01.08	85/92		SBR		1 987 482 189	1860	
	1.8i	05.05-01.08	85/92		HTB		1 987 482 122	↔ 228	
	1.8 TDCi	04.05-01.08	85/92		HTB		1 987 482 122	↔ 228	
	2.0i	07.04-03.07	98-100/107				1 987 477 216	1830	
	2.0 TDCi	12.05-01.08	98-100/107				1 987 482 188	337	
		04.07-01.08	98-100/107				1 987 482 189	1860	
	1.4i	07.04-01.08	59				0 986 594 554 <sup>4</sup>		
		MFD 11.04-01.08	59				0 986 594 556 <sup>3</sup>		
		OFD 07.04-01.08	59				0 986 594 555 <sup>3</sup>		
	1.6i	07.04-01.08	66/74-80/85				0 986 594 554 <sup>4</sup>		
	1.6 TDCi	MFD 11.04-01.08	66/74-80/85				0 986 594 556 <sup>3</sup>		
	1.6 Ti-VCT	OFD 07.04-01.08	66/74-80/85				0 986 594 555 <sup>3</sup>		
	1.8 FFV	04.05-01.08	85/92				0 986 594 554 <sup>4</sup>		
	1.8i	MFD 04.05-01.08	85/92				0 986 594 556 <sup>3</sup>		
	1.8 TDCi	OFD 04.05-01.08	85/92				0 986 594 555 <sup>3</sup>		
	2.0i	07.04-01.08	98-100/107				0 986 594 554 <sup>4</sup>		
	2.0 TDCi	MFD 11.04-01.08	98-100/107				0 986 594 556 <sup>3</sup>		
		OFD 07.04-01.08	98-100/107				0 986 594 555 <sup>3</sup>		



			S							
◀ FORD										
Focus II Turnier [08]										
	1.4 i	12.07-12.11	59					0986 473 385		◀ 56,95 1987 470 506 <sup>8</sup>
								0986 474 385		→ 56,95 1987 470 506 <sup>8</sup>
	1.6 i, TDCi, Ti-VCT	12.07-12.11	66/74-80/ 85-88					0986 473 385		◀ 56,95 1987 470 506 <sup>8</sup>
								0986 474 385		→ 56,95 1987 470 506 <sup>8</sup>
	1.8 Flexifuel, i, TDCi	12.07-12.11	85/92					0986 473 385		◀ 56,95 1987 470 506 <sup>8</sup>
								0986 474 385		→ 56,95 1987 470 506 <sup>8</sup>
	2.0 i, LPG, TDCi	12.07-12.11	81/100/ 104-107					0986 473 385		◀ 56,95 1987 470 506 <sup>8</sup>
								0986 474 385		→ 56,95 1987 470 506 <sup>8</sup>
	1.4 i	12.07-12.11	59					0986 475 927		↔ 20,64
	1.6 i, TDCi, Ti-VCT	12.07-12.11	66/74-80/85-88					0986 475 927		↔ 20,64
	1.8 Flexifuel, i, TDCi	12.07-12.11	85/92					0986 475 927		↔ 20,64
	2.0 i, LPG, TDCi	12.07-12.11	81/100/104-107					0986 475 927		↔ 20,64
	1.4 i	12.07-12.11	59					0986 473 173		◀ 37,93
								0986 474 173		→ 37,93
	1.6 i, TDCi, Ti-VCT	12.07-12.11	66/74-80/ 85-88					0986 473 173		◀ 37,93
								0986 474 173		→ 37,93
	1.8 Flexifuel, i, TDCi	12.07-12.11	85/92					0986 473 173		◀ 37,93
								0986 474 173		→ 37,93
	2.0 i, LPG, TDCi	12.07-12.11	81/100/ 104-107					0986 473 173		◀ 37,93
								0986 474 173		→ 37,93
	1.4 i	12.07-07.10	59			4SB		1987 482 189		1860
		12.07-12.11	59					1987 482 188		337
						HTB		1987 482 122		↔ 228
						HTB,MI		1987 477 222		1450
	1.6 i	12.07-12.11	66/74-80/85-88			HTB		1987 482 122		↔ 228
	1.6 i	12.07-07.10	66/74-80/85-88			4SB		1987 482 189		1860
	1.6 TDCi	12.07-12.11	66/74-80/ 85-88					1987 482 188		337
	1.6 Ti-VCT		85-88			HTB,MI		1987 477 222		1450
	1.6 TDCi	12.07-12.11	66/74-80/85-88			HTB		1987 482 122		↔ 228
	1.6 Ti-VCT	12.07-12.11	66/74-80/85-88			HTB		1987 482 122		↔ 228
	1.8 Flexifuel	12.07-12.11	85/92			HTB		1987 482 122		↔ 228
	1.8 Flexifuel	12.07-07.10	85/92			4SB		1987 482 189		1860
	1.8 i	12.07-12.11	85/92					1987 482 188		337
	1.8 TDCi					HTB,MI		1987 477 222		1450
	1.8 i	12.07-12.11	85/92			HTB		1987 482 122		↔ 228
	1.8 TDCi	12.07-12.11	85/92			HTB		1987 482 122		↔ 228
	2.0 i	12.07-12.11	81/100/104-107			HTB		1987 482 122		↔ 228
	2.0 i	12.07-07.10	81/100/104-107			4SB		1987 482 189		1860
	2.0 LPG	12.07-12.11	81/100/ 104-107					1987 482 188		337
	2.0 TDCi					HTB,MI		1987 477 222		1450
	2.0 LPG	01.08-12.11	81/100/104-107			HTB		1987 482 122		↔ 228
	2.0 TDCi	12.07-12.11	81/100/104-107			HTB		1987 482 122		↔ 228
	1.4 i	12.07-12.11	59					0986 594 554 <sup>4</sup>		
		MFD 12.07-12.11	59					0986 594 556 <sup>3</sup>		
		OFD 12.07-11.10	59					0986 594 555 <sup>3</sup>		
	1.6 i	12.07-12.11	66/74-80/85-88					0986 594 554 <sup>4</sup>		
	1.6 TDCi	MFD 12.07-12.11	66/74-80/85-88					0986 594 556 <sup>3</sup>		
	1.6 Ti-VCT	OFD 12.07-11.10	66/74-80/85-88					0986 594 555 <sup>3</sup>		
	1.8 Flexifuel	12.07-12.11	85/92					0986 594 554 <sup>4</sup>		
	1.8 i	MFD 12.07-12.11	85/92					0986 594 556 <sup>3</sup>		
	1.8 TDCi	OFD 12.07-11.10	85/92					0986 594 555 <sup>3</sup>		

								
2.0i								
2.0 LPG	MFD							
2.0 TDCi	OFD							
<b>Focus II [04]</b>								
								
	1.4i	07.04-01.08	59			0 986 473 385	↔ 56,95	1 987 470 506 <sup>B</sup>
						0 986 474 385	↔ 56,95	1 987 470 506 <sup>B</sup>
	1.6i, TDCi, Ti-VCT	07.04-01.08	66/74-80/ 85			0 986 473 385	↔ 56,95	1 987 470 506 <sup>B</sup>
						0 986 474 385	↔ 56,95	1 987 470 506 <sup>B</sup>
	1.8 FFV, i, TDCi	07.04-01.08	85/92			0 986 473 385	↔ 56,95	1 987 470 506 <sup>B</sup>
						0 986 474 385	↔ 56,95	1 987 470 506 <sup>B</sup>
	2.0i	07.04-01.08	98-100/ 107			0 986 473 385	↔ 56,95	1 987 470 506 <sup>B</sup>
	2.0 TDCi					0 986 474 385	↔ 56,95	1 987 470 506 <sup>B</sup>
	2.5i ST	10.05-01.08	166					1 987 470 506 <sup>B</sup>
								
	1.4i	07.04-01.08	59			0 986 475 927	↔ 20,64	
	1.6i, TDCi, Ti-VCT	07.04-01.08	66/74-80/85			0 986 475 927	↔ 20,64	
	1.8 FFV, i, TDCi	07.04-01.08	85/92			0 986 475 927	↔ 20,64	
	1.4i	07.04-12.07	59			0 986 474 173	↔ 37,93	1 987 470 506 <sup>B</sup>
		07.04-01.08	59			0 986 473 173	↔ 37,93	1 987 470 506 <sup>B</sup>
	1.6i	07.04-12.07	74			0 986 474 173	↔ 37,93	1 987 470 506 <sup>B</sup>
		07.04-01.08	74			0 986 473 173	↔ 37,93	1 987 470 506 <sup>B</sup>
	1.6 TDCi	07.04-12.07	66			0 986 474 173	↔ 37,93	1 987 470 506 <sup>B</sup>
			74-80			0 986 474 173	↔ 37,93	1 987 470 506 <sup>B</sup>
			80			0 986 474 173	↔ 37,93	1 987 470 506 <sup>B</sup>
		07.04-01.08	66			0 986 473 173	↔ 37,93	1 987 470 506 <sup>B</sup>
			74-80			0 986 473 173	↔ 37,93	1 987 470 506 <sup>B</sup>
			80			0 986 473 173	↔ 37,93	1 987 470 506 <sup>B</sup>
	1.6 Ti-VCT	07.04-12.07	85			0 986 474 173	↔ 37,93	1 987 470 506 <sup>B</sup>
		07.04-01.08	85			0 986 473 173	↔ 37,93	1 987 470 506 <sup>B</sup>
	1.8 FFV	07.04-01.08	92			0 986 473 173	↔ 37,93	1 987 470 506 <sup>B</sup>
	1.8 FFV, i	07.04-12.07	92			0 986 474 173	↔ 37,93	1 987 470 506 <sup>B</sup>
	1.8i	05.05-01.08	92			0 986 473 173	↔ 37,93	1 987 470 506 <sup>B</sup>
	1.8 TDCi	04.05-12.07	85			0 986 474 173	↔ 37,93	1 987 470 506 <sup>B</sup>
		04.05-01.08	85			0 986 473 173	↔ 37,93	1 987 470 506 <sup>B</sup>
	2.0i	07.04-12.07	107			0 986 474 173	↔ 37,93	1 987 470 506 <sup>B</sup>
		07.04-01.08	107			0 986 473 173	↔ 37,93	1 987 470 506 <sup>B</sup>
	2.0 TDCi	07.04-12.07	98-100			0 986 474 173	↔ 37,93	1 987 470 506 <sup>B</sup>
		07.04-01.08	98-100			0 986 473 173	↔ 37,93	1 987 470 506 <sup>B</sup>
	2.5i ST	10.05-12.07	166			0 986 474 173	↔ 37,93	1 987 470 506 <sup>B</sup>
		10.05-01.08	166			0 986 473 173	↔ 37,93	1 987 470 506 <sup>B</sup>
								
	1.4i	07.04-03.07	59		SBR	1 987 477 216		1830
		07.04-01.08	59		HTB	1 987 482 122	↔ 228	
					HTB,MI	1 987 477 222		1450
		12.05-01.08	59			1 987 482 188		337
		04.07-01.08	59		SBR	1 987 482 189		1860
	1.6i	07.04-01.08	66/74-80/85		HTB	1 987 482 122	↔ 228	
	1.6i	07.04-03.07	66/74-80/85		SBR	1 987 477 216		1830
	1.6 TDCi	07.04-01.08	66/74-80/85		HTB,MI	1 987 477 222		1450
	1.6 Ti-VCT	12.05-01.08	66/74-80/85			1 987 482 188		337
		04.07-01.08	66/74-80/85		SBR	1 987 482 189		1860
	1.6 TDCi	07.04-01.08	66/74-80/85		HTB	1 987 482 122	↔ 228	
	1.6 Ti-VCT	07.04-01.08	66/74-80/85		HTB	1 987 482 122	↔ 228	
	1.8 FFV	07.04-01.08	85/92		HTB	1 987 482 122	↔ 228	





		S							
<b>FORD Focus II [04]</b>									
	<b>1.8 FFV</b>	07.04-03.07	85/92		SBR		1987 <b>477 216</b>		1830
	<b>1.8 i</b>	07.04-01.08	85/92		HTB,MI		1987 <b>477 222</b>		1450
	<b>1.8 TDCi</b>	12.05-01.08	85/92				1987 <b>482 188</b>		337
		04.07-01.08	85/92		SBR		1987 <b>482 189</b>		1860
	<b>1.8 i</b>	05.05-01.08	85/92		HTB		1987 <b>482 122</b>	↔ 228	
	<b>1.8 TDCi</b>	04.05-01.08	85/92		HTB		1987 <b>482 122</b>	↔ 228	
	<b>2.0 i</b>	07.04-03.07	98-100/107				1987 <b>477 216</b>		1830
	<b>2.0 TDCi</b>	12.05-01.08	98-100/107				1987 <b>482 188</b>		337
		04.07-01.08	98-100/107				1987 <b>482 189</b>		1860
	<b>2.5 i ST</b>	10.05-03.07	166				1987 <b>477 216</b>		1830
		12.05-01.08	166				1987 <b>482 188</b>		337
		04.07-01.08	166				1987 <b>482 189</b>		1860
	<b>1.4 i</b>	07.04-01.08	59				0986 <b>594 554</b> <sup>4</sup>		
		MFD 11.04-01.08	59				0986 <b>594 556</b> <sup>3</sup>		
		OFD 07.04-01.08	59				0986 <b>594 555</b> <sup>3</sup>		
	<b>1.6 i</b>	07.04-01.08	66/74-80/85				0986 <b>594 554</b> <sup>4</sup>		
	<b>1.6 TDCi</b>	MFD 11.04-01.08	66/74-80/85				0986 <b>594 556</b> <sup>3</sup>		
	<b>1.6 Ti-VCT</b>	OFD 07.04-01.08	66/74-80/85				0986 <b>594 555</b> <sup>3</sup>		
	<b>1.8 FFV</b>	07.04-01.08	85/92				0986 <b>594 554</b> <sup>4</sup>		
	<b>1.8 i</b>	MFD 11.04-01.08	85/92				0986 <b>594 556</b> <sup>3</sup>		
	<b>1.8 TDCi</b>	OFD 07.04-01.08	85/92				0986 <b>594 555</b> <sup>3</sup>		
	<b>2.0 i</b>	07.04-01.08	98-100/107				0986 <b>594 554</b> <sup>4</sup>		
	<b>2.0 TDCi</b>	MFD 11.04-01.08	98-100/107				0986 <b>594 556</b> <sup>3</sup>		
		OFD 07.04-01.08	98-100/107				0986 <b>594 555</b> <sup>3</sup>		
	<b>2.5 i ST</b>	10.05-01.08	166				0986 <b>594 554</b> <sup>4</sup>		
							0986 <b>594 556</b> <sup>3</sup>		
<b>Focus II [08]</b>									
	<b>1.4 i</b>	12.07-12.11	59				0986 <b>473 385</b>	👁️ ← 56,95	1987 <b>470 506</b> <sup>8</sup>
							0986 <b>474 385</b>	👁️ → 56,95	1987 <b>470 506</b> <sup>8</sup>
	<b>1.6 i, TDCi, Ti-VCT</b>	12.07-12.11	66/74-80/ 85-88				0986 <b>473 385</b>	👁️ ← 56,95	1987 <b>470 506</b> <sup>8</sup>
							0986 <b>474 385</b>	👁️ → 56,95	1987 <b>470 506</b> <sup>8</sup>
	<b>1.8 Flexifuel, i, TDCi</b>	12.07-12.11	85/92				0986 <b>473 385</b>	👁️ ← 56,95	1987 <b>470 506</b> <sup>8</sup>
							0986 <b>474 385</b>	👁️ → 56,95	1987 <b>470 506</b> <sup>8</sup>
	<b>2.0 CNG, i, LPG, TDCi</b>	12.07-12.11	81/93-107				0986 <b>473 385</b>	👁️ ← 56,95	1987 <b>470 506</b> <sup>8</sup>
							0986 <b>474 385</b>	👁️ → 56,95	1987 <b>470 506</b> <sup>8</sup>
	<b>1.4 i</b>	12.07-12.11	59				0986 <b>475 927</b>	↔ 20,64	
	<b>1.6 i, TDCi, Ti-VCT</b>	12.07-12.11	66/74-80/85-88				0986 <b>475 927</b>	↔ 20,64	
	<b>1.8 Flexifuel, i, TDCi</b>	12.07-12.11	85/92				0986 <b>475 927</b>	↔ 20,64	
	<b>2.0 CNG, i, LPG, TDCi</b>	12.07-12.11	81/93-107				0986 <b>475 927</b>	↔ 20,64	
	<b>1.4 i</b>	12.07-12.11	59				0986 <b>473 173</b>	👁️ ← 37,93	
							0986 <b>474 173</b>	👁️ → 37,93	
	<b>1.6 i, TDCi, Ti-VCT</b>	12.07-12.11	66/74-80/ 85-88				0986 <b>473 173</b>	👁️ ← 37,93	
							0986 <b>474 173</b>	👁️ → 37,93	
	<b>1.8 Flexifuel, i, TDCi</b>	12.07-12.11	85/92				0986 <b>473 173</b>	👁️ ← 37,93	
							0986 <b>474 173</b>	👁️ → 37,93	
	<b>2.0 CNG, i, LPG, TDCi</b>	12.07-12.11	81/93-107				0986 <b>473 173</b>	👁️ ← 37,93	
							0986 <b>474 173</b>	👁️ → 37,93	
	<b>2.5 i RS</b>	01.09-12.11	224				0986 <b>134 430</b>	👁️ ← 38	
	<b>2.5 i ST</b>	12.07-12.11	166				0986 <b>473 173</b>	👁️ ← 37,93	
							0986 <b>474 173</b>	👁️ → 37,93	
	<b>1.4 i</b>	12.07-07.10	59		4SB		1987 <b>482 189</b>		1860

		S							
1.4i	12.07-12.11	59					1 987 482 188	337	
						HTB	1 987 482 122	↔ 228	
						HTB,MI	1 987 477 222	1450	
1.6i	12.07-12.11	66/74-80/85-88				HTB	1 987 482 122	↔ 228	
1.6i	12.07-07.10	66/74-80/85-88				4SB	1 987 482 189	1860	
1.6 TDCi	12.07-12.11	66/74-80/					1 987 482 188	337	
1.6 Ti-VCT		85-88				HTB,MI	1 987 477 222	1450	
1.6 TDCi	12.07-12.11	66/74-80/85-88				HTB	1 987 482 122	↔ 228	
1.6 Ti-VCT	12.07-12.11	66/74-80/85-88				HTB	1 987 482 122	↔ 228	
1.8 Flexifuel	12.07-12.11	85/92				HTB	1 987 482 122	↔ 228	
1.8 Flexifuel	12.07-07.10	85/92				4SB	1 987 482 189	1860	
1.8i	12.07-12.11	85/92					1 987 482 188	337	
1.8 TDCi						HTB,MI	1 987 477 222	1450	
1.8i	12.07-12.11	85/92				HTB	1 987 482 122	↔ 228	
1.8 TDCi	12.07-12.11	85/92				HTB	1 987 482 122	↔ 228	
2.0 CNG	01.08-12.11	81/93-107				HTB	1 987 482 122	↔ 228	
2.0 CNG, i, LPG, TDCi	12.07-07.10	81/93-107				4SB	1 987 482 189	1860	
	12.07-12.11	81/93-107					1 987 482 188	337	
						HTB,MI	1 987 477 222	1450	
2.0i	12.07-12.11	81/93-107				HTB	1 987 482 122	↔ 228	
2.0 LPG	01.08-12.11	81/93-107				HTB	1 987 482 122	↔ 228	
2.0 TDCi	12.07-12.11	81/93-107				HTB	1 987 482 122	↔ 228	
2.5i RS	01.09-12.11	224					1 987 482 188	337	
							1 987 482 280	1848	
2.5i ST	12.07-07.10	166					1 987 482 189	1860	
	12.07-12.11	166					1 987 482 188	337	
1.4i	12.07-12.11	59					0 986 594 554 <sup>4</sup>		
	MFD 12.07-12.11	59					0 986 594 556 <sup>3</sup>		
	OFD 12.07-11.10	59					0 986 594 555 <sup>3</sup>		
1.6i	12.07-12.11	66/74-80/85-88					0 986 594 554 <sup>4</sup>		
1.6 TDCi	MFD 12.07-12.11	66/74-80/85-88					0 986 594 556 <sup>3</sup>		
1.6 Ti-VCT	OFD 12.07-11.10	66/74-80/85-88					0 986 594 555 <sup>3</sup>		
1.8 Flexifuel	12.07-12.11	85/92					0 986 594 554 <sup>4</sup>		
1.8i	MFD 12.07-12.11	85/92					0 986 594 556 <sup>3</sup>		
1.8 TDCi	OFD 12.07-11.10	85/92					0 986 594 555 <sup>3</sup>		
2.0 CNG, i, LPG, TDCi	12.07-12.11	81/93-107					0 986 594 554 <sup>4</sup>		
	MFD 12.07-12.11	81/93-107					0 986 594 556 <sup>3</sup>		
	OFD 12.07-11.10	81/93-107					0 986 594 555 <sup>3</sup>		
2.5i RS	01.09-12.11	224					0 986 594 554 <sup>4</sup>		
							0 986 594 556 <sup>3</sup>		
2.5i ST	12.07-12.11	166					0 986 594 554 <sup>4</sup>		
	MFD 12.07-12.11	166					0 986 594 556 <sup>3</sup>		
	OFD 12.07-11.10	166					0 986 594 555 <sup>3</sup>		
<b>Focus III Turnier [11]</b>									
1.0 ECOBoost	02.12→	74/92					0 986 473 385	← 56,95	1 987 470 506 <sup>B</sup>
							0 986 474 385	→ 56,95	1 987 470 506 <sup>B</sup>
1.6 EcoBoost, EcoBoost FlexiFuel, TDCi, TDCi ECOnetic, Ti-VCT, Ti-VCT FlexiFuel	01.11→	63/70/77/ 85/86-88/ 92/110/134					0 986 473 385	← 56,95	1 987 470 506 <sup>B</sup>
							0 986 474 385	→ 56,95	1 987 470 506 <sup>B</sup>
2.0 GDI Ti-VCT	01.11→	85/100/					0 986 473 385	← 56,95	1 987 470 506 <sup>B</sup>
2.0 TDCi		103/110/120					0 986 474 385	→ 56,95	1 987 470 506 <sup>B</sup>
1.0 ECOBoost	02.12→	74/92					0 986 475 989	↔ 20,6	
1.6 EcoBoost, EcoBoost FlexiFuel, TDCi, TDCi ECOnetic, Ti-VCT, Ti-VCT FlexiFuel	01.11→	63/70/77/85/86-88/ 92/110/134					0 986 475 989	↔ 20,6	
2.0 TDCi	01.11→	85/100/103/120					0 986 475 989	↔ 20,6	



			S								
◀ FORD Focus III Turnier [11]											
	1.0 EcoBoost	02.12→	74/92		HTB	1987 482 370	↔ 230				
					TW	1987 482 369	306				
	1.6 EcoBoost	01.11→	63/70/77/85/86-88/92/110/134		HTB	1987 482 370	↔ 230				
	1.6 EcoBoost FlexiFuel	02.14→	63/70/77/85/86-88/92/110/134		HTB	1987 482 370	↔ 230				
	1.6 EcoBoost, EcoBoost FlexiFuel, TDCi, TDCi ECOnetic, Ti-VCT, Ti-VCT FlexiFuel	01.11→	63/70/77/85/86-88/92/110/134		TW	1987 482 369	306				
	1.6 TDCi	01.11→	63/70/77/85/86-88/92/110/134		HTB	1987 482 370	↔ 230				
	1.6 TDCi ECOnetic	06.12→	63/70/77/85/86-88/92/110/134		HTB	1987 482 370	↔ 230				
	1.6 Ti-VCT	01.11→	63/70/77/85/86-88/92/110/134		HTB	1987 482 370	↔ 230				
	1.6 Ti-VCT FlexiFuel	01.11→	63/70/77/85/86-88/92/110/134		HTB	1987 482 370	↔ 230				
	2.0 EcoBoost ST	06.12→	184		TW	1987 482 369	306				
	2.0 GDI Ti-VCT	09.11→	110		TW	1987 482 369	306				
	2.0 TDCi	01.11→	85/100/ 103 120		HTB	1987 482 370	↔ 230				
					TW	1987 482 369	306				
				HTB	1987 482 370	↔ 230					
				TW	1987 482 369	306					
Focus III [11]											
	Electric	06.13→	107			0986 473 385		← 56,95	1987 470 506 <sup>8</sup>		
						0986 474 385		→ 56,95	1987 470 506 <sup>8</sup>		
	1.0 EcoBoost	02.12→	74/92			0986 473 385		← 56,95	1987 470 506 <sup>8</sup>		
						0986 474 385		→ 56,95	1987 470 506 <sup>8</sup>		
	1.6 EcoBoost, EcoBoost FlexiFuel, TDCi, TDCi ECOnetic, Ti-VCT, Ti-VCT FlexiFuel	01.11→	63/70/77/85/86-88/ 92/110/134			0986 473 385		← 56,95	1987 470 506 <sup>8</sup>		
						0986 474 385		→ 56,95	1987 470 506 <sup>8</sup>		
2.0 GDI Ti-VCT	01.11→	85/100/			0986 473 385		← 56,95	1987 470 506 <sup>8</sup>			
2.0 TDCi		103/110-125			0986 474 385		→ 56,95	1987 470 506 <sup>8</sup>			
	Electric	06.13→	107			0986 475 989	↔ 20,6				
	1.0 EcoBoost	02.12→	74/92			0986 475 989	↔ 20,6				
	1.6 EcoBoost, EcoBoost FlexiFuel, TDCi, TDCi ECOnetic, Ti-VCT, Ti-VCT FlexiFuel	01.11→	63/70/77/85/86-88/ 92/110/134			0986 475 989	↔ 20,6				
	2.0 TDCi	01.11→	85/100/103/120-125			0986 475 989	↔ 20,6				
	Electric	06.13→	107		HTB	1987 482 370	↔ 230				
					TW	1987 482 369	306				
	1.0 EcoBoost	02.12→	74/92		HTB	1987 482 370	↔ 230				
					TW	1987 482 369	306				
	1.6 EcoBoost	01.11→	63/70/77/85/86-88/92/110/134		HTB	1987 482 370	↔ 230				
	1.6 EcoBoost FlexiFuel	02.14→	63/70/77/85/86-88/92/110/134		HTB	1987 482 370	↔ 230				
	1.6 EcoBoost, EcoBoost FlexiFuel, TDCi, TDCi ECOnetic, Ti-VCT, Ti-VCT FlexiFuel	01.11→	63/70/77/85/86-88/ 92/110/134		TW	1987 482 369	306				
	1.6 TDCi	01.11→	63/70/77/85/86-88/92/110/134		HTB	1987 482 370	↔ 230				
	1.6 TDCi ECOnetic	06.12→	63/70/77/85/86-88/92/110/134		HTB	1987 482 370	↔ 230				
	1.6 Ti-VCT	01.11→	63/70/77/85/86-88/92/110/134		HTB	1987 482 370	↔ 230				
	1.6 Ti-VCT FlexiFuel	01.11→	63/70/77/85/86-88/92/110/134		HTB	1987 482 370	↔ 230				
	2.0 EcoBoost ST	06.12→	184		TW	1987 482 369	306				
	2.0 GDI Ti-VCT	09.11→	110-125		TW	1987 482 369	306				
	2.0 TDCi	01.11→	85/100/ 103 120-125		HTB	1987 482 370	↔ 230				
					TW	1987 482 369	306				
				HTB	1987 482 370	↔ 230					
				TW	1987 482 369	306					



**Focus IV Turnier [15]**

	1.0 EcoBoost	10.14→	74/92		0 986 473 385		56,95	1 987 470 506 <sup>B</sup>
					0 986 474 385		56,95	1 987 470 506 <sup>B</sup>
	1.5 EcoBoost, TDCi, TDCi ECInetic	10.14→	70/77/88/ 110/134		0 986 473 385		56,95	1 987 470 506 <sup>B</sup>
					0 986 474 385		56,95	1 987 470 506 <sup>B</sup>
	1.6 TDCi	10.14→	70/85		0 986 473 385		56,95	1 987 470 506 <sup>B</sup>
					0 986 474 385		56,95	1 987 470 506 <sup>B</sup>
	2.0 TDCi	10.14→	110		0 986 473 385		56,95	1 987 470 506 <sup>B</sup>
					0 986 474 385		56,95	1 987 470 506 <sup>B</sup>

	1.0 EcoBoost	10.14→	74/92		0 986 475 989		20,6	
	1.5 EcoBoost, TDCi, TDCi ECInetic	10.14→	70/77/88/110/134		0 986 475 989		20,6	
	1.6 TDCi	10.14→	70/85		0 986 475 989		20,6	
	2.0 TDCi	10.14→	110		0 986 475 989		20,6	

	1.0 EcoBoost	10.14→	74/92	HTB	1 987 482 370		230	
	1.5 EcoBoost	10.14→	70/77/88/110/134	HTB	1 987 482 370		230	
	1.5 TDCi	10.14→	70/77/88/110/134	HTB	1 987 482 370		230	
	1.5 TDCi ECInetic	10.14→	70/77/88/110/134	HTB	1 987 482 370		230	
	1.6 TDCi	10.14→	70/85	HTB	1 987 482 370		230	
	2.0 TDCi	10.14→	110	HTB	1 987 482 370		230	

**Focus IV [15]**

	1.0 EcoBoost	10.14→	74/92		0 986 473 385		56,95	1 987 470 506 <sup>B</sup>
					0 986 474 385		56,95	1 987 470 506 <sup>B</sup>
	1.5 EcoBoost, TDCi, TDCi ECONetic	10.14→	70/77/88/ 110/134		0 986 473 385		56,95	1 987 470 506 <sup>B</sup>
					0 986 474 385		56,95	1 987 470 506 <sup>B</sup>
	1.6 TDCi	10.14→	70/85		0 986 473 385		56,95	1 987 470 506 <sup>B</sup>
					0 986 474 385		56,95	1 987 470 506 <sup>B</sup>
	2.0 TDCi	10.14→	110		0 986 473 385		56,95	1 987 470 506 <sup>B</sup>
					0 986 474 385		56,95	1 987 470 506 <sup>B</sup>

	1.0 EcoBoost	10.14→	74/92		0 986 475 989		20,6	
	1.5 EcoBoost, TDCi, TDCi ECONetic	10.14→	70/77/88/110/134		0 986 475 989		20,6	
	1.6 TDCi	10.14→	70/85		0 986 475 989		20,6	
	2.0 TDCi	10.14→	110		0 986 475 989		20,6	

	1.0 EcoBoost	10.14→	74/92	HTB	1 987 482 370		230	
	1.5 EcoBoost	10.14→	70/77/88/110/134	HTB	1 987 482 370		230	
	1.5 TDCi	10.14→	70/77/88/110/134	HTB	1 987 482 370		230	
	1.5 TDCi ECONetic	10.14→	70/77/88/110/134	HTB	1 987 482 370		230	
	1.6 TDCi	10.14→	70/85	HTB	1 987 482 370		230	
	2.0 TDCi	10.14→	110	HTB	1 987 482 370		230	

**Focus Sedan [Fase I]**

	1.6 i 8V	03.04→	75					1 987 470 006 <sup>7</sup>
	1.8 i 16V	09.00-07.04	85					1 987 470 006 <sup>7</sup>
	2.0 i 16V	07.00-09.08	96-97/103-108					1 987 470 006 <sup>7</sup>



		S				?			
◀ FORD Focus Sedan [Fase I]									
	1.6 i8V	03.04→	75			F 026 <b>002 581</b>	↔ 20,64		
	1.8 i16V	09.00-07.04	85		STB	F 026 <b>002 581</b>	↔ 20,64		
	2.0 i16V	07.00-09.08	96-97/103-108		STB	F 026 <b>002 581</b>	↔ 20,64		
	1.8 i16V	09.00-07.04	85			0986 <b>473 080</b>	👁️ ← 33,9		
						0986 <b>474 080</b>	👁️ → 33,9		
	2.0 i16V	07.00-09.08	96-97/ 103-108			0986 <b>473 080</b>	👁️ ← 33,9		
						0986 <b>474 080</b>	👁️ → 33,9		
	2.0 i16V	06.05-09.08	103-108			1987 <b>477 906</b>	← 175		
Focus Sedan [Fase II]									
	2.0 i16V	10.08→	107			0986 <b>473 385</b>	👁️ ← 56,95		
						0986 <b>474 385</b>	👁️ → 56,95		
	2.0 i16V	10.08→	107			1987 <b>482 189</b>	1860		
Focus Turnier [15]									
	1.6 Ti-VCT	10.14→	63/77/86/ 92			0986 <b>473 385</b>	👁️ ← 56,95	1987 <b>470 506<sup>8</sup></b>	
						0986 <b>474 385</b>	👁️ → 56,95	1987 <b>470 506<sup>8</sup></b>	
	1.6 Ti-VCT	10.14→	63/77/86/ 92			0986 <b>475 989</b>	↔ 20,6		
	1.6 Ti-VCT	10.14→	63/77/86/ 92		HTB	1987 <b>482 370</b>	↔ 230		
Focus [15]									
	1.6 Ti-VCT	10.14→	63/77/86/ 92			0986 <b>473 385</b>	👁️ ← 56,95	1987 <b>470 506<sup>8</sup></b>	
						0986 <b>474 385</b>	👁️ → 56,95	1987 <b>470 506<sup>8</sup></b>	
	1.6 Ti-VCT	10.14→	63/77/86/ 92			0986 <b>475 989</b>	↔ 20,6		
	1.6 Ti-VCT	10.14→	63/77/86/ 92		HTB	1987 <b>482 370</b>	↔ 230		



		S									
<b>Fusion [02]</b>											
	1.4 i	10.02-06.12	50/56-59				0 986 473 275	← 54	1 987 470 506 <sup>B</sup>		
	1.4 TDCi						0 986 474 275	→ 54	1 987 470 506 <sup>B</sup>		
	1.6 i	10.02-06.12	66/74				0 986 473 275	← 54	1 987 470 506 <sup>B</sup>		
	1.6 TDCi						0 986 474 275	→ 54	1 987 470 506 <sup>B</sup>		
	1.25 i	03.05-06.12	55				0 986 473 275	← 54	1 987 470 506 <sup>B</sup>		
							0 986 474 275	→ 54	1 987 470 506 <sup>B</sup>		
	1.4 i, TDCi	10.02-06.12	50/56-59				0 986 475 926	↔ 19,05			
	1.6 i, TDCi	10.02-06.12	66/74				0 986 475 926	↔ 19,05			
	1.25 i	03.05-06.12	55				0 986 475 926	↔ 19,05			
	1.4 i	10.02-06.12	50/56-59				1 987 477 906	↔ 175			
	1.4 i	10.02-06.12	50/56-59				1 987 482 132	300			
	1.4 TDCi				MI		1 987 477 732	1445			
	1.4 TDCi	10.02-06.12	50/56-59				1 987 477 906	↔ 175			
	1.6 i	10.02-06.12	66/74				1 987 477 906	↔ 175			
	1.6 i	10.02-06.12	66/74				1 987 482 132	300			
	1.6 TDCi				MI		1 987 477 732	1445			
	1.6 TDCi	11.04-06.12	66/74				1 987 477 906	↔ 175			
	1.25 i	03.05-06.12	55				1 987 477 906	↔ 175			
						MI	1 987 482 132	300			
					MI	1 987 477 732	1445				
	1.4 i, TDCi	10.02-06.12	50/56-59				0 986 594 557 <sup>3</sup>				
	1.6 i, TDCi	10.02-06.12	66/74				0 986 594 557 <sup>3</sup>				
	1.25 i	03.05-06.12	55				0 986 594 557 <sup>3</sup>				
<b>Galaxy [00]</b>											
	1.9 TDI	04.00-05.01	66/85				0 986 473 111	← 56,93	1 987 470 005 <sup>6</sup>		
							0 986 473 111	← 56,93	1 987 470 005 <sup>7</sup>		
							0 986 473 111	← 56,93	1 987 470 506 <sup>B</sup>		
					0 986 474 111	→ 56,93	1 987 470 005 <sup>6</sup>				
			06.01-08.06	66/85				0 986 473 259	← 57	1 987 470 005 <sup>6</sup>	
								0 986 473 259	← 57	1 987 470 005 <sup>7</sup>	
							0 986 474 259	→ 57	1 987 470 005 <sup>6</sup>		
			01.03-08.06	96/110				0 986 473 259	← 57	1 987 470 005 <sup>6</sup>	
								0 986 473 259	← 57	1 987 470 005 <sup>7</sup>	
								0 986 474 259	→ 57	1 987 470 005 <sup>6</sup>	
		2.0 i	01.01-05.01	85				0 986 473 111	← 56,93	1 987 470 005 <sup>6</sup>	
							0 986 473 111	← 56,93	1 987 470 005 <sup>7</sup>		
							0 986 473 111	← 56,93	1 987 470 506 <sup>B</sup>		
					0 986 474 111	→ 56,93	1 987 470 005 <sup>6</sup>				
				06.01-08.06	85				0 986 473 259	← 57	1 987 470 005 <sup>6</sup>
									0 986 473 259	← 57	1 987 470 005 <sup>7</sup>
								0 986 474 259	→ 57	1 987 470 005 <sup>6</sup>	
		2.3 i	04.00-05.01	107				0 986 473 111	← 56,93	1 987 470 005 <sup>6</sup>	
						0 986 473 111	← 56,93	1 987 470 005 <sup>7</sup>			
						0 986 473 111	← 56,93	1 987 470 506 <sup>B</sup>			
				0 986 474 111	→ 56,93	1 987 470 005 <sup>6</sup>					
			06.01-08.06	107				0 986 473 259	← 57	1 987 470 005 <sup>6</sup>	
								0 986 473 259	← 57	1 987 470 005 <sup>7</sup>	
							0 986 474 259	→ 57	1 987 470 005 <sup>6</sup>		



		S								
<b>FORD Galaxy [00]</b>										
	2.3 i	11.02-08.06	103				0986 473 259		← 57	1987 470 005 <sup>6</sup>
							0986 473 259		← 57	1987 470 005 <sup>7</sup>
							0986 474 259		→ 57	1987 470 005 <sup>6</sup>
	2.8 i	04.00-08.06	150				0986 473 184		← 57	1987 470 005 <sup>6</sup>
							0986 473 184		← 57	1987 470 005 <sup>7</sup>
							0986 474 184		→ 57	1987 470 005 <sup>6</sup>
	1.9 TDI	04.00-08.06	66/85/96/ 110				0986 473 846		← 38	1987 470 040 <sup>7</sup>
							0986 473 847		→ 38	1987 470 040 <sup>7</sup>
	2.0 i	01.01-08.06	85				0986 473 846		← 38	1987 470 040 <sup>7</sup>
							0986 473 847		→ 38	1987 470 040 <sup>7</sup>
	2.3 i	04.00-08.06	103/107				0986 473 846		← 38	1987 470 040 <sup>7</sup>
							0986 473 847		→ 38	1987 470 040 <sup>7</sup>
2.8 i	04.00-08.06	150				0986 473 073		← 38	1987 470 040 <sup>7</sup>	
	1.9 TDI	04.00-08.06	66/85/96/ 110				1987 477 630		↔ 1293	
							1987 477 833		654	
	2.0 i	01.01-08.06	85				1987 477 630		↔ 1293	
							1987 477 833		654	
	2.3 i	04.00-08.06	103/107				1987 477 630		↔ 1293	
							1987 477 833		654	
2.8 i	04.00-08.06	150				1987 477 833		654		
<b>Galaxy [06]</b>										
	1.6 EcoBoost, TDCi	11.10→	85/118						1987 470 506 <sup>8</sup>	
	1.8 TDCi	03.06-03.10	74/92						1987 470 506 <sup>8</sup>	
	2.0, FlexiFuel, TDCi	03.06→	85/96/100/103/107/120						1987 470 506 <sup>8</sup>	
	2.0 EcoBoost SCTi	03.10→	147-149			TW			1987 470 506 <sup>8</sup>	
	2.2 TDCi	03.08-10.10	129						1987 470 506 <sup>8</sup>	
		11.10→	147						1987 470 506 <sup>8</sup>	
	2.3	09.07→	118						1987 470 506 <sup>8</sup>	
	1.6 EcoBoost, TDCi	11.10→	85/118		FEB		0986 134 430		← 38	
	1.8 TDCi	03.06-03.10	74/92		FEB		0986 134 430		← 38	
	2.0, EcoBoost SCTi, FlexiFuel, TDCi	03.06→	85/96/100/103/107/120/147-149		FEB		0986 134 430		← 38	
	2.2 TDCi	03.08→	129/147		FEB		0986 134 430		← 38	
	2.3	09.07→	118		FEB		0986 134 430		← 38	
	1.6 EcoBoost, TDCi	11.10→	85/118				1987 482 242		→ 2071	
	1.8 TDCi	03.06-02.07	74/92				1987 482 133		← 2070	
							1987 482 134		→ 2067	
				03.07-03.10	74/92			1987 482 242		→ 2071
	2.0, FlexiFuel, TDCi	03.07→	103/107				1987 482 242		→ 2071	
	2.0	03.06-02.07	103/107				1987 482 133		← 2070	
	2.0 TDCi						1987 482 134		→ 2067	
	2.0 EcoBoost SCTi, TDCi	03.10→	120/147-149				1987 482 242		→ 2071	
	2.0 TDCi	03.06-02.07	96				1987 482 133		← 2070	
							1987 482 134		→ 2067	
							03.07-02.10	96		1987 482 242
				11.07→	85			1987 482 242		→ 2071
				09.08→	100			1987 482 242		→ 2071
	2.2 TDCi	03.08→	129/147				1987 482 242		→ 2071	
	2.3	09.07→	118				1987 482 242		→ 2071	









































		S								
	1.6 EcoBoost	11.10→	85/118				0 986 594 554 <sup>4</sup>			
	1.6 TDCi						0 986 594 555 <sup>3</sup>			
	1.8 TDCi	03.06-03.10	74/92				0 986 594 554 <sup>4</sup>			
							0 986 594 555 <sup>3</sup>			
	2.0, EcoBoost SCTi, FlexiFuel, TDCi	03.06→	85/96/100/103/107/120/147-149				0 986 594 554 <sup>4</sup>			
	2.2 TDCi	03.08→	129/147				0 986 594 554 <sup>4</sup>			
							0 986 594 555 <sup>3</sup>			
2.3	09.07→	118				0 986 594 554 <sup>4</sup>				
							0 986 594 555 <sup>3</sup>			
<b>Galaxy [95]</b>										
	1.9 TDI	02.95-03.00	66/81				0 986 473 111		56,93	1 987 470 005 <sup>7</sup>
							0 986 473 111		56,93	1 987 470 506 <sup>8</sup>
							0 986 474 111		56,93	1 987 470 005 <sup>7</sup>
	2.0i	02.95-03.00	85				0 986 473 111		56,93	1 987 470 005 <sup>7</sup>
							0 986 473 111		56,93	1 987 470 506 <sup>8</sup>
							0 986 474 111		56,93	1 987 470 005 <sup>7</sup>
	2.3i 16V	01.97-03.00	107				0 986 473 111		56,93	1 987 470 005 <sup>7</sup>
							0 986 473 111		56,93	1 987 470 506 <sup>8</sup>
							0 986 474 111		56,93	1 987 470 005 <sup>7</sup>
	2.8i	02.95-03.00	128				0 986 473 111		56,93	1 987 470 005 <sup>7</sup>
2.8i 4x4						0 986 473 111		56,93	1 987 470 506 <sup>8</sup>	
							0 986 474 111		56,93	1 987 470 005 <sup>7</sup>
	1.9 TDI	02.95-03.00	66/81				0 986 473 846		38	1 987 470 040 <sup>7</sup>
							0 986 473 847		38	1 987 470 040 <sup>7</sup>
	2.0i	02.95-03.00	85				0 986 473 846		38	1 987 470 040 <sup>7</sup>
							0 986 473 847		38	1 987 470 040 <sup>7</sup>
	2.3i 16V	01.97-03.00	107				0 986 473 846		38	1 987 470 040 <sup>7</sup>
							0 986 473 847		38	1 987 470 040 <sup>7</sup>
	2.8i	02.95-03.00	128				0 986 473 846		38	1 987 470 040 <sup>7</sup>
	2.8i 4x4						0 986 473 847		38	1 987 470 040 <sup>7</sup>
	1.9 TDI	02.95-03.00	66/81				1 987 477 630		1293	
							1 987 477 833		654	
	2.0i	02.95-03.00	85				1 987 477 630		1293	
							1 987 477 833		654	
	2.3i 16V	01.97-03.00	107				1 987 477 630		1293	
							1 987 477 833		654	
	2.8i, i 4x4	02.95-03.00	128				1 987 477 833		654	
	1.9 TDI	09.97-03.00	66/81				0 986 594 010 <sup>3</sup>			
							0 986 594 011 <sup>4</sup>			
	2.0i	09.97-03.00	85				0 986 594 010 <sup>3</sup>			
							0 986 594 011 <sup>4</sup>			
	2.3i 16V	09.97-03.00	107				0 986 594 010 <sup>3</sup>			
							0 986 594 011 <sup>4</sup>			
	2.8i	09.97-03.00	128				0 986 594 010 <sup>3</sup>			
2.8i 4x4						0 986 594 011 <sup>4</sup>				
<b>Granada III Estate [92]</b>										
	2.0i	09.92-09.94	85							1 987 470 506 <sup>8</sup>
	2.4i	09.92-09.94	92							1 987 470 506 <sup>8</sup>
	2.5 D Turbo	09.92-09.94	68							1 987 470 506 <sup>8</sup>





<b>◀ FORD Granada III Estate [92]</b>									
	2.9 i	09.92-09.94	107						1 987 470 506 <sup>8</sup>
	2.9 i 4x4	02.92-09.94	107						1 987 470 506 <sup>8</sup>
	2.0 i	02.92-09.94	85		0 986 474 152		→ 42,79		
	2.4 i	02.92-09.94	92		0 986 474 152		→ 42,79		
	2.5 D Turbo	02.92-09.94	68		0 986 474 152		→ 42,79		
	2.9 i	02.92-09.94	107		0 986 474 152		→ 42,79		
	2.9 i 4x4				0 986 474 152				
	2.0 i	02.92-09.94	85		1 987 477 735		3760		
	2.4 i	02.92-09.94	92		1 987 477 735		3760		
	2.5 D Turbo	02.92-09.94	68		1 987 477 735		3760		
	2.9 i, i 4x4	02.92-09.94	107		1 987 477 735		3760		
<b>Granada III [92]</b>									
	2.0 i	09.92-09.94	85						1 987 470 506 <sup>8</sup>
	2.4 i	09.92-09.94	92						1 987 470 506 <sup>8</sup>
	2.5 D Turbo	09.92-09.94	68						1 987 470 506 <sup>8</sup>
	2.9 i	09.92-09.94	107						1 987 470 506 <sup>8</sup>
	2.9 i 4x4	02.92-09.94	107						1 987 470 506 <sup>8</sup>
		09.92-09.94	107		AA				1 987 470 506 <sup>8</sup>
	2.9 i 24V	02.92-09.94	143		0 986 474 152		→ 42,79		
					0 986 474 152				
	2.0 i	02.92-09.94	85		1 987 477 735		3760		
	2.4 i	02.92-09.94	92		1 987 477 735		3760		
	2.5 D Turbo	02.92-09.94	68		1 987 477 735		3760		
	2.9 i, i 4x4, i 24V	02.92-09.94	107/143		1 987 477 735		3760		
<b>Ka [Fase I]</b>									
	1.6 i	02.01-12.07	70		0 986 AB8 491		↔		
<b>Ka [08]</b>									
	1.2	09.08-05.10	51		BSY F 026 002 474		↔ 20,64		
		06.10→	51		LOC 0 986 475 974		↔ 20,64		
	1.3 TDCi	09.08-05.10	55		BSY F 026 002 474		↔ 20,64		
		06.10→	55		LOC 0 986 475 974		↔ 20,64		
	1.2	09.08→	51		1 987 482 241		↔ 2071		
	1.3 TDCi	09.08→	55		1 987 482 241		↔ 2071		































































F

		S							
<b>Ka [97]</b>									
									
	1.3i	09.96-01.00	36/37/44				0 986 473 897	 ← 48	1 987 470 506 <sup>B</sup>
							0 986 473 898	 → 48	1 987 470 506 <sup>B</sup>
		02.00-09.08	36/37/44				0 986 134 286	 ← 48	1 987 470 506 <sup>B</sup>
							0 986 135 286	 → 48	1 987 470 506 <sup>B</sup>
		10.02-09.08	51				0 986 134 286	 ← 48	1 987 470 506 <sup>B</sup>
							0 986 135 286	 → 48	1 987 470 506 <sup>B</sup>
	1.6i	07.03-09.08	70				0 986 473 275	 ← 54	1 987 470 506 <sup>B</sup>
							0 986 474 275	 → 54	1 987 470 506 <sup>B</sup>
									
	1.3i	09.96-02.00	36/37/44				0 986 475 776	↔ 19	
		03.00-09.08	36/37/44				0 986 475 905	↔ 19,05	
		10.02-09.08	51				0 986 475 905	↔ 19,05	
	1.6i	07.03-09.08	70				0 986 475 926	↔ 19,05	
									
	1.3i	09.96-11.06	36/37/44/ 51				1 987 477 301	1627	
							1 987 477 517	312	
	1.6i	07.03-11.06	70				1 987 477 517	312	
		07.03-12.06	70				1 987 477 345	1640	
	1.3i	09.96-08.04	36/37/44/51				0 986 594 024 <sup>3</sup>		
	1.6i	07.03-08.04	70				0 986 594 024 <sup>3</sup>		
<b>Kuga [DM2]</b>									
									
	2.5	01.14→	110				0 986 473 385	 ← 56,95	1 987 470 506 <sup>B</sup>
							0 986 474 385	 → 56,95	1 987 470 506 <sup>B</sup>
<b>Kuga [08]</b>									
									
	2.0 TDCi	02.08-11.12	100/103/				0 986 473 385	 ← 56,95	1 987 470 506 <sup>B</sup>
	2.0 TDCi 4x4		120-123				0 986 474 385	 → 56,95	1 987 470 506 <sup>B</sup>
	2.5 i 4x4	12.08-11.12	147				0 986 473 385	 ← 56,95	1 987 470 506 <sup>B</sup>
							0 986 474 385	 → 56,95	1 987 470 506 <sup>B</sup>
									
	2.0 TDCi, TDCi 4x4	02.08-11.12	100/103/120-123				0 986 134 430	 ← 38	
	2.5 i 4x4	12.08-11.12	147				0 986 134 430	 ← 38	
									
	2.0 TDCi	02.08-11.12	100/103/				1 987 482 279	360	
	2.0 TDCi 4x4		120-123				1 987 482 280	1848	
	2.5 i 4x4	12.08-11.12	147				1 987 482 279	360	
							1 987 482 280	1848	
	2.0 TDCi	02.08-11.10	100/103				0 986 594 555 <sup>3</sup>		
		02.08-11.12	100/103				0 986 594 554 <sup>4</sup>		
	2.0 TDCi 4x4	02.08-11.10	100/103				0 986 594 555 <sup>3</sup>		
		02.08-11.12	100/103				0 986 594 569 <sup>4</sup>		
		04.10-11.10	120-123				0 986 594 555 <sup>3</sup>		
		04.10-11.12	120-123				0 986 594 569 <sup>4</sup>		
	2.5 i 4x4	12.08-11.10	147				0 986 594 555 <sup>3</sup>		
		12.08-11.12	147				0 986 594 569 <sup>4</sup>		

























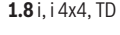





















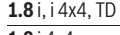

















		S				?			
◀ FORD									
<b>Kuga [13]</b>									
	1.5 EcoBoost	10.14→	110				0986 473 385	← 56,95	1987 470 506 <sup>8</sup>
							0986 474 385	→ 56,95	1987 470 506 <sup>8</sup>
	1.6 EcoBoost	11.12-09.14	110				0986 473 385	← 56,95	1987 470 506 <sup>8</sup>
							0986 474 385	→ 56,95	1987 470 506 <sup>8</sup>
	2.0 TDCi	11.12→	88/100/ 103/110		TW		0986 473 385	← 56,95	1987 470 506 <sup>8</sup>
							0986 474 385	→ 56,95	1987 470 506 <sup>8</sup>
<b>Maverick [UDS, UNS]</b>									
	2.4 i	06.93-04.96	91				0986 475 759	↔ 23,8	
							0986 475 984	↔ 22,2	
		05.96-12.98	85/87				0986 475 759	↔ 23,8	
	2.7 TD	06.93-04.96	74				0986 475 759	↔ 23,8	
							0986 475 984	↔ 22,2	
		05.96-12.98	92				0986 475 759	↔ 23,8	
	2.4 i	06.93-12.98	85/87/91				1987 477 756	← 1324	
							1987 477 757	↔ 1470	
							1987 482 152	→ 1355	
	2.7 TD	06.93-12.98	74/92				1987 477 756	← 1324	
							1987 477 757	↔ 1470	
							1987 482 152	→ 1355	
<b>Mondeo</b>									
	1.8 D Turbo, i	11.97-07.01	66/85						1987 470 506 <sup>8</sup>
	2.0 i	11.97-07.01	97						1987 470 506 <sup>8</sup>
	2.5 i	02.98-12.01	125		NAA		0986 471 935	→ 60	1987 470 034 <sup>7</sup>
									1987 470 506 <sup>8</sup>
							0986 471 936	← 60	1987 470 034 <sup>7</sup>
	1.8 D Turbo, i	11.97-07.01	66/85				0986 475 752	↔ 22,2	
	2.0 i	11.97-07.01	97				0986 475 750	↔ 20,6	
	2.5 i	02.98-12.01	125				0204 102 859	← 36	
							0986 473 281		
							0204 102 860	→ 36	
							0986 474 281		
	2.5 i	03.04-01.08	127				1987 477 734		1735
	2.5 i	03.04-01.08	127				0265 007 879 <sup>3</sup>		
							0265 007 879 <sup>4</sup>		
<b>Mondeo I Turnier [93]</b>									
	1.6 i	04.93-07.96	65/66				0986 473 078	← 59,93	1987 470 034 <sup>7</sup>
							0986 474 078	→ 59,93	1987 470 034 <sup>7</sup>
	1.8 i	04.93-07.96	65/82/85				0986 473 078	← 59,93	1987 470 034 <sup>7</sup>
	1.8 TD						0986 474 078	→ 59,93	1987 470 034 <sup>7</sup>



								
								
2.0i	04.93-07.96	100				0 986 473 078	 59,93	1 987 470 034 <sup>7</sup>
						0 986 474 078	 59,93	1 987 470 034 <sup>7</sup>
2.0i 4x4	08.94-07.96	97-100				0 986 471 935	 60	1 987 470 034 <sup>7</sup>
						0 986 473 277	 60	1 987 470 034 <sup>7</sup>
2.5i	08.94-07.96	125				0 986 471 936	 60	1 987 470 034 <sup>7</sup>
						0 986 473 935	 60	1 987 470 034 <sup>7</sup>
						0 986 473 277	 60	1 987 470 034 <sup>7</sup>
						0 986 471 936	 60	1 987 470 034 <sup>7</sup>
								
	1.6i	04.93-07.96	65/66			0 986 475 751	 22,2	
	1.8i, TD	04.93-07.96	65/82/85			0 986 475 751	 22,2	
	2.0i, i 4x4	04.93-07.96	97-100			0 986 475 751	 22,2	
	1.6i	04.93-07.96	65/66			0 204 102 864	 36	
						0 204 103 864	 36	
						0 204 102 865	 36	
						0 204 103 865	 36	
	1.8i	04.93-07.96	65/82/85			0 204 102 864	 36	
	1.8 TD					0 204 103 864	 36	
						0 204 102 865	 36	
						0 204 103 865	 36	
	2.0i	04.93-07.96	97-100			0 204 102 864	 36	
	2.0i 4x4					0 204 103 864	 36	
						0 204 102 865	 36	
						0 204 103 865	 36	
	2.5i	08.94-07.96	125			0 204 102 864	 36	
						0 204 103 864	 36	
						0 204 102 865	 36	
						0 204 103 865	 36	
								
	1.6i	04.93-07.96	65/66		STB	1 987 477 521	 1611	
		05.93-07.96	65/66			1 987 477 631	270	
	1.8i	04.93-07.96	65/82/85		STB	1 987 477 521	 1611	
	1.8i, TD	05.93-07.96	65/82/85			1 987 477 631	270	
	1.8 TD	06.93-07.96	65/82/85		STB	1 987 477 521	 1611	
	2.0i	04.93-07.96	97-100		STB	1 987 477 521	 1611	
	2.0i, i 4x4	05.93-07.96	97-100			1 987 477 631	270	
	2.0i 4x4	07.93-07.96	97-100		STB	1 987 477 521	 1611	
	2.5i	08.94-07.96	125			1 987 477 631	270	
					STB	1 987 477 521	 1611	
		09.94-07.96	125		4SB	1 987 477 836	1462	
<b>Mondeo I [93]</b>								
								
	1.6i	01.93-07.96	65/66			0 986 473 078	 59,93	1 987 470 034 <sup>7</sup>
						0 986 474 078	 59,93	1 987 470 034 <sup>7</sup>
	1.8i	01.93-07.96	85			0 986 473 078	 59,93	1 987 470 034 <sup>7</sup>
						0 986 474 078	 59,93	1 987 470 034 <sup>7</sup>
	1.8i	01.93-07.96	65/82			0 986 473 078	 59,93	1 987 470 034 <sup>7</sup>
	1.8 TD					0 986 474 078	 59,93	1 987 470 034 <sup>7</sup>
	1.8i 4x4	01.93-07.96	85			0 986 471 935	 60	1 987 470 034 <sup>7</sup>
						0 986 473 277	 60	1 987 470 034 <sup>7</sup>
						0 986 471 936	 60	1 987 470 034 <sup>7</sup>
	2.0i	01.93-07.96	100			0 986 473 078	 59,93	1 987 470 034 <sup>7</sup>
						0 986 474 078	 59,93	1 987 470 034 <sup>7</sup>
		07.93-07.96	97-100			0 986 473 078	 59,93	1 987 470 034 <sup>7</sup>
						0 986 474 078	 59,93	1 987 470 034 <sup>7</sup>



































									
									
	08.94-07.96		97-100			0986 471 935	← 60	1987 470 034 <sup>7</sup>	
						0986 473 277			
	08.94-07.96		125			0986 471 936	→ 60	1987 470 034 <sup>7</sup>	
						0986 471 935	← 60	1987 470 034 <sup>7</sup>	
						0986 473 277			
						0986 471 936	→ 60	1987 470 034 <sup>7</sup>	
									
	01.93-06.94		65/66			0986 475 750	↔ 20,6		
	07.94-07.96		65/66			0986 475 752	↔ 22,2		
	01.93-06.94		65/82/85			0986 475 750	↔ 20,6		
	07.94-07.96		65/82/85			0986 475 752	↔ 22,2		
	02.93-07.96		97-100			0986 475 750	↔ 20,6		
									
	01.93-07.96		65/66			0204 102 859	← 36		
						0986 473 281			
						0204 102 860	→ 36		
	01.93-07.96		65/82/85			0204 102 859	← 36		
						0986 473 281			
						0204 102 860	→ 36		
						0986 474 281			
						0986 474 281			
						0204 102 859	← 36		
						0986 473 281			
	01.93-07.96		97-100			0204 102 859	← 36		
						0986 473 281			
						0204 102 860	→ 36		
						0986 474 281			
	08.94-07.96		125			0204 102 859	← 36		
						0986 473 281			
						0204 102 860	→ 36		
						0986 474 281			
									
	01.93-08.94		65		4SB	1987 477 836	↔ 1462		
	01.93-07.96		65		STB	1987 477 521	↔ 1611		
			66		STB	1987 477 521	↔ 1611		
	05.93-07.96		65			1987 477 631	270		
			66			1987 477 631	270		
	09.94-07.96		65		4SB	1987 477 836	1462		
			66		4SB	1987 477 836	1462		
		01.93-08.94		65/82/85		4SB	1987 477 836	↔ 1462	
		01.93-07.96		65/82/85		STB	1987 477 521	↔ 1611	
		09.94-07.96		65/82/85		4SB	1987 477 836	1462	
		05.93-07.96		65/82/85			1987 477 631	270	
		01.93-08.94		65/82/85		4SB	1987 477 836	↔ 1462	
01.93-07.96		65/82/85		STB	1987 477 521	↔ 1611			
09.94-07.96		65/82/85		4SB	1987 477 836	1462			
	06.93-08.94		65/82/85		4SB	1987 477 836	↔ 1462		
	06.93-07.96		65/82/85		STB	1987 477 521	↔ 1611		
	09.94-07.96		65/82/85		4SB	1987 477 836	1462		
	01.93-08.94		97-100		4SB	1987 477 836	↔ 1462		
	01.93-07.96		97-100		STB	1987 477 521	↔ 1611		
	09.94-07.96		97-100		4SB	1987 477 836	1462		
	05.93-07.96		97-100			1987 477 631	270		
	07.93-07.96		97-100		STB	1987 477 521	↔ 1611		
	09.94-07.96		97-100		4SB	1987 477 836	1462		
	08.94-07.96		125			1987 477 631	270		
					STB	1987 477 521	↔ 1611		
		09.94-07.96		125	4SB	1987 477 836	1462		

		S							
<b>Mondeo I [97]</b>									
									
	1.6i	08.98-09.00	70						1987 470 034 <sup>7</sup> 1987 470 506 <sup>8</sup>
									
	1.6i	08.98-09.00	70				0 986 475 752	↔ 22,2	
	1.6i	08.98-09.00	70				0 204 102 859 0 986 473 281	← 36	
							0 204 102 860 0 986 474 281	→ 36	
									
	1.6i	08.98-08.98 08.98-09.00	70 70		STB 4SB		1 987 477 521 1 987 477 631 1 987 477 836	↔ 1611 270 1462	
<b>Mondeo II Turnier [97]</b>									
									
	1.6i	08.96-09.00	65-66/70						1 987 470 034 <sup>7</sup> 1 987 470 506 <sup>8</sup>
	1.8i	08.96-09.00	85						1 987 470 034 <sup>7</sup> 1 987 470 506 <sup>8</sup>
					15Z		0 986 471 935	← 60	1 987 470 034 <sup>7</sup> 1 987 470 506 <sup>8</sup>
							0 986 471 936	→ 60	1 987 470 034 <sup>7</sup>
	1.8TD	08.96-09.00	66						1 987 470 034 <sup>7</sup> 1 987 470 506 <sup>8</sup>
	2.0i	08.96-09.00	96						1 987 470 034 <sup>7</sup> 1 987 470 506 <sup>8</sup>
					15Z		0 986 471 935	← 60	1 987 470 034 <sup>7</sup> 1 987 470 506 <sup>8</sup>
							0 986 471 936	→ 60	1 987 470 034 <sup>7</sup>
	2.5i	08.96-12.97	125				0 986 471 935	← 60	1 987 470 034 <sup>7</sup> 1 987 470 506 <sup>8</sup>
							0 986 471 936	→ 60	1 987 470 034 <sup>7</sup>
									
	1.6i	08.96-09.00	65-66/70				0 986 475 751	↔ 22,2	
	1.8i, TD	08.96-09.00	66/85				0 986 475 751	↔ 22,2	
	2.0i	08.96-09.00	96				0 986 475 751	↔ 22,2	
	2.5i, iST200	08.96-09.00	125/151				0 986 475 751	↔ 22,2	
	1.6i	08.96-09.00	65-66/70				0 204 102 864 0 204 103 864	← 36	
							0 204 102 865 0 204 103 865	→ 36	
	1.8i	08.96-09.00	66/85				0 204 102 864	← 36	
	1.8TD						0 204 103 864	↔	
							0 204 102 865 0 204 103 865	→ 36	
	2.0i	08.96-09.00	96				0 204 102 864 0 204 103 864	← 36	
							0 204 102 865 0 204 103 865	→ 36	



		S							
	◀ FORD Mondeo II Turnier [97]								
	2.5 i	08.96-09.00	125/151				0 204 102 864	← 36	
	2.5 iST200						0 204 103 864		
							0 204 102 865	→ 36	
							0 204 103 865		
	1.6 i	08.96-09.97	65-66		STB		1 987 477 521	↔ 1611	
		08.96-08.98	65-66				1 987 477 631	270	
		08.98-09.00	70				1 987 477 631	270	
	1.8 i	08.96-09.97	66/85		STB		1 987 477 521	↔ 1611	
	1.8 i, TD	08.96-09.00	66/85				1 987 477 631	270	
	1.8 TD	08.96-09.97	66/85		STB		1 987 477 521	↔ 1611	
	2.0 i	08.96-09.97	96		STB		1 987 477 521	↔ 1611	
		08.96-09.00	96				1 987 477 631	270	
	2.5 i	08.96-09.97	125		STB		1 987 477 521	↔ 1611	
		08.96-09.00	125				1 987 477 631	270	
	2.5 iST200	09.99-09.00	151				1 987 477 631	270	
	<b>Mondeo II [97]</b>								
	1.6 i	08.96-08.98	65-66						1 987 470 034 <sup>7</sup>
									1 987 470 506 <sup>8</sup>
		08.98-09.00	70						1 987 470 034 <sup>7</sup>
									1 987 470 506 <sup>8</sup>
	1.8 i	08.96-09.00	85						1 987 470 034 <sup>7</sup>
									1 987 470 506 <sup>8</sup>
	1.8 TD	08.96-09.00	65-66						1 987 470 034 <sup>7</sup>
									1 987 470 506 <sup>8</sup>
	2.0 i	08.96-09.00	96						1 987 470 034 <sup>7</sup>
									1 987 470 506 <sup>8</sup>
	2.5 i	08.96-12.97	125				0 986 471 935	← 60	1 987 470 034 <sup>7</sup>
									1 987 470 506 <sup>8</sup>
							0 986 471 936	→ 60	1 987 470 034 <sup>7</sup>
		01.98-09.00	125						1 987 470 034 <sup>7</sup>
									1 987 470 506 <sup>8</sup>
	2.5 iST200	09.99-09.00	151						1 987 470 034 <sup>7</sup>
									1 987 470 506 <sup>8</sup>
	1.6 i	08.96-09.00	65-66/70				0 986 475 752	↔ 22,2	
	1.8 i, TD	08.96-09.00	65-66/85				0 986 475 752	↔ 22,2	
	2.0 i	08.96-09.00	96				0 986 475 750	↔ 20,6	
	1.6 i	08.96-09.00	65-66/70				0 204 102 859	← 36	
							0 986 473 281		
							0 204 102 860	→ 36	
							0 986 474 281		
	1.8 i	08.96-09.00	65-66/85				0 204 102 859	← 36	
	1.8 TD						0 986 473 281		
							0 204 102 860	→ 36	
							0 986 474 281		
	2.0 i	08.96-09.00	96				0 204 102 859	← 36	
							0 986 473 281		
							0 204 102 860	→ 36	
							0 986 474 281		
	2.5 i	08.96-09.00	125/151				0 204 102 859	← 36	
	2.5 iST200						0 986 473 281		
							0 204 102 860	→ 36	
							0 986 474 281		

		S								
										
	1.6i	08.96-08.98	65-66/70			STB	1 987 477 521	↔ 1611		
		08.96-09.00	65-66/70				1 987 477 631	270		
						4SB	1 987 477 836	1462		
	1.8i	08.96-08.98	65-66/85			STB	1 987 477 521	↔ 1611		
	1.8i	08.96-09.00	65-66/85				1 987 477 631	270		
	1.8TD					4SB	1 987 477 836	1462		
	1.8TD	08.96-08.98	65-66/85			STB	1 987 477 521	↔ 1611		
	2.0i	08.96-08.98	96			STB	1 987 477 521	↔ 1611		
		08.96-09.00	96				1 987 477 631	270		
						4SB	1 987 477 836	1462		
	2.5i	08.96-08.98	125			STB	1 987 477 521	↔ 1611		
		08.96-09.00	125				1 987 477 631	270		
						4SB	1 987 477 836	1462		
	2.5i ST200	09.99-09.00	151				1 987 477 631	270		
					4SB	1 987 477 836	1462			
<b>Mondeo III Turnier [01]</b>										
										
	1.8i	10.00-03.07	81/92/96				0 204 001 957	← 57	0 204 104 259 <sup>7</sup>	
							0 986 473 167		0 204 104 261 <sup>8</sup>	
							0 204 001 958	→ 57	0 204 104 259 <sup>7</sup>	
							0 986 474 167			
	2.0i	10.00-03.07	66/85/96/107				0 204 001 957	← 57	0 204 104 259 <sup>7</sup>	
							0 986 473 167		0 204 104 261 <sup>8</sup>	
	2.0TDCi						0 204 001 958	→ 57	0 204 104 259 <sup>7</sup>	
	2.0TDDi						0 986 474 167			
	2.2TDCi	08.04-03.07	110-114				0 204 001 957	← 57	0 204 104 259 <sup>7</sup>	
							0 986 473 167		0 204 104 261 <sup>8</sup>	
							0 204 001 958	→ 57	0 204 104 259 <sup>7</sup>	
							0 986 474 167			
	2.5i	10.00-03.07	125				0 204 001 957	← 57	0 204 104 259 <sup>7</sup>	
							0 986 473 167		0 204 104 261 <sup>8</sup>	
							0 204 001 958	→ 57	0 204 104 259 <sup>7</sup>	
							0 986 474 167			
	3.0i	02.02-03.07	150/166				0 204 001 957	← 57	0 204 104 259 <sup>7</sup>	
							0 986 473 167		0 204 104 261 <sup>8</sup>	
						0 204 001 958	→ 57	0 204 104 259 <sup>7</sup>		
						0 986 474 167				
										
	1.8i	10.00-09.04	81/92/96				0 204 004 552	← 38	0 204 104 261 <sup>8</sup>	
							0 986 473 284			
							0 204 004 553	→ 38	0 204 104 261 <sup>8</sup>	
							0 986 474 284			
			10.04-03.07	81/92/96				0 204 004 380	← 38	0 204 104 281 <sup>7</sup>
								0 986 134 021		
								0 204 004 381	→ 38	0 204 104 281 <sup>7</sup>
								0 986 135 021		
	2.0i	10.00-09.04	66/85/96/107				0 204 004 552	← 38	0 204 104 261 <sup>8</sup>	
							0 986 473 284			
								0 204 004 553	→ 38	0 204 104 261 <sup>8</sup>
								0 986 474 284		
			10.04-03.07	66/85/96/107				0 204 004 380	← 38	0 204 104 281 <sup>7</sup>
								0 986 134 021		
						0 204 004 381	→ 38	0 204 104 281 <sup>7</sup>		
						0 986 135 021				





		S								
◀ FORD Mondeo III Turnier [01]										
2.2 TDCi	10.04-03.07	110-114	0 204 004 380		← 38	0 204 104 281 <sup>7</sup>				
			0 986 134 021							
			0 204 004 381		→ 38	0 204 104 281 <sup>7</sup>				
			0 986 135 021							
2.5 i	10.00-09.04	125	0 204 004 552		← 38	0 204 104 261 <sup>8</sup>				
			0 986 473 284							
	10.04-03.07	125	0 204 004 553		→ 38	0 204 104 261 <sup>8</sup>				
			0 986 474 284							
3.0 i	10.04-03.07	150	0 204 004 380		← 38	0 204 104 281 <sup>7</sup>				
			0 986 134 021							
			0 204 004 381		→ 38	0 204 104 281 <sup>7</sup>				
3.0 i ST220	02.02-09.04	166	0 204 004 552		← 38	0 204 104 261 <sup>8</sup>				
			0 986 473 284							
	10.04-03.07	166	0 204 004 553		→ 38	0 204 104 261 <sup>8</sup>				
0 986 474 284										
0 204 004 380			← 38	0 204 104 281 <sup>7</sup>						
			0 986 134 021							
			0 204 004 381		→ 38	0 204 104 281 <sup>7</sup>				
			0 986 135 021							
	1.8 i	10.00-03.07	81/92/96	1 987 477 733		↔ 1722				
				0 986 134 021		306				
	2.0 i	10.00-03.07	66/85/96/107	1 987 477 733		↔ 1722				
				0 986 135 021		306				
	2.0 i, TDCi, TDDi	09.02-03.07	66/85/96/107	1 987 477 990		↔ 1722				
				0 986 135 021		306				
	2.0 TDCi	10.01-03.07	66/85/96/107	1 987 477 733		↔ 1722				
				0 986 135 021		306				
	2.0 TDDi	10.00-03.07	66/85/96/107	1 987 477 733		↔ 1722				
				0 986 135 021		306				
	2.2 TDCi	08.04-03.07	110-114	1 987 477 733		↔ 1722				
				0 986 135 021		306				
	2.5 i	10.00-03.07	125	1 987 477 733		↔ 1722				
0 986 135 021				306						
3.0 i	08.04-03.07	150/166	1 987 477 733		↔ 1722					
			0 986 135 021		306					
3.0 i ST220	02.02-03.07	150/166	1 987 477 733		↔ 1722					
			0 986 135 021		306					
3.0 i, i ST220	09.02-03.07	150/166	1 987 477 990		↔ 1722					
			0 986 135 021		306					
	1.8 i	10.00-03.07	81/92/96	0 265 007 879						
				0 986 134 021						
				0 265 007 879						
				0 265 007 879						
				0 265 007 879						
2.0 i, TDCi, TDDi	10.00-03.07	66/85/96/107	0 265 007 879							
			0 986 135 021							
2.2 TDCi	08.04-03.07	110-114	0 265 007 879							
			0 986 135 021							
2.5 i	10.00-03.07	125	0 265 007 879							
			0 986 135 021							
3.0 i, i ST220	02.02-03.07	150/166	0 265 007 879							
			0 986 135 021							
<b>Mondeo III [01]</b>										
	1.8 i	10.00-03.07	81/92/96	0 204 001 957		← 57	0 204 104 259 <sup>7</sup>			
				0 986 473 167			0 204 104 261 <sup>8</sup>			
				0 204 001 958		→ 57	0 204 104 259 <sup>7</sup>			
	2.0 i	10.00-03.07	66/85/96/107	0 204 001 957		← 57	0 204 104 259 <sup>7</sup>			
				0 986 473 167			0 204 104 261 <sup>8</sup>			
				0 204 001 958		→ 57	0 204 104 259 <sup>7</sup>			
	2.0 TDCi		107	0 986 474 167						
				0 204 001 957		← 57	0 204 104 259 <sup>7</sup>			
	2.0 TDDi			0 204 001 958		→ 57	0 204 104 259 <sup>7</sup>			
				0 986 474 167						
				0 204 001 957		← 57	0 204 104 259 <sup>7</sup>			
2.2 TDCi	08.04-03.07	110-114	0 204 001 957		← 57	0 204 104 259 <sup>7</sup>				
			0 986 473 167			0 204 104 261 <sup>8</sup>				
			0 204 001 958		→ 57	0 204 104 259 <sup>7</sup>				
			0 986 474 167							
			0 204 001 957		← 57	0 204 104 259 <sup>7</sup>				
			0 986 473 167			0 204 104 261 <sup>8</sup>				
			0 204 001 958		→ 57	0 204 104 259 <sup>7</sup>				
			0 986 474 167							
			0 204 001 957		← 57	0 204 104 259 <sup>7</sup>				

		S							
2.5i		10.00-03.07	125				0 204 001 957 0 986 473 167	← 57 	0 204 104 259 <sup>7</sup> 0 204 104 261 <sup>8</sup>
							0 204 001 958 0 986 474 167	→ 57 	0 204 104 259 <sup>7</sup>
3.0i 3.0iST220		02.02-03.07	150/166				0 204 001 957 0 986 473 167	← 57 	0 204 104 259 <sup>7</sup> 0 204 104 261 <sup>8</sup>
							0 204 001 958 0 986 474 167	→ 57 	0 204 104 259 <sup>7</sup>
1.8i		10.00-09.04	81/92/96				0 204 004 550 0 204 103 977 0 986 134 094	← 38  	0 204 104 261 <sup>8</sup>
							0 204 004 551 0 204 103 978 0 986 135 094	→ 38  	0 204 104 261 <sup>8</sup>
		10.04-03.07	81/92/96				0 204 004 378 0 986 473 300	← 38 	0 204 104 281 <sup>7</sup>
							0 204 004 379 0 986 474 300	→ 38 	0 204 104 281 <sup>7</sup>
2.0i 2.0TDCi 2.0TDDi		10.00-09.04	66/85/96/ 107				0 204 004 550 0 204 103 977 0 986 134 094	← 38  	0 204 104 261 <sup>8</sup>
							0 204 004 551 0 204 103 978 0 986 135 094	→ 38  	0 204 104 261 <sup>8</sup>
		10.04-03.07	66/85/96/ 107				0 204 004 378 0 986 473 300	← 38 	0 204 104 281 <sup>7</sup>
							0 204 004 379 0 986 474 300	→ 38 	0 204 104 281 <sup>7</sup>
2.2TDCi		08.04-09.04	110-114				0 204 004 550 0 204 103 977 0 986 134 094	← 38  	0 204 104 261 <sup>8</sup>
							0 204 004 551 0 204 103 978 0 986 135 094	→ 38  	0 204 104 261 <sup>8</sup>
		10.04-03.07	110-114				0 204 004 378 0 986 473 300	← 38 	0 204 104 281 <sup>7</sup>
							0 204 004 379 0 986 474 300	→ 38 	0 204 104 281 <sup>7</sup>
2.5i		10.00-09.04	125				0 204 004 550 0 204 103 977 0 986 134 094	← 38  	0 204 104 261 <sup>8</sup>
							0 204 004 551 0 204 103 978 0 986 135 094	→ 38  	0 204 104 261 <sup>8</sup>
		10.04-03.07	125				0 204 004 378 0 986 473 300	← 38 	0 204 104 281 <sup>7</sup>
							0 204 004 379 0 986 474 300	→ 38 	0 204 104 281 <sup>7</sup>
3.0i 3.0iST220		02.02-09.04	150/166				0 204 004 550 0 204 103 977 0 986 134 094	← 38  	0 204 104 261 <sup>8</sup>
							0 204 004 551 0 204 103 978 0 986 135 094	→ 38  	0 204 104 261 <sup>8</sup>
		10.04-03.07	150/166				0 204 004 378 0 986 473 300	← 38 	0 204 104 281 <sup>7</sup>
							0 204 004 379 0 986 474 300	→ 38 	0 204 104 281 <sup>7</sup>



		S				?			
◀ FORD Mondeo III [01]									
	1.8 i	10.00-03.07	81/92/96				1987 477 734	↔ 1735	
		09.02-03.07	81/92/96				1987 477 990	306	
	2.0 i	10.00-03.07	66/85/96/107				1987 477 734	↔ 1735	
	2.0 i, TDCi, TDDi	09.02-03.07	66/85/96/107				1987 477 990	306	
	2.0 TDCi	10.01-03.07	66/85/96/107				1987 477 734	↔ 1735	
	2.0 TDDi	10.00-03.07	66/85/96/107				1987 477 734	↔ 1735	
	2.2 TDCi	08.04-03.07	110-114				1987 477 734	↔ 1735	
							1987 477 990	306	
	2.5 i	10.00-03.07	125				1987 477 734	↔ 1735	
		09.02-03.07	125				1987 477 990	306	
3.0 i	08.04-03.07	150/166				1987 477 734	↔ 1735		
3.0 i ST220	02.02-03.07	150/166				1987 477 734	↔ 1735		
3.0 i, i ST220	09.02-03.07	150/166				1987 477 990	306		
	1.8 i	10.00-03.07	81/92/96				0265 007 879		
	2.0 i, TDCi, TDDi	10.00-03.07	66/85/96/107				0265 007 879		
	2.2 TDCi	08.04-03.07	110-114				0265 007 879		
	2.5 i	10.00-03.07	125				0265 007 879		
	3.0 i, i ST220	02.02-03.07	150/166				0265 007 879		
Mondeo IV Turnier [07]									
	1.6 EcoBoost, TDCi, Ti-VCT	02.07→	81/85/88/92/118						1987 470 506 <sup>8</sup>
	1.8 TDCi, TDCi eco	02.07-11.10	74/92						1987 470 506 <sup>8</sup>
	2.0, EcoBoost SCTi, Flexifuel, LPG, TDCi, TDCi eco	02.07→	85/96/100/103/104-107/ 120/146-149/176,5						1987 470 506 <sup>8</sup>
	2.2 TDCi	03.08→	129/147						1987 470 506 <sup>8</sup>
	2.3	09.07→	118						1987 470 506 <sup>8</sup>
	2.5	02.07-03.10	162						1987 470 506 <sup>8</sup>
	1.6 EcoBoost, TDCi, Ti-VCT	02.07→	81/85/88/92/118				0986 134 430	← 38	
	1.8 TDCi, TDCi eco	02.07-11.10	74/92				0986 134 430	← 38	
	2.0, EcoBoost SCTi, Flexifuel, LPG, TDCi, TDCi eco	02.07→	85/96/100/103/104-107/ 120/146-149/176,5				0986 134 430	← 38	
	2.2 TDCi	03.08→	129/147				0986 134 430	← 38	
	2.3	09.07→	118				0986 134 430	← 38	
	2.5	02.07-03.10	162				0986 134 430	← 38	
	1.6 EcoBoost, TDCi, Ti-VCT	02.07→	81/85/88/92/118				1987 482 242	→ 2071	
	1.8 TDCi, TDCi eco	02.07-11.10	74/92				1987 482 242	→ 2071	
	2.0, EcoBoost SCTi, Flexifuel, LPG, TDCi, TDCi eco	02.07→	85/96/100/103/104-107/ 120/146-149/176,5				1987 482 242	→ 2071	
	2.2 TDCi	03.08→	129/147				1987 482 242	→ 2071	
	2.3	09.07→	118				1987 482 242	→ 2071	
	2.5	02.07-03.10	162				1987 482 242	→ 2071	
	1.6 EcoBoost	11.10→	118				0986 594 554 <sup>4</sup>		
							0986 594 555 <sup>3</sup>		
	1.6 TDCi	09.10→	85/88				0986 594 554 <sup>4</sup>		
	1.6 Ti-VCT						0986 594 555 <sup>3</sup>		
	1.6 Ti-VCT	02.07-08.10	81				0986 594 554 <sup>4</sup>		
		01.08-08.10	92				0986 594 554 <sup>4</sup>		
	MFD 02.07-12.07	81/92					0986 594 555 <sup>3</sup>		

		S							
<b>1.6</b> Ti-VCT	OFD	02.07-12.07	81				0 986 594 555 <sup>3</sup>		
			92				0 986 594 555 <sup>3</sup>		
<b>1.8</b> TDCi		02.07-11.10	74				0 986 594 554 <sup>4</sup>		
		01.08-11.10	74				0 986 594 555 <sup>3</sup>		
			92				0 986 594 555 <sup>3</sup>		
	OFD	02.07-12.07	74				0 986 594 555 <sup>3</sup>		
			92				0 986 594 555 <sup>3</sup>		
<b>1.8</b> TDCi eco		01.08-11.10	92				0 986 594 555 <sup>3</sup>		
	OFD	02.07-12.07	92				0 986 594 555 <sup>3</sup>		
<b>1.8</b> TDCi		02.07-11.10	92				0 986 594 554 <sup>4</sup>		
<b>1.8</b> TDCi eco	MFD	02.07-12.07	74/92				0 986 594 556 <sup>3</sup>		
<b>2.0</b>		01.08→	107				0 986 594 555 <sup>3</sup>		
	OFD	02.07-12.07	107				0 986 594 555 <sup>3</sup>		
<b>2.0</b> , Flexifuel		02.07→	107				0 986 594 554 <sup>4</sup>		
<b>2.0</b> , TDCi	MFD	02.07-12.07	85/96/103/107				0 986 594 556 <sup>3</sup>		
<b>2.0</b> EcoBoost SCTi		03.10→	120/146-149/				0 986 594 554 <sup>4</sup>		
<b>2.0</b> TDCi			176,5				0 986 594 555 <sup>3</sup>		
<b>2.0</b> Flexifuel		02.08→	107				0 986 594 555 <sup>3</sup>		
<b>2.0</b> LPG		04.09→	104-107				0 986 594 554 <sup>4</sup>		
							0 986 594 555 <sup>3</sup>		
<b>2.0</b> TDCi		02.07-02.10	96				0 986 594 554 <sup>4</sup>		
		02.07→	103				0 986 594 554 <sup>4</sup>		
		01.08-02.10	96				0 986 594 555 <sup>3</sup>		
		01.08→	85				0 986 594 555 <sup>3</sup>		
			103				0 986 594 555 <sup>3</sup>		
		09.08→	100				0 986 594 554 <sup>4</sup>		
							0 986 594 555 <sup>3</sup>		
	OFD	02.07-12.07	96				0 986 594 555 <sup>3</sup>		
			103				0 986 594 555 <sup>3</sup>		
		11.07-12.07	85				0 986 594 555 <sup>3</sup>		
<b>2.0</b> TDCi eco		09.08→	85				0 986 594 555 <sup>3</sup>		
<b>2.0</b> TDCi, TDCi eco		11.07→	85				0 986 594 554 <sup>4</sup>		
<b>2.2</b> TDCi		03.08→	129/147				0 986 594 554 <sup>4</sup>		
							0 986 594 555 <sup>3</sup>		
<b>2.3</b>		09.07→	118				0 986 594 554 <sup>4</sup>		
		01.08→	118				0 986 594 555 <sup>3</sup>		
	MFD	09.07-12.07	118				0 986 594 556 <sup>3</sup>		
	OFD	09.07-12.07	118				0 986 594 555 <sup>3</sup>		
<b>2.5</b>		02.07-03.10	162				0 986 594 554 <sup>4</sup>		
		01.08-03.10	162				0 986 594 555 <sup>3</sup>		
	OFD	02.07-12.07	162				0 986 594 555 <sup>3</sup>		

**Mondeo IV [07]**

	<b>1.6</b> EcoBoost, TDCi, Ti-VCT	02.07→	81/85/88/92/118				1 987 470 506 <sup>8</sup>	
	<b>1.8</b> TDCi, TDCi eco	02.07-11.10	74/92				1 987 470 506 <sup>8</sup>	
	<b>2.0</b> , EcoBoost SCTi, Flexifuel, LPG, TDCi, TDCi eco	02.07→	85/96/100/103/104-107/ 120/146-149/176,5				1 987 470 506 <sup>8</sup>	
	<b>2.2</b> TDCi	03.08→	129/147				1 987 470 506 <sup>8</sup>	
	<b>2.3</b>	09.07→	118				1 987 470 506 <sup>8</sup>	
	<b>2.5</b>	02.07-03.10	162				1 987 470 506 <sup>8</sup>	
	<b>1.6</b> EcoBoost, TDCi, Ti-VCT	02.07→	81/85/88/92/118			0 986 134 430	← 38	
	<b>1.8</b> TDCi, TDCi eco	02.07-11.10	74/92			0 986 134 430	← 38	
	<b>2.0</b> , EcoBoost SCTi, Flexifuel, LPG, TDCi, TDCi eco	02.07→	85/96/100/103/104-107/ 120/146-149/176,5			0 986 134 430	← 38	
	<b>2.2</b> TDCi	03.08→	129/147			0 986 134 430	← 38	
	<b>2.3</b>	09.07→	118			0 986 134 430	← 38	
	<b>2.5</b>	02.07-03.10	162			0 986 134 430	← 38	



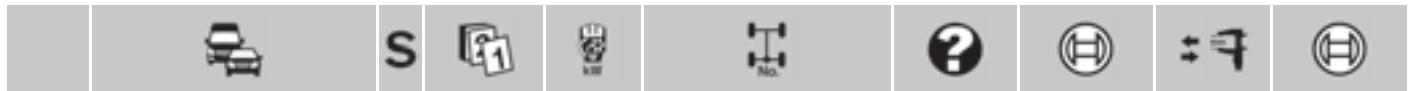

◀ FORD Mondeo IV [07]



	1.6 EcoBoost, TDCi, Ti-VCT	02.07→	81/85/88/92/118	1987	<b>482 242</b>	→ 2071
	1.8 TDCi, TDCi eco	02.07-11.10	74/92	1987	<b>482 242</b>	→ 2071
	2.0, EcoBoost SCTi, Flexifuel, LPG, TDCi, TDCi eco	02.07→	85/96/100/103/104-107/ 120/146-149/176,5	1987	<b>482 242</b>	→ 2071
	2.2 TDCi	03.08→	129/147	1987	<b>482 242</b>	→ 2071
	2.3	09.07→	118	1987	<b>482 242</b>	→ 2071
2.5	02.07-03.10	162	1987	<b>482 242</b>	→ 2071	
	1.6 EcoBoost	11.10→	118	0986	<b>594 554</b> <sup>4</sup>	
				0986	<b>594 555</b> <sup>3</sup>	
	1.6 TDCi	09.10→	85/88	0986	<b>594 554</b> <sup>4</sup>	
	1.6 Ti-VCT			0986	<b>594 555</b> <sup>3</sup>	
	1.6 Ti-VCT	02.07-08.10	81	0986	<b>594 554</b> <sup>4</sup>	
			92	0986	<b>594 554</b> <sup>4</sup>	
		01.08-08.10	81	0986	<b>594 555</b> <sup>3</sup>	
			92	0986	<b>594 555</b> <sup>3</sup>	
		MFD 02.07-12.07	81/92	0986	<b>594 556</b> <sup>3</sup>	
		OFD 02.07-12.07	81	0986	<b>594 555</b> <sup>3</sup>	
	92		0986	<b>594 555</b> <sup>3</sup>		
	1.8 TDCi	02.07-11.10	74	0986	<b>594 554</b> <sup>4</sup>	
		01.08-11.10	74	0986	<b>594 555</b> <sup>3</sup>	
			92	0986	<b>594 555</b> <sup>3</sup>	
		OFD 02.07-12.07	74	0986	<b>594 555</b> <sup>3</sup>	
		92	0986	<b>594 555</b> <sup>3</sup>		
	1.8 TDCi eco	01.08-11.10	92	0986	<b>594 555</b> <sup>3</sup>	
		OFD 02.07-12.07	92	0986	<b>594 555</b> <sup>3</sup>	
	1.8 TDCi	02.07-11.10	92	0986	<b>594 554</b> <sup>4</sup>	
	1.8 TDCi eco	MFD 02.07-12.07	74/92	0986	<b>594 556</b> <sup>3</sup>	
	2.0	01.08→	107	0986	<b>594 555</b> <sup>3</sup>	
		OFD 02.07-12.07	107	0986	<b>594 555</b> <sup>3</sup>	
	2.0, Flexifuel	02.07→	107	0986	<b>594 554</b> <sup>4</sup>	
	2.0, TDCi	MFD 02.07-12.07	85/96/103/107	0986	<b>594 556</b> <sup>3</sup>	
	2.0 EcoBoost SCTi	03.10→	120/146-149/ 176,5	0986	<b>594 554</b> <sup>4</sup>	
	2.0 TDCi			0986	<b>594 555</b> <sup>3</sup>	
	2.0 Flexifuel	02.08→	107	0986	<b>594 555</b> <sup>3</sup>	
2.0 LPG	04.09→	104-107	0986	<b>594 554</b> <sup>4</sup>		
			0986	<b>594 555</b> <sup>3</sup>		
2.0 TDCi	02.07-02.10	96	0986	<b>594 554</b> <sup>4</sup>		
	02.07→	103	0986	<b>594 554</b> <sup>4</sup>		
	01.08-02.10	96	0986	<b>594 555</b> <sup>3</sup>		
	01.08→	85	0986	<b>594 555</b> <sup>3</sup>		
		103	0986	<b>594 555</b> <sup>3</sup>		
	09.08→	100	0986	<b>594 554</b> <sup>4</sup>		
			0986	<b>594 555</b> <sup>3</sup>		
	OFD 02.07-12.07	96	0986	<b>594 555</b> <sup>3</sup>		
103		0986	<b>594 555</b> <sup>3</sup>			
	11.07-12.07	85	0986	<b>594 555</b> <sup>3</sup>		
2.0 TDCi eco	09.08→	85	0986	<b>594 555</b> <sup>3</sup>		
2.0 TDCi, TDCi eco	11.07→	85	0986	<b>594 554</b> <sup>4</sup>		
2.2 TDCi	03.08→	129/147	0986	<b>594 554</b> <sup>4</sup>		
			0986	<b>594 555</b> <sup>3</sup>		
2.3	09.07→	118	0986	<b>594 554</b> <sup>4</sup>		
	01.08→	118	0986	<b>594 555</b> <sup>3</sup>		
	MFD 09.07-12.07	118	0986	<b>594 556</b> <sup>3</sup>		
	OFD 09.07-12.07	118	0986	<b>594 555</b> <sup>3</sup>		
2.5	02.07-03.10	162	0986	<b>594 554</b> <sup>4</sup>		
	01.08-03.10	162	0986	<b>594 555</b> <sup>3</sup>		
	OFD 02.07-12.07	162	0986	<b>594 555</b> <sup>3</sup>		





















































		S							
<b>Orion</b>									
	1.8i	03.94-10.97	66			BRB, 0 986 AB8 443 BSY 0 986 AB8 444		← →	
<b>Probe</b>									
	2.0i 16V 2.5i 24V	09.92-08.97 09.92-08.97	85-88 120			0 986 474 041 0 986 474 041		↻ → 30,2 ↻ → 30,2	
<b>Puma [ECT]</b>									
	1.4i	01.98-02.00 02.00-11.00	66 66		239	0 986 473 909 0 986 473 910 0 986 473 275 0 986 474 275		↻ ← 54 ↻ → 54 ↻ ← 54 ↻ → 54	1 987 470 506 <sup>B</sup> 1 987 470 506 <sup>B</sup> 1 987 470 506 <sup>B</sup> 1 987 470 506 <sup>B</sup>
	1.6i	08.00-12.01	75			0 986 473 275 0 986 474 275		↻ ← 54 ↻ → 54	1 987 470 506 <sup>B</sup> 1 987 470 506 <sup>B</sup>
	1.7i	06.97-02.00 02.00-12.01	92 92		239	0 986 473 909 0 986 473 910 0 986 473 275 0 986 474 275		↻ ← 54 ↻ → 54 ↻ ← 54 ↻ → 54	1 987 470 506 <sup>B</sup> 1 987 470 506 <sup>B</sup> 1 987 470 506 <sup>B</sup> 1 987 470 506 <sup>B</sup>
	1.4i 1.6i 1.7i	01.98-02.00 03.00-11.00 08.00-12.01 06.97-02.00 03.00-12.01	66 66 75 92 92			F 026 002 502 0 986 475 905 0 986 475 905 F 026 002 502 0 986 475 905		↔ 17,5 ↔ 19,05 ↔ 19,05 ↔ 17,5 ↔ 19,05	
	1.4i 1.6i 1.7i	01.98-11.00 02.98-11.00 08.00-11.00 08.00-12.01 06.97-12.01 02.98-11.00	66 66 75 75 92 92			1 987 477 301 1 987 477 517 1 987 477 517 1 987 477 301 1 987 477 301 1 987 477 517		1627 312 312 1627 1627 312	
	1.4i 1.6i 1.7i	01.98-11.00 08.00-12.01 06.97-12.01	66 75 92			0 986 594 023 <sup>3</sup> 0 986 594 023 <sup>3</sup> 0 986 594 023 <sup>3</sup>			
<b>Ranger</b>									
	2.3i 16V XLS 3.0D 3.0D Turbo	01.05-06.09 01.05-06.09 03.06→	100 120 115			0 986 AB8 458 0 986 AB8 459 0 986 AB8 458 0 986 AB8 459 F 026 A02 389		← → ← → ↔	
<b>Ranger [06]</b>									
	2.5 TDCI 3.0 TDCI 4x4	03.06-12.11 03.06-12.11	105 115			F 026 A02 389 F 026 A02 389		↔ ↔	



		S				?			
◀ FORD									
<b>Scorpio I Turnier [92]</b>									
	2.0 i	08.92-09.94	85/88-90						1987 470 034 <sup>7</sup> 1987 470 506 <sup>8</sup>
	2.4 i	08.92-09.94	92						1987 470 034 <sup>7</sup> 1987 470 506 <sup>8</sup>
	2.5 TD	08.93-09.94	85						1987 470 034 <sup>7</sup> 1987 470 506 <sup>8</sup>
	2.9 i	08.92-09.94	107						1987 470 034 <sup>7</sup> 1987 470 506 <sup>8</sup>
	2.0 i	02.92-09.94	85/88-90			0986 474 152	→ 42,79		
	2.4 i	02.92-09.94	92			0986 474 152	→ 42,79		
	2.5 TD	08.93-09.94	85			0986 474 152	→ 42,79		
	2.9 i, i 4x4, i 24V	02.92-09.94	107/143			0986 474 152	→ 42,79		
	2.0 i	02.92-09.94	85/88-90			1987 477 735	3760		
	2.4 i	02.92-09.94	92			1987 477 735	3760		
	2.5 TD	08.93-09.94	85			1987 477 735	3760		
	2.9 i, i 4x4, i 24V	02.92-09.94	107/143			1987 477 735	3760		
<b>Scorpio I [92]</b>									
	2.0 i	08.92-09.94	85						1987 470 034 <sup>7</sup> 1987 470 506 <sup>8</sup>
	2.4 i	08.92-09.94	92						1987 470 034 <sup>7</sup> 1987 470 506 <sup>8</sup>
	2.5 TD	08.92-09.94	68/85						1987 470 034 <sup>7</sup> 1987 470 506 <sup>8</sup>
	2.9 i	08.92-09.94	107						1987 470 034 <sup>7</sup> 1987 470 506 <sup>8</sup>
	2.9 i 4x4								
	2.9 i 24V	02.92-09.94	143			0986 474 152	→ 42,79		
						0986 474 152			
	2.0 i	02.92-09.94	85			1987 477 735	3760		
	2.4 i	02.92-09.94	92			1987 477 735	3760		
	2.5 TD	03.92-09.94	68/85			1987 477 735	3760		
	2.9 i, i 4x4, i 24V	02.92-09.94	107/143			1987 477 735	3760		
<b>Scorpio II Turnier [95]</b>									
	2.0 i	10.94-12.98	85/100			0986 473 078	← 59,93		1987 470 034 <sup>7</sup>
	2.0 i 16V					0986 474 078	→ 59,93		1987 470 034 <sup>7</sup>
	2.3 i 16V	05.96-12.98	108			0986 473 078	← 59,93		1987 470 034 <sup>7</sup>
						0986 474 078	→ 59,93		1987 470 034 <sup>7</sup>
	2.5 TD	10.94-12.98	85/92			0986 473 078	← 59,93		1987 470 034 <sup>7</sup>
						0986 474 078	→ 59,93		1987 470 034 <sup>7</sup>



								
								
2.9i	10.94-08.96	110				0 986 473 078	 59,93	1 987 470 034 <sup>7</sup>
						0 986 474 078	 59,93	1 987 470 034 <sup>7</sup>
2.9i 24V	01.95-07.98	152				0 986 471 935	 60	1 987 470 034 <sup>7</sup>
						0 986 473 277		
						0 986 471 936	 60	1 987 470 034 <sup>7</sup>
								
	2.0i	01.95-12.98	85/100			0 986 474 152	 42,79	
	2.0i 16V					0 986 474 152		
	2.3i 16V	05.96-12.98	108			0 986 474 152	 42,79	
						0 986 474 152		
	2.5 TD	01.95-12.98	85/92			0 986 474 152	 42,79	
						0 986 474 152		
	2.9i	01.95-07.98	110/152			0 986 474 152	 42,79	
	2.9i 24V					0 986 474 152		
								
	2.0i	10.94-01.96	85/100			1 987 477 735		3760
	2.0i 16V	02.96-12.98	85/100			1 987 477 731		3800
	2.3i 16V	05.96-12.98	108			1 987 477 731		3800
	2.5 TD	10.94-01.96	85			1 987 477 735		3760
		02.96-12.98	85			1 987 477 731		3800
		01.97-12.98	92			1 987 477 731		3800
	2.9i	10.94-01.96	110/152			1 987 477 735		3760
	2.9i 24V	02.96-07.98	110/152			1 987 477 731		3800
<b>Scorpio II [95]</b>								
								
	2.0i	10.94-12.98	85/100			0 986 473 078	 59,93	1 987 470 034 <sup>7</sup>
	2.0i 16V					0 986 474 078	 59,93	1 987 470 034 <sup>7</sup>
	2.3i 16V	05.96-12.98	108			0 986 473 078	 59,93	1 987 470 034 <sup>7</sup>
						0 986 474 078	 59,93	1 987 470 034 <sup>7</sup>
	2.5 TD	10.94-12.98	85/92			0 986 473 078	 59,93	1 987 470 034 <sup>7</sup>
						0 986 474 078	 59,93	1 987 470 034 <sup>7</sup>
	2.9i	10.94-08.96	110			0 986 473 078	 59,93	1 987 470 034 <sup>7</sup>
						0 986 474 078	 59,93	1 987 470 034 <sup>7</sup>
	2.9i 24V	01.95-07.98	152			0 986 471 935	 60	1 987 470 034 <sup>7</sup>
						0 986 473 277		
						0 986 471 936	 60	1 987 470 034 <sup>7</sup>
								
	2.9i 24V	01.95-07.98	152			0 986 474 152	 42,79	
						0 986 474 152		
								
	2.0i	10.94-01.96	85/100			1 987 477 735		3760
	2.0i 16V	02.96-12.98	85/100			1 987 477 731		3800
	2.3i 16V	05.96-12.98	108			1 987 477 731		3800
	2.5 TD	10.94-01.96	85/92			1 987 477 735		3760
		02.96-12.98	85/92			1 987 477 731		3800
	2.9i	10.94-01.96	110/152			1 987 477 735		3760
	2.9i 24V	02.96-07.98	110/152			1 987 477 731		3800
<b>Serie F</b>								
								
	100 3.6	02.83-08.97	76			0 986 AB8 446		
	250	01.01-12.11	175/194		STB	0 986 AB8 426		
						0 986 AB8 454		





		S							
	◀ FORD Serie F								
250 4x4		04.06-02.12	149			EZK	0 204 062 034	←	
							0 204 062 035	→	
						STB	0 986 AB8 426	→	
							0 986 AB8 454	←	
350		09.05-12.11	88				0 204 062 034	←	
							0 204 062 035	→	
							0 986 AB8 426	→	
							0 986 AB8 454	←	
1000 3.6		04.92-11.95	108				0 986 AB8 446	←	
<b>S-MAX [06]</b>									
	1.6 EcoBoost, TDCi	11.10→	85/118						1 987 470 506 <sup>8</sup>
	1.8 TDCi	03.06-03.10	74/92						1 987 470 506 <sup>8</sup>
	2.0, FlexiFuel, TDCi	03.06→	85/96/100/103/107/120						1 987 470 506 <sup>8</sup>
	2.0 EcoBoost SCTi	03.10→	147-149			TW			1 987 470 506 <sup>8</sup>
		09.10→	176						1 987 470 506 <sup>8</sup>
	2.2 TDCi	03.08-10.10	129						1 987 470 506 <sup>8</sup>
		11.10→	147						1 987 470 506 <sup>8</sup>
	2.3	09.07→	118						1 987 470 506 <sup>8</sup>
	2.5	03.06-03.10	162						1 987 470 506 <sup>8</sup>
	1.6 EcoBoost, TDCi	11.10→	85/118			FEB	0 986 134 430	← 38	
	1.8 TDCi	03.06-03.10	74/92			FEB	0 986 134 430	← 38	
	2.0, EcoBoost SCTi, FlexiFuel, TDCi	03.06→	85/96/100/103/107/120/ 147-149/176			FEB	0 986 134 430	← 38	
	2.2 TDCi	03.08→	129/147			FEB	0 986 134 430	← 38	
	2.3	09.07→	118			FEB	0 986 134 430	← 38	
	2.5	03.06-03.10	162			FEB	0 986 134 430	← 38	
	1.6 EcoBoost, TDCi	11.10→	85/118				1 987 482 242	→ 2071	
	1.8 TDCi	03.06-02.07	74/92				1 987 482 133	← 2070	
		03.07-03.10	74/92				1 987 482 134	→ 2067	
	2.0, FlexiFuel, TDCi	03.07→	103/107				1 987 482 242	→ 2071	
	2.0	03.06-02.07	103/107				1 987 482 133	← 2070	
	2.0 TDCi						1 987 482 134	→ 2067	
	2.0 EcoBoost SCTi, TDCi	03.10→	120/147-149/176				1 987 482 242	→ 2071	
	2.0 TDCi	03.06-02.07	96				1 987 482 133	← 2070	
							1 987 482 134	→ 2067	
		03.07-02.10	96				1 987 482 242	→ 2071	
		09.07→	85				1 987 482 242	→ 2071	
		09.08→	100				1 987 482 242	→ 2071	
	2.2 TDCi	03.08→	129/147				1 987 482 242	→ 2071	
	2.3	09.07→	118				1 987 482 242	→ 2071	
	2.5	03.06-02.07	162				1 987 482 133	← 2070	
							1 987 482 134	→ 2067	
		03.07-03.10	162				1 987 482 242	→ 2071	
	1.6 EcoBoost	11.10→	85/118				0 986 594 554 <sup>4</sup>		
	1.6 TDCi						0 986 594 555 <sup>3</sup>		
	1.8 TDCi	03.06-03.10	74/92				0 986 594 554 <sup>4</sup>		
							0 986 594 555 <sup>3</sup>		
	2.0, EcoBoost SCTi, FlexiFuel, TDCi	03.06→	85/96/100/103/107/ 120/147-149/176				0 986 594 554 <sup>4</sup>		
							0 986 594 555 <sup>3</sup>		
	2.2 TDCi	03.08→	129/147				0 986 594 554 <sup>4</sup>		
							0 986 594 555 <sup>3</sup>		

		S							
2.3		09.07→	118				0 986 594 554 <sup>4</sup>		
							0 986 594 555 <sup>3</sup>		
2.5		03.06-03.10	162				0 986 594 554 <sup>4</sup>		
							0 986 594 555 <sup>3</sup>		
<b>Streetka</b>									
	1.6 i	12.02-12.05	70				0 986 473 275	← 54	1 987 470 506 <sup>8</sup>
							0 986 474 275	→ 54	1 987 470 506 <sup>8</sup>
	1.6 i	12.02-12.05	70				0 986 475 926	↔ 19,05	
	1.6 i	12.02-06.03	70				1 987 477 301	1627	
		07.03-12.05	70				1 987 477 345	1640	
	1.6 i	12.02-08.04	70				0 986 594 024 <sup>3</sup>		
<b>Tourneo Connect [02]</b>									
	1.8 i, LPG, TDCi, TDDi	05.02-12.13	55/66-67/ 81-85						1 987 470 506 <sup>8</sup>
	1.8 i, LPG, TDCi, TDDi	05.02-12.13	55/66-67/ 81-85				0 986 475 927	↔ 20,64	
	1.8 i, LPG, TDCi, TDDi	05.02-12.13	55/66-67/ 81-85				0 986 473 418	← 36	
							0 986 474 418	→ 36	
	1.8 i, LPG, TDCi, TDDi	05.02-12.13	55/66-67/ 81-85				1 987 477 929	326	
	1.8 i	05.02-06.10	81-85				0 986 594 534 <sup>3</sup>		
	1.8 LPG						0 986 594 535 <sup>4</sup>		
	1.8 TDCi	08.06-09.12	66-67/81				0 986 594 535 <sup>4</sup>		
		08.06-12.13	66-67/81				0 986 594 534 <sup>3</sup>		
		10.12-12.13	66-67/81				0 986 594 554 <sup>4</sup>		
	1.8 TDCi	05.02-06.10	55/66				0 986 594 534 <sup>3</sup>		
	1.8 TDDi						0 986 594 535 <sup>4</sup>		
<b>Tourneo Connect [13]</b>									
	1.0 EcoBoost	09.13→	74				0 986 473 385	← 56,95	
							0 986 474 385	→ 56,95	
	1.5 TDCi	06.15→	74/88				0 986 473 385	← 56,95	
							0 986 474 385	→ 56,95	
	1.6 EcoBoost	09.13→	55/70/85/				0 986 473 385	← 56,95	
	1.6 TDCi		110-112				0 986 474 385	→ 56,95	



		S				?			
◀ FORD									
<b>Tourneo Courier</b>									
	1.0 EcoBoost	04.14→	74				0 265 009 534 <sup>3</sup>		
	1.5 TDCi	04.14→	56				0 265 009 534 <sup>3</sup>		
	1.6 TDCi	04.14→	70				0 265 009 534 <sup>3</sup>		
<b>Transit</b>									
	2.8 D	03.01-07.09	68		14Z		0 204 102 925	→ 42	0 204 100 277 <sup>8</sup>
							0 204 103 925		0 204 104 135 <sup>7</sup>
							0 204 102 926	← 42	0 204 100 277 <sup>8</sup>
							0 204 103 926		
					6LO		0 204 102 934	→ 42	0 204 104 135 <sup>7</sup>
							0 204 102 935	← 42	0 204 104 135 <sup>7</sup>
	2.8 D	03.01-07.09	68				1 987 477 369		2823
<b>Transit Connect</b>									
	1.6 TDCi	09.13→	55/70/85				0 986 473 385	← 56,95	
							0 986 474 385	→ 56,95	
<b>Transit Connect [02]</b>									
	1.8 i, LPG, TDCi, TDDi	05.02-12.13	55/66-67/ 81-85						1 987 470 506 <sup>8</sup>
	1.8 i, LPG, TDCi, TDDi	05.02-12.13	55/66-67/ 81-85				0 986 475 927	↔ 20,64	
	1.8 i, LPG, TDCi, TDDi	05.02-12.13	55/66-67/ 81-85				0 986 473 418	← 36	
							0 986 474 418	→ 36	
	1.8 i, LPG, TDCi, TDDi	05.02-12.13	55/66-67/ 81-85				1 987 477 929		326
	1.8 i	05.02-06.10	81-85				0 986 594 534 <sup>3</sup>		
	1.8 LPG						0 986 594 535 <sup>4</sup>		
	1.8 TDCi	05.02-06.10	66				0 986 594 534 <sup>3</sup>		
							0 986 594 535 <sup>4</sup>		
		08.06-09.12	66-67/81				0 986 594 535 <sup>4</sup>		
		08.06-12.13	66-67/81				0 986 594 534 <sup>3</sup>		
		10.12-12.13	55				0 986 594 554 <sup>4</sup>		
			66-67/81				0 986 594 554 <sup>4</sup>		
	1.8 TDCi	05.02-09.12	55				0 986 594 535 <sup>4</sup>		
	1.8 TDDi	05.02-12.13	55				0 986 594 534 <sup>3</sup>		

























F

		S							
<b>Transit Connect [13]</b>									
	1.0 EcoBoost	09.13→	74				0 986 473 385	← 56,95	
							0 986 474 385	→ 56,95	
	1.5 TDCi	06.15→	74/88				0 986 473 385	← 56,95	
							0 986 474 385	→ 56,95	
	1.6 EcoBoost	09.13→	110-112				0 986 473 385	← 56,95	
							0 986 474 385	→ 56,95	
<b>Transit Courier</b>									
	1.0 EcoBoost	04.14→	74				0 265 009 534 <sup>3</sup>		
	1.5 TDCi	04.14→	56/70				0 265 009 534 <sup>3</sup>		
<b>Transit Custom [13]</b>									
	FT 250 2.2 TDCi	09.12→	74						0 204 104 359 <sup>B</sup>
	FT 270 2.2 TDCi	09.12→	74/92/114						0 204 104 359 <sup>B</sup>
	FT 290 2.2 CDTi, 2.2 TDCi	09.12→	74/92/114						0 204 104 359 <sup>B</sup>
	FT 300 2.2 DTCi	09.12→	74/92/114						0 204 104 359 <sup>B</sup>
	FT 310 2.2 TDCi	09.12→	74/92/114						0 204 104 359 <sup>B</sup>
<b>Transit Euroline [00]</b>									
	2.0 TDCi	08.00-07.06	74/92				0 204 204 992	← 48	0 204 201 289 <sup>B</sup>
	2.0 TDE						0 986 473 272	→ 48	0 204 201 476
							0 204 204 993	↔ 25,4	0 204 201 289 <sup>B</sup>
							0 986 474 272		
	2.0 TDCi	08.00-07.06	74/92				F 026 002 578		
	2.0 TDE								
	2.0 TDCi	08.00-07.06	74/92				1 987 477 174	← 1547	
	2.0 TDE						1 987 482 036	→ 1283	
						LLE	1 987 477 186	1052	
						RLE	1 987 477 190	910	
	2.0 TDCi	07.03-07.06	74/92			LAB,TW	0 265 006 784 <sup>4</sup>		
						TW	0 265 006 784 <sup>3</sup>		
	2.0 TDCi	08.00-05.04	74/92			LAB,TW	0 265 006 818 <sup>4</sup>		
	2.0 TDE	08.00-07.06	74/92			RAB,TW	0 265 006 817 <sup>4</sup>		
						TW	0 265 006 458 <sup>3</sup>		
		11.03-05.04	74/92			RAB,TW	0 265 006 460 <sup>4</sup>		
		05.04-07.06	74/92			RAB,TW	0 265 006 811 <sup>4</sup>		
	2.0 TDE	07.03-07.06	74/92			LAB,TW	0 265 006 784 <sup>4</sup>		
						TW	0 265 006 784 <sup>3</sup>		
<b>Transit Euroline [06]</b>									
	2.2 TDCi	04.06-09.11	81/85/ 96-96/103				0 204 004 617	← 48	
							0 986 134 025	→ 48	
							0 204 004 618	↔ 48	
							0 986 135 025		



◀ FORD Transit Euroline [06]								
	2.2 TDCi	04.06-09.11	81/85/ 96-96/103			F 026 <b>002 578</b>	↔ 25,4	
	2.2 TDCi	04.06-09.11	81/85/ 96-96/103			0 204 <b>902 026</b> 0986 <b>134 027</b>	← 48	
						0 204 <b>902 027</b> 0986 <b>135 027</b>	→ 48	
	2.2 TDCi	04.06-09.11	81/85/ 96-96/103	TBR		1987 <b>477 174</b> 1987 <b>482 036</b>	← 1547 → 1283	
				4SB		1987 <b>482 277</b> 1987 <b>482 281</b>	← 1532 → 1266	
	2.2 TDCi	04.06-09.11	81/85/ 96-96/103	RAB		0 265 <b>007 878<sup>4</sup></b>		
Transit Euroline [12]								
	2.2 TDCi	09.11-12.13	92/103			0 204 <b>004 617</b> 0986 <b>134 025</b>	← 48	
						0 204 <b>004 618</b> 0986 <b>135 025</b>	→ 48	
	2.2 TDCi	09.11-12.13	92/103			0 204 <b>902 026</b> 0986 <b>134 027</b>	← 48	
						0 204 <b>902 027</b> 0986 <b>135 027</b>	→ 48	
	2.2 TDCi	09.11-12.13	92/103			1987 <b>482 277</b> 1987 <b>482 281</b>	← 1532 → 1266	
	2.2 TDCi	09.11-12.13	92/103	RAB		0 265 <b>007 878<sup>4</sup></b>		
Transit Euroline [95]								
	2.0 i	08.94-07.00	84	5LO		0 204 <b>102 925</b> 0 204 <b>103 925</b>	→ 42	0 204 <b>104 135<sup>7</sup></b>
						0 204 <b>102 926</b> 0 204 <b>103 926</b>	← 42	0 204 <b>104 135<sup>7</sup></b>
				6LO		0 204 <b>102 934</b> 0 204 <b>102 935</b>	→ 42	0 204 <b>104 135<sup>7</sup></b>
	2.5 D	08.94-08.00	51/56/63/ 85	5LO		0 204 <b>102 925</b> 0 204 <b>103 925</b>	→ 42	0 204 <b>104 135<sup>7</sup></b>
	2.5 DI					0 204 <b>102 926</b> 0 204 <b>103 926</b>	← 42	0 204 <b>104 135<sup>7</sup></b>
	2.5 TD					0 204 <b>102 926</b> 0 204 <b>103 926</b>	← 42	0 204 <b>104 135<sup>7</sup></b>
	2.5 TDI			6LO		0 204 <b>102 934</b> 0 204 <b>102 935</b>	→ 42	0 204 <b>104 135<sup>7</sup></b>
							← 42	0 204 <b>104 135<sup>7</sup></b>
	2.0 i	08.94-07.00	84			F 026 <b>002 171</b> F 026 <b>002 172</b>	↔ 20,6 ↔ 22,2	



		S							
	2.5 D, DI, TD, TDI	08.94-08.00	51/56/63/85				F 026 <b>002 171</b> F 026 <b>002 172</b>	↔ 20,6 ↔ 22,2	
									
	2.0i	08.94-07.00	84			OZB ZWB	1 987 <b>477 369</b> 1 987 <b>477 370</b>	2823 2730	
	2.5 D, DI, TD, TDI	08.94-08.00	51/56/63/85			OZB ZWB	1 987 <b>477 369</b> 1 987 <b>477 370</b>	2823 2730	
<b>Transit Nugget [00]</b>									
									
	2.0 TDCi 2.0 TDE	08.00-07.06	74/92				0 204 <b>204 992</b> 0 986 <b>473 272</b> 0 204 <b>204 993</b> 0 986 <b>474 272</b>	← 48 ↻ → 48 ↻	0 204 <b>201 289</b> <sup>B</sup> 0 204 <b>201 476</b> 0 204 <b>201 289</b> <sup>B</sup>
									
	2.0 TDCi 2.0 TDE	08.00-07.06	74/92				F 026 <b>002 578</b>	↔ 25,4	
									
	2.0 TDCi 2.0 TDE	08.00-07.06	74/92				1 987 <b>477 174</b> 1 987 <b>482 036</b> LLE 1 987 <b>477 186</b> RLE 1 987 <b>477 190</b>	← 1547 → 1283 1052 910	
	2.0 TDCi	07.03-07.06	74/92			LAB, TW TW	0 265 <b>006 784</b> <sup>4</sup> 0 265 <b>006 784</b> <sup>3</sup>		
	2.0 TDCi	08.00-05.04	74/92			LAB, TW	0 265 <b>006 818</b> <sup>4</sup>		
	2.0 TDE	08.00-07.06	74/92			RAB, TW TW	0 265 <b>006 817</b> <sup>4</sup> 0 265 <b>006 458</b> <sup>3</sup>		
		11.03-05.04	74/92			RAB, TW	0 265 <b>006 460</b> <sup>4</sup>		
		05.04-07.06	74/92			RAB, TW	0 265 <b>006 811</b> <sup>4</sup>		
	2.0 TDE	07.03-07.06	74/92			LAB, TW TW	0 265 <b>006 784</b> <sup>4</sup> 0 265 <b>006 784</b> <sup>3</sup>		
<b>Transit Nugget [06]</b>									
									
	2.2 TDCi	04.06-09.11	81/85/ 96-96/103				0 204 <b>004 617</b> 0 986 <b>134 025</b> 0 204 <b>004 618</b> 0 986 <b>135 025</b>	← 48 ↻ → 48 ↻	
									
	2.2 TDCi	04.06-09.11	81/85/ 96-96/103				F 026 <b>002 578</b>	↔ 25,4	
	2.2 TDCi	04.06-09.11	81/85/ 96-96/103				0 204 <b>902 026</b> 0 986 <b>134 027</b> 0 204 <b>902 027</b> 0 986 <b>135 027</b>	← 48 ↻ → 48 ↻	
									
	2.2 TDCi	04.06-09.11	81/85/ 96-96/103			TBR 4SB	1 987 <b>477 174</b> 1 987 <b>482 036</b> 1 987 <b>482 277</b> 1 987 <b>482 281</b>	← 1547 → 1283 ← 1532 → 1266	



◀ FORD Transit Nugget [06]								
	2.2 TDCi	04.06-09.11	81/85/ 96-96/103		RAB	0 265 007 878 <sup>4</sup>		
<b>Transit Nugget [12]</b>								
	2.2 TDCi	09.11-12.13	92/103			0 204 004 617 ← 48 0 986 134 025		
	2.2 TDCi	09.11-12.13	92/103			0 204 004 618 → 48 0 986 135 025		
	2.2 TDCi	09.11-12.13	92/103			0 204 902 026 ← 48 0 986 134 027		
	2.2 TDCi	09.11-12.13	92/103			0 204 902 027 → 48 0 986 135 027		
	2.2 TDCi	09.11-12.13	92/103			1 987 482 277 ← 1532 1 987 482 281 → 1266		
	2.2 TDCi	09.11-12.13	92/103		RAB	0 265 007 878 <sup>4</sup>		
<b>Transit Nugget [95]</b>								
	2.0 i	08.94-07.00	84		5LO	0 204 102 925 → 42 0 204 103 925	0 204 104 135 <sup>7</sup>	
	2.5 D	08.94-08.00	51/56/63/ 85		6LO	0 204 102 926 ← 42 0 204 103 926	0 204 104 135 <sup>7</sup>	
	2.5 DI				5LO	0 204 102 925 → 42 0 204 103 925	0 204 104 135 <sup>7</sup>	
	2.5 TD				6LO	0 204 102 926 ← 42 0 204 103 926	0 204 104 135 <sup>7</sup>	
	2.5 TDI				6LO	0 204 102 934 → 42 0 204 102 935 ← 42	0 204 104 135 <sup>7</sup> 0 204 104 135 <sup>7</sup>	
	2.0 i	08.94-07.00	84			F 026 002 171 ↔ 20,6 F 026 002 172 ↔ 22,2		
	2.5 D, DI, TD, TDI	08.94-08.00	51/56/63/ 85			F 026 002 171 ↔ 20,6 F 026 002 172 ↔ 22,2		
	2.0 i	08.94-07.00	84		OZB	1 987 477 369	2823	
	2.5 D, DI, TD, TDI	08.94-08.00	51/56/63/ 85		ZWB	1 987 477 370	2730	
	2.0 i	08.94-07.00	84		OZB	1 987 477 369	2823	
	2.5 D, DI, TD, TDI	08.94-08.00	51/56/63/ 85		ZWB	1 987 477 370	2730	
<b>Transit Tourneo Custom [13]</b>								
	2.2 TDCi	09.12→	74/92/114					0 204 104 359 <sup>8</sup>





		S							
<b>Transit Tourneo [00]</b>									
	2.0 TDCi 2.0 TDE	08.00-07.06	74/92				0 204 204 992 0 986 473 272 0 204 204 993 0 986 474 272	← 48  → 48 	0 204 201 289 <sup>B</sup> 0 204 201 476 0 204 201 289 <sup>B</sup>
	2.0 TDCi 2.0 TDE	08.00-07.06	74/92				F 026 002 578	↔ 25,4	
	2.0 TDCi 2.0 TDE	08.00-07.06	74/92				1 987 477 174 1 987 482 036 LLE 1 987 477 186 RLE 1 987 477 190	← 1547 → 1283 1052 910	
	2.0 TDCi	07.03-07.06	74/92		LAB,TW		0 265 006 784 <sup>4</sup>		
					TW		0 265 006 784 <sup>3</sup>		
	2.0 TDCi	08.00-05.04	74/92		LAB,TW		0 265 006 818 <sup>4</sup>		
	2.0 TDE	08.00-07.06	74/92		RAB,TW		0 265 006 817 <sup>4</sup>		
		11.03-05.04	74/92		TW		0 265 006 458 <sup>3</sup>		
		11.03-05.04	74/92		RAB,TW		0 265 006 460 <sup>4</sup>		
		05.04-07.06	74/92		RAB,TW		0 265 006 811 <sup>4</sup>		
	2.0 TDE	07.03-07.06	74/92		LAB,TW		0 265 006 784 <sup>4</sup>		
					TW		0 265 006 784 <sup>3</sup>		
<b>Transit Tourneo [06]</b>									
	2.2 TDCi	04.06-09.11	81/85/ 96-96/103				0 204 004 617 0 986 134 025 0 204 004 618 0 986 135 025	← 48  → 48 	
	2.2 TDCi	04.06-09.11	81/85/ 96-96/103				F 026 002 578	↔ 25,4	
	2.2 TDCi	04.06-09.11	81/85/ 96-96/103				0 204 902 026 0 986 134 027 0 204 902 027 0 986 135 027	← 48  → 48 	
	2.2 TDCi	04.06-09.11	81/85/ 96-96/103		TBR		1 987 477 174 1 987 482 036	← 1547 → 1283	
					4SB		1 987 482 277 1 987 482 281	← 1532 → 1266	
	2.2 TDCi	04.06-09.11	81/85/ 96-96/103		RAB		0 265 007 878 <sup>4</sup>		





		S							
◀ FORD									
<b>Transit Tourneo [12]</b>									
	2.2 TDCi	09.11-12.13	74/92/103				0 204 004 617	← 48	
							0 986 134 025		
							0 204 004 618	→ 48	
							0 986 135 025		
	2.2 TDCi	09.11-12.13	74/92/103				0 204 902 026	← 48	
							0 986 134 027		
							0 204 902 027	→ 48	
							0 986 135 027		
	2.2 TDCi	09.11-12.13	74/92/103				1 987 482 277	← 1532	
							1 987 482 281	→ 1266	
	2.2 TDCi	09.11-12.13	74/92/103		RAB		0 265 007 878 <sup>4</sup>		
<b>Transit Tourneo [95]</b>									
	2.0 i	08.94-07.00	84		5LO		0 204 102 925	→ 42	0 204 104 135 <sup>7</sup>
							0 204 103 925		
							0 204 102 926	← 42	0 204 104 135 <sup>7</sup>
							0 204 103 926		
					6LO		0 204 102 934	→ 42	0 204 104 135 <sup>7</sup>
							0 204 102 935	← 42	0 204 104 135 <sup>7</sup>
	2.5 D	08.94-08.00	51/56/63/		5LO		0 204 102 925	→ 42	0 204 104 135 <sup>7</sup>
	2.5 DI		85				0 204 103 925		
	2.5 TD						0 204 102 926	← 42	0 204 104 135 <sup>7</sup>
	2.5 TDI						0 204 103 926		
					6LO		0 204 102 934	→ 42	0 204 104 135 <sup>7</sup>
							0 204 102 935	← 42	0 204 104 135 <sup>7</sup>
	2.0 i	08.94-07.00	84				F 026 002 171	↔ 20,6	
							F 026 002 172	↔ 22,2	
	2.5 D, DI, TD, TDI	08.94-08.00	51/56/63/				F 026 002 171	↔ 20,6	
			85				F 026 002 172	↔ 22,2	
	2.0 i	08.94-07.00	84		OZB		1 987 477 369		2823
					ZWB		1 987 477 370		2730
	2.5 D, DI, TD, TDI	08.94-08.00	51/56/63/		OZB		1 987 477 369		2823
			85		ZWB		1 987 477 370		2730
<b>Transit [00]</b>									
	FT 240 K/S 2.0 TD	08.00-07.06	55/63				0 204 204 992	← 48	0 204 201 289 <sup>8</sup>
	FT 240 K/S 2.0 TDE						0 986 473 272		0 204 201 476
							0 204 204 993	→ 48	0 204 201 289 <sup>8</sup>
							0 986 474 272		
	FT 260 K/S 2.0 TD, 2.0 TDCi,	08.00-07.06	55/63/66/				0 204 204 992	← 48	0 204 201 289 <sup>8</sup>
	2.0 TDE, 2.3i, 2.4 TDE		74/92/				0 986 473 272		0 204 201 476
			103-107				0 204 204 993	→ 48	0 204 201 289 <sup>8</sup>
							0 986 474 272		



								
<b>FT 280 K/S</b> 2.0 TD, 2.0 TDCi, 2.0 TDE, 2.3i, 2.4 TDE	08.00-07.06	55/63/66/ 74/92/ 103-107				0 204 204 992	← 48	0 204 201 289 <sup>B</sup>
						0 986 473 272		0 204 201 476
						0 204 204 993	→ 48	0 204 201 289 <sup>B</sup>
						0 986 474 272		
<b>FT 280 L</b> 2.3i <b>FT 280 L</b> 2.4 TDE	01.00-07.06	55/66/85/ 92/103-107				0 204 204 992	← 48	0 204 201 289 <sup>B</sup>
						0 986 473 272		0 204 201 476
						0 204 204 993	→ 48	0 204 201 289 <sup>B</sup>
						0 986 474 272		
<b>FT 280 M</b> 2.0 TD, 2.0 TDCi, 2.0 TDE, 2.3i, 2.4 TDE	08.00-07.06	55/63/66/ 74/92/ 103-107				0 204 204 992	← 48	0 204 201 289 <sup>B</sup>
						0 986 473 272		0 204 201 476
						0 204 204 993	→ 48	0 204 201 289 <sup>B</sup>
						0 986 474 272		
<b>FT 280 S</b> 2.4 TDI	01.01-05.06	66				0 204 204 992	← 48	0 204 201 289 <sup>B</sup>
						0 986 473 272		0 204 201 476
						0 204 204 993	→ 48	0 204 201 289 <sup>B</sup>
						0 986 474 272		
<b>FT 300 K/S</b> 2.0 TD <b>FT 300 K/S</b> 2.0 TDCi <b>FT 300 K/S</b> 2.0 TDE <b>FT 300 K/S</b> 2.3i	08.00-07.06	55/63/74/ 92/107				0 204 204 992	← 48	0 204 201 289 <sup>B</sup>
						0 986 473 272		0 204 201 476
						0 204 204 993	→ 48	0 204 201 289 <sup>B</sup>
						0 986 474 272		
<b>FT 300 L</b> 2.0 TD <b>FT 300 L</b> 2.0 TDCi <b>FT 300 L</b> 2.0 TDE <b>FT 300 L</b> 2.3i	08.00-07.06	55/63/74/ 92/107				0 204 204 992	← 48	0 204 201 289 <sup>B</sup>
						0 986 473 272		0 204 201 476
						0 204 204 993	→ 48	0 204 201 289 <sup>B</sup>
						0 986 474 272		
<b>FT 300 M</b> 2.0 TD <b>FT 300 M</b> 2.0 TDCi <b>FT 300 M</b> 2.0 TDE <b>FT 300 M</b> 2.3i	08.00-07.06	55/63/74/ 92/107				0 204 204 992	← 48	0 204 201 289 <sup>B</sup>
						0 986 473 272		0 204 201 476
						0 204 204 993	→ 48	0 204 201 289 <sup>B</sup>
						0 986 474 272		
<b>FT 300 S</b> 2.0 TDCi <b>FT 300 S</b> 2.4 TDI	01.01-05.06	66/74/92				0 204 204 992	← 48	0 204 201 289 <sup>B</sup>
						0 986 473 272		0 204 201 476
						0 204 204 993	→ 48	0 204 201 289 <sup>B</sup>
						0 986 474 272		
<b>FT 310 S</b> 2.4 TDI	01.01-05.06	88				0 204 204 992	← 48	0 204 201 289 <sup>B</sup>
						0 986 473 272		0 204 201 476
						0 204 204 993	→ 48	0 204 201 289 <sup>B</sup>
						0 986 474 272		
<b>FT 330 K/S</b> 2.0 TDCi, 2.0 TDE, 2.3i, 2.4 TD, 2.4 TDCi, 2.4 TDE	01.00-07.06	55/66/74/ 85/88/92/ 101/ 103-107				0 204 204 992	← 48	0 204 201 289 <sup>B</sup>
						0 986 473 272		0 204 201 476
						0 204 204 993	→ 48	0 204 201 289 <sup>B</sup>
						0 986 474 272		
<b>FT 330 L</b> 2.0 TDCi, 2.0 TDE, 2.3i, 2.4 TD, 2.4 TDCi, 2.4 TDE, 2.4 TDI	01.00-07.06	55/66/74/ 85/88/92/ 101/ 103-107				0 204 204 992	← 48	0 204 201 289 <sup>B</sup>
						0 986 473 272		0 204 201 476
						0 204 204 993	→ 48	0 204 201 289 <sup>B</sup>
						0 986 474 272		
<b>FT 330 M</b> 2.0 TDCi, 2.0 TDE, 2.3i, 2.4 TD, 2.4 TDCi, 2.4 TDE, 2.4 TDI	01.00-07.06	55/66/74/ 85/88/92/ 101/ 103-107				0 204 204 992	← 48	0 204 201 289 <sup>B</sup>
						0 986 473 272		0 204 201 476
						0 204 204 993	→ 48	0 204 201 289 <sup>B</sup>
						0 986 474 272		
<b>FT 330 S</b> 2.4 TDI	01.01-05.06	66/74/88				0 204 204 992	← 48	0 204 201 289 <sup>B</sup>
						0 986 473 272		0 204 201 476
						0 204 204 993	→ 48	0 204 201 289 <sup>B</sup>
						0 986 474 272		
<b>FT 350 EL</b> 2.0 TDCi, 2.0 TDE, 2.3i, 2.4 TD, 2.4 TDCi, 2.4 TDE	01.00-07.06	55/66/74/ 85/92/101/ 103-107				0 204 204 992	← 48	0 204 201 289 <sup>B</sup>
						0 986 473 272		0 204 201 476
						0 204 204 993	→ 48	0 204 201 289 <sup>B</sup>
						0 986 474 272		
<b>FT 350 E</b> 2.4 TDI	01.01-05.06	66/88/96				0 204 204 992	← 48	0 204 201 289 <sup>B</sup>
						0 986 473 272		0 204 201 476
						0 204 204 993	→ 48	0 204 201 289 <sup>B</sup>
						0 986 474 272		











		S							
	◀ FORD Transit [00]								
	<b>FT 350 L</b> 2.0 TDCi, 2.0 TDE, 2.3i, 2.4 TD, 2.4 TDCi, 2.4 TDE, 2.4 TDI	01.00-07.06	55/66/74/ 85/88/92/ 96/101/ 103-107				0 204 <b>204 992</b> 0 986 <b>473 272</b> 0 204 <b>204 993</b> 0 986 <b>474 272</b>	← 48  → 48 	0 204 <b>201 289</b> <sup>8</sup> 0 204 <b>201 476</b> 0 204 <b>201 289</b> <sup>8</sup>
	<b>FT 350 M</b> 2.0 TDCi, 2.0 TDE, 2.3i, 2.4 TD, 2.4 TDCi, 2.4 TDE, 2.4 TDI	01.00-07.06	55/66/74/ 85/88/92/ 96/101/ 103-107				0 204 <b>204 992</b> 0 986 <b>473 272</b> 0 204 <b>204 993</b> 0 986 <b>474 272</b>	← 48  → 48 	0 204 <b>201 289</b> <sup>8</sup> 0 204 <b>201 476</b> 0 204 <b>201 289</b> <sup>8</sup>
	<b>FT 430 EL</b> 2.4 TD <b>FT 430 EL</b> 2.4 TDCi <b>FT 430 EL</b> 2.4 TDE	08.02-07.06	55/66/85/ 92/101				0 204 <b>204 992</b> 0 986 <b>473 272</b> 0 204 <b>204 993</b> 0 986 <b>474 272</b>	← 48  → 48 	0 204 <b>201 289</b> <sup>8</sup> 0 204 <b>201 476</b> 0 204 <b>201 289</b> <sup>8</sup>
	<b>FT 430 E</b> 2.4 TDI	06.04-05.06	96				0 204 <b>204 992</b> 0 986 <b>473 272</b> 0 204 <b>204 993</b> 0 986 <b>474 272</b>	← 48  → 48 	0 204 <b>201 289</b> <sup>8</sup> 0 204 <b>201 476</b> 0 204 <b>201 289</b> <sup>8</sup>
	<b>FT 430 M</b> 2.4 TD <b>FT 430 M</b> 2.4 TDCi <b>FT 430 M</b> 2.4 TDE	08.02-07.06	55/85/92/ 101				0 204 <b>204 992</b> 0 986 <b>473 272</b> 0 204 <b>204 993</b> 0 986 <b>474 272</b>	← 48  → 48 	0 204 <b>201 289</b> <sup>8</sup> 0 204 <b>201 476</b> 0 204 <b>201 289</b> <sup>8</sup>
	<b>FT 240 K/S</b> 2.0 TD, 2.0 TDE	08.00-07.06	55/63				F 026 <b>002 578</b>	↔ 25,4	
	<b>FT 260 K/S</b> 2.0 TD, 2.0 TDCi, 2.0 TDE, 2.3i, 2.4 TDE	08.00-07.06	55/63/66/74/92/ 103-107				F 026 <b>002 578</b>	↔ 25,4	
	<b>FT 280 K/S</b> 2.0 TD, 2.0 TDCi, 2.0 TDE, 2.3i, 2.4 TDE	08.00-07.06	55/63/66/74/92/ 103-107				F 026 <b>002 578</b>	↔ 25,4	
	<b>FT 280 L</b> 2.3i, 2.4 TDE	01.00-07.06	55/66/85/92/103-107				F 026 <b>002 578</b>	↔ 25,4	
	<b>FT 280 M</b> 2.0 TD, 2.0 TDCi, 2.0 TDE, 2.3i, 2.4 TDE	08.00-07.06	55/63/66/74/92/ 103-107				F 026 <b>002 578</b>	↔ 25,4	
	<b>FT 280 S</b> 2.4 TDI	01.01-05.06	66				F 026 <b>002 578</b>	↔ 25,4	
	<b>FT 300 K/S</b> 2.0 TD, 2.0 TDCi, 2.0 TDE, 2.3i	08.00-07.06	55/63/74/ 92/107				F 026 <b>002 578</b>	↔ 25,4	
	<b>FT 300 L</b> 2.0 TD, 2.0 TDCi, 2.0 TDE, 2.3i	08.00-07.06	55/63/74/ 92/107				F 026 <b>002 578</b>	↔ 25,4	
	<b>FT 300 M</b> 2.0 TD, 2.0 TDCi, 2.0 TDE, 2.3i	08.00-07.06	55/63/74/ 92/107				F 026 <b>002 578</b>	↔ 25,4	
	<b>FT 300 S</b> 2.0 TDCi, 2.4 TDI	01.01-05.06	66/74/92				F 026 <b>002 578</b>	↔ 25,4	
	<b>FT 310 S</b> 2.4 TDI	01.01-05.06	88				F 026 <b>002 578</b>	↔ 25,4	
	<b>FT 330 K/S</b> 2.0 TDCi, 2.0 TDE, 2.3i, 2.4 TD, 2.4 TDCi, 2.4 TDE	01.00-07.06	55/66/74/85/88/92/ 101/103-107				F 026 <b>002 578</b>	↔ 25,4	
	<b>FT 330 L</b> 2.0 TDCi, 2.0 TDE, 2.3i, 2.4 TD, 2.4 TDCi, 2.4 TDE, 2.4 TDI	01.00-07.06	55/66/74/85/88/92/ 101/103-107				F 026 <b>002 578</b>	↔ 25,4	
	<b>FT 330 M</b> 2.0 TDCi, 2.0 TDE, 2.3i, 2.4 TD, 2.4 TDCi, 2.4 TDE, 2.4 TDI	01.00-07.06	55/66/74/85/88/92/ 101/103-107				F 026 <b>002 578</b>	↔ 25,4	
	<b>FT 330 S</b> 2.4 TDI	01.01-05.06	66/74/88				F 026 <b>002 578</b>	↔ 25,4	
	<b>FT 350 EL</b> 2.0 TDCi, 2.0 TDE, 2.3i, 2.4 TD, 2.4 TDCi, 2.4 TDE	01.00-07.06	55/66/74/85/92/101/ 103-107				F 026 <b>002 578</b>	↔ 25,4	
	<b>FT 350 E</b> 2.4 TDI	01.01-05.06	66/88/96				F 026 <b>002 578</b>	↔ 25,4	
	<b>FT 350 L</b> 2.0 TDCi, 2.0 TDE, 2.3i, 2.4 TD, 2.4 TDCi, 2.4 TDE, 2.4 TDI	01.00-07.06	55/66/74/85/88/92/ 96/101/103-107				F 026 <b>002 578</b>	↔ 25,4	
	<b>FT 350 M</b> 2.0 TDCi, 2.0 TDE, 2.3i, 2.4 TD, 2.4 TDCi, 2.4 TDE, 2.4 TDI	01.00-07.06	55/66/74/85/88/92/ 96/101/103-107				F 026 <b>002 578</b>	↔ 25,4	
	<b>FT 430 EL</b> 2.4 TD, 2.4 TDCi, 2.4 TDE	08.02-07.06	55/66/85/92/101				F 026 <b>002 578</b>	↔ 25,4	
	<b>FT 430 E</b> 2.4 TDI	06.04-05.06	96				F 026 <b>002 578</b>	↔ 25,4	
	<b>FT 430 M</b> 2.4 TD, 2.4 TDCi, 2.4 TDE	08.02-07.06	55/85/92/101				F 026 <b>002 578</b>	↔ 25,4	
	<b>FT 240 K/S</b> 2.0 TD	08.00-07.06	55/63			FGS,PW	1 987 <b>482 035</b>	← 1648	
	<b>FT 240 K/S</b> 2.0 TDE						1 987 <b>482 135</b>	→ 1352	
						LLE	1 987 <b>477 186</b>	1052	

		S							
FT 240 K/S 2.0 TD FT 240 K/S 2.0 TDE	08.00-07.06	55/63	PW	1 987 477 174	← 1547				
				1 987 482 036	→ 1283				
			RLE	1 987 477 190	910				
FT 260 K/S 2.0 TD FT 260 K/S 2.0 TDE	08.00-07.06	55/63	FGS,PW	1 987 482 035	← 1648				
				1 987 482 135	→ 1352				
			LLE	1 987 477 186	1052				
			PW	1 987 477 174	← 1547				
				1 987 482 036	→ 1283				
			RLE	1 987 477 190	910				
FT 260 K/S 2.0 TDCi FT 260 K/S 2.0 TDE	08.00-07.06	74/92	FGS,PW	1 987 482 035	← 1648				
				1 987 482 135	→ 1352				
			LLE	1 987 477 186	1052				
			PW	1 987 477 174	← 1547				
				1 987 482 036	→ 1283				
			RLE	1 987 477 190	910				
FT 260 K/S 2.3i	08.01-07.06	103-107	LLE	1 987 477 186	1052				
				PW	1 987 477 178	← 1528			
				1 987 482 036	→ 1283				
			OZB,PW	1 987 477 180	← 1608				
				1 987 477 185	→ 1386				
			PW,ZWB	1 987 477 175	← 1590				
				1 987 477 177	→ 1334				
			RLE	1 987 477 190	910				
FT 260 K/S 2.4 TDE	04.01-07.06	66	LLE	1 987 477 186	1052				
				PW	1 987 477 178	← 1528			
				1 987 482 036	→ 1283				
			OZB,PW	1 987 477 180	← 1608				
				1 987 477 185	→ 1386				
			PW,ZWB	1 987 477 175	← 1590				
				1 987 477 177	→ 1334				
			RLE	1 987 477 190	910				
FT 280 K/S 2.0 TD FT 280 K/S 2.0 TDE	08.00-07.06	55/63	FGS,PW	1 987 482 035	← 1648				
				1 987 482 135	→ 1352				
			LLE	1 987 477 186	1052				
			PW	1 987 477 174	← 1547				
				1 987 482 036	→ 1283				
			RLE	1 987 477 190	910				
FT 280 K/S 2.0 TDCi FT 280 K/S 2.0 TDE	08.00-07.06	74/92	FGS,PW	1 987 482 035	← 1648				
				1 987 482 135	→ 1352				
			LLE	1 987 477 186	1052				
			PW	1 987 477 174	← 1547				
				1 987 482 036	→ 1283				
			RLE	1 987 477 190	910				
FT 280 K/S 2.3i	08.01-07.06	103-107	LLE	1 987 477 186	1052				
				PW	1 987 477 178	← 1528			
				1 987 482 036	→ 1283				
			OZB,PW	1 987 477 180	← 1608				
				1 987 477 185	→ 1386				
			PW,ZWB	1 987 477 175	← 1590				
				1 987 477 177	→ 1334				
			RLE	1 987 477 190	910				
FT 280 K/S 2.4 TDE	04.01-07.06	66	LLE	1 987 477 186	1052				
				PW	1 987 477 178	← 1528			
				1 987 482 036	→ 1283				
			OZB,PW	1 987 477 180	← 1608				
				1 987 477 185	→ 1386				
			PW,ZWB	1 987 477 175	← 1590				
				1 987 477 177	→ 1334				
			RLE	1 987 477 190	910				













		S							
◀ FORD Transit [00]									
<b>FT 280 L 2.3i</b>		01.00-07.06	55/66/85/			LLE	1987 477 186		1052
<b>FT 280 L 2.4 TDE</b>			92/103-107			MI	1987 482 195		1534
						PW	1987 477 178	←	1528
							1987 482 036	→	1283
						OZB,PW	1987 477 180	←	1608
							1987 477 185	→	1386
						PW,ZWB	1987 477 175	←	1590
							1987 477 177	→	1334
						RLE	1987 477 190		910
<b>FT 280 M 2.0 TD</b>		08.00-07.06	55/63			FGS,MI,PW	1987 482 194		1083
<b>FT 280 M 2.0 TDE</b>						FGS,PW	1987 482 035	←	1648
							1987 482 135	→	1352
						LLE	1987 477 186		1052
						PW	1987 477 174	←	1547
							1987 482 036	→	1283
						RLE	1987 477 190		910
<b>FT 280 M 2.0 TDCi</b>		08.00-07.06	74/92			FGS,MI,PW	1987 482 194		1083
<b>FT 280 M 2.0 TDE</b>						FGS,PW	1987 482 035	←	1648
							1987 482 135	→	1352
						LLE	1987 477 186		1052
						PW	1987 477 174	←	1547
							1987 482 036	→	1283
						RLE	1987 477 190		910
<b>FT 280 M 2.3i</b>		08.01-07.06	103-107			LLE	1987 477 186		1052
						MI	1987 482 194		1083
						PW	1987 477 178	←	1528
							1987 482 036	→	1283
						OZB,PW	1987 477 180	←	1608
							1987 477 185	→	1386
						PW,ZWB	1987 477 175	←	1590
							1987 477 177	→	1334
						RLE	1987 477 190		910
<b>FT 280 M 2.4 TDE</b>		04.01-07.06	66			LLE	1987 477 186		1052
						MI	1987 482 194		1083
						PW	1987 477 178	←	1528
							1987 482 036	→	1283
						OZB,PW	1987 477 180	←	1608
							1987 477 185	→	1386
						PW,ZWB	1987 477 175	←	1590
							1987 477 177	→	1334
						RLE	1987 477 190		910
<b>FT 280 S 2.4 TDI</b>		01.01-05.06	66				1987 477 186		1052
						PW	1987 477 178	←	1528
							1987 482 036	→	1283
						OZB,PW	1987 477 180	←	1608
							1987 477 185	→	1386
						PW,ZWB	1987 477 175	←	1590
							1987 477 177	→	1334
<b>FT 300 K/S 2.0 TD</b>		08.00-07.06	55/63/74/			FGS,PW	1987 482 035	←	1648
<b>FT 300 K/S 2.0 TDCi</b>			92				1987 482 135	→	1352
<b>FT 300 K/S 2.0 TDE</b>						LLE	1987 477 186		1052
						PW	1987 477 174	←	1547
							1987 482 036	→	1283
						RLE	1987 477 190		910
<b>FT 300 K/S 2.3i</b>		08.00-07.06	107			LLE	1987 477 186		1052
						PW	1987 477 178	←	1528
							1987 482 036	→	1283
						OZB,PW	1987 477 180	←	1608
							1987 477 185	→	1386
						PW,ZWB	1987 477 175	←	1590
							1987 477 177	→	1334
						RLE	1987 477 190		910











									
<b>FT 300 L 2.0 TD</b>		08.00-07.06	55/63/74/			FGS,PW	1 987 482 035	← 1648	
<b>FT 300 L 2.0 TDCi</b>			92				1 987 482 135	→ 1352	
<b>FT 300 L 2.0 TDE</b>						LLE	1 987 477 186	1052	
						PW	1 987 477 174	← 1547	
							1 987 482 036	→ 1283	
						RLE	1 987 477 190	910	
<b>FT 300 L 2.3i</b>		08.00-07.06	107			LLE	1 987 477 186	1052	
						MI	1 987 482 195	1534	
						PW	1 987 477 178	← 1528	
							1 987 482 036	→ 1283	
						OZB,PW	1 987 477 180	← 1608	
							1 987 477 185	→ 1386	
						PW,ZWB	1 987 477 175	← 1590	
							1 987 477 177	→ 1334	
						RLE	1 987 477 190	910	
<b>FT 300 M 2.0 TD</b>		08.00-07.06	55/63/74/			FGS,MI,PW	1 987 482 194	1083	
<b>FT 300 M 2.0 TDCi</b>			92			FGS,PW	1 987 482 035	← 1648	
<b>FT 300 M 2.0 TDE</b>							1 987 482 135	→ 1352	
						LLE	1 987 477 186	1052	
						PW	1 987 477 174	← 1547	
							1 987 482 036	→ 1283	
						RLE	1 987 477 190	910	
<b>FT 300 M 2.3i</b>		08.00-07.06	107			LLE	1 987 477 186	1052	
						MI	1 987 482 194	1083	
						PW	1 987 477 178	← 1528	
							1 987 482 036	→ 1283	
						OZB,PW	1 987 477 180	← 1608	
							1 987 477 185	→ 1386	
						PW,ZWB	1 987 477 175	← 1590	
							1 987 477 177	→ 1334	
						RLE	1 987 477 190	910	
<b>FT 300 S 2.0 TDCi</b>		05.02-05.06	92				1 987 477 186	1052	
						FGS,PW	1 987 482 035	← 1648	
							1 987 482 135	→ 1352	
						PW	1 987 477 174	← 1547	
							1 987 482 036	→ 1283	
<b>FT 300 S 2.4 TDI</b>		01.01-05.06	66/74				1 987 477 186	1052	
						PW	1 987 477 178	← 1528	
							1 987 482 036	→ 1283	
						OZB,PW	1 987 477 180	← 1608	
							1 987 477 185	→ 1386	
						PW,ZWB	1 987 477 175	← 1590	
							1 987 477 177	→ 1334	
<b>FT 310 S 2.4 TDI</b>		01.01-05.06	88				1 987 477 186	1052	
						PW	1 987 477 178	← 1528	
							1 987 482 036	→ 1283	
						OZB,PW	1 987 477 180	← 1608	
							1 987 477 185	→ 1386	
						PW,ZWB	1 987 477 175	← 1590	
							1 987 477 177	→ 1334	
<b>FT 330 K/S 2.0 TDCi</b>		05.02-07.06	92			FGS,PW	1 987 482 035	← 1648	
							1 987 482 135	→ 1352	
						PW	1 987 477 174	← 1547	
							1 987 482 036	→ 1283	
<b>FT 330 K/S 2.0 TDCi</b>		01.00-07.06	92			LLE	1 987 477 186	1052	
<b>FT 330 K/S 2.4 TDE</b>						RLE	1 987 477 190	910	
<b>FT 330 K/S 2.0 TDE</b>		08.03-07.06	74			FGS,PW	1 987 482 035	← 1648	
							1 987 482 135	→ 1352	
						LLE	1 987 477 186	1052	
						PW	1 987 477 174	← 1547	
							1 987 482 036	→ 1283	
						RLE	1 987 477 190	910	



								
 ◀ FORD Transit [00]								
<b>FT 330 K/S</b> 2.3i	12.00-07.06	101/			LLE	1987 477 186		1052
<b>FT 330 K/S</b> 2.4 TDCi		103-107			PW	1987 477 178	←	1528
						1987 482 036	→	1283
					OZB,PW	1987 477 180	←	1608
						1987 477 185	→	1386
					PW,ZWB	1987 477 175	←	1590
						1987 477 177	→	1334
					RLE	1987 477 190		910
<b>FT 330 K/S</b> 2.4 TD	01.00-07.06	55/66			LLE	1987 477 186		1052
<b>FT 330 K/S</b> 2.4 TDE					PW	1987 477 178	←	1528
						1987 482 036	→	1283
					OZB,PW	1987 477 180	←	1608
						1987 477 185	→	1386
					PW,ZWB	1987 477 175	←	1590
						1987 477 177	→	1334
					RLE	1987 477 190		910
<b>FT 330 K/S</b> 2.4 TDE	01.00-07.06	85/88			LLE	1987 477 186		1052
					PW	1987 477 178	←	1528
						1987 482 036	→	1283
					OZB,PW	1987 477 180	←	1608
						1987 477 185	→	1386
					PW,ZWB	1987 477 175	←	1590
						1987 477 177	→	1334
					RLE	1987 477 190		910
		92			PW	1987 477 178	←	1528
						1987 482 036	→	1283
					OZB,PW	1987 477 180	←	1608
						1987 477 185	→	1386
					PW,ZWB	1987 477 175	←	1590
						1987 477 177	→	1334
					RLE	1987 477 190		910
<b>FT 330 L</b> 2.0 TDCi	05.02-07.06	92			FGS,PW	1987 482 035	←	1648
						1987 482 135	→	1352
					PW	1987 477 174	←	1547
						1987 482 036	→	1283
<b>FT 330 L</b> 2.0 TDCi	01.00-07.06	92			LLE	1987 477 186		1052
<b>FT 330 L</b> 2.4 TDE					RLE	1987 477 190		910
<b>FT 330 L</b> 2.0 TDE	08.03-07.06	74			FGS,PW	1987 482 035	←	1648
						1987 482 135	→	1352
					LLE	1987 477 186		1052
					PW	1987 477 174	←	1547
						1987 482 036	→	1283
					RLE	1987 477 190		910
<b>FT 330 L</b> 2.3i	12.00-07.06	101/			LLE	1987 477 186		1052
<b>FT 330 L</b> 2.4 TDCi		103-107			MI	1987 482 195		1534
					PW	1987 477 178	←	1528
						1987 482 036	→	1283
					OZB,PW	1987 477 180	←	1608
						1987 477 185	→	1386
					PW,ZWB	1987 477 175	←	1590
						1987 477 177	→	1334
					RLE	1987 477 190		910
<b>FT 330 L</b> 2.4 TD	01.00-09.03	55			LLE	1987 477 186		1052
					MI	1987 482 195		1534
					PW	1987 477 178	←	1528
						1987 482 036	→	1283
					OZB,PW	1987 477 180	←	1608
						1987 477 185	→	1386
					PW,ZWB	1987 477 175	←	1590
						1987 477 177	→	1334
					RLE	1987 477 190		910
<b>FT 330 L</b> 2.4 TDE	01.00-07.06	66			LLE	1987 477 186		1052
					PW	1987 482 036	→	1283
					RLE	1987 477 190		910











																											
<b>FT 330 L 2.4 TDE</b>		01.00-07.06	88				LLE	1 987 477 186	1052																		
							PW	1 987 482 036	→ 1283																		
							RLE	1 987 477 190	910																		
							92	MI	1 987 482 195	1534																	
								PW	1 987 477 178	← 1528																	
							OZB,PW	1 987 482 036	→ 1283																		
								1 987 477 180	← 1608																		
								1 987 477 185	→ 1386																		
								PW,ZWB	1 987 477 175	← 1590																	
								1 987 477 177	→ 1334																		
								03.04-07.06	85			LLE	1 987 477 186	1052													
							MI					1 987 482 195	1534														
							PW					1 987 477 178	← 1528														
							1 987 482 036					→ 1283															
OZB,PW	1 987 477 180	← 1608																									
	1 987 477 185	→ 1386																									
PW,ZWB	1 987 477 175	← 1590																									
	1 987 477 177	→ 1334																									
RLE	1 987 477 190	910																									
<b>FT 330 L 2.4 TDE</b> <b>FT 330 L 2.4 TDI</b>		01.00-07.06	66				MI					1 987 482 195	1534														
							PW					1 987 477 178	← 1528														
							OZB,PW					1 987 477 180	← 1608														
												1 987 477 185	→ 1386														
							PW,ZWB					1 987 477 175	← 1590														
								1 987 477 177	→ 1334																		
							88	MI	1 987 482 195	1534																	
								PW	1 987 477 178	← 1528																	
								OZB,PW	1 987 477 180	← 1608																	
									1 987 477 185	→ 1386																	
								PW,ZWB	1 987 477 175	← 1590																	
									1 987 477 177	→ 1334																	
							<b>FT 330 L 2.4 TDI</b>		01.01-05.06	66					1 987 477 186	1052											
														PW	1 987 482 036	→ 1283											
88		1 987 477 186	1052																								
	PW	1 987 482 036	→ 1283																								
<b>FT 330 M 2.0 TDCi</b>		05.02-07.06	92											FGS,MI,PW	1 987 482 194	1083											
														FGS,PW	1 987 482 035	← 1648											
														1 987 482 135	→ 1352												
														PW	1 987 477 174	← 1547											
														1 987 482 036	→ 1283												
														<b>FT 330 M 2.0 TDCi</b> <b>FT 330 M 2.4 TDE</b> <b>FT 330 M 2.0 TDE</b>		01.00-07.06	92				LLE	1 987 477 186	1052				
																					RLE	1 987 477 190	910				
																					08.03-07.06	74			FGS,MI,PW	1 987 482 194	1083
																									FGS,PW	1 987 482 035	← 1648
																									1 987 482 135	→ 1352	
							LLE	1 987 477 186	1052																		
							PW	1 987 477 174	← 1547																		
							1 987 482 036	→ 1283																			
							RLE	1 987 477 190	910																		
<b>FT 330 M 2.3i</b> <b>FT 330 M 2.4 TDCi</b>		12.00-07.06	101/ 103-107				LLE	1 987 477 186	1052																		
							MI	1 987 482 194	1083																		
							PW	1 987 477 178	← 1528																		
							1 987 482 036	→ 1283																			
							OZB,PW	1 987 477 180	← 1608																		
								1 987 477 185	→ 1386																		
							PW,ZWB	1 987 477 175	← 1590																		
								1 987 477 177	→ 1334																		
							RLE	1 987 477 190	910																		
							<b>FT 330 M 2.4 TD</b>		01.00-09.03	55				LLE	1 987 477 186	1052											
														MI	1 987 482 194	1083											
														PW	1 987 477 178	← 1528											
														1 987 482 036	→ 1283												





		S									
◀ FORD Transit [00]											
<b>FT 330 M 2.4 TD</b>	01.00-09.03	55	OZB,PW	1987 477 180	←	1608					
				1987 477 185	→	1386					
				PW,ZWB	1987 477 175	←	1590				
				1987 477 177	→	1334					
				RLE	1987 477 190		910				
<b>FT 330 M 2.4 TDE</b>	01.00-07.06	66	LLE	1987 477 186		1052					
			PW	1987 482 036	→	1283					
			RLE	1987 477 190		910					
		88	LLE	1987 477 186		1052					
			PW	1987 482 036	→	1283					
			RLE	1987 477 190		910					
		92	MI	1987 482 194		1083					
			PW	1987 477 178	←	1528					
				1987 482 036	→	1283					
			OZB,PW	1987 477 180	←	1608					
				1987 477 185	→	1386					
			PW,ZWB	1987 477 175	←	1590					
				1987 477 177	→	1334					
			03.04-07.06	LLE	1987 477 186		1052				
				MI	1987 482 194		1083				
PW	1987 477 178	←		1528							
	1987 482 036	→		1283							
OZB,PW	1987 477 180	←		1608							
	1987 477 185	→		1386							
PW,ZWB	1987 477 175	←		1590							
	1987 477 177	→		1334							
RLE	1987 477 190			910							
<b>FT 330 M 2.4 TDE</b> <b>FT 330 M 2.4 TDI</b>	01.00-07.06	66	MI	1987 482 194		1083					
			PW	1987 477 178	←	1528					
			OZB,PW	1987 477 180	←	1608					
			1987 477 185	→	1386						
		PW,ZWB	1987 477 175	←	1590						
			1987 477 177	→	1334						
		88	MI	1987 482 194		1083					
			PW	1987 477 178	←	1528					
			OZB,PW	1987 477 180	←	1608					
				1987 477 185	→	1386					
			PW,ZWB	1987 477 175	←	1590					
				1987 477 177	→	1334					
		<b>FT 330 M 2.4 TDI</b>	01.01-05.06	66		1987 477 186		1052			
					PW	1987 482 036	→	1283			
						1987 477 186		1052			
<b>FT 330 S 2.4 TDI</b>	01.01-05.06	66/74/88	PW	1987 482 036	→	1283					
				1987 477 186		1052					
			PW	1987 477 178	←	1528					
			1987 482 036	→	1283						
OZB,PW	1987 477 180	←	1608								
	1987 477 185	→	1386								
PW,ZWB	1987 477 175	←	1590								
	1987 477 177	→	1334								
<b>FT 350 EL 2.0 TDCi</b>	05.02-07.06	92	FGS,PW	1987 482 035	←	1648					
				1987 482 135	→	1352					
			MI	1987 482 195		1534					
			PW	1987 477 174	←	1547					
				1987 482 036	→	1283					
<b>FT 350 EL 2.0 TDCi</b>	01.00-07.06	92	LLE	1987 477 186		1052					
			RLE	1987 477 190		910					
<b>FT 350 EL 2.0 TDE</b>	08.03-07.06	74	FGS,PW	1987 482 035	←	1648					
				1987 482 135	→	1352					
			LLE	1987 477 186		1052					
			MI	1987 482 195		1534					











									
<b>FT 350 EL 2.0 TDE</b>	08.03-07.06	74				PW	1 987 477 174	← 1547	
							1 987 482 036	→ 1283	
						RLE	1 987 477 190	910	
<b>FT 350 EL 2.3i</b>	12.00-07.06	101/				LLE	1 987 477 186	1052	
<b>FT 350 EL 2.4 TDCi</b>		103-107				MI	1 987 482 195	1534	
						PW	1 987 477 178	← 1528	
							1 987 482 036	→ 1283	
						OZB,PW	1 987 477 180	← 1608	
							1 987 477 185	→ 1386	
						PW,ZWB	1 987 477 175	← 1590	
							1 987 477 177	→ 1334	
						RLE	1 987 477 190	910	
<b>FT 350 EL 2.4 TD</b>	01.00-07.06	55/66				LLE	1 987 477 186	1052	
<b>FT 350 EL 2.4 TDE</b>						MI	1 987 482 195	1534	
						PW	1 987 477 178	← 1528	
							1 987 482 036	→ 1283	
						OZB,PW	1 987 477 180	← 1608	
							1 987 477 185	→ 1386	
						PW,ZWB	1 987 477 175	← 1590	
							1 987 477 177	→ 1334	
						RLE	1 987 477 190	910	
<b>FT 350 EL 2.4 TDE</b>	01.00-07.06	92				MI	1 987 482 195	1534	
						PW	1 987 477 178	← 1528	
							1 987 482 036	→ 1283	
						OZB,PW	1 987 477 180	← 1608	
							1 987 477 185	→ 1386	
						PW,ZWB	1 987 477 175	← 1590	
							1 987 477 177	→ 1334	
						RLE	1 987 477 190	910	
						LLE	1 987 477 186	1052	
						MI	1 987 482 195	1534	
						PW	1 987 477 178	← 1528	
							1 987 482 036	→ 1283	
						OZB,PW	1 987 477 180	← 1608	
							1 987 477 185	→ 1386	
						PW,ZWB	1 987 477 175	← 1590	
							1 987 477 177	→ 1334	
						RLE	1 987 477 190	910	
<b>FT 350 E 2.4 TDI</b>	01.01-05.06	66/88/96					1 987 477 186	1052	
						MI	1 987 482 195	1534	
						PW	1 987 477 178	← 1528	
							1 987 482 036	→ 1283	
						OZB,PW	1 987 477 180	← 1608	
							1 987 477 185	→ 1386	
						PW,ZWB	1 987 477 175	← 1590	
							1 987 477 177	→ 1334	
<b>FT 350 L 2.0 TDCi</b>	05.02-07.06	92				FGS,PW	1 987 482 035	← 1648	
							1 987 482 135	→ 1352	
						PW	1 987 477 174	← 1547	
							1 987 482 036	→ 1283	
<b>FT 350 L 2.0 TDCi</b>	01.00-07.06	92				LLE	1 987 477 186	1052	
<b>FT 350 L 2.4 TDE</b>						RLE	1 987 477 190	910	
<b>FT 350 L 2.0 TDE</b>	08.03-07.06	74				FGS,PW	1 987 482 035	← 1648	
							1 987 482 135	→ 1352	
						LLE	1 987 477 186	1052	
						PW	1 987 477 174	← 1547	
							1 987 482 036	→ 1283	
						RLE	1 987 477 190	910	
<b>FT 350 L 2.3i</b>	12.00-07.06	101/				LLE	1 987 477 186	1052	
<b>FT 350 L 2.4 TDCi</b>		103-107				MI	1 987 482 195	1534	
						PW	1 987 477 178	← 1528	
							1 987 482 036	→ 1283	
						OZB,PW	1 987 477 180	← 1608	
							1 987 477 185	→ 1386	



			S									
◀ FORD Transit [00]												
FT 350 L 2.3i	12.00-07.06	101/					PW,ZWB	1987 477 175	←	1590		
								1987 477 177	→	1334		
FT 350 L 2.4 TDCi		103-107					RLE	1987 477 190		910		
								1987 477 186		1052		
FT 350 L 2.4 TD	01.00-09.03	55					MI	1987 482 195		1534		
								PW	1987 477 178	←	1528	
									1987 482 036	→	1283	
								OZB,PW	1987 477 180	←	1608	
									1987 477 185	→	1386	
								PW,ZWB	1987 477 175	←	1590	
									1987 477 177	→	1334	
								RLE	1987 477 190		910	
									1987 477 186		1052	
								FT 350 L 2.4 TDE	01.00-07.06	66		
PW	1987 482 036	→	1283									
	1987 477 190		910									
RLE	1987 477 186		1052									
	1987 482 036	→	1283									
88							RLE					
									MI	1987 482 195		1534
										PW	1987 477 178	←
									1987 482 036		→	1283
									OZB,PW	1987 477 180	←	1608
										1987 477 185	→	1386
92							PW,ZWB		1987 477 175	←	1590	
								1987 477 177	→	1334		
								RLE	1987 477 190		910	
									1987 477 186		1052	
								MI	1987 482 195		1534	
									PW	1987 477 178	←	1528
1987 482 036	→	1283										
03.04-07.06	85						OZB,PW	1987 477 180	←	1608		
								1987 477 185	→	1386		
								PW,ZWB	1987 477 175	←	1590	
									1987 477 177	→	1334	
								RLE	1987 477 190		910	
									1987 477 186		1052	
								MI	1987 482 195		1534	
									PW	1987 477 178	←	1528
								1987 482 036		→	1283	
								OZB,PW	1987 477 180	←	1608	
1987 477 185	→	1386										
PW,ZWB	1987 477 175	←	1590									
	1987 477 177	→	1334									
FT 350 L 2.4 TDE	01.00-07.06	66					RLE	1987 477 190		910		
								1987 477 186		1052		
FT 350 L 2.4 TDI							MI	1987 482 195		1534		
								PW	1987 477 178	←	1528	
OZB,PW	1987 477 180	←	1608									
	1987 477 185	→	1386									
PW,ZWB	1987 477 175	←	1590									
	1987 477 177	→	1334									
88							RLE	1987 477 190		910		
								MI	1987 482 195		1534	
									PW	1987 477 178	←	1528
								1987 477 186			1052	
								OZB,PW	1987 477 180	←	1608	
									1987 477 185	→	1386	
PW,ZWB	1987 477 175	←	1590									
	1987 477 177	→	1334									
FT 350 L 2.4 TDI	01.01-05.06	66					MI	1987 477 186		1052		
								PW	1987 482 036	→	1283	
88							PW		1987 477 186		1052	
								1987 482 036	→	1283		
06.04-05.06	96						PW	1987 477 186		1052		
								MI	1987 482 195		1534	
									PW	1987 477 178	←	1528
								1987 482 036		→	1283	
								OZB,PW	1987 477 180	←	1608	
									1987 477 185	→	1386	
PW,ZWB	1987 477 175	←	1590									
	1987 477 177	→	1334									
FT 350 M 2.0 TDCi	05.02-07.06	92					FGS,MI,PW	1987 482 194		1083		
								FGS,PW	1987 482 035	←	1648	
									1987 482 135	→	1352	
								PW	1987 477 174	←	1547	
									1987 482 036	→	1283	











		<b>S</b>							
<b>FT 350 M 2.0 TDCi</b>		01.00-07.06	92			LLE	1 987 477 186		1052
<b>FT 350 M 2.4 TDE</b>						RLE	1 987 477 190		910
<b>FT 350 M 2.0 TDE</b>		08.03-07.06	74			FGS,MI,PW	1 987 482 194		1083
						FGS,PW	1 987 482 035	←	1648
							1 987 482 135	→	1352
						LLE	1 987 477 186		1052
						PW	1 987 477 174	←	1547
							1 987 482 036	→	1283
						RLE	1 987 477 190		910
<b>FT 350 M 2.3i</b>		12.00-07.06	101/			LLE	1 987 477 186		1052
<b>FT 350 M 2.4 TDCi</b>			103-107			MI	1 987 482 194		1083
						PW	1 987 477 178	←	1528
							1 987 482 036	→	1283
						OZB,PW	1 987 477 180	←	1608
							1 987 477 185	→	1386
						PW,ZWB	1 987 477 175	←	1590
							1 987 477 177	→	1334
						RLE	1 987 477 190		910
<b>FT 350 M 2.4 TD</b>		01.00-09.03	55			LLE	1 987 477 186		1052
						MI	1 987 482 194		1083
						PW	1 987 477 178	←	1528
							1 987 482 036	→	1283
						OZB,PW	1 987 477 180	←	1608
							1 987 477 185	→	1386
						PW,ZWB	1 987 477 175	←	1590
							1 987 477 177	→	1334
						RLE	1 987 477 190		910
<b>FT 350 M 2.4 TDE</b>		01.00-07.06	66			LLE	1 987 477 186		1052
						PW	1 987 482 036	→	1283
						RLE	1 987 477 190		910
			88			LLE	1 987 477 186		1052
						PW	1 987 482 036	→	1283
						RLE	1 987 477 190		910
			92			MI	1 987 482 194		1083
						PW	1 987 477 178	←	1528
							1 987 482 036	→	1283
						OZB,PW	1 987 477 180	←	1608
							1 987 477 185	→	1386
						PW,ZWB	1 987 477 175	←	1590
							1 987 477 177	→	1334
						RLE	1 987 477 190		910
		03.04-07.06	85			LLE	1 987 477 186		1052
						MI	1 987 482 194		1083
						PW	1 987 477 178	←	1528
							1 987 482 036	→	1283
						OZB,PW	1 987 477 180	←	1608
							1 987 477 185	→	1386
						PW,ZWB	1 987 477 175	←	1590
							1 987 477 177	→	1334
						RLE	1 987 477 190		910
<b>FT 350 M 2.4 TDE</b>		01.00-07.06	66			MI	1 987 482 194		1083
<b>FT 350 M 2.4 TDI</b>						PW	1 987 477 178	←	1528
						OZB,PW	1 987 477 180	←	1608
							1 987 477 185	→	1386
						PW,ZWB	1 987 477 175	←	1590
							1 987 477 177	→	1334
			88			MI	1 987 482 194		1083
						PW	1 987 477 178	←	1528
						OZB,PW	1 987 477 180	←	1608
							1 987 477 185	→	1386
						PW,ZWB	1 987 477 175	←	1590
							1 987 477 177	→	1334





◀ FORD Transit [00]										
<b>FT 350 M</b> 2.4 TDI	01.01-05.06	66				1987 477 186	1052			
			PW			1987 482 036	→ 1283			
			88				1987 477 186	1052		
							1987 482 036	→ 1283		
	06.04-05.06	96					1987 477 186	1052		
			MI				1987 482 194	1083		
			PW				1987 477 178	← 1528		
							1987 482 036	→ 1283		
			OZB,PW				1987 477 180	← 1608		
							1987 477 185	→ 1386		
PW,ZWB						1987 477 175	← 1590			
						1987 477 177	→ 1334			
<b>FT 430 EL</b> 2.4 TD <b>FT 430 EL</b> 2.4 TDCi <b>FT 430 EL</b> 2.4 TDE	08.02-07.06	55/66/85/ 92/101				1987 477 186	1052			
			LLE			1987 482 195	1534			
							1987 477 178	← 1528		
							1987 482 036	→ 1283		
							1987 477 180	← 1608		
				OZB,PW				1987 477 185	→ 1386	
				PW,ZWB				1987 477 175	← 1590	
								1987 477 177	→ 1334	
				RLE				1987 477 190	910	
								1987 477 186	1052	
<b>FT 430 E</b> 2.4 TDI	06.04-05.06	96				1987 477 186	1052			
			MI			1987 482 195	1534			
							1987 477 178	← 1528		
							1987 482 036	→ 1283		
							1987 477 180	← 1608		
				OZB,PW				1987 477 185	→ 1386	
				PW,ZWB				1987 477 175	← 1590	
								1987 477 177	→ 1334	
				RLE				1987 477 190	910	
								1987 477 186	1052	
<b>FT 430 M</b> 2.4 TD <b>FT 430 M</b> 2.4 TDCi <b>FT 430 M</b> 2.4 TDE	08.02-07.06	55/85/92/ 101				1987 477 186	1052			
			LLE			1987 482 194	1083			
							1987 477 178	← 1528		
							1987 482 036	→ 1283		
							1987 477 180	← 1608		
				OZB,PW				1987 477 185	→ 1386	
				PW,ZWB				1987 477 175	← 1590	
								1987 477 177	→ 1334	
				RLE				1987 477 190	910	
								1987 477 186	1052	
<b>FT 240 K/S</b> 2.0 TD <b>FT 240 K/S</b> 2.0 TD <b>FT 240 K/S</b> 2.0 TDE	07.03-07.06	55/63				0 265 006 784 <sup>4</sup>				
			LAB,TW			0 265 006 784 <sup>3</sup>				
							0 265 006 818 <sup>4</sup>			
							0 265 006 815 <sup>4</sup>			
							0 265 006 817 <sup>4</sup>			
				TW			0 265 006 458 <sup>3</sup>			
				RAB,TW			0 265 006 460 <sup>4</sup>			
				LAB,TW			0 265 006 816 <sup>4</sup>			
				RAB,TW			0 265 006 811 <sup>4</sup>			
							0 265 006 784 <sup>4</sup>			
<b>FT 240 K/S</b> 2.0 TDE	07.03-07.06	55/63				0 265 006 784 <sup>3</sup>				
			TW			0 265 006 784 <sup>3</sup>				
<b>FT 260 K/S</b> 2.0 TD	07.03-07.06	55/63				0 265 006 784 <sup>4</sup>				
			LAB,TW			0 265 006 784 <sup>3</sup>				
<b>FT 260 K/S</b> 2.0 TD	08.00-05.04	55/63				0 265 006 818 <sup>4</sup>				
			LAB,TW			0 265 006 815 <sup>4</sup>				
<b>FT 260 K/S</b> 2.0 TDE	08.00-07.06	55/63				0 265 006 817 <sup>4</sup>				
			RAB,TW			0 265 006 458 <sup>3</sup>				
						0 265 006 460 <sup>4</sup>				
			LAB,TW			0 265 006 816 <sup>4</sup>				
			RAB,TW			0 265 006 811 <sup>4</sup>				
						0 265 006 784 <sup>4</sup>				
						0 265 006 784 <sup>3</sup>				
						0 265 006 458 <sup>3</sup>				
<b>FT 260 K/S</b> 2.0 TDCi	07.03-07.06	74/92				0 265 006 784 <sup>4</sup>				
			LAB,TW			0 265 006 784 <sup>3</sup>				

		S							
<b>FT 260 K/S 2.0 TDCi</b>		08.00-05.04	74/92				LAB, TW	0 265 006 818 <sup>4</sup>	
<b>FT 260 K/S 2.0 TDE</b>		08.00-07.06	74/92				RAB, TW	0 265 006 815 <sup>4</sup>	
							TW	0 265 006 817 <sup>4</sup>	
		11.03-05.04	74/92				RAB, TW	0 265 006 458 <sup>3</sup>	
		05.04-07.06	74/92				LAB, TW	0 265 006 460 <sup>4</sup>	
							RAB, TW	0 265 006 816 <sup>4</sup>	
<b>FT 260 K/S 2.0 TDE</b>		07.03-07.06	55/63				LAB, TW	0 265 006 811 <sup>4</sup>	
							TW	0 265 006 784 <sup>4</sup>	
			74/92				LAB, TW	0 265 006 784 <sup>3</sup>	
							LAB, TW	0 265 006 784 <sup>4</sup>	
							TW	0 265 006 784 <sup>3</sup>	
<b>FT 260 K/S 2.3i</b>		08.01-07.06	103-107					0 265 006 458 <sup>3</sup>	
							LAB, TW	0 265 006 461 <sup>4</sup>	
								0 265 006 814 <sup>4</sup>	
							RAB, TW	0 265 006 460 <sup>4</sup>	
								0 265 006 813 <sup>4</sup>	
		12.02-07.06	103-107				LAB, TW	0 265 006 812 <sup>4</sup>	
		03.04-07.06	103-107				RAB, TW	0 265 006 811 <sup>4</sup>	
<b>FT 260 K/S 2.4 TDE</b>		04.01-07.06	66					0 265 006 458 <sup>3</sup>	
							LAB, TW	0 265 006 461 <sup>4</sup>	
								0 265 006 814 <sup>4</sup>	
							RAB, TW	0 265 006 460 <sup>4</sup>	
								0 265 006 813 <sup>4</sup>	
		12.02-07.06	66				LAB, TW	0 265 006 812 <sup>4</sup>	
		03.04-07.06	66				RAB, TW	0 265 006 811 <sup>4</sup>	
<b>FT 280 K/S 2.0 TD</b>		07.03-07.06	55/63				LAB, TW	0 265 006 784 <sup>4</sup>	
							TW	0 265 006 784 <sup>3</sup>	
<b>FT 280 K/S 2.0 TD</b>		08.00-05.04	55/63				LAB, TW	0 265 006 818 <sup>4</sup>	
<b>FT 280 K/S 2.0 TDE</b>		08.00-07.06	55/63				RAB, TW	0 265 006 815 <sup>4</sup>	
								0 265 006 817 <sup>4</sup>	
							TW	0 265 006 458 <sup>3</sup>	
		11.03-05.04	55/63				RAB, TW	0 265 006 460 <sup>4</sup>	
		05.04-07.06	55/63				LAB, TW	0 265 006 816 <sup>4</sup>	
							RAB, TW	0 265 006 811 <sup>4</sup>	
<b>FT 280 K/S 2.0 TDCi</b>		07.03-07.06	74/92				LAB, TW	0 265 006 784 <sup>4</sup>	
							TW	0 265 006 784 <sup>3</sup>	
<b>FT 280 K/S 2.0 TDCi</b>		08.00-05.04	74/92				LAB, TW	0 265 006 818 <sup>4</sup>	
<b>FT 280 K/S 2.0 TDE</b>		08.00-07.06	74/92				RAB, TW	0 265 006 815 <sup>4</sup>	
								0 265 006 817 <sup>4</sup>	
							TW	0 265 006 458 <sup>3</sup>	
		11.03-05.04	74/92				RAB, TW	0 265 006 460 <sup>4</sup>	
		05.04-07.06	74/92				LAB, TW	0 265 006 816 <sup>4</sup>	
							RAB, TW	0 265 006 811 <sup>4</sup>	
<b>FT 280 K/S 2.0 TDE</b>		07.03-07.06	55/63				LAB, TW	0 265 006 784 <sup>4</sup>	
							TW	0 265 006 784 <sup>3</sup>	
			74/92				LAB, TW	0 265 006 784 <sup>4</sup>	
							TW	0 265 006 784 <sup>3</sup>	
<b>FT 280 K/S 2.3i</b>		08.01-07.06	103-107					0 265 006 458 <sup>3</sup>	
							LAB, TW	0 265 006 461 <sup>4</sup>	
								0 265 006 814 <sup>4</sup>	
							RAB, TW	0 265 006 460 <sup>4</sup>	
								0 265 006 813 <sup>4</sup>	
		12.02-07.06	103-107				LAB, TW	0 265 006 812 <sup>4</sup>	
		03.04-07.06	103-107				RAB, TW	0 265 006 811 <sup>4</sup>	
<b>FT 280 K/S 2.4 TDE</b>		04.01-07.06	66					0 265 006 458 <sup>3</sup>	
							LAB, TW	0 265 006 461 <sup>4</sup>	
								0 265 006 814 <sup>4</sup>	
							RAB, TW	0 265 006 460 <sup>4</sup>	
								0 265 006 813 <sup>4</sup>	
		12.02-07.06	66				LAB, TW	0 265 006 812 <sup>4</sup>	
		03.04-07.06	66				RAB, TW	0 265 006 811 <sup>4</sup>	



		S							
	◀ FORD Transit [00]								
<b>FT 280 L 2.3i</b>		01.00-07.06	66/85/92/				0 265 006 458 <sup>3</sup>		
<b>FT 280 L 2.4 TDE</b>			103-107		LAB,TW		0 265 006 461 <sup>4</sup>		
					RAB,TW		0 265 006 814 <sup>4</sup>		
							0 265 006 460 <sup>4</sup>		
							0 265 006 813 <sup>4</sup>		
		12.02-07.06	66/85/92/103-107		LAB,TW		0 265 006 812 <sup>4</sup>		
		03.04-07.06	66/85/92/103-107		RAB,TW		0 265 006 811 <sup>4</sup>		
<b>FT 280 L 2.4 TDE</b>		01.00-09.03	55				0 265 006 458 <sup>3</sup>		
					LAB,TW		0 265 006 461 <sup>4</sup>		
							0 265 006 814 <sup>4</sup>		
					RAB,TW		0 265 006 460 <sup>4</sup>		
							0 265 006 813 <sup>4</sup>		
		12.02-09.03	55		LAB,TW		0 265 006 812 <sup>4</sup>		
<b>FT 280 M 2.0 TD</b>		07.03-07.06	55/63		LAB,TW		0 265 006 784 <sup>4</sup>		
					TW		0 265 006 784 <sup>3</sup>		
<b>FT 280 M 2.0 TD</b>		08.00-05.04	55/63		LAB,TW		0 265 006 818 <sup>4</sup>		
<b>FT 280 M 2.0 TDE</b>		08.00-07.06	55/63		RAB,TW		0 265 006 815 <sup>4</sup>		
							0 265 006 817 <sup>4</sup>		
					TW		0 265 006 458 <sup>3</sup>		
		11.03-05.04	55/63		RAB,TW		0 265 006 460 <sup>4</sup>		
		05.04-07.06	55/63		LAB,TW		0 265 006 816 <sup>4</sup>		
					RAB,TW		0 265 006 811 <sup>4</sup>		
<b>FT 280 M 2.0 TDCi</b>		07.03-07.06	74/92		LAB,TW		0 265 006 784 <sup>4</sup>		
					TW		0 265 006 784 <sup>3</sup>		
<b>FT 280 M 2.0 TDCi</b>		08.00-05.04	74/92		LAB,TW		0 265 006 818 <sup>4</sup>		
<b>FT 280 M 2.0 TDE</b>		08.00-07.06	74/92		RAB,TW		0 265 006 815 <sup>4</sup>		
							0 265 006 817 <sup>4</sup>		
					TW		0 265 006 458 <sup>3</sup>		
		11.03-05.04	74/92		RAB,TW		0 265 006 460 <sup>4</sup>		
		05.04-07.06	74/92		LAB,TW		0 265 006 816 <sup>4</sup>		
					RAB,TW		0 265 006 811 <sup>4</sup>		
<b>FT 280 M 2.0 TDE</b>		07.03-07.06	55/63		LAB,TW		0 265 006 784 <sup>4</sup>		
					TW		0 265 006 784 <sup>3</sup>		
			74/92		LAB,TW		0 265 006 784 <sup>4</sup>		
					TW		0 265 006 784 <sup>3</sup>		
<b>FT 280 M 2.3i</b>		08.01-07.06	103-107				0 265 006 458 <sup>3</sup>		
					LAB,TW		0 265 006 461 <sup>4</sup>		
							0 265 006 814 <sup>4</sup>		
					RAB,TW		0 265 006 460 <sup>4</sup>		
							0 265 006 813 <sup>4</sup>		
		12.02-07.06	103-107		LAB,TW		0 265 006 812 <sup>4</sup>		
		03.04-07.06	103-107		RAB,TW		0 265 006 811 <sup>4</sup>		
<b>FT 280 M 2.4 TDE</b>		04.01-07.06	66				0 265 006 458 <sup>3</sup>		
					LAB,TW		0 265 006 461 <sup>4</sup>		
							0 265 006 814 <sup>4</sup>		
					RAB,TW		0 265 006 460 <sup>4</sup>		
							0 265 006 813 <sup>4</sup>		
		12.02-07.06	66		LAB,TW		0 265 006 812 <sup>4</sup>		
		03.04-07.06	66		RAB,TW		0 265 006 811 <sup>4</sup>		
<b>FT 280 S 2.4 TDI</b>		01.01-09.03	66		LAB,OZB		0 265 006 461 <sup>4</sup>		
					OZB,RAB		0 265 006 460 <sup>4</sup>		
		01.01-05.06	66				0 265 006 458 <sup>3</sup>		
					LAB,ZWB		0 265 006 814 <sup>4</sup>		
					RAB,ZWB		0 265 006 813 <sup>4</sup>		
		10.03-05.06	66		LAB,OZB		0 265 006 812 <sup>4</sup>		
					OZB,RAB		0 265 006 811 <sup>4</sup>		
<b>FT 300 K/S 2.0 TD</b>		07.03-07.06	55/63/74/ 92		LAB,TW		0 265 006 784 <sup>4</sup>		
					TW		0 265 006 784 <sup>3</sup>		
<b>FT 300 K/S 2.0 TD</b>		08.00-05.04	55/63/74/92		LAB,TW		0 265 006 818 <sup>4</sup>		
<b>FT 300 K/S 2.0 TDCi</b>		08.00-07.06	55/63/74/		RAB,TW		0 265 006 815 <sup>4</sup>		
<b>FT 300 K/S 2.0 TDE</b>			92				0 265 006 817 <sup>4</sup>		
					TW		0 265 006 458 <sup>3</sup>		



	S							
<b>FT 300 K/S 2.0 TD</b>	11.03-05.04	55/63/74/92				RAB,TW	0 265 006 460 <sup>4</sup>	
<b>FT 300 K/S 2.0 TDCi</b>	05.04-07.06	55/63/74/				LAB,TW	0 265 006 816 <sup>4</sup>	
<b>FT 300 K/S 2.0 TDE</b>		92				RAB,TW	0 265 006 811 <sup>4</sup>	
<b>FT 300 K/S 2.0 TDCi</b>	07.03-07.06	55/63/74/				LAB,TW	0 265 006 784 <sup>4</sup>	
		92				TW	0 265 006 784 <sup>3</sup>	
<b>FT 300 K/S 2.0 TDE</b>	07.03-07.06	55/63/74/				LAB,TW	0 265 006 784 <sup>4</sup>	
		92				TW	0 265 006 784 <sup>3</sup>	
<b>FT 300 K/S 2.3i</b>	08.00-07.06	107					0 265 006 458 <sup>3</sup>	
						LAB,TW	0 265 006 461 <sup>4</sup>	
							0 265 006 814 <sup>4</sup>	
						RAB,TW	0 265 006 460 <sup>4</sup>	
							0 265 006 813 <sup>4</sup>	
	12.02-07.06	107				LAB,TW	0 265 006 812 <sup>4</sup>	
	03.04-07.06	107				RAB,TW	0 265 006 811 <sup>4</sup>	
<b>FT 300 L 2.0 TD</b>	07.03-07.06	55/63/74/				LAB,TW	0 265 006 784 <sup>4</sup>	
		92				TW	0 265 006 784 <sup>3</sup>	
<b>FT 300 L 2.0 TD</b>	08.00-05.04	55/63/74/92				LAB,TW	0 265 006 818 <sup>4</sup>	
<b>FT 300 L 2.0 TDCi</b>	08.00-07.06	55/63/74/				RAB,TW	0 265 006 815 <sup>4</sup>	
<b>FT 300 L 2.0 TDE</b>		92					0 265 006 817 <sup>4</sup>	
						TW	0 265 006 458 <sup>3</sup>	
	11.03-05.04	55/63/74/92				RAB,TW	0 265 006 460 <sup>4</sup>	
	05.04-07.06	55/63/74/				LAB,TW	0 265 006 816 <sup>4</sup>	
		92				RAB,TW	0 265 006 811 <sup>4</sup>	
<b>FT 300 L 2.0 TDCi</b>	07.03-07.06	55/63/74/				LAB,TW	0 265 006 784 <sup>4</sup>	
		92				TW	0 265 006 784 <sup>3</sup>	
<b>FT 300 L 2.0 TDE</b>	07.03-07.06	55/63/74/				LAB,TW	0 265 006 784 <sup>4</sup>	
		92				TW	0 265 006 784 <sup>3</sup>	
<b>FT 300 L 2.3i</b>	08.00-07.06	107					0 265 006 458 <sup>3</sup>	
						LAB,TW	0 265 006 461 <sup>4</sup>	
							0 265 006 814 <sup>4</sup>	
						RAB,TW	0 265 006 460 <sup>4</sup>	
							0 265 006 813 <sup>4</sup>	
	12.02-07.06	107				LAB,TW	0 265 006 812 <sup>4</sup>	
	03.04-07.06	107				RAB,TW	0 265 006 811 <sup>4</sup>	
<b>FT 300 M 2.0 TD</b>	07.03-07.06	55/63/74/				LAB,TW	0 265 006 784 <sup>4</sup>	
		92				TW	0 265 006 784 <sup>3</sup>	
<b>FT 300 M 2.0 TD</b>	08.00-05.04	55/63/74/92				LAB,TW	0 265 006 818 <sup>4</sup>	
<b>FT 300 M 2.0 TDCi</b>	08.00-07.06	55/63/74/				RAB,TW	0 265 006 815 <sup>4</sup>	
<b>FT 300 M 2.0 TDE</b>		92					0 265 006 817 <sup>4</sup>	
						TW	0 265 006 458 <sup>3</sup>	
	11.03-05.04	55/63/74/92				RAB,TW	0 265 006 460 <sup>4</sup>	
	05.04-07.06	55/63/74/				LAB,TW	0 265 006 816 <sup>4</sup>	
		92				RAB,TW	0 265 006 811 <sup>4</sup>	
<b>FT 300 M 2.0 TDCi</b>	07.03-07.06	55/63/74/				LAB,TW	0 265 006 784 <sup>4</sup>	
		92				TW	0 265 006 784 <sup>3</sup>	
<b>FT 300 M 2.0 TDE</b>	07.03-07.06	55/63/74/				LAB,TW	0 265 006 784 <sup>4</sup>	
		92				TW	0 265 006 784 <sup>3</sup>	
<b>FT 300 M 2.3i</b>	08.00-07.06	107					0 265 006 458 <sup>3</sup>	
						LAB,TW	0 265 006 461 <sup>4</sup>	
							0 265 006 814 <sup>4</sup>	
						RAB,TW	0 265 006 460 <sup>4</sup>	
							0 265 006 813 <sup>4</sup>	
	12.02-07.06	107				LAB,TW	0 265 006 812 <sup>4</sup>	
	03.04-07.06	107				RAB,TW	0 265 006 811 <sup>4</sup>	
<b>FT 300 S 2.0 TDCi</b>	05.02-05.04	92				LAB,TW	0 265 006 818 <sup>4</sup>	
	05.02-05.06	92				RAB,TW	0 265 006 815 <sup>4</sup>	
							0 265 006 817 <sup>4</sup>	
						TW	0 265 006 458 <sup>3</sup>	
							0 265 006 784 <sup>3</sup>	
	07.03-05.06	92				LAB,TW	0 265 006 784 <sup>4</sup>	
	05.04-05.06	92				LAB,TW	0 265 006 816 <sup>4</sup>	
<b>FT 300 S 2.4 TDI</b>	01.01-09.03	66/74				LAB,OZB	0 265 006 461 <sup>4</sup>	
						OZB,RAB	0 265 006 460 <sup>4</sup>	















**F** ◀ FORD Transit [00]









<b>FT 300 S</b> 2.4 TDI	01.01-05.06	66/74		0 265 006 458 <sup>3</sup>
			LAB,ZWB	0 265 006 814 <sup>4</sup>
			RAB,ZWB	0 265 006 813 <sup>4</sup>
	10.03-05.06	66/74	LAB,OZB	0 265 006 812 <sup>4</sup>
			OZB,RAB	0 265 006 811 <sup>4</sup>
<b>FT 310 S</b> 2.4 TDI	01.01-09.03	88	LAB,OZB	0 265 006 461 <sup>4</sup>
			OZB,RAB	0 265 006 460 <sup>4</sup>
	01.01-05.06	88		0 265 006 458 <sup>3</sup>
			LAB,ZWB	0 265 006 814 <sup>4</sup>
			RAB,ZWB	0 265 006 813 <sup>4</sup>
	10.03-05.06	88	LAB,OZB	0 265 006 812 <sup>4</sup>
			OZB,RAB	0 265 006 811 <sup>4</sup>
<b>FT 330 K/S</b> 2.0 TDCi	05.02-05.04	92	LAB,TW	0 265 006 818 <sup>4</sup>
	05.02-07.06	92	RAB,TW	0 265 006 815 <sup>4</sup>
				0 265 006 817 <sup>4</sup>
			TW	0 265 006 458 <sup>3</sup>
	07.03-07.06	92	LAB,TW	0 265 006 784 <sup>4</sup>
			TW	0 265 006 784 <sup>3</sup>
	11.03-05.04	92	RAB,TW	0 265 006 460 <sup>4</sup>
	05.04-07.06	92	LAB,TW	0 265 006 816 <sup>4</sup>
			RAB,TW	0 265 006 811 <sup>4</sup>
<b>FT 330 K/S</b> 2.0 TDE	08.03-05.04	74	LAB,TW	0 265 006 818 <sup>4</sup>
	08.03-07.06	74	LAB,TW	0 265 006 784 <sup>4</sup>
			RAB,TW	0 265 006 815 <sup>4</sup>
				0 265 006 817 <sup>4</sup>
			TW	0 265 006 458 <sup>3</sup>
				0 265 006 784 <sup>3</sup>
	11.03-05.04	74	RAB,TW	0 265 006 460 <sup>4</sup>
	05.04-07.06	74	LAB,TW	0 265 006 816 <sup>4</sup>
			RAB,TW	0 265 006 811 <sup>4</sup>
<b>FT 330 K/S</b> 2.3i	12.00-07.06	101/		0 265 006 458 <sup>3</sup>
<b>FT 330 K/S</b> 2.4 TDCi		103-107	LAB,TW	0 265 006 461 <sup>4</sup>
				0 265 006 814 <sup>4</sup>
			RAB,TW	0 265 006 460 <sup>4</sup>
				0 265 006 813 <sup>4</sup>
	12.02-07.06	101/103-107	LAB,TW	0 265 006 812 <sup>4</sup>
	03.04-07.06	101/103-107	RAB,TW	0 265 006 811 <sup>4</sup>
<b>FT 330 K/S</b> 2.4 TD	01.00-09.03	55		0 265 006 458 <sup>3</sup>
			LAB,TW	0 265 006 461 <sup>4</sup>
				0 265 006 814 <sup>4</sup>
			RAB,TW	0 265 006 460 <sup>4</sup>
				0 265 006 813 <sup>4</sup>
	12.02-09.03	55	LAB,TW	0 265 006 812 <sup>4</sup>
<b>FT 330 K/S</b> 2.4 TDE	01.00-07.06	66		0 265 006 458 <sup>3</sup>
			LAB,TW	0 265 006 461 <sup>4</sup>
				0 265 006 814 <sup>4</sup>
			RAB,TW	0 265 006 460 <sup>4</sup>
				0 265 006 813 <sup>4</sup>
		85/88		0 265 006 458 <sup>3</sup>
			LAB,TW	0 265 006 461 <sup>4</sup>
				0 265 006 814 <sup>4</sup>
			RAB,TW	0 265 006 460 <sup>4</sup>
				0 265 006 813 <sup>4</sup>
		92		0 265 006 458 <sup>3</sup>
			LAB,TW	0 265 006 461 <sup>4</sup>
				0 265 006 814 <sup>4</sup>
			RAB,TW	0 265 006 460 <sup>4</sup>
				0 265 006 813 <sup>4</sup>
	12.02-07.06	66	LAB,TW	0 265 006 812 <sup>4</sup>
		85/88	LAB,TW	0 265 006 812 <sup>4</sup>
		92	LAB,TW	0 265 006 812 <sup>4</sup>

		S							
<b>FT 330 K/S 2.4 TDE</b>	03.04-07.06	66				RAB,TW	0 265 006 811 <sup>4</sup>		
		85/88				RAB,TW	0 265 006 811 <sup>4</sup>		
		92				RAB,TW	0 265 006 811 <sup>4</sup>		
<b>FT 330 L 2.0 TDCi</b>	05.02-05.04	92				LAB,TW	0 265 006 818 <sup>4</sup>		
	05.02-07.06	92				RAB,TW	0 265 006 815 <sup>4</sup>		
						TW	0 265 006 817 <sup>4</sup>		
						TW	0 265 006 458 <sup>3</sup>		
	07.03-07.06	92				LAB,TW	0 265 006 784 <sup>4</sup>		
						TW	0 265 006 784 <sup>3</sup>		
	11.03-05.04	92				RAB,TW	0 265 006 460 <sup>4</sup>		
	05.04-07.06	92				LAB,TW	0 265 006 816 <sup>4</sup>		
<b>FT 330 L 2.0 TDE</b>	08.03-05.04	74				LAB,TW	0 265 006 818 <sup>4</sup>		
	08.03-07.06	74				LAB,TW	0 265 006 784 <sup>4</sup>		
						RAB,TW	0 265 006 815 <sup>4</sup>		
						TW	0 265 006 817 <sup>4</sup>		
						TW	0 265 006 458 <sup>3</sup>		
						TW	0 265 006 784 <sup>3</sup>		
	11.03-05.04	74				RAB,TW	0 265 006 460 <sup>4</sup>		
	05.04-07.06	74				LAB,TW	0 265 006 816 <sup>4</sup>		
<b>FT 330 L 2.3i</b> <b>FT 330 L 2.4 TDCi</b>	12.00-07.06	101/ 103-107					0 265 006 458 <sup>3</sup>		
						LAB,TW	0 265 006 461 <sup>4</sup>		
						RAB,TW	0 265 006 814 <sup>4</sup>		
						RAB,TW	0 265 006 460 <sup>4</sup>		
							0 265 006 813 <sup>4</sup>		
	12.02-07.06	101/103-107				LAB,TW	0 265 006 812 <sup>4</sup>		
	03.04-07.06	101/103-107				RAB,TW	0 265 006 811 <sup>4</sup>		
							0 265 006 458 <sup>3</sup>		
<b>FT 330 L 2.4 TD</b>	01.00-09.03	55					0 265 006 458 <sup>3</sup>		
						LAB,TW	0 265 006 461 <sup>4</sup>		
							0 265 006 814 <sup>4</sup>		
						RAB,TW	0 265 006 460 <sup>4</sup>		
							0 265 006 813 <sup>4</sup>		
<b>FT 330 L 2.4 TDE</b>	12.02-09.03	55				LAB,TW	0 265 006 812 <sup>4</sup>		
	01.00-07.06	66				LAB,TW	0 265 006 461 <sup>4</sup>		
						RAB,TW	0 265 006 814 <sup>4</sup>		
						RAB,TW	0 265 006 460 <sup>4</sup>		
							0 265 006 813 <sup>4</sup>		
		88				LAB,TW	0 265 006 461 <sup>4</sup>		
							0 265 006 814 <sup>4</sup>		
						RAB,TW	0 265 006 460 <sup>4</sup>		
							0 265 006 813 <sup>4</sup>		
		92					0 265 006 458 <sup>3</sup>		
						LAB,TW	0 265 006 461 <sup>4</sup>		
							0 265 006 814 <sup>4</sup>		
						RAB,TW	0 265 006 460 <sup>4</sup>		
							0 265 006 813 <sup>4</sup>		
	12.02-07.06	66				LAB,TW	0 265 006 812 <sup>4</sup>		
		88				LAB,TW	0 265 006 812 <sup>4</sup>		
		92				LAB,TW	0 265 006 812 <sup>4</sup>		
03.04-07.06	66				RAB,TW	0 265 006 811 <sup>4</sup>			
	85					0 265 006 458 <sup>3</sup>			
					LAB,TW	0 265 006 461 <sup>4</sup>			
						0 265 006 812 <sup>4</sup>			
						0 265 006 814 <sup>4</sup>			
					RAB,TW	0 265 006 460 <sup>4</sup>			
						0 265 006 811 <sup>4</sup>			
						0 265 006 813 <sup>4</sup>			
	88				RAB,TW	0 265 006 811 <sup>4</sup>			
	92				RAB,TW	0 265 006 811 <sup>4</sup>			
<b>FT 330 L 2.4 TDE</b>	01.00-07.06	66					0 265 006 458 <sup>3</sup>		
<b>FT 330 L 2.4 TDI</b>		88					0 265 006 458 <sup>3</sup>		



		S								
	◀ FORD Transit [00]									
<b>FT 330 L 2.4 TDI</b>	01.01-09.03	66	LAB,OZB	0 265 006 461 <sup>4</sup>						
			OZB,RAB	0 265 006 460 <sup>4</sup>						
		88	LAB,OZB	0 265 006 461 <sup>4</sup>						
			OZB,RAB	0 265 006 460 <sup>4</sup>						
	01.01-05.06	66	LAB,ZWB	0 265 006 814 <sup>4</sup>						
			RAB,ZWB	0 265 006 813 <sup>4</sup>						
		88	LAB,ZWB	0 265 006 814 <sup>4</sup>						
			RAB,ZWB	0 265 006 813 <sup>4</sup>						
	10.03-05.06	66	LAB,OZB	0 265 006 812 <sup>4</sup>						
			OZB,RAB	0 265 006 811 <sup>4</sup>						
		88	LAB,OZB	0 265 006 812 <sup>4</sup>						
			OZB,RAB	0 265 006 811 <sup>4</sup>						
<b>FT 330 M 2.0 TDCi</b>	05.02-05.04	92	LAB,TW	0 265 006 818 <sup>4</sup>						
			RAB,TW	0 265 006 815 <sup>4</sup>						
			TW	0 265 006 458 <sup>3</sup>						
			LAB,TW	0 265 006 784 <sup>4</sup>						
	07.03-07.06	92	TW	0 265 006 784 <sup>3</sup>						
			RAB,TW	0 265 006 460 <sup>4</sup>						
	11.03-05.04	92	LAB,TW	0 265 006 816 <sup>4</sup>						
			RAB,TW	0 265 006 811 <sup>4</sup>						
	05.04-07.06	92	LAB,TW	0 265 006 811 <sup>4</sup>						
			RAB,TW	0 265 006 811 <sup>4</sup>						
<b>FT 330 M 2.0 TDE</b>	08.03-05.04	74	LAB,TW	0 265 006 818 <sup>4</sup>						
			LAB,TW	0 265 006 784 <sup>4</sup>						
		74	RAB,TW	0 265 006 815 <sup>4</sup>						
			TW	0 265 006 817 <sup>4</sup>						
			TW	0 265 006 458 <sup>3</sup>						
			TW	0 265 006 784 <sup>3</sup>						
	11.03-05.04	74	RAB,TW	0 265 006 460 <sup>4</sup>						
			LAB,TW	0 265 006 816 <sup>4</sup>						
05.04-07.06	74	RAB,TW	0 265 006 811 <sup>4</sup>							
		RAB,TW	0 265 006 811 <sup>4</sup>							
<b>FT 330 M 2.3i</b> <b>FT 330 M 2.4 TDCi</b>	12.00-07.06	101/ 103-107		0 265 006 458 <sup>3</sup>						
			LAB,TW	0 265 006 461 <sup>4</sup>						
			RAB,TW	0 265 006 814 <sup>4</sup>						
			RAB,TW	0 265 006 460 <sup>4</sup>						
				0 265 006 813 <sup>4</sup>						
			LAB,TW	0 265 006 812 <sup>4</sup>						
	12.02-07.06	101/103-107	LAB,TW	0 265 006 812 <sup>4</sup>						
			RAB,TW	0 265 006 811 <sup>4</sup>						
	03.04-07.06	101/103-107		0 265 006 811 <sup>4</sup>						
				0 265 006 458 <sup>3</sup>						
<b>FT 330 M 2.4 TD</b>	01.00-09.03	55	LAB,TW	0 265 006 461 <sup>4</sup>						
				0 265 006 814 <sup>4</sup>						
			RAB,TW	0 265 006 460 <sup>4</sup>						
				0 265 006 813 <sup>4</sup>						
	12.02-09.03	55	LAB,TW	0 265 006 812 <sup>4</sup>						
				0 265 006 814 <sup>4</sup>						
	<b>FT 330 M 2.4 TDE</b>	01.00-07.06	66	LAB,TW	0 265 006 461 <sup>4</sup>					
					0 265 006 814 <sup>4</sup>					
				RAB,TW	0 265 006 460 <sup>4</sup>					
					0 265 006 813 <sup>4</sup>					
		88	LAB,TW	0 265 006 461 <sup>4</sup>						
				0 265 006 814 <sup>4</sup>						
			RAB,TW	0 265 006 460 <sup>4</sup>						
				0 265 006 813 <sup>4</sup>						
		92		0 265 006 458 <sup>3</sup>						
			LAB,TW	0 265 006 461 <sup>4</sup>						
			0 265 006 814 <sup>4</sup>							
		RAB,TW	0 265 006 460 <sup>4</sup>							
			0 265 006 813 <sup>4</sup>							
		LAB,TW	0 265 006 812 <sup>4</sup>							
12.02-07.06	66	LAB,TW	0 265 006 812 <sup>4</sup>							
		LAB,TW	0 265 006 812 <sup>4</sup>							
	88	LAB,TW	0 265 006 812 <sup>4</sup>							
		LAB,TW	0 265 006 812 <sup>4</sup>							
03.04-07.06	66	RAB,TW	0 265 006 811 <sup>4</sup>							
			0 265 006 458 <sup>3</sup>							
	85		0 265 006 458 <sup>3</sup>							











		<b>S</b>													
<b>FT 330 M 2.4 TDE</b>	03.04-07.06	85					LAB, TW	0 265 006 461 <sup>4</sup>							
								0 265 006 812 <sup>4</sup>							
								0 265 006 814 <sup>4</sup>							
								RAB, TW	0 265 006 460 <sup>4</sup>						
									0 265 006 811 <sup>4</sup>						
									0 265 006 813 <sup>4</sup>						
	88						RAB, TW	0 265 006 811 <sup>4</sup>							
	92						RAB, TW	0 265 006 811 <sup>4</sup>							
<b>FT 330 M 2.4 TDE</b>	01.00-07.06	66						0 265 006 458 <sup>3</sup>							
<b>FT 330 M 2.4 TDI</b>		88						0 265 006 458 <sup>3</sup>							
<b>FT 330 M 2.4 TDI</b>	01.01-09.03	66					LAB, OZB	0 265 006 461 <sup>4</sup>							
							OZB, RAB	0 265 006 460 <sup>4</sup>							
							88	LAB, OZB	0 265 006 461 <sup>4</sup>						
								OZB, RAB	0 265 006 460 <sup>4</sup>						
	01.01-05.06	66						LAB, ZWB	0 265 006 814 <sup>4</sup>						
								RAB, ZWB	0 265 006 813 <sup>4</sup>						
								88	LAB, ZWB	0 265 006 814 <sup>4</sup>					
								RAB, ZWB	0 265 006 813 <sup>4</sup>						
	10.03-05.06	66						LAB, OZB	0 265 006 812 <sup>4</sup>						
								OZB, RAB	0 265 006 811 <sup>4</sup>						
								88	LAB, OZB	0 265 006 812 <sup>4</sup>					
								OZB, RAB	0 265 006 811 <sup>4</sup>						
<b>FT 330 S 2.4 TDI</b>	01.01-09.03	66/74/88					LAB, OZB	0 265 006 461 <sup>4</sup>							
							OZB, RAB	0 265 006 460 <sup>4</sup>							
	01.01-05.06	66/74/88							0 265 006 458 <sup>3</sup>						
								LAB, ZWB	0 265 006 814 <sup>4</sup>						
								RAB, ZWB	0 265 006 813 <sup>4</sup>						
	10.03-05.06	66/74/88						LAB, OZB	0 265 006 812 <sup>4</sup>						
OZB, RAB								0 265 006 811 <sup>4</sup>							
<b>FT 350 EL 2.0 TDCi</b>	05.02-05.04	92					LAB, TW	0 265 006 818 <sup>4</sup>							
							05.02-07.06	92					RAB, TW	0 265 006 815 <sup>4</sup>	
									0 265 006 817 <sup>4</sup>						
								TW	0 265 006 458 <sup>3</sup>						
	07.03-07.06	92						LAB, TW	0 265 006 784 <sup>4</sup>						
														TW	0 265 006 784 <sup>3</sup>
	11.03-05.04	92						RAB, TW	0 265 006 460 <sup>4</sup>						
	05.04-07.06	92						LAB, TW	0 265 006 816 <sup>4</sup>						
							RAB, TW	0 265 006 811 <sup>4</sup>							
<b>FT 350 EL 2.0 TDE</b>	08.03-05.04	74					LAB, TW	0 265 006 818 <sup>4</sup>							
							08.03-07.06	74					LAB, TW	0 265 006 784 <sup>4</sup>	
									0 265 006 815 <sup>4</sup>						
								TW	0 265 006 458 <sup>3</sup>						
									0 265 006 784 <sup>3</sup>						
	11.03-05.04	74						RAB, TW	0 265 006 460 <sup>4</sup>						
	05.04-07.06	74						LAB, TW	0 265 006 816 <sup>4</sup>						
								RAB, TW	0 265 006 811 <sup>4</sup>						
<b>FT 350 EL 2.3i</b>	12.00-07.06	101/						0 265 006 458 <sup>3</sup>							
<b>FT 350 EL 2.4 TDCi</b>		103-107					LAB, TW	0 265 006 461 <sup>4</sup>							
								0 265 006 814 <sup>4</sup>							
								RAB, TW	0 265 006 460 <sup>4</sup>						
								0 265 006 813 <sup>4</sup>							
							12.02-07.06	101/103-107					LAB, TW	0 265 006 812 <sup>4</sup>	
							03.04-07.06	101/103-107					RAB, TW	0 265 006 811 <sup>4</sup>	
<b>FT 350 EL 2.4 TD</b>	01.00-09.03	55						0 265 006 458 <sup>3</sup>							
								LAB, TW	0 265 006 461 <sup>4</sup>						
									0 265 006 814 <sup>4</sup>						
								RAB, TW	0 265 006 460 <sup>4</sup>						
									0 265 006 813 <sup>4</sup>						
	12.02-09.03	55						LAB, TW	0 265 006 812 <sup>4</sup>						



		S							
	◀ FORD Transit [00]								
<b>FT 350 EL 2.4 TDE</b>	01.00-07.06	66					0 265 006 458 <sup>3</sup>		
					LAB,TW		0 265 006 461 <sup>4</sup>		
							0 265 006 814 <sup>4</sup>		
					RAB,TW		0 265 006 460 <sup>4</sup>		
							0 265 006 813 <sup>4</sup>		
		92					0 265 006 458 <sup>3</sup>		
					LAB,TW		0 265 006 461 <sup>4</sup>		
							0 265 006 814 <sup>4</sup>		
					RAB,TW		0 265 006 460 <sup>4</sup>		
							0 265 006 813 <sup>4</sup>		
	12.02-07.06	66			LAB,TW		0 265 006 812 <sup>4</sup>		
		92			LAB,TW		0 265 006 812 <sup>4</sup>		
	03.04-07.06	66			RAB,TW		0 265 006 811 <sup>4</sup>		
		85					0 265 006 458 <sup>3</sup>		
					LAB,TW		0 265 006 461 <sup>4</sup>		
							0 265 006 812 <sup>4</sup>		
							0 265 006 814 <sup>4</sup>		
					RAB,TW		0 265 006 460 <sup>4</sup>		
							0 265 006 811 <sup>4</sup>		
							0 265 006 813 <sup>4</sup>		
		92			RAB,TW		0 265 006 811 <sup>4</sup>		
<b>FT 350 E 2.4 TDI</b>	01.01-09.03	66/88			LAB,OZB		0 265 006 461 <sup>4</sup>		
					OZB,RAB		0 265 006 460 <sup>4</sup>		
	01.01-05.06	66/88					0 265 006 458 <sup>3</sup>		
					LAB,ZWB		0 265 006 814 <sup>4</sup>		
					RAB,ZWB		0 265 006 813 <sup>4</sup>		
	10.03-05.06	66/88			LAB,OZB		0 265 006 812 <sup>4</sup>		
					OZB,RAB		0 265 006 811 <sup>4</sup>		
	06.04-05.06	96					0 265 006 458 <sup>3</sup>		
					LAB,OZB		0 265 006 812 <sup>4</sup>		
					LAB,ZWB		0 265 006 814 <sup>4</sup>		
					OZB,RAB		0 265 006 811 <sup>4</sup>		
					RAB,ZWB		0 265 006 813 <sup>4</sup>		
<b>FT 350 L 2.0 TDCi</b>	05.02-05.04	92			LAB,TW		0 265 006 818 <sup>4</sup>		
	05.02-07.06	92			RAB,TW		0 265 006 815 <sup>4</sup>		
							0 265 006 817 <sup>4</sup>		
					TW		0 265 006 458 <sup>3</sup>		
	07.03-07.06	92			LAB,TW		0 265 006 784 <sup>4</sup>		
					TW		0 265 006 784 <sup>3</sup>		
	11.03-05.04	92			RAB,TW		0 265 006 460 <sup>4</sup>		
	05.04-07.06	92			LAB,TW		0 265 006 816 <sup>4</sup>		
					RAB,TW		0 265 006 811 <sup>4</sup>		
<b>FT 350 L 2.0 TDE</b>	08.03-05.04	74			LAB,TW		0 265 006 818 <sup>4</sup>		
	08.03-07.06	74			LAB,TW		0 265 006 784 <sup>4</sup>		
					RAB,TW		0 265 006 815 <sup>4</sup>		
							0 265 006 817 <sup>4</sup>		
					TW		0 265 006 458 <sup>3</sup>		
							0 265 006 784 <sup>3</sup>		
	11.03-05.04	74			RAB,TW		0 265 006 460 <sup>4</sup>		
	05.04-07.06	74			LAB,TW		0 265 006 816 <sup>4</sup>		
					RAB,TW		0 265 006 811 <sup>4</sup>		
<b>FT 350 L 2.3i</b>	12.00-07.06	101/					0 265 006 458 <sup>3</sup>		
<b>FT 350 L 2.4 TDCi</b>		103-107			LAB,TW		0 265 006 461 <sup>4</sup>		
							0 265 006 814 <sup>4</sup>		
					RAB,TW		0 265 006 460 <sup>4</sup>		
							0 265 006 813 <sup>4</sup>		
	12.02-07.06	101/103-107			LAB,TW		0 265 006 812 <sup>4</sup>		
	03.04-07.06	101/103-107			RAB,TW		0 265 006 811 <sup>4</sup>		
<b>FT 350 L 2.4 TD</b>	01.00-09.03	55					0 265 006 458 <sup>3</sup>		
					LAB,TW		0 265 006 461 <sup>4</sup>		
							0 265 006 814 <sup>4</sup>		
					RAB,TW		0 265 006 460 <sup>4</sup>		
							0 265 006 813 <sup>4</sup>		



























		S							
<b>FT 350 L 2.4 TD</b>		12.02-09.03	55				LAB,TW	0 265 006 812 <sup>4</sup>	
<b>FT 350 L 2.4 TDE</b>		01.00-07.06	66				LAB,TW	0 265 006 461 <sup>4</sup>	
								0 265 006 814 <sup>4</sup>	
							RAB,TW	0 265 006 460 <sup>4</sup>	
								0 265 006 813 <sup>4</sup>	
			88				LAB,TW	0 265 006 461 <sup>4</sup>	
								0 265 006 814 <sup>4</sup>	
							RAB,TW	0 265 006 460 <sup>4</sup>	
								0 265 006 813 <sup>4</sup>	
			92					0 265 006 458 <sup>3</sup>	
							LAB,TW	0 265 006 461 <sup>4</sup>	
								0 265 006 814 <sup>4</sup>	
							RAB,TW	0 265 006 460 <sup>4</sup>	
								0 265 006 813 <sup>4</sup>	
		12.02-07.06	66				LAB,TW	0 265 006 812 <sup>4</sup>	
			88				LAB,TW	0 265 006 812 <sup>4</sup>	
			92				LAB,TW	0 265 006 812 <sup>4</sup>	
		03.04-07.06	66				RAB,TW	0 265 006 811 <sup>4</sup>	
			85					0 265 006 458 <sup>3</sup>	
							LAB,TW	0 265 006 461 <sup>4</sup>	
								0 265 006 812 <sup>4</sup>	
								0 265 006 814 <sup>4</sup>	
							RAB,TW	0 265 006 460 <sup>4</sup>	
								0 265 006 811 <sup>4</sup>	
								0 265 006 813 <sup>4</sup>	
			88				RAB,TW	0 265 006 811 <sup>4</sup>	
			92				RAB,TW	0 265 006 811 <sup>4</sup>	
<b>FT 350 L 2.4 TDE</b>		01.00-07.06	66					0 265 006 458 <sup>3</sup>	
<b>FT 350 L 2.4 TDI</b>			88					0 265 006 458 <sup>3</sup>	
<b>FT 350 L 2.4 TDI</b>		01.01-09.03	66				LAB,OZB	0 265 006 461 <sup>4</sup>	
							OZB,RAB	0 265 006 460 <sup>4</sup>	
			88				LAB,OZB	0 265 006 461 <sup>4</sup>	
							OZB,RAB	0 265 006 460 <sup>4</sup>	
		01.01-05.06	66				LAB,ZWB	0 265 006 814 <sup>4</sup>	
							RAB,ZWB	0 265 006 813 <sup>4</sup>	
			88				LAB,ZWB	0 265 006 814 <sup>4</sup>	
							RAB,ZWB	0 265 006 813 <sup>4</sup>	
		10.03-05.06	66				LAB,OZB	0 265 006 812 <sup>4</sup>	
							OZB,RAB	0 265 006 811 <sup>4</sup>	
			88				LAB,OZB	0 265 006 812 <sup>4</sup>	
							OZB,RAB	0 265 006 811 <sup>4</sup>	
		06.04-05.06	96					0 265 006 458 <sup>3</sup>	
							LAB,OZB	0 265 006 812 <sup>4</sup>	
							LAB,ZWB	0 265 006 814 <sup>4</sup>	
							OZB,RAB	0 265 006 811 <sup>4</sup>	
							RAB,ZWB	0 265 006 813 <sup>4</sup>	
<b>FT 350 M 2.0 TDCi</b>		05.02-05.04	92				LAB,TW	0 265 006 818 <sup>4</sup>	
		05.02-07.06	92				RAB,TW	0 265 006 815 <sup>4</sup>	
								0 265 006 817 <sup>4</sup>	
							TW	0 265 006 458 <sup>3</sup>	
		07.03-07.06	92				LAB,TW	0 265 006 784 <sup>4</sup>	
							TW	0 265 006 784 <sup>3</sup>	
		11.03-05.04	92				RAB,TW	0 265 006 460 <sup>4</sup>	
		05.04-07.06	92				LAB,TW	0 265 006 816 <sup>4</sup>	
							RAB,TW	0 265 006 811 <sup>4</sup>	
<b>FT 350 M 2.0 TDE</b>		08.03-05.04	74				LAB,TW	0 265 006 818 <sup>4</sup>	
		08.03-07.06	74				LAB,TW	0 265 006 784 <sup>4</sup>	
							RAB,TW	0 265 006 815 <sup>4</sup>	
								0 265 006 817 <sup>4</sup>	
							TW	0 265 006 458 <sup>3</sup>	
								0 265 006 784 <sup>3</sup>	
		11.03-05.04	74				RAB,TW	0 265 006 460 <sup>4</sup>	





◀ FORD Transit [00]								
<b>FT 350 M 2.0 TDE</b>	05.04-07.06	74	LAB,TW	0 265 006 816 <sup>4</sup>				
			RAB,TW	0 265 006 811 <sup>4</sup>				
<b>FT 350 M 2.3i</b>	12.00-07.06	101/		0 265 006 458 <sup>3</sup>				
<b>FT 350 M 2.4 TDCi</b>		103-107	LAB,TW	0 265 006 461 <sup>4</sup>				
			RAB,TW	0 265 006 814 <sup>4</sup>				
				0 265 006 460 <sup>4</sup>				
				0 265 006 813 <sup>4</sup>				
	12.02-07.06	101/103-107	LAB,TW	0 265 006 812 <sup>4</sup>				
	03.04-07.06	101/103-107	RAB,TW	0 265 006 811 <sup>4</sup>				
<b>FT 350 M 2.4 TD</b>	01.00-09.03	55		0 265 006 458 <sup>3</sup>				
			LAB,TW	0 265 006 461 <sup>4</sup>				
			RAB,TW	0 265 006 460 <sup>4</sup>				
				0 265 006 813 <sup>4</sup>				
	12.02-09.03	55	LAB,TW	0 265 006 812 <sup>4</sup>				
<b>FT 350 M 2.4 TDE</b>	01.00-07.06	66	LAB,TW	0 265 006 461 <sup>4</sup>				
			RAB,TW	0 265 006 814 <sup>4</sup>				
				0 265 006 460 <sup>4</sup>				
				0 265 006 813 <sup>4</sup>				
		88	LAB,TW	0 265 006 461 <sup>4</sup>				
			RAB,TW	0 265 006 814 <sup>4</sup>				
				0 265 006 460 <sup>4</sup>				
				0 265 006 813 <sup>4</sup>				
		92	LAB,TW	0 265 006 458 <sup>3</sup>				
			RAB,TW	0 265 006 461 <sup>4</sup>				
				0 265 006 814 <sup>4</sup>				
				0 265 006 460 <sup>4</sup>				
				0 265 006 813 <sup>4</sup>				
	12.02-07.06	66	LAB,TW	0 265 006 812 <sup>4</sup>				
		88	LAB,TW	0 265 006 812 <sup>4</sup>				
		92	LAB,TW	0 265 006 812 <sup>4</sup>				
	03.04-07.06	66	RAB,TW	0 265 006 811 <sup>4</sup>				
		85		0 265 006 458 <sup>3</sup>				
			LAB,TW	0 265 006 461 <sup>4</sup>				
				0 265 006 812 <sup>4</sup>				
				0 265 006 814 <sup>4</sup>				
			RAB,TW	0 265 006 460 <sup>4</sup>				
				0 265 006 811 <sup>4</sup>				
				0 265 006 813 <sup>4</sup>				
		88	RAB,TW	0 265 006 811 <sup>4</sup>				
		92	RAB,TW	0 265 006 811 <sup>4</sup>				
<b>FT 350 M 2.4 TDE</b>	01.00-07.06	66		0 265 006 458 <sup>3</sup>				
<b>FT 350 M 2.4 TDI</b>		88		0 265 006 458 <sup>3</sup>				
<b>FT 350 M 2.4 TDI</b>	01.01-09.03	66	LAB,OZB	0 265 006 461 <sup>4</sup>				
			OZB,RAB	0 265 006 460 <sup>4</sup>				
		88	LAB,OZB	0 265 006 461 <sup>4</sup>				
			OZB,RAB	0 265 006 460 <sup>4</sup>				
	01.01-05.06	66	LAB,ZWB	0 265 006 814 <sup>4</sup>				
			RAB,ZWB	0 265 006 813 <sup>4</sup>				
		88	LAB,ZWB	0 265 006 814 <sup>4</sup>				
			RAB,ZWB	0 265 006 813 <sup>4</sup>				
	10.03-05.06	66	LAB,OZB	0 265 006 812 <sup>4</sup>				
			OZB,RAB	0 265 006 811 <sup>4</sup>				
		88	LAB,OZB	0 265 006 812 <sup>4</sup>				
			OZB,RAB	0 265 006 811 <sup>4</sup>				
	06.04-05.06	96		0 265 006 458 <sup>3</sup>				
			LAB,OZB	0 265 006 812 <sup>4</sup>				
			LAB,ZWB	0 265 006 814 <sup>4</sup>				
			OZB,RAB	0 265 006 811 <sup>4</sup>				
			RAB,ZWB	0 265 006 813 <sup>4</sup>				



	<b>S</b>							
<b>FT 430 EL 2.4 TD</b>	08.02-09.03	55				0 265 <b>006 458</b> <sup>3</sup>		
					LAB,TW	0 265 <b>006 461</b> <sup>4</sup>		
						0 265 <b>006 814</b> <sup>4</sup>		
					RAB,TW	0 265 <b>006 460</b> <sup>4</sup>		
						0 265 <b>006 813</b> <sup>4</sup>		
	12.02-09.03	55			LAB,TW	0 265 <b>006 812</b> <sup>4</sup>		
<b>FT 430 EL 2.4 TDCi</b>	08.02-07.06	66/85/92/				0 265 <b>006 458</b> <sup>3</sup>		
<b>FT 430 EL 2.4 TDE</b>		101			LAB,TW	0 265 <b>006 461</b> <sup>4</sup>		
						0 265 <b>006 814</b> <sup>4</sup>		
					RAB,TW	0 265 <b>006 460</b> <sup>4</sup>		
						0 265 <b>006 813</b> <sup>4</sup>		
	12.02-07.06	66/85/92/101			LAB,TW	0 265 <b>006 812</b> <sup>4</sup>		
	03.04-07.06	66/85/92/101			RAB,TW	0 265 <b>006 811</b> <sup>4</sup>		
<b>FT 430 E 2.4 TDI</b>	06.04-05.06	96				0 265 <b>006 458</b> <sup>3</sup>		
					LAB,OZB	0 265 <b>006 812</b> <sup>4</sup>		
					LAB,ZWB	0 265 <b>006 814</b> <sup>4</sup>		
					OZB,RAB	0 265 <b>006 811</b> <sup>4</sup>		
					RAB,ZWB	0 265 <b>006 813</b> <sup>4</sup>		
<b>FT 430 M 2.4 TD</b>	08.02-09.03	55				0 265 <b>006 458</b> <sup>3</sup>		
					LAB,TW	0 265 <b>006 461</b> <sup>4</sup>		
						0 265 <b>006 814</b> <sup>4</sup>		
					RAB,TW	0 265 <b>006 460</b> <sup>4</sup>		
						0 265 <b>006 813</b> <sup>4</sup>		
	12.02-09.03	55			LAB,TW	0 265 <b>006 812</b> <sup>4</sup>		
<b>FT 430 M 2.4 TDCi</b>	08.02-07.06	85/92/101				0 265 <b>006 458</b> <sup>3</sup>		
<b>FT 430 M 2.4 TDE</b>					LAB,TW	0 265 <b>006 461</b> <sup>4</sup>		
						0 265 <b>006 814</b> <sup>4</sup>		
					RAB,TW	0 265 <b>006 460</b> <sup>4</sup>		
						0 265 <b>006 813</b> <sup>4</sup>		
	12.02-07.06	85/92/101			LAB,TW	0 265 <b>006 812</b> <sup>4</sup>		
	03.04-07.06	85/92/101			RAB,TW	0 265 <b>006 811</b> <sup>4</sup>		
<b>Transit [06]</b>								
								
	<b>FT 260 2.2 TDCi</b>	04.06-09.11	63/81/85/ 96-96/103			0 204 <b>004 617</b>	← 48	
						0 986 <b>134 025</b>		
						0 204 <b>004 618</b>	→ 48	
						0 986 <b>135 025</b>		
	<b>FT 280 2.2 TDCi</b>	04.06-09.11	63/81/85/ 96-96/103			0 204 <b>004 617</b>	← 48	
						0 986 <b>134 025</b>		
						0 204 <b>004 618</b>	→ 48	
						0 986 <b>135 025</b>		
	<b>FT 300 2.2 TDCi</b>	04.06-08.07	96			0 204 <b>004 617</b>	← 48	
						0 986 <b>134 025</b>		
						0 204 <b>004 618</b>	→ 48	
						0 986 <b>135 025</b>		
		04.06-06.10	81			0 204 <b>004 617</b>	← 48	
						0 986 <b>134 025</b>		
						0 204 <b>004 618</b>	→ 48	
						0 986 <b>135 025</b>		
		04.06-09.11	63			0 204 <b>004 617</b>	← 48	
						0 986 <b>134 025</b>		
						0 204 <b>004 618</b>	→ 48	
						0 986 <b>135 025</b>		
		10.07-09.11	103			0 204 <b>004 617</b>	← 48	
						0 986 <b>134 025</b>		
						0 204 <b>004 618</b>	→ 48	
						0 986 <b>135 025</b>		
		10.08-09.11	85			0 204 <b>004 617</b>	← 48	
						0 986 <b>134 025</b>		
						0 204 <b>004 618</b>	→ 48	
						0 986 <b>135 025</b>		





<b>FORD Transit [06]</b>								
<b>FT 300 2.3i</b>	04.06-09.11	107				0 204 004 615	← 48	
						0 986 134 028		
						0 204 004 616	→ 48	
						0 986 135 028		
<b>FT 300 2.4 TDCi</b>	07.06-09.11	74-74				0 204 004 615	← 48	
						0 986 134 028		
						0 204 004 616	→ 48	
						0 986 135 028		
		85				0 204 004 615	← 48	
						0 986 134 028		
						0 204 004 616	→ 48	
						0 986 135 028		
<b>FT 330 2.2 TDCi, 2.3i, 2.3i CNG, 2.3i LPG, 2.4 TDCi, 2.4 TDCi 4x4</b>	04.06-09.11	74-74/81/ 85-85/96/ 100-107				0 204 004 615	← 48	
						0 986 134 028		
						0 204 004 616	→ 48	
						0 986 135 028		
<b>FT 350 2.2 TDCi, 2.3i, 2.3i CNG, 2.3i LPG, 2.4 TDCi, 2.4 TDCi 4x4, 3.2 TDCi</b>	04.06-09.11	74-74/81/ 85-85/96/ 100-107/ 147				0 204 004 615	← 48	
						0 986 134 028		
						0 204 004 616	→ 48	
						0 986 135 028		
<b>FT 430 2.4 TDCi</b>	07.06-09.11	74-74/ 85-85/103				0 204 004 615	← 48	
						0 986 134 028		
						0 204 004 616	→ 48	
						0 986 135 028		
<b>FT 460 2.4 TDCi</b>	07.06-09.11	85/103/				0 204 004 615	← 48	
<b>FT 460 3.2 TDCi</b>		147				0 986 134 028		
						0 204 004 616	→ 48	
						0 986 135 028		
<b>FT 260 2.2 TDCi</b>	04.06-09.11	63/81/85/96-96/103				F 026 002 578	↔ 25,4	
<b>FT 280 2.2 TDCi</b>	04.06-09.11	63/81/85/96-96/103				F 026 002 578	↔ 25,4	
<b>FT 300 2.2 TDCi</b>	04.06-09.11	63/81/85/96/103				F 026 002 578	↔ 25,4	
<b>FT 260 2.2 TDCi</b>	04.06-09.11	63/81/85/ 96-96/103				0 204 902 026	← 48	
						0 986 134 027		
						0 204 902 027	→ 48	
						0 986 135 027		
<b>FT 280 2.2 TDCi</b>	04.06-09.11	63/81/85/ 96-96/103				0 204 902 026	← 48	
						0 986 134 027		
						0 204 902 027	→ 48	
						0 986 135 027		
<b>FT 300 2.2 TDCi</b>	04.06-09.11	63/74-74/				0 204 902 026	← 48	
<b>FT 300 2.3i</b>		81/85/96/				0 986 134 027		
<b>FT 300 2.4 TDCi</b>		103/107				0 204 902 027	→ 48	
						0 986 135 027		
<b>FT 330 2.2 TDCi, 2.3i, 2.3i CNG, 2.3i LPG, 2.4 TDCi, 2.4 TDCi 4x4</b>	04.06-09.11	74-74/81/ 85-85/96/ 100-107				0 204 902 026	← 48	
						0 986 134 027		
						0 204 902 027	→ 48	
						0 986 135 027		
<b>FT 350 2.2 TDCi, 2.3i, 2.3i CNG, 2.3i LPG, 2.4 TDCi, 2.4 TDCi 4x4, 3.2 TDCi</b>	04.06-09.11	74-74/81/ 85-85/96/ 100-107/ 147				0 204 902 026	← 48	
						0 986 134 027		
						0 204 902 027	→ 48	
						0 986 135 027		
<b>FT 430 2.4 TDCi</b>	07.06-09.11	74-74/ 85-85/103				0 204 902 026	← 48	
						0 986 134 027		
						0 204 902 027	→ 48	
						0 986 135 027		



		S							
	<b>FT 260</b> 2.2 TDCi	04.06-09.11	63/81/85/ 96-96/103			TBR	1 987 477 174	← 1547	
							1 987 482 036	→ 1283	
						4SB	1 987 482 277	← 1532	
							1 987 482 281	→ 1266	
	<b>FT 280</b> 2.2 TDCi	04.06-09.11	63/81/85/ 96-96/103			TBR	1 987 477 174	← 1547	
							1 987 482 036	→ 1283	
						4SB	1 987 482 277	← 1532	
							1 987 482 281	→ 1266	
	<b>FT 300</b> 2.2 TDCi	04.06-08.07	96			FGS,TBR	1 987 482 035	← 1648	
							1 987 482 135	→ 1352	
						FGS,TBR	1 987 477 174	← 1547	
							1 987 482 036	→ 1283	
						4SB,FGS	1 987 482 277	← 1532	
							1 987 482 281	→ 1266	
		04.06-06.10	81			FGS,TBR	1 987 482 035	← 1648	
							1 987 482 135	→ 1352	
						FGS,TBR	1 987 477 174	← 1547	
							1 987 482 036	→ 1283	
						4SB,FGS	1 987 482 277	← 1532	
							1 987 482 281	→ 1266	
		04.06-09.11	63			FGS,TBR	1 987 482 035	← 1648	
							1 987 482 135	→ 1352	
						FGS,TBR	1 987 477 174	← 1547	
							1 987 482 036	→ 1283	
						4SB,FGS	1 987 482 277	← 1532	
							1 987 482 281	→ 1266	
		10.07-09.11	103			FGS,TBR	1 987 482 035	← 1648	
							1 987 482 135	→ 1352	
						FGS,TBR	1 987 477 174	← 1547	
							1 987 482 036	→ 1283	
						4SB,FGS	1 987 482 277	← 1532	
							1 987 482 281	→ 1266	
		10.08-09.11	85			FGS,TBR	1 987 482 035	← 1648	
							1 987 482 135	→ 1352	
						FGS,TBR	1 987 477 174	← 1547	
							1 987 482 036	→ 1283	
						4SB,FGS	1 987 482 277	← 1532	
							1 987 482 281	→ 1266	
	<b>FT 300</b> 2.3i	04.06-09.11	107			FGS	1 987 482 277	← 1532	
							1 987 482 281	→ 1266	
	<b>FT 300</b> 2.4 TDCi	07.06-09.11	74-74			FGS	1 987 482 277	← 1532	
							1 987 482 281	→ 1266	
			85			FGS	1 987 482 277	← 1532	
							1 987 482 281	→ 1266	
	<b>FT 330</b> 2.2 TDCi, 2.3i, 2.3i CNG, 2.3i LPG, 2.4 TDCi, 2.4 TDCi 4x4	04.06-09.11	74-74/81/85-85/ 96/100-107			FGS	1 987 482 277	← 1532	
							1 987 482 281	→ 1266	
	<b>FT 350</b> 2.2 TDCi	04.06-08.07	96			FGS	1 987 482 277	← 1532	
							1 987 482 281	→ 1266	
		04.06-09.11	81/85			FGS	1 987 482 277	← 1532	
							1 987 482 281	→ 1266	
		10.07-09.11	103			FGS	1 987 482 277	← 1532	
							1 987 482 281	→ 1266	
	<b>FT 350</b> 2.3i CNG	04.06-09.11	100-107			FGS,OZB	1 987 482 277	← 1532	
							1 987 482 281	→ 1266	
	<b>FT 350</b> 2.3i, 2.3i LPG, 3.2 TDCi	04.06-09.11	107/147			FGS,OZB	1 987 482 277	← 1532	
							1 987 482 281	→ 1266	
	<b>FT 350</b> 2.4 TDCi	07.06-09.11	74-74			FGS,OZB	1 987 482 277	← 1532	
							1 987 482 281	→ 1266	
			85-85			FGS,OZB	1 987 482 277	← 1532	
							1 987 482 281	→ 1266	



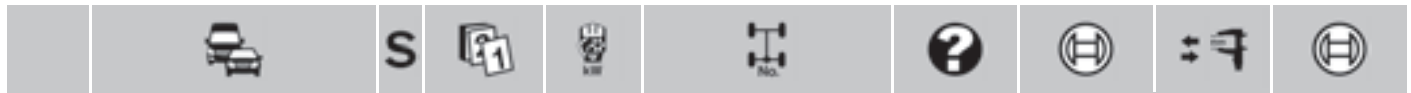







































◀ FORD Transit [06]

	<b>FT 350 2.4 TDCi</b>	07.06-09.11	103		FGS,OZB	1987 <b>482 277</b>	◀ 1532
	<b>FT 350 2.4 TDCi 4x4</b>					1987 <b>482 281</b>	→ 1266
	<b>FT 260 2.2 TDCi</b>	04.06-09.11	63/81/85/96-96/103		RAB	0 265 <b>007 878<sup>4</sup></b>	
	<b>FT 280 2.2 TDCi</b>	04.06-09.11	63/81/85/96-96/103		RAB	0 265 <b>007 878<sup>4</sup></b>	
	<b>FT 300 2.2 TDCi</b>	04.06-08.07	96		RAB	0 265 <b>007 878<sup>4</sup></b>	
	<b>FT 300 2.2 TDCi</b>	04.06-03.10	103/107		RAB	0 265 <b>007 878<sup>4</sup></b>	
	<b>FT 300 2.3i</b>	04.10-09.11	103/107		LAB,TW	0 265 <b>008 662<sup>4</sup></b>	
					RAB,TW	0 265 <b>007 878<sup>4</sup></b>	
						0 265 <b>008 665<sup>4</sup></b>	
	<b>FT 300 2.2 TDCi</b>	04.06-03.10	63/74-74/81/85		RAB	0 265 <b>007 878<sup>4</sup></b>	
	<b>FT 300 2.4 TDCi</b>	04.10-09.11	63/74-74/ 81/85		LAB,TW	0 265 <b>008 662<sup>4</sup></b>	
					RAB,TW	0 265 <b>007 878<sup>4</sup></b>	
						0 265 <b>008 665<sup>4</sup></b>	
	<b>FT 330 2.2 TDCi</b>	04.06-08.07	96		RAB	0 265 <b>007 878<sup>4</sup></b>	
	<b>FT 330 2.2 TDCi, 2.3i, 2.3i CNG,</b>	04.06-03.10	100-107		RAB	0 265 <b>007 878<sup>4</sup></b>	
	<b>2.3i LPG, 2.4 TDCi, 2.4 TDCi 4x4</b>	04.10-09.11	100-107		LAB,TW	0 265 <b>008 662<sup>4</sup></b>	
					RAB,TW	0 265 <b>007 878<sup>4</sup></b>	
						0 265 <b>008 665<sup>4</sup></b>	
	<b>FT 330 2.2 TDCi</b>	04.06-03.10	74-74/81/85-85		RAB	0 265 <b>007 878<sup>4</sup></b>	
	<b>FT 330 2.4 TDCi</b>	04.10-09.11	74-74/81/ 85-85		LAB,TW	0 265 <b>008 662<sup>4</sup></b>	
					RAB,TW	0 265 <b>007 878<sup>4</sup></b>	
						0 265 <b>008 665<sup>4</sup></b>	
	<b>FT 350 2.2 TDCi</b>	04.06-08.07	96		RAB	0 265 <b>007 878<sup>4</sup></b>	
	<b>FT 350 2.2 TDCi, 2.3i, 2.3i CNG,</b>	04.06-03.10	100-107/147		RAB	0 265 <b>007 878<sup>4</sup></b>	
	<b>2.3i LPG, 2.4 TDCi, 2.4 TDCi 4x4,</b>	04.10-09.11	100-107/147		LAB,TW	0 265 <b>008 662<sup>4</sup></b>	
	<b>3.2 TDCi</b>				RAB,TW	0 265 <b>007 878<sup>4</sup></b>	
						0 265 <b>008 665<sup>4</sup></b>	
	<b>FT 350 2.2 TDCi</b>	04.06-03.10	74-74/81/85-85		RAB	0 265 <b>007 878<sup>4</sup></b>	
	<b>FT 350 2.4 TDCi</b>	04.10-09.11	74-74/81/ 85-85		LAB,TW	0 265 <b>008 662<sup>4</sup></b>	
					RAB,TW	0 265 <b>007 878<sup>4</sup></b>	
						0 265 <b>008 665<sup>4</sup></b>	
	<b>FT 430 2.4 TDCi</b>	07.06-09.11	74-74/85-85/103		RAB	0 265 <b>007 878<sup>4</sup></b>	
	<b>FT 460 2.4 TDCi</b>	07.06-03.10	85/103/147		RAB	0 265 <b>007 878<sup>4</sup></b>	
	<b>FT 460 3.2 TDCi</b>	04.10-09.11	85/103/147		LAB,TW	0 265 <b>008 662<sup>4</sup></b>	
					RAB,TW	0 265 <b>007 878<sup>4</sup></b>	
						0 265 <b>008 665<sup>4</sup></b>	

**Transit [12]**

	<b>FT 250 2.2 TDCi</b>	09.11-12.13	74			0 204 <b>004 617</b>	◀ 48
						0 986 <b>134 025</b>	
						0 204 <b>004 618</b>	→ 48
						0 986 <b>135 025</b>	
	<b>FT 260 2.2 TDCi</b>	09.11-12.13	74/92/103			0 204 <b>004 617</b>	◀ 48
						0 986 <b>134 025</b>	
						0 204 <b>004 618</b>	→ 48
						0 986 <b>135 025</b>	
	<b>FT 280 2.2 TDCi</b>	09.11-12.13	74/92/103			0 204 <b>004 617</b>	◀ 48
						0 986 <b>134 025</b>	
						0 204 <b>004 618</b>	→ 48
						0 986 <b>135 025</b>	
	<b>FT 300 2.2 TDCi</b>	09.11-12.13	74/92			0 204 <b>004 615</b>	◀ 48
						0 986 <b>134 028</b>	
						0 204 <b>004 616</b>	→ 48
						0 986 <b>135 028</b>	
						0 204 <b>004 617</b>	◀ 48
						0 986 <b>134 025</b>	
						0 204 <b>004 618</b>	→ 48
						0 986 <b>135 025</b>	

	<b>S</b>							
<b>FT 300</b> 2.2 TDCi	09.11-12.13	103				0 204 <b>004 617</b> 0 986 <b>134 025</b>	← 48 	
						0 204 <b>004 618</b> 0 986 <b>135 025</b>	→ 48 	
<b>FT 330</b> 2.2 TDCi	09.11-12.13	74/92/103/ 114				0 204 <b>004 615</b> 0 986 <b>134 028</b>	← 48 	
						0 204 <b>004 616</b> 0 986 <b>135 028</b>	→ 48 	
<b>FT 350</b> 2.2 TDCi <b>FT 350</b> 2.2 TDCi HDT	09.11-12.13	74/92/99/ 103/114				0 204 <b>004 615</b> 0 986 <b>134 028</b>	← 48 	
						0 204 <b>004 616</b> 0 986 <b>135 028</b>	→ 48 	
<b>FT 370</b> 2.2 TDCi	09.11-12.13	74/92/114				0 204 <b>004 615</b> 0 986 <b>134 028</b>	← 48 	
						0 204 <b>004 616</b> 0 986 <b>135 028</b>	→ 48 	
<b>FT 430</b> 2.2 TDCi <b>FT 430</b> 2.2 TDCi HDT	09.11-12.13	74/92/99/ 114				0 204 <b>004 615</b> 0 986 <b>134 028</b>	← 48 	
						0 204 <b>004 616</b> 0 986 <b>135 028</b>	→ 48 	
<b>FT 460</b> 2.2 TDCi	09.11-12.13	92/114				0 204 <b>004 615</b> 0 986 <b>134 028</b>	← 48 	
						0 204 <b>004 616</b> 0 986 <b>135 028</b>	→ 48 	
								
 <b>FT 250</b> 2.2 TDCi	09.11-12.13	74				0 204 <b>902 026</b> 0 986 <b>134 027</b>	← 48 	
						0 204 <b>902 027</b> 0 986 <b>135 027</b>	→ 48 	
<b>FT 260</b> 2.2 TDCi	09.11-12.13	74/92/103				0 204 <b>902 026</b> 0 986 <b>134 027</b>	← 48 	
						0 204 <b>902 027</b> 0 986 <b>135 027</b>	→ 48 	
<b>FT 280</b> 2.2 TDCi	09.11-12.13	74/92/103				0 204 <b>902 026</b> 0 986 <b>134 027</b>	← 48 	
						0 204 <b>902 027</b> 0 986 <b>135 027</b>	→ 48 	
<b>FT 300</b> 2.2 TDCi	09.11-12.13	74/92/103				0 204 <b>902 026</b> 0 986 <b>134 027</b>	← 48 	
						0 204 <b>902 027</b> 0 986 <b>135 027</b>	→ 48 	
<b>FT 330</b> 2.2 TDCi	09.11-12.13	74/92/103/ 114				0 204 <b>902 026</b> 0 986 <b>134 027</b>	← 48 	
						0 204 <b>902 027</b> 0 986 <b>135 027</b>	→ 48 	
<b>FT 350</b> 2.2 TDCi <b>FT 350</b> 2.2 TDCi HDT	09.11-12.13	74/92/99/ 103/114				0 204 <b>902 026</b> 0 986 <b>134 027</b>	← 48 	
						0 204 <b>902 027</b> 0 986 <b>135 027</b>	→ 48 	
<b>FT 370</b> 2.2 TDCi	09.11-12.13	74/92/114				0 204 <b>902 026</b> 0 986 <b>134 027</b>	← 48 	
						0 204 <b>902 027</b> 0 986 <b>135 027</b>	→ 48 	
<b>FT 430</b> 2.2 TDCi <b>FT 430</b> 2.2 TDCi HDT	09.11-12.13	74/92/99/ 114				0 204 <b>902 026</b> 0 986 <b>134 027</b>	← 48 	
						0 204 <b>902 027</b> 0 986 <b>135 027</b>	→ 48 	





◀ FORD Transit [12]



	<b>FT 250</b> 2.2 TDCi	09.11-12.13	74		1987 <b>482 277</b>	← 1532
					1987 <b>482 281</b>	→ 1266
	<b>FT 260</b> 2.2 TDCi	09.11-12.13	74/92/103		1987 <b>482 277</b>	← 1532
					1987 <b>482 281</b>	→ 1266
	<b>FT 280</b> 2.2 TDCi	09.11-12.13	74/92/103		1987 <b>482 277</b>	← 1532
					1987 <b>482 281</b>	→ 1266
	<b>FT 300</b> 2.2 TDCi	09.11-12.13	74	FGS	1987 <b>482 277</b>	← 1532
					1987 <b>482 281</b>	→ 1266
			92		1987 <b>482 277</b>	← 1532
					1987 <b>482 281</b>	→ 1266
				FGS	1987 <b>482 277</b>	← 1532
					1987 <b>482 281</b>	→ 1266
		103	FGS	1987 <b>482 277</b>	← 1532	
				1987 <b>482 281</b>	→ 1266	
<b>FT 330</b> 2.2 TDCi	09.11-12.13	74		1987 <b>482 277</b>	← 1532	
				1987 <b>482 281</b>	→ 1266	
			FGS	1987 <b>482 277</b>	← 1532	
				1987 <b>482 281</b>	→ 1266	
		92/103/	FGS	1987 <b>482 277</b>	← 1532	
		114		1987 <b>482 281</b>	→ 1266	
<b>FT 350</b> 2.2 TDCi	09.11-12.13	74		1987 <b>482 277</b>	← 1532	
				1987 <b>482 281</b>	→ 1266	
			FGS,OZB	1987 <b>482 277</b>	← 1532	
				1987 <b>482 281</b>	→ 1266	
		92	FGS	1987 <b>482 277</b>	← 1532	
				1987 <b>482 281</b>	→ 1266	
			FGS,OZB	1987 <b>482 277</b>	← 1532	
				1987 <b>482 281</b>	→ 1266	
		103	FGS	1987 <b>482 277</b>	← 1532	
				1987 <b>482 281</b>	→ 1266	
		114	FGS,OZB	1987 <b>482 277</b>	← 1532	
				1987 <b>482 281</b>	→ 1266	
<b>FT 370</b> 2.2 TDCi	09.11-12.13	74/92/114		1987 <b>482 277</b>	← 1532	
				1987 <b>482 281</b>	→ 1266	
	<b>FT 250</b> 2.2 TDCi	09.11-12.13	74	RAB	0265 <b>007 878</b> <sup>4</sup>	
	<b>FT 260</b> 2.2 TDCi	09.11-12.13	74/92/103	RAB	0265 <b>007 878</b> <sup>4</sup>	
	<b>FT 280</b> 2.2 TDCi	09.11-12.13	74/92/103	RAB	0265 <b>007 878</b> <sup>4</sup>	
	<b>FT 300</b> 2.2 TDCi	09.11-12.13	74	FGS,LAB	0265 <b>008 662</b> <sup>4</sup>	
				FGS,RAB	0265 <b>008 665</b> <sup>4</sup>	
				FGS,RAB	0265 <b>007 878</b> <sup>4</sup>	
			92	FGS,LAB	0265 <b>008 662</b> <sup>4</sup>	
				FGS,RAB	0265 <b>008 665</b> <sup>4</sup>	
				FGS,RAB	0265 <b>007 878</b> <sup>4</sup>	
				RAB	0265 <b>007 878</b> <sup>4</sup>	
			103	FGS,LAB	0265 <b>008 662</b> <sup>4</sup>	
				FGS,RAB	0265 <b>008 665</b> <sup>4</sup>	
			FGS,RAB	0265 <b>007 878</b> <sup>4</sup>		
<b>FT 330</b> 2.2 TDCi	09.11-12.13	74	FGS,LAB	0265 <b>008 662</b> <sup>4</sup>		
			FGS,RAB	0265 <b>008 665</b> <sup>4</sup>		
			FGS,RAB	0265 <b>007 878</b> <sup>4</sup>		
			RAB	0265 <b>007 878</b> <sup>4</sup>		
		92/103/	FGS,LAB	0265 <b>008 662</b> <sup>4</sup>		
		114	FGS,RAB	0265 <b>008 665</b> <sup>4</sup>		
			FGS,RAB	0265 <b>007 878</b> <sup>4</sup>		
<b>FT 350</b> 2.2 TDCi	09.11-12.13	74	FGS,LAB	0265 <b>008 662</b> <sup>4</sup>		
			FGS,RAB	0265 <b>008 665</b> <sup>4</sup>		
			FGS,RAB	0265 <b>007 878</b> <sup>4</sup>		
			RAB	0265 <b>007 878</b> <sup>4</sup>		

	S							
FT 350 2.2 TDCi	09.11-12.13	92	103/114			FGS,LAB	0 265 008 662 <sup>4</sup>	
						FGS,RAB	0 265 008 665 <sup>4</sup>	
						FGS,RAB	0 265 007 878 <sup>4</sup>	
						FGS,LAB	0 265 008 662 <sup>4</sup>	
						FGS,RAB	0 265 008 665 <sup>4</sup>	
						FGS,RAB	0 265 007 878 <sup>4</sup>	
FT 350 2.2 TDCi HDT	09.11-12.13	99			RAB	0 265 007 878 <sup>4</sup>		
FT 370 2.2 TDCi	09.11-12.13	74/92/114			RAB	0 265 007 878 <sup>4</sup>		
FT 430 2.2 TDCi, 2.2 TDCi HDT	09.11-12.13	74/92/99/114			RAB	0 265 007 878 <sup>4</sup>		
FT 460 2.2 TDCi	09.11-12.13	92	114			RAB	0 265 007 878 <sup>4</sup>	
						FGS,LAB	0 265 008 662 <sup>4</sup>	
						FGS,RAB	0 265 008 665 <sup>4</sup>	
						FGS,RAB	0 265 007 878 <sup>4</sup>	

**Transit [14]**

	FT 290 2.2 TDCi HDT	09.11-12.13	99			0 204 004 615	← 48	
						0 986 134 028		
						0 204 004 616	→ 48	
						0 986 135 028		
	FT 330 2.2 TDCi	01.14→	74/92/114					0 204 104 359 <sup>8</sup>
	FT 350 2.2 TDCi	01.14→	74/92/114					0 204 104 359 <sup>8</sup>
					OZB			0 204 104 359 <sup>8</sup>
	FT 370 2.2 TDCi	01.14→	92/99/114					0 204 104 359 <sup>8</sup>
	FT 410 2.2 TDCi	01.14→	92/99/114					0 204 104 359 <sup>8</sup>
	FT 430 2.2 TDCi	01.14→	92/114		OZB			0 204 104 359 <sup>8</sup>
	FT 460 2.2 TDCi	01.14→	92/99/114		OZB			0 204 104 359 <sup>8</sup>
	FT 470 2.2 TDCi	01.14→	92/114		OZB			0 204 104 359 <sup>8</sup>

	FT 290 2.2 TDCi HDT	09.11-12.13	99		RAB	0 265 007 878 <sup>4</sup>		

**Transit [92]**

	2.0 i LWB 100-190	08.91-07.94	65-66/72		14Z	0 204 102 925	→ 42	0 204 100 277 <sup>8</sup>
						0 204 103 925		0 204 104 135 <sup>7</sup>
						0 204 102 926	← 42	0 204 100 277 <sup>8</sup>
						0 204 103 926		
	2.0 LWB 100-190	08.91-07.94	65-66/72		15Z	0 204 102 934	→ 42	0 204 100 277 <sup>8</sup>
						0 986 474 179		0 204 104 135 <sup>7</sup>
						0 204 102 935	← 42	0 204 100 277 <sup>8</sup>
						0 986 473 179		
	2.5 DI LWB 100 L	08.91-07.94	51-52/59/63/74		14Z	0 204 102 925	→ 42	0 204 100 277 <sup>8</sup>
						0 204 103 925		0 204 104 135 <sup>7</sup>
						0 204 102 926	← 42	0 204 100 277 <sup>8</sup>
						0 204 103 926		
2.5 DI SWB 80-120	08.91-07.94	51-52/59/63/74		15Z	0 204 102 934	→ 42	0 204 100 277 <sup>8</sup>	
					0 986 474 179		0 204 104 135 <sup>7</sup>	
					0 204 102 935	← 42	0 204 100 277 <sup>8</sup>	
					0 986 473 179			
2.5 DI Turbo LWB 100-190	08.91-07.94	51-52/59/63/74		14Z	0 204 102 925	→ 42	0 204 100 277 <sup>8</sup>	
					0 204 103 925		0 204 104 135 <sup>7</sup>	
					0 204 102 926	← 42	0 204 100 277 <sup>8</sup>	
					0 204 103 926			
2.5 DI Turbo LWB 150-190 L	08.91-07.94	51-52/59/63/74		15Z	0 204 102 934	→ 42	0 204 100 277 <sup>8</sup>	
					0 986 474 179		0 204 104 135 <sup>7</sup>	
					0 204 102 935	← 42	0 204 100 277 <sup>8</sup>	
					0 986 473 179			
2.5 DI Turbo SWB 80-150	08.91-07.94	51-52/59/63/74		14Z	0 204 102 925	→ 42	0 204 100 277 <sup>8</sup>	
					0 204 103 925		0 204 104 135 <sup>7</sup>	
					0 204 102 926	← 42	0 204 100 277 <sup>8</sup>	
					0 204 103 926			







































		S							
<b>FORD Transit [92]</b>									
	<b>2.9 V6 LWB 100 L-190</b>	08.91-07.94	104		15Z	0 204 <b>102 934</b> 0 986 <b>474 179</b>	→ 42	0 204 <b>100 277<sup>8</sup></b> 0 204 <b>104 135<sup>7</sup></b>	
						0 204 <b>102 935</b> 0 986 <b>473 179</b>	← 42	0 204 <b>100 277<sup>8</sup></b>	
	<b>2.0 i LWB 100-190, i SWB 80-150, LWB 100-190, SWB 80-150</b>	08.91-07.94	65-66/72			F 026 <b>002 171</b> F 026 <b>002 172</b>	↔ 20,6 ↔ 22,2		
					254	F 026 <b>002 173</b>	↔ 25,4		
	<b>2.5 DI LWB 100 L, DI LWB 100-190, DI SWB 80-120, DI SWB 80-150, DI Turbo LWB 100-190, DI Turbo LWB 150-190 L, DI Turbo SWB 80-150, DI Turbo SWB 150 S</b>	08.91-07.94	51-52/59/ 63/74			F 026 <b>002 171</b> F 026 <b>002 172</b>	↔ 20,6 ↔ 22,2		
					254	F 026 <b>002 173</b>	↔ 25,4		
	<b>2.0 i LWB 100-190, i SWB 80-150, LWB 100-190, SWB 80-150</b>	08.91-07.94	65-66/72		ABM,OZB	1 987 <b>477 369</b>		2823	
					ABM,ZWB	1 987 <b>477 370</b>		2730	
	<b>2.5 DI LWB 100 L, DI LWB 100-190, DI SWB 80-120, DI SWB 80-150, DI Turbo LWB 100-190, DI Turbo LWB 150-190 L, DI Turbo SWB 80-150, DI Turbo SWB 150 S</b>	08.91-07.94	51-52/59/ 63/74		ABM,OZB	1 987 <b>477 369</b>		2823	
					ABM,ZWB	1 987 <b>477 370</b>		2730	
	<b>2.9 V6 LWB 100 L-190</b>	08.91-07.94	104		ABM,OZB	1 987 <b>477 369</b>		2823	
					ABM,ZWB	1 987 <b>477 370</b>		2730	
<b>Transit [95]</b>									
	<b>FT 080 2.0i</b>	08.94-08.00	51/55/56/ 63/74/84/		5LO	0 204 <b>102 925</b> 0 204 <b>103 925</b>	→ 42	0 204 <b>104 135<sup>7</sup></b>	
	<b>FT 080 2.5 D</b>					0 204 <b>102 926</b> 0 204 <b>103 926</b>	← 42	0 204 <b>104 135<sup>7</sup></b>	
	<b>FT 080 2.5 DI</b>		85						
	<b>FT 080 2.5 TD</b>								
	<b>FT 080 2.5 TDI</b>				6LO	0 204 <b>102 934</b> 0 204 <b>102 935</b>	→ 42 ← 42	0 204 <b>104 135<sup>7</sup></b> 0 204 <b>104 135<sup>7</sup></b>	
	<b>FT 100 2.0i</b>	08.94-08.00	51/56/63/ 74/84/85		5LO	0 204 <b>102 925</b> 0 204 <b>103 925</b>	→ 42	0 204 <b>104 135<sup>7</sup></b>	
	<b>FT 100 2.5 D</b>					0 204 <b>102 926</b> 0 204 <b>103 926</b>	← 42	0 204 <b>104 135<sup>7</sup></b>	
	<b>FT 100 2.5 DI</b>								
	<b>FT 100 2.5 TD</b>								
	<b>FT 100 2.5 TDI</b>				6LO	0 204 <b>102 934</b> 0 204 <b>102 935</b>	→ 42 ← 42	0 204 <b>104 135<sup>7</sup></b> 0 204 <b>104 135<sup>7</sup></b>	
	<b>FT 120 2.0i</b>	08.94-08.00	51/56/63/ 74/84/85		5LO	0 204 <b>102 925</b> 0 204 <b>103 925</b>	→ 42	0 204 <b>104 135<sup>7</sup></b>	
	<b>FT 120 2.5 D</b>					0 204 <b>102 926</b> 0 204 <b>103 926</b>	← 42	0 204 <b>104 135<sup>7</sup></b>	
	<b>FT 120 2.5 DI</b>								
	<b>FT 120 2.5 TD</b>								
	<b>FT 120 2.5 TDI</b>				6LO	0 204 <b>102 934</b> 0 204 <b>102 935</b>	→ 42 ← 42	0 204 <b>104 135<sup>7</sup></b> 0 204 <b>104 135<sup>7</sup></b>	
	<b>FT 150 2.0i</b>	08.94-08.00	56/63/74/ 84/85		5LO	0 204 <b>102 925</b> 0 204 <b>103 925</b>	→ 42	0 204 <b>104 135<sup>7</sup></b>	
	<b>FT 150 2.5 DI</b>					0 204 <b>102 926</b> 0 204 <b>103 926</b>	← 42	0 204 <b>104 135<sup>7</sup></b>	
	<b>FT 150 2.5 TD</b>								
	<b>FT 150 2.5 TDI</b>				6LO	0 204 <b>102 934</b> 0 204 <b>102 935</b>	→ 42 ← 42	0 204 <b>104 135<sup>7</sup></b> 0 204 <b>104 135<sup>7</sup></b>	
	<b>FT 190 2.0i, 2.5 DI, 2.5 TD, 2.5 TDI</b>	08.94-08.00	56/63/74/ 84/85		5LO	0 204 <b>102 925</b> 0 204 <b>103 925</b>	→ 42	0 204 <b>104 135<sup>7</sup></b>	
						0 204 <b>102 926</b> 0 204 <b>103 926</b>	← 42	0 204 <b>104 135<sup>7</sup></b>	





























		S							
	<b>FT 190</b> 2.0i, 2.5 DI, 2.5 TD, 2.5 TDI	08.94-08.00	56/63/74/ 84/85		6LO		0 204 <b>102 934</b> 0 204 <b>102 935</b>	→ 42 ← 42	0 204 <b>104 135</b> <sup>7</sup> 0 204 <b>104 135</b> <sup>7</sup>
	<b>FT 080</b> 2.0i, 2.5 D, 2.5 DI, 2.5 TD, 2.5 TDI	08.94-08.00	51/56/63/ 74/84/85				F 026 <b>002 171</b> F 026 <b>002 172</b>	↔ 20,6 ↔ 22,2	
	<b>FT 100</b> 2.0i, 2.5 D, 2.5 DI, 2.5 TD, 2.5 TDI	08.94-08.00	51/56/63/ 74/84/85				F 026 <b>002 171</b> F 026 <b>002 172</b>	↔ 20,6 ↔ 22,2	
	<b>FT 120</b> 2.0i, 2.5 D, 2.5 DI, 2.5 TD, 2.5 TDI	08.94-08.00	51/56/63/ 74/84/85				F 026 <b>002 171</b> F 026 <b>002 172</b>	↔ 20,6 ↔ 22,2	
	<b>FT 150</b> 2.0i, 2.5 DI, 2.5 TD, 2.5 TDI	08.94-08.00	56/63/74/84/85				F 026 <b>002 171</b>	↔ 20,6	
	<b>FT 190</b> 2.0i, 2.5 DI, 2.5 TD, 2.5 TDI	08.94-08.00	56/63/74/84/85				F 026 <b>002 173</b>	↔ 25,4	
	<b>FT 080</b> 2.0i, 2.5 D, 2.5 DI, 2.5 TD, 2.5 TDI	08.94-08.00	51/55/56/ 63/74/84/85		OZB ZWB		1 987 <b>477 369</b> 1 987 <b>477 370</b>	2823 2730	
	<b>FT 100</b> 2.0i, 2.5 D, 2.5 DI, 2.5 TD, 2.5 TDI	08.94-08.00	51/56/63/ 74/84/85		OZB ZWB		1 987 <b>477 369</b> 1 987 <b>477 370</b>	2823 2730	
	<b>FT 120</b> 2.0i, 2.5 D, 2.5 DI, 2.5 TD, 2.5 TDI	08.94-08.00	51/56/63/ 74/84/85		OZB ZWB		1 987 <b>477 369</b> 1 987 <b>477 370</b>	2823 2730	
	<b>FT 150</b> 2.0i, 2.5 DI, 2.5 TD, 2.5 TDI	08.94-08.00	56/63/74/ 84/85		OZB ZWB		1 987 <b>477 369</b> 1 987 <b>477 370</b>	2823 2730	
	<b>FT 190</b> 2.0i, 2.5 DI, 2.5 TD, 2.5 TDI	08.94-08.00	56/63/74/ 84/85		OZB ZWB		1 987 <b>477 369</b> 1 987 <b>477 370</b>	2823 2730	
<b>GAZ</b>									
<b>Volga [311]</b>									
	<b>2.3</b>	01.96-12.08	110				0 265 <b>006 638</b> <sup>3</sup> 0 265 <b>006 639</b> <sup>4</sup>		
<b>HOLDEN</b>									
<b>Astra [G]</b>									
	<b>1.8 i</b>	ABO 09.00-08.09	92				0 986 <b>473 057</b> 0 986 <b>474 057</b>	↔ ← 52 ↔ → 52	
		ABS 09.00-08.09	92				0 986 <b>473 062</b> 0 986 <b>474 062</b>	↔ ← 57 ↔ → 57	1 987 <b>470 005</b> <sup>7</sup> 1 987 <b>470 005</b> <sup>7</sup>
	<b>1.8 i</b>	ABO 09.00-08.09	92		LUC		0 986 <b>473 252</b>	↔ ← 34	
		ABS 09.00-08.09	92	Fg.-Nr. →32999999, →35999999, →36999999, →38999999	LUC		0 986 <b>474 261</b>	↔ → 36	
				Fg.-Nr. Y2147600→, Y5133295→, Y6069184→, Y8074628→	BSY		0 986 <b>473 325</b> 0 986 <b>474 325</b>	↔ ← 36 ↔ → 36	
				Fg.-Nr. 42000001→, 45000001→, 46000001→, 48000001→	LUC		0 986 <b>134 313</b> 0 986 <b>135 313</b>	↔ ← ↔ →	
	<b>1.8 i</b>	09.00-08.09	92				1 987 <b>477 764</b>	1254	



























		S				?			
<b>HONDA</b>									
<b>Accord</b>									
									
	2.0i 16V	10.99-12.00	110						F 026 A03 501 <sup>7</sup>
									
	3.0i	09.02-11.06	177						F 026 A03 519 <sup>7</sup>
<b>Accord Aerodeck [CB/CC/CD/CE]</b>									
									
	2.2i 16V	01.91-06.94	108-110			0986 474 787		← 34	
						0986 474 786		→ 34	
<b>Accord [CF]</b>									
									
	2.3	09.97-08.02	101						F 026 A03 501 <sup>7</sup>
<b>Accord [CG]</b>									
									
	2.3 EXI	09.97-08.01	110						F 026 A03 501 <sup>7</sup>
<b>Accord [CM]</b>									
									
	2.4 VTI-E	09.02-08.07	118/124						F 026 A03 519 <sup>7</sup>
<b>Accord Coupé [CB/CC/CD/CE]</b>									
									
	2.0i 16V	01.94-12.97	100						F 026 A03 530 <sup>7</sup>
	2.2i 16V	01.94-06.98	110						F 026 A03 530 <sup>7</sup>
									
	2.0i 16V	09.93-12.97	100			0986 474 787		← 34	
						0986 474 786		→ 34	
	2.2i 16V	09.93-06.98	110			0986 474 787		← 34	
						0986 474 786		→ 34	
<b>Accord Sedan [CC]</b>									
									
	1.8i 16V	09.93-09.95	85			0986 474 787		← 34	
						0986 474 786		→ 34	
	2.0i 16V	03.93-09.95	85/96			0986 474 787		← 34	
						0986 474 786		→ 34	
	2.3i 16V	03.93-09.95	116			0986 474 787		← 34	
						0986 474 786		→ 34	



		S							
									
	1.8i16V	09.93-09.95	85				1 987 477 602	← 1870	
	2.0i16V	09.93-09.95	85/96				1 987 477 602	← 1870	
	2.3i16V	09.93-09.95	116				1 987 477 602	← 1870	
<b>Accord Sedan [CE/CF]</b>									
									
	1.8i16V	09.95-10.98	85				0 986 474 787	← 34	
							0 986 474 786	→ 34	
	2.0D Turbo	09.95-10.98	77/96				0 986 474 787	← 34	
	2.0i16V						0 986 474 786	→ 34	
	2.2i16V	09.95-10.98	110				0 986 474 787	← 34	
							0 986 474 786	→ 34	
									
	1.8i16V	09.95-10.98	85				1 987 477 602	← 1870	
	2.0D Turbo, i16V	09.95-10.98	77/96				1 987 477 602	← 1870	
	2.2i16V	09.95-10.98	110				1 987 477 602	← 1870	
<b>Accord Tourer [CL/CN/CM]</b>									
									
	2.0	02.03-08.08	114				0 986 473 508	← 38	F 026 A03 550 <sup>7</sup>
							0 986 474 508	→ 38	F 026 A03 550 <sup>7</sup>
	2.2CTDI	01.04-08.08	103				0 986 473 508	← 38	F 026 A03 550 <sup>7</sup>
							0 986 474 508	→ 38	F 026 A03 550 <sup>7</sup>
	2.4	02.03-08.08	140				0 986 473 508	← 38	F 026 A03 550 <sup>7</sup>
							0 986 474 508	→ 38	F 026 A03 550 <sup>7</sup>
<b>City</b>									
									
	1.5i-DSI	11.02-01.09	66						F 026 A06 127 <sup>7</sup>
									
	1.3i	06.96→	71				0 986 AB8 147	↔ 17,46	
	1.3i16V	01.98-10.03	66				0 986 475 709	← 19	
							0 986 475 710	→ 19	
	1.5i-DSI	11.02-01.09	66				0 986 AB8 147	↔ 17,46	
<b>City [GM]</b>									
									
	1.4	01.09-12.10	73						F 026 A03 515 <sup>7</sup>
<b>City New [MN]</b>									
									
	1.5i8V	10.03-12.06	57						F 026 A06 127 <sup>7</sup>
									
	1.5i8V	10.03-12.06	57				0 986 AB8 147	↔ 17,46	























								
◀ HONDA								
<b>Civic</b>								
								
	1.5 i	09.95-08.00	66			0986 475 709	← 19	
						0986 475 710	→ 19	
	2.0 i	05.03-12.04	116			0986 473 994	← 34	
						0986 474 994	→ 34	
								
	1.5 i	09.95-08.00	66	Fg.-Nr. →0S036858		1987 482 084	→ 1542	
						1987 482 085	← 1535	
<b>Civic Aerodeck [MB/MC]</b>								
								
	1.4 i 16V	03.98-02.01	55/66			0986 474 778	← 54	
						0986 474 779	→ 54	
	1.5 i 16V	03.98-02.01	84			0986 474 778	← 54	
						0986 474 779	→ 54	
	1.6 i 16V	03.98-12.98	85			0986 474 778	← 54	
		03.99-12.00	93			0986 474 778	← 54	
						0986 474 779	→ 54	
		03.99-02.01	85			0986 474 778	← 54	
						0986 474 779	→ 54	
	2.0 D Turbo	04.98-02.01	77			0986 474 778	← 54	
						0986 474 779	→ 54	
								
	1.4 i 16V	03.98-02.01	55/66			0986 475 854	← 19,05	
						0986 475 855	→ 19,05	
	1.5 i 16V	03.98-02.01	84			0986 475 854	← 19,05	
						0986 475 855	→ 19,05	
	1.4 i 16V	03.98-02.01	55			0986 474 780	← 30,2	
						0986 474 781	→ 30,2	
	1.5 i 16V	03.98-02.01	84			0986 474 780	← 30,2	
						0986 474 781	→ 30,2	
	1.6 i 16V	03.98-12.98	85			0986 474 780	← 30,2	
						0986 474 781	→ 30,2	
	2.0 D Turbo	04.98-02.01	77			0986 474 780	← 30,2	
						0986 474 781	→ 30,2	
								
	2.0 D Turbo	04.98-02.01	77		LAB	0 265 006 258 <sup>3</sup>		
						0 265 006 267 <sup>4</sup>		
					RAB	0 265 006 259 <sup>3</sup>		
						0 265 006 268 <sup>4</sup>		
<b>Civic Coupé</b>								
								
	1.6 i 16V	01.94-04.00	81/92/118			0986 475 709	← 19	
						0986 475 710	→ 19	
	1.6 i 16V	09.98-08.00	118			0986 473 033	← 30,2	F 026 A03 515 <sup>7</sup>
						0986 474 033	→ 30,2	F 026 A03 515 <sup>7</sup>
	1.7 i	05.01-12.05	88/92			0986 473 994	← 34	
	1.7 i VTEC					0986 474 994	→ 34	



		S				?			
<b>Civic Coupé [EJ]</b>									
	1.6	09.95-12.97	59			GS	0 986 473 082	← 51,04	F 026 A08 207 <sup>7</sup>
							0 986 474 082	→ 51,04	F 026 A08 207 <sup>7</sup>
	1.5	01.94-08.95	74				0 986 475 709	← 19	
							0 986 475 710	→ 19	
	1.6	09.95-08.00	59/92				0 986 475 709	← 19	
							0 986 475 710	→ 19	
<b>Civic Coupé [EK]</b>									
	1.6 i Vti	01.98-11.01	95				0 986 473 033	← 30,2	F 026 A03 515 <sup>7</sup>
							0 986 474 033	→ 30,2	F 026 A03 515 <sup>7</sup>
<b>Civic CRX [EG/EH]</b>									
	1.6 i 16V	03.92-12.94	92/118				0 986 473 445	← 54	
							0 986 474 445	→ 54	
		01.95-12.95	92/118				0 986 474 445	← 54	
							0 986 473 445	→ 54	
	1.6 i 16V	03.92-12.98	92				0 986 475 709	← 19	
							0 986 475 710	→ 19	
	1.6 i 16V	03.92-12.98	118				0 986 473 033	← 30,2	
							0 986 474 033	→ 30,2	
		01.94-12.98	118			LAB	0 986 473 033	↔ 30,2	
<b>Civic [EJ/EK]</b>									
	1.6 i	03.95-12.96	90			AG	0 986 473 082	← 51,04	F 026 A08 207 <sup>7</sup>
							0 986 474 082	→ 51,04	F 026 A08 207 <sup>7</sup>
	1.6 i	03.95-12.96	90				0 986 475 709	← 19	
							0 986 475 710	→ 19	
	1.6 i	01.97-11.01	90				0 986 473 033	← 30,2	F 026 A03 515 <sup>7</sup>
							0 986 474 033	→ 30,2	F 026 A03 515 <sup>7</sup>
<b>Civic [ES]</b>									
	1.7 i Vtec	12.00-12.05	97				0 986 473 994	← 34	
							0 986 474 994	→ 34	
<b>Civic Fastback [MA]</b>									
	1.4 i 16V	09.94-01.97	66				0 986 475 808	→ 19,05	
							0 986 475 809	← 19,05	































		S							
	◀ HONDA Civic Fastback [MA]								
	1.5 i16V	09.94-01.97	66				0986 475 808	→ 19,05	
							0986 475 809	← 19,05	
<b>Civic Fastback [MB/MC]</b>									
	1.4 i16V	03.97-02.01	55/66				0986 474 778	← 54	
							0986 474 779	→ 54	
	1.5 i16V	03.97-02.01	84				0986 474 778	← 54	
							0986 474 779	→ 54	
	1.6 i16V	03.97-02.01	85/93				0986 474 778	← 54	
							0986 474 779	→ 54	
	2.0D	03.97-02.01	74-77				0986 474 778	← 54	
							0986 474 779	→ 54	
	1.4 i16V	03.97-02.01	55				0986 475 854	→ 19,05	
							0986 475 855	← 19,05	
		01.99-12.00	55				0986 475 854	← 19,05	
							0986 475 855	→ 19,05	
			66				0986 475 854	← 19,05	
							0986 475 855	→ 19,05	
	1.5 i16V	03.97-02.01	84				0986 475 854	→ 19,05	
							0986 475 855	← 19,05	
	2.0D	03.97-02.01	74-77				0986 475 854	→ 19,05	
							0986 475 855	← 19,05	
	2.0D	03.97-02.01	74-77		4SB		0986 474 780	← 30,2	
							0986 474 781	→ 30,2	
	2.0D	03.97-02.01	74-77		LAB		0265 006 258 <sup>3</sup>		
							0265 006 267 <sup>4</sup>		
					RAB		0265 006 259 <sup>3</sup>		
							0265 006 268 <sup>4</sup>		
<b>Civic Hatchback [EG/EH]</b>									
	1.3 16V	10.91-09.95	55				0986 474 081	→ 51,05	
	1.5 i16V	10.91-09.95	66				0986 473 082	← 51,04	
							0986 474 082	→ 51,04	
	1.6 i16V	10.91-09.95	92				0986 473 082	← 51,04	
							0986 474 082	→ 51,04	
			118				0986 473 445	← 54	
							0986 474 445	→ 54	
	1.3 16V	10.91-09.95	55				0986 475 709	← 19	
							0986 475 710	→ 19	
	1.5 i16V	10.91-09.95	66				0986 475 709	← 19	
							0986 475 710	→ 19	
	1.6 i16V	10.91-09.95	92/118				0986 473 033	← 30,2	
							0986 474 033	→ 30,2	
	1.3 16V	10.91-09.95	55				1987 477 447	→ 1480	
							1987 477 448	← 1478	

		S							
1.5i16V		10.91-09.95	66				1 987 477 447	→ 1480	
							1 987 477 448	← 1478	
1.6i16V		10.91-09.95	92/118				1 987 477 737	→ 1619	
							1 987 477 740	← 1614	
<b>Civic Hatchback [EJ/EK]</b>									
									
 1.4i16V		10.95-08.97	55				0 986 473 082	← 51,04	F 026 A08 207 <sup>7</sup>
							0 986 474 082	→ 51,04	F 026 A08 207 <sup>7</sup>
									
 1.4i16V		10.95-02.01	55/66				0 986 475 709	← 19	
							0 986 475 710	→ 19	
1.5i16V		10.95-02.01	84				0 986 475 709	← 19	
							0 986 475 710	→ 19	
1.6i16V		10.95-02.01	84/118				0 986 475 709	← 19	
							0 986 475 710	→ 19	
 1.6i16V		10.95-02.01	118				0 986 473 033	← 30,2	F 026 A03 515 <sup>7</sup>
							0 986 474 033	→ 30,2	F 026 A03 515 <sup>7</sup>
									
 1.4i16V		10.95-08.96	55	Fg.-Nr. →OS046342, →OS036858	TW		1 987 482 084	→ 1542	
							1 987 482 085	← 1535	
		10.95-10.98	66	Fg.-Nr. →OS046342	TBR		1 987 482 084	→ 1542	
							1 987 482 085	← 1535	
1.5i16V		10.95-02.01	84	Fg.-Nr. →OS036858	TBR		1 987 482 084	→ 1542	
							1 987 482 085	← 1535	
1.6i16V		10.95-02.01	84	Fg.-Nr. →OS011121	TBR		1 987 482 084	→ 1542	
							1 987 482 085	← 1535	
<b>Civic Hatchback [EU/EP]</b>									
									
 1.4		02.01-12.05	55-66				0 986 474 779	←	
							0 986 474 988	←	
							0 986 473 988	→ 54	
1.6i		02.01-12.05	81				0 986 474 779	←	
							0 986 474 988	←	
							0 986 473 988	→ 54	
									
 1.4		02.01-12.05	55-66				0 986 473 994	← 34	
							0 986 474 994	→ 34	
1.6i		02.01-12.05	81				0 986 473 994	← 34	
							0 986 474 994	→ 34	
1.7CTDi		01.02-12.05	74				0 986 473 994	← 34	
							0 986 474 994	→ 34	
2.0VSA		01.04-12.05	118				0 986 473 994	← 34	
							0 986 474 994	→ 34	
<b>Civic Hatchback [FK/FN]</b>									
									
 1.4		01.06-12.11	61/73				0 986 134 284	← 54	
							0 986 135 284	→ 54	
1.8		09.05-12.11	103				0 986 134 284	← 54	
							0 986 135 284	→ 54	
2.2CTDi		09.05-12.11	103				0 986 134 284	← 54	
							0 986 135 284	→ 54	



		S				?			
◀ HONDA Civic Hatchback [FK/FN]									
	1.4	01.06-12.11	61/73				0986 134 239		←
							0986 135 239		→
	1.8	09.05-12.11	103				0986 134 239		←
							0986 135 239		→
	2.0 Type R	01.07-12.11	148				0986 134 239		←
							0986 135 239		→
	2.2 CTDi	09.05-12.11	103				0986 134 239		←
							0986 135 239		→
Civic Hybrid [ES]									
	1.3	01.02-12.05	61				0986 473 994		← 34
							0986 474 994		→ 34
Civic Sedan									
	1.5 i	10.00-08.02	81				0986 475 978	←	19,05
							0986 475 979	→	19,05
	1.6 i 16VLX	10.97-12.00	78				0986 475 709	←	19
							0986 475 710	→	19
Civic Sedan [EG/EH]									
	1.5 i 16V	10.91-09.95	66				0986 473 082		← 51,04
							0986 474 082		→ 51,04
	1.6 i 16V	10.91-09.95	92				0986 473 082		← 51,04
							0986 474 082		→ 51,04
			118				0986 473 445		← 54
							0986 474 445		→ 54
	1.6 i 16V 4WD	10.91-09.95	88				0986 473 445		← 54
							0986 474 445		→ 54
	1.5 i 16V	10.91-09.95	66				0986 475 709	←	19
							0986 475 710	→	19
	1.6 i 16V	10.91-09.95	92/118				0986 473 033		← 30,2
							0986 474 033		→ 30,2
Civic Sedan [EJ/EK]									
	1.4 i 16V	10.95-12.97	66				0986 473 082		← 51,04 F 026 A08 207 <sup>7</sup>
							0986 474 082		→ 51,04 F 026 A08 207 <sup>7</sup>
	1.4 i 16V	10.95-02.01	66				0986 475 709	←	19
							0986 475 710	→	19
	1.5 i 16V	10.95-02.01	84				0986 475 709	←	19
							0986 475 710	→	19
	1.6 i 16V	10.95-02.01	118				0986 473 033		← 30,2 F 026 A03 515 <sup>7</sup>
							0986 474 033		→ 30,2 F 026 A03 515 <sup>7</sup>





























		S							
									
	1.4i 16V	10.95-02.01	66	Fg.-Nr. → OS046342	TBR	1 987 482 084	→ 1542		
	1.5i 16V	10.95-02.01	84	Fg.-Nr. → OS036858	TBR	1 987 482 085	← 1535		
						1 987 482 084	→ 1542		
						1 987 482 085	← 1535		
<b>Civic Sedan [ES]</b>									
									
	1.6	09.01-12.06	81		TW	0 986 474 779	←		
						0 986 474 988	←		
						0 986 473 988	→ 54		
									
	1.4	02.01-12.02	66			0 986 475 978	← 19,05		
						0 986 475 979	→ 19,05		
	1.6	02.01-12.06	81			0 986 475 978	← 19,05		
						0 986 475 979	→ 19,05		
<b>Civic Shuttle [EC/ED/EE]</b>									
									
	1.6i 16V 4WD	09.88-06.95	80-81/85			0 986 473 030	← 54		
						0 986 474 030	→ 54		
<b>Civiv Sedan [EJ/EK]</b>									
									
	1.4i 16V	10.95-12.97	66			0 986 473 082	← 51,04	F 026 A08 2077	
						0 986 474 082	→ 51,04	F 026 A08 2077	
									
	1.4i 16V	10.95-10.98	66			0 986 475 709	← 19		
						0 986 475 710	→ 19		
									
	1.4i 16V	10.95-10.98	66	Fg.-Nr. → OS046342		1 987 482 084	→ 1542		
						1 987 482 085	← 1535		
<b>Concerto Hatchback</b>									
									
	1.5i 16V	08.89-03.95	66			0 986 474 778	← 54		
						0 986 474 779	→ 54		
	1.6i 16V	08.89-03.95	82/90-96			0 986 474 778	← 54		
						0 986 474 779	→ 54		
									
	1.5i 16V	08.89-03.95	66			0 986 475 808	→ 19,05		
						0 986 475 809	← 19,05		
	1.6i 16V	08.89-03.95	82/90-96			0 986 474 780	← 30,2		
						0 986 474 781	→ 30,2		
									
	1.5i 16V	08.89-03.95	66			1 987 477 788	→ 1531		
						1 987 477 789	← 1506		





		S							
	◀ HONDA Concerto Hatchback								
	1.6 i 16V	08.89-03.95	82/90-96				1987 477 736	→ 1678	
							1987 477 738	← 1653	
<b>Concerto Sedan</b>									
	1.5 i 16V	08.89-03.95	66				0986 474 778	← 54	
							0986 474 779	→ 54	
	1.6 i 16V	08.89-03.95	82/90-96				0986 474 778	← 54	
							0986 474 779	→ 54	
	1.5 i 16V	08.89-03.95	66				0986 475 808	→ 19,05	
							0986 475 809	← 19,05	
	1.6 i 16V	08.89-03.95	82/90-96				0986 474 780	← 30,2	
							0986 474 781	→ 30,2	
	1.5 i 16V	08.89-03.95	66				1987 477 788	→ 1531	
							1987 477 789	← 1506	
	1.6 i 16V	08.89-03.95	82/90-96				1987 477 736	→ 1678	
							1987 477 738	← 1653	
<b>CR-V</b>									
	2.0 i Vtec	05.02-09.13	112				0986 134 274	←	
							0986 135 274	→	
	2.0 i 4x4	09.98-08.01	110						F 026 A03 530 <sup>7</sup>
	2.0 i 16V 4WD	10.95-01.99	96						F 026 A03 530 <sup>7</sup>
		09.96→	97		AG				F 026 A03 501 <sup>7</sup>
					GS				F 026 A03 517 <sup>7</sup>
	2.4 i 4WD	05.04-12.05	119				0986 134 085	← 57	
							0986 135 085	→ 57	
	2.0 i 4x4	10.95→	96/97/110				0986 475 942	→ 20,6	
	2.0 i 16V 4WD						0986 475 943	← 20,6	
	2.4 i 4WD	05.04-12.05	119				0986 473 508	← 38	F 026 A03 550 <sup>6</sup>
							0986 474 508	→ 38	F 026 A03 550 <sup>6</sup>
	2.0 i 4x4	09.98-08.01	110				1987 482 086	→ 1715	
							1987 482 087	← 1678	
	2.0 i 16V 4WD	10.95-01.99	96		LLE		1987 482 086	→ 1715	
							1987 482 087	← 1678	
<b>CR-V [RD]</b>									
	2.0 i 4WD	07.02-08.04	110				0986 134 274	←	
							0986 135 274	→	
		09.04-09.06	110				0986 134 085	← 57	
							0986 135 085	→ 57	
	2.0 i 16V 4WD	03.97-07.02	94-96/108						F 026 A03 517 <sup>7</sup>



































		S							
									
	2.0i 16V 4WD	10.95-07.02	94-96/108				0 986 475 942	→ 20,6	
							0 986 475 943	← 20,6	
	2.0i 4WD	07.02-08.04	110				0 986 473 508	↔ 38	F 026 A03 550 <sup>7</sup>
		09.04-09.06	110				0 986 474 508	↔ 38	F 026 A03 550 <sup>7</sup>
	2.2 CTDi 4x4	02.05-09.06	103				0 986 473 508	↔ 38	F 026 A03 550 <sup>6</sup>
							0 986 474 508	↔ 38	F 026 A03 550 <sup>6</sup>
									
	2.0i 16V 4WD	10.95-07.02	94-96/108				1 987 482 086	→ 1715	
							1 987 482 087	← 1678	
<b>Fit</b>									
									
	1.5i	09.02-10.07	81				0 986 134 262	↔ 51	F 026 A06 127 <sup>7</sup>
							0 986 135 262	↔ 51	F 026 A06 127 <sup>7</sup>
									
	1.5i	09.02-10.07	81				0 986 AB8 148	↔ 15,88	
<b>Fit [GD]</b>									
									
	1.4i 8V	04.03-10.08	59				0 986 BB3 012	↔	
							0 986 475 961	↔ 17,46	
	1.5i 16V	02.05-10.08	77				0 986 BB3 012	↔	
							0 986 475 961	↔ 17,46	
<b>HR-V [GH]</b>									
									
	1.6i 16V, i16V VTEC 4WD, i16V 4WD	12.98-12.05	77/92						F 026 A03 517 <sup>7</sup>
									
	1.6i 16V VTEC 4WD	01.00-12.05	92				0 986 475 942	→ 20,6	
							0 986 475 943	← 20,6	
	1.6i 16V	12.98-12.05	77				0 986 475 709	← 19	
	1.6i 16V 4WD	01.00-12.05	77				0 986 475 710	→ 19	
							0 986 475 942	→ 20,6	
							0 986 475 943	← 20,6	
<b>Jazz</b>									
									
	1.5i 16V	01.04-09.08	66						F 026 A06 127 <sup>7</sup>
									
	1.5i	01.04→	66/88				0 986 AB8 148	↔ 15,88	
	1.5i 16V								



		S								
◀ HONDA										
<b>Jazz [GD]</b>										
	1.2	03.02-12.08	55-57				0986 134 262	← 51	F 026 A06 127 <sup>7</sup>	
							0986 135 262	→ 51	F 026 A06 127 <sup>7</sup>	
	1.4	03.02-12.08	61				0986 134 262	← 51	F 026 A06 127 <sup>7</sup>	
							0986 135 262	→ 51	F 026 A06 127 <sup>7</sup>	
	1.2	03.02-12.03	55-57				0986 475 961	↔ 17,46		
	1.4	03.02-12.03	61				0986 475 961	↔ 17,46		
		01.04-12.08	61				0986 AB8 148	↔ 15,88		
	1.2	01.04-12.08	55-57	Fg.-Nr. →8S201071			0986 134 220	←	F 026 A03 515 <sup>7</sup>	
							0986 135 220	→	F 026 A03 515 <sup>7</sup>	
				Fg.-Nr. 8S201072→			0986 134 220	←	F 026 A03 515 <sup>7</sup>	
							0986 135 220	→	F 026 A03 515 <sup>7</sup>	
	1.4	03.02-12.08	61	Fg.-Nr. →8S205799			0986 134 220	←	F 026 A03 515 <sup>7</sup>	
							0986 135 220	→	F 026 A03 515 <sup>7</sup>	
				Fg.-Nr. 8S205800→			0986 134 220	←	F 026 A03 515 <sup>7</sup>	
							0986 135 220	→	F 026 A03 515 <sup>7</sup>	
<b>Jazz [GE/GG]</b>										
	1.2	10.08→	66						F 026 A03 515 <sup>7</sup>	
	1.4	10.08→	73						F 026 A03 515 <sup>7</sup>	
<b>Legend</b>										
	3.2i 24V	01.91-12.95	151				0986 473 508	← 38		
							0986 474 508	→ 38		
						LAB	0986 473 508	↔ 38		
						RAB	0986 474 508	↔ 38		
	3.5i 24V	01.96-12.98	147-151				0986 473 508	← 38		
							0986 474 508	→ 38		
					LAB	0986 473 508	↔ 38			
					RAB	0986 474 508	↔ 38			
<b>Legend Coupé</b>										
	3.2i 24V	01.91-02.96	151				0986 473 508	← 38		
							0986 474 508	→ 38		
						LAB	0986 473 508	↔ 38		
						RAB	0986 474 508	↔ 38		
	<b>Logo</b>									
	1.3i	02.99-03.02	48				0986 473 445	← 54		
							0986 474 445	→ 54		
<b>Prelude [BB]</b>										
	2.2i 16V	10.96-08.01	136		TW				F 026 A03 517 <sup>7</sup>	
	2.2i 16V 4WS	10.96-12.01	147						F 026 A03 517 <sup>7</sup>	



		<b>S</b>							
<b>Shuttle</b>									
									
	2.2 i 16V	01.95-12.97	107				0 986 473 508	 ← 38	F 026 A03 550 <sup>7</sup>
							0 986 474 508	 → 38	F 026 A03 550 <sup>7</sup>
	2.3 i 16V	01.98-05.01	110				0 986 473 508	 ← 38	F 026 A03 550 <sup>7</sup>
							0 986 474 508	 → 38	F 026 A03 550 <sup>7</sup>
<b>Vigor</b>									
									
	2.5 i	01.95-12.98	140						F 026 A03 530 <sup>7</sup>
<b>HYUNDAI</b>									
<b>Accent</b>									
									
	1.5 i 12V	10.99→	69				0 986 473 171	 ← 53,9	F 026 A03 496 <sup>7</sup>
							0 986 474 171	 → 53,9	F 026 A03 496 <sup>7</sup>
	1.6 i 16V	10.01-09.08	76				0 986 473 171	 ← 53,9	F 026 A03 496 <sup>7</sup>
							0 986 474 171	 → 53,9	F 026 A03 496 <sup>7</sup>
									
	1.5 i 12V	10.99-08.02	69				0 986 475 854	→ 19,05	
							0 986 475 855	← 19,05	
	1.6 i 16V	10.01-09.08	76				F 026 A02 346	→	
							0 986 475 854	→ 19,05	
							0 986 475 855	← 19,05	
									
	1.5 i 12V	10.99→	69				1 987 477 614	↔ 1485	
	1.6 i 16V	10.01-09.08	76				1 987 477 614	↔ 1485	
<b>Accent blue [RB]</b>									
									
	1.4	01.11→	74/80				0 986 475 985	↔ 17,5	
	1.6 CRDi	01.11→	94				0 986 475 985	↔ 17,5	
<b>Accent Hatchback [LC]</b>									
									
	1.3 i	08.99-03.06	53/55/61-63						F 026 A03 496 <sup>7</sup>
	1.5 CRDi, i	08.99-06.06	57-60/66/75						F 026 A03 496 <sup>7</sup>
	1.6 i	08.02-03.06	77						F 026 A03 496 <sup>7</sup>
									
	1.3 i	08.99-08.02	53/55/ 61-63				0 986 475 854	→ 19,05	
							0 986 475 855	← 19,05	
		09.02-03.06	53/55/ 61-63				0 986 475 928	← 17,46	
							0 986 475 929	→ 17,46	
	1.5 CRDi	08.99-08.02	57-60/66/ 75				0 986 475 854	→ 19,05	
	1.5 i						0 986 475 855	← 19,05	
		09.02-06.06	57-60/66/ 75				0 986 475 928	← 17,46	
							0 986 475 929	→ 17,46	
	1.6 i	08.02-03.06	77				0 986 475 928	← 17,46	
							0 986 475 929	→ 17,46	





◀ HYUNDAI Accent Hatchback [LC]



	1.3 i	08.99-07.02	53/55/61-63	1987 477 614	↔ 1485
		08.02-03.06	53/55/61-63	1987 477 055	→ 1493
	1.5 CRDi	01.02-07.02	57-60/66/75	1987 477 614	↔ 1485
	1.5 CRDi	08.02-06.06	57-60/66/	1987 477 055	→ 1493
	1.5 i		75	1987 477 066	← 1493
	1.5 i	08.99-07.02	57-60/66/75	1987 477 614	↔ 1485
	1.6 i	08.02-03.06	77	1987 477 055	→ 1493
				1987 477 066	← 1493

Accent Hatchback [MC]



	1.4	04.06-02.12	71	0986 475 946	↔ 17,5
	1.5 CRDi	04.06-02.12	81	0986 475 946	↔ 17,5
	1.6	04.06-02.12	82	0986 475 946	↔ 17,5
	1.4	04.06-02.12	71	0986 134 225	↔ ←
				0986 135 225	↔ →
	1.5 CRDi	04.06-02.12	81	0986 134 225	↔ ←
				0986 135 225	↔ →
	1.6	04.06-02.12	82	0986 134 225	↔ ←
				0986 135 225	↔ →



	1.4	ABS	04.06-10.07	71	1987 482 358	← 1588
					1987 482 359	→ 1588
	1.5 CRDi	ABS	04.06-10.07	81	1987 482 358	← 1588
					1987 482 359	→ 1588
	1.6	ABS	04.06-10.07	82	1987 482 358	← 1588
					1987 482 359	→ 1588

Accent Hatchback [X3]



	1.3 i	07.94-07.99	43/44/55/62	0986 473 203	↔ ← 51	F 026 A03 476 <sup>6</sup>
				0986 474 203	↔ → 51	F 026 A03 476 <sup>6</sup>
	1.5 i	07.94-07.99	63/65-68/73	0986 473 203	↔ ← 51	F 026 A03 476 <sup>6</sup>
				0986 474 203	↔ → 51	F 026 A03 476 <sup>6</sup>



	1.3 i	07.94-07.99	43/44/55/62	0986 475 846	← 19,05
				0986 475 849	→ 19,05
	1.5 i	07.94-07.99	63/65-68/73	0986 475 846	← 19,05
				0986 475 849	→ 19,05



	1.3 i	07.94-11.94	43/44/55/62	1987 482 164	← 1503
				1987 482 165	→ 1503
				1987 477 612	← 1485
				1987 477 614	→ 1485
	1.5 i	07.94-11.94	63	1987 482 164	← 1503
				1987 482 165	→ 1503
				1987 477 612	← 1485
				1987 477 614	→ 1485
				1987 477 612	← 1485
				1987 477 614	→ 1485

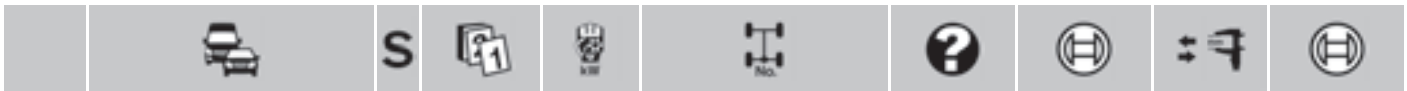

**Accent [LC]**

	<b>1.3, i</b>	05.99-03.06	44/55/61-63				F 026 <b>A03 496</b> <sup>7</sup>
	<b>1.5 CRDi</b>	01.02-06.06	57-60				F 026 <b>A03 496</b> <sup>7</sup>
	<b>1.5 i</b>	08.99-02.05	75				F 026 <b>A03 496</b> <sup>7</sup>
		08.99-03.06	66	0 986 <b>473 171</b>		53,9	F 026 <b>A03 496</b> <sup>7</sup>
				0 986 <b>474 171</b>		53,9	F 026 <b>A03 496</b> <sup>7</sup>
	<b>1.6 i</b>	08.02-03.06	77				F 026 <b>A03 496</b> <sup>7</sup>

	<b>1.3</b>	05.99-08.02	44	0 986 <b>475 854</b>		19,05	
				0 986 <b>475 855</b>		19,05	
	<b>1.3 i</b>	08.99-08.02	55/61-63	0 986 <b>475 854</b>		19,05	
		09.02-03.06	55/61-63	0 986 <b>475 928</b>		17,46	
				0 986 <b>475 929</b>		17,46	
	<b>1.5 CRDi</b>	08.99-08.02	57-60/66/	0 986 <b>475 854</b>		19,05	
	<b>1.5 i</b>		75	0 986 <b>475 855</b>		19,05	
		09.02-06.06	57-60/66/	0 986 <b>475 928</b>		17,46	
			75	0 986 <b>475 929</b>		17,46	
	<b>1.6 i</b>	08.02-03.06	77	F 026 <b>A02 295</b>			
				F 026 <b>A02 296</b>			
				0 986 <b>475 928</b>		17,46	
				0 986 <b>475 929</b>		17,46	
		04.05-09.08	76	0 986 <b>475 946</b>		17,5	

	<b>1.3</b>	05.99-07.02	44	1 987 <b>477 614</b>		1485	
	<b>1.3 i</b>	08.99-07.02	55/61-63	1 987 <b>477 614</b>		1485	
		08.02-03.06	55/61-63	1 987 <b>477 055</b>		1493	
				1 987 <b>477 066</b>		1493	
	<b>1.5 CRDi</b>	01.02-07.02	57-60/66/75	1 987 <b>477 614</b>		1485	
	<b>1.5 CRDi</b>	08.02-06.06	57-60/66/	1 987 <b>477 055</b>		1493	
	<b>1.5 i</b>		75	1 987 <b>477 066</b>		1493	
	<b>1.5 i</b>	08.99-07.02	57-60/66/75	1 987 <b>477 614</b>		1485	
	<b>1.6 i</b>	08.02-03.06	77	1 987 <b>477 055</b>		1493	
				1 987 <b>477 066</b>		1493	

**Accent [MC, MCT]**

	<b>1.4</b>	04.06-11.10	70-71	0 986 <b>475 946</b>		17,5	
	<b>1.5 CRDi</b>	04.06-02.12	81	0 986 <b>475 946</b>		17,5	
	<b>1.6</b>	04.06-02.12	82	0 986 <b>475 946</b>		17,5	

	<b>1.4</b>	04.06-11.10	70-71	0 986 <b>134 225</b>			
				0 986 <b>135 225</b>			
	<b>1.5 CRDi</b>	04.06-02.12	81	0 986 <b>134 225</b>			
				0 986 <b>135 225</b>			
	<b>1.6</b>	04.06-02.12	82	0 986 <b>134 225</b>			
				0 986 <b>135 225</b>			

	<b>1.4</b>	ABS	04.06-10.07	70-71	1 987 <b>482 358</b>		1588
					1 987 <b>482 359</b>		1588
	<b>1.5 CRDi</b>	ABS	04.06-10.07	81	1 987 <b>482 358</b>		1588
					1 987 <b>482 359</b>		1588
	<b>1.6</b>	ABS	04.06-10.07	82	1 987 <b>482 358</b>		1588
					1 987 <b>482 359</b>		1588



		S				?			
◀ HYUNDAI									
<b>Accent [RB]</b>									
	1.6	11.10→	92				0986 475 985	↔ 17,5	
<b>Accent [X3]</b>									
	1.3 i	04.94-07.99	43/44/55/ 62/67				0986 473 203	← 51	F 026 A03 476 <sup>6</sup>
							0986 474 203	→ 51	F 026 A03 476 <sup>6</sup>
	1.5 i	04.94-07.99	63/65-68/ 71/73				0986 473 203	← 51	F 026 A03 476 <sup>6</sup>
	1.5 i 16V						0986 474 203	→ 51	F 026 A03 476 <sup>6</sup>
	1.3 i	04.94-07.99	43/44/55/ 62/67				0986 475 846	← 19,05	
							0986 475 849	→ 19,05	
	1.5 i	04.94-07.99	63/65-68/ 71/73				0986 475 846	← 19,05	
	1.5 i 16V						0986 475 849	→ 19,05	
	1.3 i	04.94-11.94	43/44/55/ 62/67				1987 482 164	← 1503	
							1987 482 165	→ 1503	
		12.94-07.99	43/44/55/ 62/67				1987 477 612	← 1485	
							1987 477 614	→ 1485	
	1.5 i	04.94-11.94	63/71				1987 482 164	← 1503	
							1987 482 165	→ 1503	
		12.94-07.99	63/71				1987 477 612	← 1485	
							1987 477 614	→ 1485	
	1.5 i 16V	11.95-07.99	73				1987 477 612	← 1485	
							1987 477 614	→ 1485	
<b>Atos [MX]</b>									
	0.8 i	09.97-02.01	39-42				0986 473 084	← 51,04	
							0986 474 084	→ 51,04	
		03.01-06.01	39-42				0986 134 273	← 51	
							0986 135 273	→ 51	
	1.0 i	12.97-02.01	40				0986 473 084	← 51,04	
							0986 474 084	→ 51,04	
		03.01-06.01	40				0986 134 273	← 51	
							0986 135 273	→ 51	
		07.01-12.03	43				0986 134 273	← 51	
							0986 135 273	→ 51	
	0.8 i	09.97-06.01	39-42				0986 475 928	← 17,46	
							0986 475 929	→ 17,46	
	1.0 i	12.97-06.01	40				0986 475 928	← 17,46	
							0986 475 929	→ 17,46	
		07.01-12.03	43				0986 475 928	← 17,46	
							0986 475 929	→ 17,46	
	0.8 i	09.97-06.01	39-42				1987 477 611	← 1504	
							1987 477 613	→ 1520	
	1.0 i	12.97-12.03	40/43				1987 477 611	← 1504	
							1987 477 613	→ 1520	





**Atos Prime [MX]**

	1.0i	09.99-02.01	40			0 986 473 084	← 51,04	
						0 986 474 084	→ 51,04	
		03.01-06.01	40			0 986 134 273	← 51	
						0 986 135 273	→ 51	
		07.01-12.03	43			0 986 134 273	← 51	
						0 986 135 273	→ 51	
	1.1i	06.03-03.08	43-46			0 986 134 273	← 51	
						0 986 135 273	→ 51	
	1.0i	09.99-02.01	40			0 986 475 928	← 17,46	
						0 986 475 929	→ 17,46	
		07.01-12.03	43			0 986 475 928	← 17,46	
						0 986 475 929	→ 17,46	
	1.0i	09.99-12.03	40/43			1 987 477 611	← 1504	
						1 987 477 613	→ 1520	
	1.1i	06.03-03.08	43-46			1 987 477 611	← 1504	
						1 987 477 613	→ 1520	

**Avante [J2]**

	1.5i	ABO 03.95-04.95	77			0 986 473 171	← 53,9	
						0 986 474 171	→ 53,9	
		ABS 03.95-02.97	77		KOB	0 986 473 331	← 54	
						0 986 474 331	→ 54	
		03.95→	65-68			0 986 473 331	← 54	
						0 986 474 331	→ 54	
		05.95-02.97	77			0 986 473 331	← 54	
						0 986 474 331	→ 54	
	1.5i	03.95→	65-68/77			0 986 475 848	← 19,05	
						0 986 475 849	→ 19,05	
	1.5i	03.95→	65-68			0 986 473 083	← 33,9	F 026 A06 128 <sup>7</sup>
						0 986 474 083	→ 33,9	F 026 A06 128 <sup>7</sup>
		ABS 05.96-08.00	77		EFV	0 986 473 083	← 33,9	
						0 986 474 083	→ 33,9	
	1.5i	ABO 09.96-08.00	77			1 987 482 168	← 1578	
						1 987 482 169	→ 1571	

**Azera**

	2.7	09.06-12.10	125					F 026 A06 129 <sup>7</sup>





		S				?			
◀ HYUNDAI									
<b>Coupé [GK]</b>									
	2.0 i	10.01-08.05	101-105						F 026 A06 1287
<b>Coupé [RD]</b>									
	1.6 i	04.99-04.02	84-85			0986 473 120		← 53,9	
						0986 474 120		→ 53,9	
	1.8 i	07.97-04.02	94			0986 473 331		← 54	
						0986 474 331		→ 54	
	2.0 i	04.99-04.02	99-102			0986 473 120		← 53,9	
						0986 474 120		→ 53,9	
	1.6 i	05.96-04.02	84-85			0986 475 848		← 19,05	
						0986 475 849		→ 19,05	
	1.6 i	05.96-04.02	84-85			0986 473 083		← 33,9	
						0986 474 083		→ 33,9	
	1.8 i	07.97-04.02	94			0986 473 083		← 33,9	
						0986 474 083		→ 33,9	
	2.0 i	05.96-04.02	99-102			0986 473 083		← 33,9	
						0986 474 083		→ 33,9	
	1.6 i	05.96-04.02	84-85		4SB	1987 477 743		→ 1370	
						1987 477 842		← 1377	
		09.96-04.02	84-85		STB	1987 477 741		← 1520	
						1987 477 742		→ 1512	
	2.0 i	05.96-04.02	99-102		4SB	1987 477 743		→ 1370	
						1987 477 842		← 1377	
		09.96-04.02	99-102		STB	1987 477 741		← 1520	
						1987 477 742		→ 1512	
<b>Elantra Hatchback [XD]</b>									
	1.6 16V	ABO 06.00-09.01	66-79			0986 473 120		← 53,9	
						0986 474 120		→ 53,9	
	1.8 16V	ABO 06.00-09.01	97			0986 473 120		← 53,9	
						0986 474 120		→ 53,9	
	2.0 CRDi	ABO 06.00-09.01	83/102-105			0986 473 120		← 53,9	
	2.0 16V					0986 474 120		→ 53,9	
	1.6 16V	11.01-05.04	66-79			0986 475 854		→ 19,05	
						0986 475 855		← 19,05	
		06.04-08.06	66-79			0986 475 854		← 19,05	
						0986 475 855		→ 19,05	
	1.8 16V	11.01-06.03	97			0986 475 854		→ 19,05	
						0986 475 855		← 19,05	
	2.0 16V	11.01-05.04	102-105			0986 475 854		→ 19,05	
						0986 475 855		← 19,05	
		06.04-09.06	102-105			0986 475 854		← 19,05	
						0986 475 855		→ 19,05	



		S							
	1.6 16V	06.00-09.05	66-79						F 026 A06 128 <sup>7</sup>
	1.8 16V	06.00-09.05	97						F 026 A06 128 <sup>7</sup>
	2.0 CRDi	06.01-07.03	83						F 026 A06 128 <sup>7</sup>
		05.04-08.05	83						F 026 A06 128 <sup>7</sup>
	2.0 16V	06.00-07.03	102-105						F 026 A06 128 <sup>7</sup>
		05.04-08.05	102-105						F 026 A06 128 <sup>7</sup>
	1.6 16V	06.00-07.03	66-79		4SB		1 987 482 166	← 1593	
							1 987 482 167	→ 1578	
	1.8 16V	06.00-07.03	97		4SB		1 987 482 166	← 1593	
							1 987 482 167	→ 1578	
	2.0 CRDi	06.00-07.03	83/102-105		4SB		1 987 482 166	← 1593	
	2.0 16V						1 987 482 167	→ 1578	
<b>Elantra [HD]</b>									
	1.6 CRDi	08.06-10.06	85				0 986 475 854	← 19,05	
							0 986 475 855	→ 19,05	
<b>Elantra [J1]</b>									
	1.5 i	10.90-04.95	53/63-66				0 986 473 171	← 53,9	
							0 986 474 171	→ 53,9	
	1.5 i	10.90-04.95	53/63-66				0 986 475 848	← 19,05	
							0 986 475 849	→ 19,05	
	1.6 i 16V	10.90-04.95	78-84				0 986 475 848	← 19,05	
							0 986 475 849	→ 19,05	
	1.8 i 16V	06.92-04.95	93				0 986 475 848	← 19,05	
							0 986 475 849	→ 19,05	
	1.5 i	10.90-04.95	53/63-66						F 026 A06 128 <sup>7</sup>
	1.6 i 16V	ABS 05.93-04.95	78-84						F 026 A06 128 <sup>7</sup>
	1.8 i 16V	ABS 05.93-04.95	93						F 026 A06 128 <sup>7</sup>
<b>Elantra [J2]</b>									
	1.5 i	ABS 07.96-03.97	65-68				0 986 473 331	← 54	
							0 986 474 331	→ 54	
		04.99-09.00	65-68				0 986 473 120	← 53,9	
							0 986 474 120	→ 53,9	
	1.6 i 16V	05.95-03.97	84				0 986 473 331	← 54	
							0 986 474 331	→ 54	
		04.99-09.00	84				0 986 473 120	← 53,9	
							0 986 474 120	→ 53,9	
	1.8 i 16V	05.95-03.97	101				0 986 473 331	← 54	
							0 986 474 331	→ 54	
		04.99-09.00	101				0 986 473 120	← 53,9	
							0 986 474 120	→ 53,9	
	1.9 D	04.99-09.00	50				0 986 473 120	← 53,9	
							0 986 474 120	→ 53,9	
	1.5 i	07.96-09.00	65-68				0 986 475 848	← 19,05	
							0 986 475 849	→ 19,05	



		S							
	<b>◀ HYUNDAI Elantra [J2]</b>								
	1.6 i 16V	05.95-09.00	84				0986 475 848	← 19,05	
							0986 475 849	→ 19,05	
	1.8 i	08.95-02.01	94-97				F 026 A02 295	←	
							F 026 A02 296	→	
	1.8 i 16V	05.95-09.00	101				0986 475 848	← 19,05	
							0986 475 849	→ 19,05	
	1.9 D	05.95-09.00	50				0986 475 848	← 19,05	
							0986 475 849	→ 19,05	
	1.5 i	07.96-09.00	65-68				0986 473 083	← 33,9	F 026 A06 128 <sup>7</sup>
							0986 474 083	→ 33,9	F 026 A06 128 <sup>7</sup>
	1.6 i 16V	05.95-09.00	84				0986 473 083	← 33,9	F 026 A06 128 <sup>7</sup>
							0986 474 083	→ 33,9	F 026 A06 128 <sup>7</sup>
	1.8 i 16V	05.95-09.00	101				0986 473 083	← 33,9	F 026 A06 128 <sup>7</sup>
							0986 474 083	→ 33,9	F 026 A06 128 <sup>7</sup>
	1.9 D	05.95-09.00	50				0986 473 083	← 33,9	F 026 A06 128 <sup>7</sup>
							0986 474 083	→ 33,9	F 026 A06 128 <sup>7</sup>
	1.5 i	07.96-09.00	65-68		TBR		1987 482 168	← 1578	
							1987 482 169	→ 1571	
	1.6 i 16V	05.95-09.00	84		TBR		1987 482 168	← 1578	
							1987 482 169	→ 1571	
	1.8 i 16V	05.95-09.00	101		TBR		1987 482 168	← 1578	
							1987 482 169	→ 1571	
	1.9 D	05.95-09.00	50		TBR		1987 482 168	← 1578	
							1987 482 169	→ 1571	
<b>Elantra VI</b>									
	1.6 i	11.03-04.09	82						F 026 A06 128 <sup>7</sup>
	1.8 i	10.03-09.11	96						F 026 A06 128 <sup>7</sup>
<b>Elantra [XD]</b>									
	1.6 16V	ABO 06.00-09.01	66-82				0986 473 120	← 53,9	
							0986 474 120	→ 53,9	
	1.8 16V	ABO 06.00-09.01	97				0986 473 120	← 53,9	
							0986 474 120	→ 53,9	
	2.0 CRDi	ABO 06.00-09.01	83/102-105				0986 473 120	← 53,9	
	2.0 16V						0986 474 120	→ 53,9	
	1.6 16V	11.01-05.04	66-82				0986 475 854	→ 19,05	
		06.04-08.06	66-82				0986 475 855	← 19,05	
							0986 475 854	← 19,05	
							0986 475 855	→ 19,05	
	1.8 16V	11.01-06.03	97				0986 475 854	→ 19,05	
							0986 475 855	← 19,05	
	2.0 16V	11.01-05.04	102-105				0986 475 854	→ 19,05	
		06.04-09.06	102-105				0986 475 855	← 19,05	
							0986 475 854	← 19,05	
							0986 475 855	→ 19,05	
	1.6 16V	06.00-09.05	66-82						F 026 A06 128 <sup>7</sup>
	1.8 16V	06.00-09.05	97						F 026 A06 128 <sup>7</sup>
	2.0 CRDi	06.01-07.03	83						F 026 A06 128 <sup>7</sup>
		05.04-08.05	83						F 026 A06 128 <sup>7</sup>

		S							
	2.0 16V		06.00-07.03	102-105					F 026 A06 128 <sup>7</sup>
			05.04-08.05	102-105					F 026 A06 128 <sup>7</sup>
	1.6 16V		06.00-07.03	66-82	4SB		1 987 482 166	← 1593	
							1 987 482 167	→ 1578	
	1.8 16V		06.00-07.03	97	4SB		1 987 482 166	← 1593	
							1 987 482 167	→ 1578	
	2.0 CRDi		06.00-07.03	83/102-105	4SB		1 987 482 166	← 1593	
	2.0 16V						1 987 482 167	→ 1578	
<b>Excel Hatchback [X2]</b>									
	1.3 i		04.89-07.94	43/49			0 986 473 171	← 53,9	
							0 986 474 171	→ 53,9	
	1.5 i		04.89-07.94	53/61-62			0 986 473 171	← 53,9	
							0 986 474 171	→ 53,9	
	1.3 i		04.89-07.94	43/49			0 986 475 839	← 20,6	
							0 986 475 851	→ 20,6	
	1.5 i		04.89-07.94	53/61-62			0 986 475 839	← 20,6	
							0 986 475 851	→ 20,6	
<b>Excel Hatchback [X3]</b>									
	1.5 i		11.95-07.99	73			0 986 473 203	← 51	F 026 A03 476 <sup>6</sup>
							0 986 474 203	→ 51	F 026 A03 476 <sup>6</sup>
	1.5 i		11.95-07.99	73			0 986 475 846	← 19,05	
							0 986 475 849	→ 19,05	
<b>Excel [X2]</b>									
	1.3 i		04.89-07.94	43/49			0 986 473 171	← 53,9	
							0 986 474 171	→ 53,9	
	1.5 i		04.89-07.94	53/61-62			0 986 473 171	← 53,9	
							0 986 474 171	→ 53,9	
	1.3 i		04.89-07.94	43/49			0 986 475 839	← 20,6	
							0 986 475 851	→ 20,6	
	1.5 i		04.89-07.94	53/61-62			0 986 475 839	← 20,6	
							0 986 475 851	→ 20,6	
<b>Excel [X3]</b>									
	1.3 i		07.94-07.99	55			0 986 473 203	← 51	F 026 A03 476 <sup>6</sup>
							0 986 474 203	→ 51	F 026 A03 476 <sup>6</sup>
	1.5 i		07.94-07.99	65-68/73			0 986 473 203	← 51	F 026 A03 476 <sup>6</sup>
	1.5 i 16V						0 986 474 203	→ 51	F 026 A03 476 <sup>6</sup>



◀ HYUNDAI Excel [X3]									
	1.3i	07.94-07.99	55		0986 475 846	← 19,05			
					0986 475 849	→ 19,05			
	1.5i	07.94-07.99	65-68/73		0986 475 846	← 19,05			
	1.5i 16V				0986 475 849	→ 19,05			
	1.3i	07.94-11.94	55		1987 482 164	← 1503			
					1987 482 165	→ 1503			
		12.94-07.99	55		1987 477 612	← 1485			
					1987 477 614	→ 1485			
	1.5i	07.94-11.94	65-68		1987 482 164	← 1503			
					1987 482 165	→ 1503			
		12.94-07.99	65-68		1987 477 612	← 1485			
					1987 477 614	→ 1485			
Getz [BT/BU]									
	1.3i	09.05-02.10	61		F 026 009 929	→ 17,5			
					0986 475 928	← 17,46			
Getz [TB]									
	1.1	09.02-06.09	46-49		0986 473 171	← 53,9	F 026 A03 496 <sup>7</sup>		
					0986 474 171	→ 53,9	F 026 A03 496 <sup>7</sup>		
	1.3	09.02-08.05	60-63		0986 473 171	← 53,9	F 026 A03 496 <sup>7</sup>		
					0986 474 171	→ 53,9	F 026 A03 496 <sup>7</sup>		
	1.4	09.05-06.09	71		0986 473 171	← 53,9	F 026 A03 496 <sup>7</sup>		
					0986 474 171	→ 53,9	F 026 A03 496 <sup>7</sup>		
	1.5 CRDi	05.03-06.09	60/65/81		0986 473 171	← 53,9	F 026 A03 496 <sup>7</sup>		
					0986 474 171	→ 53,9	F 026 A03 496 <sup>7</sup>		
	1.6	09.02-06.09	77-78		0986 473 171	← 53,9	F 026 A03 496 <sup>7</sup>		
					0986 474 171	→ 53,9	F 026 A03 496 <sup>7</sup>		
		1.1	09.02-06.09	46-49		0986 475 928	← 17,46		
						0986 475 929	→ 17,46		
		1.3	09.02-08.05	60-63		0986 475 929	→ 17,46		
					0986 475 928	← 17,46			
1.3i		09.02→	60-63		0986 475 928	← 17,46			
1.3i		07.03→	60-63		F 026 009 929	→ 17,5			
1.4		09.05-06.09	71		0986 475 928	← 17,46			
					0986 475 929	→ 17,46			
1.5 CRDi		05.03-06.09	60/65/81		0986 475 928	← 17,46			
					0986 475 929	→ 17,46			
1.6	09.02-06.09	77-78		0986 475 928	← 17,46				
				0986 475 929	→ 17,46				
	1.1	ABO	09.02-06.09	46-49	1987 482 072	← 1598			
					1987 482 073	→ 1607			
		ABS	09.02-06.09	46-49	1987 482 070	← 1610			
					1987 482 071	→ 1620			
	1.3	ABO	09.02-08.05	60-63	1987 482 072	← 1598			
					1987 482 073	→ 1607			
		ABS	09.02-08.05	60-63	1987 482 070	← 1610			
					1987 482 071	→ 1620			
	1.4	09.05-06.09	71		1987 482 223	← 1584			
				4SB		1987 482 224	→ 1593		

		S									
1.4	ABO	09.05-08.07	71			STB	1 987 482 072	← 1598			
							1 987 482 073	→ 1607			
	ABS	09.05-08.07	71			STB	1 987 482 070	← 1610			
							1 987 482 071	→ 1620			
1.5 CRDi	ABO	05.03-06.09	60/65/81			4SB	1 987 482 223	← 1584			
							1 987 482 224	→ 1593			
	ABS	05.03-06.09	60/65/81			STB	1 987 482 072	← 1598			
							1 987 482 073	→ 1607			
1.6	ABO	09.02-06.09	77-78			4SB	1 987 482 223	← 1584			
							1 987 482 224	→ 1593			
	ABS	09.02-08.07	77-78			STB	1 987 482 072	← 1598			
							1 987 482 073	→ 1607			
Grace	ABO	10.95→	90				0 986 473 454	← 60			
							0 986 474 454	→ 60			
	ABS	10.95→	59				0 986 473 454	← 60			
							0 986 474 454	→ 60			
Grandeur [TG]	ABO	10.95→	90				0 986 AB8 171	← 20,64			
							0 986 AB8 172	→ 20,64			
	ABS	10.95→	59				0 986 AB8 171	← 20,64			
							0 986 AB8 172	→ 20,64			
Grandeur [TG]	ABO	07.05-09.05	171-173						F 026 A06 129 <sup>7</sup>		
H 100	ABO	07.93-03.00	82-84/90				0 986 473 454	← 60			
							0 986 474 454	→ 60			
		ABS	02.93-04.00	55/57/59/63					0 986 473 454	← 60	
									0 986 474 454	→ 60	
	ABO	07.93-03.00	82-84/90					0 986 AB8 171	← 20,64		
								0 986 AB8 172	→ 20,64		
		ABS	07.93-02.07	59					0 986 AB8 171	← 20,64	
									0 986 AB8 172	→ 20,64	
		ABS	02.93-03.00	55/57					0 986 AB8 171	← 20,64	
									0 986 AB8 172	→ 20,64	
		ABS	09.96-09.04	63					0 986 AB8 171	← 20,64	
									0 986 AB8 172	→ 20,64	
		FKR	07.93-03.00	59					0 986 475 957	← 19	
									0 986 475 958	→ 19	
FLR	07.93-03.00	59					0 986 AB8 171	← 20,64			
							0 986 AB8 172	→ 20,64			
FLR	01.03-02.07	59					0 986 AB8 171	← 20,64			
							0 986 AB8 172	→ 20,64			



		S							
◀ HYUNDAI H 100									
	2.5 D	02.93-12.94	55			LAB	0 265 006 133 <sup>3</sup>		
<b>H-1</b>									
	2.4	10.97-05.07	82/99-107				0 986 473 494		← 43
	2.4i						0 986 474 494		→ 43
	2.5 D	10.97-08.02	57				0 986 473 494		← 43
							0 986 474 494		→ 43
	2.4	06.01-10.02	99-107			AA	0 986 475 959		← 22,2
							0 986 475 960		→ 22,2
		06.01-12.04	99-107			AA	0 986 475 959		← 22,2
							0 986 475 960		→ 22,2
		11.02-09.06	99-107			AA	0 986 475 944		↔ 20,6
	2.4i	10.97-03.98	82				0 986 475 959		← 22,2
							0 986 475 960		→ 22,2
	2.5 CRDi	10.97-12.07	81/103				0 986 475 944		↔ 20,6
	2.5 D	10.97-03.98	57				0 986 475 959		← 22,2
							0 986 475 960		→ 22,2
	2.5 Tci	10.99-12.07	73-74				0 986 475 959		← 22,2
							0 986 475 960		→ 22,2
<b>i10 [PA]</b>									
	1.0	10.10-09.13	49				F 026 002 010		← 15,87
							F 026 002 011		→ 15,87
	1.1	10.07→	49/51				F 026 002 010		← 15,87
	1.1i						F 026 002 011		→ 15,87
	1.1 LPG	03.09-02.11	47				0 986 AB8 126		→ 15,88
							0 986 AB8 127		← 15,88
	1.2	10.10-09.13	63				F 026 002 010		← 15,87
							F 026 002 011		→ 15,87
	1.2i 16V	07.08→	59				0 986 AB8 126		→ 15,88
							0 986 AB8 127		← 15,88
	1.0	10.10-09.13	49				0 986 134 222		←
							0 986 135 222		→
	1.1, CRDi, LPG	03.08-09.13	47/49/51/ 55				0 986 134 222		←
							0 986 135 222		→
	1.2	08.08-09.13	54/57/63				0 986 134 222		←
	1.2 LPG						0 986 135 222		→
<b>i20 [GB]</b>									
	1.0	11.14→	62				0 986 475 985		↔ 17,5
	1.1 CRDi	11.14→	55				0 986 475 985		↔ 17,5
	1.2	11.14→	55				0 986 475 985		↔ 17,5
	1.4	11.14→	66/74				0 986 475 985		↔ 17,5
<b>i20 [PB, PBT]</b>									
	1.25	MFD 03.12→	63				0 986 134 294		← 54
							0 986 135 294		→ 54



		S				?			
	1.25	03.12→	63				0 986 475 985	← 17,5	
							0 986 475 986	→ 17,5	
	1.25	03.12→	63				0 986 134 248	←	
							0 986 135 248	→	
	1.25	03.12→	63				1 987 482 349	← 1615	
							1 987 482 350	→ 1648	
<b>i20 [PB/PBT]</b>									
	1.1 CRDi	03.12→	55				0 986 134 294	← 54	
							0 986 135 294	→ 54	
	1.4	10.08→	55/66/74				0 986 134 294	← 54	
	1.4 CRDi						0 986 135 294	→ 54	
	1.6	01.09-03.12	85/91-93/				0 986 134 294	← 54	
	1.6 CRDi		94				0 986 135 294	→ 54	
	1.25	MFD 01.09-03.12	57				0 986 134 294	← 54	
							0 986 135 294	→ 54	
	1.25	01.09-03.12	57				0 986 475 985	← 17,5	
							0 986 475 986	→ 17,5	
	1.1 CRDi	03.12→	55				0 986 134 248	←	
							0 986 135 248	→	
	1.4	10.08→	55/66/74				0 986 134 248	←	
	1.4 CRDi						0 986 135 248	→	
	1.6	01.09-03.12	85/91-93/				0 986 134 248	←	
	1.6 CRDi		94				0 986 135 248	→	
	1.25	01.09-03.12	57				0 986 134 248	←	
							0 986 135 248	→	
	1.1 CRDi	03.12→	55				1 987 482 349	← 1615	
							1 987 482 350	→ 1648	
	1.4	10.08→	55/66/74				1 987 482 349	← 1615	
	1.4 CRDi						1 987 482 350	→ 1648	
	1.6	01.09-03.12	85/91-93/				1 987 482 349	← 1615	
	1.6 CRDi		94				1 987 482 350	→ 1648	
	1.25	01.09-03.12	57				1 987 482 349	← 1615	
							1 987 482 350	→ 1648	
<b>i30 CW [FD/FDH]</b>									
	1.4	03.09-09.12	76/77-80		15Z		0 986 134 295	← 57	
	1.4 LPG						0 986 135 295	→ 57	
	1.6, CRDi, LPG	02.08-09.12	66/85-93/		15Z		0 986 134 295	← 57	
			94				0 986 135 295	→ 57	
	2.0, CRDi, LPG	03.08-03.11	100-103/		15Z		0 986 134 295	← 57	
			105				0 986 135 295	→ 57	





		S							
◀ HYUNDAI									
<b>i30 [FD/FDH]</b>									
	1.4	09.07-12.11	76-80			15Z	0986 134 295		← 57
	1.4 LPG						0986 135 295		→ 57
	1.6, CRDi, LPG	09.07-08.12	66/81-93/ 94			15Z	0986 134 295		← 57
							0986 135 295		→ 57
	2.0, CRDi, LPG	09.07-01.13	100-103/ 105			15Z	0986 134 295		← 57
							0986 135 295		→ 57
<b>Lantra [J1]</b>									
	1.5 i	10.90-04.95	53/57/63				0986 473 171		← 53,9
							0986 474 171		→ 53,9
	1.5 i	10.90-04.95	53/57/63				0986 475 848		← 19,05
							0986 475 849		→ 19,05
	1.6 i 16V	10.90-04.95	78-84				0986 475 848		← 19,05
							0986 475 849		→ 19,05
	1.8 i 16V	06.92-04.95	93				0986 475 848		← 19,05
							0986 475 849		→ 19,05
	1.5 i	ABS 05.93-04.95	53/57/63						F 026 A06 128 <sup>7</sup>
	1.6 i 16V	ABS 05.93-04.95	78-84						F 026 A06 128 <sup>7</sup>
	1.8 i 16V	ABS 05.93-04.95	93						F 026 A06 128 <sup>7</sup>
<b>Lantra [J2]</b>									
	1.5 i	04.99-09.00	65-68				0986 473 120		← 53,9
							0986 474 120		→ 53,9
		ABS 07.96-03.97	65-68				0986 473 331		← 54
							0986 474 331		→ 54
		04.99-09.00	65-68				0986 473 120		← 53,9
							0986 474 120		→ 53,9
	1.6 i 16V	05.95-03.97	66/84				0986 473 331		← 54
							0986 474 331		→ 54
		04.99-09.00	66/84				0986 473 120		← 53,9
							0986 474 120		→ 53,9
	1.8 i 16V	05.95-03.97	94				0986 473 331		← 54
							0986 474 331		→ 54
		04.99-09.00	94				0986 473 120		← 53,9
							0986 474 120		→ 53,9
	2.0 i 16V	08.96-03.97	102				0986 473 331		← 54
							0986 474 331		→ 54
		04.99-09.00	102				0986 473 120		← 53,9
							0986 474 120		→ 53,9
	1.5 i	07.96-09.00	65-68				0986 475 848		← 19,05
							0986 475 849		→ 19,05
	1.6 i 16V	05.95-09.00	66/84				0986 475 848		← 19,05
							0986 475 849		→ 19,05
	1.8 i 16V	05.95-09.00	94				0986 475 848		← 19,05
							0986 475 849		→ 19,05
	2.0 i 16V	08.96-09.00	102				0986 475 848		← 19,05
							0986 475 849		→ 19,05



		S									
	1.5i	07.96-09.00	65-68				0 986 473 083		← 33,9	F 026 A06 128 <sup>7</sup>	
							0 986 474 083		→ 33,9	F 026 A06 128 <sup>7</sup>	
	1.6i 16V	05.95-09.00	66/84				0 986 473 083		← 33,9	F 026 A06 128 <sup>7</sup>	
							0 986 474 083		→ 33,9	F 026 A06 128 <sup>7</sup>	
	1.8i 16V	05.95-09.00	94				0 986 473 083		← 33,9	F 026 A06 128 <sup>7</sup>	
							0 986 474 083		→ 33,9	F 026 A06 128 <sup>7</sup>	
	2.0i 16V	08.96-09.00	102				0 986 473 083		← 33,9	F 026 A06 128 <sup>7</sup>	
							0 986 474 083		→ 33,9	F 026 A06 128 <sup>7</sup>	
	1.5i	07.96-09.00	65-68			TBR	1 987 482 168		← 1578		
							1 987 482 169		→ 1571		
	1.6i 16V	05.95-09.00	66/84			TBR	1 987 482 168		← 1578		
							1 987 482 169		→ 1571		
	1.8i 16V	05.95-09.00	94			TBR	1 987 482 168		← 1578		
							1 987 482 169		→ 1571		
	2.0i 16V	08.96-09.00	102			TBR	1 987 482 168		← 1578		
							1 987 482 169		→ 1571		
<b>Lantra Kombi [J2]</b>											
	1.5i	04.99-09.00	65				0 986 473 120		← 53,9		
							0 986 474 120		→ 53,9		
		ABS	07.96-03.97	65				0 986 473 331		← 54	
								0 986 474 331		→ 54	
			04.99-09.00	65				0 986 473 120		← 53,9	
								0 986 474 120		→ 53,9	
	1.6i	05.95-03.97	66/84					0 986 473 331		← 54	
								0 986 474 331		→ 54	
			04.99-09.00	66/84				0 986 473 120		← 53,9	
								0 986 474 120		→ 53,9	
	1.8i	05.95-03.97	94					0 986 473 331		← 54	
								0 986 474 331		→ 54	
		04.99-09.00	94				0 986 473 120		← 53,9		
							0 986 474 120		→ 53,9		
	2.0i	08.96-03.97	102				0 986 473 331		← 54		
							0 986 474 331		→ 54		
		04.99-09.00	102				0 986 473 120		← 53,9		
							0 986 474 120		→ 53,9		
	1.5i	07.96-09.00	65				0 986 475 848		← 19,05		
							0 986 475 849		→ 19,05		
	1.6i	05.95-09.00	66/84				0 986 475 848		← 19,05		
							0 986 475 849		→ 19,05		
	1.8i	05.95-09.00	94				0 986 475 848		← 19,05		
							0 986 475 849		→ 19,05		
	2.0i	08.96-09.00	102				0 986 475 848		← 19,05		
							0 986 475 849		→ 19,05		
	1.5i	07.96-09.00	65				0 986 473 083		← 33,9	F 026 A06 128 <sup>7</sup>	
							0 986 474 083		→ 33,9	F 026 A06 128 <sup>7</sup>	
	1.6i	05.95-09.00	66/84				0 986 473 083		← 33,9	F 026 A06 128 <sup>7</sup>	
							0 986 474 083		→ 33,9	F 026 A06 128 <sup>7</sup>	
	1.8i	05.95-09.00	94				0 986 473 083		← 33,9	F 026 A06 128 <sup>7</sup>	
							0 986 474 083		→ 33,9	F 026 A06 128 <sup>7</sup>	
	2.0i	08.96-09.00	102				0 986 473 083		← 33,9	F 026 A06 128 <sup>7</sup>	
							0 986 474 083		→ 33,9	F 026 A06 128 <sup>7</sup>	



		S							
◀ HYUNDAI Lantra Kombi [J2]									
	1.5 i	07.96-09.00	65		TBR	1987 <b>482 168</b>	← 1578		
						1987 <b>482 169</b>	→ 1571		
	1.6 i	05.95-09.00	66/84		TBR	1987 <b>482 168</b>	← 1578		
						1987 <b>482 169</b>	→ 1571		
	1.8 i	05.95-09.00	94		TBR	1987 <b>482 168</b>	← 1578		
						1987 <b>482 169</b>	→ 1571		
	2.0 i	08.96-09.00	102		TBR	1987 <b>482 168</b>	← 1578		
						1987 <b>482 169</b>	→ 1571		
<b>Matrix [FC]</b>									
	1.5 CRDi	07.01-03.02	60			0986 <b>473 120</b>	← 53,9		
						0986 <b>474 120</b>	→ 53,9		
	1.6 i	08.01-03.02	66/76			0986 <b>473 120</b>	← 53,9		
						0986 <b>474 120</b>	→ 53,9		
	1.8 i	08.01-03.02	90			0986 <b>473 120</b>	← 53,9		
						0986 <b>474 120</b>	→ 53,9		
	1.5 CRDi	07.01-10.04	60			0986 <b>475 854</b>	→ 19,05		
						0986 <b>475 855</b>	← 19,05		
		11.04-01.06	60			0986 <b>475 854</b>	← 19,05		
						0986 <b>475 855</b>	→ 19,05		
		02.05-04.10	75/81			0986 <b>475 854</b>	← 19,05		
						0986 <b>475 855</b>	→ 19,05		
	1.6 i	08.01-10.04	66/76			0986 <b>475 854</b>	→ 19,05		
						0986 <b>475 855</b>	← 19,05		
		11.04-04.10	66/76			0986 <b>475 854</b>	← 19,05		
						0986 <b>475 855</b>	→ 19,05		
1.8 i	08.01-10.04	90			0986 <b>475 854</b>	→ 19,05			
					0986 <b>475 855</b>	← 19,05			
	11.04-04.10	90			0986 <b>475 854</b>	← 19,05			
					0986 <b>475 855</b>	→ 19,05			
	1.5 CRDi	OFD	07.01-04.10	60/75/81	LLE	1987 <b>482 074</b>	← 1650		
						1987 <b>482 075</b>	→ 1718		
			RLE	1987 <b>482 209</b>	← 1718				
				1987 <b>482 210</b>	→ 1650				
	1.6 i	OFD	08.01-04.10	66/76	LLE	1987 <b>482 074</b>	← 1650		
						1987 <b>482 075</b>	→ 1718		
			RLE	1987 <b>482 209</b>	← 1718				
				1987 <b>482 210</b>	→ 1650				
	1.8 i	OFD	08.01-04.10	90	LLE	1987 <b>482 074</b>	← 1650		
						1987 <b>482 075</b>	→ 1718		
			RLE	1987 <b>482 209</b>	← 1718				
				1987 <b>482 210</b>	→ 1650				
<b>Pony [X2]</b>									
	1.3 i	04.89-07.94	43/45-49		0986 <b>473 171</b>	← 53,9			
					0986 <b>474 171</b>	→ 53,9			
	1.5 i	04.89-07.94	53/61-62		0986 <b>473 171</b>	← 53,9			
					0986 <b>474 171</b>	→ 53,9			

		S							
	1.3i	04.89-07.94	43/45-49			EMA	0 986 475 839	← 20,6	
							0 986 475 851	→ 20,6	
	1.5i	04.89-07.94	53/61-62			EMA	0 986 475 839	← 20,6	
							0 986 475 851	→ 20,6	
<b>Pony [X3]</b>									
	1.3i	07.94-07.99	62				0 986 473 203	← 51	F 026 A03 476 <sup>®</sup>
							0 986 474 203	→ 51	F 026 A03 476 <sup>®</sup>
	1.3i	07.94-07.99	62				0 986 475 846	← 19,05	
							0 986 475 849	→ 19,05	
	1.3i	07.94-11.94	62				1 987 482 164	← 1503	
							1 987 482 165	→ 1503	
		12.94-07.99	62				1 987 477 612	← 1485	
							1 987 477 614	→ 1485	
<b>Santa Fe [SM]</b>									
	2.0 CRDi 4x4, CRDi-VGT 4x4, i	01.01-12.05	83/92-107				0 986 475 944	← 20,6	
							0 986 475 945	→ 20,6	
	2.4i	02.00-12.05	100/107				0 986 475 944	← 20,6	
	2.4i 4x4						0 986 475 945	→ 20,6	
	2.0 CRDi 4x4, CRDi-VGT 4x4, i	01.01-12.05	83/92-107			4SB,LLE	1 987 482 076	← 1741	
							1 987 482 077	→ 1775	
	2.4i	02.00-12.05	100/107			4SB,LLE	1 987 482 076	← 1741	
	2.4i 4x4						1 987 482 077	→ 1775	
	2.7i 4x4	09.99-12.05	127-132			4SB,LLE	1 987 482 076	← 1741	
							1 987 482 077	→ 1775	
<b>Santro [MX]</b>									
	1.0i 12V	09.98-11.00	40				0 986 473 084	← 51,04	
							0 986 474 084	→ 51,04	
		12.00-01.02	40				0 986 134 273	← 51	
							0 986 135 273	→ 51	
	1.1i 12V	03.02→	46-48				0 986 135 273	→ 51	
	1.0i 12V	09.98-01.02	40				0 986 475 928	← 17,46	
							0 986 475 929	→ 17,46	
	1.1i 12V	03.02→	46-48				0 986 475 928	← 17,46	
							0 986 475 929	→ 17,46	
	1.0i 12V	09.98-01.02	40				1 987 477 611	← 1504	
							1 987 477 613	→ 1520	
	1.1i 12V	03.02→	46-48				1 987 477 611	← 1504	
							1 987 477 613	→ 1520	



		S				?			
◀ HYUNDAI									
<b>Satellite</b>									
	2.4 i	10.97-05.07	82				0986 473 494		← 43
	2.4 i 4WD						0986 474 494		→ 43
	2.5 D Turbo	10.97-08.02	63				0986 473 494		← 43
	2.5 D Turbo 4WD						0986 474 494		→ 43
	2.4 i	10.97-05.07	82				0986 475 959		← 22,2
	2.4 i 4WD	10.97-05.07	82				0986 475 960		→ 22,2
	2.4 i 4WD	10.97-05.07	82				0986 475 959		← 22,2
	2.4 i 4WD	10.97-05.07	82				0986 475 960		→ 22,2
	2.5 D Turbo	10.97-08.02	63				0986 475 959		← 22,2
	2.5 D Turbo	10.97-08.02	63				0986 475 960		→ 22,2
	2.5 D Turbo 4WD	10.97-08.02	63				0986 475 959		← 22,2
	2.5 D Turbo 4WD	10.97-08.02	63				0986 475 960		→ 22,2
<b>Satnta Fe [DM]</b>									
	2.0 CRDi	04.01-12.05	83				0986 475 944		← 20,6
	2.0 CRDi	04.01-12.05	83				0986 475 945		→ 20,6
	2.0 CRDi	04.01-12.05	83		4SB,LLE		1987 482 076		← 1741
	2.0 CRDi	04.01-12.05	83		4SB,LLE		1987 482 077		→ 1775
<b>Scoupe</b>									
	1.5 i	07.92-04.95	65-68/				0986 473 171		← 53,9
	1.5 i Turbo GT		84-85				0986 474 171		→ 53,9
	1.5 i	04.91-04.95	65-68/				0986 475 839		← 20,6
	1.5 i Turbo GT		84-85				0986 475 851		→ 20,6
<b>Solaris Hatchback [RB]</b>									
	1.4	01.11→	79				0986 475 985		↔ 17,5
	1.6	01.11→	90				0986 475 985		↔ 17,5
<b>Solaris [RB]</b>									
	1.4	01.11→	79				0986 475 985		↔ 17,5
	1.6	01.11→	90-91				0986 475 985		↔ 17,5
<b>Sonata [EF]</b>									
	2.0 i, LPG	03.98-11.04	96-98/100/108						F 026 A06 129 <sup>7</sup>
	2.4 i	05.98-03.01	105						F 026 A06 129 <sup>7</sup>
	2.5 i	03.98-03.01	118/129						F 026 A06 129 <sup>7</sup>
	2.7 i	04.01-01.06	127-132						F 026 A06 129 <sup>7</sup>



		S							
<b>Sonata [NF]</b>									
	2.4		08.04-05.05	119					F 026 A06 129 <sup>7</sup>
	3.3		12.04-09.05	171-173					F 026 A06 129 <sup>7</sup>
<b>Sonata V [EF]</b>									
	2.0i		12.03-09.11	101					F 026 A06 129 <sup>7</sup>
	2.7i		12.03-05.06	127-131					F 026 A06 129 <sup>7</sup>
<b>Sonata [Y3]</b>									
	1.8i	ABO	07.93-06.98	63/72			0 986 475 848	← 19,05	
	1.8i GLS						0 986 475 849	→ 19,05	
	2.0i	ABO	07.93-06.98	77/92/102			0 986 475 848	← 19,05	
							0 986 475 849	→ 19,05	
	1.8i	ABS	07.93-06.98	63/72	EFV		0 986 473 035	← 38,1	
	1.8i GLS						0 986 474 035	→ 38,1	
	2.0i	ABS	07.93-06.98	77/92/102	EFV		0 986 473 035	← 38,1	
							0 986 474 035	→ 38,1	
	3.0i		07.93-06.98	107			0 986 473 035	← 38,1	
							0 986 474 035	→ 38,1	
<b>Starex</b>									
	2.4i		10.97-05.07	82-86			0 986 473 494	← 43	
	2.4i 4WD						0 986 474 494	→ 43	
	2.5 CRDi		10.02-06.03	74/103			0 986 473 494	← 43	
	2.5 TCI						0 986 474 494	→ 43	
	2.5 D, D Turbo, D Turbo 4WD		10.97-08.02	57/59			0 986 473 494	← 43	
							0 986 474 494	→ 43	
	2.4i		10.97-05.07	82			0 986 475 959	← 22,2	
							0 986 475 960	→ 22,2	
	2.4i 4WD		10.97-05.07	82-86			0 986 475 959	← 22,2	
							0 986 475 960	→ 22,2	
	2.5 CRDi		10.02-01.07	74/103			0 986 475 944	↔ 20,6	
	2.5 D		10.97-08.02	57			0 986 475 959	← 22,2	
							0 986 475 960	→ 22,2	
	2.5 D Turbo		10.97-08.02	59			0 986 475 959	← 22,2	
							0 986 475 960	→ 22,2	
	2.5 D Turbo 4WD		10.97-08.02	59			0 986 475 959	← 22,2	
							0 986 475 960	→ 22,2	
	2.5 TCI		10.02-12.07	74/103			0 986 475 944	↔ 20,6	
<b>Tiburon [RD]</b>									
	1.5i	ABS	04.96→	74-76			0 986 473 331	← 54	
							0 986 474 331	→ 54	
	2.0i		09.96-08.97	102-103			0 986 473 331	← 54	
							0 986 474 331	→ 54	



		S				?			
◀ HYUNDAI Tiburon [RD]									
	1.5 i	04.96→	74-76				0986 475 848	← 19,05	
							0986 475 849	→ 19,05	
	1.5 i	06.96→	74-76			EFV,SBR	0986 473 083	← 33,9	
	2.0 i	09.96-08.97	102-103				0986 473 083	← 33,9	
							0986 474 083	→ 33,9	
Trajet [FO]									
	2.0 CRDi	01.00-06.07	83-92/100				0986 475 944	← 20,6	
	2.0 i						0986 475 945	→ 20,6	
	2.7 i	01.00-06.07	127				0986 475 944	← 20,6	
							0986 475 945	→ 20,6	
Trajet XG									
	2.0 i	10.99→	104				0986 475 944	← 20,6	
							0986 475 945	→ 20,6	
	2.7 i	10.99-06.07	127-136				0986 475 944	← 20,6	
							0986 475 945	→ 20,6	
Tucson [JM]									
	2.0 CRDi	08.04-03.10	83/100-103/			LLE	1987 482 529	← 1712	
	2.0 i		104-105/110				1987 482 530	→ 1800	
Verna [LC]									
	1.5 i Lean Burn	07.99-03.06	70				0986 473 171	← 53,9	F 026 A03 496 <sup>7</sup>
							0986 474 171	→ 53,9	F 026 A03 496 <sup>7</sup>
	1.5 i Lean Burn	07.99-08.02	70				0986 475 854	→ 19,05	
							0986 475 855	← 19,05	
		09.02-03.06	70				0986 475 928	← 17,46	
							0986 475 929	→ 17,46	
	1.5 i Lean Burn	07.99-07.02	70				1987 477 614	↔ 1485	
		08.02-03.06	70				1987 477 055	→ 1493	
							1987 477 066	← 1493	
XG [F]									
	25 2.5i	12.98-12.05	120						F 026 A06 129 <sup>7</sup>
	30 3.0i	12.98-12.05	138						F 026 A06 129 <sup>7</sup>
	35 3.5i	08.02-12.05	145						F 026 A06 129 <sup>7</sup>





**INFINITI**

**EX [J50]**

	25 4x4	02.11→	163		0 265 008 529 <sup>3</sup>
					0 265 008 563 <sup>4</sup>
	30 d 4x4	04.10-09.10	175		0 265 008 382 <sup>3</sup>
				LAB	0 265 008 564 <sup>4</sup>
		RAB	0 265 008 577 <sup>4</sup>		
		10.10→	175		0 265 008 529 <sup>3</sup>
				LAB	0 265 008 530 <sup>4</sup>
				RAB	0 265 008 531 <sup>4</sup>
	35 4x4	04.08-05.09	222	LAB	0 265 008 190 <sup>4</sup>
				RAB	0 265 008 191 <sup>4</sup>
		04.08-01.10	222		0 265 008 219 <sup>3</sup>
		06.09-01.10	222	LAB	0 265 008 564 <sup>4</sup>
	37 4x4	06.08-05.09	235-243	LAB	0 265 008 190 <sup>4</sup>
				06.08-09.10	235-243
				GS,RLE	0 265 008 382 <sup>3</sup>
				LLE	0 265 008 219 <sup>3</sup>
		06.08-12.10	235-243	RAB	0 265 008 577 <sup>4</sup>
		06.09-12.10	235-243	LAB	0 265 008 564 <sup>4</sup>
		10.10-12.10	235-243	LLE	0 265 008 382 <sup>3</sup>
					0 265 008 529 <sup>3</sup>
				RLE	0 265 008 529 <sup>3</sup>
		10.10→	235-243	LAB	0 265 008 530 <sup>4</sup>
			RAB	0 265 008 563 <sup>4</sup>	
	01.11→	235-243		0 265 008 529 <sup>3</sup>	

**FX [S51]**

	30 d 4x4	03.10-11.10	175	RAB	0 265 008 577 <sup>4</sup>
		03.10→	175		0 265 008 383 <sup>3</sup>
		12.10→	175	RAB	0 265 008 531 <sup>4</sup>
	35 4x4	09.08-01.10	228	LAB	0 265 008 245 <sup>4</sup>
				RAB	0 265 008 577 <sup>4</sup>
	37 4x4	07.08-11.10	235-245	RAB	0 265 008 577 <sup>4</sup>
		07.08-08.11	235-245	LAB	0 265 008 245 <sup>4</sup>
		01.10→	235-245		0 265 008 383 <sup>3</sup>
		12.10→	235-245	RAB	0 265 008 531 <sup>4</sup>
	50 4x4	07.08-11.10	287-294	RAB	0 265 008 577 <sup>4</sup>
		07.08-08.11	287-294	LAB	0 265 008 245 <sup>4</sup>
		01.10→	287-294		0 265 008 383 <sup>3</sup>
		12.10→	287-294	RAB	0 265 008 531 <sup>4</sup>

**FX50 [S51]**

	5.0 4x4	06.13→	309	LAB	0 265 008 383 <sup>3</sup>
				RAB	0 265 008 383 <sup>3</sup>
					0 265 008 531 <sup>4</sup>

**G Cabrio [HV36]**

	37	06.09-01.10	235-245		0 265 008 025 <sup>3</sup>		
				06.09→	235-245	LAB	0 265 008 564 <sup>4</sup>
						RAB	0 265 008 563 <sup>4</sup>





	◀ INFINITI G Cabrio [HV36]						
	37	02.10→	235-245			0 265 008 381 <sup>3</sup>	

**G Coupé [CV36]**

	37	10.07-05.09	235-245		LAB	0 265 008 190 <sup>4</sup>	
					RAB	0 265 008 191 <sup>4</sup>	
		10.07-01.10	235-245			0 265 008 025 <sup>3</sup>	
		06.09→	235-245		LAB	0 265 008 564 <sup>4</sup>	
					RAB	0 265 008 563 <sup>4</sup>	
		02.10→	235-245			0 265 008 381 <sup>3</sup>	

**G [V36]**

	25	01.10-01.10	163			0 265 008 024 <sup>3</sup>	
		01.10→	163			0 265 007 714 <sup>4</sup>	
		02.10→	163			0 265 008 380 <sup>3</sup>	
	35 4x4	12.06-12.08	232			0 265 007 714 <sup>4</sup>	
						0 265 008 025 <sup>3</sup>	
	37	07.08-01.10	235-243			0 265 008 024 <sup>3</sup>	
		02.10→	235-243			0 265 008 380 <sup>3</sup>	
	37, 4x4	07.08→	235-243			0 265 007 714 <sup>4</sup>	
	37 4x4	07.08-01.10	235-243			0 265 008 025 <sup>3</sup>	
		02.10→	235-243			0 265 008 381 <sup>3</sup>	

**M [Y50]**

	35	07.06-05.10	206/226			0 265 007 690 <sup>3</sup>	
	35 4x4					0 265 007 714 <sup>4</sup>	
	45	07.06-05.10	250			0 265 007 690 <sup>3</sup>	
						0 265 007 714 <sup>4</sup>	

**M [Y51]**

	25	07.10→	163			0 265 008 516 <sup>3</sup>	
					LAB	0 265 008 530 <sup>4</sup>	
					RAB	0 265 008 531 <sup>4</sup>	
	30 d	07.10→	175			0 265 008 516 <sup>3</sup>	
					LAB	0 265 008 530 <sup>4</sup>	
					RAB	0 265 008 531 <sup>4</sup>	
	35 h	01.11→	225			0 265 008 516 <sup>3</sup>	
					LAB	0 265 008 530 <sup>4</sup>	
					RAB	0 265 008 531 <sup>4</sup>	
	37	05.10→	235			0 265 008 516 <sup>3</sup>	
					LAB	0 265 008 530 <sup>4</sup>	
					RAB	0 265 008 531 <sup>4</sup>	
	37 4x4	05.10→	243-245			0 265 008 529 <sup>3</sup>	
					LAB	0 265 008 530 <sup>4</sup>	
					RAB	0 265 008 531 <sup>4</sup>	
	56	07.10-09.13	300			0 265 008 516 <sup>3</sup>	
		10.13→	300			0 265 008 529 <sup>3</sup>	
	56	07.10→	300		LAB	0 265 008 530 <sup>4</sup>	
	56 4x4				RAB	0 265 008 531 <sup>4</sup>	
	56 4x4	07.12→	300			0 265 008 529 <sup>3</sup>	



**QX50**

	3.0	10.13→	175			0 265 008 529 <sup>3</sup>	
				LAB		0 265 008 530 <sup>4</sup>	
				RAB		0 265 008 531 <sup>4</sup>	
	3.7	10.13→	235			0 265 008 529 <sup>3</sup>	
				LAB		0 265 008 530 <sup>4</sup>	
				RAB		0 265 008 563 <sup>4</sup>	

**QX70 [S51]**

	3.0 Turbo AWD	11.13→	175			0 265 008 383 <sup>3</sup>	
				LAB		0 265 008 383 <sup>3</sup>	
				RAB		0 265 008 531 <sup>4</sup>	
	3.7 AWD	11.13→	235			0 265 008 383 <sup>3</sup>	
				LAB		0 265 008 383 <sup>3</sup>	
				RAB		0 265 008 531 <sup>4</sup>	
	5.0 AWD	11.13→	287			0 265 008 383 <sup>3</sup>	
				LAB		0 265 008 383 <sup>3</sup>	
				RAB		0 265 008 531 <sup>4</sup>	

**Q60 Cabrio**

	3.7	10.13→	235			0 265 008 381 <sup>3</sup>	
				LAB		0 265 008 564 <sup>4</sup>	
				RAB		0 265 008 563 <sup>4</sup>	

**Q60 Coupé**

	3.7	10.13→				0 265 008 381 <sup>3</sup>	
				LAB		0 265 008 564 <sup>4</sup>	
				RAB		0 265 008 563 <sup>4</sup>	

**Q70 [Y51]**

	2.2	10.14→	125			0 265 008 529 <sup>3</sup>	
				LAB		0 265 008 530 <sup>4</sup>	
				RAB		0 265 008 531 <sup>4</sup>	
	3.0 DCI	10.13→	175			0 265 008 516 <sup>3</sup>	
				LAB		0 265 008 530 <sup>4</sup>	
				RAB		0 265 008 531 <sup>4</sup>	
	3.5 Hybrid	10.13→	225-268			0 265 008 516 <sup>3</sup>	
				LAB		0 265 008 530 <sup>4</sup>	
				RAB		0 265 008 531 <sup>4</sup>	
	3.7	10.13→	235			0 265 008 516 <sup>3</sup>	
				LAB		0 265 008 530 <sup>4</sup>	
				RAB		0 265 008 531 <sup>4</sup>	

**INNOCENTI (NUOVA INNOCENTI)**

**Elba**

	1.4 i.e.	09.93-12.96	49			F 026 002 454	↔ 19,05
	1.6 i.e.	09.93-12.96	55			F 026 002 454	↔ 19,05
	1.7 D	09.92-12.96	42			F 026 002 454	↔ 19,05



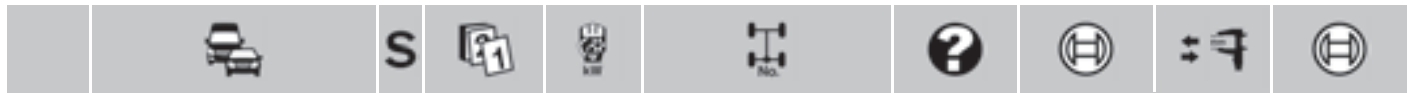

◀ INNOCENTI Elba



	1.4 i.e.	09.93-06.95	49	Fg.-Nr. VET 9778539→	1987 <b>477 296</b>	2833
		06.95-12.96	49		1987 <b>477 296</b>	2833
	1.6 i.e.	09.93-03.96	55	Fg.-Nr. VET 9778539→	1987 <b>477 296</b>	2833
		03.95-12.96	55		1987 <b>477 296</b>	2833
	1.7 D	09.92-12.96	42		1987 <b>477 296</b>	2833

Mille



	1.0 i.e.	07.94-11.97	35		1987 <b>477 296</b>	2833
	1.7 D	07.94-11.97	43		1987 <b>477 296</b>	2833

ISUZU

Trooper [UB]



	3.2 i 24V 4WD	04.92-09.04	130			F 026 <b>A08 114</b> <sup>7</sup>
--	---------------	-------------	-----	--	--	-----------------------------------

IVECO

Daily



	35 -10 Turbo	09.89-04.96	76	TW	0986 <b>475 826</b>	↔ 15,9
		05.96-05.99	76		0986 <b>475 826</b>	↔ 15,9
	35 -12 Turbo	05.96-05.99	90		0986 <b>475 826</b>	↔ 15,9

	45 S 17	04.12→	125		0986 <b>134 331</b>	↔ ← 44
					0986 <b>135 331</b>	↔ → 44





















































	A45 -10 Turbo	07.89-04.96	76/85		0265 <b>050 012</b> <sup>3</sup>	
	A45 -12 Turbo	02.90-02.96	76/85		0265 <b>050 029</b> <sup>4</sup>	
	30 -8	02.91-02.96	55		0265 <b>050 029</b> <sup>4</sup>	
		02.91-04.96	55		0265 <b>050 012</b> <sup>3</sup>	
	35 -8	02.91-02.96	55/66,1-68,9		0265 <b>050 029</b> <sup>4</sup>	
	35 -10 Turbo	02.91-04.96	55/66,1-68,9		0265 <b>050 012</b> <sup>3</sup>	
	35 -10 Turbo	07.92-04.97	80	Fg.-Nr. →5115972	0265 <b>050 026</b> <sup>4</sup>	
		05.96-05.99	76	Fg.-Nr. →5115972	0265 <b>050 026</b> <sup>4</sup>	
	35 -10 Turbo I.D.	07.92-02.96	80		0265 <b>050 029</b> <sup>4</sup>	
		07.92-04.97	80		0265 <b>050 012</b> <sup>3</sup>	
	35 -12 Turbo	10.90-02.96	85		0265 <b>050 029</b> <sup>4</sup>	
		10.90-04.96	85		0265 <b>050 012</b> <sup>3</sup>	
	40 -8	07.89-04.96	55/76		0265 <b>050 012</b> <sup>3</sup>	
	40 -10 Turbo 4x4	02.90-02.96	55/76		0265 <b>050 029</b> <sup>4</sup>	
	49 -12 Turbo	06.90-02.96	85		0265 <b>050 029</b> <sup>4</sup>	
		06.90-04.96	85		0265 <b>050 012</b> <sup>3</sup>	
	59 -12 Turbo	05.91-02.96	85		0265 <b>050 029</b> <sup>4</sup>	
		05.91-04.96	85		0265 <b>050 012</b> <sup>3</sup>	









Daily Chassi



















	35 S 14	08.07-03.12	100		0986 <b>134 331</b>	↔ ← 44
					0986 <b>135 331</b>	↔ → 44











		S							
55 C 16		08.07→	114/125				0 986 134 331	 ← 44	
55 C 17							0 986 135 331	 → 44	
									
 35 .13		10.05-07.07	92				1 987 482 148		2674
40 .13		10.05-07.07	92				1 987 482 148		2674
50 .13		10.05-07.07	92				1 987 482 148		2674
<b>Daily Furgao</b>									
									
 35 S 14		08.07-03.12	100				0 986 134 331	 ← 44	
							0 986 135 331	 → 44	
45 S 17		04.12→	125				0 986 134 331	 ← 44	
							0 986 135 331	 → 44	
55 C 17		04.12→	125				0 986 134 331	 ← 44	
							0 986 135 331	 → 44	
									
 38 .13		10.05-07.07	92				1 987 482 148		2674
40 .13		10.05-07.07	92				1 987 482 148		2674
50 .13		10.05-07.07	92				1 987 482 148		2674
<b>Daily MaxiVan</b>									
									
 40 S 16		08.07-03.12	114				0 986 134 331	 ← 44	
							0 986 135 331	 → 44	
55 C 16		08.07-03.12	114				0 986 134 331	 ← 44	
							0 986 135 331	 → 44	
									
 40 .13		10.05-07.07	92				1 987 482 148		2674
50 .13		10.05-07.07	92				1 987 482 148		2674
<b>Daily [00]</b>									
									
 29 L 10, 12, 14		09.02-03.06	70/85/100		TW		0 986 473 166	 ← 51,95	
							0 986 474 166	 → 51,95	
35 C 10, 11, 12, 13, 9		05.99-08.06	62/66/70/ 78/85/92		TW		0 986 134 331	 ← 44	
							0 986 135 331	 → 44	
35 C 14		09.04-03.06	100		TW		0 986 134 331	 ← 44	
							0 986 473 166	 ← 51,95	
							0 986 135 331	 → 44	
							0 986 474 166	 → 51,95	
35 C 15		05.01-03.06	108/122		TW		0 986 134 331	 ← 44	
35 C 17							0 986 135 331	 → 44	
35 S 10, 11, 12, 13, 14, 15, 9		05.99-08.06	62/66/70/78/ 85/92/100/108		TW		0 986 473 166	 ← 51,95	
							0 986 474 166	 → 51,95	
35 S 17		09.04-03.06	122				0 986 473 166	 ← 51,95	
							0 986 474 166	 → 51,95	
40 C 13, 14, 15, 17		01.01-03.06	92/100/ 108/122		TW		0 986 134 331	 ← 44	
							0 986 135 331	 → 44	
50 C 11, 12, 13, 14, 15, 17		05.99-08.06	78/85/92/ 100/108/122		TW		0 986 134 331	 ← 44	
							0 986 135 331	 → 44	









































			S							
◀ IVECO										
Daily [06]										
	29 L 10	04.06-12.11	71/85/100	Fg.-Nr. →5798349, →D411956			0986 473 166		←	51,95
	29 L 12						0986 474 166		→	51,95
	29 L 14			Fg.-Nr. 5798350→, D411957→			0986 473 166		←	51,95
							0986 474 166		→	51,95
	35 C 12	04.06-12.11	85				0986 134 331		←	44
						TW	0986 135 331		→	44
							0986 134 331		←	44
							0986 135 331		→	44
	35 C 14, 15, 18	04.06-12.11	100/107/ 130			TW	0986 134 331		←	44
							0986 135 331		→	44
	35 S 10	04.06-12.11	71/85	Fg.-Nr. →5798349, →D411956			0986 473 166		←	51,95
	35 S 12			Fg.-Nr. 5798350→, D411957→			0986 474 166		→	51,95
							0986 473 166		←	51,95
							0986 474 166		→	51,95
	35 S 14	04.06-12.11	100	Fg.-Nr. →5798349, →D411956			0986 473 166		←	51,95
				Fg.-Nr. 5798350→, D411957→			0986 474 166		→	51,95
		04.07-12.11	100				0986 473 166		←	51,95
							0986 474 166		→	51,95
	35 S 15	04.06-05.09	107				0986 473 166		←	51,95
							0986 474 166		→	51,95
	35 S 18	04.06-12.11	130			TW	0986 473 166		←	51,95
							0986 474 166		→	51,95
	40 C 10, 12, 14, 15, 18	04.06-12.11	71/85/100/ 107/130				0986 134 331		←	44
							0986 135 331		→	44
	50 C 12, 14, 15, 18	04.06-12.11	85/100/ 107/130				0986 134 331		←	44
							0986 135 331		→	44
	29 L 10	04.06-12.11	71/85/100			TW	0 265 004 025 <sup>3</sup>			
							0 265 004 025 <sup>4</sup>			
	29 L 10, 12, 14	04.06-12.11	71/85/100			TW	0 265 008 429 <sup>4</sup>			
	29 L 12	04.06-12.11	71/85/100			TW	0 265 004 025 <sup>3</sup>			
							0 265 004 025 <sup>4</sup>			
	29 L 14	04.06-12.11	71/85/100			TW	0 265 004 025 <sup>3</sup>			
							0 265 004 025 <sup>4</sup>			
	35 C 10	04.06-12.11	71				0 265 004 025			
	35 C 12	04.06-12.11	85			TW	0 265 004 025			
							0 265 004 025 <sup>3</sup>			
							0 265 004 025 <sup>4</sup>			
							0 265 008 429 <sup>4</sup>			
							0 265 008 430 <sup>4</sup>			
	35 C 14	04.06-12.11	100				0 265 004 025			
	35 C 15	04.06-12.11	107			TW	0 265 004 025 <sup>3</sup>			
							0 265 004 025 <sup>4</sup>			
							0 265 008 429 <sup>4</sup>			
							0 265 008 430 <sup>4</sup>			
	35 C 18	04.06-12.11	130			TW	0 265 004 025 <sup>3</sup>			
							0 265 004 025 <sup>4</sup>			
							0 265 008 429 <sup>4</sup>			
	35 S 10	04.06-12.11	71			TW	0 265 004 025 <sup>3</sup>			
							0 265 004 025 <sup>4</sup>			
							0 265 008 429 <sup>4</sup>			
	35 S 12	04.06-05.09	85/100			TW	0 265 004 025 <sup>3</sup>			
							0 265 004 025 <sup>4</sup>			
		04.06-12.11	85/100				0 265 004 025			
	35 S 12, 14	04.06-12.11	85/100			TW	0 265 008 429 <sup>4</sup>			

	S							
35 S 14	04.06-12.11	85/100				0 265 004 025		
	04.07-12.11	85/100			TW	0 265 004 025 <sup>3</sup>		
35 S 15	04.06-05.09	107/130				0 265 004 025 <sup>4</sup>		
					TW	0 265 004 025 <sup>3</sup>		
35 S 15, 18	04.06-12.11	107/130				0 265 008 429 <sup>4</sup>		
35 S 18	04.06-12.11	107/130				0 265 004 025 <sup>3</sup>		
					TW	0 265 004 025 <sup>4</sup>		
40 C 10, 12	04.06-05.09	71/85				0 265 004 025		
40 C 14	04.07-12.11	100				0 265 004 025 <sup>3</sup>		
					TW	0 265 004 025 <sup>4</sup>		
40 C 15	04.06-12.11	107/130				0 265 008 429 <sup>4</sup>		
					TW	0 265 004 025 <sup>3</sup>		
40 C 15	04.06-12.11	107/130				0 265 004 025 <sup>4</sup>		
40 C 18	04.06-12.11	107/130				0 265 008 429 <sup>4</sup>		
40 C 18	04.06-12.11	107/130				0 265 008 430 <sup>4</sup>		
					TW	0 265 004 025 <sup>3</sup>		
45 C 15, 18	04.06-12.11	107/130				0 265 004 025 <sup>4</sup>		
					TW	0 265 004 025		
50 C 12	04.06-12.11	85				0 265 004 025		
50 C 14	04.07-12.11	100				0 265 004 025 <sup>3</sup>		
					TW	0 265 004 025 <sup>4</sup>		
50 C 15	04.06-12.11	107/130				0 265 008 429 <sup>4</sup>		
					TW	0 265 004 025 <sup>3</sup>		
50 C 15	04.06-12.11	107/130				0 265 004 025 <sup>4</sup>		
50 C 18	04.06-12.11	107/130				0 265 008 429 <sup>4</sup>		
50 C 18	04.06-12.11	107/130				0 265 008 430 <sup>4</sup>		
					TW	0 265 004 025 <sup>3</sup>		
55 S 18	04.06-12.11	130				0 265 004 025 <sup>4</sup>		
60 C 15	04.06-12.11	107				0 265 004 025		
60 C 18	04.06-12.11	130				0 265 004 025		
65 C 14	04.07-12.11	100/107/ 130				0 265 004 025 <sup>3</sup>		
					TW	0 265 004 025 <sup>4</sup>		
65 C 14, 15, 18	04.06-12.11	100/107/ 130				0 265 008 429 <sup>4</sup>		
					TW	0 265 008 429 <sup>4</sup>		
65 C 15	04.06-12.11	100/107/ 130				0 265 008 430 <sup>4</sup>		
					TW	0 265 004 025 <sup>3</sup>		
65 C 18	04.06-12.11	100/107/ 130				0 265 004 025 <sup>4</sup>		
					TW	0 265 004 025 <sup>3</sup>		

## Daily [09]

								
	35 C 11, 13, 14	04.07-12.11	78/93/100/ 103			0 986 134 331		← 44
					TW	0 986 135 331		→ 44
35 S 11	06.09-12.11	78/93/103	Fg.-Nr. →5798349, →D411956			0 986 473 166		← 51,95
35 S 13						0 986 474 166		→ 51,95
35 S 14			Fg.-Nr. 5798350→, D411957→			0 986 473 166		← 51,95
						0 986 474 166		→ 51,95
35 S 17	06.09-12.11	125				0 986 473 166		← 51,95
					TW	0 986 474 166		→ 51,95
35 S 18	11.10-12.11	130	Fg.-Nr. →5798349, →D411956			0 986 473 166		← 51,95
						0 986 474 166		→ 51,95
40 C 11, 13, 14, 17	06.09-12.11	78/93/103/ 125	Fg.-Nr. 5798350→, D411957→			0 986 473 166		← 51,95
						0 986 474 166		→ 51,95
50 C 14	06.09-12.11	103/125				0 986 134 331		← 44
50 C 17						0 986 135 331		→ 44

								
◀ IVECO Daily [09]								
								
	<b>35 C 11</b>	06.09-12.11	78/93/100		TW	0 265 004 025 <sup>3</sup>		
						0 265 004 025 <sup>4</sup>		
	<b>35 C 11, 13, 14</b>	04.07-12.11	78/93/100		TW	0 265 008 429 <sup>4</sup>		
	<b>35 C 13</b>	06.09-12.11	78/93/100		TW	0 265 004 025 <sup>3</sup>		
						0 265 004 025 <sup>4</sup>		
	<b>35 C 14</b>	04.07-12.11	78/93/100		TW	0 265 004 025 <sup>3</sup>		
						0 265 004 025 <sup>4</sup>		
		06.09-12.11	103		TW	0 265 004 025 <sup>3</sup>		
						0 265 004 025 <sup>4</sup>		
	<b>35 C 17</b>	06.09-12.11	125		TW	0 265 004 025 <sup>3</sup>		
						0 265 004 025 <sup>4</sup>		
						0 265 008 429 <sup>4</sup>		
	<b>35 S 11</b>	06.09-12.11	78		TW	0 265 004 025 <sup>3</sup>		
						0 265 004 025 <sup>4</sup>		
						0 265 008 429 <sup>4</sup>		
	<b>35 S 13</b>	06.09-12.11	93			0 265 004 025		
	<b>35 S 14</b>	06.09-12.11	103/125		TW	0 265 004 025 <sup>3</sup>		
						0 265 004 025 <sup>4</sup>		
	<b>35 S 14, 17</b>	06.09-12.11	103/125		TW	0 265 008 429 <sup>4</sup>		
	<b>35 S 17</b>	06.09-12.11	103/125		TW	0 265 004 025 <sup>3</sup>		
						0 265 004 025 <sup>4</sup>		
	<b>35 S 18</b>	11.10-12.11	130			0 265 004 025		
	<b>40 C 11</b>	06.09-12.11	78		TW	0 265 004 025 <sup>3</sup>		
						0 265 004 025 <sup>4</sup>		
						0 265 008 430 <sup>4</sup>		
	<b>40 C 13</b>	06.09-12.11	93/103/ 125		TW	0 265 004 025 <sup>3</sup>		
						0 265 004 025 <sup>4</sup>		
	<b>40 C 13, 14, 17</b>	06.09-12.11	93/103/ 125		TW	0 265 008 429 <sup>4</sup>		
						0 265 008 430 <sup>4</sup>		
	<b>40 C 14</b>	06.09-12.11	93/103/ 125		TW	0 265 004 025 <sup>3</sup>		
						0 265 004 025 <sup>4</sup>		
	<b>40 C 17</b>	06.09-12.11	93/103/ 125		TW	0 265 004 025 <sup>3</sup>		
						0 265 004 025 <sup>4</sup>		
	<b>45 C 14, 15, 17</b>	07.09-12.11	103/107/125			0 265 004 025		
	<b>50 C 14</b>	06.09-12.11	103/125		TW	0 265 004 025 <sup>3</sup>		
						0 265 004 025 <sup>4</sup>		
	<b>50 C 14</b>	06.09-12.11	103/125		TW	0 265 008 429 <sup>4</sup>		
	<b>50 C 17</b>					0 265 008 430 <sup>4</sup>		
	<b>50 C 17</b>	06.09-12.11	103/125		TW	0 265 004 025 <sup>3</sup>		
						0 265 004 025 <sup>4</sup>		
	<b>55 S 17</b>	06.09-12.11	125			0 265 004 025		
	<b>60 C 14</b>	11.10-12.11	103			0 265 004 025		
	<b>65 C 14</b>	06.09-12.11	103		TW	0 265 004 025 <sup>3</sup>		
						0 265 004 025 <sup>4</sup>		
	<b>65 C 17</b>	06.09-12.11	125		TW	0 265 004 025 <sup>3</sup>		
						0 265 004 025 <sup>4</sup>		
						0 265 008 429 <sup>4</sup>		
						0 265 008 430 <sup>4</sup>		
	<b>70 C 14</b>	11.10-12.11	103/107/ 125/130		TW	0 265 004 025 <sup>3</sup>		
						0 265 004 025 <sup>4</sup>		
	<b>70 C 14, 15, 17, 18</b>	06.10-12.11	103/107/ 125/130		TW	0 265 008 429 <sup>4</sup>		
						0 265 008 430 <sup>4</sup>		
	<b>70 C 15</b>	06.10-12.11	103/107/ 125/130		TW	0 265 004 025 <sup>3</sup>		
						0 265 004 025 <sup>4</sup>		
	<b>70 C 17</b>	11.10-12.11	103/107/ 125/130		TW	0 265 004 025 <sup>3</sup>		
						0 265 004 025 <sup>4</sup>		
	<b>70 C 18</b>	06.10-12.11	103/107/ 125/130		TW	0 265 004 025 <sup>3</sup>		
						0 265 004 025 <sup>4</sup>		

		<b>S</b>							
<b>Daily [12]</b>									
									
	<b>29 L</b> 11, 13, 15	07.11-07.14	78/93/146				0 986 <b>473 166</b>	 ← 51,95	
							0 986 <b>474 166</b>	 → 51,95	
	<b>35 S</b> 11, 13, 14 CNG, 15, 17, 21	07.11-07.14	78/93/100/ 107/125/150				0 986 <b>473 166</b>	 ← 51,95	
							0 986 <b>474 166</b>	 → 51,95	
	<b>40 C</b> 11, 13, 14 CNG, 15, 17, 21	01.12-07.14	78/93/100/ 107/125/150				0 986 <b>134 331</b>	 ← 44	
							0 986 <b>135 331</b>	 → 44	
	<b>50 C</b> 14 CNG, 15, 17, 21	07.11-07.14	100/107/ 125/150				0 986 <b>134 331</b>	 ← 44	
							0 986 <b>135 331</b>	 → 44	
									
	<b>29 L</b> 11, 13, 15	07.11-07.14	78/93/146				0 265 <b>008 429</b> <sup>4</sup>		
	<b>35 C</b> 11, 13, 14 CNG, 15, 17, 21	07.11-07.14	78/93/100/107/125/150				0 265 <b>008 429</b> <sup>4</sup>		
	<b>35 S</b> 11, 13, 14 CNG, 15, 17, 21	07.11-07.14	78/93/100/107/125/150				0 265 <b>008 429</b> <sup>4</sup>		
	<b>40 C</b> 11, 13, 14 CNG, 15, 17, 21	01.12-07.14	78/93/100/ 107/125/150		TW		0 265 <b>008 429</b> <sup>4</sup>		
							0 265 <b>008 430</b> <sup>4</sup>		
	<b>50 C</b> 14 CNG, 15, 17, 21	07.11-07.14	100/107/ 125/150		TW		0 265 <b>008 429</b> <sup>4</sup>		
							0 265 <b>008 430</b> <sup>4</sup>		
	<b>65 C</b> 14 CNG, 15, 17, 21	07.11-07.14	100/107/ 125/150		TW		0 265 <b>008 429</b> <sup>4</sup>		
							0 265 <b>008 430</b> <sup>4</sup>		
	<b>70 C</b> 14 CNG, 15, 17, 21	07.11-07.14	100/107/ 125/150		TW		0 265 <b>008 429</b> <sup>4</sup>		
							0 265 <b>008 430</b> <sup>4</sup>		
<b>Daily [14]</b>									
									
	<b>33 S</b> 11, 13, 15	05.14→	78/93/107				0 986 <b>473 166</b>	 ← 51,95	
							0 986 <b>474 166</b>	 → 51,95	
	<b>35 S</b> 11, 13, 14 CNG, 15, 17, 21	05.14→	78/93/100/ 107/125/150				0 986 <b>473 166</b>	 ← 51,95	
							0 986 <b>474 166</b>	 → 51,95	
	<b>40 C</b> 15, 17, 21	05.14→	107/125/ 150				0 986 <b>134 331</b>	 ← 44	
							0 986 <b>135 331</b>	 → 44	
	<b>50 C</b> 14 CNG, 15, 17, 21	05.14→	100/107/ 125/150				0 986 <b>134 331</b>	 ← 44	
							0 986 <b>135 331</b>	 → 44	
									
	<b>33 S</b> 11, 13, 15	05.14→	78/93/107				0 265 <b>008 429</b> <sup>4</sup>		
	<b>35 C</b> 11, 13, 14 CNG, 15, 17, 21	05.14→	78/93/100/107/125/150				0 265 <b>008 429</b> <sup>4</sup>		
	<b>35 S</b> 11, 13, 14 CNG, 15, 17, 21	05.14→	78/93/100/107/125/150				0 265 <b>008 429</b> <sup>4</sup>		
	<b>40 C</b> 15, 17, 21	05.14→	107/125/ 150		TW		0 265 <b>008 429</b> <sup>4</sup>		
							0 265 <b>008 430</b> <sup>4</sup>		
	<b>50 C</b> 14 CNG, 15, 17, 21	05.14→	100/107/ 125/150		TW		0 265 <b>008 429</b> <sup>4</sup>		
							0 265 <b>008 430</b> <sup>4</sup>		
	<b>65 C</b> 14 CNG, 15, 17, 21	05.14→	100/107/125/150				0 265 <b>008 430</b> <sup>4</sup>		
	<b>70 C</b> 14 CNG, 15, 17, 21	05.14→	100/107/125/150				0 265 <b>008 430</b> <sup>4</sup>		
<b>Scudato</b>									
									
	<b>35 .10</b>	08.02-12.03	76				0 986 <b>134 022</b>	 ← 44	
							0 986 <b>135 022</b>	 → 44	
									
	<b>35 .10</b>	08.02-12.03	76				0 986 <b>134 014</b>	 ← 44	
							0 986 <b>135 014</b>	 → 44	



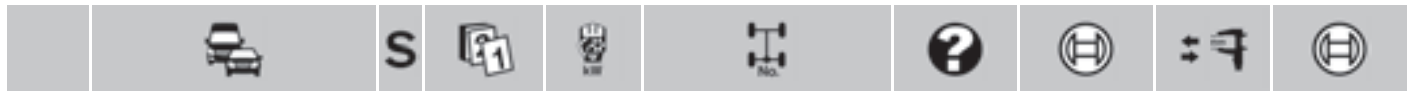

**JAGUAR**

**Daimler**

	4.0 Kompressor 4.0 32V	09.97-08.02	209/267				1 987 470 506 <sup>8</sup>
--	---------------------------	-------------	---------	--	--	--	----------------------------

	4.0 Kompressor 4.0 32V	09.97-08.02	209/267				1 987 470 506 <sup>8</sup>
--	---------------------------	-------------	---------	--	--	--	----------------------------

**XJ 6**

	3.2 24V	10.90-09.94	146-149			0 265 001 096 <sup>4</sup>	
				LAB		0 265 001 095 <sup>3</sup>	
				RAB		0 265 001 094 <sup>3</sup>	

**XJ 12**

	5.3 HE	01.90-09.94	183-207			0 265 001 270 <sup>3</sup>	
				LAB		0 265 001 272 <sup>4</sup>	
				RAB		0 265 001 269 <sup>3</sup>	
						0 265 001 271 <sup>4</sup>	

**X-Type**

	2.0 2.0D	03.02-06.10	96/115			0 204 001 957	← 57	0 204 104 259 <sup>7</sup> 0 204 104 261 <sup>8</sup>
						0 204 001 958	→ 57	0 204 104 259 <sup>7</sup>
	2.2D	09.05-11.09	107-114			0 204 001 957	← 57	0 204 104 259 <sup>7</sup> 0 204 104 261 <sup>8</sup>
						0 204 001 958	→ 57	0 204 104 259 <sup>7</sup>
	2.5	03.01-11.09	144			0 204 001 957	← 57	0 204 104 259 <sup>7</sup> 0 204 104 261 <sup>8</sup>
						0 204 001 958	→ 57	0 204 104 259 <sup>7</sup>
	3.0	03.01-11.09	169-172			0 204 001 957	← 57	0 204 104 259 <sup>7</sup> 0 204 104 261 <sup>8</sup>
						0 204 001 958	→ 57	0 204 104 259 <sup>7</sup>

	2.0 2.0D	03.02-06.10	96/115	Fg.-Nr. →E 24053		0 204 004 660 0 986 473 284	← 38	0 204 104 274 0 204 104 275 <sup>8</sup>
						0 204 004 661 0 986 474 284	→ 38	0 204 104 274
				Fg.-Nr. E 24054→		0 204 205 119	← 38	0 204 104 281 <sup>7</sup>
						0 204 205 120	→ 38	0 204 104 281 <sup>7</sup>
	2.2D	09.05-11.09	107-114	Fg.-Nr. →E 24053		0 204 004 660 0 986 473 284	← 38	0 204 104 274 0 204 104 275 <sup>8</sup>
						0 204 004 661 0 986 474 284	→ 38	0 204 104 274
				Fg.-Nr. E 24054→		0 204 205 119	← 38	0 204 104 281 <sup>7</sup>
						0 204 205 120	→ 38	0 204 104 281 <sup>7</sup>
	2.5	03.01-11.09	144	Fg.-Nr. →E 24053		0 204 004 660 0 986 473 284	← 38	0 204 104 274 0 204 104 275 <sup>8</sup>
						0 204 004 661 0 986 474 284	→ 38	0 204 104 274

























	S							
2.5	03.01-11.09	144	Fg.-Nr. E 24054→			0 204 205 119	← 38	0 204 104 281 <sup>7</sup>
						0 204 205 120	→ 38	0 204 104 281 <sup>7</sup>
3.0	03.01-11.09	169-172	Fg.-Nr. →E 24053			0 204 004 660	← 38	0 204 104 274
						0 986 473 284		0 204 104 275 <sup>8</sup>
						0 204 004 661	→ 38	0 204 104 274
						0 986 474 284		
			Fg.-Nr. E 24054→			0 204 205 119	← 38	0 204 104 281 <sup>7</sup>
						0 204 205 120	→ 38	0 204 104 281 <sup>7</sup>
2.0.D	03.02-06.10	96/115				0 265 007 879		
2.2D	09.05-11.09	107-114				0 265 007 879		
2.5	03.01-11.09	144				0 265 007 879 <sup>3</sup>		
					LAB	0 265 007 417 <sup>4</sup>		
					RAB	0 265 007 404 <sup>4</sup>		
3.0	03.01-11.09	169-172				0 265 007 879 <sup>3</sup>		
					LAB	0 265 007 417 <sup>4</sup>		
					RAB	0 265 007 404 <sup>4</sup>		
<b>X-Type Estate</b>								
2.0	03.03-10.05	96/115				0 204 001 957	← 57	0 204 104 259 <sup>7</sup>
2.0D						0 204 001 958	→ 57	0 204 104 261 <sup>8</sup>
						0 204 001 957	← 57	0 204 104 259 <sup>7</sup>
2.2D	09.05-12.09	107-114				0 204 001 957	← 57	0 204 104 259 <sup>7</sup>
						0 204 001 958	→ 57	0 204 104 261 <sup>8</sup>
2.5	09.03-12.09	144				0 204 001 957	← 57	0 204 104 259 <sup>7</sup>
						0 204 001 958	→ 57	0 204 104 261 <sup>8</sup>
3.0	09.03-12.09	169-172				0 204 001 957	← 57	0 204 104 259 <sup>7</sup>
						0 204 001 958	→ 57	0 204 104 259 <sup>7</sup>
2.0	03.03-10.05	96/115	Fg.-Nr. →E 24053			0 204 004 660	← 38	0 204 104 274
2.0D						0 986 473 284		0 204 104 275 <sup>8</sup>
						0 204 004 661	→ 38	0 204 104 274
						0 986 474 284		
			Fg.-Nr. E 24054→			0 204 205 119	← 38	0 204 104 281 <sup>7</sup>
						0 204 205 120	→ 38	0 204 104 281 <sup>7</sup>
2.2D	09.05-12.09	107-114	Fg.-Nr. →E 24053			0 204 004 660	← 38	0 204 104 274
						0 986 473 284		0 204 104 275 <sup>8</sup>
						0 204 004 661	→ 38	0 204 104 274
						0 986 474 284		
			Fg.-Nr. E 24054→			0 204 205 119	← 38	0 204 104 281 <sup>7</sup>
						0 204 205 120	→ 38	0 204 104 281 <sup>7</sup>
2.5	09.03-12.09	144	Fg.-Nr. →E 24053			0 204 004 660	← 38	0 204 104 274
						0 986 473 284		0 204 104 275 <sup>8</sup>
						0 204 004 661	→ 38	0 204 104 274
						0 986 474 284		
			Fg.-Nr. E 24054→			0 204 205 119	← 38	0 204 104 281 <sup>7</sup>
						0 204 205 120	→ 38	0 204 104 281 <sup>7</sup>
3.0	09.03-12.09	169-172	Fg.-Nr. →E 24053			0 204 004 660	← 38	0 204 104 274
						0 986 473 284		0 204 104 275 <sup>8</sup>
						0 204 004 661	→ 38	0 204 104 274
						0 986 474 284		
			Fg.-Nr. E 24054→			0 204 205 119	← 38	0 204 104 281 <sup>7</sup>
						0 204 205 120	→ 38	0 204 104 281 <sup>7</sup>



		S							
◀ JAGUAR X-Type Estate									
	2.0, D	03.03-10.05	96/115				0 265 007 879		
	2.2 D	09.05-12.09	107-114				0 265 007 879		
	2.5	09.03-12.09	144				0 265 007 879		
	3.0	09.03-12.09	169-172				0 265 007 879 <sup>3</sup>		
						LAB	0 265 007 417 <sup>4</sup>		
						RAB	0 265 007 404 <sup>4</sup>		
<b>JEEP</b>									
<b>Cherokee</b>									
	2.5 i	01.94-07.04	78/85			TW	0 986 475 916	↔ 20,64	
	4.0 i	04.94-06.00	127				0 986 475 916	↔ 20,64	
<b>Cherokee [XJ]</b>									
	2.1 D Turbo	01.87-08.95	65			TW	0 986 475 916	↔ 20,64	
		01.88-08.95	65				0 986 475 872	← 22,2	
							0 986 475 873	→ 22,2	
	2.5 D Turbo	09.90-03.00	85-89/90			09Z,BHQ	0 986 475 916	↔ 20,64	
	2.5 i 4x4	09.90-12.01	85-89/90			10Z,BHO	0 986 475 872	→ 22,2	
							0 986 475 873	← 22,2	
		03.00-12.01	85-89/90			09Z,BHQ	F 026 002 372	↔ 19,5	
	4.0	09.93-03.00	127-131			09Z,BHQ	0 986 475 916	↔ 20,64	
		09.93-08.01	127-131			10Z,BHO	0 986 475 872	→ 22,2	
							0 986 475 873	← 22,2	
		03.00-08.01	127-131			09Z,BHQ	F 026 002 372	↔ 19,5	
		04.00-12.01	135			10Z,BHO	0 986 475 872	→ 22,2	
							0 986 475 873	← 22,2	
	2.5 D Turbo	10.95-12.01	85-89				1 987 482 365	← 894	
	2.5 i 4x4	09.90-09.01	90				1 987 482 365	← 894	
	4.0	09.93-08.01	127-131				1 987 482 365	← 894	
		04.00-12.01	135				1 987 482 365	← 894	
<b>Compass [MK]</b>									
	2.0 CRD, CRD 4x4	10.06→	103				F 026 A09 607	↔	
	2.4, 4x4	10.06→	125				F 026 A09 607	↔	
<b>Compass [PK]</b>									
	2.2 CRD 4x4	01.11→	100/120				F 026 A09 607	↔	
<b>Grand Cherokee</b>									
	4.7 i 4x4	12.03-03.07	175				1 987 482 363	→ 1128	
							1 987 482 364	← 1104	



									
<b>Grand Cherokee [WG]</b>									
									
	2.7 CRD	10.01-12.02	120				1 987 482 363	→ 1128	
							1 987 482 364	← 1104	
	3.1 TD	09.00-12.02	103				1 987 482 363	→ 1128	
							1 987 482 364	← 1104	
	4.0i	09.00-12.02	140-144				1 987 482 363	→ 1128	
							1 987 482 364	← 1104	
	4.7i	09.00-12.02	162-164/				1 987 482 363	→ 1128	
	4.7i Overland		190				1 987 482 364	← 1104	
<b>Patriot [MK]</b>									
									
	2.0 CRD, CRD 4x4	10.06→	103				F 026 A09 607	↔	
	2.2 CRD	09.10→	90/120				F 026 A09 607	↔	
	2.4	10.06→	125				F 026 A09 607	↔	
<b>Wagoneer [SJ]</b>									
									
	2.1 D Turbo	01.88-12.94	64				0 986 475 872	← 22,2	
							0 986 475 873	→ 22,2	
	4.0i	01.90-12.95	125				0 986 475 872	← 22,2	
							0 986 475 873	→ 22,2	
<b>Wrangler [TJ]</b>									
									
	2.4	01.03-12.06	105-110				F 026 002 372	↔ 19,5	
	2.5	09.96-03.00	87-90				0 986 475 916	↔ 20,64	
		04.00-08.02	87-90				F 026 002 372	↔ 19,5	
	4.0	01.97-03.00	131-142				0 986 475 916	↔ 20,64	
		04.00-12.07	131-142				F 026 002 372	↔ 19,5	
		08.03-12.06	130				F 026 002 372	↔ 19,5	
<b>KIA</b>									
<b>Avella</b>									
									
	1.3i	03.94→	54			LAB	0 265 006 296 <sup>3</sup>		
							0 265 006 298 <sup>4</sup>		
						RAB	0 265 006 297 <sup>3</sup>		
<b>Cee'd [ED/FF2]</b>									
									
	1.4	11.06-12.12	66/77/80				0 986 134 295	↔ ← 57	
							0 986 135 295	↔ → 57	
	1.6	11.06-12.12	66/85-93/				0 986 134 295	↔ ← 57	
	1.6 CRDi		94				0 986 135 295	↔ → 57	
	2.0	11.06-12.12	103/105				0 986 134 295	↔ ← 57	
	2.0 CRDi						0 986 135 295	↔ → 57	
									
	1.4	11.06-12.12	66/77/80				0 986 134 249	↔ ←	
							0 986 135 249	↔ →	



		S							
	<b>◀ KIA Cee'd [ED/FF2]</b>								
	1.6	11.06-12.12	66/85-93/				0986 134 249		←
	1.6 CRDi		94				0986 135 249		→
	2.0	11.06-12.12	103/105				0986 134 249		←
	2.0 CRDi						0986 135 249		→
	1.4	07.09-12.12	66/77/80				1987 482 361		← 1673
							1987 482 362		→ 1673
	1.6	07.09-12.12	66/85-93/				1987 482 361		← 1673
	1.6 CRDi		94				1987 482 362		→ 1673
	2.0	07.09-12.12	103/105				1987 482 361		← 1673
	2.0 CRDi						1987 482 362		→ 1673
	<b>Cee'd Sporty Wagon [ED/FF2]</b>								
	1.4	09.07-12.12	66/77/80				0986 134 295		← 57
							0986 135 295		→ 57
	1.6	09.07-12.12	66/85-93/				0986 134 295		← 57
	1.6 CRDi		94				0986 135 295		→ 57
	2.0	09.07-12.12	103/105				0986 134 295		← 57
	2.0 CRDi						0986 135 295		→ 57
	1.4	09.07-12.12	66/77/80				0986 134 249		←
							0986 135 249		→
	1.6	09.07-12.12	66/85-93/				0986 134 249		←
	1.6 CRDi		94				0986 135 249		→
	2.0	09.07-12.12	103/105				0986 134 249		←
	2.0 CRDi						0986 135 249		→
	1.4	07.09-12.12	66/77/80				1987 482 361		← 1673
							1987 482 362		→ 1673
	1.6	07.09-12.12	66/85-93/				1987 482 361		← 1673
	1.6 CRDi		94				1987 482 362		→ 1673
	2.0	07.09-12.12	103/105				1987 482 361		← 1673
	2.0 CRDi						1987 482 362		→ 1673
	<b>Cerato [FE]</b>								
	1.6 i	05.06-11.09	90				0986 475 928		→ 17,46
	1.5 CRDi	10.04-11.04	75				0986 473 083		← 33,9
							0986 474 083		→ 33,9
	1.6 i	10.04-11.04	77				0986 473 083		← 33,9
							0986 474 083		→ 33,9
	2.0 CRDi	03.04-11.04	83/105				0986 473 083		← 33,9
	2.0 i						0986 474 083		→ 33,9
	1.5 CRDi	10.04-11.04	75				1987 482 270		← 1576
							1987 482 360		→ 1560
	1.6 i	10.04-11.04	77				1987 482 270		← 1576
							1987 482 360		→ 1560
	2.0 CRDi	03.04-11.04	83/105				1987 482 270		← 1576
	2.0 i						1987 482 360		→ 1560



























		S							
<b>Cerato Hatchback [FE]</b>									
	1.6	05.06-11.09	90				0 986 475 928	→ 17,46	
	1.5 CRDi	03.04-11.04	75				0 986 473 083	↔ 33,9	
							0 986 474 083	↔ 33,9	
	1.6 i	03.04-11.04	77				0 986 473 083	↔ 33,9	
							0 986 474 083	↔ 33,9	
	2.0 CRDi	03.04-11.04	83/105				0 986 473 083	↔ 33,9	
	2.0 i						0 986 474 083	↔ 33,9	
	1.5 CRDi	03.04-11.04	75				1 987 482 270	← 1576	
							1 987 482 360	→ 1560	
	1.6 i	03.04-11.04	77				1 987 482 270	← 1576	
							1 987 482 360	→ 1560	
	2.0 CRDi	03.04-11.04	83/105				1 987 482 270	← 1576	
	2.0 i						1 987 482 360	→ 1560	
<b>Clarus [GC]</b>									
	1.8 i 16V	06.98-11.01	85-86				0 986 473 405	↔ 33,85	
		ABS 05.96-05.98	85				0 986 474 405	↔ 33,85	
							0 986 473 405	↔ 33,85	
							0 986 474 405	↔ 33,85	
	2.0 i 16V	05.96-05.98	98		SAZ		0 986 473 405	↔ 33,85	
							0 986 474 405	↔ 33,85	
		06.98-11.01	98				0 986 473 405	↔ 33,85	
							0 986 474 405	↔ 33,85	
<b>Clarus Kombi [GC]</b>									
	1.8 i	06.98-11.01	85-86				0 986 473 405	↔ 33,85	
							0 986 474 405	↔ 33,85	
	2.0 i	06.98-11.01	98				0 986 473 405	↔ 33,85	
							0 986 474 405	↔ 33,85	
<b>Forte</b>									
	1.6 i	08.08→	91				0 986 475 928	↔ 17,46	
<b>K 2500</b>									
	TCi	09.01-04.02	69-96				F 026 002 382	→ 19,05	
							F 026 002 383	← 19,05	
<b>K 2900</b>									
	2.9 CRDi	05.07→	92		TW		0 986 AB8 163	↔ 20,64	
							0 986 AB8 164	↔ 20,64	



◀ KIA								
<b>Mentor II [FX]</b>								
	1.6 i	02.01-08.04	74			F 026 <b>A06 516</b>	↔	
	1.8 i	02.01-08.04	82			F 026 <b>A06 516</b>	↔	
<b>Mentor II Hatchback [FX]</b>								
	1.6 i	02.01-08.04	74			F 026 <b>A06 516</b>	↔	
	1.8 i	02.01-08.04	82			F 026 <b>A06 516</b>	↔	
<b>Picanto</b>								
	1.1 i	04.04→	71			F 026 <b>002 388</b>	↔ 15,87	
<b>Picanto [BA]</b>								
	1.0 i	05.04-01.11	45-46			0986 <b>134 340</b>	👁 ← 51	
						0986 <b>135 340</b>	👁 → 51	
	1.1 CRDI	11.05-01.11	55			0986 <b>134 340</b>	👁 ← 51	
						0986 <b>135 340</b>	👁 → 51	
	1.1 i	05.04-01.11	48		TW	0986 <b>134 340</b>	👁 ← 51	
						0986 <b>135 340</b>	👁 → 51	
	1.0 i	05.04-01.11	45-46			F 026 <b>002 388</b>	↔ 15,87	
	1.1 CRDI, i	05.04-01.11	48/55			F 026 <b>002 388</b>	↔ 15,87	
	1.0 i	05.04-01.05	45-46			0986 <b>134 341</b>	👁 ← 34	
						0986 <b>135 341</b>	👁 → 34	
		02.05-01.11	45-46			0986 <b>134 218</b>	👁 ←	
						0986 <b>135 218</b>	👁 →	
	1.1 CRDI	11.05-01.11	55			0986 <b>134 218</b>	👁 ←	
						0986 <b>135 218</b>	👁 →	
	1.1 i	05.04-01.05	48			0986 <b>134 341</b>	👁 ← 34	
						0986 <b>135 341</b>	👁 → 34	
		02.05-01.11	48			0986 <b>134 218</b>	👁 ←	
						0986 <b>135 218</b>	👁 →	
	1.0 i	02.05-01.11	45-46		4SB	1987 <b>482 097</b>	→ 1515	
						1987 <b>482 098</b>	← 1515	
	1.1 CRDI	02.05-01.11	48/55		4SB	1987 <b>482 097</b>	→ 1515	
	1.1 i					1987 <b>482 098</b>	← 1515	
<b>Picanto [TA]</b>								
	1.0	05.11→	51/60			0986 <b>475 990</b>	← 17,46	
	1.0 Bi-Fuel					0986 <b>475 991</b>	→ 17,46	
	1.2	05.11→	63			0986 <b>475 990</b>	← 17,46	
						0986 <b>475 991</b>	→ 17,46	









































		S							
<b>Pregio [TB]</b>									
									
	2.5 Tci	08.01-04.02	69				F 026 <b>002 382</b>	→ 19,05	
							F 026 <b>002 383</b>	← 19,05	
	2.7 D	02.97-04.02	60-61				F 026 <b>002 382</b>	→ 19,05	
							F 026 <b>002 383</b>	← 19,05	
	3.0 D	02.97-12.03	63				0 986 <b>BB3 004</b>	→	
							0 986 <b>BB3 005</b>	←	
<b>Pro Cee'd [ED]</b>									
									
	1.4	10.07-12.12	66/77/80				0 986 <b>134 295</b>	↔ 57	
							0 986 <b>135 295</b>	↔ 57	
	1.6	03.08-12.12	66/85-93/				0 986 <b>134 295</b>	↔ 57	
	1.6 CRDi		94				0 986 <b>135 295</b>	↔ 57	
	2.0	03.08-12.12	103/105				0 986 <b>134 295</b>	↔ 57	
	2.0 CRDi						0 986 <b>135 295</b>	↔ 57	
									
	1.4	10.07-12.12	66/77/80				0 986 <b>134 249</b>	↔	
							0 986 <b>135 249</b>	↔	
	1.6	03.08-12.12	66/85-93/				0 986 <b>134 249</b>	↔	
	1.6 CRDi		94				0 986 <b>135 249</b>	↔	
	2.0	03.08-12.12	103/105				0 986 <b>134 249</b>	↔	
	2.0 CRDi						0 986 <b>135 249</b>	↔	
									
	1.4	07.09-12.12	66/77/80				1 987 <b>482 361</b>	← 1673	
							1 987 <b>482 362</b>	→ 1673	
	1.6	07.09-12.12	66/85-93/				1 987 <b>482 361</b>	← 1673	
	1.6 CRDi		94				1 987 <b>482 362</b>	→ 1673	
	2.0	07.09-12.12	103/105				1 987 <b>482 361</b>	← 1673	
	2.0 CRDi						1 987 <b>482 362</b>	→ 1673	
<b>Rio [DC]</b>									
									
	1.3 i	07.00-02.05	62				0 986 <b>475 946</b>	↔ 17,5	
		09.00-02.05	55				0 986 <b>475 946</b>	↔ 17,5	
	1.5 i	07.00-02.05	72				0 986 <b>475 946</b>	↔ 17,5	
									
	1.3 i	07.00-02.05	55/62				1 987 <b>482 099</b>	← 1584	
	1.5 i	07.00-02.05	72				1 987 <b>482 099</b>	← 1584	
<b>Rio Hatchback [JB, DE]</b>									
									
	1.4, i	03.05-09.11	55/71				0 986 <b>475 946</b>	↔ 17,5	
	1.5 CRDi	03.05-09.11	65/81				0 986 <b>475 946</b>	↔ 17,5	
	1.6 i	03.05-09.11	82				0 986 <b>475 946</b>	↔ 17,5	
									
	1.4 i	03.05-10.07	71		4SB		1 987 <b>482 358</b>	← 1588	
							1 987 <b>482 359</b>	→ 1588	
	1.5 CRDi	03.05-10.07	81		4SB		1 987 <b>482 358</b>	← 1588	
							1 987 <b>482 359</b>	→ 1588	





		S							
	◀ KIA Rio Hatchback [JB, DE]								
	1.6 i	03.05-10.07	82		4SB		1987 <b>482 358</b>	← 1588	
							1987 <b>482 359</b>	→ 1588	
<b>Rio Hatchback [UB]</b>									
	1.1 CRDi	06.11→	55				0986 <b>475 985</b>	↔ 17,5	
	1.2	06.11→	51/62,5				0986 <b>475 985</b>	↔ 17,5	
	1.4, CRDi	06.11→	66/79/80				0986 <b>475 985</b>	↔ 17,5	
	1.6	01.12→	91				0986 <b>475 985</b>	↔ 17,5	
<b>Rio [JB, DE]</b>									
	1.4 i	03.05-09.11	71				0986 <b>475 946</b>	↔ 17,5	
	1.5 CRDi	03.05-09.11	65/81				0986 <b>475 946</b>	↔ 17,5	
	1.6 i	03.05→	82				0986 <b>475 946</b>	↔ 17,5	
	1.4 i	03.05-10.07	71		4SB		1987 <b>482 358</b>	← 1588	
							1987 <b>482 359</b>	→ 1588	
	1.5 CRDi	03.05-10.07	81		4SB		1987 <b>482 358</b>	← 1588	
							1987 <b>482 359</b>	→ 1588	
	1.6 i	03.05-10.07	82		4SB		1987 <b>482 358</b>	← 1588	
							1987 <b>482 359</b>	→ 1588	
<b>Rio Kombi [DC]</b>									
	1.3 i	09.02-02.05	55/60				0986 <b>475 946</b>	↔ 17,5	
	1.5 i	09.02-02.05	71-72				0986 <b>475 946</b>	↔ 17,5	
	1.3 i	09.02-02.05	55/60				1987 <b>482 099</b>	← 1584	
	1.5 i	09.02-02.05	71-72				1987 <b>482 099</b>	← 1584	
<b>Rio [UB]</b>									
	1.2	11.11→	62,5				0986 <b>475 985</b>	↔ 17,5	
	1.4	11.11→	79/80				0986 <b>475 985</b>	↔ 17,5	
	1.6	01.12→	91				0986 <b>475 985</b>	↔ 17,5	
<b>Sephia I [FA]</b>									
	1.5 i 16V	10.97-12.00	74		SBR		1987 <b>482 100</b>	→ 1658	
<b>Shuma II [FB]</b>									
	1.6 i 16V	01.01-08.04	74-74				F 026 <b>A06 516</b>	↔	
	1.8 i 16V	01.01-08.04	82				F 026 <b>A06 516</b>	↔	
<b>Shuma II Hatchback [FB]</b>									
	1.6 i 16V	03.01-08.04	74				F 026 <b>A06 516</b>	↔	
	1.8 i 16V	01.01-08.04	82				F 026 <b>A06 516</b>	↔	































		S							
<b>Sorento [JC]</b>									
									
	2.4i	03.03-04.06	102				0 986 <b>134 031</b>	 ← 46	
							0 986 <b>135 031</b>	 → 46	
	2.5 CRDi	07.02-04.06	103				0 986 <b>134 031</b>	 ← 46	
							0 986 <b>135 031</b>	 → 46	
	3.5i	03.03-08.09	144				0 986 <b>134 031</b>	 ← 46	
							0 986 <b>135 031</b>	 → 46	
									
	2.4i	03.03-04.06	102				0 986 <b>134 023</b>	 ← 43	
							0 986 <b>135 023</b>	 → 43	
	2.5 CRDi	07.02-08.09	103				0 986 <b>134 023</b>	 ← 43	
		03.06-08.09	125				0 986 <b>135 023</b>	 → 43	
							0 986 <b>134 023</b>	 ← 43	
							0 986 <b>135 023</b>	 → 43	
	3.3i	12.06-08.09	177-182				0 986 <b>134 023</b>	 ← 43	
							0 986 <b>135 023</b>	 → 43	
	3.5i	03.03-08.09	144				0 986 <b>134 023</b>	 ← 43	
							0 986 <b>135 023</b>	 → 43	
<b>Spectra [FB]</b>									
									
	1.6i 16V	01.01-12.09	75				F 026 <b>A06 516</b>	↔	
							0 986 <b>475 946</b>	↔ 17,5	
	1.8i 16V	01.01-12.09	93				F 026 <b>A06 516</b>	↔	
<b>Spectra Hatchback</b>									
									
	1.8i 16V	03.01-12.06	93				0 986 <b>475 946</b>	↔ 17,5	
									
	1.5i 16V	ABS 01.01-12.06	65				1 987 <b>482 100</b>	→ 1658	
	1.8i 16V	ABS 01.01-12.06	93				1 987 <b>482 100</b>	→ 1658	
<b>Sportage [JA]</b>									
									
	2.0i	11.98-08.04	95				F 026 <b>002 350</b>	↔ 20,64	
	2.0i 4x4	10.00-08.04	87				F 026 <b>002 350</b>	↔ 20,64	
	2.0i 4x4	07.93-08.04	70/73				F 026 <b>002 349</b>	↔ 20,64	
		04.94-10.98	94				F 026 <b>002 349</b>	↔ 20,64	
	2.0 TD 4x4	11.96-10.98	61				F 026 <b>002 349</b>	↔ 20,64	
		11.98-08.04	61				F 026 <b>002 350</b>	↔ 20,64	
	2.2 4x4	05.93-10.98	46				F 026 <b>002 349</b>	↔ 20,64	
									
	2.0i	11.98-08.04	95		MI		1 987 <b>482 225</b>	335	
	2.0i, i 4x4	10.00-08.04	87		RLE		1 987 <b>482 225</b>	335	
	2.0i 4x4	04.94-10.98	94				1 987 <b>482 225</b>	335	
		11.98-08.04	95		RLE		1 987 <b>482 225</b>	335	
	2.0 TD 4x4	11.96-10.98	61		MI		1 987 <b>482 225</b>	335	



























		S				?			
◀ KIA									
<b>Sportage [JE]</b>									
	2.0 CRDi, CRDi 4x4, i 4x4, 4x4	09.04-12.09	83/100-103/ 104/110		LLE	1987 <b>482 531</b>	← 1836		
						1987 <b>482 532</b>	→ 1888		
	2.7 i 4x4	09.04-12.09	129		LLE	1987 <b>482 531</b>	← 1836		
	2.7 4x4					1987 <b>482 532</b>	→ 1888		
<b>LADA</b>									
<b>Forma</b>									
	1.3	09.91-12.00	45			0986 <b>475 795</b>	↔ 20,6		
	1.5	09.91-12.00	53			0986 <b>475 795</b>	↔ 20,6		
	1.3	09.91-12.00	45			1987 <b>477 843</b>	↔ 1617		
	1.5	09.91-12.00	53			1987 <b>477 843</b>	↔ 1617		
<b>Granta</b>									
	1.6 16V 1.6 8V	01.12→	60/64/72			0986 <b>475 795</b>	↔ 20,6		
<b>Kalina</b>									
	1.4	07.07→	65,5			0986 <b>475 795</b>	↔ 20,6		
	1.6	11.04→	59,5/62/65,5			0986 <b>475 795</b>	↔ 20,6		
	1.4	07.07→	65,5			0265 <b>007 885</b> <sup>3</sup>			
						0265 <b>007 886</b> <sup>4</sup>			
	1.6	11.04→	59,5/62/ 65,5			0265 <b>007 885</b> <sup>3</sup>			
						0265 <b>007 886</b> <sup>4</sup>			
<b>Kalina Hatchback</b>									
	1.4	07.07→	65,5			0986 <b>475 795</b>	↔ 20,6		
	1.6	07.06→	59,5/62			0986 <b>475 795</b>	↔ 20,6		
	1.4	07.07→	65,5			0265 <b>007 885</b> <sup>3</sup>			
						0265 <b>007 886</b> <sup>4</sup>			
	1.6	07.06→	59,5/62			0265 <b>007 885</b> <sup>3</sup>			
						0265 <b>007 886</b> <sup>4</sup>			
<b>Kalina Kombi</b>									
	1.4	07.07→	65,5			0986 <b>475 795</b>	↔ 20,6		
	1.6	07.07→	59,5/62			0986 <b>475 795</b>	↔ 20,6		

K

		S							
									
	1.4	07.07→	65,5				0 265 007 885 <sup>3</sup>		
							0 265 007 886 <sup>4</sup>		
	1.6	07.07→	59,5/62				0 265 007 885 <sup>3</sup>		
							0 265 007 886 <sup>4</sup>		
<b>Niva</b>									
									
	1.6	12.76-12.96	56-58				0 986 475 744	↔ 20,6	
	1.7, i	01.93→	56/59-62				0 986 475 795	↔ 20,6	
	1.9D	01.93-12.99	47-48				0 986 475 795	↔ 20,6	
	1.9TD	07.99→	55				0 986 475 744	↔ 20,6	
									
	1.7, i	01.93-12.99	56/59-62	FKR			1 987 482 010	2122	
	1.9D	01.93-12.99	47-48	FKR			1 987 482 010	2122	
	1.9TD	07.99→	55				1 987 482 010	↔ 2122	
<b>Priora</b>									
									
	1.6 16V 1.6 8V	11.06→	60/66/72				0 986 475 795	↔ 20,6	
									
	1.6 16V	11.06→	72				0 265 007 885 <sup>3</sup>		
							0 265 007 886 <sup>4</sup>		
	1.8	03.08→	88				0 265 007 885 <sup>3</sup>		
							0 265 007 886 <sup>4</sup>		
<b>Priora Hatchback</b>									
									
	1.6 16V 1.6 8V	01.08→	60/66/72				0 986 475 795	↔ 20,6	
									
	1.6 16V	01.08→	72				0 265 007 885 <sup>3</sup>		
							0 265 007 886 <sup>4</sup>		
	1.8	03.08→	88				0 265 007 885 <sup>3</sup>		
							0 265 007 886 <sup>4</sup>		
<b>Priora Kombi</b>									
									
	1.6	01.08→	72				0 986 475 795	↔ 20,6	
									
	1.6	01.08→	72				0 265 007 885 <sup>3</sup>		
							0 265 007 886 <sup>4</sup>		
<b>Samara</b>									
									
	1.1 i 1.3 i 1.5 i	09.91-12.00 02.96→ 01.84→	39 50 50/57/60				0 986 475 795 0 986 475 795 0 986 475 795	↔ 20,6 ↔ 20,6 ↔ 20,6	



		S							
◀ LADA Samara									
	1.1 i	09.91-12.00	39			1987 477 843		↔ 1617	
	1.3 i	02.96→	50			1987 477 843		↔ 1617	
	1.5 i	01.84→	50/57/60			1987 477 843		↔ 1617	
	2.6	07.97→	88-92			1987 477 843		↔ 1617	
<b>Samara Fun</b>									
	1.1	09.88→	39			0986 475 795		↔ 20,6	
	1.3	09.88→	45-48			0986 475 795		↔ 20,6	
	1.5	09.88→	50-53			0986 475 795		↔ 20,6	
	1.1	09.88→	39			1987 477 843		↔ 1617	
	1.3	09.88→	45-48			1987 477 843		↔ 1617	
	1.5	09.88→	50-53			1987 477 843		↔ 1617	
<b>Samara Hatchback</b>									
	1.1	01.84→	39/43			0986 475 795		↔ 20,6	
	1.3, i	01.84→	48			0986 475 795		↔ 20,6	
	1.5, i	01.84→	52/55/57			0986 475 795		↔ 20,6	
	1.1	01.84→	39/43			1987 477 843		↔ 1617	
	1.3	01.84→	48			1987 477 843		↔ 1617	
	1.3 i	01.86→	48			1987 477 843		↔ 1617	
	1.5	01.86→	52/55/57			1987 477 843		↔ 1617	
	1.5 i	01.84→	52/55/57			1987 477 843		↔ 1617	
<b>Serie 110</b>									
	1.5, i, i 8V, i 16V, 16V Premier	01.96-12.04	54/56/56,4/57/58/68/69			0986 475 795		↔ 20,6	
	1.6 i, i 8V, i 16V	01.05→	59/65,5			0986 475 795		↔ 20,6	
	2.0 GTI	01.96-12.00	110			0 265 002 276 <sup>4</sup>			
	2.0 16V					0 265 006 330 <sup>3</sup>			
<b>Serie 111</b>									
	1.5, i, i 8V, i 16V	01.96-12.04	56/57-58/68/69/70			0986 475 795		↔ 20,6	
	1.6 i	01.05→	59			0986 475 795		↔ 20,6	
<b>Serie 112</b>									
	1.5 i, i 8V, i 16V	01.96→	54/56/56,4/58/66/67/69			0986 475 795		↔ 20,6	
	1.6 i	01.05→	59			0986 475 795		↔ 20,6	
<b>Serie 114</b>									
	1.6 i	12.08→	65,5			0986 475 795		↔ 20,6	

		S							
<b>Serie 115</b>									
									
	1.5 i	01.00→	56,4				0 986 475 795	↔ 20,6	
									
	1.3	01.98→	47			TW	1 987 477 843	↔ 1617	
	1.3 i	01.00→	47			TW	1 987 477 843	↔ 1617	
	1.5	01.98→	52/57			TW	1 987 477 843	↔ 1617	
	1.5 i	01.00→	52/57			TW	1 987 477 843	↔ 1617	
<b>Serie 2100</b>									
									
	2106 1.6	04.86→	55				0 986 475 744	↔ 20,6	
	2107-02 1.5	01.86→	52				0 986 475 795	↔ 20,6	
									
	2106 1.6	09.75→	55				1 987 482 009	2503	
	2107-02 1.5	01.86→	52				1 987 482 009	2503	
<b>Serie 2114</b>									
									
	1.5 i	10.01→	56,4-57,2				0 986 475 795	↔ 20,6	
<b>Serie 21000</b>									
									
	21041-30 1.6i	11.07→	54,5				0 986 475 795	↔ 20,6	
	210540 1.6i	12.05→	53,5				0 986 475 795	↔ 20,6	
	21061 1.5	04.86→	48				0 986 475 744	↔ 20,6	
	21063 1.3	04.86→	48				0 986 475 744	↔ 20,6	
	21072 1.3	02.86→	48				0 986 475 795	↔ 20,6	
	21073-40 1.7	01.86→					0 986 475 795	↔ 20,6	
	210740 1.6i	12.05→	53,5				0 986 475 795	↔ 20,6	
	21074 1.6	05.82→	55				0 986 475 795	↔ 20,6	
	21077 1.3	01.86-12.00	48				0 986 475 795	↔ 20,6	
	21099 1.5i	01.90-01.04	56,4				0 986 475 795	↔ 20,6	
									
	21061 1.5	01.82→	48				1 987 482 009	2503	
	21063 1.3	01.86→	48				1 987 482 009	2503	
	21072 1.3	02.86→	48				1 987 482 009	2503	
	21073-40 1.7	01.86→					1 987 482 009	2503	
	21074 1.6	05.82→	55				1 987 482 009	2503	
	21077 1.3	01.86-12.00	48				1 987 482 009	2503	
	21099 1.5i	01.90-01.04	56,4				1 987 477 843	↔ 1617	
<b>Toscana</b>									
									
	1.4	01.86-12.00	55				0 986 475 795	↔ 20,6	
	1.5	01.86-12.00	55				0 986 475 795	↔ 20,6	

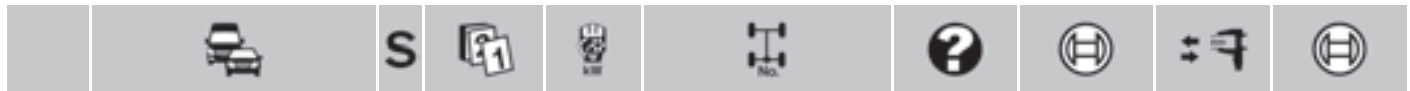

◀ LADA Toscana



	1.4	01.86-12.00	55		1987 <b>482 009</b>	2503
	1.5	01.86-12.00	55		1987 <b>482 009</b>	2503

4x4



	1.7 i	06.07→	59,5		0986 <b>475 795</b>	↔ 20,6
--	-------	--------	------	--	---------------------	--------

























LANCIA

Dedra Berlina [835]



	1.6 i	01.89-10.94	65	BSY	0 204 <b>102 460</b>	← 48	0 204 <b>104 234<sup>7</sup></b>
					0 204 <b>103 460</b>		
					0 204 <b>102 461</b>	→ 48	0 204 <b>104 234<sup>7</sup></b>
					0 204 <b>103 461</b>		
		10.94-04.98	66		0 204 <b>102 530</b>	← 54	0 204 <b>104 237<sup>7</sup></b>
					0 204 <b>103 530</b>		
					0 204 <b>102 531</b>	→ 54	0 204 <b>104 237<sup>7</sup></b>
					0 204 <b>103 531</b>		
		ABS 01.89-10.94	65		0 204 <b>102 524</b>	← 48	0 204 <b>104 234<sup>7</sup></b>
					0 204 <b>103 524</b>		
					0 204 <b>102 525</b>	→ 48	0 204 <b>104 234<sup>7</sup></b>
					0 204 <b>103 525</b>		
		04.93-10.94	55		0 204 <b>102 530</b>	→ 54	0 204 <b>104 234<sup>7</sup></b>
					0 204 <b>103 530</b>		
					0 204 <b>102 531</b>	← 54	0 204 <b>104 234<sup>7</sup></b>
					0 204 <b>103 531</b>		
	1.6 i 16V	04.98-10.99	76		0 204 <b>902 103</b>	← 54	
					0 204 <b>103 502</b>		
					0 204 <b>902 104</b>	→ 54	
					0 204 <b>103 503</b>		
	1.8 i	02.93-10.94	77		0 204 <b>102 530</b>	→ 54	0 204 <b>104 234<sup>7</sup></b>
					0 204 <b>103 530</b>		
					0 204 <b>102 531</b>	← 54	0 204 <b>104 234<sup>7</sup></b>
					0 204 <b>103 531</b>		
		10.94-12.95	74		0 204 <b>102 532</b>	← 54	0 204 <b>104 234<sup>7</sup></b>
					0 204 <b>103 532</b>		
					0 204 <b>102 533</b>	→ 54	0 204 <b>104 234<sup>7</sup></b>
					0 204 <b>103 533</b>		
	1.8 i 16V	01.96-06.96	83	BSY	0 204 <b>902 103</b>	← 54	
					0 204 <b>103 502</b>		
					0 204 <b>902 104</b>	→ 54	
					0 204 <b>103 503</b>		
	1.9 TD	02.93-10.94	66		0 204 <b>102 530</b>	→ 54	0 204 <b>104 234<sup>7</sup></b>
					0 204 <b>103 530</b>		
					0 204 <b>102 531</b>	← 54	0 204 <b>104 234<sup>7</sup></b>
					0 204 <b>103 531</b>		
		10.94-11.97	66		0 204 <b>102 532</b>	← 54	0 204 <b>104 234<sup>7</sup></b>
					0 204 <b>103 532</b>		
					0 204 <b>102 533</b>	→ 54	0 204 <b>104 234<sup>7</sup></b>
					0 204 <b>103 533</b>		
		12.97-10.99	66		0 204 <b>902 103</b>	← 54	
					0 204 <b>103 502</b>		
					0 204 <b>902 104</b>	→ 54	
					0 204 <b>103 503</b>		



								
<b>2.0i</b>			02.93-10.99	83		0 204 <b>102 532</b>	← 54	0 204 <b>104 234</b> <sup>7</sup>
<b>2.0i Automatic</b>						0 204 <b>103 532</b>		
						0 204 <b>102 533</b>	→ 54	0 204 <b>104 234</b> <sup>7</sup>
						0 204 <b>103 533</b>		
								
 <b>1.6i</b>			01.89-10.94	65		F 026 <b>002 458</b>	↔ 19,05	
 <b>1.6i</b>			04.93-10.94	55		0 986 <b>471 009</b>	→ 34	1 987 <b>470 028</b> <sup>7</sup>
						0 986 <b>474 077</b>		
						0 986 <b>471 010</b>	← 34	1 987 <b>470 028</b> <sup>7</sup>
						0 986 <b>473 077</b>		
	ABS		10.94-07.95	66		0 986 <b>471 009</b>	→ 34	
						0 986 <b>474 077</b>		
						0 986 <b>471 010</b>	← 34	
						0 986 <b>473 077</b>		
			07.95-04.98	66		0 986 <b>473 121</b>	← 33,9	
						0 986 <b>474 121</b>	→ 33,9	
<b>1.8i</b>			10.94-07.95	74		0 986 <b>471 009</b>	→ 34	1 987 <b>470 028</b> <sup>7</sup>
						0 986 <b>474 077</b>		
						0 986 <b>471 010</b>	← 34	1 987 <b>470 028</b> <sup>7</sup>
						0 986 <b>473 077</b>		
	ABO		09.89-10.94	77	MIH	0 204 <b>102 473</b>	← 36	
						0 204 <b>102 474</b>	→ 36	
	ABS		01.90-10.94	77				1 987 <b>470 028</b> <sup>7</sup>
<b>1.8i 16V</b>			01.96-10.99	83/97		0 986 <b>473 121</b>	← 33,9	
						0 986 <b>474 121</b>	→ 33,9	
<b>1.9TD</b>			01.89-07.95	66		0 986 <b>471 009</b>	→ 34	1 987 <b>470 028</b> <sup>7</sup>
						0 986 <b>474 077</b>		
						0 986 <b>471 010</b>	← 34	1 987 <b>470 028</b> <sup>7</sup>
						0 986 <b>473 077</b>		
			07.95-10.99	66		0 986 <b>473 121</b>	← 33,9	
						0 986 <b>474 121</b>	→ 33,9	
	ABO		01.89-10.94	66	MIH	0 204 <b>102 473</b>	← 36	
						0 204 <b>102 474</b>	→ 36	
<b>2.0i</b>			ABO 09.89-10.94	83	MIH	0 204 <b>102 473</b>	← 36	
						0 204 <b>102 474</b>	→ 36	
	ABS		01.90-10.94	83				1 987 <b>470 028</b> <sup>7</sup>
<b>2.0i Automatic</b>			10.94-07.95	83		0 986 <b>471 009</b>	→ 34	1 987 <b>470 028</b> <sup>7</sup>
						0 986 <b>474 077</b>		
						0 986 <b>471 010</b>	← 34	1 987 <b>470 028</b> <sup>7</sup>
						0 986 <b>473 077</b>		
<b>2.0i 16V</b>			07.95-10.99	102		0 986 <b>473 121</b>	← 33,9	
						0 986 <b>474 121</b>	→ 33,9	
								
 <b>1.6i</b>			01.89-10.94	65		1 987 <b>477 087</b>	← 1415	
						1 987 <b>477 088</b>	→ 1375	
			04.93-10.94	55		1 987 <b>477 375</b>	→ 1460	
						1 987 <b>477 382</b>	← 1517	
	ABS		01.89-10.94	65		1 987 <b>477 375</b>	→ 1460	
						1 987 <b>477 376</b>	← 1495	
<b>1.8i</b>			09.89-10.94	77		1 987 <b>477 375</b>	→ 1460	
						1 987 <b>477 376</b>	← 1495	
<b>1.9TD</b>			10.94-10.99	66		1 987 <b>477 375</b>	→ 1460	
						1 987 <b>477 382</b>	← 1517	
<b>2.0i</b>			09.89-10.94	83		1 987 <b>477 375</b>	→ 1460	
						1 987 <b>477 376</b>	← 1495	
<b>2.0i 16V</b>			04.95-10.99	102		1 987 <b>477 375</b>	→ 1460	
						1 987 <b>477 382</b>	← 1517	



































◀ LANCIA Dedra Berlina [835]

	<b>1.6 i</b>	03.93-10.94	65		0 265 <b>001 215</b> <sup>3</sup>	
				LAB	0 265 <b>001 216</b> <sup>4</sup>	
				RAB	0 265 <b>001 217</b> <sup>4</sup>	
		04.93-10.94	55		0 265 <b>001 216</b> <sup>4</sup>	
				RAB	0 265 <b>001 217</b> <sup>4</sup>	
		10.94-08.95	66		0 265 <b>001 215</b> <sup>3</sup>	
				LAB	0 265 <b>001 216</b> <sup>4</sup>	
				RAB	0 265 <b>001 217</b> <sup>4</sup>	
		09.95-04.98	66		0 265 <b>006 197</b> <sup>4</sup>	
					0 265 <b>006 212</b> <sup>3</sup>	
	<b>1.6 i 16V</b>	04.98-10.99	76		0 265 <b>006 197</b> <sup>4</sup>	
					0 265 <b>006 212</b> <sup>3</sup>	
	<b>1.8 i</b>	03.93-10.94	77		0 265 <b>001 215</b> <sup>3</sup>	
				LAB	0 265 <b>001 216</b> <sup>4</sup>	
				RAB	0 265 <b>001 217</b> <sup>4</sup>	
		10.94-08.95	74		0 265 <b>001 215</b> <sup>3</sup>	
				LAB	0 265 <b>001 216</b> <sup>4</sup>	
				RAB	0 265 <b>001 217</b> <sup>4</sup>	
		09.95-12.95	74		0 265 <b>006 197</b> <sup>4</sup>	
					0 265 <b>006 212</b> <sup>3</sup>	
	<b>1.8 i 16V</b>	01.96-10.99	83/97		0 265 <b>006 197</b> <sup>4</sup>	
					0 265 <b>006 212</b> <sup>3</sup>	
	<b>1.9 TD</b>	01.89-10.94	66		0 265 <b>001 215</b> <sup>3</sup>	
				LAB	0 265 <b>001 216</b> <sup>4</sup>	
				RAB	0 265 <b>001 217</b> <sup>4</sup>	
		10.94-10.99	66		0 265 <b>006 197</b> <sup>4</sup>	
		09.95-10.99	66		0 265 <b>006 212</b> <sup>3</sup>	
	<b>2.0 i</b>	11.90-10.94	102/119		0 265 <b>006 197</b> <sup>4</sup>	
			119		0 265 <b>006 212</b> <sup>3</sup>	
	<b>2.0 i</b>	09.89-08.95	83		0 265 <b>001 215</b> <sup>3</sup>	
	<b>2.0 i Automatic</b>			LAB	0 265 <b>001 216</b> <sup>4</sup>	
				RAB	0 265 <b>001 217</b> <sup>4</sup>	
	<b>2.0 i 4x4 Integrale</b>	04.91-10.94	121		0 265 <b>001 215</b> <sup>3</sup>	
					0 265 <b>001 304</b> <sup>4</sup>	
	<b>2.0 i 16V</b>	10.94-10.99	102/119		0 265 <b>006 197</b> <sup>4</sup>	
		09.95-10.99	102/119		0 265 <b>006 212</b> <sup>3</sup>	















**Dedra Station Wagon [835]**

	<b>1.6 i 16V</b>	04.98-10.99	76		0 204 <b>902 103</b>	← 54
					0 204 <b>103 502</b>	↻
					0 204 <b>902 104</b>	→ 54
					0 204 <b>103 503</b>	↻
	<b>1.8 i</b>	10.94-12.95	74		0 204 <b>102 532</b>	← 54
					0 204 <b>103 532</b>	↻
					0 204 <b>102 533</b>	→ 54
					0 204 <b>103 533</b>	↻
	<b>1.8 i 16V</b>	01.96-06.96	83	BSY	0 204 <b>902 103</b>	← 54
					0 204 <b>103 502</b>	↻
					0 204 <b>902 104</b>	→ 54
					0 204 <b>103 503</b>	↻
	<b>1.9 TD</b>	10.94-10.99	66		0 204 <b>102 530</b>	→ 54
					0 204 <b>103 530</b>	↻
					0 204 <b>102 531</b>	← 54
					0 204 <b>103 531</b>	↻
	<b>2.0 i 16V 4x4</b>	10.94-10.99	102		0 204 <b>102 506</b>	← 54
					0 204 <b>103 506</b>	↻
					0 986 <b>134 005</b>	↻
					0 204 <b>102 507</b>	→ 54
					0 204 <b>103 507</b>	↻































		S							
									
	1.6i	ABS	10.94-07.95	66			0 986 471 009	→ 34	
							0 986 474 077		
							0 986 471 010	← 34	
							0 986 473 077		
			07.95-04.98	66			0 986 473 121	 ← 33,9	
							0 986 474 121	 → 33,9	
	1.8i		10.94-07.95	74			0 986 471 009	→ 34	1 987 470 028 <sup>7</sup>
							0 986 474 077		
							0 986 471 010	← 34	1 987 470 028 <sup>7</sup>
							0 986 473 077		
	1.8i 16V		01.96-10.99	83/97			0 986 473 121	 ← 33,9	
							0 986 474 121	 → 33,9	
	1.9TD		10.94-07.95	66			0 986 471 009	→ 34	1 987 470 028 <sup>7</sup>
							0 986 474 077		
							0 986 471 010	← 34	1 987 470 028 <sup>7</sup>
							0 986 473 077		
			07.95-10.99	66			0 986 473 121	 ← 33,9	
							0 986 474 121	 → 33,9	
	2.0i 16V		07.95-10.99	102			0 986 473 121	 ← 33,9	
	2.0i 16V 4x4						0 986 474 121	 → 33,9	
									
	1.6i 16V		04.98-10.99	76			1 987 477 375	→ 1460	
							1 987 477 382	← 1517	
	1.8i 16V		01.96-10.99	83/97			1 987 477 375	→ 1460	
							1 987 477 382	← 1517	
	1.9TD		10.94-10.99	66			1 987 477 375	→ 1460	
							1 987 477 382	← 1517	
	2.0i 16V		04.95-10.99	102			1 987 477 375	→ 1460	
	2.0i 16V 4x4						1 987 477 382	← 1517	
									
	1.6i		10.94-08.95	66			0 265 001 215 <sup>3</sup>		
						LAB	0 265 001 216 <sup>4</sup>		
						RAB	0 265 001 217 <sup>4</sup>		
			09.95-04.98	66			0 265 006 197 <sup>4</sup>		
							0 265 006 212 <sup>3</sup>		
	1.6i 16V		04.98-10.99	76			0 265 006 197 <sup>4</sup>		
							0 265 006 212 <sup>3</sup>		
	1.8i		10.94-08.95	74			0 265 001 215 <sup>3</sup>		
						LAB	0 265 001 216 <sup>4</sup>		
						RAB	0 265 001 217 <sup>4</sup>		
			09.95-12.95	74			0 265 006 197 <sup>4</sup>		
							0 265 006 212 <sup>3</sup>		
	1.8i 16V		01.96-10.99	83/97			0 265 006 197 <sup>4</sup>		
							0 265 006 212 <sup>3</sup>		
	1.9TD		10.94-10.99	66			0 265 006 197 <sup>4</sup>		
			09.95-10.99	66			0 265 006 212 <sup>3</sup>		
	2.0i 16V		10.94-10.99	102			0 265 006 197 <sup>4</sup>		
	2.0i 16V 4x4		09.95-10.99	102			0 265 006 212 <sup>3</sup>		
<b>Delta [831]</b>									
									
	2.0i Turbo 8V Int. 4x4		03.89-01.94	126/158		LAB	0 265 001 246 <sup>3</sup>		
	2.0i Turbo 16V Int. 4x4						0 265 001 248 <sup>4</sup>		
						RAB	0 265 001 247 <sup>3</sup>		
							0 265 001 249 <sup>4</sup>		



		S							
◀ LANCIA									
<b>Delta [836]</b>									
	1.4 i	06.93-12.94	51						0 204 104 237 <sup>7</sup>
		01.95-12.99	51			0 204 102 530	← 54		0 204 104 237 <sup>7</sup>
						0 204 103 530			
						0 204 102 531	→ 54		0 204 104 237 <sup>7</sup>
						0 204 103 531			
	1.6 i	06.93-12.99	55			0 204 102 530	← 54		0 204 104 237 <sup>7</sup>
						0 204 103 530			
						0 204 102 531	→ 54		0 204 104 237 <sup>7</sup>
						0 204 103 531			
	1.6 i 16V HPE	01.96-12.99	66/76			0 204 902 101	←		
						0 204 103 499			
						0 986 134 317			
						0 204 902 102	→		
						0 204 103 500			
						0 986 135 317			
	1.8 i	06.93-12.99	66/74/76			0 204 102 530	← 54		0 204 104 237 <sup>7</sup>
						0 204 103 530			
						0 204 102 531	→ 54		0 204 104 237 <sup>7</sup>
						0 204 103 531			
	1.8 i GT 16V	01.96-12.99	97			0 204 102 506	← 54		
						0 204 103 506			
						0 986 134 005			
						0 204 102 507	→ 54		
						0 204 103 507			
	1.8 i 16V	01.96-12.99	83			0 204 902 103	← 54		
						0 204 103 502			
						0 204 902 104	→ 54		
						0 204 103 503			
	1.9 TD	07.94-10.95	66			0 204 102 530	← 54		0 204 104 237 <sup>7</sup>
						0 204 103 530			
						0 204 102 531	→ 54		0 204 104 237 <sup>7</sup>
						0 204 103 531			
		10.95-10.96	66			0 204 902 101	←		
						0 204 103 499			
						0 986 134 317			
						0 204 902 102	→		
						0 204 103 500			
						0 986 135 317			
		11.96-12.99	66			0 204 902 103	← 54		
						0 204 103 502			
						0 204 902 104	→ 54		
						0 204 103 503			
	2.0 i 16V	06.95-12.99	102/137			0 204 102 506	← 54		
	2.0 i 16V Turbo HPE					0 204 103 506			
						0 986 134 005			
						0 204 102 507	→ 54		
						0 204 103 507			
	1.6 i 16V HPE	01.96-12.99	66/76			F 026 002 434	↔ 22		
	1.9 TD	07.94-12.99	66			F 026 002 434	↔ 22		
	1.8 i	06.93-12.99	66/74/76			0 986 471 009	→ 34		
						0 986 474 077			
						0 986 471 010	← 34		
						0 986 473 077			

		S							
1.9 TD		07.94-12.99	66				0 986 471 009 0 986 474 077 0 986 471 010 0 986 473 077	→ 34 ↻ ← 34 ↻	
									
	1.4 i	06.93-12.95	51				1 987 477 087 1 987 477 088	→ 1415 ← 1375	
	1.6 i	06.93-12.95	55				1 987 477 087 1 987 477 088	→ 1415 ← 1375	
	1.6 i 16V HPE	ABS 01.96-12.99	66/76				1 987 477 375 1 987 477 382	→ 1460 ← 1517	
	1.8 i, iGT 16V, i 16V	06.93-12.99	66/74/76/ 83/97				1 987 477 375 1 987 477 382	→ 1460 ← 1517	
	1.9 TD	07.94-10.95	66				1 987 477 375 1 987 477 382	→ 1460 ← 1517	
	2.0 i 16V	06.93-12.99	102/137				1 987 477 375	→ 1460	
	2.0 i 16V Turbo HPE						1 987 477 382	← 1517	
	1.4 i	06.93-08.95 06.93-12.99 09.95-12.99	51 51 51				0 265 006 212 <sup>3</sup> 0 265 006 197 <sup>4</sup> 0 265 006 162 <sup>3</sup>		
	1.6 i	06.93-08.95 06.93-12.99 09.95-12.99	55 55 55				0 265 006 212 <sup>3</sup> 0 265 006 197 <sup>4</sup> 0 265 006 162 <sup>3</sup>		
	1.6 i 16V HPE	01.96-12.99	66/76				0 265 006 197 <sup>4</sup> 0 265 006 212 <sup>3</sup>		
	1.8 i	06.93-08.95 06.93-12.99 09.95-12.99	66/74/76 66/74/76 66/74/76				0 265 006 212 <sup>3</sup> 0 265 006 197 <sup>4</sup> 0 265 006 162 <sup>3</sup>		
	1.8 i GT 16V	01.96-12.99	83/97				0 265 006 197 <sup>4</sup>		
	1.8 i 16V						0 265 006 212 <sup>3</sup>		
	1.9 TD	07.94-08.95 07.94-12.99 09.95-12.99	66 66 66				0 265 006 212 <sup>3</sup> 0 265 006 197 <sup>4</sup> 0 265 006 162 <sup>3</sup>		
	2.0 i 16V	06.93-08.95	102/137				0 265 006 212 <sup>3</sup>		
	2.0 i 16V Turbo HPE	06.93-12.99 09.95-12.99	102/137 102/137				0 265 006 197 <sup>4</sup> 0 265 006 162 <sup>3</sup>		
<b>Delta [844]</b>									
									
	1.4 i BiFuel, i 16V	07.08→	88/103/110				1 987 482 239	→ 408	
	1.6 Multijet	07.08→	77/85/88				1 987 482 239	→ 408	
	1.9 Multijet	08.08→	140				1 987 482 239	→ 408	
	2.0 Multijet	08.08→	120/121				1 987 482 239	→ 408	
	1.4 i BiFuel	12.09→	88		FPA		0 265 008 288 <sup>4</sup>		
	1.4 i BiFuel	07.08→	88				0 265 008 002 <sup>3</sup>		
	1.4 i 16V						0 265 008 003 <sup>4</sup>		
	1.4 i 16V	07.08-07.10	110				0 265 008 002 <sup>3</sup> 0 265 008 003 <sup>4</sup>		
		08.10→	103				0 265 008 002 <sup>3</sup>		
					FPA		0 265 008 288 <sup>4</sup>		
					FPA		0 265 008 003 <sup>4</sup>		
	1.6 Multijet	07.08→	77/85/88				0 265 008 002 <sup>3</sup>		
					FPA		0 265 008 288 <sup>4</sup>		
					FPA		0 265 008 003 <sup>4</sup>		
	1.8 Tbi	05.09-12.14	147				0 265 008 002 <sup>3</sup>		
					FPA		0 265 008 288 <sup>4</sup>		
					FPA		0 265 008 003 <sup>4</sup>		

		S							
	<b>LANCIA Delta [844]</b>								
	1.9 Multijet	08.08→	140				0 265 008 002 <sup>3</sup>		
						FPA	0 265 008 288 <sup>4</sup>		
						FPA	0 265 008 003 <sup>4</sup>		
	2.0 Multijet	08.08→	120/121				0 265 008 002 <sup>3</sup>		
						FPA	0 265 008 288 <sup>4</sup>		
						FPA	0 265 008 003 <sup>4</sup>		
	<b>Kappa Berlina [838]</b>								
	2.0 i 20V	06.98-12.00	114				0 204 102 871	← 57	
							0 986 473 496		
							0 204 102 872	→ 57	
							0 986 474 496		
	2.4 i 20V	03.98-12.00	100/129				0 204 102 871	← 57	
	2.4 JTD						0 986 473 496		
							0 204 102 872	→ 57	
							0 986 474 496		
	2.0 i Turbo 20V	06.98-12.00	162				0 986 473 156	→ 38	
	2.4 i 20V, JTD	03.98-12.00	100/129				0 986 473 156	→ 38	
	3.0 i 24V	06.98-12.00	150				0 986 473 156	↔ 38	
							0 986 474 156	→ 38	
	2.0 i Turbo 16V, i Turbo 20V, i 20V	11.94-12.00	110/114/ 151/162				1 987 477 657	→ 1345	
							1 987 477 726	← 1298	
	2.4 i 20V	11.94-12.00	100/129				1 987 477 657	→ 1345	
	2.4 JTD						1 987 477 726	← 1298	
	2.4 TD	11.94-06.96	91				1 987 477 657	← 1345	
							1 987 477 726	→ 1298	
		06.96-03.98	91				1 987 477 657	→ 1345	
							1 987 477 726	← 1298	
	3.0 i 24V	11.94-06.98	150				1 987 477 657	← 1345	
							1 987 477 726	→ 1298	
		06.98-12.00	150				1 987 477 657	→ 1345	
							1 987 477 726	← 1298	
		2.0 i Turbo 16V	11.94-06.98	151			0 265 006 160 <sup>3</sup>		
						Fg.-Nr. 2059704→	0 265 007 040 <sup>4</sup>		
						Ricam.Nr →2059703	0 265 006 300 <sup>4</sup>		
	2.0 i Turbo 20V	06.98-12.00	162				0 265 006 160 <sup>3</sup>		
							0 265 007 040 <sup>4</sup>		
	2.0 i 20V	11.94-06.96	110				0 265 006 160 <sup>3</sup>		
						Fg.-Nr. 2059704→	0 265 007 040 <sup>4</sup>		
						Ricam.Nr →2059703	0 265 006 300 <sup>4</sup>		
		06.96-06.98	114				0 265 006 160 <sup>3</sup>		
		06.96-12.00	114				0 265 007 040 <sup>4</sup>		
		06.98-12.00	114			LAB	0 265 007 041 <sup>3</sup>		
						RAB	0 265 007 042 <sup>3</sup>		
	2.4 i 20V	11.94-06.98	129				0 265 006 160 <sup>3</sup>		
						Fg.-Nr. 2059704→	0 265 007 040 <sup>4</sup>		
						Ricam.Nr →2059703	0 265 006 300 <sup>4</sup>		
		06.98-12.00	129				0 265 007 040 <sup>4</sup>		
						LAB	0 265 007 041 <sup>3</sup>		
						RAB	0 265 007 042 <sup>3</sup>		
	2.4 JTD	03.98-12.00	100				0 265 007 040 <sup>4</sup>		
						LAB	0 265 007 041 <sup>3</sup>		
						RAB	0 265 007 042 <sup>3</sup>		

		S							
2.4 TD		11.94-03.98	91				0 265 006 160 <sup>3</sup>		
						Fg.-Nr. 2059704→	0 265 007 040 <sup>4</sup>		
						Ricam.Nr →2059703	0 265 006 300 <sup>4</sup>		
3.0i 24V		11.94-12.00	150				0 265 006 160 <sup>3</sup>		
						Fg.-Nr. →2059704	0 265 006 300 <sup>4</sup>		
						Fg.-Nr. 2059704→	0 265 007 040 <sup>4</sup>		
		06.98-12.00	150			LAB	0 265 007 041 <sup>3</sup>		
						RAB	0 265 007 042 <sup>3</sup>		
<b>Kappa Coupé [838]</b>									
									
	2.4i 20V	04.99-06.00	129				0 204 102 871	← 57	
							0 986 473 496		
							0 204 102 872	→ 57	
							0 986 474 496		
									
	2.0i Turbo 20V	06.98-06.00	162				0 986 473 156	 → 38	
	2.4i 20V	05.97-06.00	129				0 986 473 156	 → 38	
	3.0i 24V V6	06.98-06.00	150				0 986 473 156	 → 38	
									
	2.0i Turbo 20V	06.98-06.00	162				1 987 477 657	→ 1345	
							1 987 477 726	← 1298	
	2.4i 20V	04.97-06.98	129				1 987 477 657	→ 1345	
							1 987 477 726	← 1298	
	2.0i Turbo 16V	04.97-06.98	151				0 265 006 160 <sup>3</sup>		
							0 265 006 300 <sup>4</sup>		
	2.0i Turbo 20V	06.98-06.00	162				0 265 007 040 <sup>4</sup>		
						LAB	0 265 007 041 <sup>3</sup>		
						RAB	0 265 007 042 <sup>3</sup>		
	2.4i 20V	04.97-06.98	129				0 265 006 160 <sup>3</sup>		
		04.97-06.00	129				0 265 007 040 <sup>4</sup>		
		06.98-06.00	129			LAB	0 265 007 041 <sup>3</sup>		
						RAB	0 265 007 042 <sup>3</sup>		
	3.0i 24V V6	04.97-06.98	150				0 265 006 160 <sup>3</sup>		
							0 265 006 300 <sup>4</sup>		
		06.98-06.00	150			LAB	0 265 007 041 <sup>3</sup>		
						RAB	0 265 007 042 <sup>3</sup>		
		07.98-06.00	150				0 265 007 040 <sup>4</sup>		
<b>Kappa Station Wagon [838]</b>									
									
	2.0i 20V	06.98-12.00	114				0 204 102 871	← 57	
							0 986 473 496		
							0 204 102 872	→ 57	
							0 986 474 496		
	2.4i 20V	03.98-12.00	100/129				0 204 102 871	← 57	
	2.4JTD						0 986 473 496		
							0 204 102 872	→ 57	
							0 986 474 496		
									
	2.0i Turbo 20V	06.98-12.00	162				0 986 473 156	 → 38	
	2.4i 20V, JTD	03.98-12.00	100/129				0 986 473 156	 → 38	
	3.0i 24V	06.98-12.00	150				0 986 473 156	 → 38	

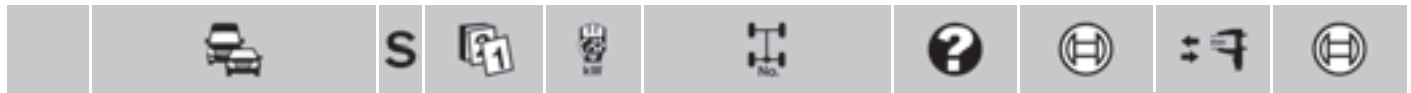

◀ LANCIA Kappa Station Wagon [838]

























	2.0 i Turbo 16V, i Turbo 20V, i 20V	11.94-12.00	114/151/ 162		1 987 477 657	→ 1345
					1 987 477 726	← 1298
	2.4 D Turbo, i 20V, JTD	11.94-12.00	91/100/ 129		1 987 477 657	→ 1345
					1 987 477 726	← 1298
	3.0 i 24V	11.94-12.00	150		1 987 477 657	→ 1345
					1 987 477 726	← 1298
	2.0 i Turbo 16V	11.94-06.98	151		0 265 006 160 <sup>3</sup>	
				Fg.-Nr. 2059704→	0 265 007 040 <sup>4</sup>	
				Ricam.Nr →2059703	0 265 006 300 <sup>4</sup>	
	2.0 i Turbo 20V	06.98-12.00	162		0 265 006 160 <sup>3</sup>	
					0 265 007 040 <sup>4</sup>	
	2.0 i 20V	06.96-06.98	114		0 265 006 160 <sup>3</sup>	
				Fg.-Nr. 2059704→	0 265 007 040 <sup>4</sup>	
				Ricam.Nr →2059703	0 265 006 300 <sup>4</sup>	
		06.98-12.00	114		0 265 007 040 <sup>4</sup>	
				LAB	0 265 007 041 <sup>3</sup>	
				RAB	0 265 007 042 <sup>3</sup>	
	2.4 D Turbo	06.96-03.98	91		0 265 006 160 <sup>3</sup>	
				Fg.-Nr. 2059704→	0 265 007 040 <sup>4</sup>	
				Ricam.Nr →2059703	0 265 006 300 <sup>4</sup>	
	2.4 i 20V	11.94-06.98	129		0 265 006 160 <sup>3</sup>	
			Fg.-Nr. 2059704→	0 265 007 040 <sup>4</sup>		
			Ricam.Nr →2059703	0 265 006 300 <sup>4</sup>		
	06.98-12.00	129		0 265 007 040 <sup>4</sup>		
			LAB	0 265 007 041 <sup>3</sup>		
			RAB	0 265 007 042 <sup>3</sup>		
2.4 JTD	03.98-12.00	100		0 265 007 040 <sup>4</sup>		
			LAB	0 265 007 041 <sup>3</sup>		
			RAB	0 265 007 042 <sup>3</sup>		
3.0 i 24V	11.94-06.98	150		0 265 006 160 <sup>3</sup>		
	11.94-12.00	150	Fg.-Nr. →2059704	0 265 006 300 <sup>4</sup>		
			Fg.-Nr. 2059704→	0 265 007 040 <sup>4</sup>		
	06.98-12.00	150		0 265 007 041 <sup>3</sup>		
			LAB	0 265 007 041 <sup>3</sup>		
			RAB	0 265 007 042 <sup>3</sup>		

Lybra Berlina [839]





























	1.6 i 16V	10.99-09.05	76		0 204 102 506	← 54
					0 204 102 507	→ 54
					0 204 103 507	
	1.8 i 16V	10.99-09.05	96		0 204 102 506	← 54
					0 204 103 506	
					0 986 134 005	
					0 204 102 507	→ 54
					0 204 103 507	
1.9 JTD	10.99-11.06	77/80/85			0 204 102 506	← 54
					0 204 103 506	
					0 986 134 005	
					0 204 102 507	→ 54
					0 204 103 507	
2.0 i 20V	10.99-09.05	110/113			0 204 102 506	← 54
					0 204 103 506	
					0 986 134 005	
					0 204 102 507	→ 54
					0 204 103 507	
2.4 i 20V	10.99-05.02	129			0 204 001 969	← 57
					0 204 001 970	→ 57

		S							
2.4 JTD		10.99-09.05	98/103/110				0 204 102 506 0 204 103 506 0 986 134 005 0 204 102 507 0 204 103 507	← 54   → 54 	
									
	1.6i 16V	10.99-09.05	76				0 986 473 251 0 986 474 251	 ← 38  → 38	
	1.8i 16V	10.99-09.05	96				0 986 473 251 0 986 474 251	← 38  → 38	
	1.9 JTD	10.99-11.06	77/80/85				0 986 473 251 0 986 474 251	 ← 38  → 38	
	2.0i 20V	10.99-09.05	110/113				0 986 473 251 0 986 474 251	← 38  → 38	
	2.4i 20V	10.99-09.05	98/103/110/129				0 986 473 251 0 986 474 251	← 38  → 38	
									
	1.6i 16V	10.99-09.05	76				1 987 477 555 1 987 477 556	→ 1222 ← 1266	
	1.8i 16V	10.99-09.05	96				1 987 477 555 1 987 477 556	→ 1222 ← 1266	
	1.9 JTD	10.99-11.06	77/80/85				1 987 477 555 1 987 477 556	→ 1222 ← 1266	
	2.0i 20V	10.99-09.05	110/113				1 987 477 555 1 987 477 556	→ 1222 ← 1266	
	2.4i 20V	10.99-09.05	98/103/110/129				1 987 477 555 1 987 477 556	→ 1222 ← 1266	
	1.6i 16V	10.99-08.02	76			LAB	0 265 007 073 <sup>3</sup> 0 265 007 076 <sup>4</sup>		
						RAB	0 265 007 074 <sup>3</sup> 0 265 007 075 <sup>4</sup>		
		09.02-09.05	76			LAB	0 265 007 564 <sup>3</sup> 0 265 007 567 <sup>4</sup>		
						RAB	0 265 007 565 <sup>3</sup> 0 265 007 566 <sup>4</sup>		
	1.8i 16V	10.99-08.02	96			LAB	0 265 007 073 <sup>3</sup> 0 265 007 076 <sup>4</sup>		
						RAB	0 265 007 074 <sup>3</sup> 0 265 007 075 <sup>4</sup>		
		09.02-09.05	96			LAB	0 265 007 564 <sup>3</sup> 0 265 007 567 <sup>4</sup>		
						RAB	0 265 007 565 <sup>3</sup> 0 265 007 566 <sup>4</sup>		
	1.9 JTD	10.99-06.01	77/80			LAB	0 265 007 073 <sup>3</sup> 0 265 007 076 <sup>4</sup>		
						RAB	0 265 007 074 <sup>3</sup> 0 265 007 075 <sup>4</sup>		
		06.01-08.02	85			LAB	0 265 007 073 <sup>3</sup> 0 265 007 076 <sup>4</sup>		
						RAB	0 265 007 074 <sup>3</sup> 0 265 007 075 <sup>4</sup>		
		09.02-11.06	85			LAB	0 265 007 564 <sup>3</sup> 0 265 007 567 <sup>4</sup>		
						RAB	0 265 007 565 <sup>3</sup> 0 265 007 566 <sup>4</sup>		





























		S							
<b>LANCIA Lybra Berlina [839]</b>									
	2.0 i20V	10.99-09.00	113	LAB	0 265 007 073 <sup>3</sup>				
					0 265 007 076 <sup>4</sup>				
				RAB	0 265 007 074 <sup>3</sup>				
					0 265 007 075 <sup>4</sup>				
		10.00-08.02	110	LAB	0 265 007 073 <sup>3</sup>				
					0 265 007 076 <sup>4</sup>				
				RAB	0 265 007 074 <sup>3</sup>				
					0 265 007 075 <sup>4</sup>				
		09.02-09.05	110	LAB	0 265 007 564 <sup>3</sup>				
					0 265 007 567 <sup>4</sup>				
				RAB	0 265 007 565 <sup>3</sup>				
					0 265 007 566 <sup>4</sup>				
	2.4 i20V	10.99-05.02	129	LAB	0 265 007 073 <sup>3</sup>				
					0 265 007 076 <sup>4</sup>				
				RAB	0 265 007 074 <sup>3</sup>				
					0 265 007 075 <sup>4</sup>				
	2.4 JTD	10.99-05.02	98/103	LAB	0 265 007 073 <sup>3</sup>				
					0 265 007 076 <sup>4</sup>				
				RAB	0 265 007 074 <sup>3</sup>				
					0 265 007 075 <sup>4</sup>				
		06.02-08.02	110	LAB	0 265 007 073 <sup>3</sup>				
					0 265 007 076 <sup>4</sup>				
				RAB	0 265 007 074 <sup>3</sup>				
					0 265 007 075 <sup>4</sup>				
		09.02-09.05	110	LAB	0 265 007 564 <sup>3</sup>				
					0 265 007 567 <sup>4</sup>				
				RAB	0 265 007 565 <sup>3</sup>				
					0 265 007 566 <sup>4</sup>				
<b>Lybra Station Wagon [839]</b>									
	1.6 i16V	10.99-09.05	76		0 204 102 506		← 54		
					0 204 102 507				
					0 204 103 507				
	1.8 i16V	10.99-09.05	96		0 204 102 506		← 54		
					0 204 103 506				
					0 986 134 005				
	1.9 JTD	10.99-11.06	77/80/85		0 204 102 507		→ 54		
					0 204 103 507				
					0 204 102 506				
	2.0 i20V	10.99-09.05	113		0 204 102 506		← 54		
					0 204 103 506				
					0 986 134 005				
	2.4 JTD	10.99-09.05	98/103/ 110		0 204 102 507		→ 54		
					0 204 103 507				
					0 204 102 506				
	1.6 i16V	10.99-09.05	76		0 204 102 506		← 54		
					0 204 103 506				
					0 986 134 005				
	1.8 i16V	10.99-09.05	96		0 204 102 507		→ 54		
					0 204 103 507				
					0 204 102 506				
	1.6 i16V	10.99-09.05	76		0 986 473 251		← 38		
					0 986 474 251				
					0 986 473 251				
	1.8 i16V	10.99-09.05	96		0 986 473 251		← 38		
					0 986 474 251				







































		S							
1.9 JTD		10.99-11.06	77/80/85				0 986 473 251	 38	
							0 986 474 251	 38	
2.0 i 20V		10.99-09.05	113				0 986 473 251	 38	
							0 986 474 251	 38	
2.4 JTD		10.99-09.05	98/103/ 110				0 986 473 251	 38	
							0 986 474 251	 38	
<hr/>									
									
	1.6 i 16V	10.99-09.05	76				1 987 477 555	 1222	
							1 987 477 556	 1266	
	1.8 i 16V	10.99-09.05	96				1 987 477 555	 1222	
							1 987 477 556	 1266	
	1.9 JTD	10.99-11.06	77/80/85				1 987 477 555	 1222	
							1 987 477 556	 1266	
	2.0 i 20V	10.99-09.05	113				1 987 477 555	 1222	
							1 987 477 556	 1266	
	2.4 JTD	10.99-09.05	98/103/ 110				1 987 477 555	 1222	
							1 987 477 556	 1266	
<hr/>									
	1.6 i 16V	10.99-08.02	76			LAB	0 265 007 073 <sup>3</sup>		
						RAB	0 265 007 076 <sup>4</sup>		
							0 265 007 074 <sup>3</sup>		
							0 265 007 075 <sup>4</sup>		
		09.02-09.05	76			LAB	0 265 007 564 <sup>3</sup>		
						RAB	0 265 007 567 <sup>4</sup>		
							0 265 007 565 <sup>3</sup>		
							0 265 007 566 <sup>4</sup>		
	1.8 i 16V	10.99-08.02	96			LAB	0 265 007 073 <sup>3</sup>		
						RAB	0 265 007 076 <sup>4</sup>		
							0 265 007 074 <sup>3</sup>		
							0 265 007 075 <sup>4</sup>		
		09.02-09.05	96			LAB	0 265 007 564 <sup>3</sup>		
						RAB	0 265 007 567 <sup>4</sup>		
							0 265 007 565 <sup>3</sup>		
							0 265 007 566 <sup>4</sup>		
	1.9 JTD	10.99-06.01	77/80			LAB	0 265 007 073 <sup>3</sup>		
						RAB	0 265 007 076 <sup>4</sup>		
							0 265 007 074 <sup>3</sup>		
							0 265 007 075 <sup>4</sup>		
		06.01-08.02	85			LAB	0 265 007 073 <sup>3</sup>		
						RAB	0 265 007 076 <sup>4</sup>		
							0 265 007 074 <sup>3</sup>		
							0 265 007 075 <sup>4</sup>		
		09.02-11.06	85			LAB	0 265 007 564 <sup>3</sup>		
						RAB	0 265 007 567 <sup>4</sup>		
							0 265 007 565 <sup>3</sup>		
							0 265 007 566 <sup>4</sup>		
	2.0 i 20V	10.99-08.02	113			LAB	0 265 007 073 <sup>3</sup>		
						RAB	0 265 007 076 <sup>4</sup>		
							0 265 007 074 <sup>3</sup>		
							0 265 007 075 <sup>4</sup>		
		09.02-09.05	113			LAB	0 265 007 564 <sup>3</sup>		
						RAB	0 265 007 567 <sup>4</sup>		
							0 265 007 565 <sup>3</sup>		
							0 265 007 566 <sup>4</sup>		
	2.4 JTD	10.99-05.02	98/103			LAB	0 265 007 073 <sup>3</sup>		
						RAB	0 265 007 076 <sup>4</sup>		
							0 265 007 074 <sup>3</sup>		
							0 265 007 075 <sup>4</sup>		



		S							
	◀ LANCIA Lybra Station Wagon [839]								
2.4 JTD		06.02-08.02	110			LAB	0 265 007 073 <sup>3</sup>		
							0 265 007 076 <sup>4</sup>		
						RAB	0 265 007 074 <sup>3</sup>		
							0 265 007 075 <sup>4</sup>		
		09.02-09.05	110			LAB	0 265 007 564 <sup>3</sup>		
							0 265 007 567 <sup>4</sup>		
						RAB	0 265 007 565 <sup>3</sup>		
							0 265 007 566 <sup>4</sup>		
<b>Musa [350]</b>									
	1.3 Multijet	10.04-11.10	51-55				0 204 001 965	← 54	
							0 204 001 966	→ 54	
		09.05→	66/70				0 204 004 338	← 54	0 204 104 282 <sup>8</sup>
							0 986 134 339		
							0 204 004 339	→ 54	0 204 104 282 <sup>8</sup>
							0 986 135 339		
	1.4, LPG, 16V	10.04→	55/57/66/ 70				0 204 001 965	← 54	
							0 204 001 966	→ 54	
	1.6 Multijet	10.07→	85/88				0 204 004 338	← 54	0 204 104 282 <sup>8</sup>
							0 986 134 339		
							0 204 004 339	→ 54	0 204 104 282 <sup>8</sup>
							0 986 135 339		
	1.9 Multijet	10.04→	74				0 204 004 338	← 54	0 204 104 282 <sup>8</sup>
							0 986 134 339		
							0 204 004 339	→ 54	0 204 104 282 <sup>8</sup>
							0 986 135 339		
	1.3 Multijet	10.04-11.10	51-55				0 986 475 937	↔ 22,2	
		09.05-11.10	66		LOC		0 986 475 816	↔ 20,64	
		03.09→	70				0 986 475 936	↔ 20,64	
	1.4, 16V	10.04→	55/66/70				0 986 475 937	↔ 22,2	
	1.9 Multijet	10.04→	74		LOC		0 986 475 816	↔ 20,64	
	1.3 Multijet	10.04-01.06	51-55				1 987 477 928	1535	
		01.06-11.10	66				1 987 477 925	↔ 1557	
		02.06-11.10	51-55				1 987 477 925	1557	
		03.09→	70				1 987 477 925	1557	
	1.4	03.05-01.06	55				1 987 477 928	1535	
		02.06→	55				1 987 477 925	1557	
	1.4 LPG	03.09→	57				1 987 477 925	1557	
	1.4 16V	10.04-01.06	66/70				1 987 477 928	1535	
		02.06→	66/70				1 987 477 925	1557	
	1.6 Multijet	10.07→	85/88				1 987 482 239	408	
								↔ 408	
	1.9 Multijet	01.06→	74				1 987 477 925	↔ 1557	
	1.3 Multijet	10.04-03.07	51-55/66				0 265 007 503 <sup>4</sup>		
							0 265 007 830 <sup>3</sup>		
	1.4	10.04-03.07	55/66/70				0 265 007 503 <sup>4</sup>		
	1.4 16V						0 265 007 830 <sup>3</sup>		
	1.9 Multijet	10.04-03.07	74				0 265 007 503 <sup>4</sup>		
							0 265 007 830 <sup>3</sup>		



















										
<b>Phedra [179]</b>										
										
	2.0 JTD 16V	09.02-01.05	80	Ricam.Nr →10284			1 987 477 713	← 1068		
							1 987 477 714	→ 2360		
		02.05-03.06	80	Ricam.Nr 10285→			1 987 477 953	→ 2308		
							1 987 477 954	← 1041		
		03.06-12.10	88				1 987 482 235	↔ 1255		
		10.06-12.10	100				1 987 482 235	↔ 1255		
	2.0 16V	09.02-01.05	100	Ricam.Nr →10284			1 987 477 713	← 1068		
							1 987 477 714	→ 2360		
		02.05-09.05	100	Ricam.Nr 10285→			1 987 477 953	→ 2308		
							1 987 477 954	← 1041		
2.2 JTD 16V	09.02-01.05	95	Ricam.Nr →10284			1 987 477 713	← 1068			
						1 987 477 714	→ 2360			
	02.05-09.07	95	Ricam.Nr 10285→			1 987 477 953	→ 2308			
						1 987 477 954	← 1041			
	10.07-12.10	120/125				1 987 477 953	→ 2308			
						1 987 477 954	← 1041			
3.0 24V	09.02-01.05	150	Ricam.Nr →10284			1 987 477 713	← 1068			
						1 987 477 714	→ 2360			
	02.05-09.05	150	Ricam.Nr 10285→			1 987 477 953	→ 2308			
						1 987 477 954	← 1041			
	2.0 JTD 16V	09.02-12.10	80/88/100				0 986 594 566 <sup>4</sup>			
							LAB	0 265 007 083 <sup>3</sup>		
	2.0 16V							RAB	0 265 007 084 <sup>3</sup>	
	2.2 JTD 16V	09.02-09.07	95				0 986 594 566 <sup>4</sup>			
							LAB	0 265 007 083 <sup>3</sup>		
								RAB	0 265 007 084 <sup>3</sup>	
		10.07-12.10	120/125				0 986 594 566 <sup>4</sup>			
							LAB	0 265 007 131 <sup>3</sup>		
						RAB	0 265 007 130 <sup>3</sup>			
3.0 24V	09.02-09.05	150				0 986 594 566 <sup>4</sup>				
						LAB	0 265 007 083 <sup>3</sup>			
							RAB	0 265 007 084 <sup>3</sup>		
<b>Thema Berlina [104]</b>										
										
	2.0 i.e., i.e. 16V	05.92-11.94	84/112				0 204 102 560	← 54		
	2.5 TD	05.92-11.94	85				0 204 102 560	← 54		
										
	2.0 i.e., i.e. 16V, i.e. 16V Turbo	05.92-11.94	84/112/148		GIR	0 986 473 027	 ← 38			
						0 986 474 027	 → 38			
	2.5 TD	05.92-11.94	85		GIR	0 986 473 027	 ← 38			
						0 986 474 027	 → 38			
3.0 i.e.	05.92-11.94	126		GIR	0 986 473 027	 ← 38				
					0 986 474 027	 → 38				
										
	2.0 i.e., i.e. 16V, i.e. 16V Turbo	05.92-11.94	84/112/148				1 987 477 390	2950		
	3.0 i.e.	05.92-11.94	126				1 987 477 390	2950		
	2.0 i.e., i.e. 16V, i.e. 16V Turbo	05.92-11.94	84/112/148				0 265 006 262 <sup>3</sup>			
		10.93-11.94	84/112/148				0 265 006 238 <sup>4</sup>			
	2.5 TD	05.92-11.94	85				0 265 006 262 <sup>3</sup>			
		01.93-11.94	85				0 265 003 075 <sup>4</sup>			
	10.93-11.94	85				0 265 006 238 <sup>4</sup>				

		S							
	◀ LANCIA Thema Berlina [104]								
	3.0 i.e.	05.92-11.94	126				0 265 006 262 <sup>3</sup>		
		10.93-11.94	126				0 265 006 238 <sup>4</sup>		
<b>Thema Station Wagon [104]</b>									
	2.0 i.e. 16V	05.92-11.94	112				0 204 102 560	← 54	
	2.5 TD	05.92-11.94	85				0 204 102 560	← 54	
	2.0 i.e. 16V	05.92-11.94	112/148		GIR	0 986 473 027		← 38	
	2.0 i.e. 16V Turbo					0 986 474 027		→ 38	
	2.5 TD	05.92-11.94	85		GIR	0 986 473 027		← 38	
						0 986 474 027		→ 38	
	3.0 i.e.	05.92-11.94	126		GIR	0 986 473 027		← 38	
						0 986 474 027		→ 38	
	2.0 i.e. 16V, i.e. 16V Turbo	05.92-11.94	112/148			1 987 477 390		2950	
	3.0 i.e.	05.92-11.94	126			1 987 477 390		2950	
	2.0 i.e. 16V	05.92-11.94	112/148			0 265 006 262 <sup>3</sup>			
	2.0 i.e. 16V Turbo	10.93-11.94	112/148			0 265 006 238 <sup>4</sup>			
	2.5 TD	05.92-11.94	85			0 265 006 262 <sup>3</sup>			
		01.93-11.94	85			0 265 003 075 <sup>4</sup>			
		10.93-11.94	85			0 265 006 238 <sup>4</sup>			
	3.0 i.e.	05.92-11.94	126			0 265 006 262 <sup>3</sup>			
		10.93-11.94	126			0 265 006 238 <sup>4</sup>			
<b>Thesis [841]</b>									
	2.0 Turbo 20V	04.02-12.09	136			0 265 007 059 <sup>3</sup>			
	2.4 JTD 10V, JTD 20V, 20V	04.02-12.09	110/120/125/129/136			0 265 007 059 <sup>3</sup>			
	3.0 V6 24V	04.02-07.03	158			0 265 007 059 <sup>3</sup>			
	3.2 V6 24V	08.03-12.09	169			0 265 007 059 <sup>3</sup>			
<b>Y 10 [156]</b>									
	1.1 i Selectronic	09.92-12.95	37			0 204 102 524		← 48	0 204 104 234 <sup>7</sup>
						0 204 103 524			
						0 204 102 525		→ 48	0 204 104 234 <sup>7</sup>
						0 204 103 525			
	1.1 i	09.92-12.95	37			0 204 102 447		← 48	0 204 104 184
	1.1 i 4x4					0 986 473 104			
						0 204 102 448		→ 48	0 204 104 184
						0 986 474 104			
		01.95-12.95	40			0 204 102 447		← 48	0 204 104 184
						0 986 473 104			
						0 204 102 448		→ 48	0 204 104 184
						0 986 474 104			
	1.3 i	09.92-12.95	53			0 204 102 524		← 48	0 204 104 234 <sup>7</sup>
						0 204 103 524			
						0 204 102 525		→ 48	0 204 104 234 <sup>7</sup>
						0 204 103 525			
	1.1 i, i Selectronic, i 4x4	09.92-12.95	37/40			F 026 002 454		↔ 19,05	
	1.3 i	09.92-12.95	53			F 026 002 454		↔ 19,05	

		S							
									
	1.1 i, i Selectronic, i 4x4		09.92-12.95	37			1 987 477 651	2385	
	1.1 i, i 4x4		01.95-12.95	40			1 987 477 086	2668	
	1.3 i		09.92-12.95	53			1 987 477 086	2668	
<b>Y [840]</b>									
									
	1.1 i.e.	ABO	04.97-03.98	40			0 204 102 492	← 48	0 204 104 203 <sup>7</sup>
							0 204 103 494		
							0 986 134 007		
							0 204 102 493	→ 48	0 204 104 203 <sup>7</sup>
							0 204 103 495		
							0 986 135 007		
			04.98-06.00	40			0 204 102 494	← 48	0 204 104 203 <sup>7</sup>
							0 204 103 494		
							0 204 103 822		
							0 204 102 495	→ 48	0 204 104 203 <sup>7</sup>
							0 204 103 495		
							0 986 135 007		
		ABS	04.97-06.97	40			0 204 102 524	← 48	0 204 104 234 <sup>7</sup>
							0 204 103 524		
							0 204 102 525	→ 48	0 204 104 234 <sup>7</sup>
							0 204 103 525		
			07.97-06.00	40					0 204 104 208 <sup>8</sup>
	1.2 i 8V	ABO	04.98-06.03	44			0 204 102 494	← 48	0 204 104 203 <sup>7</sup>
	1.2 i.e. 8V						0 204 103 494		
							0 204 103 822		
							0 204 102 495	→ 48	0 204 104 203 <sup>7</sup>
							0 204 103 495		
							0 986 135 007		
		ABS	07.97-06.03	44					0 204 104 208 <sup>8</sup>
	1.2 i 16V		06.00-06.03	63					0 204 104 208 <sup>8</sup>
	1.2 i.e. 8V	ABO	01.96-03.98	44			0 204 102 492	← 48	0 204 104 203 <sup>7</sup>
							0 204 103 494		
							0 986 134 007		
							0 204 102 493	→ 48	0 204 104 203 <sup>7</sup>
							0 204 103 495		
							0 986 135 007		
		ABS	01.96-06.97	44			0 204 102 524	← 48	0 204 104 234 <sup>7</sup>
							0 204 103 524		
							0 204 102 525	→ 48	0 204 104 234 <sup>7</sup>
							0 204 103 525		
	1.2 i.e. 16V	ABO	04.97-06.00	63					0 204 104 208 <sup>8</sup>
		ABS	04.97-06.97	63			0 204 102 524	← 48	0 204 104 234 <sup>7</sup>
							0 204 103 524		
							0 204 102 525	→ 48	0 204 104 234 <sup>7</sup>
							0 204 103 525		
	1.4 i.e. 12V		01.96-06.97	55/59			0 204 102 524	← 48	0 204 104 234 <sup>7</sup>
							0 204 103 524		
							0 204 102 525	→ 48	0 204 104 234 <sup>7</sup>
							0 204 103 525		
			07.97-06.00	55/59					0 204 104 208 <sup>8</sup>
									
	1.1 i.e.	ABO	04.97-06.00	40	LOC		0 986 475 816	↔ 20,64	
		ABS	04.97-06.00	40			F 026 002 157	↔ 20,6	
	1.2 i 8V, i.e. 8V	ABS	01.96-06.03	44			F 026 002 157	↔ 20,6	
	1.2 i 8V, i.e. 8V, i.e. 16V	ABO	01.96-06.03	44/63	LOC		0 986 475 816	↔ 20,64	
	1.2 i 16V		06.00-06.03	63			F 026 002 157	↔ 20,6	
	1.2 i.e. 16V	ABS	04.97-06.00	63			F 026 002 157	↔ 20,6	



		S							
<b>LANCIA Y [840]</b>									
	1.4 i.e. 12V	ABO	01.96-06.00	55/59		LOC	0 986 475 816		↔ 20,64
		ABS	01.96-06.00	55/59			F 026 002 157		↔ 20,6
	1.1 i.e.		04.97-06.00	40			1 987 477 655		→ 1414
							1 987 477 656		← 1392
	1.2 i 8V, i 16V, i.e. 8V, i.e. 16V		01.96-06.03	44/63			1 987 477 655		→ 1414
							1 987 477 656		← 1392
1.4 i.e. 12V		01.96-06.00	55/59			1 987 477 655		→ 1414	
							1 987 477 656		← 1392
	1.1 i.e.		04.97-06.00	40		LAB	0 265 006 139 <sup>4</sup>		
						RAB	0 265 006 140 <sup>4</sup>		
						Ricam.Nr →3336902	0 265 006 138 <sup>3</sup>		
						Ricam.Nr 3336903→	0 265 007 024 <sup>3</sup>		
	1.2 i 8V		06.00-06.03	44/63		LAB	0 265 007 024 <sup>3</sup>		
						RAB	0 265 007 025 <sup>3</sup>		
	1.2 i 16V						0 265 007 025 <sup>3</sup>		
							0 265 007 027 <sup>4</sup>		
	1.2 i.e. 8V		01.96-06.00	44/63		LAB	0 265 006 139 <sup>4</sup>		
						RAB	0 265 006 140 <sup>4</sup>		
	1.2 i.e. 16V					Ricam.Nr →3336902	0 265 006 138 <sup>3</sup>		
						Ricam.Nr 3336903→	0 265 007 024 <sup>3</sup>		
1.4 i.e. 12V		01.96-06.00	55/59		LAB	0 265 006 139 <sup>4</sup>			
					RAB	0 265 006 140 <sup>4</sup>			
					Ricam.Nr →3336902	0 265 006 138 <sup>3</sup>			
					Ricam.Nr 3336903→	0 265 007 024 <sup>3</sup>			
					RAB	0 265 007 025 <sup>3</sup>			
<b>Ypsilon [312]</b>									
	0.9		06.11→	62,5			0 986 475 936		↔ 20,64
	1.2, Bi-Fuel		06.11→	51			0 986 475 936		↔ 20,64
	1.3 Multijet 16V		06.11→	70			0 986 475 936		↔ 20,64
	0.9		06.11→	62,5			1 987 482 393		→ 1535
							1 987 482 394		← 1535
	1.2		06.11→	51			1 987 482 393		→ 1535
							1 987 482 394		← 1535
	1.3 Multijet 16V		06.11→	70			1 987 482 393		→ 1535
							1 987 482 394		← 1535
<b>Ypsilon [843]</b>									
	1.2 8V		06.03-11.11	44	Fg.-Nr. →2103111		0 986 134 291		← 48
							0 986 135 291		→ 48
					Fg.-Nr. 2103112→		0 986 134 291		← 48
							0 986 135 291		→ 48
			08.10-11.11	51			0 986 134 291		← 48
							0 986 135 291		→ 48
	1.4 8V		10.06-11.11	55			0 986 134 291		← 48
							0 986 135 291		→ 48

		S							
									
	1.2 16V	06.03-12.05	59				1 987 477 912	1425	
		01.06-09.06	59				1 987 477 912	↔ 1425	
	1.2 8V	06.03-12.05	44				1 987 477 912	1425	
		01.06-11.11	44				1 987 477 912	↔ 1425	
		08.10-11.11	51				1 987 477 912	↔ 1425	
	1.3 JTD	06.03-12.05	51				1 987 477 912	1425	
		01.06-09.06	51				1 987 477 912	↔ 1425	
	1.3 Multijet	10.06-11.10	55				1 987 477 912	↔ 1425	
		10.06-11.11	66/77		TBR		1 987 477 912	↔ 1425	
	1.4 16V	06.03-12.05	70				1 987 477 912	1425	
		01.06-11.11	70		TBR		1 987 477 912	↔ 1425	
	1.4 8V	10.06-11.11	55				1 987 477 912	↔ 1425	
	1.2 16V	06.03-09.06	59				0 265 007 830 <sup>3</sup>		
							0 265 008 049 <sup>4</sup>		
	1.2 8V	06.03-11.11	44				0 265 007 830 <sup>3</sup>		
		08.10-11.11	51				0 265 008 049 <sup>4</sup>		
					AMJ		0 265 008 188 <sup>4</sup>		
					AMJ		0 265 008 049 <sup>4</sup>		
	1.3 JTD	06.03-11.10	51/55				0 265 007 830 <sup>3</sup>		
	1.3 Multijet						0 265 008 049 <sup>4</sup>		
	1.3 Multijet	10.06-11.11	66/77				0 265 007 830 <sup>3</sup>		
					AMJ		0 265 008 188 <sup>4</sup>		
					AMJ		0 265 008 049 <sup>4</sup>		
	1.4 16V	06.03-11.11	70				0 265 007 830 <sup>3</sup>		
					AMJ		0 265 008 188 <sup>4</sup>		
					AMJ		0 265 008 049 <sup>4</sup>		
	1.4 8V	10.06-11.11	55				0 265 007 830 <sup>3</sup>		
							0 265 008 049 <sup>4</sup>		
<b>Zeta [122]</b>									
									
	2.0 i.e. Turbo, JTD, 16V	02.98-06.02	80/97/110				0 986 473 115	↔ 57,11	
							0 986 474 115	↔ 57,11	
	2.1 TD	02.98-06.99	80				0 986 473 115	↔ 57,11	
							0 986 474 115	↔ 57,11	
									
	2.0 i.e. Turbo, JTD, 16V	09.94-06.02	80/97/110				F 026 002 181	↔ 19,05	
	2.1 TD	05.96-06.99	80				F 026 002 181	↔ 19,05	
									
	2.0 i.e. Turbo	ABO 09.94-06.02	80/97/110				1 987 477 569	→ 2286	
	2.0 JTD	ABS 09.94-06.02	80/97/110				1 987 477 524	→ 2205	
	2.0 16V						1 987 477 525	← 1255	
	2.1 TD	ABO 05.96-06.99	80				1 987 477 569	→ 2286	
		ABS 05.96-06.99	80				1 987 477 524	→ 2205	
							1 987 477 525	← 1255	
	2.0 i.e. Turbo	09.94-08.97	110				0 265 006 426 <sup>4</sup>		
		09.94-06.99	110				0 265 006 388 <sup>3</sup>		
		09.97-06.99	110				0 265 006 406 <sup>4</sup>		
	2.0 JTD	06.99-06.02	80				0 265 006 388 <sup>3</sup>		
							0 265 006 406 <sup>4</sup>		
	2.0 16V	06.99-10.00	97				0 265 006 406 <sup>4</sup>		
		06.99-06.02	97				0 265 006 388 <sup>3</sup>		
		10.00-06.02	97				0 265 006 504 <sup>4</sup>		



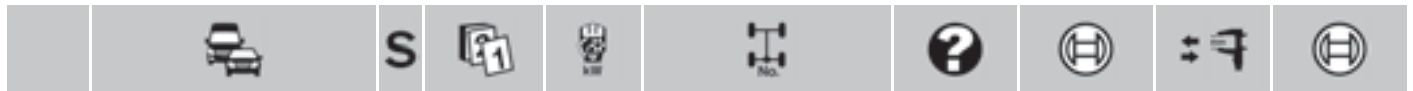

	◀ LANCIA Zeta [122]							
	2.1 TD	05.96-08.97	80			0 265 006 426 <sup>4</sup>		
		05.96-06.99	80			0 265 006 388 <sup>3</sup>		
		09.97-06.99	80			0 265 006 406 <sup>4</sup>		

**LAND ROVER GROUP**

**Defender 90**

	2.2 Td4 AWD	09.11→	90		INB			F 026 A08 155 <sup>7</sup>
	2.4 Td4 AWD	05.07→	90-103		INB			F 026 A08 155 <sup>7</sup>
	2.8 AWD	ABS 09.00-09.04	140-142			0 986 473 296	← 41	F 026 A08 225 <sup>6</sup>
						0 986 474 296	→ 41	F 026 A08 225 <sup>6</sup>
	2.2 Td4 AWD	09.11→	90	Fg.-Nr. AA798477→		0 265 004 042 <sup>3</sup>		
						0 265 004 043 <sup>4</sup>		
	2.4 Td4 AWD	05.07→	90-103	Fg.-Nr. AA798477→		0 265 004 042 <sup>3</sup>		
						0 265 004 043 <sup>4</sup>		

**Defender 110**

	2.2 Td4 AWD	09.11→	90		INB			F 026 A08 155 <sup>7</sup>
	2.4 Td4 AWD	08.07→	90-103		INB			F 026 A08 155 <sup>7</sup>
	2.5 AWD, D AWD, D Turbo AWD	08.90-12.01	50-51/62/ 65-83			0 986 475 976	→ 27	
						0 986 475 977	← 27	
	3.5 AWD	08.90-12.98	100			0 986 475 976	→ 27	
						0 986 475 977	← 27	
	2.2 Td4 AWD	09.11→	90	Fg.-Nr. AA798477→		0 265 004 042 <sup>3</sup>		
						0 265 004 043 <sup>4</sup>		
	2.4 Td4 AWD	08.07→	90-103	Fg.-Nr. AA798477→		0 265 004 042 <sup>3</sup>		
						0 265 004 043 <sup>4</sup>		

**Defender 130**

	2.2 Td4 AWD	09.11→	90		INB			F 026 A08 155 <sup>7</sup>
	2.4 Td4 AWD	08.07→	90-103		INB			F 026 A08 155 <sup>7</sup>
	2.5 D AWD, D Turbo AWD, Td5 AWD	08.90-07.07	50/80-83/ 90			0 986 475 976	→ 27	
						0 986 475 977	← 27	
	2.2 Td4 AWD	09.11→	90	Fg.-Nr. AA798477→		0 265 004 042 <sup>3</sup>		
	2.4 Td4 AWD	08.07→	90-103	Fg.-Nr. AA798477→		0 265 004 042 <sup>3</sup>		





**Discovery I**

	<b>2.0i 16V AWD</b>	10.93-06.98	100	Fg.-Nr. →KA 034313	INB	0 986 473 304		← 41	
						0 986 474 304		→ 41	
	<b>2.5 TDi AWD</b>	09.89-12.98	82-90	Fg.-Nr. →KA 034313	INB	0 986 473 304		← 41	
						0 986 474 304		→ 41	
	<b>3.5 AWD</b>	09.89-12.98	98-119	Fg.-Nr. →KA 034313	INB	0 986 473 304		← 41	
	<b>3.5 i AWD</b>					0 986 474 304		→ 41	
	<b>3.9i V8 AWD</b>	10.93-12.99	134-136	Fg.-Nr. →KA 034313	INB	0 986 473 304		← 41	
						0 986 474 304		→ 41	

	<b>2.0i 16V AWD</b>	10.93-06.98	100	Fg.-Nr. Achs(A) 28S 44172D→, Achs(A) 32S 2119B→		0 986 473 296		← 41	F 026 A08 225 <sup>6</sup>
						0 986 474 296		→ 41	F 026 A08 225 <sup>6</sup>
	<b>2.5 TDi AWD</b>	09.89-12.98	82-90	Fg.-Nr. Achs(A) 28S 44172D→, Achs(A) 32S 2119B→		0 986 473 296		← 41	F 026 A08 225 <sup>6</sup>
						0 986 474 296		→ 41	F 026 A08 225 <sup>6</sup>
	<b>3.5 AWD</b>	09.89-12.98	98-119	Fg.-Nr. Achs(A) 28S 44172D→, Achs(A) 32S 2119B→		0 986 473 296		← 41	F 026 A08 225 <sup>6</sup>
	<b>3.5 i AWD</b>					0 986 474 296		→ 41	F 026 A08 225 <sup>6</sup>
	<b>3.9i V8 AWD</b>	10.93-12.99	134-136	Fg.-Nr. Achs(A) 28S 44172D→, Achs(A) 32S 2119B→		0 986 473 296		← 41	F 026 A08 225 <sup>6</sup>
						0 986 474 296		→ 41	F 026 A08 225 <sup>6</sup>

	<b>2.0i 16V AWD</b>	10.93-06.98	100	Fg.-Nr. →JA 020500		1 987 477 873			1193
				Fg.-Nr. JA 020501→KA 055568		1 987 477 873			1193
	<b>2.5 TDi AWD</b>	09.89-12.98	82-90	Fg.-Nr. →JA 020500		1 987 477 873			1193
				Fg.-Nr. JA 020501→KA 055568		1 987 477 873			1193
	<b>3.5 AWD</b>	09.89-12.98	98-119	Fg.-Nr. →JA 020500		1 987 477 873			1193
	<b>3.5 i AWD</b>			Fg.-Nr. JA 020501→KA 055568		1 987 477 873			1193
	<b>3.9i V8 AWD</b>	10.93-12.99	134-136	Fg.-Nr. →JA 020500		1 987 477 873			1193
				Fg.-Nr. JA 020501→KA 055568		1 987 477 873			1193

**Discovery II**

	<b>4.6i AWD</b>	01.03-12.04	140			0 986 473 348		← 48	
						0 986 474 348		→ 48	

	<b>4.6i AWD</b>	01.03-12.04	140			0 986 473 365		← 45	
						0 986 474 365		→ 45	

**Discovery II [LT, LJ]**

	<b>2.5 Td5 AWD</b>	10.98-08.04	100-102			0 986 473 348		← 48	
						0 986 474 348		→ 48	
	<b>4.0i AWD</b>	10.98-08.04	134-139			0 986 473 348		← 48	
						0 986 474 348		→ 48	

	<b>2.5 Td5 AWD</b>	10.98-08.04	100-102			0 986 473 365		← 45	
						0 986 474 365		→ 45	
	<b>4.0i AWD</b>	10.98-08.04	134-139			0 986 473 365		← 45	
						0 986 474 365		→ 45	



		S				?			
◀ LAND ROVER GROUP									
<b>Discovery II [LT,LJ]</b>									
	4.0 i AWD i 4X4	09.96-08.02					0986 473 348		← 48
							0986 474 348		→ 48
	4.0 i 4X4	09.98-08.02					0986 473 348		← 48
							0986 474 348		→ 48
	4.0 i AWD i 4X4	09.96-08.02					0986 473 365		← 45
							0986 474 365		→ 45
	4.0 i 4X4	09.98-08.02					0986 473 365		← 45
							0986 474 365		→ 45
<b>Discovery III [TAA]</b>									
	2.7 TDV6 AWD	09.04-08.09	140-147				0 265 007 922 <sup>4</sup>		
						Fg.-Nr. 6A351057→	0 265 007 923 <sup>3</sup>		
	4.0 AWD	09.04-08.09	156-161				0 265 007 922 <sup>4</sup>		
						Fg.-Nr. 6A351057→	0 265 007 923 <sup>3</sup>		
	4.4 AWD	09.04-08.09	220				0 265 007 922 <sup>4</sup>		
						Fg.-Nr. 6A351057→	0 265 007 923 <sup>3</sup>		
<b>Discovery IV [LA]</b>									
	2.7 TDV6 AWD	09.09-08.10	140				0 265 007 922 <sup>4</sup>		
							0 265 008 266 <sup>3</sup>		
	3.0 SDV6 AWD, TDV6 AWD, V6 Supercharged AWD	09.09→	155/180-200/ 250				0 265 007 922 <sup>4</sup>		
							0 265 008 266 <sup>3</sup>		
	4.0 V6 AWD	09.09→	161				0 265 007 922 <sup>4</sup>		
							0 265 008 266 <sup>3</sup>		
	5.0 V8 AWD	09.09→	276-280				0 265 007 922 <sup>4</sup>		
							0 265 008 266 <sup>3</sup>		
<b>Freelander II</b>									
	2.2 Td4 AWD	10.06→	110-118			Fg.-Nr. →CH999999	0986 134 243		←
							0986 135 243		→
	2.2 Td4 AWD	10.06→	110-118			Fg.-Nr. →CH999999	1987 482 313		→ 1573
							1987 482 314		← 1578
	3.2 i6 AWD	10.06-11.12	170-171			Fg.-Nr. →CH999999	1987 482 313		→ 1573
							1987 482 314		← 1578
<b>Freelander [LN]</b>									
	1.8 i 16V AWD	09.97-03.07	84-88			Fg.-Nr. →YA 999999	0986 473 302		← 57
							0986 474 302		→ 57
						Fg.-Nr. 1A 000001→	0986 473 303		← 57
							0986 474 303		→ 57
	2.0 D AWD	09.97-03.07	70-72/			Fg.-Nr. →YA 999999	0986 473 302		← 57
	2.0 TD4 AWD		80-82				0986 474 302		→ 57
						Fg.-Nr. 1A 000001→	0986 473 303		← 57
							0986 474 303		→ 57
	2.5 V6 AWD	09.01-03.07	130			Fg.-Nr. →YA 999999	0986 473 302		← 57
							0986 474 302		→ 57



		S							
2.5 V6 AWD		09.01-03.07	130	Fg.-Nr. 1A 000001→			0 986 473 303		← 57
							0 986 474 303		→ 57
1.8 i 16V AWD		09.97-03.07	84-88	Fg.-Nr. →YA 999999			0 986 475 838		↔ 20,6
				Fg.-Nr. 1A 000001→			0 986 475 955		↔ 19
2.0 D AWD		09.97-03.07	70-72/	Fg.-Nr. →YA 999999			0 986 475 838		↔ 20,6
2.0 TD4 AWD			80-82	Fg.-Nr. 1A 000001→			0 986 475 955		↔ 19
2.5 V6 AWD		09.01-03.07	130	Fg.-Nr. →YA 999999			0 986 475 838		↔ 20,6
				Fg.-Nr. 1A 000001→			0 986 475 955		↔ 19
1.8 i 16V AWD		09.97-03.07	84-88	Fg.-Nr. →YA 999999			1 987 477 790		→ 1568
							1 987 477 791		← 1568
2.0 D AWD		09.97-03.07	70-72/	Fg.-Nr. →YA 999999			1 987 477 790		→ 1568
2.0 TD4 AWD			80-82				1 987 477 791		← 1568
2.5 V6 AWD		09.01-03.07	130	Fg.-Nr. →YA 999999			1 987 477 790		→ 1568
							1 987 477 791		← 1568
<b>Freelander 2 [LF]</b>									
2.2 eD4		09.10→	110/140	Fg.-Nr. →CH999999			0 986 134 243		←
2.2 SD4 AWD							0 986 135 243		→
2.2 eD4		09.10→	110/140	Fg.-Nr. →CH999999			1 987 482 313		→ 1573
2.2 SD4 AWD							1 987 482 314		← 1578
<b>Range Rover I</b>									
2.5 D Turbo AWD	ABO	10.91-09.94	83/89	Hintera. 34S 16422C→, 36S 00595B→			0 986 473 296		← 41
	ABS	10.91-09.94	83/89	Hintera. 35S 18189C→, 37S 08651B→			0 986 474 296		→ 41
							0 986 473 296		← 41
							0 986 474 296		→ 41
2.5 TDi Classic AWD	ABO	10.92-09.95	83/89	Hintera. 34S 16422C→, 36S 00595B→			0 986 473 296		← 41
	ABS	10.92-09.95	83/89	Hintera. 35S 18189C→, 37S 08651B→			0 986 473 296		← 41
							0 986 474 296		→ 41
							0 986 473 296		← 41
3.9 i AWD	ABO	10.91-08.94	127/134	Hintera. 34S 16422C→, 36S 00595B→			0 986 473 296		← 41
	ABS	10.91-08.94	127/134	Hintera. 35S 18189C→, 37S 08651B→			0 986 473 296		← 41
							0 986 474 296		→ 41
							0 986 473 296		← 41
3.9 i Classic AWD	ABO	10.91-04.96	127/134	Hintera. 34S 16422C→, 36S 00595B→			0 986 473 296		← 41
	ABS	10.91-04.96	127/134	Hintera. 35S 18189C→, 37S 08651B→			0 986 473 296		← 41
							0 986 474 296		→ 41
							0 986 473 296		← 41
4.3 Vogue LSE AWD	ABO	09.92-04.96	147-149	Hintera. 34S 16422C→, 36S 00595B→			0 986 473 296		← 41
	ABS	09.92-04.96	147-149	Hintera. 35S 18189C→, 37S 08651B→			0 986 473 296		← 41
							0 986 474 296		→ 41
							0 986 473 296		← 41
<b>Range Rover II [LP]</b>									
2.5 D AWD		09.94-08.02	100-102				0 986 473 348		← 48
							0 986 474 348		→ 48
4.0 i V8 AWD		09.94-08.02	136-140				0 986 473 348		← 48
							0 986 474 348		→ 48



<b>LAND ROVER GROUP Range Rover II [LP]</b>									
	4.6 iV8 AWD		09.94-08.02	158-168			0986 473 348		← 48
							0986 474 348		→ 48
	2.5 D AWD		09.94-08.02	100-102			0986 473 365		← 45
							0986 474 365		→ 45
	2.5 TDi AWD	ABO	10.94-04.96	81-83	Hintera. 34S 16422C→, 36S 00595B→		0986 473 296		← 41
							0986 474 296		→ 41
		ABS	10.94-04.96	81-83	Hintera. 35S 18189C→, 37S 08651B→		0986 473 296		← 41
							0986 474 296		→ 41
	4.0 iV8 AWD		09.94-08.02	136-140			0986 473 365		← 45
							0986 474 365		→ 45
	4.6 iV8 AWD		09.94-08.02	158-168			0986 473 365		← 45
							0986 474 365		→ 45
<b>Range Rover III [LM L322]</b>									
	3.0 Td6 AWD		03.02-09.06	130	Fg.-Nr. →5A999999	RLE	1987 482 254		→ 1825
							1987 482 255		← 1850
	4.4 V8 AWD		03.02-07.05	210	Fg.-Nr. →5A999999	RLE	1987 482 254		→ 1825
							1987 482 255		← 1850
<b>Range Rover IV [LG]</b>									
	3.0 AWD, SDV6 HYBRID AWD, TD AWD		02.13→	155-190/ 250-254			0 265 009 325 <sup>3</sup>		
							0 265 009 326 <sup>4</sup>		
	4.4 SD AWD		01.14→	250			0 265 009 325 <sup>3</sup>		
							0 265 009 326 <sup>4</sup>		
	5.0 AWD		02.13→	276/375			0 265 009 325 <sup>3</sup>		
							0 265 009 326 <sup>4</sup>		
<b>Range Rover [LW L494]</b>									
	3.0 AWD		09.13→	250			0 265 009 325 <sup>3</sup>		
							0 265 009 326 <sup>4</sup>		
<b>Range Rover Sport [LS L320]</b>									
	2.7 TD AWD		03.05-08.09	140			0 265 007 922 <sup>4</sup>		
							0 265 007 924 <sup>3</sup>		
	3.0 SD AWD		09.09-08.13	155-188			0 265 007 922 <sup>4</sup>		
	3.0 TD AWD						0 265 007 924 <sup>3</sup>		
	3.6 TD AWD		01.07-08.13	200			0 265 007 922 <sup>4</sup>		
							0 265 007 924 <sup>3</sup>		
	4.2 AWD		03.05-08.09	286-287			0 265 007 922 <sup>4</sup>		
							0 265 007 924 <sup>3</sup>		
	4.4 AWD		03.05-08.09	220-225			0 265 007 922 <sup>4</sup>		
							0 265 007 924 <sup>3</sup>		
	5.0 AWD		09.09-08.13	276-280/ 372-375			0 265 007 922 <sup>4</sup>		
	5.0 SC AWD						0 265 007 924 <sup>3</sup>		
<b>Range Rover Sport [LW L494]</b>									
	3.0 SDV6 AWD, SDV6 Hybrid AWD, TDV6 AWD		09.13→	183-190/ 215-250			0 265 009 325 <sup>3</sup>		
							0 265 009 326 <sup>4</sup>		
	5.0 AWD		09.13→	375-405			0 265 009 325 <sup>3</sup>		
							0 265 009 326 <sup>4</sup>		

		S							
<b>LEXUS</b>									
<b>GX [J1]</b>									
	470 4x4	11.02-09.05	172						F 026 A06 115 <sup>7</sup>
		11.02-08.09	172			0 986 134 312		←	
						0 986 135 312		→	
		10.05-08.09	172						F 026 A06 116 <sup>7</sup>
	460 i 4x4	11.09→	225			0 986 134 250		←	F 026 A08 119 <sup>7</sup>
						0 986 135 250		→	F 026 A08 119 <sup>7</sup>
	470 4x4	11.02-08.09	172			0 986 134 250		←	F 026 A08 119 <sup>7</sup>
						0 986 135 250		→	F 026 A08 119 <sup>7</sup>
<b>LX [J1]</b>									
	470 4x4	01.98-08.07	172			F 026 A03 264		→	F 026 A03 520 <sup>7</sup>
						F 026 A03 265		←	F 026 A03 520 <sup>7</sup>
	470 4x4	01.98-12.02	172						F 026 A03 491 <sup>7</sup>
<b>LX [J2]</b>									
	570 4x4	11.07→	282						F 026 A06 612 <sup>7</sup>
	570 4x4	11.07→	282						F 026 A07 001 <sup>7</sup>
<b>LX [J8]</b>									
	450 4x4	11.95-01.98	158			F 026 A03 335		→	F 026 A03 313 <sup>6</sup>
									F 026 A08 118 <sup>7</sup>
						F 026 A03 338		←	F 026 A03 313 <sup>6</sup>
	450 4x4	11.95-01.98	158			F 026 A03 326		→	F 026 A08 119 <sup>7</sup>
						F 026 A03 327		←	F 026 A08 119 <sup>7</sup>
<b>RX [U1]</b>									
	300 4x4	01.98-02.03	148/164						F 026 A03 510 <sup>7</sup>





**MARUTI**

**Omni**

	0.8	11.84-11.99	27	U05	0986 <b>AB8 102</b>	← 25,4	
					0986 <b>AB8 103</b>	→ 25,4	
				V80	0986 <b>AB8 104</b>	← 25,4	
					0986 <b>AB8 105</b>	→ 25,4	

**Zen**

	1.0 i 1.0 i 16V	10.93-03.06	37/44		1987 <b>482 088</b>		3135

**800 [MB 308]**

	0.8 i 6V 0.8 i 6V, i 12V	01.05→ 12.83-03.03	27 29/33		0986 <b>AB8 101</b>	↔ 15,88	
					0986 <b>AB8 101</b>	↔ 15,88	

**MAZDA**

**BT-50 [UN]**

	2.5 D Turbo	03.06→	105	EIZ	0 204 <b>772 021</b>	←	F 026 <b>A06 094</b> <sup>7</sup>
					0 204 <b>772 022</b>	→	F 026 <b>A06 094</b> <sup>7</sup>
				ZWZ			F 026 <b>A03 551</b> <sup>7</sup>
	2.5 D Turbo 4x4	03.06-07.12	105				F 026 <b>A03 551</b> <sup>7</sup>
	3.0 D Turbo	03.06→	115	EIZ	0 204 <b>772 021</b>	←	F 026 <b>A06 094</b> <sup>7</sup>
					0 204 <b>772 022</b>	→	F 026 <b>A06 094</b> <sup>7</sup>
				ZWZ			F 026 <b>A03 551</b> <sup>7</sup>
	3.0 D Turbo 4x4	03.06-07.12	115				F 026 <b>A03 551</b> <sup>7</sup>

**Demio [DW]**

	1.3 i 1.5 i	05.98-02.03 01.00-02.03	46/53 55				F 026 <b>A03 502</b> <sup>7</sup> F 026 <b>A03 502</b> <sup>7</sup>

**E-Serie**

	2.0 i 2.2 D	08.99-12.01 03.97-08.99 08.99-01.10	71 52 52				F 026 <b>A03 485</b> <sup>7</sup> F 026 <b>A08 160</b> <sup>7</sup> F 026 <b>A03 485</b> <sup>7</sup>
	2.0 i 2.2 D	09.90-04.97 08.99-12.01 03.97-08.99	71 71 52				F 026 <b>A02 215</b> → F 026 <b>A02 216</b> ← F 026 <b>A02 388</b> ↔
				OZB	F 026 <b>A02 239</b>	→	
					F 026 <b>A02 240</b>	←	
				ZWB	F 026 <b>A02 325</b>	→	
					F 026 <b>A02 326</b>	←	
		08.99-02.04	52	Fg.-Nr. →SD1*32105858	F 026 <b>A02 388</b>	↔	



		S							
	2.0i	08.99-12.01	71			LAB	F 01G 09F 0B2 <sup>3</sup>		
						RAB	F 01G 09F 0GS <sup>4</sup>		
							F 01G 09F 0B3 <sup>3</sup>		
							F 01G 09F 0GT <sup>4</sup>		
	2.2D	08.99-01.10	52			LAB	F 01G 09F 0B2 <sup>3</sup>		
						RAB	F 01G 09F 0GS <sup>4</sup>		
							F 01G 09F 0B3 <sup>3</sup>		
							F 01G 09F 0GT <sup>4</sup>		
<b>Marathon</b>									
	2.2	08.91-02.01	77						F 026 A08 160 <sup>7</sup>
	2.2	08.91-01.98	77				F 026 A02 214	←	
<b>MPV [LV]</b>									
	2.5 12V D Turbo	03.96-05.99	85						F 026 A03 485 <sup>7</sup>
	3.0i	11.95→	109-113/115						F 026 A03 485 <sup>7</sup>
	2.5 12V D Turbo	03.96-05.99	85			LAB	F 01G 09F 09K <sup>3</sup>		
						RAB	F 01G 09F 09L <sup>3</sup>		
							Fg.-Nr. LV12*2-104600→		
						LAB	F 01G 09F 0EU <sup>4</sup>		
						RAB	F 01G 09F 0EH <sup>4</sup>		
	3.0i	11.95-05.99	109-113			LAB	F 01G 09F 09K <sup>3</sup>		
						RAB	F 01G 09F 09L <sup>3</sup>		
							Fg.-Nr. LV12J5-100845→		
						LAB	F 01G 09F 0EU <sup>4</sup>		
						RAB	F 01G 09F 0EH <sup>4</sup>		
		12.95→	115			LAB	F 01G 09F 09K <sup>3</sup>		
						RAB	F 01G 09F 09L <sup>3</sup>		
							Fg.-Nr. LV10E2-102031→		
						LAB	F 01G 09F 0EU <sup>4</sup>		
						RAB	F 01G 09F 0EH <sup>4</sup>		
		03.96-05.99	109-113				Fg.-Nr. LV12*2-104600→		
						LAB	F 01G 09F 0EU <sup>4</sup>		
						RAB	F 01G 09F 0EH <sup>4</sup>		
<b>MPV [LW]</b>									
	2.0D Turbo	03.02-06.04	100						F 026 A03 485 <sup>7</sup>
							Fg.-Nr. →309637		
							Fg.-Nr. 309638→		
								0 986 134 065	← 43 F 026 A03 485 <sup>7</sup>
								0 986 135 065	→ 43 F 026 A03 485 <sup>7</sup>
	2.0i 16V	06.99-04.02	90					0 986 134 065	← 43 F 026 A03 485 <sup>7</sup>
								0 986 135 065	→ 43 F 026 A03 485 <sup>7</sup>
	2.3i	03.02-06.04	104				Fg.-Nr. →309637		F 026 A03 485 <sup>7</sup>
							Fg.-Nr. 309638→		
								0 986 134 065	← 43 F 026 A03 485 <sup>7</sup>
								0 986 135 065	→ 43 F 026 A03 485 <sup>7</sup>
	2.5i	06.99→	129			AG,BSB			F 026 A03 485 <sup>7</sup>
						BSB,GS			F 026 A03 485 <sup>7</sup>
	2.5i 24V	05.99-04.02	125					0 986 134 065	← 43 F 026 A03 485 <sup>7</sup>
								0 986 135 065	→ 43 F 026 A03 485 <sup>7</sup>
	3.0i	05.02-08.04	147				Fg.-Nr. →309637		F 026 A03 485 <sup>7</sup>
							Fg.-Nr. 309638→		
								0 986 134 065	← 43 F 026 A03 485 <sup>7</sup>
								0 986 135 065	→ 43 F 026 A03 485 <sup>7</sup>





		S				?			
◀ MAZDA MPV [LW]									
	2.0D Turbo, i 16V	06.99-06.04	90/100				F 026 A09 605	↔	
	2.3 i	03.02-06.04	104				F 026 A09 605	↔	
	2.5 i, i 24V	05.99→	125/129				F 026 A09 605	↔	
	3.0 i	05.02-08.04	147				F 026 A09 605	↔	
MX-3 [EC]									
	1.6 i	11.93-02.98	79-81				0986 475 866	↔ 19	
MX-5 [NA]									
	1.6 i 16V	ABO 12.94-11.97	66				0986 473 170	← 51,05	
							0986 474 170	→ 51,05	
	1.8 i	12.94-11.97	96-98				0986 473 133	← 51,05	
							0986 474 133	→ 51,05	
	1.6 i 16V	12.94-11.97	66		LAB		F 01G 09F 0FY <sup>4</sup>		
					RAB		F 01G 09F 09M <sup>3</sup>		
							F 01G 09F 0FZ <sup>4</sup>		
							F 01G 09F 09N <sup>3</sup>		
	1.8 i	09.93-11.97	96-98		LAB		F 01G 09F 0FY <sup>4</sup>		
					RAB		F 01G 09F 09M <sup>3</sup>		
							F 01G 09F 0FZ <sup>4</sup>		
							F 01G 09F 09N <sup>3</sup>		
MX-5 [NB]									
	1.6 i	09.00-07.05	81		SPF				F 026 A03 482 <sup>7</sup>
					SPN		0986 473 133	← 51,05	
							0986 474 133	→ 51,05	
	1.8 i	09.00-07.05	103-106/107-113						F 026 A03 482 <sup>7</sup>
	1.6 i	01.98-08.00	81				0986 134 060	← 32	
							0986 135 060	→ 32	
	1.8 i	01.98-08.00	103-106				0986 134 060	← 32	
							0986 135 060	→ 32	
	1.6 i	01.98-07.05	81				1987 482 055	← 1143	
							1987 482 056	→ 1143	
	1.8 i	01.98-07.05	103-106				1987 482 055	← 1143	
							1987 482 056	→ 1143	
		09.00-07.05	107-113				1987 482 055	→ 1143	
							1987 482 056	← 1143	
	1.6 i	01.98-07.05	81	Fg.-Nr. →412421	LAB		F 01G 09F 0AF <sup>3</sup>		
					RAB		F 01G 09F 0HC <sup>4</sup>		
							F 01G 09F 0AG <sup>3</sup>		
							F 01G 09F 0HD <sup>4</sup>		
	1.8 i	01.98-07.05	103-106	Fg.-Nr. →412421	LAB		F 01G 09F 0AF <sup>3</sup>		
					RAB		F 01G 09F 0HC <sup>4</sup>		
							F 01G 09F 0AG <sup>3</sup>		
							F 01G 09F 0HD <sup>4</sup>		



		S							
1.8i		09.00-07.05	107-113			LAB	F 01G 09F 0AF <sup>3</sup>		
						RAB	F 01G 09F 0HC <sup>4</sup>		
							F 01G 09F 0AG <sup>3</sup>		
							F 01G 09F 0HD <sup>4</sup>		
<b>MX-5 [NC]</b>									
	1.8	07.05→	93						F 026 A03 482 <sup>7</sup>
	2.0	07.05→	118						F 026 A03 482 <sup>7</sup>
<b>MX-6 [GE]</b>									
	2.0i	07.91-06.94	85				0 986 473 042	← 57,1	F 026 A03 465 <sup>7</sup>
							0 986 474 042	→ 57,1	F 026 A03 465 <sup>7</sup>
	2.5i	07.91-06.97	121-123				0 986 473 042	← 57,1	F 026 A03 465 <sup>7</sup>
	2.5i 4WS						0 986 474 042	→ 57,1	F 026 A03 465 <sup>7</sup>
	2.0i	06.93-06.97	85	Fg.-Nr. →GE***477075			0 986 475 661	↔ 17,4	
				Fg.-Nr. GE***477075→			0 986 475 947	↔ 17,46	
	2.5i	07.94-06.97	121		TW		0 986 475 661	↔ 17,4	
	2.5i 4WS						0 986 475 947	↔ 17,46	
	2.0i	07.91-06.94	85				0 986 473 041	← 30,2	
							0 986 474 041	→ 30,2	
	2.5i	07.91-06.94	121-123				0 986 473 041	← 30,2	
	2.5i 4WS						0 986 474 041	→ 30,2	
	2.5i	07.94-06.97	121		SBR		1 987 477 501	→ 1657	
	2.5i 4WS						1 987 477 502	← 1657	
	2.5i 4WS	08.91-06.94	121-123				1 987 477 503	252	
<b>Premacy [CP]</b>									
	1.8i	03.99-05.05	74/84			5SP	0 986 473 042	← 57,1	F 026 A03 465 <sup>7</sup>
							0 986 474 042	→ 57,1	F 026 A03 465 <sup>7</sup>
						7SP			F 026 A03 465 <sup>7</sup>
	2.0D Turbo	06.99-05.05	66/74			5SP	0 986 473 042	← 57,1	F 026 A03 465 <sup>7</sup>
							0 986 474 042	→ 57,1	F 026 A03 465 <sup>7</sup>
						7SP			F 026 A03 465 <sup>7</sup>
	2.0i	11.01-05.05	96						F 026 A03 465 <sup>7</sup>
	1.8i	03.99-05.05	74/84				F 026 002 387	↔ 20,64	
	2.0D Turbo	06.99-10.01	66				F 026 002 387	↔ 20,64	
	1.8i	03.99-05.05	74/84			7SP	0 986 473 074	← 34,8	
							0 986 474 074	→ 34,8	
	2.0D Turbo	06.99-05.05	66/74/96			7SP	0 986 473 074	← 34,8	
	2.0i						0 986 474 074	→ 34,8	
	1.8i	03.99-05.05	74/84				1 987 477 503	252	
	2.0D Turbo, i	06.99-05.05	66/74/96				1 987 477 503	252	

























































		S							
◀ MAZDA									
<b>RX-7 Coupé [FD]</b>									
	<b>Biturbo</b>	01.92→	176-177/ 204						F 026 <b>A06 206</b> <sup>7</sup>
	<b>Biturbo</b>	01.92-07.94	176		LAB	F 01G <b>09F 0P2</b> <sup>4</sup>			
					RAB	F 01G <b>09F 0D2</b> <sup>3</sup>			
						F 01G <b>09F 0P3</b> <sup>4</sup>			
						F 01G <b>09F 02E</b> <sup>3</sup>			
		08.93-02.96	176-177		LAB	F 01G <b>09F 0P2</b> <sup>4</sup>			
						F 01G <b>09F 02J</b> <sup>3</sup>			
					RAB	F 01G <b>09F 0P3</b> <sup>4</sup>			
						F 01G <b>09F 02K</b> <sup>3</sup>			
		01.96→	204		LAB	F 01G <b>09F 0P2</b> <sup>4</sup>			
						F 01G <b>09F 0D2</b> <sup>3</sup>			
					RAB	F 01G <b>09F 0P3</b> <sup>4</sup>			
						F 01G <b>09F 02E</b> <sup>3</sup>			
<b>RX-8 [FE]</b>									
		04.08-04.12	141-151/ 170		FEN				F 026 <b>A03 482</b> <sup>7</sup>
					SPF				F 026 <b>A03 482</b> <sup>7</sup>
<b>RX-8 [SE]</b>									
		04.03-04.08	141/170		FEN				F 026 <b>A03 482</b> <sup>7</sup>
					SPF				F 026 <b>A03 482</b> <sup>7</sup>
<b>Serie B [UF]</b>									
	<b>2200</b>	03.96-05.99	68			F 026 <b>A02 327</b>	←		
						F 026 <b>A02 328</b>	→		
	<b>2500 12V D</b>	03.96-05.99	57-63			F 026 <b>A02 327</b>	←		
	<b>2500 12V D 4x4</b>					F 026 <b>A02 328</b>	→		
	<b>2600 i 12V 4x4</b>	03.96-05.99	92			F 026 <b>A02 327</b>	←		
						F 026 <b>A02 328</b>	→		
<b>Serie B [UN]</b>									
	<b>2200</b>	02.99-03.06	60-68			0 204 <b>772 021</b>	←	F 026 <b>A06 094</b> <sup>7</sup>	
						0 204 <b>772 022</b>	→	F 026 <b>A06 094</b> <sup>7</sup>	
	<b>2200 4x4</b>	06.99-03.06	68			0 204 <b>776 785</b>	←	F 026 <b>A06 094</b> <sup>7</sup>	
						0 204 <b>776 786</b>	→	F 026 <b>A06 094</b> <sup>7</sup>	
	<b>2500 D Turbo 4x4</b>	02.99-07.02	64-80			0 204 <b>776 785</b>	←	F 026 <b>A06 094</b> <sup>7</sup>	
						0 204 <b>776 786</b>	→	F 026 <b>A06 094</b> <sup>7</sup>	
		08.02-03.06	64-80					F 026 <b>A03 551</b> <sup>7</sup>	
	<b>2500 D Turbo 4x4</b>	02.99-07.02	57/62			0 204 <b>776 785</b>	←	F 026 <b>A06 094</b> <sup>7</sup>	
	<b>2500 D 4x4</b>					0 204 <b>776 786</b>	→	F 026 <b>A06 094</b> <sup>7</sup>	
		08.02-03.06	57/62					F 026 <b>A03 551</b> <sup>7</sup>	
	<b>2500 D</b>	02.99-03.06	57/62			0 204 <b>772 021</b>	←	F 026 <b>A06 094</b> <sup>7</sup>	
	<b>2500 D Turbo</b>					0 204 <b>772 022</b>	→	F 026 <b>A06 094</b> <sup>7</sup>	
	<b>2600 4x4</b>	02.99-03.06	90			0 204 <b>776 785</b>	←	F 026 <b>A06 094</b> <sup>7</sup>	
						0 204 <b>776 786</b>	→	F 026 <b>A06 094</b> <sup>7</sup>	



		S							
	<b>2200</b>	02.99-03.06	60-68				F 026 <b>A02 389</b>	↔	
	<b>2200 4x4</b>	06.99-03.06	60-68				F 026 <b>A02 389</b>	↔	
	<b>2500 D</b>	02.99-03.06	57/62/64-80				F 026 <b>A02 389</b>	↔	
	<b>2500 D Turbo</b>	09.01-03.06	57/62/64-80				F 026 <b>A02 389</b>	↔	
	<b>2500 D Turbo 4x4</b>	02.99-03.06	57/62/64-80				F 026 <b>A02 389</b>	↔	
	<b>2500 D 4x4</b>	02.99-03.06	57/62/64-80				F 026 <b>A02 389</b>	↔	
	<b>2600 4x4</b>	02.99-03.06	90				F 026 <b>A02 389</b>	↔	
<b>Serie E</b>									
	<b>2.2 D</b>	03.97-12.01	52						F 026 <b>A03 485</b> <sup>7</sup>
	<b>2.2 D 4WD</b>								
	<b>2.0</b>	07.89-09.94	60-63				F 026 <b>A02 213</b>	→	
							F 026 <b>A02 214</b>	←	
		07.89-03.95	60-65		OZB		F 026 <b>A02 213</b>	→	
							F 026 <b>A02 214</b>	←	
					ZWB		F 026 <b>A02 215</b>	→	
							F 026 <b>A02 216</b>	←	
	<b>2.0i</b>	08.91-04.97	70				F 026 <b>A02 213</b>	→	
							F 026 <b>A02 214</b>	←	
	<b>2.2 D</b>	07.89-04.97	44-47				F 026 <b>A02 213</b>	→	
							F 026 <b>A02 214</b>	←	
					OZB		F 026 <b>A02 213</b>	→	
							F 026 <b>A02 214</b>	←	
					ZWB		F 026 <b>A02 215</b>	→	
							F 026 <b>A02 216</b>	←	
		08.99-12.01	52				F 026 <b>A02 388</b>	↔	
	<b>2.2 D 4WD</b>	07.89-04.97	44-47				F 026 <b>A02 213</b>	→	
							F 026 <b>A02 214</b>	←	
		03.97-12.01	52	Fg.-Nr. →SR1*108899			F 026 <b>A02 388</b>	↔	
	<b>2.2 D</b>	08.99-12.01	52		LAB		F 01G <b>09F 0B2</b> <sup>3</sup>		
							F 01G <b>09F 0GS</b> <sup>4</sup>		
					RAB		F 01G <b>09F 0B3</b> <sup>3</sup>		
							F 01G <b>09F 0GT</b> <sup>4</sup>		
<b>Tribute</b>									
	<b>2.0i</b>	12.00→	97				F 026 <b>A02 355</b>	↔	
	<b>3.0i</b>	12.00→	150				F 026 <b>A02 355</b>	↔	
<b>Tribute [EP]</b>									
	<b>2.0i</b>	02.01-12.03	91						F 026 <b>A06 097</b> <sup>7</sup>
	<b>2.0i 4x4</b>								
<b>Xedos-6 [CA]</b>									
	<b>1.6i</b>	01.92-05.94	83-85				0 986 <b>473 041</b>	← 30,2	
							0 986 <b>474 041</b>	→ 30,2	
	<b>2.0i</b>	01.92-03.94	105-108				0 986 <b>473 041</b>	← 30,2	
							0 986 <b>474 041</b>	→ 30,2	

















































									
◀ MAZDA Xedos-6 [CA]									
									
	1.6 i	01.92-05.94	83-85			1987 477 501	→ 1657		
						1987 477 502	← 1657		
	2.0 i	01.92-03.94	105-108			1987 477 501	→ 1657		
						1987 477 502	← 1657		
<b>2 [DE]</b>									
									
	1.3	06.07→	55/62-63			0986 475 668	↔ 19		
	1.4 CD	08.07-09.10	50			0986 475 668	↔ 19		
	1.5	06.07→	75-76			0986 475 668	↔ 19		
	1.6 CD	11.08→	66/70			0986 475 668	↔ 19		
									
	1.3	06.07-11.07	55/62-63	Fg.-Nr. →133959		1987 482 421	408		
		06.07→	55/62-63			1987 482 278	↔ 162		
	1.4 CD	08.07-11.07	50	Fg.-Nr. →133959		1987 482 421	408		
		08.07-09.10	50			1987 482 278	↔ 162		
	1.5	06.07-11.07	75-76	Fg.-Nr. →133959		1987 482 421	408		
		06.07→	75-76			1987 482 278	↔ 162		
	1.6 CD	11.08→	66/70			1987 482 422	1360		
						MI	1987 482 422	1360	
		1.3	06.07→	55/62-63			0 265 007 992 <sup>3</sup>		
							0 265 007 994 <sup>4</sup>		
		1.4 CD	08.07-09.10	50			0 265 007 992 <sup>3</sup>		
							0 265 007 994 <sup>4</sup>		
1.5		06.07→	75-76			0 265 007 992 <sup>3</sup>			
						0 265 007 994 <sup>4</sup>			
1.6 CD		11.08→	66/70			0 265 007 992 <sup>3</sup>			
						0 265 007 994 <sup>4</sup>			
<b>2 [DY]</b>									
									
		1.4	02.03-06.07	50/59			0986 473 275	👁️ ← 54	
		1.4 D Turbo					0986 474 275	👁️ → 54	
	1.6	02.03-06.07	74			0986 473 275	👁️ ← 54		
						0986 474 275	👁️ → 54		
	1.25	02.03-06.07	55			0986 473 275	👁️ ← 54		
					0986 474 275	👁️ → 54			
									
	1.4, D Turbo	02.03-06.07	50/59			0986 475 926	↔ 19,05		
	1.6	02.03-06.07	74			0986 475 926	↔ 19,05		
	1.25	02.03-06.07	55			0986 475 926	↔ 19,05		
									
	1.4	02.03-06.07	50/59			1987 477 906	175		
	1.4 D Turbo					MI	1987 477 732	1445	
							1987 477 906	175	
	1.6	02.03-06.07	74			MI	1987 477 732	1445	
							1987 477 906	175	
1.25	02.03-06.07	55			MI	1987 477 732	1445		

		S							
<b>3 [BK]</b>									
									
	<b>1.6</b> 1.6 MZ-CD	07.03-12.08	77/80	Fg.-Nr. →566436	0 986 <b>473 385</b>	 ← 56,95	F 026 <b>A06 153</b> <sup>7</sup>		
				Fg.-Nr. 566437→	0 986 <b>474 385</b>	 → 56,95	F 026 <b>A06 153</b> <sup>7</sup>		
	<b>2.0</b> 2.0 MZR-CD	07.03-12.08	105/110	Fg.-Nr. →566436	0 986 <b>473 385</b>	 ← 56,95	F 026 <b>A06 153</b> <sup>7</sup>		
				Fg.-Nr. 566437→	0 986 <b>474 385</b>	 → 56,95	F 026 <b>A06 153</b> <sup>7</sup>		
									
	<b>1.6</b>	07.03-12.08	77	Fg.-Nr. →BK1***734267, →BK2***385282, →BK3***385282, →BK4***385282	0 986 <b>473 173</b>	 ← 37,93	F 026 <b>A06 133</b> <sup>7</sup>		
				Fg.-Nr. BK1***734268→, BK2***385283→, BK3***385283→, BK4***385283→	0 986 <b>474 173</b>	 → 37,93	F 026 <b>A06 133</b> <sup>7</sup>		
	<b>1.6</b> MZ-CD	12.03-12.08	80		0 986 <b>473 173</b>	 ← 37,93	F 026 <b>A06 133</b> <sup>7</sup>		
					0 986 <b>474 173</b>	 → 37,93	F 026 <b>A06 133</b> <sup>7</sup>		
	<b>2.0</b> 2.0 MZR-CD	07.03-12.08	105/110		0 986 <b>473 173</b>	 ← 37,93	F 026 <b>A06 133</b> <sup>7</sup>		
					0 986 <b>474 173</b>	 → 37,93	F 026 <b>A06 133</b> <sup>7</sup>		
									
	<b>1.6</b>	07.03-03.06	77	Fg.-Nr. →555548	1 987 <b>482 057</b>	→ 1875			
					1 987 <b>482 058</b>	← 1831			
		07.03-12.08	77	Fg.-Nr. BK1...	1 987 <b>482 420</b>	1910			
	<b>1.6</b> MZ-CD	12.03-03.06	80	Fg.-Nr. →555548	1 987 <b>482 057</b>	→ 1875			
					1 987 <b>482 058</b>	← 1831			
		12.03-12.08	80		1 987 <b>482 420</b>	1910			
	<b>2.0</b>	07.03-03.06	110	Fg.-Nr. →555548	1 987 <b>482 057</b>	→ 1875			
					1 987 <b>482 058</b>	← 1831			
		07.03-12.08	110		1 987 <b>482 420</b>	1910			
	<b>2.0</b> MZR-CD	12.06-12.08	105	Fg.-Nr. →555548	1 987 <b>482 057</b>	→ 1875			
					1 987 <b>482 058</b>	← 1831			
<b>3 [BL]</b>									
									
	<b>1.6</b> MZR, MZR-CD	12.08→	77/80-81/85						F 026 <b>A06 153</b> <sup>7</sup>
	<b>2.0</b> MZR, MZR DISI	12.08→	110/111						F 026 <b>A06 153</b> <sup>7</sup>
	<b>2.2</b> MZR-CD	01.09-07.11	110/136						F 026 <b>A06 153</b> <sup>7</sup>
									
	<b>1.6</b> MZR, MZR-CD	12.08→	77/80-81/85						F 026 <b>A06 133</b> <sup>7</sup>
	<b>2.0</b> MZR, MZR DISI	12.08→	110/111						F 026 <b>A06 133</b> <sup>7</sup>
	<b>2.2</b> MZR-CD	01.09-07.11	110/136						F 026 <b>A06 133</b> <sup>7</sup>
									
	<b>1.6</b> MZR, MZR-CD	12.08→	77/80-81/85		1 987 <b>482 420</b>	1910			
	<b>2.0</b> MZR, MZR DISI	12.08→	110/111		1 987 <b>482 420</b>	1910			
	<b>2.2</b> MZR-CD	01.09-07.11	110/136		1 987 <b>482 420</b>	1910			
<b>3 Hatchback [BK]</b>									
									
	<b>1.4</b>	08.03-12.08	59	Fg.-Nr. →566436	0 986 <b>473 385</b>	 ← 56,95	F 026 <b>A06 153</b> <sup>7</sup>		
				Fg.-Nr. 566437→	0 986 <b>474 385</b>	 → 56,95	F 026 <b>A06 153</b> <sup>7</sup>		
									F 026 <b>A06 153</b> <sup>7</sup>



		S				?			
	<b>MAZDA 3 Hatchback [BK]</b>								
	1.6	10.03-12.08	66/77/80	Fg.-Nr. →566436	0986 473 385		← 56,95	F 026 A06 153 <sup>7</sup>	
	1.6 MZ-CD			Fg.-Nr. 566437→	0986 474 385		→ 56,95	F 026 A06 153 <sup>7</sup>	
	2.0	07.03-12.08	105/110	Fg.-Nr. →566436	0986 473 385		← 56,95	F 026 A06 153 <sup>7</sup>	
	2.0 MZR-CD			Fg.-Nr. 566437→	0986 474 385		→ 56,95	F 026 A06 153 <sup>7</sup>	
	1.4	08.03-12.08	59		0986 473 173		← 37,93	F 026 A06 133 <sup>7</sup>	
	1.6	10.03-12.08	77	Fg.-Nr. →BK1***734267, →BK2***385282, →BK3***385282, →BK4***385282	0986 473 173		← 37,93	F 026 A06 133 <sup>7</sup>	
				Fg.-Nr. BK1***734268→, BK2***385283→, BK3***385283→, BK4***385283→				F 026 A06 133 <sup>7</sup>	
	1.6 MZ-CD	12.03-12.08	80		0986 473 173		← 37,93	F 026 A06 133 <sup>7</sup>	
		10.05-12.08	66		0986 474 173		→ 37,93	F 026 A06 133 <sup>7</sup>	
	2.0	07.03-12.08	110		0986 473 173		← 37,93	F 026 A06 133 <sup>7</sup>	
	2.0 MZR-CD	12.06-12.08	105		0986 474 173		→ 37,93	F 026 A06 133 <sup>7</sup>	
				Fg.-Nr. →147119	0986 473 173		← 37,93		
				Fg.-Nr. 139606→	0986 474 173		→ 37,93		F 026 A06 133 <sup>7</sup>
	2.3 MPS	07.06-12.08	184-191		0986 473 173		← 37,93	F 026 A06 133 <sup>7</sup>	
					0986 474 173		→ 37,93	F 026 A06 133 <sup>7</sup>	
	1.4	08.03-03.06	59	Fg.-Nr. →555548	1987 482 057		→ 1875		
		08.03-12.08	59		1987 482 058		← 1831		
	1.6	10.03-03.06	77	Fg.-Nr. →555548	1987 482 057		→ 1875		
		10.03-12.08	77	Fg.-Nr. BK1...	1987 482 058		← 1831		
	1.6 MZ-CD	12.03-03.06	80	Fg.-Nr. →555548	1987 482 420		→ 1910		
		12.03-12.08	80		1987 482 057		→ 1875		
		10.05-03.06	66	Fg.-Nr. →555548	1987 482 058		← 1831		
		10.05-12.08	66		1987 482 420		→ 1910		
	2.0	07.03-03.06	110	Fg.-Nr. →555548	1987 482 057		→ 1875		
		07.03-12.08	110		1987 482 058		← 1831		
					1987 482 420		→ 1910		
<b>3 Hatchback [BL]</b>									
	1.6 MZR, MZR-CD	12.08→	77/80-81/85					F 026 A06 153 <sup>7</sup>	
	2.0 MZR, MZR DISI	12.08→	110/111					F 026 A06 153 <sup>7</sup>	
	2.2 MZR-CD	01.09-10.13	110/136					F 026 A06 153 <sup>7</sup>	
	1.6 MZR, MZR-CD	12.08→	77/80-81/85					F 026 A06 133 <sup>7</sup>	
	2.0 MZR, MZR DISI	12.08→	110/111					F 026 A06 133 <sup>7</sup>	
	2.2 MZR-CD	01.09-10.13	110/136					F 026 A06 133 <sup>7</sup>	
	2.3 MPS	09.09-10.13	191					F 026 A06 133 <sup>7</sup>	

								
								
	1.6 MZR, MZR-CD	12.08→	77/80-81/85			1 987 482 420	1910	
	2.0 MZR, MZR DISI	12.08→	110/111			1 987 482 420	1910	
	2.2 MZR-CD	01.09-10.13	110/136			1 987 482 420	1910	
	2.3 MPS	09.09-10.13	191			1 987 482 420	1910	
<b>5 [CR]</b>								
								
	1.8	02.05-12.10	85	Fg.-Nr. →183516		0 986 473 385	 56,95	F 026 A06 153 <sup>7</sup>
				Fg.-Nr. 183517→		0 986 474 385	 56,95	F 026 A06 153 <sup>7</sup>
								F 026 A06 153 <sup>7</sup>
	2.0	02.05-12.10	81/	Fg.-Nr. →183516		0 986 473 385	 56,95	F 026 A06 153 <sup>7</sup>
	2.0 CD		101-107			0 986 474 385	 56,95	F 026 A06 153 <sup>7</sup>
				Fg.-Nr. 183517→				F 026 A06 153 <sup>7</sup>
								
	1.8	02.05-12.10	85			1 987 482 052	 1810	
						1 987 482 053	 1828	
	2.0	02.05-12.10	81/101-107			1 987 482 052	 1810	
	2.0 CD					1 987 482 053	 1828	
<b>5 [CW]</b>								
								
	1.6 CD	06.10→	85					F 026 A06 153 <sup>7</sup>
	1.8	06.10→	85					F 026 A06 153 <sup>7</sup>
	2.0, DISI	06.10→	106/110					F 026 A06 153 <sup>7</sup>
<b>6 Fastback [GG/GY]</b>								
								
	1.8	04.02-08.07	88					F 026 A03 484 <sup>7</sup>
	2.0, D Turbo	04.02-08.07	89/100-108					F 026 A03 484 <sup>7</sup>
	2.3	04.02-08.08	122		15Z,16Z,B17			F 026 A03 484 <sup>7</sup>
								
	1.8	04.02-08.07	88			0 986 473 207	 35	F 026 A06 096 <sup>7</sup>
						0 986 474 207	 35	F 026 A06 096 <sup>7</sup>
	2.0	04.02-08.07	89/100-108			0 986 473 207	 35	F 026 A06 096 <sup>7</sup>
	2.0 D Turbo					0 986 474 207	 35	F 026 A06 096 <sup>7</sup>
	2.3	04.02-08.08	122		15Z,16Z, B17	0 986 473 207	 35	F 026 A06 096 <sup>7</sup>
						0 986 474 207	 35	F 026 A06 096 <sup>7</sup>
								
	1.8	04.02-08.07	88			1 987 482 054	1640	
	2.0, D Turbo	04.02-08.07	89/100-108			1 987 482 054	1640	
	2.3	04.02-08.08	122			1 987 482 054	1640	
<b>6 Fastback [GH]</b>								
								
	1.8 MZR	08.07-12.12	88			0 986 473 207	 35	F 026 A06 096 <sup>7</sup>
						0 986 474 207	 35	F 026 A06 096 <sup>7</sup>
	2.0 MZR, MZR DISI, MZR-CD	08.07-12.12	103/108/ 114			0 986 473 207	 35	F 026 A06 096 <sup>7</sup>
						0 986 474 207	 35	F 026 A06 096 <sup>7</sup>
	2.2 MZR-CD	01.09-12.12	92/95/120/ 132/136			0 986 473 207	 35	F 026 A06 096 <sup>7</sup>
						0 986 474 207	 35	F 026 A06 096 <sup>7</sup>
	2.5 MZR	08.07-12.12	125			0 986 473 207	 35	F 026 A06 096 <sup>7</sup>
						0 986 474 207	 35	F 026 A06 096 <sup>7</sup>





		S				?			
◀ MAZDA									
<b>6 [GG/GY]</b>									
	2.3	02.02-08.07	122			15Z,16Z, B17			F 026 <b>A03 484</b> <sup>7</sup>
	2.3	02.02-08.07	122			15Z,16Z, B17	0986 <b>473 207</b>	← 35	F 026 <b>A06 096</b> <sup>7</sup>
							0986 <b>474 207</b>	→ 35	F 026 <b>A06 096</b> <sup>7</sup>
	2.3	02.02-08.07	122				1987 <b>482 054</b>	1640	
<b>6 [GH]</b>									
	1.8 MZR	08.07-12.12	88				0986 <b>473 207</b>	← 35	F 026 <b>A06 096</b> <sup>7</sup>
							0986 <b>474 207</b>	→ 35	F 026 <b>A06 096</b> <sup>7</sup>
	2.0 MZR, MZR DISI, MZR-CD	08.07-12.12	103/108/ 114				0986 <b>473 207</b>	← 35	F 026 <b>A06 096</b> <sup>7</sup>
							0986 <b>474 207</b>	→ 35	F 026 <b>A06 096</b> <sup>7</sup>
	2.2 MZR-CD	01.09-12.12	92/95/120/ 132/136				0986 <b>473 207</b>	← 35	F 026 <b>A06 096</b> <sup>7</sup>
							0986 <b>474 207</b>	→ 35	F 026 <b>A06 096</b> <sup>7</sup>
	2.5 MZR	08.07-12.12	125				0986 <b>473 207</b>	← 35	F 026 <b>A06 096</b> <sup>7</sup>
							0986 <b>474 207</b>	→ 35	F 026 <b>A06 096</b> <sup>7</sup>
<b>6 Sedan [GG/GY]</b>									
	1.8	02.02-08.07	88						F 026 <b>A03 484</b> <sup>7</sup>
	2.0, D Turbo	02.02-08.07	89/100-108						F 026 <b>A03 484</b> <sup>7</sup>
	1.8	02.02-08.07	88				0986 <b>473 207</b>	← 35	F 026 <b>A06 096</b> <sup>7</sup>
							0986 <b>474 207</b>	→ 35	F 026 <b>A06 096</b> <sup>7</sup>
	2.0	02.02-08.07	89/100-108				0986 <b>473 207</b>	← 35	F 026 <b>A06 096</b> <sup>7</sup>
	2.0 D Turbo						0986 <b>474 207</b>	→ 35	F 026 <b>A06 096</b> <sup>7</sup>
	1.8	02.02-08.07	88				1987 <b>482 054</b>	1640	
	2.0, D Turbo	02.02-08.07	89/100-108				1987 <b>482 054</b>	1640	
<b>6 Wagon [GG/GY]</b>									
	1.8	06.02-12.07	88						F 026 <b>A03 484</b> <sup>7</sup>
	2.0, D Turbo	06.02-12.07	89/100-108						F 026 <b>A03 484</b> <sup>7</sup>
	2.3	06.02-12.07	122			15Z,16Z,B17			F 026 <b>A03 484</b> <sup>7</sup>
	2.3 4x4	08.02-12.07	119						F 026 <b>A03 484</b> <sup>7</sup>
	1.8	06.02-12.07	88				0986 <b>473 207</b>	← 35	F 026 <b>A06 096</b> <sup>7</sup>
							0986 <b>474 207</b>	→ 35	F 026 <b>A06 096</b> <sup>7</sup>
	2.0	06.02-12.07	89/100-108				0986 <b>473 207</b>	← 35	F 026 <b>A06 096</b> <sup>7</sup>
	2.0 D Turbo						0986 <b>474 207</b>	→ 35	F 026 <b>A06 096</b> <sup>7</sup>
	2.3	06.02-12.07	122			15Z,16Z, B17	0986 <b>473 207</b>	← 35	F 026 <b>A06 096</b> <sup>7</sup>
							0986 <b>474 207</b>	→ 35	F 026 <b>A06 096</b> <sup>7</sup>



























































		S							
2.3 4x4		08.02-12.07	119				0 986 473 207	35	F 026 A06 096 <sup>7</sup>
							0 986 474 207	35	F 026 A06 096 <sup>7</sup>
	1.8	06.02-12.07	88				1 987 482 054	1640	
	2.0, D Turbo	06.02-12.07	89/100-108				1 987 482 054	1640	
	2.3	06.02-12.07	122				1 987 482 054	1640	
<b>6 Wagon [GH]</b>									
	1.8 MZR	12.07-12.12	88				0 986 473 207	35	F 026 A06 096 <sup>7</sup>
							0 986 474 207	35	F 026 A06 096 <sup>7</sup>
	2.0 MZR, MZR DISI, MZR-CD	12.07-12.12	103/108/ 114				0 986 473 207	35	F 026 A06 096 <sup>7</sup>
							0 986 474 207	35	F 026 A06 096 <sup>7</sup>
	2.2 MZR-CD	10.08-12.12	92/95/120/ 132/136				0 986 473 207	35	F 026 A06 096 <sup>7</sup>
							0 986 474 207	35	F 026 A06 096 <sup>7</sup>
	2.5 MZR	12.07-12.12	125				0 986 473 207	35	F 026 A06 096 <sup>7</sup>
							0 986 474 207	35	F 026 A06 096 <sup>7</sup>
<b>121 [DB]</b>									
	1.1	11.93-12.95	40				0 986 475 840	15,9	
	1.3i	11.93-11.97	44/54/55				0 986 475 840	15,9	
		ABO 11.93-12.95	39-40/53-56				0 986 475 840	15,9	
<b>121 [JA/JB]</b>									
	1.3i	01.96-01.02	37/44				0 986 473 897	48	
							0 986 473 898	48	
	1.8D	01.96-01.02	44				0 986 473 897	48	
							0 986 473 898	48	
	1.25 i 16V	01.96-01.02	55		AG		0 986 473 909	54	
							0 986 473 910	54	
					GS		0 986 473 897	48	
							0 986 473 898	48	
	1.3i	01.96-01.02	37/44				F 026 002 502	17,5	
	1.8D	01.96-01.02	44				F 026 002 502	17,5	
	1.25 i 16V	01.96-01.02	55		GS		F 026 002 502	17,5	
	1.3i	01.96-01.02	37/44		SAZ		1 987 477 345	1640	
					TW		1 987 477 517	312	
	1.8D	01.96-01.02	44		SAZ		1 987 477 345	1640	
					TW		1 987 477 517	312	
	1.25 i 16V	01.96-01.02	55		SAZ		1 987 477 345	1640	
					TW		1 987 477 517	312	
	1.3i	01.96-01.02	37/44			EFV	0 986 594 023 <sup>3</sup>		
	1.8D	01.96-01.02	44			EFV	0 986 594 023 <sup>3</sup>		
	1.25 i 16V	01.96-01.02	55			EFV	0 986 594 023 <sup>3</sup>		

















		S				?			
◀ MAZDA									
<b>121 [Soho]</b>									
	1.3 i	05.97-12.98	44				0986 473 897		← 48
							0986 473 898		→ 48
	1.4 i	10.98-12.00	55				0986 473 897		← 48
							0986 473 898		→ 48
	1.3 i	05.97-12.98	44				F 026 002 502		↔ 17,5
	1.4 i	10.98-12.00	55				F 026 002 502		↔ 17,5
<b>323 Astina [BA]</b>									
	1.8 i	10.96-06.98	92						F 026 A03 460 <sup>7</sup>
<b>323 [BA]</b>									
	1.6 i	08.95-09.96	78	Fg.-Nr. →BA11*-100848					F 026 A03 460 <sup>7</sup>
				Fg.-Nr. BA11*-100848→					F 026 A03 460 <sup>7</sup>
<b>323 [BG]</b>									
	1.6	04.91-12.95	64				0986 473 127		← 53,93
							0986 474 127		→ 53,93
	1.8 i	04.91-05.94	76				0986 473 127		← 53,93
							0986 474 127		→ 53,93
	1.6	04.91-12.95	64	Fg.-Nr. →BG10*2-150324					F 026 A03 456 <sup>7</sup>
				Fg.-Nr. BG10*2-150324→					F 026 A03 456 <sup>7</sup>
	1.8 i	04.91-05.94	76	Fg.-Nr. →BG10*2-150324					F 026 A03 456 <sup>7</sup>
				Fg.-Nr. BG10*2-150324→					F 026 A03 456 <sup>7</sup>
<b>323 [BJ]</b>									
	1.3 i	05.98-09.03	54						F 026 A03 482 <sup>7</sup>
	1.5 i	05.98-10.00	65						F 026 A03 482 <sup>7</sup>
	1.6 i	07.98-10.00	79						F 026 A03 482 <sup>7</sup>
		10.00-09.03	70-72				0986 473 042		← 57,1 F 026 A03 465 <sup>7</sup>
							0986 474 042		→ 57,1 F 026 A03 465 <sup>7</sup>
	1.8 i	05.98-09.03	84/92				0986 473 042		← 57,1 F 026 A03 465 <sup>7</sup>
							0986 474 042		→ 57,1 F 026 A03 465 <sup>7</sup>
	2.0 D, D Turbo, i	05.98-09.03	52/66/74/ 96				0986 473 042		← 57,1 F 026 A03 465 <sup>7</sup>
							0986 474 042		→ 57,1 F 026 A03 465 <sup>7</sup>
	1.3 i	05.98-10.00	54				0986 475 947		↔ 17,46
	1.5 i	05.98-10.00	65				0986 475 947		↔ 17,46
	1.6 i	07.98-11.00	78/79				0986 475 947		↔ 17,46
	2.0 D, D Turbo	05.98-10.00	52/66				0986 475 947		↔ 17,46
	1.6 i	10.00-09.03	70-72				0986 473 074		← 34,8
							0986 474 074		→ 34,8



								
<b>1.8i</b>	07.98-11.00	92						F 026 A03 4607
	01.01-09.03	84				0 986 473 074	 34,8	
						0 986 474 074	 34,8	
<b>2.0D Turbo</b>	09.00-09.03	74/96				0 986 473 074	 34,8	
<b>2.0i</b>						0 986 474 074	 34,8	
								
	<b>1.3i</b>	05.98-10.00	54			1 987 482 153	 1660	
						1 987 482 154	 1640	
		05.98-09.03	54			1 987 477 503	252	
		10.00-09.03	54		STB	1 987 482 153	 1660	
						1 987 482 154	 1640	
	<b>1.5i</b>	05.98-10.00	65			1 987 477 503	252	
						1 987 482 153	 1660	
						1 987 482 154	 1640	
	<b>1.6i</b>	07.98-10.00	79			1 987 477 503	252	
						1 987 482 153	 1660	
						1 987 482 154	 1640	
		07.98-11.00	78			1 987 482 153	 1660	
						1 987 482 154	 1640	
		10.00-09.03	70-72			1 987 477 503	252	
					STB	1 987 482 153	 1660	
						1 987 482 154	 1640	
					4SB	1 987 477 916	 1715	
						1 987 477 917	 1693	
	<b>1.8i</b>	05.98-09.03	84			1 987 477 503	252	
						1 987 477 916	 1715	
						1 987 477 917	 1693	
		07.98-11.00	92			1 987 477 916	 1715	
						1 987 477 917	 1693	
		01.01-09.03	84		4SB	1 987 477 916	 1715	
						1 987 477 917	 1693	
	<b>2.0D Turbo</b>	09.00-09.03	74/96			1 987 477 503	252	
	<b>2.0i</b>				4SB	1 987 477 916	 1715	
						1 987 477 917	 1693	
	<b>2.0D</b>	05.98-10.00	52/66			1 987 477 503	252	
	<b>2.0D Turbo</b>					1 987 482 153	 1660	
						1 987 482 154	 1640	
<b>323 F Hatchback [BA]</b>								
								
	<b>1.5i</b>	05.94-07.98	65-66/81			0 986 475 866	 19	
	<b>1.8i</b>	08.94-07.98	84-85/99			0 986 475 866	 19	
	<b>2.0i</b>	05.94-07.98	106-108			0 986 475 866	 19	
<b>323 Hatchback [BA]</b>								
								
	<b>P 1.3i</b>	10.96-09.00	54-55			0 986 473 039	 54	
						0 986 474 039	 54	
	<b>P 1.5i</b>	10.96-09.00	65			0 986 473 127	 53,93	
						0 986 474 127	 53,93	
	<b>1.5i</b>	06.94-07.98	65-71			0 986 473 127	 53,93	
						0 986 474 127	 53,93	
								
	<b>P 1.3i</b>	ABO 10.96-09.00	54-55			0 986 475 947	 17,46	
		ABS 10.96-09.00	54-55			0 986 475 866	 19	
	<b>P 1.5i</b>	ABO 10.96-09.00	65			0 986 475 947	 17,46	
		ABS 10.96-09.00	65			0 986 475 866	 19	



		S							
	◀ MAZDA 323 Hatchback [BA]								
	<b>P.2.0 D</b>	ABO 03.97-09.00	52				0986 475 947	↔	17,46
		ABS 03.97-09.00	52				0986 475 866	↔	19
	<b>1.3 i</b>	06.94-11.96	54-55				0986 475 866	↔	19
	<b>1.5 i</b>	06.94-11.96	65-71				0986 475 866	↔	19
		ABO 11.96-07.98	65				0986 475 947	↔	17,46
		ABS 11.96-07.98	65				0986 475 866	↔	19
	<b>1.8 i</b>	08.94-11.96	84-85				0986 475 866	↔	19
		ABO 11.96-04.98	99				0986 475 947	↔	17,46
		ABS 11.96-04.98	99				0986 475 866	↔	19
	<b>1.8 i Astina</b>	10.96-06.98	92						F 026 A03 460 <sup>7</sup>
<b>323 Hatchback [BF]</b>									
	<b>1.6 i</b>	05.87-12.97	61				0986 475 660	↔	17,4
<b>323 Hatchback [BG]</b>									
	<b>1.3 i 16V</b>	03.91-05.96	54-55/58				0986 473 039	↔	54
	<b>1.3 16V</b>						0986 474 039	↔	54
					AG		0986 473 127	↔	53,93
							0986 474 127	↔	53,93
	<b>1.6 i 16V</b>	03.91-07.94	65-66				0986 473 127	↔	53,93
							0986 474 127	↔	53,93
	<b>1.6 16V</b>	03.91-07.94	64				0986 473 039	↔	54
							0986 474 039	↔	54
					AG		0986 473 127	↔	53,93
							0986 474 127	↔	53,93
	<b>1.7 D</b>	04.91-02.96	43				0986 473 039	↔	54
							0986 474 039	↔	54
					AG		0986 473 127	↔	53,93
							0986 474 127	↔	53,93
	<b>1.8 i</b>	04.91-05.94	76				0986 473 127	↔	53,93
							0986 474 127	↔	53,93
	<b>1.8 i 16V</b>	03.91-05.94	76-78				0986 473 039	↔	54
							0986 474 039	↔	54
					AG		0986 473 127	↔	53,93
							0986 474 127	↔	53,93
	<b>1.8 i 16V 4x4</b>	06.91-05.94	76-78				0986 473 127	↔	53,93
							0986 474 127	↔	53,93
	<b>1.3 i 16V, 16V</b>	03.91-05.96	54-55/58				0986 475 661	↔	17,4
	<b>1.6 16V</b>	03.91-07.94	64				0986 475 661	↔	17,4
	<b>1.7 D</b>	04.91-02.96	43				0986 475 661	↔	17,4
	<b>1.8 i 16V</b>	03.91-05.94	76-78				0986 475 661	↔	17,4
	<b>1.8 i</b>	04.91-05.94	76/92			Fg.-Nr. →BG10*2-150324			F 026 A03 456 <sup>7</sup>
	<b>1.8 i 16V</b>					Fg.-Nr. BG10*2-150324→			F 026 A03 456 <sup>7</sup>
	<b>1.8 i 16V</b>	03.91-07.94	94-96				0986 473 040	↔	30,2
							0986 474 040	↔	30,2
	<b>1.3 i 16V</b>	03.91-05.96	54-55/58				1987 477 492	→	1466
	<b>1.3 16V</b>						1987 477 493	←	1503
							1987 477 494	→	1498
							1987 477 495	←	1468

								
1.6 16V	03.91-07.94	64				1 987 477 492	→ 1466	
						1 987 477 493	← 1503	
						1 987 477 494	→ 1498	
						1 987 477 495	← 1468	
1.7 D	04.91-02.96	43				1 987 477 492	→ 1466	
						1 987 477 493	← 1503	
						1 987 477 494	→ 1498	
						1 987 477 495	← 1468	
1.8 i 16V	03.91-05.94	76-78				1 987 477 492	→ 1466	
						1 987 477 493	← 1503	
						1 987 477 494	→ 1498	
						1 987 477 495	← 1468	
<b>323 Hatchback [BJ]</b>								
								
	1.3 i	06.98-09.03	54					F 026 A03 482 <sup>7</sup>
	1.5 i	06.98-01.01	65					F 026 A03 482 <sup>7</sup>
	1.6 i	10.00-09.03	70-72			0 986 473 042	↻ ← 57,1	F 026 A03 465 <sup>7</sup>
						0 986 474 042	↻ → 57,1	F 026 A03 465 <sup>7</sup>
	1.8 i	06.98→	84/92			0 986 473 042	↻ ← 57,1	F 026 A03 465 <sup>7</sup>
						0 986 474 042	↻ → 57,1	F 026 A03 465 <sup>7</sup>
	2.0 D, D Turbo, i	06.98→	52/66/74/ 96/98			0 986 473 042	↻ ← 57,1	F 026 A03 465 <sup>7</sup>
						0 986 474 042	↻ → 57,1	F 026 A03 465 <sup>7</sup>
								
	P 1.3 i	09.98-10.00	54			0 986 475 947	↔ 17,46	
	P 1.5 i	09.98-10.00	65			0 986 475 947	↔ 17,46	
	1.3 i	06.98-01.01	54			0 986 475 947	↔ 17,46	
	1.5 i	06.98-01.01	65			0 986 475 947	↔ 17,46	
	1.6 i	07.98→	78			0 986 475 947	↔ 17,46	
	2.0 D, D Turbo	06.98-01.01	52/66			0 986 475 947	↔ 17,46	
	1.6 i	10.00-09.03	70-72			0 986 473 074	↻ ← 34,8	
						0 986 474 074	↻ → 34,8	
	1.8 i	07.98→	92					F 026 A03 460 <sup>7</sup>
		12.00-09.03	84			0 986 473 074	↻ ← 34,8	
						0 986 474 074	↻ → 34,8	
	2.0 D Turbo	10.00-09.03	74/96			0 986 473 074	↻ ← 34,8	
	2.0 i					0 986 474 074	↻ → 34,8	
	2.0 i	12.00→	98					F 026 A03 460 <sup>7</sup>
								
	P 1.3 i	09.98-10.00	54			1 987 477 503	252	
						1 987 482 153	→ 1660	
						1 987 482 154	← 1640	
	P 1.5 i	09.98-10.00	65			1 987 477 503	252	
						1 987 482 153	→ 1660	
						1 987 482 154	← 1640	
	1.3 i	06.98-01.01	54			1 987 482 153	→ 1660	
						1 987 482 154	← 1640	
		06.98-09.03	54			1 987 477 503	252	
		10.00-09.03	54		STB	1 987 482 153	→ 1660	
						1 987 482 154	← 1640	
	1.5 i	06.98-01.01	65			1 987 477 503	252	
						1 987 482 153	→ 1660	
						1 987 482 154	← 1640	
	1.6 i	07.98→	78			1 987 482 153	→ 1660	
						1 987 482 154	← 1640	
		10.00-09.03	70-72			1 987 477 503	252	





<b>MAZDA 323 Hatchback [BJ]</b>											
1.6 i	10.00-09.03	70-72	STB	1987 482 153	→ 1660						
				1987 482 154	← 1640						
1.8 i	06.98-01.01	84	4SB	1987 477 916	→ 1715						
				1987 477 917	← 1693						
				1987 477 916	→ 1715						
				1987 477 917	← 1693						
				06.98-09.03	84	1987 477 503	252				
				07.98-→	92	1987 477 916	→ 1715				
2.0 D Turbo 2.0 i	10.00-09.03	74/96	4SB	1987 477 916	→ 1715						
				1987 477 917	← 1693						
				1987 477 503	252						
				1987 477 916	→ 1715						
				1987 477 917	← 1693						
				06.98-01.01	52/66	1987 477 503	252				
2.0 D 2.0 D Turbo	10.00-09.03	74/96	4SB	1987 477 916	→ 1715						
				1987 477 917	← 1693						
				1987 482 153	→ 1660						
				1987 482 154	← 1640						
2.0 i	12.00-→	98	4SB	1987 477 916	→ 1715						
				1987 477 917	← 1693						

**323 Sedan [BA]**







































1.3 i	06.94-09.96	54-55	ABO	0986 475 866	↔ 19					
				10.96-06.98	54-55	0986 475 947	↔ 17,46			
				10.96-06.98	54-55	0986 475 866	↔ 19			
1.5 i	06.94-09.96	65-71	ABS	0986 475 866	↔ 19					
				10.96-06.98	65	0986 475 947	↔ 17,46			
				10.96-06.98	65	0986 475 866	↔ 19			
1.7 D Turbo	08.95-12.96	60-62	ABO	0986 475 866	↔ 19					
1.8 i	08.94-09.96	84-85	ABO	0986 475 866	↔ 19					
				10.96-06.98	99	0986 475 947	↔ 17,46			
				10.96-06.98	99	0986 475 866	↔ 19			
2.0 D	03.97-06.98	52	ABS	0986 475 947	↔ 17,46					
				03.97-06.98	52	0986 475 866	↔ 19			

**323 Sedan [BF]**

1.6 i	05.87-12.97	61	ABO	0986 475 660	↔ 17,4				

**323 Sedan [BG]**

1.3 i 16V 1.3 16V	04.91-05.96	54-55/58	AG	0986 473 039	↔ 54				
				0986 474 039	↔ 54				
1.6 i 16V	03.91-02.97	65-66	AG	0986 473 127	↔ 53,93				
				0986 474 127	↔ 53,93				
			GS	0986 473 039	↔ 54				
				0986 474 039	↔ 54				
1.6 16V	03.91-07.94	64	AG	0986 473 039	↔ 54				
				0986 474 039	↔ 54				
			AG	0986 473 127	↔ 53,93				
				0986 474 127	↔ 53,93				
1.7 D	03.91-05.94	43	AG	0986 473 039	↔ 54				
				0986 474 039	↔ 54				
			AG	0986 473 127	↔ 53,93				
				0986 474 127	↔ 53,93				







































		S							
									
1.8i 16V		04.91-07.94	76-78				0 986 473 127	 ← 53,93	
1.8i 16V 4x4							0 986 474 127	 → 53,93	
									
									
1.3i 16V, 16V		04.91-05.96	54-55/58				0 986 475 661	↔ 17,4	
1.6i 16V, 16V		03.91-02.97	64/65-66				0 986 475 661	↔ 17,4	
1.7D		03.91-05.94	43				0 986 475 661	↔ 17,4	
1.8i 16V		04.91-07.94	76-78				0 986 475 661	↔ 17,4	
									
									
1.3i 16V		04.91-05.96	54-55/58				1 987 477 492	→ 1466	
1.3i 16V							1 987 477 493	← 1503	
1.6i 16V		03.91-02.97	65-66		STB		1 987 477 492	→ 1466	
							1 987 477 493	← 1503	
1.6i 16V		03.91-07.94	64				1 987 477 492	→ 1466	
							1 987 477 493	← 1503	
1.7D		03.91-05.94	43				1 987 477 492	→ 1466	
							1 987 477 493	← 1503	
1.8i 16V		04.91-07.94	76-78		STB		1 987 477 492	→ 1466	
							1 987 477 493	← 1503	
<b>323 Wagon [BW]</b>									
									
									
1.5		09.89-06.95	54				0 986 473 037	 ← 51	
							0 986 474 037	 → 51	
1.6i		09.89-10.95	63-66				0 986 473 037	 ← 51	
1.6i 4x4							0 986 474 037	 → 51	
1.7D		09.89-06.95	41				0 986 473 037	 ← 51	
							0 986 474 037	 → 51	
									
									
1.5		09.89-06.95	54				0 986 475 660	↔ 17,4	
1.6i		09.89-10.95	63-66				0 986 475 660	↔ 17,4	
1.7D		09.89-06.95	41				0 986 475 660	↔ 17,4	
<b>626 Fastback [GF]</b>									
									
									
1.8i 16V		08.99-06.00	66/74				0 986 473 042	 ← 57,1	F 026 A03 465 <sup>7</sup>
							0 986 474 042	 → 57,1	F 026 A03 465 <sup>7</sup>
2.0i 16V		08.99-04.02	74/85/100				0 986 473 042	 ← 57,1	F 026 A03 465 <sup>7</sup>
2.0 16V D Turbo							0 986 474 042	 → 57,1	F 026 A03 465 <sup>7</sup>
									
									
1.8i 16V		08.99-06.00	66/74				1 987 477 503	252	
							1 987 477 916	→ 1715	
							1 987 477 917	← 1693	
2.0i 16V		08.99-04.02	74/85/100				1 987 477 503	252	
2.0 16V D Turbo							1 987 477 916	→ 1715	
							1 987 477 917	← 1693	
<b>626 [GE]</b>									
									
									
1.8i 16V		08.91-03.97	66/77				0 986 473 042	 ← 57,1	F 026 A03 465 <sup>7</sup>
							0 986 474 042	 → 57,1	F 026 A03 465 <sup>7</sup>
2.0 D Complex, i 16V, i 16V 4x4		08.91-06.97	55/85-86				0 986 473 042	 ← 57,1	F 026 A03 465 <sup>7</sup>
							0 986 474 042	 → 57,1	F 026 A03 465 <sup>7</sup>























		S							
	<b>MAZDA 626 [GE]</b>								
	2.5 i 24V	04.92-06.97	121				0986 473 042	← 57,1	F 026 A03 4657
							0986 474 042	→ 57,1	F 026 A03 4657
	1.8 i 16V	08.91-03.97	66/77	Fg.-Nr. GE****433619→ GE****477075			0986 475 661	↔ 17,4	
				Fg.-Nr. GE****477075→			0986 475 947	↔ 17,46	
	2.0 D Comprex	03.92-03.97	55	Fg.-Nr. GE****433619→ GE****477075			0986 475 661	↔ 17,4	
				Fg.-Nr. GE****477075→			0986 475 947	↔ 17,46	
	2.0 i 16V	08.91-03.97	85-86	Fg.-Nr. GE****433619→ GE****477075			0986 475 661	↔ 17,4	
				Fg.-Nr. GE****477075→			0986 475 947	↔ 17,46	
		06.94-06.97	85-86		TW		0986 475 661	↔ 17,4	
							0986 475 947	↔ 17,46	
	2.5 i 24V	06.94-06.97	121		TW		0986 475 661	↔ 17,4	
							0986 475 947	↔ 17,46	
	1.8 i 16V	08.91-05.94	77				0986 473 041	← 30,2	
							0986 474 041	→ 30,2	
		08.91-03.97	77	Fg.-Nr. →GE****408282, →GE12J2 802741			0986 473 041	← 30,2	
							0986 474 041	→ 30,2	
		06.94-03.97	66	Fg.-Nr. →GE****408282, →GE12J2 802741			0986 473 041	← 30,2	
							0986 474 041	→ 30,2	
	2.0 D Comprex	08.91-05.94	55/85-86				0986 473 041	← 30,2	
	2.0 i 16V						0986 474 041	→ 30,2	
		08.91-03.97	55/85-86	Fg.-Nr. →GE****408282, →GE12J2 802741			0986 473 041	← 30,2	
							0986 474 041	→ 30,2	
	2.5 i 24V	04.92-05.94	121				0986 473 041	← 30,2	
							0986 474 041	→ 30,2	
	1.8 i 16V	08.91-05.94	77				1987 477 501	→ 1657	
							1987 477 502	← 1657	
		05.94-03.97	77		SBR		1987 477 501	→ 1657	
							1987 477 502	← 1657	
		06.94-03.97	66		SBR		1987 477 501	→ 1657	
							1987 477 502	← 1657	
	2.0 D Comprex	03.92-05.94	55				1987 477 502	← 1657	
		06.94-03.97	55		4SB		1987 477 502	← 1657	
	2.0 i 16V	08.91-05.94	85-86				1987 477 501	→ 1657	
							1987 477 502	← 1657	
		05.94-06.97	85-86		SBR		1987 477 501	→ 1657	
							1987 477 502	← 1657	
	2.5 i 24V	04.92-05.94	121	Fg.-Nr. GE1***-100222→ GE1***-106178			1987 477 502	← 1657	
				Fg.-Nr. GE1***-106178→			1987 477 501	→ 1657	
							1987 477 502	← 1657	
		06.94-06.97	121		SBR		1987 477 501	→ 1657	
							1987 477 502	← 1657	
	<b>626 [GF]</b>								
	1.8 i 16V	05.97-09.99	66-67				0986 473 042	← 57,1	F 026 A03 4657
							0986 474 042	→ 57,1	F 026 A03 4657
		09.99-06.00	66				0986 473 042	← 57,1	
							0986 474 042	→ 57,1	
		09.99-03.02	74				0986 473 042	← 57,1	
							0986 474 042	→ 57,1	



		S							
<b>1.8 16V</b>							0 986 473 042	 ← 57,1	F 026 A03 465 <sup>7</sup>
							0 986 474 042	 → 57,1	F 026 A03 465 <sup>7</sup>
<b>2.0i 16V</b>			05.97-09.99	85			0 986 473 042	 ← 57,1	F 026 A03 465 <sup>7</sup>
			06.97-10.99	93			0 986 474 042	 → 57,1	F 026 A03 465 <sup>7</sup>
			09.97-09.99	100			0 986 473 042	 ← 57,1	F 026 A03 465 <sup>7</sup>
			11.98-04.02	100			0 986 474 042	 → 57,1	F 026 A03 465 <sup>7</sup>
			09.99-06.00				0 986 473 042	 ← 57,1	
			09.99-04.02	85			0 986 474 042	 → 57,1	
							0 986 473 042	 ← 57,1	
							0 986 474 042	 → 57,1	
<b>2.0 16V</b>			11.97-09.99	85			0 986 473 042	 ← 57,1	F 026 A03 465 <sup>7</sup>
							0 986 474 042	 → 57,1	F 026 A03 465 <sup>7</sup>
<b>2.0 16V D Turbo</b>			04.98-09.99	74			0 986 473 042	 ← 57,1	F 026 A03 465 <sup>7</sup>
			09.99-07.02	74			0 986 474 042	 → 57,1	F 026 A03 465 <sup>7</sup>
			10.00-07.02	81			0 986 473 042	 ← 57,1	
							0 986 474 042	 → 57,1	
									
	<b>1.8i 16V, 16V</b>		05.97-09.99	66-67			F 026 002 387	↔ 20,64	
	<b>2.0i 16V, 16V, 16V D Turbo</b>		05.97-09.99	74/85/100			F 026 002 387	↔ 20,64	
	<b>1.8i 16V</b>		05.97-09.99	66-67			0 986 473 074	 ← 34,8	
	<b>1.8 16V</b>						0 986 474 074	 → 34,8	
	<b>2.0i 16V, 16V, 16V D Turbo</b>		05.97-09.99	74/85/100			0 986 473 074	 ← 34,8	
							0 986 474 074	 → 34,8	
									
	<b>1.8i 16V</b>		05.97-09.99	66-67		SBR	1 987 477 503	252	
							1 987 477 916	→ 1715	
							1 987 477 917	← 1693	
			09.99-06.00	66			1 987 477 503	252	
							1 987 477 916	→ 1715	
							1 987 477 917	← 1693	
			09.99-03.02	74			1 987 477 503	252	
							1 987 477 916	→ 1715	
							1 987 477 917	← 1693	
	<b>2.0i 16V</b>		05.97-09.99	85		SBR	1 987 477 916	→ 1715	
							1 987 477 917	← 1693	
			05.97-04.02	85			1 987 477 503	252	
			06.97-04.02	93/100			1 987 477 503	252	
							1 987 477 916	→ 1715	
							1 987 477 917	← 1693	
			09.99-04.02	85			1 987 477 916	→ 1715	
							1 987 477 917	← 1693	
	<b>2.0i 16V</b>		09.99-07.02	74/81			1 987 477 503	252	
	<b>2.0 16V D Turbo</b>						1 987 477 916	→ 1715	
							1 987 477 917	← 1693	
<b>626 Hatchback [GE]</b>									
									
	<b>1.8i 16V</b>		09.91-03.97	66/77			0 986 473 042	 ← 57,1	F 026 A03 465 <sup>7</sup>
							0 986 474 042	 → 57,1	F 026 A03 465 <sup>7</sup>
	<b>2.0 D Complex, i 16V, i 16V 4x4</b>		09.91-06.97	55/85-86			0 986 473 042	 ← 57,1	F 026 A03 465 <sup>7</sup>
							0 986 474 042	 → 57,1	F 026 A03 465 <sup>7</sup>



		S							
	<b>MAZDA 626 Hatchback [GE]</b>								
	2.5 i, i 24V, i 24V 4WS	09.91-06.97	121-123				0986 473 042	← 57,1	F 026 A03 4657
							0986 474 042	→ 57,1	F 026 A03 4657
	1.8 i 16V	06.94-03.97	66/77	Fg.-Nr. GE****433619→ GE****477075			0986 475 661	↔ 17,4	
				Fg.-Nr. GE****477075→			0986 475 947	↔ 17,46	
	2.0 D Comprex	06.94-03.97	55	Fg.-Nr. GE****433619→ GE****477075			0986 475 661	↔ 17,4	
				Fg.-Nr. GE****477075→			0986 475 947	↔ 17,46	
	2.0 i 16V	06.94-03.97	85-86	Fg.-Nr. GE****433619→ GE****477075			0986 475 661	↔ 17,4	
		06.94-06.97	85-86	Fg.-Nr. GE****477075→	TW		0986 475 661	↔ 17,4	
							0986 475 947	↔ 17,46	
	2.5 i 24V	06.94-06.97	121		TW		0986 475 661	↔ 17,4	
							0986 475 947	↔ 17,46	
	1.8 i 16V	09.91-03.97	66/77				0986 473 041	← 30,2	
							0986 474 041	→ 30,2	
	2.0 D Comprex	09.91-03.97	55/85-86				0986 473 041	← 30,2	
	2.0 i 16V						0986 474 041	→ 30,2	
	2.5 i, i 24V, i 24V 4WS	09.91-06.97	121-123				0986 473 041	← 30,2	
							0986 474 041	→ 30,2	
	1.8 i 16V	09.91-03.97	66/77				1987 477 501	→ 1657	
							1987 477 502	← 1657	
	2.0 D Comprex	03.92-03.97	55				1987 477 501	→ 1657	
							1987 477 502	← 1657	
	2.0 i 16V	09.91-03.97	85-86				1987 477 501	→ 1657	
		06.94-06.97	85-86		SBR		1987 477 501	→ 1657	
							1987 477 502	← 1657	
	2.5 i	11.91-05.94	121	Fg.-Nr. GE1***-100222→ GE1***-106178			1987 477 502	← 1657	
				Fg.-Nr. GE1***-106178→			1987 477 501	→ 1657	
							1987 477 502	← 1657	
	2.5 i 24V	06.94-03.97	121				1987 477 501	→ 1657	
		06.94-06.97	121		SBR		1987 477 501	→ 1657	
							1987 477 502	← 1657	
	2.5 i 24V	09.91-05.94	121-123				1987 477 501	→ 1657	
	2.5 i 24V 4WS						1987 477 502	← 1657	
	<b>626 Hatchback [GF]</b>								
	1.8 i 16V	04.97-09.99	66-67				0986 473 042	← 57,1	F 026 A03 4657
	1.8 16V						0986 474 042	→ 57,1	F 026 A03 4657
	2.0 i 16V	04.97-10.99	85/93/100				0986 473 042	← 57,1	F 026 A03 4657
	2.0 16V						0986 474 042	→ 57,1	F 026 A03 4657
	2.0 16V D Turbo	04.98-08.99	66				0986 473 042	← 57,1	F 026 A03 4657
		10.00-07.02	81				0986 474 042	→ 57,1	F 026 A03 4657
							0986 473 042	← 57,1	
							0986 474 042	→ 57,1	
	1.8 i 16V, 16V	04.97-09.99	66-67				F 026 002 387	↔ 20,64	
	2.0 i 16V, 16V	04.97-10.99	85/93/100				F 026 002 387	↔ 20,64	

		S							
<b>2.0 16V D Turbo</b>									
		04.98-08.99	66				F 026 <b>002 387</b>	↔ 20,64	
		10.00-07.02	81				F 026 <b>002 387</b>	↔ 20,64	
									
<b>1.8 i 16V</b>									
		04.97-09.99	66-67				1 987 <b>477 503</b>	252	
	<b>1.8 16V</b>					SBR	1 987 <b>477 916</b>	→ 1715	
							1 987 <b>477 917</b>	← 1693	
<b>2.0 i 16V</b>									
		04.97-09.99	100				1 987 <b>477 503</b>	252	
						SBR	1 987 <b>477 916</b>	→ 1715	
							1 987 <b>477 917</b>	← 1693	
		05.97-10.99	93				1 987 <b>477 503</b>	252	
							1 987 <b>477 916</b>	→ 1715	
							1 987 <b>477 917</b>	← 1693	
<b>2.0 i 16V</b>									
		04.97-08.99	85				1 987 <b>477 503</b>	252	
<b>2.0 16V</b>									
						SBR	1 987 <b>477 916</b>	→ 1715	
							1 987 <b>477 917</b>	← 1693	
<b>2.0 16V D Turbo</b>									
		04.98-08.99	66				1 987 <b>477 503</b>	252	
							1 987 <b>477 916</b>	→ 1715	
							1 987 <b>477 917</b>	← 1693	
		10.00-07.02	81				1 987 <b>477 503</b>	252	
							1 987 <b>477 916</b>	→ 1715	
							1 987 <b>477 917</b>	← 1693	
<b>626 Wagon [GV]</b>									
									
<b>2.0 D, D Complex, i, i 16V</b>									
		03.92-10.97	55/60/66/103				1 987 <b>477 747</b>	← 1702	
	<b>2.2i</b>	03.92-10.97	85				1 987 <b>477 747</b>	← 1702	
<b>626 Wagon [GW]</b>									
									
<b>1.8 i 16V</b>									
		10.97-10.99	66				0 986 <b>473 042</b>	↔ 57,1	F 026 <b>A03 465</b> <sup>7</sup>
							0 986 <b>474 042</b>	↔ 57,1	F 026 <b>A03 465</b> <sup>7</sup>
		10.99-04.02	74			Fg.-Nr. →020201			F 026 <b>A03 465</b> <sup>7</sup>
						Fg.-Nr. 020201→			F 026 <b>A03 465</b> <sup>7</sup>
<b>2.0 D Turbo, 16V D Turbo</b>									
		05.98-04.02	66/74/81						F 026 <b>A03 465</b> <sup>7</sup>
<b>2.0 i 16V</b>									
		10.97-11.99	85				0 986 <b>473 042</b>	↔ 57,1	F 026 <b>A03 465</b> <sup>7</sup>
							0 986 <b>474 042</b>	↔ 57,1	F 026 <b>A03 465</b> <sup>7</sup>
			100-100				0 986 <b>473 042</b>	↔ 57,1	F 026 <b>A03 465</b> <sup>7</sup>
							0 986 <b>474 042</b>	↔ 57,1	F 026 <b>A03 465</b> <sup>7</sup>
		11.99-04.02	85			Fg.-Nr. →020201			F 026 <b>A03 465</b> <sup>7</sup>
						Fg.-Nr. 020201→			F 026 <b>A03 465</b> <sup>7</sup>
			100			Fg.-Nr. →020201			F 026 <b>A03 465</b> <sup>7</sup>
						Fg.-Nr. 020201→			F 026 <b>A03 465</b> <sup>7</sup>
									
<b>1.8 i 16V</b>									
		10.97-04.02	66/74				0 986 <b>473 074</b>	↔ 34,8	
							0 986 <b>474 074</b>	↔ 34,8	
<b>2.0 D Turbo, i 16V, 16V D Turbo</b>									
		10.97-04.02	66/74/81/ 85/100-100				0 986 <b>473 074</b>	↔ 34,8	
							0 986 <b>474 074</b>	↔ 34,8	
									
<b>1.8 i 16V</b>									
		10.97-04.02	66/74				1 987 <b>477 503</b>	252	
<b>2.0 D Turbo, i 16V, 16V D Turbo</b>									
		10.97-04.02	66/74/81/85/100-100				1 987 <b>477 503</b>	252	



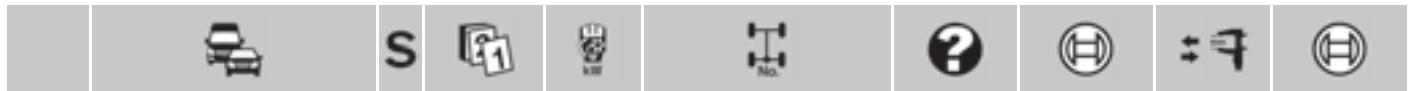

**MERCEDES-BENZ**

**Citan [415]**

	108 CDI	07.12→	55		F 026 <b>002 573</b>	↔ 22,2
	109 CDI	07.12→	66		F 026 <b>002 573</b>	↔ 22,2
	112	08.13→	84		F 026 <b>002 573</b>	↔ 22,2

**Classe A [168]**

	190	09.00-09.02	92	Fg.-Nr. →A 044865	1987 <b>477 691</b>	→ 739
		09.00-08.05	92	Fg.-Nr. →A 044865	1987 <b>482 538</b>	← 1062
	190	09.00-08.05	92		0 265 <b>006 372</b> <sup>4</sup>	
				LAB	0 265 <b>006 370</b> <sup>3</sup>	
				RAB	0 265 <b>006 368</b> <sup>3</sup>	

**MB**

	100	01.87-04.96	43		0 204 <b>102 371</b>	← 48
					0 204 <b>103 371</b>	
					0 986 <b>134 096</b>	
					0 204 <b>102 372</b>	→ 48
					0 204 <b>103 372</b>	
					0 986 <b>135 096</b>	
	100 D	09.91-01.96	55		0 204 <b>102 371</b>	← 48
					0 204 <b>103 371</b>	
					0 986 <b>134 096</b>	
					0 204 <b>102 372</b>	→ 48
					0 204 <b>103 372</b>	
					0 986 <b>135 096</b>	
				Fg.-Nr. BM: 631.349	0 204 <b>102 322</b>	← 52
					0 986 <b>473 199</b>	
					0 204 <b>102 323</b>	→ 52
					0 986 <b>474 199</b>	
	180	01.87-01.96	56		0 204 <b>102 322</b>	← 52
					0 986 <b>473 199</b>	
					0 204 <b>102 323</b>	→ 52
					0 986 <b>474 199</b>	

	100, D	01.87-04.96	43/55		0 986 <b>475 662</b>	↔ 25,4
	180	01.87-01.96	56		0 986 <b>475 662</b>	↔ 25,4

	100	01.87-04.96	43		1987 <b>477 117</b>	1438
					1987 <b>477 326</b>	1416
	100 D	09.91-01.96	55		1987 <b>477 117</b>	1438
				Fg.-Nr. BM:631.332,333,334	1987 <b>477 326</b>	1416
				Fg.-Nr. BM:631.340,342,343,	1987 <b>477 327</b>	1647
				Fg.-Nr. BM:631.344,349		
	180	01.87-01.96	56		1987 <b>477 117</b>	1438
					1987 <b>477 327</b>	1647





**Serie A [168]**

Icon	Model	Start	End	Units	Fig.-Nr.	Part No.	Quantity	Part No.	Quantity
	<b>140</b>	10.97-08.04	60			0 986 473 098	54 ←	1 987 470 287 <sup>7</sup>	
						0 986 474 098	54 →	1 987 470 287 <sup>7</sup>	
		03.01-08.04	60			0 986 473 097	54 ←	1 987 470 287 <sup>7</sup>	
						0 986 474 097	54 →	1 987 470 287 <sup>7</sup>	
	<b>160</b>	10.97-08.04	75			0 986 473 097	54 ←	1 987 470 287 <sup>7</sup>	
						0 986 474 097	54 →	1 987 470 287 <sup>7</sup>	
	<b>160 CDI</b>	09.98-08.04	44/55			0 986 473 098	54 ←	1 987 470 287 <sup>7</sup>	
						0 986 474 098	54 →	1 987 470 287 <sup>7</sup>	
	<b>170 CDI</b>	07.98-08.04	66/70			0 986 473 097	54 ←	1 987 470 287 <sup>7</sup>	
						0 986 474 097	54 →	1 987 470 287 <sup>7</sup>	
	<b>140</b>	10.97-07.98	60	Fg.-Nr. →J 078973		0 986 475 870	19,05 ↔		
		08.98-08.04	60	Fg.-Nr. J 078974→		0 986 475 875	17,8 ↔		
	<b>160</b>	10.97-07.98	75	Fg.-Nr. →J 078973		0 986 475 870	19,05 ↔		
		08.98-08.04	75	Fg.-Nr. J 078974→		0 986 475 875	17,8 ↔		
	<b>160 CDI</b>	09.98-02.01	44			0 986 475 875	17,8 ↔		
	<b>170 CDI</b>	07.98-07.98	66	Fg.-Nr. →J 078973		0 986 475 870	19,05 ↔		
		08.98-02.01	66	Fg.-Nr. J 078974→		0 986 475 875	17,8 ↔		
	<b>160</b>	03.01-08.04	75			0 986 134 033	28 ←		
						0 986 135 033	28 →		
	<b>170 CDI</b>	03.01-08.04	70			0 986 134 033	28 ←		
						0 986 135 033	28 →		
	<b>190</b>	03.99-08.04	92			0 986 134 033	28 ←		
						0 986 135 033	28 →		
	<b>140</b>	10.97-09.99	60	Fg.-Nr. →J 306886		1 987 477 960	987		
						1 987 482 538	1062 ←		
		10.97-08.04	60			1 987 477 691	739 →		
		10.99-08.04	60	Fg.-Nr. J 306887→		1 987 477 692	1056 ←		
						1 987 477 962	987		
		09.00-08.04	60			1 987 477 692	1056 ←		
						1 987 477 962	987		
		03.01-08.04	60			1 987 477 961	1170		
	<b>160</b>	10.97-09.99	75	Fg.-Nr. →J 306886		1 987 477 960	987		
						1 987 482 538	1062 ←		
		10.97-08.04	75			1 987 477 691	739 →		
		10.99-08.04	75	Fg.-Nr. J 306887→		1 987 477 692	1056 ←		
						1 987 477 962	987		
		03.01-08.04	75			1 987 477 801	1038 ←		
						1 987 477 810	685 →		
						1 987 477 961	1170		
	<b>160 CDI</b>	09.98-09.99	44	Fg.-Nr. →J 306886		1 987 477 960	987		
						1 987 482 538	1062 ←		
		09.98-02.01	44			1 987 477 691	739 →		
		10.99-02.01	44	Fg.-Nr. J 306887→		1 987 477 692	1056 ←		
						1 987 477 962	987		
		03.01-08.04	55			1 987 477 691	739 →		
						1 987 477 692	1056 ←		
						1 987 477 962	987		
	<b>170 CDI</b>	07.98-09.99	66	Fg.-Nr. →J 306886		1 987 477 960	987		
						1 987 482 538	1062 ←		
		07.98-02.01	66			1 987 477 691	739 →		
		10.99-02.01	66	Fg.-Nr. J 306887→		1 987 477 692	1056 ←		
						1 987 477 962	987		





**MERCEDES-BENZ Serie A [168]**

<b>170</b> CDI	03.01-08.04	70		1987 477 691	→ 739	
				1987 477 692	← 1056	
<b>190</b>	03.99-09.99	92	Fg.-Nr. →J 306886	1987 477 801	← 1038	
				1987 477 810	→ 685	
				1987 477 961	1170	
	10.99-08.04	92	Fg.-Nr. J 306887→	1987 477 962	987	
				1987 477 809	← 1046	
				1987 477 810	→ 685	
				1987 477 960	987	
	03.01-08.04	92		1987 477 801	← 1038	
				1987 477 810	→ 685	
				1987 477 961	1170	
1987 477 801				← 1038		
<b>210</b> Evolution	03.02-08.04	103		1987 477 801	← 1038	
				1987 477 810	→ 685	
				FKR	1987 477 962	987
				FLR	1987 477 961	1170

**M**

<b>140</b>	10.97-08.04	60		0 265 006 372 <sup>4</sup>	
				LAB	0 265 006 370 <sup>3</sup>
				RAB	0 265 006 368 <sup>3</sup>
<b>160</b>	10.97-08.04	44/55/75		0 265 006 372 <sup>4</sup>	
				LAB	0 265 006 370 <sup>3</sup>
<b>160</b> CDI				RAB	0 265 006 368 <sup>3</sup>
<b>170</b> CDI	07.98-08.04	66/70		0 265 006 372 <sup>4</sup>	
				LAB	0 265 006 370 <sup>3</sup>
				RAB	0 265 006 368 <sup>3</sup>
<b>190</b>	03.99-08.04	92		0 265 006 372 <sup>4</sup>	
				LAB	0 265 006 370 <sup>3</sup>
				RAB	0 265 006 368 <sup>3</sup>
<b>210</b> Evolution	03.02-08.04	103		0 265 006 372 <sup>4</sup>	
				LAB	0 265 006 370 <sup>3</sup>
				RAB	0 265 006 368 <sup>3</sup>

**Serie A [169]**

<b>150</b>	09.04-03.07	70	Fg.-Nr. →J 474114		0 986 473 433	☹ ← 57
					0 986 135 283	☹ →
<b>160</b>	04.07-04.09	70	Fg.-Nr. J 474115→		0 986 474 433	☹ →
					0 986 135 283	☹ →
<b>160</b> CDI	09.04-08.05	60	Fg.-Nr. →J 215300	NON	0 986 135 283	☹ →
					0 986 473 433	☹ ← 57
<b>170</b>	09.04-03.07	85	Fg.-Nr. →J 474114		0 986 134 017	☹ ← 57
					0 986 135 017	☹ → 57
<b>180</b>	04.09-04.12	85			0 986 134 017	☹ ← 57
					0 986 135 017	☹ → 57
<b>180</b> CDI	09.04-03.07	80	Fg.-Nr. →J 474114		0 986 134 017	☹ ← 57
					0 986 135 017	☹ → 57
<b>180</b> CDI	04.07-04.12	80	Fg.-Nr. J 474115→		0 986 134 017	☹ ← 57
					0 986 135 017	☹ → 57

		S										
<b>200</b>		04.04-03.07	100	Fg.-Nr. →J 474114			0 986 <b>134 017</b>		57			
							0 986 <b>135 017</b>		57			
		04.07-04.12	100	Fg.-Nr. J 474115→				0 986 <b>134 017</b>		57		
								0 986 <b>135 017</b>		57		
<b>200 CDI</b>		09.04-04.12	103/142				0 986 <b>134 264</b>		57			
<b>200 Turbo</b>							0 986 <b>135 264</b>		57			
<hr/>												
<b>150</b>		09.04-03.07	70	Fg.-Nr. →J 474114			0 986 <b>473 416</b>					
							0 986 <b>474 416</b>					
		04.07-04.09	70	Fg.-Nr. J 474115→				0 986 <b>473 416</b>				
								0 986 <b>474 416</b>				
		<b>160</b>		04.09-04.12	70				0 986 <b>473 416</b>			
		0 986 <b>474 416</b>										
		<b>160 CDI</b>		09.04-03.07	60	Fg.-Nr. →J 474114			0 986 <b>473 416</b>			
									0 986 <b>474 416</b>			
				04.07-04.12	60	Fg.-Nr. J 474115→				0 986 <b>473 416</b>		
										0 986 <b>474 416</b>		
		<b>170</b>		09.04-04.09	85				0 986 <b>473 416</b>			
		0 986 <b>474 416</b>										
<b>180</b>		04.09-04.12	85				0 986 <b>473 416</b>					
							0 986 <b>474 416</b>					
		<b>180 CDI</b>		09.04-03.07	80	Fg.-Nr. →J 474114			0 986 <b>473 416</b>			
									0 986 <b>474 416</b>			
<b>200</b>		04.07-04.12	80	Fg.-Nr. J 474115→			0 986 <b>473 416</b>					
							0 986 <b>474 416</b>					
<b>200 CDI</b>		04.04-03.07	100/103/ 142	Fg.-Nr. →J 474114			0 986 <b>473 416</b>					
							0 986 <b>474 416</b>					
		<b>200 Turbo</b>		04.07-04.12	100/103/ 142	Fg.-Nr. J 474115→			0 986 <b>473 416</b>			
									0 986 <b>474 416</b>			
<hr/>												
<b>E-Cell</b>		01.11-04.12	50				1 987 <b>477 224</b>		587			
							1 987 <b>477 225</b>		1215			
							1 987 <b>482 490</b>		1130			
		<b>150</b>		09.04-04.09	70				1 987 <b>477 224</b>		587	
									1 987 <b>477 225</b>		1215	
									1 987 <b>482 490</b>		1130	
		<b>160</b>		09.04-04.12	60/70				1 987 <b>477 224</b>		587	
									1 987 <b>477 225</b>		1215	
									1 987 <b>482 490</b>		1130	
		<b>160 CDI</b>		09.04-04.09	85				1 987 <b>477 224</b>		587	
									1 987 <b>477 225</b>		1215	
									1 987 <b>482 490</b>		1130	
		<b>170</b>		09.04-04.12	80/85				1 987 <b>477 224</b>		587	
									1 987 <b>477 225</b>		1215	
									1 987 <b>482 490</b>		1130	
		<b>180</b>		04.04-04.12	100/103/ 142				1 987 <b>477 224</b>		587	
									1 987 <b>477 225</b>		1215	
									1 987 <b>482 490</b>		1130	
		<b>180 CDI</b>		04.04-04.12	100/103/ 142				1 987 <b>477 224</b>		587	
									1 987 <b>477 225</b>		1215	
									1 987 <b>482 490</b>		1130	
		<b>E-Cell</b>		01.11-04.12	50				0 265 <b>007 478</b> <sup>3</sup>			
									0 265 <b>007 480</b> <sup>4</sup>			
									0 265 <b>007 478</b> <sup>3</sup>			
<b>150</b>				09.04-04.09	70				0 265 <b>007 478</b> <sup>3</sup>			
									0 265 <b>007 480</b> <sup>4</sup>			
									0 265 <b>007 478</b> <sup>3</sup>			
<b>160</b>				09.04-04.12	60/70				0 265 <b>007 478</b> <sup>3</sup>			
									0 265 <b>007 480</b> <sup>4</sup>			
									0 265 <b>007 478</b> <sup>3</sup>			
<b>160 CDI</b>				09.04-04.09	85				0 265 <b>007 478</b> <sup>3</sup>			
									0 265 <b>007 480</b> <sup>4</sup>			
									0 265 <b>007 478</b> <sup>3</sup>			
<b>170</b>				09.04-04.12	80/85				0 265 <b>007 478</b> <sup>3</sup>			
									0 265 <b>007 480</b> <sup>4</sup>			
									0 265 <b>007 478</b> <sup>3</sup>			
<b>180</b>				09.04-04.12	80/85				0 265 <b>007 478</b> <sup>3</sup>			
									0 265 <b>007 480</b> <sup>4</sup>			
									0 265 <b>007 478</b> <sup>3</sup>			





			S							
◀ MERCEDES-BENZ Serie A [169]										
		200, CDI, Turbo		04.04-04.12	100/103/ 142			0265 007 478 <sup>3</sup>		
								0265 007 480 <sup>4</sup>		
<b>Serie B [245]</b>										
	150	04.05-03.07 70		Fg.-Nr. →J 249561				0986 134 017		← 57
		04.07-04.09 70		Fg.-Nr. J 249562→				0986 135 017		→ 57
		04.07-04.09 70		Fg.-Nr. J 249562→				0986 134 017		← 57
								0986 135 017		→ 57
160		04.09-04.11 70						0986 134 017		← 57
								0986 135 017		→ 57
170		04.05-03.07 85		Fg.-Nr. →J 249561				0986 134 017		← 57
		04.07-04.09 85		Fg.-Nr. J 249562→				0986 135 017		→ 57
		04.07-04.09 85		Fg.-Nr. J 249562→				0986 134 017		← 57
								0986 135 017		→ 57
170 NGT		05.08-04.09 85						0986 134 264		← 57
								0986 135 264		→ 57
180		04.09-04.11 85						0986 134 017		← 57
								0986 135 017		→ 57
180 CDI		04.05-05.11 80						0986 134 264		← 57
								0986 135 264		→ 57
180 NGT		05.09-04.11 85						0986 134 264		← 57
								0986 135 264		→ 57
200, CDI, Turbo		04.05-05.11 100-103/ 142						0986 134 264		← 57
								0986 135 264		→ 57
	150	04.05-03.07 70		Fg.-Nr. →J 474114				0986 473 416		←
		04.07-04.09 70		Fg.-Nr. J 474115→				0986 474 416		→
		04.07-04.09 70		Fg.-Nr. J 474115→				0986 473 416		←
								0986 474 416		→
160		04.09-04.11 70						0986 473 416		←
								0986 474 416		→
170		04.05-03.07 85		Fg.-Nr. →J 249561				0986 473 416		←
		04.07-04.09 85		Fg.-Nr. J 249562→				0986 474 416		→
		04.07-04.09 85		Fg.-Nr. J 249562→				0986 473 416		←
								0986 474 416		→
170 NGT		05.08-04.09 85						0986 473 416		←
								0986 474 416		→
180		04.09-04.11 85						0986 473 416		←
180 NGT								0986 474 416		→
180 CDI		04.05-03.07 80		Fg.-Nr. →J 249561				0986 473 416		←
		04.07-05.11 80		Fg.-Nr. J 249562→				0986 474 416		→
		04.07-05.11 80		Fg.-Nr. J 249562→				0986 473 416		←
								0986 474 416		→
200		04.05-03.07 100-103/ 142		Fg.-Nr. →J 249561				0986 473 416		←
200 CDI								0986 474 416		→
200 Turbo		04.07-05.11 100-103/ 142		Fg.-Nr. J 249562→				0986 473 416		←
								0986 474 416		→
	150	04.05-04.09 70						1987 477 223		1307
								1987 477 224	←	587
								1987 477 225	→	1215
160		04.09-04.11 70						1987 477 223		1307
								1987 477 224	←	587
								1987 477 225	→	1215
170		04.05-04.09 85						1987 477 223		1307
170 NGT								1987 477 224	←	587
								1987 477 225	→	1215



		S							
<b>180</b>		04.05-05.11	80/85				1 987 477 223	1307	
<b>180 CDI</b>							1 987 477 224	← 587	
<b>180 NGT</b>							1 987 477 225	→ 1215	
<b>200</b>		04.05-05.11	100-103/				1 987 477 223	1307	
<b>200 CDI</b>			142				1 987 477 224	← 587	
<b>200 Turbo</b>							1 987 477 225	→ 1215	
	<b>150</b>	04.05-04.09	70				0 265 007 478 <sup>3</sup>		
	<b>160</b>	04.09-04.11	70				0 265 007 480 <sup>4</sup>		
	<b>170</b>	04.05-04.09	85				0 265 007 478 <sup>3</sup>		
	<b>170 NGT</b>						0 265 007 480 <sup>4</sup>		
	<b>180, CDI, NGT</b>	04.05-05.11	80/85				0 265 007 478 <sup>3</sup>		
							0 265 007 480 <sup>4</sup>		
	<b>200, CDI, Turbo</b>	04.05-05.11	100-103/				0 265 007 478 <sup>3</sup>		
			142				0 265 007 480 <sup>4</sup>		
<b>Serie C (Coupé) [204]</b>									
	<b>180</b>	04.12→	115			SBJ	0 986 134 322	← 60	
							0 986 135 322	→ 60	
	<b>180 CGI</b>	03.11-04.12	115			SBJ,TW	0 986 134 322	← 60	
							0 986 135 322	→ 60	
	<b>200</b>	04.12→	135			SBJ,TW	0 986 134 322	← 60	
							0 986 135 322	→ 60	
	<b>220 CDI</b>	03.11→	120-125			SBJ	0 986 134 322	← 60	
							0 986 135 322	→ 60	
	<b>250 CDI</b>	03.11→	150			SBJ,TW	0 986 134 322	← 60	
	<b>250 CGI</b>						0 986 135 322	→ 60	
	<b>180</b>	04.12→	115				0 986 134 333	← 38	1 987 470 506 <sup>B</sup>
							0 986 135 333	→ 38	1 987 470 506 <sup>B</sup>
	<b>180 CGI</b>	03.11-04.12	115			TW			1 987 470 506 <sup>B</sup>
							0 986 134 333	← 38	1 987 470 506 <sup>B</sup>
							0 986 135 333	→ 38	1 987 470 506 <sup>B</sup>
	<b>200</b>	04.12→	135	Komp.Nr. P84			0 986 134 333	← 38	1 987 470 506 <sup>B</sup>
				Komp.Nr. P84			0 986 135 333	→ 38	1 987 470 506 <sup>B</sup>
	<b>220 CDI</b>	03.11→	120-125				0 986 134 333	← 38	1 987 470 506 <sup>B</sup>
							0 986 135 333	→ 38	1 987 470 506 <sup>B</sup>
	<b>250 CDI</b>	03.11→	150						1 987 470 506 <sup>B</sup>
	<b>250 CGI</b>	03.11→	150				0 986 134 333	← 38	1 987 470 506 <sup>B</sup>
							0 986 135 333	→ 38	1 987 470 506 <sup>B</sup>
	<b>350 CGI</b>	03.11→	225						1 987 470 506 <sup>B</sup>
	<b>63 AMG</b>	03.11→	336/358				1 987 482 301	↔ 728	
						LLE	1 987 482 331	2057	
						MI	1 987 482 332	1152	
						RLE	1 987 482 330	1637	
		06.11→	373/380				1 987 482 329	↔ 743	
						LLE	1 987 482 331	2057	
						MI	1 987 482 332	1152	
						RLE	1 987 482 330	1637	
	<b>180</b>	04.12→	115				1 987 482 301	↔ 728	
	<b>180</b>	03.11→	115			LLE	1 987 482 331	2057	
	<b>180 CGI</b>					MI	1 987 482 332	1152	
						RLE	1 987 482 330	1637	



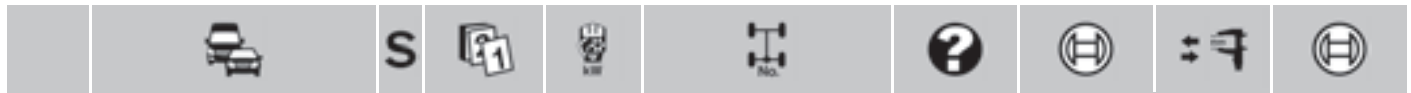

**Mercedes-Benz Serie C (Coupé) [204]**

<b>180 CGI</b>	03.11-04.12	115		1987 <b>482 301</b>	↔ 728
<b>200</b>	04.12→	135		1987 <b>482 301</b>	↔ 728
			LLE	1987 <b>482 331</b>	2057
			MI	1987 <b>482 332</b>	1152
			RLE	1987 <b>482 330</b>	1637
<b>220 CDI</b>	03.11→	120-125		1987 <b>482 301</b>	↔ 728
			LLE	1987 <b>482 331</b>	2057
			MI	1987 <b>482 332</b>	1152
			RLE	1987 <b>482 330</b>	1637
<b>250 CDI</b>	03.11→	150		1987 <b>482 301</b>	↔ 728
<b>250 CDI</b>	03.11→	150	LLE	1987 <b>482 331</b>	2057
<b>250 CGI</b>			MI	1987 <b>482 332</b>	1152
			RLE	1987 <b>482 330</b>	1637
<b>250 CGI</b>	03.11→	150		1987 <b>482 301</b>	↔ 728
<b>350 CGI</b>	03.11→	225		1987 <b>482 301</b>	↔ 728
			LLE	1987 <b>482 331</b>	2057
			MI	1987 <b>482 332</b>	1152
			RLE	1987 <b>482 330</b>	1637





























**Mercedes-Benz Serie C (Sportcoupe) [203]**

<b>63 AMG</b>	03.11→	336/358		0986 <b>594 546<sup>4</sup></b>	
	06.11→	373/380		0265 <b>008 140<sup>4</sup></b>	
<b>180</b>	03.11→	115		0986 <b>594 546<sup>4</sup></b>	
<b>180 CGI</b>				0986 <b>594 548<sup>3</sup></b>	
<b>200</b>	04.12→	135		0986 <b>594 546<sup>4</sup></b>	
				0986 <b>594 548<sup>3</sup></b>	
<b>220 CDI</b>	03.11→	120-125		0986 <b>594 546<sup>4</sup></b>	
				0986 <b>594 548<sup>3</sup></b>	
<b>250 CDI</b>	03.11→	150		0986 <b>594 546<sup>4</sup></b>	
<b>250 CGI</b>				0986 <b>594 548<sup>3</sup></b>	
<b>350 CGI</b>	03.11→	225		0986 <b>594 546<sup>4</sup></b>	
				0986 <b>594 548<sup>3</sup></b>	

**Serie C (Sportcoupe) [203]**

<b>160 KOMPRESSOR</b>	06.05-02.08	90		0986 <b>473 220</b>	← 57
				0986 <b>474 220</b>	→ 57
<b>180</b>	01.01-02.08	95/105		0986 <b>473 220</b>	← 57
<b>180 KOMPRESSOR</b>				0986 <b>474 220</b>	→ 57
<b>200 CDI</b>	03.03-02.08	90	ATP	0986 <b>473 220</b>	← 57
				0986 <b>474 220</b>	→ 57
<b>200 CGI KOMPRESSOR</b>	04.03-08.04	125	ATP	0986 <b>473 220</b>	← 57
				0986 <b>474 220</b>	→ 57
<b>200 KOMPRESSOR</b>	01.01-08.02	120		0986 <b>473 220</b>	← 57
				0986 <b>474 220</b>	→ 57
	09.02-02.08	120	ATP	0986 <b>473 220</b>	← 57
				0986 <b>474 220</b>	→ 57
<b>220 CDI</b>	01.01-02.08	105/110	ATP	0986 <b>473 220</b>	← 57
				0986 <b>474 220</b>	→ 57
<b>230</b>	06.05-02.08	150	ATP	0986 <b>473 220</b>	← 57
				0986 <b>474 220</b>	→ 57
<b>230 KOMPRESSOR</b>	01.01-05.05	141/145		0986 <b>473 490</b>	← 57
				0986 <b>474 490</b>	→ 57
<b>320</b>	09.02-05.05	160	ATP	0986 <b>473 490</b>	← 57
				0986 <b>474 490</b>	→ 57
<b>350</b>	06.05-02.08	200	ATP	0986 <b>473 490</b>	← 57
				0986 <b>474 490</b>	→ 57

<b>30 AMG CDI</b>	09.02-08.04	170			1987 <b>470 084</b>
<b>160 KOMPRESSOR</b>	06.05-02.08	90		0986 <b>473 282</b>	← 36
				0986 <b>474 282</b>	→ 36
					1987 <b>470 084</b>

		S							
<b>180</b>		01.01-02.08	95/105				0 986 473 282	 ← 36	1 987 470 084
<b>180</b> KOMPRESSOR							0 986 474 282	 → 36	1 987 470 084
<b>200</b> CDI, CGI KOMPRESSOR, KOMPRESSOR		01.01-02.08	90/120/125				0 986 473 282	 ← 36	1 987 470 084
							0 986 474 282	 → 36	1 987 470 084
<b>220</b> CDI		01.01-02.08	105/110				0 986 473 282	 ← 36	1 987 470 084
							0 986 474 282	 → 36	1 987 470 084
<b>230</b>		01.01-02.08	141/145/150				0 986 134 039	 ←	1 987 470 084
<b>230</b> KOMPRESSOR							0 986 134 061	 ←	
							0 986 135 039	 →	1 987 470 084
							0 986 135 061	 →	
<b>320</b>		09.02-05.05	160				0 986 134 039	 ←	1 987 470 084
							0 986 134 061	 ←	
							0 986 135 039	 →	1 987 470 084
							0 986 135 061	 →	
<b>350</b>		06.05-02.08	200				0 986 134 039	 ←	1 987 470 084
							0 986 134 061	 ←	
							0 986 135 039	 →	1 987 470 084
							0 986 135 061	 →	
									
 <b>30</b> AMG CDI		09.02-08.04	170				1 987 477 846	← 925	
							1 987 477 847	→ 900	
						LLE	1 987 477 845	2735	
						RLE	1 987 477 848	2160	
<b>160</b> KOMPRESSOR		06.05-02.08	90				1 987 477 846	← 925	
							1 987 477 847	→ 900	
						LLE	1 987 477 845	2735	
						RLE	1 987 477 848	2160	
<b>180</b>		01.01-02.08	95/105				1 987 477 846	← 925	
<b>180</b> KOMPRESSOR							1 987 477 847	→ 900	
						LLE	1 987 477 845	2735	
						RLE	1 987 477 848	2160	
<b>200</b> CDI		01.01-02.08	90/120/125				1 987 477 846	← 925	
<b>200</b> CGI KOMPRESSOR							1 987 477 847	→ 900	
<b>200</b> KOMPRESSOR						LLE	1 987 477 845	2735	
						RLE	1 987 477 848	2160	
<b>220</b> CDI		01.01-02.08	105/110				1 987 477 846	← 925	
							1 987 477 847	→ 900	
						LLE	1 987 477 845	2735	
						RLE	1 987 477 848	2160	
<b>230</b>		01.01-02.08	141/145/150				1 987 477 846	← 925	
<b>230</b> KOMPRESSOR							1 987 477 847	→ 900	
						LLE	1 987 477 845	2735	
						RLE	1 987 477 848	2160	
<b>320</b>		09.02-05.05	160				1 987 477 846	← 925	
							1 987 477 847	→ 900	
						LLE	1 987 477 845	2735	
						RLE	1 987 477 848	2160	
<b>350</b>		06.05-02.08	200				1 987 477 846	← 925	
							1 987 477 847	→ 900	
						LLE	1 987 477 845	2735	
						RLE	1 987 477 848	2160	
 <b>30</b> AMG CDI		09.02-08.04	170				0 986 594 543 <sup>3</sup>		
						LAB	0 986 594 541 <sup>4</sup>		
						RAB	0 986 594 542 <sup>4</sup>		
<b>160</b> KOMPRESSOR		06.05-02.08	90				0 986 594 543 <sup>3</sup>		
						LAB	0 986 594 541 <sup>4</sup>		
						RAB	0 986 594 542 <sup>4</sup>		
<b>180</b>		01.01-02.08	95/105				0 986 594 543 <sup>3</sup>		
<b>180</b> KOMPRESSOR						LAB	0 986 594 541 <sup>4</sup>		
						RAB	0 986 594 542 <sup>4</sup>		



		S							
<b>Mercedes-Benz Serie C (Sportcoupe) [203]</b>									
<b>200 CDI</b>		01.01-02.08	90/120/				0986 594 543 <sup>3</sup>		
<b>200 CGI KOMPRESSOR</b>			125			LAB	0986 594 541 <sup>4</sup>		
<b>200 KOMPRESSOR</b>						RAB	0986 594 542 <sup>4</sup>		
<b>220 CDI</b>		01.01-02.08	105/110				0986 594 543 <sup>3</sup>		
						LAB	0986 594 541 <sup>4</sup>		
						RAB	0986 594 542 <sup>4</sup>		
<b>230</b>		01.01-02.08	141/145/				0986 594 543 <sup>3</sup>		
<b>230 KOMPRESSOR</b>			150			LAB	0986 594 541 <sup>4</sup>		
						RAB	0986 594 542 <sup>4</sup>		
<b>320</b>		09.02-05.05	160				0986 594 543 <sup>3</sup>		
						LAB	0986 594 541 <sup>4</sup>		
						RAB	0986 594 542 <sup>4</sup>		
<b>350</b>		06.05-02.08	200				0986 594 543 <sup>3</sup>		
						LAB	0986 594 541 <sup>4</sup>		
						RAB	0986 594 542 <sup>4</sup>		
<b>Serie C (T-Modell) [202]</b>									
<b>180</b>		05.96-02.01	90/95				0986 473 816	← 54	1987 474 486 <sup>8</sup>
							0986 473 817	→ 54	1987 474 486 <sup>8</sup>
<b>200, CDI, D</b>		05.96-02.01	65/75/100				0986 473 816	← 54	1987 474 486 <sup>8</sup>
							0986 473 817	→ 54	1987 474 486 <sup>8</sup>
<b>200 KOMPRESSOR</b>		05.96-02.01	120/132/ 141				0986 473 096	← 56,93	1987 470 506 <sup>8</sup>
							0986 474 096	→ 56,93	1987 470 506 <sup>8</sup>
<b>220 CDI</b>		05.96-02.01	55-70/92				0986 473 816	← 54	1987 474 486 <sup>8</sup>
<b>220 D</b>							0986 473 817	→ 54	1987 474 486 <sup>8</sup>
<b>230</b>		05.96-05.97	110				0986 473 816	← 54	1987 474 486 <sup>8</sup>
							0986 473 817	→ 54	1987 474 486 <sup>8</sup>
<b>230 KOMPRESSOR</b>		06.97-02.01	142				0986 473 096	← 56,93	1987 470 506 <sup>8</sup>
							0986 474 096	→ 56,93	1987 470 506 <sup>8</sup>
<b>240</b>		06.97-02.01	125				0986 473 096	← 56,93	1987 470 506 <sup>8</sup>
							0986 474 096	→ 56,93	1987 470 506 <sup>8</sup>
<b>250 D Turbo</b>		06.97-02.01	110				0986 473 096	← 56,93	
							0986 474 096	→ 56,93	
<b>280</b>		06.97-02.01	145				0986 473 096	← 56,93	1987 470 506 <sup>8</sup>
							0986 474 096	→ 56,93	1987 470 506 <sup>8</sup>
<b>180</b>		05.96-02.01	90	Fg.-Nr. →F 576240	MZH		0986 473 963	← 38	1987 470 195
							0986 473 964	→ 38	1987 470 195
				Fg.-Nr. F 576241→	MEH		0986 473 174	← 35,96	1987 470 084
							0986 474 174	→ 35,96	1987 470 084
		09.00-02.01	95				0986 473 174	← 35,96	1987 470 084
							0986 474 174	→ 35,96	1987 470 084
<b>200</b>		05.96-02.01	100	Fg.-Nr. →F 576240	MZH		0986 473 963	← 38	1987 470 195
							0986 473 964	→ 38	1987 470 195
				Fg.-Nr. F 576241→	MEH		0986 473 174	← 35,96	1987 470 084
							0986 474 174	→ 35,96	1987 470 084
<b>200 CDI</b>		03.98-02.01	75				0986 473 174	← 35,96	1987 470 084
							0986 474 174	→ 35,96	1987 470 084
<b>200 D</b>		09.96-06.99	65	Fg.-Nr. →F 576240	MZH		0986 473 963	← 38	1987 470 195
							0986 473 964	→ 38	1987 470 195
				Fg.-Nr. F 576241→	MEH		0986 473 174	← 35,96	1987 470 084
							0986 474 174	→ 35,96	1987 470 084
<b>200 KOMPRESSOR</b>		05.96-03.00	132/141	Fg.-Nr. →F 576240	MZH		0986 473 963	← 38	1987 470 083
							0986 473 964	→ 38	1987 470 083
				Fg.-Nr. F 576241→	MEH		0986 473 174	← 35,96	1987 470 084
							0986 474 174	→ 35,96	1987 470 084
		04.00-02.01	120				0986 473 174	← 35,96	1987 470 084
							0986 474 174	→ 35,96	1987 470 084

		S								
<b>220 CDI</b>		05.96-02.01	55-70/92	Fg.-Nr. →F 576240	MZH		0 986 473 963		← 38	1 987 470 195
<b>220 D</b>				Fg.-Nr. F 576241→	MEH		0 986 473 964		→ 38	1 987 470 195
							0 986 473 174		← 35,96	1 987 470 084
							0 986 474 174		→ 35,96	1 987 470 084
<b>230</b>		05.96-05.97	110	Fg.-Nr. →F 576240	MZH		0 986 473 963		← 38	1 987 470 195
				Fg.-Nr. F 576241→	MEH		0 986 473 964		→ 38	1 987 470 195
							0 986 473 174		← 35,96	1 987 470 084
							0 986 474 174		→ 35,96	1 987 470 084
<b>230 KOMPRESSOR</b>		06.97-02.01	142				0 986 473 174		← 35,96	1 987 470 084
							0 986 474 174		→ 35,96	1 987 470 084
<b>240</b>		06.97-02.01	125				0 986 473 174		← 35,96	1 987 470 084
							0 986 474 174		→ 35,96	1 987 470 084
<b>250 D Turbo</b>		05.96-02.01	110	Fg.-Nr. →F 576240	MZH		0 986 473 963		← 38	1 987 470 195
				Fg.-Nr. F 576241→	MEH		0 986 473 964		→ 38	1 987 470 195
							0 986 473 174		← 35,96	1 987 470 084
							0 986 474 174		→ 35,96	1 987 470 084
<b>280</b>		06.97-02.01	145				0 986 473 174		← 35,96	1 987 470 084
							0 986 474 174		→ 35,96	1 987 470 084
	<b>43 AMG</b>	10.97-02.01	225				1 987 477 219		← 960	
							1 987 477 220		→ 925	
						LLE	1 987 477 896		2557	
						RLE	1 987 477 700		2067	
<b>180</b>		05.96-02.01	90/95				1 987 477 219		← 960	
							1 987 477 220		→ 925	
						LLE	1 987 477 699		2554	
						RLE	1 987 477 700		2067	
<b>200</b>		05.96-02.01	65/75/100/				1 987 477 219		← 960	
<b>200 CDI</b>			120/132/				1 987 477 220		→ 925	
<b>200 D</b>			141				1 987 477 699		2554	
<b>200 KOMPRESSOR</b>							1 987 477 700		2067	
<b>220 CDI</b>		05.96-02.01	55-70/92				1 987 477 219		← 960	
<b>220 D</b>							1 987 477 220		→ 925	
						LLE	1 987 477 699		2554	
						RLE	1 987 477 700		2067	
<b>230</b>		05.96-02.01	110/142				1 987 477 219		← 960	
<b>230 KOMPRESSOR</b>							1 987 477 220		→ 925	
						LLE	1 987 477 699		2554	
						RLE	1 987 477 700		2067	
<b>240</b>		06.97-02.01	125				1 987 477 219		← 960	
							1 987 477 220		→ 925	
						LLE	1 987 477 699		2554	
						RLE	1 987 477 700		2067	
<b>250 D Turbo</b>		05.96-02.01	110				1 987 477 219		← 960	
							1 987 477 220		→ 925	
						LLE	1 987 477 699		2554	
						RLE	1 987 477 700		2067	
<b>280</b>		06.97-02.01	145				1 987 477 219		← 960	
							1 987 477 220		→ 925	
						LLE	1 987 477 699		2554	
						RLE	1 987 477 700		2067	
	<b>43 AMG</b>	10.97-02.01	225			LAB BO	0 265 006 266 <sup>3</sup>			
						RAB BO	0 265 006 264 <sup>3</sup>			
				Fg.-Nr. →F894083,		LAB	0 265 006 192 <sup>4</sup>			
				Komp.Nr. Code 808/809,		RAB	0 265 006 172 <sup>4</sup>			
				Komp.Nr. Code 800/807						
<b>180</b>		05.96-02.01	90	Fg.-Nr. →F894083,	LAB,MET BO		0 265 006 192 <sup>4</sup>			
				Komp.Nr. Code 808/809,	MET,RAB BO		0 265 006 172 <sup>4</sup>			
				Komp.Nr. Code 800/807						



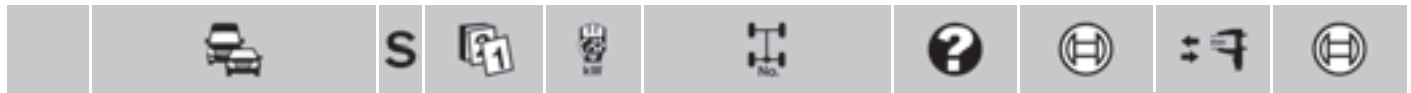

<b>Mercedes-Benz Serie C (T-Modell) [202]</b>						
<b>200</b>	05.96-02.01	75/100/132/141	Fg.-Nr. →F894083, Komp.Nr. Code 808/809, <del>Komp.Nr. Code 800/807</del>	LAB,MET MET,RAB	BO BO	0 265 <b>006 192</b> <sup>4</sup> 0 265 <b>006 172</b> <sup>4</sup>
<b>200 CDI</b>						
<b>200 KOMPRESSOR</b>						
<b>200 D</b>	09.96-06.99	65	Fg.-Nr. →F873443, Komp.Nr. Code 808/809, <del>Komp.Nr. Code 800/807</del>	LAB,MET MET,RAB	BO BO	0 265 <b>006 192</b> <sup>4</sup> 0 265 <b>006 172</b> <sup>4</sup>
<b>220 CDI</b>	12.97-02.01	92	Fg.-Nr. →F894083, Komp.Nr. Code 808/809, <del>Komp.Nr. Code 800/807</del>	LAB,MET MET,RAB	BO BO	0 265 <b>006 192</b> <sup>4</sup> 0 265 <b>006 172</b> <sup>4</sup>
<b>220 D</b>	05.96-06.99	55-70	Fg.-Nr. →F873443, Komp.Nr. Code 808/809, <del>Komp.Nr. Code 800/807</del>	LAB,MET MET,RAB	BO BO	0 265 <b>006 192</b> <sup>4</sup> 0 265 <b>006 172</b> <sup>4</sup>
<b>230</b>	05.96-05.97	110	Fg.-Nr. →F873443, Komp.Nr. Code 808/809, <del>Komp.Nr. Code 800/807</del>	LAB,MET MET,RAB	BO BO	0 265 <b>006 192</b> <sup>4</sup> 0 265 <b>006 172</b> <sup>4</sup>
<b>230 KOMPRESSOR</b>	06.97-02.01	142	Fg.-Nr. →F894083, Komp.Nr. Code 808/809, <del>Komp.Nr. Code 800/807</del>	LAB RAB	BO BO	0 265 <b>006 192</b> <sup>4</sup> 0 265 <b>006 172</b> <sup>4</sup>
<b>240</b>	06.97-02.01	125		LAB RAB	BO BO	0 265 <b>006 266</b> <sup>3</sup> 0 265 <b>006 264</b> <sup>3</sup>
			Fg.-Nr. →F894083, Komp.Nr. Code 808/809, <del>Komp.Nr. Code 800/807</del>	LAB RAB	BO BO	0 265 <b>006 192</b> <sup>4</sup> 0 265 <b>006 172</b> <sup>4</sup>
<b>250 D Turbo</b>	05.96-02.01	110	Fg.-Nr. →F894083, Komp.Nr. Code 808/809, <del>Komp.Nr. Code 800/807</del>	LAB,MET MET,RAB	BO BO	0 265 <b>006 192</b> <sup>4</sup> 0 265 <b>006 172</b> <sup>4</sup>
<b>280</b>	06.97-02.01	145		LAB RAB	BO BO	0 265 <b>006 266</b> <sup>3</sup> 0 265 <b>006 264</b> <sup>3</sup>
			Fg.-Nr. →F894083, Komp.Nr. Code 808/809, <del>Komp.Nr. Code 800/807</del>	LAB RAB		0 265 <b>006 192</b> <sup>4</sup> 0 265 <b>006 172</b> <sup>4</sup>

**Serie C (T-Modell) [203]**

<b>Serie C (T-Modell) [203]</b>						
<b>180</b>	01.01-08.07	95/105				0 986 <b>473 220</b> ← 57
<b>180 KOMPRESSOR</b>						0 986 <b>474 220</b> → 57
<b>200 CDI</b>	10.01-08.07	75/85/90		ATP		0 986 <b>473 220</b> ← 57
						0 986 <b>474 220</b> → 57
<b>200 CGI KOMPRESSOR</b>	04.03-08.04	125		ATP		0 986 <b>473 220</b> ← 57
						0 986 <b>474 220</b> → 57
<b>200 KOMPRESSOR</b>	01.01-08.02	120				0 986 <b>473 220</b> ← 57
						0 986 <b>474 220</b> → 57
	09.02-08.07	120		ATP		0 986 <b>473 220</b> ← 57
						0 986 <b>474 220</b> → 57
<b>220 CDI</b>	01.01-08.07	105/110		ATP		0 986 <b>473 220</b> ← 57
						0 986 <b>474 220</b> → 57
<b>230</b>	06.05-08.07	150		ATP		0 986 <b>473 220</b> ← 57
						0 986 <b>474 220</b> → 57
<b>230 KOMPRESSOR</b>	02.04-05.05	141		ATP		0 986 <b>473 490</b> ← 57
						0 986 <b>474 490</b> → 57
<b>240</b>	01.01-05.05	125		ATP		0 986 <b>473 490</b> ← 57
						0 986 <b>474 490</b> → 57
<b>240 4MATIC</b>	09.02-06.05	125				0 986 <b>473 524</b> ← 57
						0 986 <b>474 524</b> → 57
<b>270 CDI</b>	01.01-08.04	125		ATP		0 986 <b>473 490</b> ← 57
						0 986 <b>474 490</b> → 57
<b>280</b>	06.05-08.07	170		ATP		0 986 <b>473 490</b> ← 57
						0 986 <b>474 490</b> → 57
<b>280 4MATIC</b>	07.05-08.07	170				0 986 <b>473 524</b> ← 57
						0 986 <b>474 524</b> → 57
<b>320</b>	01.01-05.05	160		ATP		0 986 <b>473 490</b> ← 57
						0 986 <b>474 490</b> → 57

		S								
<b>320 CDI</b>		09.04-08.07	165				SBJ	0 986 134 076		57
								0 986 135 076		57
<b>320 4MATIC</b>		09.02-06.05	160					0 986 473 524		57
								0 986 474 524		57
<b>350</b>		06.05-08.07	200				ATP	0 986 473 490		57
								0 986 474 490		57
<b>350 4MATIC</b>		07.05-08.07	200					0 986 473 524		57
								0 986 474 524		57
<hr/>										
	<b>30 AMG CDI</b>	01.03-08.04	170							1 987 470 084
	<b>32 AMG KOMPRESSOR</b>	01.01-01.04	260							1 987 470 084
	<b>55 AMG</b>	02.04-08.07	270							1 987 470 084
	<b>180</b>	01.01-08.07	95/105					0 986 134 061		36
	<b>180 KOMPRESSOR</b>							0 986 135 061		36
	<b>200 CDI, CGI KOMPRESSOR, KOMPRESSOR</b>	01.01-08.07	75/85/90/ 120/125					0 986 134 061		36
								0 986 135 061		36
	<b>220 CDI</b>	01.01-08.07	105/110					0 986 134 061		36
								0 986 135 061		36
	<b>230</b>	02.04-08.07	141/150					0 986 134 061		36
	<b>230 KOMPRESSOR</b>							0 986 135 061		36
	<b>240</b>	01.01-06.05	125					0 986 134 061		36
	<b>240 4MATIC</b>							0 986 135 061		36
	<b>270 CDI</b>	01.01-08.04	125					0 986 134 061		36
								0 986 135 061		36
	<b>280</b>	06.05-08.07	170					0 986 134 061		36
	<b>280 4MATIC</b>							0 986 135 061		36
	<b>320, CDI, 4MATIC</b>	01.01-08.07	160/165					0 986 134 061		36
								0 986 135 061		36
	<b>350</b>	06.05-08.07	200					0 986 134 061		36
	<b>350 4MATIC</b>							0 986 135 061		36
<hr/>										
	<b>30 AMG CDI</b>	01.03-08.04	170					1 987 477 846		925
								1 987 477 847		900
							LLE	1 987 477 845		2735
							RLE	1 987 477 848		2160
	<b>32 AMG KOMPRESSOR</b>	01.01-01.04	260					1 987 477 846		925
								1 987 477 847		900
							LLE	1 987 477 845		2735
							RLE	1 987 477 848		2160
	<b>55 AMG</b>	02.04-08.07	270					1 987 477 846		925
								1 987 477 847		900
							LLE	1 987 477 845		2735
							RLE	1 987 477 848		2160
	<b>180</b>	01.01-08.07	95/105					1 987 477 846		925
	<b>180 KOMPRESSOR</b>							1 987 477 847		900
							LLE	1 987 477 845		2735
							RLE	1 987 477 848		2160
	<b>200 CDI</b>	01.01-08.07	75/85/90/ 120/125					1 987 477 846		925
	<b>200 CGI KOMPRESSOR</b>							1 987 477 847		900
	<b>200 KOMPRESSOR</b>						LLE	1 987 477 845		2735
							RLE	1 987 477 848		2160
	<b>220 CDI</b>	01.01-08.07	105/110					1 987 477 846		925
								1 987 477 847		900
							LLE	1 987 477 845		2735
							RLE	1 987 477 848		2160
	<b>230</b>	02.04-08.07	141/150					1 987 477 846		925
	<b>230 KOMPRESSOR</b>							1 987 477 847		900
							LLE	1 987 477 845		2735
							RLE	1 987 477 848		2160





			S							
◀ MERCEDES-BENZ Serie C (T-Modell) [203]										
240	01.01-06.05	125						1987 477 846	← 925	
240 4MATIC								1987 477 847	→ 900	
								LLE	1987 477 845	2735
								RLE	1987 477 848	2160
270 CDI	01.01-08.04	125						1987 477 846	← 925	
								1987 477 847	→ 900	
								LLE	1987 477 845	2735
								RLE	1987 477 848	2160
280	06.05-08.07	170						1987 477 846	← 925	
280 4MATIC								1987 477 847	→ 900	
								LLE	1987 477 845	2735
								RLE	1987 477 848	2160
320	01.01-08.07	160/165						1987 477 846	← 925	
320 CDI								1987 477 847	→ 900	
320 4MATIC								LLE	1987 477 845	2735
								RLE	1987 477 848	2160
350	06.05-08.07	200						1987 477 846	← 925	
350 4MATIC								1987 477 847	→ 900	
								LLE	1987 477 845	2735
								RLE	1987 477 848	2160
30 AMG CDI	01.03-08.04	170						0986 594 543 <sup>3</sup>		
								LAB	0986 594 541 <sup>4</sup>	
								RAB	0986 594 542 <sup>4</sup>	
32 AMG KOMPRESSOR	01.01-01.04	260						0986 594 543 <sup>3</sup>		
								LAB	0986 594 541 <sup>4</sup>	
								RAB	0986 594 542 <sup>4</sup>	
55 AMG	02.04-08.07	270						0986 594 543 <sup>3</sup>		
								LAB	0986 594 541 <sup>4</sup>	
								RAB	0986 594 542 <sup>4</sup>	
180	01.01-08.07	95/105						0986 594 543 <sup>3</sup>		
180 KOMPRESSOR								LAB	0986 594 541 <sup>4</sup>	
								RAB	0986 594 542 <sup>4</sup>	
200 CDI	01.01-08.07	75/85/90/						0986 594 543 <sup>3</sup>		
200 CGI KOMPRESSOR		120/125						LAB	0986 594 541 <sup>4</sup>	
200 KOMPRESSOR								RAB	0986 594 542 <sup>4</sup>	
220 CDI	01.01-08.07	105/110						0986 594 543 <sup>3</sup>		
								LAB	0986 594 541 <sup>4</sup>	
								RAB	0986 594 542 <sup>4</sup>	
230	02.04-08.07	141/150						0986 594 543 <sup>3</sup>		
230 KOMPRESSOR								LAB	0986 594 541 <sup>4</sup>	
								RAB	0986 594 542 <sup>4</sup>	
240	01.01-05.05	125						0986 594 543 <sup>3</sup>		
240	01.01-06.05	125						LAB	0986 594 541 <sup>4</sup>	
240 4MATIC								RAB	0986 594 542 <sup>4</sup>	
240 4MATIC	09.02-06.05	125						0986 594 544 <sup>3</sup>		
270 CDI	01.01-08.04	125						0986 594 543 <sup>3</sup>		
								LAB	0986 594 541 <sup>4</sup>	
								RAB	0986 594 542 <sup>4</sup>	
280	06.05-08.07	170						0986 594 543 <sup>3</sup>		
280	06.05-08.07	170						LAB	0986 594 541 <sup>4</sup>	
280 4MATIC								RAB	0986 594 542 <sup>4</sup>	
280 4MATIC	07.05-08.07	170						0986 594 544 <sup>3</sup>		
320	01.01-05.05	160						0986 594 543 <sup>3</sup>		
320	01.01-06.05	160						LAB	0986 594 541 <sup>4</sup>	
320 4MATIC								RAB	0986 594 542 <sup>4</sup>	
320 CDI	09.04-08.07	165						0986 594 543 <sup>3</sup>		
								LAB	0986 594 541 <sup>4</sup>	
								RAB	0986 594 542 <sup>4</sup>	
320 4MATIC	09.02-06.05	160						0986 594 544 <sup>3</sup>		
350	06.05-08.07	200						0986 594 543 <sup>3</sup>		
350	06.05-08.07	200						LAB	0986 594 541 <sup>4</sup>	
350 4MATIC								RAB	0986 594 542 <sup>4</sup>	



		S							
350 4MATIC		07.05-08.07	200				0 986 594 544 <sup>3</sup>		
<b>Serie C (T-Modell) [204]</b>									
	180 CDI	01.11→	88		SBJ		0 986 134 322		← 60
							0 986 135 322		→ 60
	180 CGI	10.09→	115		SBJ		0 986 134 322		← 60
							0 986 135 322		→ 60
	180 KOMPRESSOR	09.07-08.08	115		ATP		0 986 134 322		← 60
							0 986 135 322		→ 60
	180 KOMPRESSOR BlueEFFICIENCY	09.08-04.10	115		SBJ		0 986 134 322		← 60
							0 986 135 322		→ 60
	200 CDI	09.07-10.09	100		ATP		0 986 134 322		← 60
							0 986 135 322		→ 60
		01.11→	100		SBJ		0 986 134 322		← 60
							0 986 135 322		→ 60
	200 CGI	09.07→	135		SBJ		0 986 134 322		← 60
	200 KOMPRESSOR						0 986 135 322		→ 60
	220 CDI	09.07→	125		SBJ		0 986 134 322		← 60
							0 986 135 322		→ 60
	230	09.07-04.09	150		ATP		0 986 134 322		← 60
							0 986 135 322		→ 60
	250 CDI	04.09→	150		SBJ		0 986 134 322		← 60
	250 CGI						0 986 135 322		→ 60
	180 CDI	01.11→	88		SBJ		0 986 134 333		← 38
							0 986 135 333		→ 38
					SBJ		0 986 134 321		← 38
							0 986 135 321		→ 38
	180 CGI	10.09-04.12	115		AGH		0 986 134 333		← 38
							0 986 135 333		→ 38
					GEM		0 986 134 321		← 38
							0 986 135 321		→ 38
		04.12→	115				0 986 134 333		← 38
							0 986 135 333		→ 38
	180 KOMPRESSOR	09.07-04.10	115				0 986 134 321		← 38
	180 KOMPRESSOR BlueEFFICIENCY						0 986 135 321		→ 38
	200 CDI	09.07-10.09	100				0 986 134 321		← 38
							0 986 135 321		→ 38
		01.11→	100		AGH		0 986 134 333		← 38
							0 986 135 333		→ 38
					GEM		0 986 134 321		← 38
							0 986 135 321		→ 38
	200 CGI	04.09→	135		AGH		0 986 134 333		← 38
							0 986 135 333		→ 38
					GEM		0 986 134 321		← 38
							0 986 135 321		→ 38
	200 KOMPRESSOR	09.07-04.10	135				0 986 134 321		← 38
							0 986 135 321		→ 38
	220 CDI	09.07-03.09	125				0 986 134 321		← 38
							0 986 135 321		→ 38
		04.09→	125		GEM		0 986 134 321		← 38
							0 986 135 321		→ 38
	220 CDI 4MATIC	03.13→	125		GEM		0 986 134 321		← 38
							0 986 135 321		→ 38
	220 CDI	04.09→	125		AGH		0 986 134 333		← 38
	220 CDI 4MATIC						0 986 135 333		→ 38
	230	09.07-04.09	150				0 986 134 321		← 38
							0 986 135 321		→ 38
	250 CDI	04.09→	150		TW				1 987 470 506 <sup>B</sup>



		S								
<b>◀ MERCEDES-BENZ Serie C (T-Modell) [204]</b>										
<b>250 CDI 4MATIC</b>	04.10→	150		AGH, SBJ			0986 134 333		38	1987 470 506 <sup>8</sup>
							0986 135 333		38	1987 470 506 <sup>8</sup>
										1987 470 506 <sup>8</sup>
							0986 134 321		38	1987 470 506 <sup>8</sup>
							0986 135 321		38	1987 470 506 <sup>8</sup>
				GEM, SBJ					1987 470 506 <sup>8</sup>	
<b>250 CGI</b>	04.09→	150		TW			0986 134 321		38	1987 470 506 <sup>8</sup>
							0986 134 333		38	1987 470 506 <sup>8</sup>
							0986 135 321		38	1987 470 506 <sup>8</sup>
							0986 135 333		38	1987 470 506 <sup>8</sup>
<b>280</b>	09.07-03.09	170					0986 134 321		38	1987 470 506 <sup>8</sup>
							0986 135 321		38	1987 470 506 <sup>8</sup>
<b>300</b>	04.09-12.11	170		TW			0986 134 321		38	1987 470 506 <sup>8</sup>
							0986 134 333		38	1987 470 506 <sup>8</sup>
							0986 135 321		38	1987 470 506 <sup>8</sup>
							0986 135 333		38	1987 470 506 <sup>8</sup>
<b>300 CDI 4MATIC</b>	09.11→	170								1987 470 506 <sup>8</sup>
<b>320 CDI</b>	09.07-04.09	165		AGH						1987 470 506 <sup>8</sup>
							GEM			1987 470 506 <sup>8</sup>
<b>320 CDI 4MATIC</b>	09.07-04.09	165								1987 470 506 <sup>8</sup>
<b>350, CDI, CDI 4MATIC, CGI</b>	09.07→	170/195/200/225								1987 470 506 <sup>8</sup>
<b>350 CDI</b>	05.09-10.09	165		AGH						1987 470 506 <sup>8</sup>
							GEM			1987 470 506 <sup>8</sup>
<b>350 CDI 4MATIC</b>	05.09-10.09	165								1987 470 506 <sup>8</sup>
<b>63 AMG</b>	02.08→	336/358/ 373		LLE			1987 482 301		728	
							1987 482 331		2057	
							1987 482 332		1152	
							1987 482 330		1637	
<b>180 CDI</b>	01.11→	88		MI			1987 482 301		728	
							1987 482 331		2057	
							1987 482 332		1152	
<b>180 CGI</b>	10.09→	115					1987 482 301		728	
<b>180 CGI</b>	09.07→	115		LLE			1987 482 331		2057	
							MI		1152	
							1987 482 332		1152	
							RLE		1637	
<b>180 KOMPRESSOR</b>							1987 482 330		1637	
<b>180 KOMPRESSOR BlueEFFICIENCY</b>							1987 482 301		728	
<b>180 KOMPRESSOR BlueEFFICIENCY</b>	09.07-08.08	115					1987 482 301		728	
<b>180 KOMPRESSOR BlueEFFICIENCY</b>	09.08-04.10	115					1987 482 301		728	
<b>200 CDI</b>	09.07-10.09	100/135					1987 482 301		728	
							01.11→	100/135		
<b>200 CDI</b>	09.07→	100/135					LLE		2057	
<b>200 CGI</b>							MI		1152	
<b>200 KOMPRESSOR</b>							RLE		1637	
<b>200 CGI</b>	04.09→	100/135					1987 482 301		728	
<b>200 KOMPRESSOR</b>	09.07-04.10	100/135					1987 482 301		728	
<b>220 CDI</b>	09.07→	125					1987 482 301		728	
<b>220 CDI 4MATIC</b>	03.13→	125					1987 482 301		728	
<b>220 CDI</b>	09.07→	125		LLE			1987 482 331		2057	
							MI		1152	
							RLE		1637	
<b>230</b>	09.07-04.09	150					1987 482 301		728	
							LLE		2057	
							MI		1152	
							RLE		1637	
<b>250 CDI</b>	04.09→	150					1987 482 301		728	
							LLE		2057	
<b>250 CDI 4MATIC</b>	04.10→	150					1987 482 301		728	
							1987 482 331		2057	
<b>250 CDI, CDI 4MATIC, CGI</b>	04.09→	150					MI		1152	
<b>250 CDI, CGI</b>	04.09→	150					RLE		1637	



		S							
<b>250 CGI</b>		04.09→	150					1 987 482 301	↔ 728
						LLE		1 987 482 331	2057
<b>280</b>		09.07-03.09	170					1 987 482 301	↔ 728
						LLE		1 987 482 331	2057
						MI		1 987 482 332	1152
						RLE		1 987 482 330	1637
<b>300</b>		04.09-12.11	170					1 987 482 301	↔ 728
						LLE		1 987 482 331	2057
						RLE		1 987 482 330	1637
<b>300, CDI 4MATIC</b>		04.09→	170			MI		1 987 482 332	1152
<b>300 CDI 4MATIC</b>		09.11→	170					1 987 482 301	↔ 728
								1 987 482 331	2057
<b>320 CDI</b>		09.07-04.09	165					1 987 482 301	↔ 728
<b>320 CDI 4MATIC</b>		09.07-04.09	165					1 987 482 301	↔ 728
<b>320 CDI</b>		09.07-04.09	165			LLE		1 987 482 331	2057
<b>320 CDI 4MATIC</b>						MI		1 987 482 332	1152
						RLE		1 987 482 330	1637
<b>350</b>		09.07-12.10	200					1 987 482 301	↔ 728
						LLE		1 987 482 331	2057
						MI		1 987 482 332	1152
						RLE		1 987 482 330	1637
<b>350 CDI</b>		05.09-10.09	165					1 987 482 301	↔ 728
		10.09-01.11	170					1 987 482 301	↔ 728
						LLE		1 987 482 331	2057
						RLE		1 987 482 330	1637
		02.11→	195					1 987 482 301	↔ 728
						LLE		1 987 482 331	2057
						MI		1 987 482 332	1152
						RLE		1 987 482 330	1637
<b>350 CDI 4MATIC</b>		05.09-10.09	165					1 987 482 301	↔ 728
		10.09-08.11	170					1 987 482 301	↔ 728
								1 987 482 331	2057
<b>350 CDI</b>		05.09-10.09	165			LLE		1 987 482 331	2057
<b>350 CDI 4MATIC</b>						MI		1 987 482 332	1152
						RLE		1 987 482 330	1637
		10.09-08.11	170			MI		1 987 482 332	1152
<b>350 CGI</b>		02.11→	225					1 987 482 301	↔ 728
						LLE		1 987 482 331	2057
						MI		1 987 482 332	1152
						RLE		1 987 482 330	1637
<b>63 AMG</b>		02.08→	336/358/373					0 986 594 546 <sup>4</sup>	
<b>180 CDI</b>		01.11→	88					0 986 594 546 <sup>4</sup>	
								0 986 594 548 <sup>3</sup>	
<b>180 CGI</b>		10.09-04.12	115		Komp.Nr. 802/803/804/805			0 986 594 548 <sup>3</sup>	
					Komp.Nr. 809/800/801			0 986 594 545 <sup>3</sup>	
		04.12→	115					0 986 594 548 <sup>3</sup>	
<b>180 CGI, KOMPRESSOR, KOMPRESSOR BlueEFFICIENCY</b>		09.07→	115					0 986 594 546 <sup>4</sup>	
<b>180 KOMPRESSOR</b>		09.07-04.10	115					0 986 594 545 <sup>3</sup>	
<b>180 KOMPRESSOR BlueEFFICIENCY</b>									
<b>200 CDI</b>		09.07-10.09	100					0 986 594 545 <sup>3</sup>	
								0 986 594 546 <sup>4</sup>	
		01.11→	100					0 986 594 546 <sup>4</sup>	
								0 986 594 548 <sup>3</sup>	
<b>200 CGI</b>		04.09→	135		Mod.Jahr →2010			0 986 594 545 <sup>3</sup>	
					Mod.Jahr 2011→			0 986 594 548 <sup>3</sup>	
<b>200 CGI, KOMPRESSOR</b>		09.07→	135					0 986 594 546 <sup>4</sup>	
<b>200 KOMPRESSOR</b>		09.07-04.10	135					0 986 594 545 <sup>3</sup>	
<b>220 CDI</b>		09.07-03.09	125					0 986 594 545 <sup>3</sup>	
		09.07→	125					0 986 594 546 <sup>4</sup>	
		04.09→	125		Komp.Nr. 802/803/804/805			0 986 594 548 <sup>3</sup>	
					Komp.Nr. 809/800/801			0 986 594 545 <sup>3</sup>	



	S							
<b>◀ MERCEDES-BENZ Serie C (T-Modell) [204]</b>								
<b>220 CDI 4MATIC</b>	03.13→	125				0 986 594 546 <sup>4</sup>		
<b>230</b>	09.07-04.09	150				0 986 594 545 <sup>3</sup>		
						0 986 594 546 <sup>4</sup>		
<b>250 CDI, CDI 4MATIC, CGI</b>	04.09→	150				0 986 594 546 <sup>4</sup>		
<b>250 CDI</b>	04.09→	150		Mod.Jahr →2010		0 986 594 545 <sup>3</sup>		
<b>250 CGI</b>				Mod.Jahr 2011→		0 986 594 548 <sup>3</sup>		
<b>280</b>	09.07-03.09	170				0 986 594 545 <sup>3</sup>		
						0 986 594 546 <sup>4</sup>		
<b>300</b>	04.09-12.11	170				0 986 594 546 <sup>4</sup>		
				Mod.Jahr →2010		0 986 594 545 <sup>3</sup>		
				Mod.Jahr 2011→		0 986 594 548 <sup>3</sup>		
<b>300 CDI 4MATIC</b>	09.11→	170				0 986 594 546 <sup>4</sup>		
<b>320 CDI</b>	09.07-04.09	165				0 986 594 545 <sup>3</sup>		
						0 986 594 546 <sup>4</sup>		
<b>320 CDI 4MATIC</b>	09.07-04.09	165				0 986 594 546 <sup>4</sup>		
<b>350</b>	09.07-12.10	200				0 986 594 546 <sup>4</sup>		
				Komp.Nr. 802/803/804/805		0 986 594 548 <sup>3</sup>		
				Komp.Nr. 809/800/801		0 986 594 545 <sup>3</sup>		
<b>350 CDI</b>	05.09-01.11	165/170				0 986 594 545 <sup>3</sup>		
						0 986 594 546 <sup>4</sup>		
	02.11→	195				0 986 594 546 <sup>4</sup>		
						0 986 594 548 <sup>3</sup>		
<b>350 CDI 4MATIC</b>	05.09-08.11	165/170				0 986 594 546 <sup>4</sup>		
<b>350 CGI</b>	02.11→	225				0 986 594 546 <sup>4</sup>		
						0 986 594 548 <sup>3</sup>		

**Serie C (T-Modell) [205]**

<b>63 AMG, S</b>	10.14→	350/375						1 987 470 506 <sup>8</sup>
<b>160</b>	04.15→	95		ATP				1 987 470 506 <sup>8</sup>
				ATP				1 987 470 506 <sup>8</sup>
<b>180</b>	05.14→	85/115		ATP				1 987 470 506 <sup>8</sup>
<b>180 BlueTec</b>				ATP				1 987 470 506 <sup>8</sup>
<b>200</b>	05.14→	135		ATP				1 987 470 506 <sup>8</sup>
				ATP				1 987 470 506 <sup>8</sup>
<b>200 BlueTec</b>	05.14→	100		ATP				1 987 470 506 <sup>8</sup>
				ATP				1 987 470 506 <sup>8</sup>
<b>200 4MATIC</b>	04.15→	135						1 987 470 506 <sup>8</sup>
<b>220 BlueTec</b>	05.14→	125		ATP				1 987 470 506 <sup>8</sup>
<b>220 d 4MATIC</b>				ATP				1 987 470 506 <sup>8</sup>
<b>250, BlueTec, BlueTec 4MATIC</b>	05.14→	150/155		ATP				1 987 470 506 <sup>8</sup>
				ATP				1 987 470 506 <sup>8</sup>
<b>300</b>	04.15→	180		PRC,TW				1 987 470 506 <sup>8</sup>
				TW				1 987 470 506 <sup>8</sup>
<b>300 BlueTec Hybrid</b>	10.14→	150-170						1 987 470 506 <sup>8</sup>
<b>350 e, Hybrid Plus</b>	07.14→	155-215						1 987 470 506 <sup>8</sup>
<b>400 4MATIC</b>	10.14→	245						1 987 470 506 <sup>8</sup>
<b>450 AMG 4MATIC</b>	04.15→	270						1 987 470 506 <sup>8</sup>

**Serie C [202]**

<b>36 AMG</b>	09.94-09.95	206				0 986 473 681	← 54	
						0 986 474 681	→ 54	
<b>180</b>	03.93-04.00	90						1 987 474 486 <sup>8</sup>
				Fg.-Nr. →A 344660, →F 331440		0 986 473 680	← 54	
						0 986 474 680	→ 54	
				Fg.-Nr. A 344661→, F 331441→		0 986 473 818	← 54	
						0 986 473 819	→ 54	
<b>200</b>	01.94-04.00	100						1 987 474 486 <sup>8</sup>
				Fg.-Nr. →A 344660, →F 331440,		0 986 473 681	← 54	
				Komp.Nr. Code 805, Komp.Nr. Code 806		0 986 474 681	→ 54	

		S							
<b>200</b>		01.94-04.00	100	Fg.-Nr. A 344661→, F 331441→			0 986 473 816	54	1 987 474 486 <sup>B</sup>
							0 986 473 817	54	1 987 474 486 <sup>B</sup>
<b>200 CDI</b>		03.98-04.00	75				0 986 473 816	54	1 987 474 486 <sup>B</sup>
							0 986 473 817	54	1 987 474 486 <sup>B</sup>
<b>200 D</b>		03.93-08.95	55						1 987 474 486 <sup>B</sup>
							0 986 473 680	54	
							0 986 474 680	54	
		09.96-06.99	55-65						1 987 474 486 <sup>B</sup>
							0 986 473 818	54	
							0 986 473 819	54	
<b>200 KOMPRESSOR</b>		09.95-04.00	132-141				0 986 473 096	56,93	
							0 986 474 096	56,93	
<b>220</b>		03.93-09.96	110						1 987 474 486 <sup>B</sup>
				Fg.-Nr. →A 344660, →F 331440,			0 986 473 681	54	
				Komp.Nr. Code 805, Komp.Nr. Code 806			0 986 474 681	54	
				Fg.-Nr. A 344661→, F 331441→			0 986 473 816	54	1 987 474 486 <sup>B</sup>
							0 986 473 817	54	1 987 474 486 <sup>B</sup>
<b>220 CDI</b>		12.97-04.00	92				0 986 473 816	54	1 987 474 486 <sup>B</sup>
							0 986 473 817	54	1 987 474 486 <sup>B</sup>
<b>220 D</b>		08.93-06.99	55-70				0 986 473 816	54	1 987 474 486 <sup>B</sup>
							0 986 473 817	54	1 987 474 486 <sup>B</sup>
				Fg.-Nr. →A 344660, →F 331440			0 986 473 680	54	
							0 986 474 680	54	
				Fg.-Nr. A 344661→, F 331441→			0 986 473 818	54	
							0 986 473 819	54	
<b>230</b>		09.96-08.98	110						1 987 474 486 <sup>B</sup>
							0 986 473 816	54	1 987 474 486 <sup>B</sup>
							0 986 473 817	54	1 987 474 486 <sup>B</sup>
<b>230 KOMPRESSOR</b>		09.95-04.00	142				0 986 473 096	56,93	1 987 470 506 <sup>B</sup>
							0 986 474 096	56,93	1 987 470 506 <sup>B</sup>
<b>240</b>		06.97-04.00	125				0 986 473 096	56,93	
							0 986 474 096	56,93	
<b>250 D</b>		05.93-08.95	83						1 987 474 486 <sup>B</sup>
				Fg.-Nr. →A 344660, →F 331440			0 986 473 680	54	
							0 986 474 680	54	
				Fg.-Nr. A 344661→, F 331441→			0 986 473 818	54	
							0 986 473 819	54	
<b>250 D Turbo</b>		09.95-04.00	110				0 986 473 096	56,93	1 987 470 506 <sup>B</sup>
							0 986 474 096	56,93	1 987 470 506 <sup>B</sup>
<b>280</b>		05.93-05.97	142	Fg.-Nr. →A 344660, →F 331440,					1 987 474 486 <sup>B</sup>
				Komp.Nr. Code 805, Komp.Nr. Code 806			0 986 473 681	54	
							0 986 474 681	54	
				Fg.-Nr. A 344661→, F 331441→,			0 986 473 096	56,93	
				Komp.Nr. Code 806, Komp.Nr. Code 805			0 986 474 096	56,93	
		06.97-08.00	145				0 986 473 096	56,93	1 987 470 506 <sup>B</sup>
							0 986 474 096	56,93	1 987 470 506 <sup>B</sup>
<b>36 AMG</b>		01.94-05.97	206	Fg.-Nr. →A 344660, →F 331440					1 987 470 083
				Fg.-Nr. A 344661→,			0 986 473 276	36	
				F 331441→			0 986 474 276	36	
<b>180</b>		03.93-04.00	90	Fg.-Nr. →A 419828,	MZH		0 986 471 951	35	
				→F 443892			0 986 473 951		
							0 986 471 952	35	
							0 986 473 952		
				Fg.-Nr. A 419829→,	MEH		0 986 473 095	34,96	1 987 470 086 <sup>7</sup>
				F 443893→			0 986 474 095	34,96	1 987 470 086 <sup>7</sup>
<b>200</b>		01.94-04.00	100	Fg.-Nr. →A 419828,	MZH		0 986 471 951	35	
				→F 443892			0 986 473 951		
							0 986 471 952	35	
							0 986 473 952		



		S								
◀ MERCEDES-BENZ Serie C [202]										
<b>200</b>	01.94-04.00	100	Fg.-Nr. A 419829→, F 443893→	MEH	0986 473 095		34,96	1987 470 0867		
					0986 474 095		34,96	1987 470 0867		
<b>200 CDI</b>	03.98-04.00	75			0986 473 095		34,96	1987 470 0867		
					0986 474 095		34,96	1987 470 0867		
<b>200 D</b>	03.93-08.95	55	Fg.-Nr. →A 419828, →F 443892	MZH	0986 471 951		35			
					0986 473 951					
					0986 471 952		35			
	09.96-06.99	55-65	Fg.-Nr. →A 419828, →F 443892	MZH	0986 473 095		34,96	1987 470 0867		
					0986 474 095		34,96	1987 470 0867		
					0986 471 951		35			
			Fg.-Nr. A 419829→, F 443893→	MEH	0986 473 095		34,96	1987 470 0867		
					0986 474 095		34,96	1987 470 0867		
					0986 471 951		35			
<b>200 KOMPRESSOR</b>	05.96-04.00	132-141	Fg.-Nr. →A 487047, →F 576240	MZH	0986 473 963		38	1987 470 083		
					0986 473 964		38	1987 470 083		
				Fg.-Nr. A 487048→, F 576241→	MEH	0986 473 174		35,96	1987 470 084	
						0986 474 174		35,96	1987 470 084	
<b>220</b>	03.93-09.96	110	Fg.-Nr. →A 419828, →F 443892	MZH	0986 471 951		35			
					0986 473 951					
					0986 471 952		35			
				Fg.-Nr. A 419829→, F 443893→	MEH	0986 473 095		34,96	1987 470 0867	
						0986 474 095		34,96	1987 470 0867	
						0986 471 951		34,96	1987 470 0867	
<b>220 CDI</b>	12.97-04.00	92			0986 473 095		34,96	1987 470 0867		
					0986 474 095		34,96	1987 470 0867		
<b>220 D</b>	08.93-06.99	55-70	Fg.-Nr. →A 419828, →F 443892	MZH	0986 471 951		35			
					0986 473 951					
					0986 471 952		35			
				Fg.-Nr. A 419829→, F 443893→	MEH	0986 473 095		34,96	1987 470 0867	
						0986 474 095		34,96	1987 470 0867	
						0986 471 951		34,96	1987 470 0867	
<b>230</b>	09.96-08.98	110			0986 473 095		34,96	1987 470 0867		
					0986 474 095		34,96	1987 470 0867		
<b>230 KOMPRESSOR</b>	05.96-04.00	142	Fg.-Nr. →A 487047, →F 576240	MZH	0986 473 963		38	1987 470 083		
					0986 473 964		38	1987 470 083		
				Fg.-Nr. A 487048→, F 576241→	MEH	0986 473 174		35,96	1987 470 084	
						0986 474 174		35,96	1987 470 084	
<b>240</b>	06.97-04.00	125	Fg.-Nr. →A 487047, →F 576240	MZH	0986 473 963		38	1987 470 083		
					0986 473 964		38	1987 470 083		
				Fg.-Nr. A 487048→, F 576241→	MEH	0986 473 174		35,96	1987 470 084	
						0986 474 174		35,96	1987 470 084	
<b>250 D</b>	05.93-08.95	83	Fg.-Nr. →A 419828, →F 443892	MZH	0986 471 951		35			
					0986 473 951					
					0986 471 952		35			
				Fg.-Nr. A 419829→, F 443893→	MEH	0986 473 095		34,96	1987 470 0867	
						0986 474 095		34,96	1987 470 0867	
						0986 471 951		34,96	1987 470 0867	
<b>250 D Turbo</b>	05.96-04.00	110	Fg.-Nr. →A 487047, →F 576240	MZH	0986 473 963		38	1987 470 083		
					0986 473 964		38	1987 470 083		
				Fg.-Nr. A 487048→, F 576241→	MEH	0986 473 174		35,96	1987 470 084	
						0986 474 174		35,96	1987 470 084	
<b>280</b>	06.97-08.00	145	Fg.-Nr. →A 487047, →F 576240	MZH	0986 473 963		38	1987 470 083		
					0986 473 964		38	1987 470 083		
					0986 473 174		35,96	1987 470 084		
				Fg.-Nr. A 487048→, F 576241→	MEH	0986 474 174		35,96	1987 470 084	
						0986 473 095		34,96	1987 470 0867	
						0986 474 095		34,96	1987 470 0867	
	OAS	05.93-05.97	142	Fg.-Nr. →A 344660, →F 331440, Komp.Nr. Code 805, Komp.Nr. Code 806	MEH	0986 473 095		34,96	1987 470 0867	
						0986 474 095		34,96	1987 470 0867	



		S							
<b>280</b>		OAS	05.93-05.97	142	Fg.-Nr. A 344661→, F 331441→, Komp.Nr. Code 806, Komp.Nr. Code 805	MZH	0 986 473 963 0 986 473 964	38 38	1 987 470 083 1 987 470 083
<b>36 AMG</b>			01.94-05.97	206			1 987 477 219 1 987 477 220	960 925	
						LLE	1 987 477 699	2554	
						RLE	1 987 477 700	2067	
			09.94-05.97	206			1 987 477 699	2554	
<b>43 AMG</b>			11.97-04.00	225			1 987 477 219 1 987 477 220	960 925	
						LLE	1 987 477 896	2557	
						RLE	1 987 477 700	2067	
<b>180</b>			03.93-04.00	90			1 987 477 219 1 987 477 220	960 925	
						LLE	1 987 477 699	2554	
						RLE	1 987 477 700	2067	
<b>200</b>			03.93-04.00	55-65/75/			1 987 477 219	960	
<b>200 CDI</b>				100/			1 987 477 220	925	
<b>200 D</b>				132-141		LLE	1 987 477 699	2554	
<b>200 KOMPRESSOR</b>						RLE	1 987 477 700	2067	
<b>220</b>			03.93-08.96	110			1 987 477 699	2554	
			03.93-09.96	110			1 987 477 219 1 987 477 220	960 925	
						LLE	1 987 477 699	2554	
						RLE	1 987 477 700	2067	
<b>220 CDI</b>			08.93-04.00	55-70/92			1 987 477 219	960	
<b>220 D</b>							1 987 477 220	925	
						LLE	1 987 477 699	2554	
						RLE	1 987 477 700	2067	
<b>230</b>			09.96-08.97	110			1 987 477 699	2554	
							1 987 477 700	2067	
			09.96-08.98	110			1 987 477 219 1 987 477 220	960 925	
							1 987 477 699	2554	
<b>230 KOMPRESSOR</b>			09.95-04.00	142			1 987 477 219 1 987 477 220	960 925	
						LLE	1 987 477 699	2554	
						RLE	1 987 477 700	2067	
<b>240</b>			06.97-04.00	125			1 987 477 219 1 987 477 220	960 925	
						LLE	1 987 477 699	2554	
						RLE	1 987 477 700	2067	
<b>250 D</b>			05.93-04.00	83/110			1 987 477 219	960	
<b>250 D Turbo</b>							1 987 477 220	925	
						LLE	1 987 477 699	2554	
						RLE	1 987 477 700	2067	
<b>280</b>			05.93-05.97	142			1 987 477 219 1 987 477 220	960 925	
						LLE	1 987 477 699	2554	
						RLE	1 987 477 700	2067	
			06.97-04.00	145			1 987 477 699	2554	
							1 987 477 700	2067	
			06.97-08.00	145			1 987 477 219 1 987 477 220	960 925	
							1 987 477 699	2554	
			09.97-08.00	145			1 987 477 699	2554	
<b>36 AMG</b>			01.94-05.97	206		LAB,MET BO MET,RAB BO MET BO	0 265 006 192 <sup>4</sup> 0 265 006 172 <sup>4</sup> 0 265 002 212 <sup>4</sup>		







 ◀ MERCEDES-BENZ Serie C [202]

<b>36 AMG</b>	01.94-05.97	206	Fg.-Nr. →A344660,	LAB	BO	0 265 <b>006 248</b> <sup>3</sup>
			→F331440, Komp.Nr. Code 805, <del>Komp.Nr. Code 806</del>	RAB	BO	0 265 <b>006 242</b> <sup>3</sup>
			Fg.-Nr. A334661→A809594, F331441→F894083, 202...A/B/C/D/E, Komp.Nr. Code 806/809, <del>Komp.Nr. Code 800/805</del>	LAB	BO	0 265 <b>006 266</b> <sup>3</sup>
			Fg.-Nr. A344661→A809594, F331441→F894083, 202...A/B/C/D/E, Komp.Nr. Code 806/809, <del>Komp.Nr. Code 800/805</del>	RAB	BO	0 265 <b>006 264</b> <sup>3</sup>
<b>43 AMG</b>	11.97-04.00	225		LAB,MET	BO	0 265 <b>006 192</b> <sup>4</sup>
				MET,RAB	BO	0 265 <b>006 172</b> <sup>4</sup>
				MET	BO	0 265 <b>002 212</b> <sup>4</sup>
			Fg.-Nr. 202...A/B/C/D/E	LAB	BO	0 265 <b>006 266</b> <sup>3</sup>
				RAB	BO	0 265 <b>006 264</b> <sup>3</sup>
<b>180</b>	03.93-04.00	90		LAB,MET	BO	0 265 <b>006 192</b> <sup>4</sup>
				MET,RAB	BO	0 265 <b>006 172</b> <sup>4</sup>
				MET	BO	0 265 <b>002 212</b> <sup>4</sup>
			Fg.-Nr. →A344660, →F331440, Komp.Nr. Code 805, <del>Komp.Nr. Code 806</del>	LAB	BO	0 265 <b>006 248</b> <sup>3</sup>
			Fg.-Nr. A334661→, F331441→, 202...A/B/D/E, Komp.Nr. Code 806/809, <del>Komp.Nr. Code 800/805</del>	LAB	BO	0 265 <b>006 266</b> <sup>3</sup>
			Fg.-Nr. A344661→, F331441→, 202...A/B/C/D/E, Komp.Nr. Code 806/809, <del>Komp.Nr. Code 800/805</del>	RAB	BO	0 265 <b>006 264</b> <sup>3</sup>
<b>200</b>	01.94-04.00	100		LAB,MET	BO	0 265 <b>006 192</b> <sup>4</sup>
				MET,RAB	BO	0 265 <b>006 172</b> <sup>4</sup>
				MET	BO	0 265 <b>002 212</b> <sup>4</sup>
			Fg.-Nr. →A344660, →F331440, Komp.Nr. Code 805, <del>Komp.Nr. Code 806</del>	LAB	BO	0 265 <b>006 248</b> <sup>3</sup>
			Fg.-Nr. A334661→, F331441→, 202...A/B/D/E, Komp.Nr. Code 806/809, <del>Komp.Nr. Code 800/805</del>	LAB	BO	0 265 <b>006 266</b> <sup>3</sup>
			Fg.-Nr. A344661→, F331441→, 202...A/B/C/D/E, Komp.Nr. Code 806/809, <del>Komp.Nr. Code 800/805</del>	RAB	BO	0 265 <b>006 264</b> <sup>3</sup>
<b>200 CDI</b>	03.98-04.00	75		LAB,MET	BO	0 265 <b>006 192</b> <sup>4</sup>
				MET,RAB	BO	0 265 <b>006 172</b> <sup>4</sup>
				MET	BO	0 265 <b>002 212</b> <sup>4</sup>
			Fg.-Nr. →A344660, →F331440, Komp.Nr. Code 805, <del>Komp.Nr. Code 806</del>	LAB	BO	0 265 <b>006 248</b> <sup>3</sup>
			Fg.-Nr. A334661→A809594, F331441→F894083, 202...A/B/C/D/E, Komp.Nr. Code 806/809, <del>Komp.Nr. Code 800/805</del>	LAB	BO	0 265 <b>006 266</b> <sup>3</sup>
			Fg.-Nr. A344661→A809594, F331441→F894083, 202...A/B/C/D/E, Komp.Nr. Code 806/809, <del>Komp.Nr. Code 800/805</del>	RAB	BO	0 265 <b>006 264</b> <sup>3</sup>



		S														
200 D		03.93-08.95	55				LAB		0 265 006 248 <sup>3</sup>							
							LAB,MET	BO	0 265 006 192 <sup>4</sup>							
							MET,RAB	BO	0 265 006 172 <sup>4</sup>							
							MET	BO	0 265 002 212 <sup>4</sup>							
							RAB		0 265 006 242 <sup>3</sup>							
							09.96-06.99	55-65					LAB,MET	BO	0 265 006 192 <sup>4</sup>	
													MET,RAB	BO	0 265 006 172 <sup>4</sup>	
													MET	BO	0 265 002 212 <sup>4</sup>	
													Fg.-Nr. →A344660, →F331440, Komp.Nr. Code 805, <del>Komp.Nr. Code 806</del>	LAB	BO	0 265 006 248 <sup>3</sup>
													RAB	BO	0 265 006 242 <sup>3</sup>	
200 KOMPRESSOR		09.95-04.00	132-141				LAB	BO	0 265 006 266 <sup>3</sup>							
							MET,RAB	BO	0 265 006 192 <sup>4</sup>							
							MET	BO	0 265 002 212 <sup>4</sup>							
							Fg.-Nr. →A809594, →F894083, 202...A/B/C/D/E, Komp.Nr. Code 806/809, <del>Komp.Nr. Code 800/805</del>	LAB	BO	0 265 006 266 <sup>3</sup>						
RAB	BO	0 265 006 264 <sup>3</sup>														
220		03.93-09.96	110				LAB,MET	BO	0 265 006 192 <sup>4</sup>							
							MET,RAB	BO	0 265 006 172 <sup>4</sup>							
							MET	BO	0 265 002 212 <sup>4</sup>							
							Fg.-Nr. →A344660, →F331440, Komp.Nr. Code 805, <del>Komp.Nr. Code 806</del>	LAB	BO	0 265 006 248 <sup>3</sup>						
							RAB	BO	0 265 006 242 <sup>3</sup>							
							OAS	03.93-09.95	110					LAB	BO	0 265 006 248 <sup>3</sup>
														RAB	BO	0 265 006 242 <sup>3</sup>
														LAB,MET	BO	0 265 006 192 <sup>4</sup>
														MET,RAB	BO	0 265 006 172 <sup>4</sup>
							220 CDI		12.97-04.00	92				MET	BO	0 265 002 212 <sup>4</sup>
Fg.-Nr. →A344660, →F331440, Komp.Nr. Code 805, <del>Komp.Nr. Code 806</del>	LAB	BO	0 265 006 248 <sup>3</sup>													
RAB	BO	0 265 006 242 <sup>3</sup>														
Fg.-Nr. A334661→, 202...A/B/D/E, Komp.Nr. Code 806/809, <del>Komp.Nr. Code 800/805</del>	LAB	BO	0 265 006 266 <sup>3</sup>													
RAB	BO	0 265 006 264 <sup>3</sup>														
220 D		08.93-06.99	55-70											LAB	BO	0 265 006 248 <sup>3</sup>
														RAB	BO	0 265 006 242 <sup>3</sup>
														LAB,MET	BO	0 265 006 192 <sup>4</sup>
														MET,RAB	BO	0 265 006 172 <sup>4</sup>
MET	BO	0 265 002 212 <sup>4</sup>														
220 D		08.93-06.99	55-70				LAB	BO	0 265 006 248 <sup>3</sup>							
							RAB	BO	0 265 006 242 <sup>3</sup>							
							LAB,MET	BO	0 265 006 192 <sup>4</sup>							
							MET,RAB	BO	0 265 006 172 <sup>4</sup>							
MET	BO	0 265 002 212 <sup>4</sup>														



◀ MERCEDES-BENZ Serie C [202]										
220 D	08.93-06.99	55-70	Fg.-Nr. →A344660, →F331440, Komp.Nr. Code 805, Komp.Nr. Code 806	LAB	BO	0 265	<b>006 248<sup>3</sup></b>			
				RAB	BO	0 265	<b>006 242<sup>3</sup></b>			
				Fg.-Nr. A334661→, F331441→, 202...A/B/D/E, Komp.Nr. Code 806/809, Komp.Nr. Code 800/805	LAB	BO	0 265	<b>006 266<sup>3</sup></b>		
220	09.96-08.98	110	Fg.-Nr. A344661→, F331441→, 202...A/B/C/D/E, Komp.Nr. Code 806/809, Komp.Nr. Code 800/805	RAB	BO	0 265	<b>006 264<sup>3</sup></b>			
				LAB	BO	0 265	<b>006 266<sup>3</sup></b>			
				LAB,MET	BO	0 265	<b>006 192<sup>4</sup></b>			
230	09.96-08.98	110		MET,RAB	BO	0 265	<b>006 172<sup>4</sup></b>			
				MET	BO	0 265	<b>002 212<sup>4</sup></b>			
				RAB	BO	0 265	<b>006 264<sup>3</sup></b>			
230 KOMPRESSOR	09.95-04.00	142		LAB,MET	BO	0 265	<b>006 192<sup>4</sup></b>			
				MET,RAB	BO	0 265	<b>006 172<sup>4</sup></b>			
				MET	BO	0 265	<b>002 212<sup>4</sup></b>			
230 KOMPRESSOR	09.95-04.00	142	Fg.-Nr. →A809594, →F894083, 202...A/B/C/D/E, Komp.Nr. Code 806/809, Komp.Nr. Code 800/805	LAB	BO	0 265	<b>006 266<sup>3</sup></b>			
				RAB	BO	0 265	<b>006 264<sup>3</sup></b>			
				LAB,MET	BO	0 265	<b>006 192<sup>4</sup></b>			
240	06.97-04.00	125		MET,RAB	BO	0 265	<b>006 172<sup>4</sup></b>			
				MET	BO	0 265	<b>002 212<sup>4</sup></b>			
				Fg.-Nr. 202...A/B/C/D/E	LAB	BO	0 265	<b>006 266<sup>3</sup></b>		
250 D	05.93-08.95	83		RAB	BO	0 265	<b>006 264<sup>3</sup></b>			
				LAB,MET	BO	0 265	<b>006 192<sup>4</sup></b>			
				MET,RAB	BO	0 265	<b>006 172<sup>4</sup></b>			
250 D	05.93-08.95	83	Fg.-Nr. →A344660, →F331440, Komp.Nr. Code 805, Komp.Nr. Code 806	MET	BO	0 265	<b>002 212<sup>4</sup></b>			
				LAB	BO	0 265	<b>006 248<sup>3</sup></b>			
				RAB	BO	0 265	<b>006 242<sup>3</sup></b>			
250 D Turbo	09.95-04.00	110		LAB,MET	BO	0 265	<b>006 192<sup>4</sup></b>			
				MET,RAB	BO	0 265	<b>006 172<sup>4</sup></b>			
				MET	BO	0 265	<b>002 212<sup>4</sup></b>			
250 D Turbo	09.95-04.00	110	Fg.-Nr. →A344660, →F331440, Komp.Nr. Code 805, Komp.Nr. Code 806	LAB	BO	0 265	<b>006 248<sup>3</sup></b>			
				RAB	BO	0 265	<b>006 242<sup>3</sup></b>			
				Fg.-Nr. A334661→A809594, F331441→F894083, 202...A/B/C/D/E, Komp.Nr. Code 806/809, Komp.Nr. Code 800/805	LAB	BO	0 265	<b>006 266<sup>3</sup></b>		
250 D Turbo	09.95-04.00	110	Fg.-Nr. A344661→A809594, F331441→F894083, 202...A/B/C/D/E, Komp.Nr. Code 806/809, Komp.Nr. Code 800/805	RAB	BO	0 265	<b>006 264<sup>3</sup></b>			
				LAB	BO	0 265	<b>006 248<sup>3</sup></b>			
				LAB,MET	BO	0 265	<b>006 192<sup>4</sup></b>			
280	05.93-05.97	142		MET,RAB	BO	0 265	<b>006 172<sup>4</sup></b>			
				MET	BO	0 265	<b>002 212<sup>4</sup></b>			
				Fg.-Nr. →A344660, →F331440, Komp.Nr. Code 805, Komp.Nr. Code 806	LAB	BO	0 265	<b>006 248<sup>3</sup></b>		
280	05.93-05.97	142	Fg.-Nr. A334661→A809594, F331441→F894083, 202...A/B/C/D/E, Komp.Nr. Code 806/809, Komp.Nr. Code 800/805	RAB	BO	0 265	<b>006 242<sup>3</sup></b>			
				LAB	BO	0 265	<b>006 266<sup>3</sup></b>			
				LAB,MET	BO	0 265	<b>006 192<sup>4</sup></b>			



		<b>S</b>							
<b>280</b>		05.93-05.97	142	Fg.-Nr. A344661→A809594, F331441→F894083, 202...A/B/C/D/E, Komp.Nr. Code 806/809, Komp.Nr. Code 800/805	RAB	BO	0 265 006 264 <sup>3</sup>		
		06.97-08.00	145		LAB,MET	BO	0 265 006 192 <sup>4</sup>		
					MET,RAB	BO	0 265 006 172 <sup>4</sup>		
					MET	BO	0 265 002 212 <sup>4</sup>		
				Fg.-Nr. 202...A/B/C/D/E	LAB	BO	0 265 006 266 <sup>3</sup>		
					RAB	BO	0 265 006 264 <sup>3</sup>		

**Serie C [203]**

		<b>180</b>	10.00-08.02	95			0 986 473 220		← 57
							0 986 474 220		→ 57
		<b>180 KOMPRESSOR</b>	09.02-07.07	105		SBJ	0 986 473 220		← 57
							0 986 474 220		→ 57
					Fg.-Nr. A 660227→, F 565689→, R 138318→, Fg.-Nr. R 141125	SBJ	0 986 134 076		← 57
							0 986 135 076		→ 57
		<b>200 CDI</b>	10.00-07.07	75/85/90		ATP	0 986 473 220		← 57
							0 986 474 220		→ 57
		<b>200 CGI KOMPRESSOR</b>	04.03-04.05	125		ATP	0 986 473 220		← 57
							0 986 474 220		→ 57
		<b>200 KOMPRESSOR</b>	05.00-08.02	120			0 986 473 220		← 57
			09.02-02.07	120		SBJ	0 986 474 220		→ 57
					Fg.-Nr. A 660227→, F 565689→, R 138318→, Fg.-Nr. R 141125	SBJ	0 986 134 076		← 57
							0 986 135 076		→ 57
		<b>220 CDI</b>	05.00-02.07	100-110		ATP	0 986 473 220		← 57
							0 986 474 220		→ 57
		<b>230</b>	06.05-07.07	150		SBJ	0 986 134 076		← 57
							0 986 135 076		→ 57
						SBJ	0 986 473 490		← 57
							0 986 474 490		→ 57
		<b>230 KOMPRESSOR</b>	02.04-05.05	141		SBJ	0 986 473 490		← 57
					Fg.-Nr. A 660227→, F 565689→, R 138318→, Fg.-Nr. R 141125	SBJ	0 986 134 076		← 57
							0 986 135 076		→ 57
		<b>240</b>	05.00-05.05	125		ATP	0 986 473 490		← 57
							0 986 474 490		→ 57
		<b>240 4MATIC</b>	09.02-06.05	125			0 986 473 524		← 57
							0 986 474 524		→ 57
		<b>270 CDI</b>	12.00-08.04	125		ATP	0 986 473 490		← 57
							0 986 474 490		→ 57
		<b>280</b>	09.05-02.07	170		SBJ	0 986 473 490		← 57
							0 986 474 490		→ 57
		<b>280</b>	09.05-08.07	170		SBJ	0 986 134 076		← 57
		<b>280 4MATIC</b>					0 986 135 076		→ 57
		<b>280 4MATIC</b>	09.05-08.07	170		SBJ	0 986 473 524		← 57
							0 986 474 524		→ 57
		<b>320</b>	05.00-05.05	160		SBJ	0 986 473 490		← 57
							0 986 474 490		→ 57
					Fg.-Nr. A 660227→, F 565689→, E 019385→, R 138318→	SBJ	0 986 134 076		← 57
							0 986 135 076		→ 57
		<b>320 CDI</b>	09.04-05.07	165		ATP	0 986 473 490		← 57
							0 986 474 490		→ 57





		S							
<b>◀ MERCEDES-BENZ Serie C [203]</b>									
<b>320 4MATIC</b>		09.02-06.05	160				0986 473 524		57
							0986 474 524		57
<b>350</b>		06.05-02.07	200		ATP		0986 473 490		57
							0986 474 490		57
<b>350 4MATIC</b>		07.05-08.07	200				0986 473 524		57
							0986 474 524		57
<hr/>									
<b>30 AMG CDI</b>		01.03-08.04	170						1987 470 084
<b>32 AMG KOMPRESSOR</b>		01.01-01.04	260						1987 470 084
<b>55 AMG</b>		02.04-08.07	270						1987 470 084
<b>180</b>		10.00-08.02	95				0986 473 282		36
							0986 474 282		36
<b>180 KOMPRESSOR</b>		09.02-07.07	105		SBJ		0986 134 061		36
							0986 135 061		36
					SBJ		0986 473 282		36
							0986 474 282		36
<b>200 CDI</b>		10.00-07.07	75/85/90		ATP		0986 134 061		36
							0986 135 061		36
					ATP		0986 473 282		36
							0986 474 282		36
<b>200 CGI KOMPRESSOR</b>		04.03-04.05	125		ATP		0986 134 061		36
							0986 135 061		36
					ATP		0986 473 282		36
							0986 474 282		36
<b>200 KOMPRESSOR</b>		05.00-08.02	120				0986 473 282		36
							0986 474 282		36
		09.02-02.07	120		SBJ		0986 134 061		36
							0986 135 061		36
					SBJ		0986 473 282		36
							0986 474 282		36
<b>220 CDI</b>		05.00-02.07	100-110		ATP		0986 134 061		36
							0986 135 061		36
					ATP		0986 473 282		36
							0986 474 282		36
<b>230</b>		06.05-07.07	150		SBJ		0986 134 061		36
							0986 135 061		36
					SBJ		0986 134 039		36
							0986 134 061		36
							0986 473 282		36
							0986 135 039		36
							0986 135 061		36
<b>230 KOMPRESSOR</b>		02.04-05.05	141		SBJ		0986 134 061		36
							0986 135 061		36
					SBJ		0986 134 039		36
							0986 134 061		36
							0986 135 039		36
							0986 135 061		36
<b>240</b>		05.00-06.05	125				0986 134 039		36
<b>240 4MATIC</b>							0986 134 061		36
							0986 135 039		36
							0986 135 061		36
<b>270 CDI</b>		12.00-08.04	125		ATP		0986 134 061		36
							0986 135 061		36
					ATP		0986 134 039		36
							0986 134 061		36
							0986 135 039		36
							0986 135 061		36



		S							
<b>280</b> <b>280 4MATIC</b>		09.05-08.07	170			SBJ	0 986 134 061	← 36	1 987 470 084
							0 986 135 061	→ 36	1 987 470 084
						SBJ	0 986 134 039	←	1 987 470 084
							0 986 134 061	←	
							0 986 135 039	→	1 987 470 084
							0 986 135 061	→	
<b>320</b>		05.00-05.05	160			SBJ	0 986 134 061	← 36	1 987 470 084
							0 986 135 061	→ 36	1 987 470 084
						SBJ	0 986 134 039	←	1 987 470 084
							0 986 134 061	←	
							0 986 135 039	→	1 987 470 084
							0 986 135 061	→	
<b>320 CDI</b>		09.04-05.07	165				0 986 134 061	← 36	1 987 470 084
							0 986 135 061	→ 36	1 987 470 084
<b>320 4MATIC</b>		09.02-06.05	160			ATP	0 986 134 061	← 36	1 987 470 084
							0 986 135 061	→ 36	1 987 470 084
						ATP	0 986 134 039	←	1 987 470 084
							0 986 134 061	←	
							0 986 135 039	→	1 987 470 084
							0 986 135 061	→	
<b>350</b> <b>350 4MATIC</b>		06.05-08.07	200			ATP	0 986 134 061	← 36	1 987 470 084
							0 986 135 061	→ 36	1 987 470 084
						ATP	0 986 134 039	←	1 987 470 084
							0 986 134 061	←	
							0 986 135 039	→	1 987 470 084
							0 986 135 061	→	
	<b>30 AMG CDI</b>	01.03-08.04	170				1 987 477 846	← 925	
							1 987 477 847	→ 900	
						LLE	1 987 477 845	2735	
						RLE	1 987 477 848	2160	
<b>32 AMG KOMPRESSOR</b>		01.01-01.04	260				1 987 477 846	← 925	
							1 987 477 847	→ 900	
						LLE	1 987 477 845	2735	
						RLE	1 987 477 848	2160	
<b>55 AMG</b>		02.04-08.07	270				1 987 477 846	← 925	
							1 987 477 847	→ 900	
						LLE	1 987 477 845	2735	
						RLE	1 987 477 848	2160	
<b>180</b> <b>180 KOMPRESSOR</b>		10.00-07.07	95/105				1 987 477 846	← 925	
							1 987 477 847	→ 900	
						LLE	1 987 477 845	2735	
						RLE	1 987 477 848	2160	
<b>200 CDI</b>		05.00-07.07	75/85/90/				1 987 477 846	← 925	
<b>200 CGI KOMPRESSOR</b>			120/125				1 987 477 847	→ 900	
<b>200 KOMPRESSOR</b>						LLE	1 987 477 845	2735	
						RLE	1 987 477 848	2160	
<b>220 CDI</b>		05.00-02.07	100-110				1 987 477 846	← 925	
							1 987 477 847	→ 900	
						LLE	1 987 477 845	2735	
						RLE	1 987 477 848	2160	
<b>230</b> <b>230 KOMPRESSOR</b>		02.04-07.07	141/150				1 987 477 846	← 925	
							1 987 477 847	→ 900	
						LLE	1 987 477 845	2735	
						RLE	1 987 477 848	2160	
<b>240</b> <b>240 4MATIC</b>		05.00-06.05	125				1 987 477 846	← 925	
							1 987 477 847	→ 900	
						LLE	1 987 477 845	2735	
						RLE	1 987 477 848	2160	

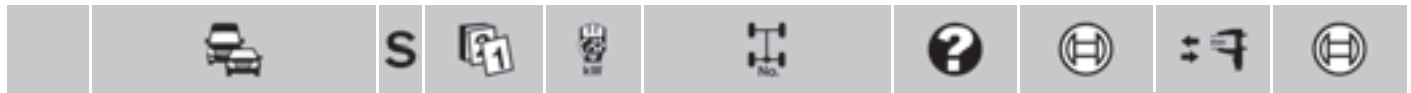



MERCEDES-BENZ Serie C [203]						
<b>270 CDI</b>	12.00-08.04	125		1987 477 846	← 925	
				1987 477 847	→ 900	
			LLE	1987 477 845	2735	
			RLE	1987 477 848	2160	
<b>280</b> <b>280 4MATIC</b>	09.05-08.07	170		1987 477 846	← 925	
				1987 477 847	→ 900	
			LLE	1987 477 845	2735	
			RLE	1987 477 848	2160	
<b>320</b> <b>320 CDI</b> <b>320 4MATIC</b>	05.00-05.07	160/165		1987 477 846	← 925	
				1987 477 847	→ 900	
			LLE	1987 477 845	2735	
			RLE	1987 477 848	2160	
<b>350</b> <b>350 4MATIC</b>	06.05-08.07	200		1987 477 846	← 925	
				1987 477 847	→ 900	
			LLE	1987 477 845	2735	
			RLE	1987 477 848	2160	
 <b>30 AMG CDI</b>	01.03-08.04	170		0986 594 543 <sup>3</sup>		
			LAB	0986 594 541 <sup>4</sup>		
			RAB	0986 594 542 <sup>4</sup>		
<b>32 AMG KOMPRESSOR</b>	01.01-01.04	260		0986 594 543 <sup>3</sup>		
			LAB	0986 594 541 <sup>4</sup>		
			RAB	0986 594 542 <sup>4</sup>		
<b>55 AMG</b>	02.04-08.07	270		0986 594 543 <sup>3</sup>		
			LAB	0986 594 541 <sup>4</sup>		
			RAB	0986 594 542 <sup>4</sup>		
<b>180</b> <b>180 KOMPRESSOR</b>	10.00-07.07	95/105		0986 594 543 <sup>3</sup>		
			LAB	0986 594 541 <sup>4</sup>		
			RAB	0986 594 542 <sup>4</sup>		
<b>200 CDI</b> <b>200 CGI KOMPRESSOR</b> <b>200 KOMPRESSOR</b>	05.00-07.07	75/85/90/ 120/125		0986 594 543 <sup>3</sup>		
			LAB	0986 594 541 <sup>4</sup>		
			RAB	0986 594 542 <sup>4</sup>		
<b>220 CDI</b>	05.00-02.07	100-110		0986 594 543 <sup>3</sup>		
			LAB	0986 594 541 <sup>4</sup>		
			RAB	0986 594 542 <sup>4</sup>		
<b>230</b> <b>230 KOMPRESSOR</b>	02.04-07.07	141/150		0986 594 543 <sup>3</sup>		
			LAB	0986 594 541 <sup>4</sup>		
			RAB	0986 594 542 <sup>4</sup>		
<b>240</b>	05.00-05.05	125		0986 594 543 <sup>3</sup>		
<b>240 4MATIC</b>	05.00-06.05	125	LAB	0986 594 541 <sup>4</sup>		
			RAB	0986 594 542 <sup>4</sup>		
<b>240 4MATIC</b>	09.02-06.05	125		0986 594 544 <sup>3</sup>		
<b>270 CDI</b>	12.00-08.04	125		0986 594 543 <sup>3</sup>		
			LAB	0986 594 541 <sup>4</sup>		
			RAB	0986 594 542 <sup>4</sup>		
<b>280</b>	09.05-02.07	170		0986 594 543 <sup>3</sup>		
<b>280 4MATIC</b>	09.05-08.07	170	LAB	0986 594 541 <sup>4</sup>		
			RAB	0986 594 542 <sup>4</sup>		
<b>280 4MATIC</b>	09.05-08.07	170		0986 594 544 <sup>3</sup>		
<b>320</b>	05.00-05.05	160		0986 594 543 <sup>3</sup>		
<b>320 4MATIC</b>	05.00-06.05	160	LAB	0986 594 541 <sup>4</sup>		
			RAB	0986 594 542 <sup>4</sup>		
<b>320 CDI</b>	09.04-05.07	165		0986 594 543 <sup>3</sup>		
			LAB	0986 594 541 <sup>4</sup>		
			RAB	0986 594 542 <sup>4</sup>		
<b>320 4MATIC</b>	09.02-06.05	160		0986 594 544 <sup>3</sup>		
<b>350</b>	06.05-02.07	200		0986 594 543 <sup>3</sup>		
<b>350 4MATIC</b>	06.05-08.07	200	LAB	0986 594 541 <sup>4</sup>		
			RAB	0986 594 542 <sup>4</sup>		
<b>350 4MATIC</b>	07.05-08.07	200		0986 594 544 <sup>3</sup>		



**Serie C [204]**

Model	Year Range	Power (kW)	Market	Part Number	Direction	Part Number	Direction
<b>180 CDI</b>	10.10-12.14	88	SBJ	0 986 134 322	←	60	
				0 986 135 322	→	60	
<b>180 CGI</b>	01.09-12.14	115	SBJ	0 986 134 322	←	60	
				0 986 135 322	→	60	
<b>180 KOMPRESSOR</b>	01.07-10.08	115	ATP	0 986 134 322	←	60	
				0 986 135 322	→	60	
	04.08-04.10	115	SBJ	0 986 134 322	←	60	
				0 986 135 322	→	60	
<b>200 CDI</b>	01.07-12.10	100	ATP	0 986 134 322	←	60	
				0 986 135 322	→	60	
	04.08-12.14	100	SBJ	0 986 134 322	←	60	
				0 986 135 322	→	60	
<b>200 CGI</b>	03.07-12.14	135	SBJ	0 986 134 322	←	60	
<b>200 KOMPRESSOR</b>				0 986 135 322	→	60	
<b>220 CDI</b>	03.07→	120-125	SBJ	0 986 134 322	←	60	
				0 986 135 322	→	60	
<b>230</b>	08.07-04.09	150	ATP	0 986 134 322	←	60	
<b>230 4MATIC</b>				0 986 135 322	→	60	
<b>250 CDI</b>	09.08→	150	SBJ	0 986 134 322	←	60	
<b>250 CGI</b>				0 986 135 322	→	60	
<b>180 CDI</b>	10.10-12.14	88	AGH	0 986 134 333	←	38	1 987 470 506 <sup>B</sup>
				0 986 135 333	→	38	1 987 470 506 <sup>B</sup>
			GEM	0 986 134 321	←	38	1 987 470 506 <sup>B</sup>
				0 986 135 321	→	38	1 987 470 506 <sup>B</sup>
<b>180 CGI</b>	01.09-04.12	115	AGH	0 986 134 333	←	38	1 987 470 506 <sup>B</sup>
				0 986 135 333	→	38	1 987 470 506 <sup>B</sup>
			GEM	0 986 134 321	←	38	1 987 470 506 <sup>B</sup>
				0 986 135 321	→	38	1 987 470 506 <sup>B</sup>
	04.12-12.14	115		0 986 134 333	←	38	1 987 470 506 <sup>B</sup>
				0 986 135 333	→	38	1 987 470 506 <sup>B</sup>
<b>180 KOMPRESSOR</b>	01.07-10.08	115	AGH	0 986 134 333	←	38	1 987 470 506 <sup>B</sup>
				0 986 135 333	→	38	1 987 470 506 <sup>B</sup>
			GEM	0 986 134 321	←	38	1 987 470 506 <sup>B</sup>
				0 986 135 321	→	38	1 987 470 506 <sup>B</sup>
	04.08-04.10	115		0 986 134 321	←	38	1 987 470 506 <sup>B</sup>
				0 986 135 321	→	38	1 987 470 506 <sup>B</sup>
<b>200 CDI</b>	01.07-12.10	100		0 986 134 321	←	38	1 987 470 506 <sup>B</sup>
				0 986 135 321	→	38	1 987 470 506 <sup>B</sup>
	04.08-12.14	100	AGH	0 986 134 333	←	38	1 987 470 506 <sup>B</sup>
				0 986 135 333	→	38	1 987 470 506 <sup>B</sup>
			GEM	0 986 134 321	←	38	1 987 470 506 <sup>B</sup>
				0 986 135 321	→	38	1 987 470 506 <sup>B</sup>
<b>200 CGI</b>	04.09-12.14	135	AGH	0 986 134 333	←	38	1 987 470 506 <sup>B</sup>
				0 986 135 333	→	38	1 987 470 506 <sup>B</sup>
			GEM	0 986 134 321	←	38	1 987 470 506 <sup>B</sup>
				0 986 135 321	→	38	1 987 470 506 <sup>B</sup>
<b>200 KOMPRESSOR</b>	03.07-04.10	135		0 986 134 321	←	38	1 987 470 506 <sup>B</sup>
				0 986 135 321	→	38	1 987 470 506 <sup>B</sup>
<b>220 CDI</b>	03.07-04.09	120-125		0 986 134 321	←	38	1 987 470 506 <sup>B</sup>
				0 986 135 321	→	38	1 987 470 506 <sup>B</sup>
<b>220 CDI</b>	12.08→	125	AGH	0 986 134 333	←	38	1 987 470 506 <sup>B</sup>
<b>220 CDI 4MATIC</b>				0 986 135 333	→	38	1 987 470 506 <sup>B</sup>
			GEM	0 986 134 321	←	38	1 987 470 506 <sup>B</sup>
				0 986 135 321	→	38	1 987 470 506 <sup>B</sup>
<b>230</b>	08.07-04.09	150		0 986 134 321	←	38	1 987 470 506 <sup>B</sup>
<b>230 4MATIC</b>				0 986 135 321	→	38	1 987 470 506 <sup>B</sup>





		S								
◀ MERCEDES-BENZ Serie C [204]										
250 CDI	09.08→	150					AGH		1987 470 506 <sup>8</sup>	
							GEM		1987 470 506 <sup>8</sup>	
250 CDI 4MATIC	04.10→	150					SBJ,TW	0986 134 321	38 1987 470 506 <sup>8</sup>	
								0986 134 333	38 1987 470 506 <sup>8</sup>	
								0986 135 321	38 1987 470 506 <sup>8</sup>	
								0986 135 333	38 1987 470 506 <sup>8</sup>	
							SBJ,TW		1987 470 506 <sup>8</sup>	
250 CGI	04.09→	150					TW	0986 134 321	38 1987 470 506 <sup>8</sup>	
								0986 134 333	38 1987 470 506 <sup>8</sup>	
								0986 135 321	38 1987 470 506 <sup>8</sup>	
								0986 135 333	38 1987 470 506 <sup>8</sup>	
280	03.07-04.09	170						0986 134 321	38 1987 470 506 <sup>8</sup>	
280 4MATIC								0986 135 321	38 1987 470 506 <sup>8</sup>	
300	05.09-01.11	170					TW	0986 134 321	38 1987 470 506 <sup>8</sup>	
								0986 134 333	38 1987 470 506 <sup>8</sup>	
								0986 135 321	38 1987 470 506 <sup>8</sup>	
								0986 135 333	38 1987 470 506 <sup>8</sup>	
300 CDI 4MATIC	03.11→	170					AGH		1987 470 506 <sup>8</sup>	
							GEM		1987 470 506 <sup>8</sup>	
300 CGI, CGI 4MATIC	08.12→	185							1987 470 506 <sup>8</sup>	
300 4MATIC	05.09-01.11	170						0986 134 321	38 1987 470 506 <sup>8</sup>	
								0986 135 321	38 1987 470 506 <sup>8</sup>	
320 CDI, CDI 4MATIC	06.07-04.09	165							1987 470 506 <sup>8</sup>	
350	03.07-12.10	200					AGH		1987 470 506 <sup>8</sup>	
							GEM		1987 470 506 <sup>8</sup>	
350 CDI	05.09-09.10	165					AGH		1987 470 506 <sup>8</sup>	
							GEM		1987 470 506 <sup>8</sup>	
	02.11→	195					AGH		1987 470 506 <sup>8</sup>	
							GEM		1987 470 506 <sup>8</sup>	
350 CDI 4MATIC	05.09-09.09	165							1987 470 506 <sup>8</sup>	
350 CDI, CDI 4MATIC	10.09→	170							1987 470 506 <sup>8</sup>	
350 CGI, CGI 4MATIC	09.08→	215/225							1987 470 506 <sup>8</sup>	
350 4MATIC	07.07-12.10	200							1987 470 506 <sup>8</sup>	
63 AMG	02.08-12.14	336/358/ 373						1987 482 301		728
							LLE	1987 482 331		2057
							MI	1987 482 332		1152
							RLE	1987 482 330		1637
180 CDI	10.10-12.14	88						1987 482 301		728
								1987 482 331		2057
							MI	1987 482 332		1152
180 CGI	01.09-12.14	115						1987 482 301		728
180 CGI	01.07-12.14	115					LLE	1987 482 331		2057
180 KOMPRESSOR							MI	1987 482 332		1152
							RLE	1987 482 330		1637
180 KOMPRESSOR	01.07-04.10	115						1987 482 301		728
200 CDI	01.07-12.14	100/135						1987 482 301		728
200 CDI	01.07-12.14	100/135					LLE	1987 482 331		2057
200 CGI							MI	1987 482 332		1152
200 KOMPRESSOR							RLE	1987 482 330		1637
200 CGI	04.09-12.14	100/135						1987 482 301		728
200 KOMPRESSOR	03.07-04.10	100/135						1987 482 301		728
220 CDI	03.07→	120-125						1987 482 301		728
220 CDI 4MATIC	03.13→	120-125						1987 482 301		728
220 CDI	03.07→	120-125					LLE	1987 482 331		2057
220 CDI 4MATIC							MI	1987 482 332		1152
							RLE	1987 482 330		1637
230	08.07-04.09	150						1987 482 301		728
230	08.07-04.09	150					LLE	1987 482 331		2057
230 4MATIC							MI	1987 482 332		1152
							RLE	1987 482 330		1637

		S							
<b>230 4MATIC</b>		08.07-04.09	150				1 987 482 301	↔ 728	
<b>250 CDI</b>		09.08→	150				1 987 482 301	↔ 728	
						LLE	1 987 482 331	2057	
<b>250 CDI 4MATIC</b>		04.10→	150				1 987 482 301	↔ 728	
							1 987 482 331	2057	
<b>250 CDI, CDI 4MATIC, CGI</b>		09.08→	150			MI	1 987 482 332	1152	
<b>250 CDI, CGI</b>		09.08→	150			RLE	1 987 482 330	1637	
<b>250 CGI</b>		04.09→	150				1 987 482 301	↔ 728	
						LLE	1 987 482 331	2057	
<b>280</b>		03.07-04.09	170				1 987 482 301	↔ 728	
<b>280</b>		03.07-04.09	170			LLE	1 987 482 331	2057	
<b>280 4MATIC</b>						MI	1 987 482 332	1152	
						RLE	1 987 482 330	1637	
<b>280 4MATIC</b>		07.07-04.09	170				1 987 482 301	↔ 728	
<b>300</b>		05.09-01.11	170				1 987 482 301	↔ 728	
<b>300</b>		05.09-01.11	170			LLE	1 987 482 331	2057	
<b>300 4MATIC</b>						MI	1 987 482 332	1152	
						RLE	1 987 482 330	1637	
<b>300 CGI</b>		08.12→	185				1 987 482 301	↔ 728	
						LLE	1 987 482 331	2057	
						RLE	1 987 482 330	1637	
<b>300 CGI 4MATIC</b>		08.12→	185				1 987 482 301	↔ 728	
							1 987 482 331	2057	
<b>300 CGI, CGI 4MATIC</b>		08.12→	185			MI	1 987 482 332	1152	
<b>300 4MATIC</b>		05.09-01.11	170				1 987 482 301	↔ 728	
<b>320 CDI</b>		06.07-04.09	165				1 987 482 301	↔ 728	
<b>320 CDI 4MATIC</b>		07.07-04.09	165				1 987 482 301	↔ 728	
<b>320 CDI</b>		06.07-04.09	165			LLE	1 987 482 331	2057	
<b>320 CDI 4MATIC</b>						MI	1 987 482 332	1152	
						RLE	1 987 482 330	1637	
<b>350</b>		03.07-12.10	195/200/215/225				1 987 482 301	↔ 728	
<b>350, CDI, CGI, CGI 4MATIC, 4MATIC</b>		03.07→	195/200/ 215/225			LLE	1 987 482 331	2057	
						MI	1 987 482 332	1152	
						RLE	1 987 482 330	1637	
<b>350 CDI</b>		05.09-09.10	165				1 987 482 301	↔ 728	
		10.09-01.11	170				1 987 482 301	↔ 728	
						LLE	1 987 482 331	2057	
						RLE	1 987 482 330	1637	
		02.11→	195/200/215/225				1 987 482 301	↔ 728	
<b>350 CDI 4MATIC</b>		05.09-09.09	165				1 987 482 301	↔ 728	
		10.09→	170				1 987 482 301	↔ 728	
							1 987 482 331	2057	
<b>350 CDI</b>		05.09-09.10	165			LLE	1 987 482 331	2057	
<b>350 CDI 4MATIC</b>						MI	1 987 482 332	1152	
						RLE	1 987 482 330	1637	
		10.09→	170			MI	1 987 482 332	1152	
<b>350 CGI</b>		09.08→	195/200/215/225				1 987 482 301	↔ 728	
<b>350 CGI 4MATIC</b>		01.11→	195/200/215/225				1 987 482 301	↔ 728	
<b>350 4MATIC</b>		07.07-12.10	195/200/215/225				1 987 482 301	↔ 728	
<b>63 AMG</b>		02.08-12.14	336/358/373				0 986 594 546 <sup>4</sup>		
<b>180 CDI</b>		10.10-12.14	88				0 986 594 546 <sup>4</sup>		
						Mod.Jahr →2010	0 986 594 545 <sup>3</sup>		
						Mod.Jahr 2011→	0 986 594 548 <sup>3</sup>		
<b>180 CGI</b>		01.09-04.12	115			Komp.Nr. 809, Komp.Nr. 800, Komp.Nr. 801	0 986 594 545 <sup>3</sup>		
		04.12-12.14	115				0 986 594 548 <sup>3</sup>		
<b>180 CGI, KOMPRESSOR</b>		01.07-12.14	115				0 986 594 546 <sup>4</sup>		
<b>180 KOMPRESSOR</b>		01.07-10.08	115			Mod.Jahr →2010	0 986 594 545 <sup>3</sup>		
						Mod.Jahr 2011→	0 986 594 548 <sup>3</sup>		
		04.08-04.10	115				0 986 594 545 <sup>3</sup>		
<b>200 CDI</b>		01.07-12.10	100			Komp.Nr. 809, Komp.Nr. 800, Komp.Nr. 801	0 986 594 545 <sup>3</sup>		
		01.07-12.14	100				0 986 594 546 <sup>4</sup>		
		04.08-12.14	100			Mod.Jahr →2010	0 986 594 545 <sup>3</sup>		



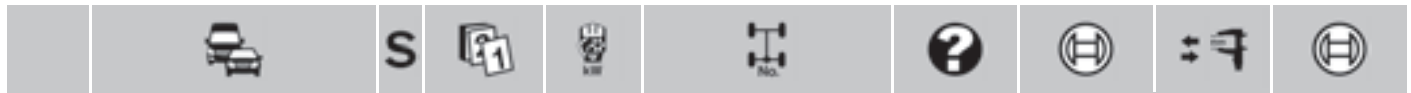

**MERCEDES-BENZ Serie C [204]**

<b>200 CGI</b>	04.09-12.14	135		0986 594 546 <sup>4</sup>
<b>200 CGI, KOMPRESSOR</b>	03.07-12.14	135	Mod.Jahr →2010	0986 594 545 <sup>3</sup>
<b>200 KOMPRESSOR</b>	03.07-04.10	135		0986 594 546 <sup>4</sup>
			Mod.Jahr 2011→	0986 594 548 <sup>3</sup>
<b>220 CDI</b>	03.07-04.09	120-125		0986 594 545 <sup>3</sup>
	12.08→	125		0986 594 546 <sup>4</sup>
			Mod.Jahr →2010	0986 594 545 <sup>3</sup>
<b>220 CDI 4MATIC</b>	03.13→	125		0986 594 546 <sup>4</sup>
<b>230</b>	08.07-04.09	150		0986 594 545 <sup>3</sup>
<b>230 4MATIC</b>				0986 594 546 <sup>4</sup>
<b>250</b>	05.09-12.10	150	Komp.Nr. 809, Komp.Nr. 800, Komp.Nr. 801	0986 594 545 <sup>3</sup>
<b>250, CDI, CDI 4MATIC, CGI</b>	09.08→	150		0986 594 546 <sup>4</sup>
<b>250 CDI, CGI</b>	09.08→	150	Mod.Jahr →2010	0986 594 545 <sup>3</sup>
<b>250 4MATIC</b>	09.09→			0986 594 546 <sup>4</sup>
			Komp.Nr. 809, Komp.Nr. 800, Komp.Nr. 801	0986 594 545 <sup>3</sup>
<b>280</b>	03.07-04.09	170	Mod.Jahr →2010	0986 594 545 <sup>3</sup>
			Mod.Jahr 2011→	0986 594 548 <sup>3</sup>
<b>280, 4MATIC</b>	03.07-04.09	170		0986 594 546 <sup>4</sup>
<b>280 4MATIC</b>	07.07-04.09	170		0986 594 545 <sup>3</sup>
<b>300</b>	05.09-01.11	170		0986 594 546 <sup>4</sup>
<b>300, 4MATIC</b>	05.09-01.11	170	Komp.Nr. 809, Komp.Nr. 800, Komp.Nr. 801	0986 594 545 <sup>3</sup>
<b>300 CDI 4MATIC</b>	03.11→	170		0986 594 546 <sup>4</sup>
<b>300 CGI</b>	08.12→	185		0986 594 548 <sup>3</sup>
<b>300 CGI, CGI 4MATIC</b>	08.12→	185		0986 594 546 <sup>4</sup>
<b>300 4MATIC</b>	05.09-01.11	170		0986 594 546 <sup>4</sup>
<b>320 CDI</b>	06.07-04.09	165		0986 594 545 <sup>3</sup>
				0986 594 546 <sup>4</sup>
<b>320 CDI 4MATIC</b>	07.07-04.09	165		0986 594 546 <sup>4</sup>
<b>350</b>	03.07-12.10	200		0986 594 546 <sup>4</sup>
<b>350 4MATIC</b>			Komp.Nr. 809, Komp.Nr. 800, Komp.Nr. 801	0986 594 545 <sup>3</sup>
<b>350 CDI</b>	05.09-09.10	165		0986 594 545 <sup>3</sup>
				0986 594 546 <sup>4</sup>
	10.09-01.11	170		0986 594 546 <sup>4</sup>
			Komp.Nr. 809, Komp.Nr. 800, Komp.Nr. 801	0986 594 545 <sup>3</sup>
	02.11→	195		0986 594 546 <sup>4</sup>
				0986 594 548 <sup>3</sup>
<b>350 CDI 4MATIC</b>	05.09-09.09	165		0986 594 546 <sup>4</sup>
	10.09→	170		0986 594 546 <sup>4</sup>
<b>350 CGI</b>	09.08-01.11	215		0986 594 546 <sup>4</sup>
			Mod.Jahr →2010	0986 594 545 <sup>3</sup>
	02.11→	225		0986 594 548 <sup>3</sup>
<b>350 CGI, CGI 4MATIC</b>	01.11→	225		0986 594 546 <sup>4</sup>

**Serie C [205]**



<b>63 AMG, S</b>	09.14→	350/375		1987 470 506 <sup>8</sup>
<b>160</b>	04.15→	95		1987 470 506 <sup>8</sup>
<b>180, BlueTec</b>	03.14→	85/115		1987 470 506 <sup>8</sup>
<b>200, BlueTec, 4MATIC</b>	12.13→	100/135		1987 470 506 <sup>8</sup>
<b>220 BlueTec, d 4MATIC</b>	11.13→	120/125		1987 470 506 <sup>8</sup>
<b>250</b>	03.14→	155	ATP	1987 470 506 <sup>8</sup>
			ATP	1987 470 506 <sup>8</sup>
<b>250 BlueTec, BlueTec 4MATIC</b>	02.14→	150		1987 470 506 <sup>8</sup>
<b>300</b>	10.14→	180	PRC,TW	1987 470 506 <sup>8</sup>
			TW	1987 470 506 <sup>8</sup>
<b>300 BlueTec Hybrid</b>	05.14→	150	ATP	1987 470 506 <sup>8</sup>
			ATP	1987 470 506 <sup>8</sup>
<b>350 e</b>	02.15→	155-237		1987 470 506 <sup>8</sup>
<b>400 4MATIC</b>	10.14→	245		1987 470 506 <sup>8</sup>
<b>450 AMG 4MATIC</b>	04.15→	270		1987 470 506 <sup>8</sup>



**Serie CL (Coupé) [140]**

	420	06.96-08.99	205			0 986 473 748		← 40
						0 986 473 749		→ 40
	500	06.96-08.99	235			0 986 473 748		← 40
						0 986 473 749		→ 40
	600	06.96-08.99	290			0 986 473 748		← 40
						0 986 473 749		→ 40

	420	06.96-08.99	205			1 987 477 749		← 1134
						1 987 477 750		→ 1109
	500	06.96-08.99	235			1 987 477 749		← 1134
						1 987 477 750		→ 1109
	600	06.96-08.99	290			1 987 477 749		← 1134
						1 987 477 750		→ 1109

	420	06.96-08.99	205		RLE	0 265 001 348 <sup>3</sup>		
				Fg.-Nr. →A 212244	LAB,LLE	0 265 001 406 <sup>3</sup>		
					LLE,RAB	0 265 001 402 <sup>3</sup>		
				Fg.-Nr. →A212244	LAB	0 265 002 218 <sup>4</sup>		
					RAB	0 265 002 216 <sup>4</sup>		
				Fg.-Nr. A 212245→A 290166	LAB,LLE	0 265 001 296 <sup>3</sup>		
					LLE,RAB	0 265 001 350 <sup>3</sup>		
				Fg.-Nr. A 290167→	LAB,LLE	0 265 006 276 <sup>3</sup>		
					LLE,RAB	0 265 006 274 <sup>3</sup>		
				Fg.-Nr. A212245→	LAB	0 265 006 182 <sup>4</sup>		
					RAB	0 265 006 180 <sup>4</sup>		
	500	06.96-08.99	235		RLE	0 265 001 348 <sup>3</sup>		
				Fg.-Nr. →A 212244	LAB,LLE	0 265 001 406 <sup>3</sup>		
					LLE,RAB	0 265 001 402 <sup>3</sup>		
				Fg.-Nr. A 212245→A 290166	LAB,LLE	0 265 001 296 <sup>3</sup>		
					LLE,RAB	0 265 001 350 <sup>3</sup>		
				Fg.-Nr. A 290167→	LAB,LLE	0 265 006 276 <sup>3</sup>		
					LLE,RAB	0 265 006 274 <sup>3</sup>		
		ASR 06.96-08.99	235	Fg.-Nr. →A212244	LAB	0 265 002 218 <sup>4</sup>		
					RAB	0 265 002 216 <sup>4</sup>		
				Fg.-Nr. A212245→	LAB	0 265 006 182 <sup>4</sup>		
					RAB	0 265 006 180 <sup>4</sup>		
		OAS 06.96-08.99	235			0 265 002 220 <sup>4</sup>		
	600	06.96-08.99	290		RLE	0 265 001 348 <sup>3</sup>		
				Fg.-Nr. →A 212244	LAB,LLE	0 265 001 406 <sup>3</sup>		
					LLE,RAB	0 265 001 402 <sup>3</sup>		
				Fg.-Nr. →A212244	LAB	0 265 002 218 <sup>4</sup>		
					RAB	0 265 002 216 <sup>4</sup>		
				Fg.-Nr. A 212245→A 290166	LAB,LLE	0 265 001 296 <sup>3</sup>		
					LLE,RAB	0 265 001 350 <sup>3</sup>		
				Fg.-Nr. A 290167→	LAB,LLE	0 265 006 276 <sup>3</sup>		
					LLE,RAB	0 265 006 274 <sup>3</sup>		
				Fg.-Nr. A212245→	LAB	0 265 006 182 <sup>4</sup>		
					RAB	0 265 006 180 <sup>4</sup>		

























**Serie CL (Coupé) [215]**

	55 AMG	09.99-08.02	265			1 987 477 899		← 992
						1 987 477 900		→ 978



		S				?			
◀ MERCEDES-BENZ Serie CL (Coupé) [215]									
	55 AMG	09.99-08.02	265				0 265 007 002 <sup>3</sup>		
				LAB		0 265 007 008 <sup>4</sup>			
							RAB		0 265 007 006 <sup>4</sup>
	55 AMG KOMPRESSOR	09.02-08.06	368				0 265 007 002 <sup>3</sup>		
							LAB		0 265 007 121 <sup>4</sup>
							RAB		0 265 007 123 <sup>4</sup>
	65 AMG	09.03-08.06	450				0 265 007 128 <sup>3</sup>		
							LAB		0 265 007 121 <sup>4</sup>
							RAB		0 265 007 123 <sup>4</sup>
	500	09.99-05.06	225				0 265 007 002 <sup>3</sup>		
							LAB		0 265 007 008 <sup>4</sup>
							RAB		0 265 007 006 <sup>4</sup>
	600	09.99-08.02	270				0 265 007 002 <sup>3</sup>		
							LAB		0 265 007 008 <sup>4</sup>
							RAB		0 265 007 006 <sup>4</sup>
		09.02-08.06	368				0 265 007 128 <sup>3</sup>		
							LAB		0 265 007 121 <sup>4</sup>
							RAB		0 265 007 123 <sup>4</sup>
Serie CL (Coupé) [216]									
	63 AMG	01.07→	386/400/420						1 987 470 506 <sup>8</sup>
	65 AMG	09.07→	450/463						1 987 470 506 <sup>8</sup>
	63 AMG	01.07→	386/400/420						1 987 470 506 <sup>8</sup>
	65 AMG	09.07→	450/463						1 987 470 506 <sup>8</sup>
	500, CGI, CGI 4MATIC, 4MATIC	06.06→	285/320						1 987 470 506 <sup>8</sup>
Serie CLC [203]									
	180 KOMPRESSOR	03.08-05.10	105				0 986 473 220		← 57
							0 986 474 220		→ 57
	200 CDI	03.08-05.10	90				0 986 473 220		← 57
							0 986 474 220		→ 57
	200 KOMPRESSOR	03.08-05.10	135		ATP		0 986 473 220		← 57
							0 986 474 220		→ 57
	220 CDI	03.08-05.10	110				0 986 473 220		← 57
							0 986 474 220		→ 57
	230	03.08-05.10	150				0 986 473 490		← 57
							0 986 474 490		→ 57
	350	03.08-05.10	200				0 986 134 076		← 57
							0 986 135 076		→ 57
	160	02.09-10.10	95				0 986 473 282		← 36
							0 986 474 282		→ 36
	180 KOMPRESSOR	03.08-05.10	105				0 986 473 282		← 36
							0 986 474 282		→ 36
	200 CDI	03.08-05.10	90				0 986 473 282		← 36
							0 986 474 282		→ 36
	200 KOMPRESSOR	03.08-05.10	135				0 986 134 039		←
							0 986 134 061		←
							0 986 135 039		→
							0 986 135 061		→
	220 CDI	03.08-05.10	110				0 986 473 282		← 36
							0 986 474 282		→ 36



		S							
230		03.08-05.10	150				0 986 134 039	 ←	1 987 470 084
							0 986 134 061	 ←	
							0 986 135 039	 →	1 987 470 084
							0 986 135 061	 →	
350		03.08-05.10	200				0 986 134 039	 ←	1 987 470 084
							0 986 134 061	 ←	
							0 986 135 039	 →	1 987 470 084
							0 986 135 061	 →	
									
	160	02.09-10.10	95				1 987 477 846	← 925	
							1 987 477 847	→ 900	
						LLE	1 987 477 845	2735	
						RLE	1 987 477 848	2160	
	180 KOMPRESSOR	03.08-05.10	105				1 987 477 846	← 925	
							1 987 477 847	→ 900	
						LLE	1 987 477 845	2735	
						RLE	1 987 477 848	2160	
	200 CDI	03.08-05.10	90/135				1 987 477 846	← 925	
	200 KOMPRESSOR						1 987 477 847	→ 900	
						LLE	1 987 477 845	2735	
						RLE	1 987 477 848	2160	
	220 CDI	03.08-05.10	110				1 987 477 846	← 925	
							1 987 477 847	→ 900	
						LLE	1 987 477 845	2735	
						RLE	1 987 477 848	2160	
	230	03.08-05.10	150				1 987 477 846	← 925	
							1 987 477 847	→ 900	
						LLE	1 987 477 845	2735	
						RLE	1 987 477 848	2160	
	350	03.08-05.10	200				1 987 477 846	← 925	
							1 987 477 847	→ 900	
						LLE	1 987 477 845	2735	
						RLE	1 987 477 848	2160	
	160	02.09-10.10	95				0 986 594 543 <sup>3</sup>		
						LAB	0 986 594 541 <sup>4</sup>		
						RAB	0 986 594 542 <sup>4</sup>		
	180 KOMPRESSOR	03.08-05.10	105				0 986 594 543 <sup>3</sup>		
						LAB	0 986 594 541 <sup>4</sup>		
						RAB	0 986 594 542 <sup>4</sup>		
	200 CDI	03.08-05.10	90/135				0 986 594 543 <sup>3</sup>		
	200 KOMPRESSOR					LAB	0 986 594 541 <sup>4</sup>		
						RAB	0 986 594 542 <sup>4</sup>		
	220 CDI	03.08-05.10	110				0 986 594 543 <sup>3</sup>		
						LAB	0 986 594 541 <sup>4</sup>		
						RAB	0 986 594 542 <sup>4</sup>		
	230	03.08-05.10	150				0 986 594 543 <sup>3</sup>		
						LAB	0 986 594 541 <sup>4</sup>		
						RAB	0 986 594 542 <sup>4</sup>		
	350	03.08-05.10	200				0 986 594 543 <sup>3</sup>		
						LAB	0 986 594 541 <sup>4</sup>		
						RAB	0 986 594 542 <sup>4</sup>		
<b>Serie CLK (Cabrio) [208]</b>									
									
	200	06.98-06.00	100				0 986 473 096	 ← 56,93	
							0 986 474 096	 → 56,93	
	200 KOMPRESSOR	09.96-01.03	120/142				0 986 473 329	 ← 57	1 987 470 506 <sup>B</sup>
							0 986 474 329	 → 57	1 987 470 506 <sup>B</sup>



		S							
<b>◀ MERCEDES-BENZ Serie CLK (Cabrio) [208]</b>									
	<b>230 KOMPRESSOR</b>	06.98-01.03	142/145				0986 473 329	← 57	1987 470 506 <sup>8</sup>
							0986 474 329	→ 57	1987 470 506 <sup>8</sup>
	<b>320</b>	06.98-01.03	160				0986 473 329	← 57	1987 470 506 <sup>8</sup>
							0986 474 329	→ 57	1987 470 506 <sup>8</sup>
	<b>200</b>	06.98-06.00	100				0986 473 174	← 35,96	1987 470 084
							0986 474 174	→ 35,96	1987 470 084
	<b>200 KOMPRESSOR</b>	09.96-01.03	120/142	Fg.-Nr. →F196683, →T098095	MZH		0986 473 276	← 36	
				Fg.-Nr. F 196684→, T 098096→	MEH		0986 474 276	→ 36	1987 470 084
	<b>230 KOMPRESSOR</b>	06.98-01.03	142/145	Fg.-Nr. →F 196683, →T 098095			0986 473 276	← 36	
				Fg.-Nr. F 196684→, T 098096→			0986 474 276	→ 36	
							0986 134 061	← 36	1987 470 084
							0986 135 061	→ 36	1987 470 084
	<b>320</b>	06.98-01.03	160	Fg.-Nr. F 196684→, T 098096→	MEH				1987 470 084
	<b>55 AMG</b>	09.00-04.02	255				1987 477 219	← 960	
							1987 477 220	→ 925	
							1987 477 699	2554	
	<b>200</b>	09.96-01.03	100/120/ 142				1987 477 219	← 960	
	<b>200 KOMPRESSOR</b>						1987 477 220	→ 925	
						LLE	1987 477 896	2557	
						RLE	1987 477 700	2067	
	<b>230 KOMPRESSOR</b>	06.98-01.03	142/145				1987 477 219	← 960	
							1987 477 220	→ 925	
						LLE	1987 477 896	2557	
						RLE	1987 477 700	2067	
	<b>320</b>	06.98-01.03	160				1987 477 219	← 960	
							1987 477 220	→ 925	
						LLE	1987 477 896	2557	
						RLE	1987 477 700	2067	
	<b>430</b>	09.98-01.03	205				1987 477 219	← 960	
							1987 477 220	→ 925	
						LLE	1987 477 896	2557	
						RLE	1987 477 700	2067	
	<b>55 AMG</b>	09.00-04.02	255			LAB	0 265 006 192 <sup>4</sup>		
							0 265 006 266 <sup>3</sup>		
						RAB	0 265 006 172 <sup>4</sup>		
				Fg.-Nr. 202...A/B/C/D/E	RAB BO		0 265 006 264 <sup>3</sup>		
	<b>320</b>	MFD 06.98-01.03	160			LAB	0 265 006 192 <sup>4</sup>		
							0 265 006 266 <sup>3</sup>		
						RAB	0 265 006 172 <sup>4</sup>		
							0 265 006 264 <sup>3</sup>		
	<b>430</b>	MFD 09.98-01.03	205			LAB	0 265 006 192 <sup>4</sup>		
							0 265 006 266 <sup>3</sup>		
						RAB	0 265 006 172 <sup>4</sup>		
							0 265 006 264 <sup>3</sup>		
<b>Serie CLK (Cabrio) [209]</b>									
	<b>200 KOMPRESSOR</b>	02.03-12.09	120/135			SBJ	0986 134 076	← 57	
							0986 135 076	→ 57	
						SBJ	0986 473 490	← 57	
							0986 474 490	→ 57	



		S							
<b>240</b>		02.03-03.05	125				0 986 473 490		← 57
							0 986 474 490		→ 57
<b>280</b>		04.05-12.09	170			SBJ	0 986 134 076		← 57
							0 986 135 076		→ 57
						SBJ	0 986 473 490		← 57
							0 986 474 490		→ 57
<b>320</b>		02.03-03.05	160			ATP	0 986 134 076		← 57
							0 986 135 076		→ 57
						ATP	0 986 473 490		← 57
							0 986 474 490		→ 57
<b>320 CDI</b>		04.05-12.09	165			SBJ	0 986 134 076		← 57
							0 986 135 076		→ 57
<b>350</b>		04.05-12.09	200			SBJ	0 986 134 076		← 57
							0 986 135 076		→ 57
<hr/>									
	<b>200 KOMPRESSOR</b>	02.03-12.09	120/135			SBJ	0 986 134 061		← 36
							0 986 135 061		→ 36
						SBJ	0 986 134 039		←
							0 986 134 061		←
							0 986 135 039		→
							0 986 135 061		→
							0 986 134 039		←
							0 986 134 061		←
							0 986 135 039		→
							0 986 135 061		→
<b>240</b>		02.03-03.05	125				0 986 134 039		←
							0 986 134 061		←
							0 986 135 039		→
							0 986 135 061		→
<b>280</b>		04.05-12.09	170			SBJ	0 986 134 061		← 36
							0 986 135 061		→ 36
						SBJ	0 986 134 039		←
							0 986 134 061		←
							0 986 135 039		→
							0 986 135 061		→
<b>320</b>		02.03-03.05	160				0 986 134 039		←
							0 986 134 061		←
							0 986 135 039		→
							0 986 135 061		→
<b>320 CDI</b>		04.05-12.09	165			SBJ	0 986 134 061		← 36
							0 986 135 061		→ 36
						SBJ	0 986 134 039		←
							0 986 134 061		←
							0 986 135 039		→
							0 986 135 061		→
<b>350</b>		04.05-12.09	200			SBJ	0 986 134 061		← 36
							0 986 135 061		→ 36
						SBJ	0 986 134 039		←
							0 986 134 061		←
							0 986 135 039		→
							0 986 135 061		→
<hr/>									
	<b>55 AMG</b>	09.01-08.06	270				1 987 477 846		← 925
							1 987 477 847		→ 900
						LLE	1 987 477 845		2735
						RLE	1 987 477 848		2160
<b>63 AMG</b>		09.06-12.09	354			LLE	1 987 477 845		2735
						RLE	1 987 477 848		2160
<b>200 KOMPRESSOR</b>		02.03-12.09	120/135				1 987 477 846		← 925
							1 987 477 847		→ 900
						LLE	1 987 477 845		2735
						RLE	1 987 477 848		2160







◀ MERCEDES-BENZ Serie CLK (Cabrio) [209]

240	02.03-03.05	125		1987 477 846	← 925	
				1987 477 847	→ 900	
			LLE	1987 477 845	2735	
			RLE	1987 477 848	2160	
280	04.05-12.09	170		1987 477 846	← 925	
				1987 477 847	→ 900	
			LLE	1987 477 845	2735	
			RLE	1987 477 848	2160	
320 320 CDI	02.03-12.09	160/165		1987 477 846	← 925	
				1987 477 847	→ 900	
			LLE	1987 477 845	2735	
			RLE	1987 477 848	2160	
350	04.05-12.09	200		1987 477 846	← 925	
				1987 477 847	→ 900	
			LLE	1987 477 845	2735	
			RLE	1987 477 848	2160	
500	02.03-07.06	225		1987 477 846	← 925	
				1987 477 847	→ 900	
			LLE	1987 477 845	2735	
			RLE	1987 477 848	2160	
	09.06-12.09	285		1987 477 846	← 925	
			1987 477 847	→ 900		
			LLE	1987 477 845	2735	
			RLE	1987 477 848	2160	

	55 AMG	09.01-08.06	270		0986 594 543 <sup>3</sup>	
				LAB	0986 594 541 <sup>4</sup>	
				RAB	0986 594 542 <sup>4</sup>	
63 AMG	09.06-12.09	354		0986 594 543 <sup>3</sup>		
			LAB	0986 594 541 <sup>4</sup>		
			RAB	0986 594 542 <sup>4</sup>		
200 KOMPRESSOR	02.03-12.09	120/135		0986 594 543 <sup>3</sup>		
			LAB	0986 594 541 <sup>4</sup>		
			RAB	0986 594 542 <sup>4</sup>		
240	02.03-03.05	125		0986 594 543 <sup>3</sup>		
			LAB	0986 594 541 <sup>4</sup>		
			RAB	0986 594 542 <sup>4</sup>		
280	04.05-12.09	170		0986 594 543 <sup>3</sup>		
			LAB	0986 594 541 <sup>4</sup>		
			RAB	0986 594 542 <sup>4</sup>		
320 320 CDI	02.03-12.09	160/165		0986 594 543 <sup>3</sup>		
			LAB	0986 594 541 <sup>4</sup>		
			RAB	0986 594 542 <sup>4</sup>		
350	04.05-12.09	200		0986 594 543 <sup>3</sup>		
			LAB	0986 594 541 <sup>4</sup>		
			RAB	0986 594 542 <sup>4</sup>		
500	02.03-07.06	225		0986 594 543 <sup>3</sup>		
			LAB	0986 594 541 <sup>4</sup>		
			RAB	0986 594 542 <sup>4</sup>		
	09.06-12.09	285		0986 594 543 <sup>3</sup>		
LAB			0986 594 541 <sup>4</sup>			
			RAB	0986 594 542 <sup>4</sup>		

**Serie CLK (Coupé) [208]**

200	06.97-04.02	100/120/		0986 473 096	← 56,93	
				0986 474 096	→ 56,93	
230 KOMPRESSOR	06.97-04.02	142/145		0986 473 096	← 56,93	
				0986 474 096	→ 56,93	
320	01.97-09.02	160		0986 473 329	← 57	1987 470 506 <sup>8</sup>
				0986 474 329	→ 57	1987 470 506 <sup>8</sup>



	<b>200</b>	06.97-04.02	100/120/				0 986 473 174	← 35,96	1 987 470 084
	<b>200 KOMPRESSOR</b>		142				0 986 474 174	→ 35,96	1 987 470 084
	<b>230 KOMPRESSOR</b>	06.97-04.02	142/145				0 986 473 174	← 35,96	1 987 470 084
							0 986 474 174	→ 35,96	1 987 470 084
	<b>320</b>	01.97-09.02	160	Fg.-Nr. →F 196683, →T 098095	MZH		0 986 473 276	← 36	
				Fg.-Nr. F 196684→, T 098096→	MEH		0 986 474 276	→ 36	1 987 470 084
	<b>430</b>	09.98-04.02	205	Mod.Jahr →1999			0 986 473 276	← 36	
							0 986 474 276	→ 36	

	<b>55 AMG</b>	05.99-04.02	255				1 987 477 219	← 960	
							1 987 477 220	→ 925	
					LLE		1 987 477 896	2557	
					RLE		1 987 477 700	2067	
	<b>200</b>	06.97-04.02	100/120/				1 987 477 219	← 960	
	<b>200 KOMPRESSOR</b>		142				1 987 477 220	→ 925	
					LLE		1 987 477 896	2557	
					RLE		1 987 477 700	2067	
	<b>230 KOMPRESSOR</b>	06.97-04.02	142/145				1 987 477 219	← 960	
							1 987 477 220	→ 925	
					LLE		1 987 477 896	2557	
					RLE		1 987 477 700	2067	
	<b>320</b>	01.97-09.02	160				1 987 477 219	← 960	
							1 987 477 220	→ 925	
					LLE		1 987 477 896	2557	
					RLE		1 987 477 700	2067	
	<b>430</b>	09.98-04.02	205				1 987 477 219	← 960	
							1 987 477 220	→ 925	
					LLE		1 987 477 896	2557	
					RLE		1 987 477 700	2067	

	<b>55 AMG</b>	05.99-04.02	255		LAB		0 265 006 192 <sup>4</sup>		
							0 265 006 266 <sup>3</sup>		
					RAB		0 265 006 172 <sup>4</sup>		
							0 265 006 264 <sup>3</sup>		
	<b>320</b>	MFD 01.97-09.02	160		LAB		0 265 006 192 <sup>4</sup>		
							0 265 006 266 <sup>3</sup>		
					RAB		0 265 006 172 <sup>4</sup>		
							0 265 006 264 <sup>3</sup>		
	<b>430</b>	MFD 09.98-04.02	205		LAB		0 265 006 192 <sup>4</sup>		
							0 265 006 266 <sup>3</sup>		
					RAB		0 265 006 172 <sup>4</sup>		
							0 265 006 264 <sup>3</sup>		





































**Serie CLK (Coupé) [209]**

	<b>200 CGI KOMPRESSOR</b>	05.02-09.06	120/125		ATP		0 986 134 076	← 57	
	<b>200 KOMPRESSOR</b>						0 986 135 076	→ 57	
					ATP		0 986 473 220	← 57	
							0 986 474 220	→ 57	
	<b>200 KOMPRESSOR</b>	10.06-04.09	135		ATP		0 986 134 076	← 57	
							0 986 135 076	→ 57	
					ATP		0 986 473 490	← 57	
							0 986 474 490	→ 57	
	<b>220 CDI</b>	04.05-04.09	100-110		ATP		0 986 134 076	← 57	
							0 986 135 076	→ 57	



		S							
	<b>◀ MERCEDES-BENZ Serie CLK (Coupé) [209]</b>								
<b>220 CDI</b>		04.05-04.09	100-110			ATP	0986 473 220	← 57	
							0986 474 220	→ 57	
<b>240</b>		05.02-03.05	125				0986 473 490	← 57	
							0986 474 490	→ 57	
<b>270 CDI</b>		09.02-03.05	125			ATP	0986 134 076	← 57	
							0986 135 076	→ 57	
						ATP	0986 473 490	← 57	
							0986 474 490	→ 57	
<b>280</b>		04.05-04.09	170			SBJ	0986 134 076	← 57	
							0986 135 076	→ 57	
						SBJ	0986 473 490	← 57	
							0986 474 490	→ 57	
<b>320</b>		05.02-03.05	160				0986 473 490	← 57	
							0986 474 490	→ 57	
<b>320 CDI</b>		04.05-04.09	165			ATP	0986 134 076	← 57	
							0986 135 076	→ 57	
<b>350</b>		04.05-04.09	200			ATP,SBJ	0986 134 076	← 57	
							0986 135 076	→ 57	
						ATP,SBJ	0986 473 490	← 57	
							0986 474 490	→ 57	
	<hr/>								
	<b>200 CGI KOMPRESSOR</b>	05.02-09.06	120/125			ATP	0986 134 061	← 36	1987 470 084
	<b>200 KOMPRESSOR</b>						0986 135 061	→ 36	1987 470 084
						ATP	0986 473 282	← 36	1987 470 084
							0986 474 282	→ 36	1987 470 084
	<b>200 KOMPRESSOR</b>	10.06-04.09	135			ATP	0986 134 061	← 36	1987 470 084
							0986 135 061	→ 36	1987 470 084
						ATP	0986 134 039	←	1987 470 084
							0986 134 061	←	
							0986 135 039	→	1987 470 084
							0986 135 061	→	
<b>220 CDI</b>		04.05-04.09	100-110			ATP	0986 134 061	← 36	1987 470 084
							0986 135 061	→ 36	1987 470 084
						ATP	0986 473 282	← 36	1987 470 084
							0986 474 282	→ 36	1987 470 084
<b>240</b>		05.02-03.05	125				0986 134 039	←	1987 470 084
							0986 134 061	←	
							0986 135 039	→	1987 470 084
							0986 135 061	→	
<b>270 CDI</b>		09.02-03.05	125			ATP	0986 134 061	← 36	1987 470 084
							0986 135 061	→ 36	1987 470 084
						ATP	0986 134 039	←	1987 470 084
							0986 134 061	←	
							0986 135 039	→	1987 470 084
							0986 135 061	→	
<b>280</b>		04.05-04.09	170			SBJ	0986 134 061	← 36	1987 470 084
							0986 135 061	→ 36	1987 470 084
						SBJ	0986 134 039	←	1987 470 084
							0986 134 061	←	
							0986 135 039	→	1987 470 084
							0986 135 061	→	
<b>320</b>		05.02-03.05	160				0986 134 039	←	1987 470 084
							0986 134 061	←	
							0986 135 039	→	1987 470 084
							0986 135 061	→	
<b>320 CDI</b>		04.05-04.09	165			ATP	0986 134 061	← 36	1987 470 084
							0986 135 061	→ 36	1987 470 084
						ATP	0986 134 039	←	1987 470 084
							0986 134 061	←	
							0986 135 039	→	1987 470 084
							0986 135 061	→	



		S							
350		04.05-04.09	200			ATP	0 986 134 061	 36	1 987 470 084
							0 986 135 061	 36	1 987 470 084
						ATP	0 986 134 039	 ←	1 987 470 084
							0 986 134 061	 ←	
							0 986 135 039	 →	1 987 470 084
							0 986 135 061	 →	
<hr/>									
									
	55 AMG	08.01-08.06	270				1 987 477 846	 925	
							1 987 477 847	 900	
						LLE	1 987 477 845	2735	
						RLE	1 987 477 848	2160	
	63 AMG	09.06-04.09	354/373				1 987 477 845	2735	
							1 987 477 848	2160	
	200 CGI KOMPRESSOR	05.02-04.09	120/125/				1 987 477 846	 925	
	200 KOMPRESSOR		135				1 987 477 847	 900	
						LLE	1 987 477 845	2735	
						RLE	1 987 477 848	2160	
	220 CDI	04.05-04.09	100-110				1 987 477 846	 925	
							1 987 477 847	 900	
						LLE	1 987 477 845	2735	
						RLE	1 987 477 848	2160	
	240	05.02-03.05	125				1 987 477 846	 925	
							1 987 477 847	 900	
						LLE	1 987 477 845	2735	
						RLE	1 987 477 848	2160	
	270 CDI	09.02-03.05	125				1 987 477 846	 925	
							1 987 477 847	 900	
						LLE	1 987 477 845	2735	
						RLE	1 987 477 848	2160	
	280	04.05-04.09	170				1 987 477 846	 925	
							1 987 477 847	 900	
						LLE	1 987 477 845	2735	
						RLE	1 987 477 848	2160	
	320	05.02-04.09	160/165				1 987 477 846	 925	
	320 CDI						1 987 477 847	 900	
						LLE	1 987 477 845	2735	
						RLE	1 987 477 848	2160	
	350	04.05-04.09	200				1 987 477 846	 925	
							1 987 477 847	 900	
						LLE	1 987 477 845	2735	
						RLE	1 987 477 848	2160	
	500	05.02-07.06	225				1 987 477 846	 925	
							1 987 477 847	 900	
						LLE	1 987 477 845	2735	
						RLE	1 987 477 848	2160	
		09.06-04.09	285				1 987 477 846	 925	
							1 987 477 847	 900	
						LLE	1 987 477 845	2735	
						RLE	1 987 477 848	2160	
<hr/>									
		55 AMG	08.01-08.06	270			0 986 594 543 <sup>3</sup>		
						LAB	0 986 594 541 <sup>4</sup>		
						RAB	0 986 594 542 <sup>4</sup>		
	63 AMG	09.06-04.09	354				0 986 594 543 <sup>3</sup>		
						LAB	0 986 594 541 <sup>4</sup>		
						RAB	0 986 594 542 <sup>4</sup>		
		05.07-04.09	373			LAB	0 986 594 541 <sup>4</sup>		
						NOR	0 986 594 543 <sup>3</sup>		
						RAB	0 986 594 542 <sup>4</sup>		



		S							
	<b>◀ MERCEDES-BENZ Serie CLK (Coupé) [209]</b>								
	<b>200 CGI KOMPRESSOR</b>	05.02-04.09	120/125/					0 986 594 543 <sup>3</sup>	
	<b>200 KOMPRESSOR</b>		135		LAB			0 986 594 541 <sup>4</sup>	
					RAB			0 986 594 542 <sup>4</sup>	
	<b>220 CDI</b>	04.05-04.09	100-110					0 986 594 543 <sup>3</sup>	
					LAB			0 986 594 541 <sup>4</sup>	
					RAB			0 986 594 542 <sup>4</sup>	
	<b>240</b>	05.02-03.05	125					0 986 594 543 <sup>3</sup>	
					LAB			0 986 594 541 <sup>4</sup>	
					RAB			0 986 594 542 <sup>4</sup>	
	<b>270 CDI</b>	09.02-03.05	125					0 986 594 543 <sup>3</sup>	
					LAB			0 986 594 541 <sup>4</sup>	
					RAB			0 986 594 542 <sup>4</sup>	
	<b>280</b>	04.05-04.09	170					0 986 594 543 <sup>3</sup>	
					LAB			0 986 594 541 <sup>4</sup>	
					RAB			0 986 594 542 <sup>4</sup>	
	<b>320</b>	05.02-04.09	160/165					0 986 594 543 <sup>3</sup>	
	<b>320 CDI</b>				LAB			0 986 594 541 <sup>4</sup>	
					RAB			0 986 594 542 <sup>4</sup>	
	<b>350</b>	04.05-04.09	200					0 986 594 543 <sup>3</sup>	
					LAB			0 986 594 541 <sup>4</sup>	
					RAB			0 986 594 542 <sup>4</sup>	
	<b>500</b>	05.02-07.06	225					0 986 594 543 <sup>3</sup>	
					LAB			0 986 594 541 <sup>4</sup>	
					RAB			0 986 594 542 <sup>4</sup>	
		09.06-04.09	285					0 986 594 543 <sup>3</sup>	
					LAB			0 986 594 541 <sup>4</sup>	
					RAB			0 986 594 542 <sup>4</sup>	
	<b>Serie CLS (Coupé) [218]</b>								
	<b>220 BlueTec</b>	05.14→	120-130						1 987 470 506 <sup>8</sup>
	<b>250 BlueTec, BlueTec 4MATIC, CDI</b>	07.10→	150						1 987 470 506 <sup>8</sup>
	<b>350 BlueTec, CDI, CDI 4MATIC, CGI, d 4MATIC</b>	10.10→	185-190/ 195/225						1 987 470 506 <sup>8</sup>
	<b>400, 4MATIC</b>	05.14→	245						1 987 470 506 <sup>8</sup>
	<b>500, 4MATIC</b>	02.11→	300						1 987 470 506 <sup>8</sup>
	<b>63 AMG</b>	10.10→	386/410/430					1 987 482 329	↔ 743
	<b>63 AMG S 4MATIC</b>	02.13→	386/410/430					1 987 482 329	↔ 743
	<b>63 AMG 4MATIC</b>	05.13→	386/410/430					1 987 482 329	↔ 743
	<b>220 BlueTec</b>	05.14→	120-130					1 987 482 329	↔ 743
	<b>250 BlueTec</b>	09.14→	150					1 987 482 329	↔ 743
	<b>250 BlueTec 4MATIC</b>	05.14→	150					1 987 482 329	↔ 743
	<b>250 CDI</b>	07.10→	150					1 987 482 329	↔ 743
	<b>350 BlueTec</b>	11.12→	185-190/195/225					1 987 482 329	↔ 743
	<b>350 CDI</b>	10.10→	185-190/195/225					1 987 482 329	↔ 743
	<b>350 CDI 4MATIC</b>	06.11→	185-190/195/225					1 987 482 329	↔ 743
	<b>350 CGI</b>	10.10→	185-190/195/225					1 987 482 329	↔ 743
	<b>350 d 4MATIC</b>	04.15→	185-190/195/225					1 987 482 329	↔ 743
	<b>400</b>	05.14→	245					1 987 482 329	↔ 743
	<b>400 4MATIC</b>	05.14→	245					1 987 482 329	↔ 743
	<b>500</b>	02.11→	300					1 987 482 329	↔ 743
	<b>500 4MATIC</b>	06.11→	300					1 987 482 329	↔ 743
	<b>63 AMG</b>	10.10→	386/410		LAB			0 265 008 135 <sup>3</sup>	
	<b>250 CDI</b>	07.10→	150		LAB			0 265 008 135 <sup>3</sup>	
	<b>350 BlueTec, CDI, CGI</b>	10.10→	185-190/195/225		LAB			0 265 008 135 <sup>3</sup>	
	<b>500</b>	02.11→	300		LAB			0 265 008 135 <sup>3</sup>	

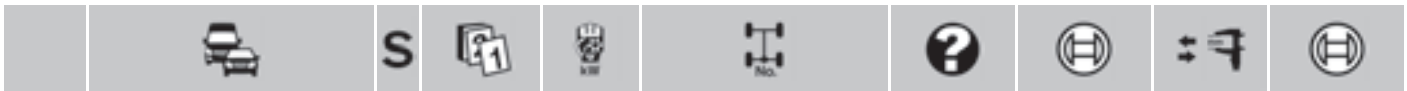

**Serie CLS (Shooting Brake) [218]**

	<b>220 BlueTec</b>	05.14→	120-130				1 987 470 506 <sup>B</sup>
	<b>250 BlueTec, BlueTec 4MATIC, CDI</b>	06.12→	150				1 987 470 506 <sup>B</sup>
	<b>350, BlueTec, BlueTec 4MATIC, CDI, CDI 4MATIC, d 4MATIC</b>	06.12→	185/190/ 195/225				1 987 470 506 <sup>B</sup>
	<b>400, 4MATIC</b>	05.14→	245				1 987 470 506 <sup>B</sup>
	<b>500, 4MATIC</b>	06.12→	300				1 987 470 506 <sup>B</sup>

	<b>63 AMG</b>	06.12→	410/430			1 987 482 329	↔ 743
	<b>63 AMG S</b>	06.13→	430			1 987 482 329	↔ 743
	<b>63 AMG S 4MATIC</b>	02.13→	410/430			1 987 482 329	↔ 743
	<b>63 AMG 4MATIC</b>	05.13→	410/430			1 987 482 329	↔ 743
	<b>220 BlueTec</b>	05.14→	120-130			1 987 482 329	↔ 743
	<b>250 BlueTec</b>	09.14→	150			1 987 482 329	↔ 743
	<b>250 BlueTec 4MATIC</b>	05.14→	150			1 987 482 329	↔ 743
	<b>250 CDI</b>	06.12→	150			1 987 482 329	↔ 743
	<b>350</b>	06.12→	185/190/195/225			1 987 482 329	↔ 743
	<b>350 BlueTec</b>	05.14→	185/190/195/225			1 987 482 329	↔ 743
	<b>350 BlueTec 4MATIC</b>	05.14-03.15	185/190/195/225			1 987 482 329	↔ 743
	<b>350 CDI</b>	06.12→	185/190/195/225			1 987 482 329	↔ 743
	<b>350 CDI 4MATIC</b>	10.12→	185/190/195/225			1 987 482 329	↔ 743
	<b>400</b>	05.14→	245			1 987 482 329	↔ 743
	<b>400 4MATIC</b>	05.14→	245			1 987 482 329	↔ 743
	<b>500</b>	06.12→	300			1 987 482 329	↔ 743
	<b>500 4MATIC</b>	06.12→	300			1 987 482 329	↔ 743

	<b>63 AMG</b>	06.12→	410		LAB	0 265 008 135 <sup>3</sup>	
	<b>63 AMG S</b>	06.13→	430	Mod.Jahr →2013	LAB	0 265 008 135 <sup>3</sup>	
	<b>250 CDI</b>	06.12→	150		LAB	0 265 008 135 <sup>3</sup>	
	<b>350, CDI</b>	06.12→	195/225		LAB	0 265 008 135 <sup>3</sup>	
	<b>500</b>	06.12→	300		LAB	0 265 008 135 <sup>3</sup>	

**Serie CLS [219]**

	<b>280</b>	01.08-04.09	170			0 986 134 055	↔ 42
						0 986 135 055	↔ 42
	<b>300</b>	05.09-09.09	170			0 986 134 055	↔ 42
						0 986 135 055	↔ 42
	<b>320 CDI</b>	05.05-04.09	155-165			0 986 134 055	↔ 42
						0 986 135 055	↔ 42
	<b>350, CDI, CGI</b>	06.04-12.10	165/200/ 215			0 986 134 055	↔ 42
						0 986 135 055	↔ 42
	<b>500</b>	06.04-04.06	225			0 986 134 055	↔ 42
						0 986 135 055	↔ 42
		04.06-09.10	285				1 987 470 506 <sup>B</sup>

	<b>55 AMG</b>	06.04-08.06	350			1 987 477 897	↔ 1726
					LLE	1 987 477 851	1952
					RLE	1 987 477 898	1433
	<b>63 AMG</b>	04.06-02.11	378			1 987 477 897	↔ 1726
					LLE	1 987 477 851	1952
					RLE	1 987 477 898	1433
	<b>280</b>	01.08-04.09	170			1 987 477 851	1952
						1 987 477 897	↔ 1726
	<b>300</b>	05.09-09.09	170			1 987 477 851	1952
						1 987 477 897	↔ 1726



		S				?								
<b>◀ MERCEDES-BENZ Serie CLS [219]</b>														
	320 CDI	05.05-04.09	155-165				LLE	1987 477 851	1952					
							RLE	1987 477 898	1433					
	350	06.04-12.09	200/215					1987 477 897	↔ 1726					
	350	06.04-09.10	200/215				LLE	1987 477 851	1952					
	350 CGI						RLE	1987 477 898	1433					
	350 CDI	05.09-12.10	165				LLE	1987 477 851	1952					
							RLE	1987 477 898	1433					
	350 CGI	04.06-09.10	200/215					1987 477 897	↔ 1726					
	500	06.04-09.10	225/285					1987 477 897	↔ 1726					
							LLE	1987 477 851	1952					
							RLE	1987 477 898	1433					
	55 AMG	06.04-08.06	350					0 265 008 097 <sup>3</sup>						
								0 986 594 563 <sup>4</sup>						
	63 AMG	04.06-02.11	378					0 265 008 097 <sup>3</sup>						
								0 986 594 563 <sup>4</sup>						
	280	01.08-04.09	170					0 265 008 097 <sup>3</sup>						
								0 986 594 563 <sup>4</sup>						
	300	05.09-09.09	170					0 265 008 097 <sup>3</sup>						
								0 986 594 563 <sup>4</sup>						
	320 CDI	05.05-04.09	155-165					0 265 008 097 <sup>3</sup>						
								0 986 594 563 <sup>4</sup>						
	350, CDI, CGI	06.04-12.10	165/200/ 215					0 265 008 097 <sup>3</sup>						
								0 986 594 563 <sup>4</sup>						
	500	06.04-09.10	225/285					0 265 008 097 <sup>3</sup>						
								0 986 594 563 <sup>4</sup>						
	<b>Serie E (Cabrio) [124]</b>													
		200	07.93-06.98	100					0 986 473 678	← 54	1987 470 287 <sup>7</sup>			
0 986 473 678									← 54	1987 474 486 <sup>8</sup>				
0 986 474 678									→ 54	1987 470 287 <sup>7</sup>				
0 986 473 678									← 54	1987 470 287 <sup>7</sup>				
0 986 473 678									← 54	1987 474 486 <sup>8</sup>				
0 986 474 678									→ 54	1987 470 287 <sup>7</sup>				
	36 AMG	07.93-06.98	195/200					0 986 473 963	← 38	1987 470 195				
								0 986 473 964	→ 38	1987 470 195				
								0 986 473 963	← 38	1987 470 195				
								0 986 473 964	→ 38	1987 470 195				
								0 986 473 963	← 38	1987 470 195				
								0 986 473 964	→ 38	1987 470 195				
								0 986 473 963	← 38	1987 470 195				
								0 986 473 964	→ 38	1987 470 195				
								0 986 473 963	← 38	1987 470 195				
								0 986 473 964	→ 38	1987 470 195				
	36 AMG	07.93-06.98	195/200					1987 477 047	↔ 1060					
								200	07.93-06.98	100			1987 477 047	↔ 1060
								220	07.93-06.98	110			1987 477 047	↔ 1060
								320	05.93-06.98	162-170			1987 477 047	↔ 1060
	36 AMG	07.93-06.98	195/200					LAB	0 265 006 111 <sup>3</sup>					
								RAB	0 265 006 109 <sup>3</sup>					
								ABS, 07.93-06.98	195/200			0 265 002 244 <sup>4</sup>		
								OAS						
								ASR 07.93-06.98	195/200			LAB	0 265 002 206 <sup>4</sup>	
				RAB	0 265 002 204 <sup>4</sup>									

		<b>S</b>							
<b>200</b>		07.93-06.98	100				0 265 <b>002 254</b> <sup>4</sup>		
							LAB 0 265 <b>006 111</b> <sup>3</sup>		
							RAB 0 265 <b>006 109</b> <sup>3</sup>		
<b>220</b>		07.93-06.98	110				0 265 <b>002 254</b> <sup>4</sup>		
							LAB 0 265 <b>006 111</b> <sup>3</sup>		
							RAB 0 265 <b>006 109</b> <sup>3</sup>		
<b>320</b>		05.93-06.98	162-170				LAB 0 265 <b>006 111</b> <sup>3</sup>		
							RAB 0 265 <b>006 109</b> <sup>3</sup>		
		ABS, 05.93-06.98	162-170				0 265 <b>002 244</b> <sup>4</sup>		
		OAS							
		ASR 05.93-06.98	162-170				LAB 0 265 <b>002 206</b> <sup>4</sup>		
							RAB 0 265 <b>002 204</b> <sup>4</sup>		

**Serie E (Cabrio) [207]**

	<b>200</b>	01.13→	135				0 986 <b>134 333</b>	← 38	1 987 <b>470 506</b> <sup>B</sup>
							0 986 <b>135 333</b>	→ 38	1 987 <b>470 506</b> <sup>B</sup>
	<b>200 CGI</b>	01.10-12.13	135		TW		0 986 <b>134 321</b>	← 38	1 987 <b>470 506</b> <sup>B</sup>
							0 986 <b>134 333</b>	← 38	1 987 <b>470 506</b> <sup>B</sup>
							0 986 <b>135 321</b>	→ 38	1 987 <b>470 506</b> <sup>B</sup>
							0 986 <b>135 333</b>	→ 38	1 987 <b>470 506</b> <sup>B</sup>
	<b>220 BlueTec</b>	01.10→	125-130		AGH		0 986 <b>134 333</b>	← 38	1 987 <b>470 506</b> <sup>B</sup>
	<b>220 CDI</b>						0 986 <b>135 333</b>	→ 38	1 987 <b>470 506</b> <sup>B</sup>
					GEM		0 986 <b>134 321</b>	← 38	1 987 <b>470 506</b> <sup>B</sup>
							0 986 <b>135 321</b>	→ 38	1 987 <b>470 506</b> <sup>B</sup>
	<b>250</b>	01.13→	155				0 986 <b>134 333</b>	← 38	1 987 <b>470 506</b> <sup>B</sup>
							0 986 <b>135 333</b>	→ 38	1 987 <b>470 506</b> <sup>B</sup>
	<b>250 BlueTec</b>	01.10→	150		AGH		0 986 <b>134 333</b>	← 38	1 987 <b>470 506</b> <sup>B</sup>
	<b>250 CDI</b>						0 986 <b>135 333</b>	→ 38	1 987 <b>470 506</b> <sup>B</sup>
					GEM		0 986 <b>134 321</b>	← 38	1 987 <b>470 506</b> <sup>B</sup>
							0 986 <b>135 321</b>	→ 38	1 987 <b>470 506</b> <sup>B</sup>
	<b>250 CGI</b>	01.10-04.13	150		TW		0 986 <b>134 321</b>	← 38	1 987 <b>470 506</b> <sup>B</sup>
							0 986 <b>134 333</b>	← 38	1 987 <b>470 506</b> <sup>B</sup>
							0 986 <b>135 321</b>	→ 38	1 987 <b>470 506</b> <sup>B</sup>
							0 986 <b>135 333</b>	→ 38	1 987 <b>470 506</b> <sup>B</sup>
	<b>300 CGI</b>	01.11→	185						1 987 <b>470 506</b> <sup>B</sup>
	<b>320</b>	07.14→	200						1 987 <b>470 506</b> <sup>B</sup>
	<b>350, CDI, CGI</b>	01.10→	195/200/215		TW				1 987 <b>470 506</b> <sup>B</sup>
	<b>350 BlueTec</b>	01.13→	185-190		AGH				1 987 <b>470 506</b> <sup>B</sup>
					GEM				1 987 <b>470 506</b> <sup>B</sup>
	<b>350 CDI</b>	01.10-01.11	170		TW				1 987 <b>470 506</b> <sup>B</sup>
	<b>350 CGI</b>	02.11→	225						1 987 <b>470 506</b> <sup>B</sup>
	<b>400</b>	02.13→	245						1 987 <b>470 506</b> <sup>B</sup>
	<b>500</b>	01.10-01.11	285		TW				1 987 <b>470 506</b> <sup>B</sup>
	<b>500 CGI</b>	02.11→	300						1 987 <b>470 506</b> <sup>B</sup>

	<b>200</b>	01.13→	135				1 987 <b>482 301</b>	↔ 728	
	<b>200</b>	01.10→	135		LLE		1 987 <b>482 331</b>	2057	
	<b>200 CGI</b>				MI		1 987 <b>482 332</b>	1152	
					RLE		1 987 <b>482 330</b>	1637	
	<b>200 CGI</b>	01.10-12.13	135				1 987 <b>482 301</b>	↔ 728	
	<b>220 BlueTec</b>	05.14→	125-130				1 987 <b>482 301</b>	↔ 728	
	<b>220 BlueTec</b>	01.10→	125-130		LLE		1 987 <b>482 331</b>	2057	
	<b>220 CDI</b>				MI		1 987 <b>482 332</b>	1152	
					RLE		1 987 <b>482 330</b>	1637	
	<b>220 CDI</b>	01.10→	125-130				1 987 <b>482 301</b>	↔ 728	
	<b>250</b>	01.13→	150/155				1 987 <b>482 301</b>	↔ 728	
	<b>250, BlueTec, CDI, CGI</b>	01.10→	150/155		LLE		1 987 <b>482 331</b>	2057	
					MI		1 987 <b>482 332</b>	1152	
					RLE		1 987 <b>482 330</b>	1637	





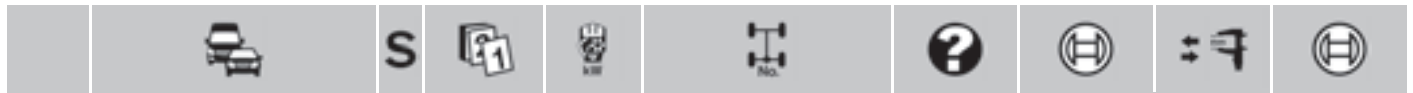

**MERCEDES-BENZ Serie E (Cabrio) [207]**

<b>250 BlueTec</b>	07.14→	150/155		1987 <b>482 301</b>	↔ 728
<b>250 CDI</b>	01.10→	150/155		1987 <b>482 301</b>	↔ 728
<b>250 CGI</b>	01.10-04.13	150/155		1987 <b>482 301</b>	↔ 728
<b>300 CGI</b>	01.11→	185		1987 <b>482 301</b>	↔ 728
			LLE	1987 <b>482 331</b>	2057
			MI	1987 <b>482 332</b>	1152
			RLE	1987 <b>482 330</b>	1637
<b>320</b>	07.14→	200		1987 <b>482 301</b>	↔ 728
			LLE	1987 <b>482 331</b>	2057
			MI	1987 <b>482 332</b>	1152
			RLE	1987 <b>482 330</b>	1637
<b>350</b>	01.10→	170/185-190/195/200/215/225		1987 <b>482 301</b>	↔ 728
<b>350, BlueTec, CDI, CGI</b>	01.10→	170/185-190/ 195/200/215/225	LLE	1987 <b>482 331</b>	2057
			MI	1987 <b>482 332</b>	1152
			RLE	1987 <b>482 330</b>	1637
<b>350 BlueTec</b>	01.13→	170/185-190/195/200/215/225		1987 <b>482 301</b>	↔ 728
<b>350 CDI</b>	01.10-01.11	170/185-190/195/200/215/225		1987 <b>482 301</b>	↔ 728
	04.11-04.13	170/185-190/195/200/215/225		1987 <b>482 301</b>	↔ 728
<b>350 CGI</b>	01.10→	170/185-190/195/200/215/225		1987 <b>482 301</b>	↔ 728
<b>400</b>	02.13→	245		1987 <b>482 301</b>	↔ 728
			LLE	1987 <b>482 331</b>	2057
			MI	1987 <b>482 332</b>	1152
			RLE	1987 <b>482 330</b>	1637
<b>500</b>	01.10-01.11	285/300		1987 <b>482 301</b>	↔ 728
<b>500</b>	01.10→	285/300	LLE	1987 <b>482 331</b>	2057
<b>500 CGI</b>			MI	1987 <b>482 332</b>	1152
			RLE	1987 <b>482 330</b>	1637
<b>500 CGI</b>	02.11→	285/300		1987 <b>482 301</b>	↔ 728

<b>200 CGI</b>	01.10-12.13	135	Mod.Jahr →2012	0 265 <b>008 138</b> <sup>3</sup>	
				0 265 <b>008 140</b> <sup>4</sup>	
<b>220 CDI</b>	01.10→	125	Mod.Jahr →2012	0 265 <b>008 138</b> <sup>3</sup>	
				0 265 <b>008 140</b> <sup>4</sup>	
<b>250 CDI</b>	01.10→	150	Mod.Jahr →2012	0 265 <b>008 138</b> <sup>3</sup>	
<b>250 CGI</b>				0 265 <b>008 140</b> <sup>4</sup>	
<b>300 CGI</b>	01.11→	185	Mod.Jahr →2012	0 265 <b>008 138</b> <sup>3</sup>	
				0 265 <b>008 140</b> <sup>4</sup>	
<b>350</b>	01.10→	195/200	Mod.Jahr →2012	0 265 <b>008 138</b> <sup>3</sup>	
<b>350 CDI</b>				0 265 <b>008 140</b> <sup>4</sup>	
<b>350 CDI</b>	01.10-01.11	170		0 265 <b>008 138</b> <sup>3</sup>	
				0 265 <b>008 140</b> <sup>4</sup>	
<b>350 CGI</b>	01.10-01.11	215		0 265 <b>008 138</b> <sup>3</sup>	
				0 265 <b>008 140</b> <sup>4</sup>	
	02.11→	225	Mod.Jahr →2012	0 265 <b>008 138</b> <sup>3</sup>	
				0 265 <b>008 140</b> <sup>4</sup>	
<b>500</b>	01.10-01.11	285		0 265 <b>008 138</b> <sup>3</sup>	
				0 265 <b>008 140</b> <sup>4</sup>	
<b>500 CGI</b>	02.11→	300	Mod.Jahr →2012	0 265 <b>008 138</b> <sup>3</sup>	
				0 265 <b>008 140</b> <sup>4</sup>	

**Serie E (Coupé) [124]**

<b>200</b>	07.93-06.97	100		0986 <b>473 678</b>	↻ ← 54	1987 <b>470 287</b> <sup>7</sup>
				0986 <b>473 678</b>	↻ ← 54	1987 <b>474 486</b> <sup>8</sup>
				0986 <b>474 678</b>	↻ → 54	1987 <b>470 287</b> <sup>7</sup>
<b>220</b>	07.93-06.97	110		0986 <b>473 678</b>	↻ ← 54	1987 <b>470 287</b> <sup>7</sup>
				0986 <b>473 678</b>	↻ ← 54	1987 <b>474 486</b> <sup>8</sup>
				0986 <b>474 678</b>	↻ → 54	1987 <b>470 287</b> <sup>7</sup>



	<b>36 AMG</b>	07.93-06.96	195/200			0 986 473 963	← 38	1 987 470 195
						0 986 473 964	→ 38	1 987 470 195
	<b>200</b>	07.93-06.97	100			0 986 471 951	← 35	
						0 986 473 951		
						0 986 471 952	→ 35	
						0 986 473 952		
	<b>220</b>	07.93-06.97	110			0 986 471 951	← 35	
						0 986 473 951		
						0 986 471 952	→ 35	
						0 986 473 952		
	<b>320</b>	07.93-06.98	162			0 986 473 963	← 38	1 987 470 195
						0 986 473 964	→ 38	1 987 470 195

	<b>36 AMG</b>	07.93-06.96	195/200			1 987 477 047	↔ 1060	
	<b>200</b>	07.93-06.97	100			1 987 477 047	↔ 1060	
	<b>220</b>	07.93-06.97	110			1 987 477 047	↔ 1060	
	<b>320</b>	07.93-06.98	162			1 987 477 047	↔ 1060	

	<b>36 AMG</b>	07.93-06.96	195/200		LAB	0 265 001 284 <sup>3</sup>		
					RAB	0 265 001 282 <sup>3</sup>		
		ABS, 07.93-06.96	195/200			0 265 002 210 <sup>4</sup>		
		OAS						
		ASR 07.93-06.96	195/200		LAB	0 265 002 206 <sup>4</sup>		
					RAB	0 265 002 204 <sup>4</sup>		
	<b>200</b>	07.93-06.97	100			0 265 002 208 <sup>4</sup>		
				Fg.-Nr. →C009355,	LAB	0 265 001 284 <sup>3</sup>		
				B891779→C009354,	RAB	0 265 001 282 <sup>3</sup>		
				Komp.Nr. Code 859				
				Fg.-Nr. C009356→,	LAB	0 265 006 111 <sup>3</sup>		
				B891779→C009354,	RAB	0 265 006 109 <sup>3</sup>		
				Komp.Nr. Code 859				
	<b>220</b>	07.93-06.97	110			0 265 002 208 <sup>4</sup>		
				Fg.-Nr. →C009355,	LAB	0 265 001 284 <sup>3</sup>		
				B891779→C009354,	RAB	0 265 001 282 <sup>3</sup>		
				Komp.Nr. Code 859				
				Fg.-Nr. C009356→,	LAB	0 265 006 111 <sup>3</sup>		
				B891779→C009354,	RAB	0 265 006 109 <sup>3</sup>		
				Komp.Nr. Code 859				
	<b>320</b>	07.93-06.98	162		LAB	0 265 001 284 <sup>3</sup>		
					RAB	0 265 001 282 <sup>3</sup>		
		ABS, 07.93-06.98	162			0 265 002 210 <sup>4</sup>		
		OAS						
		ASR 07.93-06.98	162		LAB	0 265 002 206 <sup>4</sup>		
					RAB	0 265 002 204 <sup>4</sup>		

**Serie E (Coupe) [207]**

	<b>320</b>	07.14→	200					1 987 470 506 <sup>8</sup>
	<b>400</b>	07.14→	245					1 987 470 506 <sup>8</sup>

	<b>320</b>	07.14→	200			1 987 482 301	↔ 728	
					LLE	1 987 482 331	2057	
					MI	1 987 482 332	1152	
					RLE	1 987 482 330	1637	





	◀ MERCEDES-BENZ Serie E (Coupe) [207]						
<b>400</b>	07.14→	245				1987 482 301	↔ 728
					LLE	1987 482 331	2057
					MI	1987 482 332	1152
					RLE	1987 482 330	1637

**Serie E (Coupé) [207]**

	<b>200</b>	01.13→	135			0986 134 333	↔ 38	1987 470 506 <sup>8</sup>
						0986 135 333	↔ 38	1987 470 506 <sup>8</sup>
	<b>200 CGI</b>	07.09-04.13	135		TW	0986 134 321	↔ 38	1987 470 506 <sup>8</sup>
						0986 134 333	↔ 38	1987 470 506 <sup>8</sup>
						0986 135 321	↔ 38	1987 470 506 <sup>8</sup>
						0986 135 333	↔ 38	1987 470 506 <sup>8</sup>
	<b>220 BlueTec</b>	07.09→	120-130		AGH	0986 134 333	↔ 38	1987 470 506 <sup>8</sup>
	<b>220 CDI</b>					0986 135 333	↔ 38	1987 470 506 <sup>8</sup>
					GEM	0986 134 321	↔ 38	1987 470 506 <sup>8</sup>
						0986 135 321	↔ 38	1987 470 506 <sup>8</sup>
	<b>250</b>	01.13→	155			0986 134 333	↔ 38	1987 470 506 <sup>8</sup>
						0986 135 333	↔ 38	1987 470 506 <sup>8</sup>
	<b>250 BlueTec</b>	02.09→	150		AGH	0986 134 333	↔ 38	1987 470 506 <sup>8</sup>
	<b>250 CDI</b>					0986 135 333	↔ 38	1987 470 506 <sup>8</sup>
	<b>250 CGI</b>				GEM	0986 134 321	↔ 38	1987 470 506 <sup>8</sup>
						0986 135 321	↔ 38	1987 470 506 <sup>8</sup>
	<b>300 CGI</b>	01.11→	185					1987 470 506 <sup>8</sup>
	<b>350</b>	05.09→	200					1987 470 506 <sup>8</sup>
	<b>350 BlueTec</b>	04.11→	185-190/		AGH			1987 470 506 <sup>8</sup>
	<b>350 CDI</b>		195		GEM			1987 470 506 <sup>8</sup>
	<b>350 CDI</b>	02.09-03.11	170		TW			1987 470 506 <sup>8</sup>
	<b>350 CGI</b>	02.09-01.11	215		TW			1987 470 506 <sup>8</sup>
	<b>350 CGI, 4MATIC</b>	02.11→	225					1987 470 506 <sup>8</sup>
	<b>400</b>	02.13→	245					1987 470 506 <sup>8</sup>
	<b>500</b>	02.09-01.11	285		TW			1987 470 506 <sup>8</sup>
	<b>500 CGI</b>	02.11→	300					1987 470 506 <sup>8</sup>

**Serie E (Coupé) [207]**

	<b>200</b>	01.13→	135			1987 482 301	↔ 728	
	<b>200</b>	07.09→	135		LLE	1987 482 331	2057	
	<b>200 CGI</b>				MI	1987 482 332	1152	
					RLE	1987 482 330	1637	
	<b>200 CGI</b>	07.09-04.13	135			1987 482 301	↔ 728	
	<b>220 BlueTec</b>	05.14→	120-130			1987 482 301	↔ 728	
	<b>220 BlueTec</b>	07.09→	120-130		LLE	1987 482 331	2057	
	<b>220 CDI</b>				MI	1987 482 332	1152	
					RLE	1987 482 330	1637	
	<b>220 CDI</b>	07.09→	120-130			1987 482 301	↔ 728	
	<b>250</b>	01.13→	150/155			1987 482 301	↔ 728	
	<b>250, BlueTec, CDI, CGI</b>	02.09→	150/155		LLE	1987 482 331	2057	
					MI	1987 482 332	1152	
					RLE	1987 482 330	1637	
	<b>250 BlueTec</b>	07.14→	150/155			1987 482 301	↔ 728	
	<b>250 CDI</b>	02.09→	150/155			1987 482 301	↔ 728	
	<b>250 CGI</b>	02.09-04.13	150/155			1987 482 301	↔ 728	
	<b>300 CGI</b>	01.11→	185			1987 482 301	↔ 728	
					LLE	1987 482 331	2057	
					MI	1987 482 332	1152	
					RLE	1987 482 330	1637	
	<b>350</b>	05.09→	170/185-190/195/200/215			1987 482 301	↔ 728	
	<b>350, BlueTec, CDI, CGI</b>	02.09→	170/		LLE	1987 482 331	2057	
			185-190/		MI	1987 482 332	1152	
			195/200/215		RLE	1987 482 330	1637	
	<b>350 BlueTec</b>	01.13→	170/185-190/195/200/215			1987 482 301	↔ 728	

		S							
350 CDI		02.09-04.13	170/185-190/195/200/215				1 987 482 301	↔ 728	
350 CGI		02.09-01.11	170/185-190/195/200/215				1 987 482 301	↔ 728	
		02.11→	225				1 987 482 301	↔ 728	
						LLE	1 987 482 331	2057	
						RLE	1 987 482 330	1637	
350 CGI, 4MATIC		02.11→	225			MI	1 987 482 332	1152	
350 4MATIC		03.13→	225				1 987 482 301	↔ 728	
							1 987 482 331	2057	
400		02.13→	245				1 987 482 301	↔ 728	
						LLE	1 987 482 331	2057	
						MI	1 987 482 332	1152	
						RLE	1 987 482 330	1637	
500		02.09-01.11	285/300				1 987 482 301	↔ 728	
500		02.09→	285/300			LLE	1 987 482 331	2057	
500 CGI						MI	1 987 482 332	1152	
						RLE	1 987 482 330	1637	
500 CGI		02.11→	285/300				1 987 482 301	↔ 728	
200 CGI		07.09-04.13	135	Mod.Jahr →2012			0 265 008 138 <sup>3</sup>		
							0 265 008 140 <sup>4</sup>		
220 CDI		07.09→	120-125	Mod.Jahr →2012			0 265 008 138 <sup>3</sup>		
							0 265 008 140 <sup>4</sup>		
250 CDI		02.09→	150	Mod.Jahr →2012			0 265 008 138 <sup>3</sup>		
250 CGI							0 265 008 140 <sup>4</sup>		
300 CGI		01.11→	185	Mod.Jahr →2012			0 265 008 138 <sup>3</sup>		
							0 265 008 140 <sup>4</sup>		
350		02.09→	200/215				0 265 008 138 <sup>3</sup>		
350 CGI							0 265 008 140 <sup>4</sup>		
350 CDI		02.09-03.11	170				0 265 008 138 <sup>3</sup>		
							0 265 008 140 <sup>4</sup>		
		04.11-04.13	195	Mod.Jahr →2012			0 265 008 138 <sup>3</sup>		
							0 265 008 140 <sup>4</sup>		
350 CGI		02.11→	225	Mod.Jahr →2012			0 265 008 138 <sup>3</sup>		
							0 265 008 140 <sup>4</sup>		
500		02.09-01.11	285				0 265 008 138 <sup>3</sup>		
							0 265 008 140 <sup>4</sup>		
500 CGI		02.11→	300	Mod.Jahr →2012			0 265 008 138 <sup>3</sup>		
							0 265 008 140 <sup>4</sup>		
<b>Serie E (T-Modell) [212]</b>									
350 BlueTec 4MATIC		08.12→	185-190						1 987 470 506 <sup>8</sup>
350 BlueTec 4MATIC		08.12→	185-190				1 987 482 329	↔ 743	
<b>Serie E (T-Modell) [124]</b>									
200		07.93-05.96	100				0 986 473 678	← 54	1 987 470 287 <sup>7</sup>
							0 986 473 678	← 54	1 987 474 486 <sup>8</sup>
							0 986 474 678	→ 54	1 987 470 287 <sup>7</sup>
220		07.93-05.96	110				0 986 473 678	← 54	1 987 470 287 <sup>7</sup>
							0 986 473 678	← 54	1 987 474 486 <sup>8</sup>
							0 986 474 678	→ 54	1 987 470 287 <sup>7</sup>
250 D		07.93-05.96	83		INB		0 986 473 678	← 54	1 987 470 287 <sup>7</sup>
							0 986 473 678	← 54	1 987 474 486 <sup>8</sup>
							0 986 474 678	→ 54	1 987 470 287 <sup>7</sup>



		S								
	◀ MERCEDES-BENZ Serie E (T-Modell) [124]									
250 D	07.93-05.96	83				INB	0986 473 656		54	1987 470 287 <sup>7</sup>
							0986 473 656		54	1987 474 486 <sup>8</sup>
							0986 474 656		54	1987 470 287 <sup>7</sup>
250 D Turbo	07.93-06.95	93					0986 473 678		54	1987 470 287 <sup>7</sup>
							0986 473 678		54	1987 474 486 <sup>8</sup>
							0986 474 678		54	1987 470 287 <sup>7</sup>
280	07.93-05.96	142-145	Fg.-Nr. 124.088...				0986 473 678		54	1987 470 287 <sup>7</sup>
							0986 473 678		54	1987 474 486 <sup>8</sup>
							0986 474 678		54	1987 470 287 <sup>7</sup>
300 D	07.93-05.96	100					0986 473 678		54	1987 470 287 <sup>7</sup>
							0986 473 678		54	1987 474 486 <sup>8</sup>
							0986 474 678		54	1987 470 287 <sup>7</sup>
300 D Turbo	07.93-05.96	105-108					0986 473 678		54	1987 470 287 <sup>7</sup>
							0986 473 678		54	1987 474 486 <sup>8</sup>
							0986 474 678		54	1987 470 287 <sup>7</sup>
300 D Turbo 4MATIC	07.93-05.96	105-108								1987 470 287 <sup>7</sup>
300 4MATIC	07.93-06.95	132								1987 470 287 <sup>7</sup>
	36 AMG	03.94-05.96	195-200	Fg.-Nr. →F 323055			0986 473 971		42	
							0986 473 972		42	
200	07.93-05.96	100					0986 473 963		38	1987 470 083
							0986 473 964		38	1987 470 083
220	07.93-05.96	110					0986 473 963		38	1987 470 083
							0986 473 964		38	1987 470 083
250 D	07.93-05.96	83					0986 473 963		38	1987 470 083
							0986 473 964		38	1987 470 083
250 D Turbo	07.93-06.95	93					0986 471 951		35	
							0986 473 951			
							0986 471 952		35	
							0986 473 952			
280	07.93-05.96	142-145					0986 473 963		38	1987 470 083
							0986 473 964		38	1987 470 083
300 D	07.93-05.96	100					0986 473 963		38	1987 470 083
							0986 473 964		38	1987 470 083
300 D Turbo	07.93-05.96	105-108					0986 473 963		38	1987 470 083
							0986 473 964		38	1987 470 083
300 D Turbo 4MATIC	07.93-05.96	105-108					0986 473 963		38	1987 470 195
							0986 473 964		38	1987 470 195
300 4MATIC	07.93-06.95	132					0986 473 963		38	1987 470 083
							0986 473 964		38	1987 470 083
320	07.93-05.96	162					0986 473 971		42	
							0986 473 972		42	
	36 AMG	03.94-05.96	195-200				1987 477 047		1060	
							LLE			2496
							RLE			1883
200	07.93-05.96	100					1987 477 047		1060	
							LLE			2496
							RLE			1883
220	07.93-05.96	110					1987 477 047		1060	
							LLE			2496
							RLE			1883
250 D	07.93-05.96	83					1987 477 047		1060	
							LLE			2496
							RLE			1883
250 D Turbo	07.93-06.95	93		Fg.-Nr. 124104..., Fg.-Nr. 124186...			LLE			2496
							RLE			1883
										1987 477 047
							LLE			2496
							RLE			1883

		S							
<b>280</b>		07.93-05.96	142-145						
					Fg.-Nr. 124088...	LLE	1 987 477 047	↔	1060
						RLE	1 987 477 306		2496
							1 987 482 497		1883
<b>300 D</b>		07.93-05.96	100/105-108/132				1 987 477 047	↔	1060
<b>300 D Turbo</b>		07.93-05.96	100/105-108/132				1 987 477 047	↔	1060
<b>300 D Turbo 4MATIC</b>		07.93-05.96	100/105-108/132				1 987 477 047	↔	1060
<b>300 D, D Turbo, D Turbo 4MATIC, 4MATIC</b>		07.93-05.96	100/105-108/132			LLE	1 987 477 306		2496
						RLE	1 987 482 497		1883
<b>300 4MATIC</b>		07.93-06.95	100/105-108/132				1 987 477 047	↔	1060
<b>320</b>		07.93-05.96	162				1 987 477 047	↔	1060
						LLE	1 987 477 306		2496
						RLE	1 987 482 497		1883
<b>36 AMG</b>		03.94-05.96	195-200		Fg.-Nr. →F264120	LAB	0 265 001 284 <sup>3</sup>		
						RAB	0 265 001 282 <sup>3</sup>		
					Fg.-Nr. F264121→	LAB	0 265 006 111 <sup>3</sup>		
						RAB	0 265 006 109 <sup>3</sup>		
		ABS, 03.94-05.96	195-200				0 265 002 210 <sup>4</sup>		
		OAS							
		ASR 03.94-05.96	195-200			LAB	0 265 002 206 <sup>4</sup>		
						RAB	0 265 002 204 <sup>4</sup>		
<b>200</b>		07.93-05.96	100		Fg.-Nr. →F005649		0 265 002 011 <sup>4</sup>		
					Fg.-Nr. →F264120	LAB	0 265 001 284 <sup>3</sup>		
						RAB	0 265 001 282 <sup>3</sup>		
					Fg.-Nr. F005650→		0 265 002 208 <sup>4</sup>		
					Fg.-Nr. F264121→	LAB	0 265 006 111 <sup>3</sup>		
						RAB	0 265 006 109 <sup>3</sup>		
<b>220</b>		07.93-05.96	110		Fg.-Nr. →F005649		0 265 002 011 <sup>4</sup>		
					Fg.-Nr. →F264120	LAB	0 265 001 284 <sup>3</sup>		
						RAB	0 265 001 282 <sup>3</sup>		
					Fg.-Nr. F005650→		0 265 002 208 <sup>4</sup>		
					Fg.-Nr. F264121→	LAB	0 265 006 111 <sup>3</sup>		
						RAB	0 265 006 109 <sup>3</sup>		
<b>250 D</b>		07.93-05.96	83/93			LAB	0 265 006 111 <sup>3</sup>		
<b>250 D Turbo</b>						RAB	0 265 006 109 <sup>3</sup>		
					Fg.-Nr. →F005649		0 265 002 011 <sup>4</sup>		
					Fg.-Nr. F005650→		0 265 002 208 <sup>4</sup>		
<b>280</b>		07.93-05.96	142-145		Fg.-Nr. →F264120	LAB	0 265 001 284 <sup>3</sup>		
						RAB	0 265 001 282 <sup>3</sup>		
					Fg.-Nr. F264121→	LAB	0 265 006 111 <sup>3</sup>		
						RAB	0 265 006 109 <sup>3</sup>		
		ABS, 07.93-05.96	142-145				0 265 002 210 <sup>4</sup>		
		OAS							
		ASR 07.93-05.96	142-145			LAB	0 265 002 206 <sup>4</sup>		
						RAB	0 265 002 204 <sup>4</sup>		
<b>300 D</b>		07.93-05.96	100			LAB	0 265 006 111 <sup>3</sup>		
						RAB	0 265 006 109 <sup>3</sup>		
					Fg.-Nr. →F005649		0 265 002 011 <sup>4</sup>		
					Fg.-Nr. F005650→		0 265 002 208 <sup>4</sup>		
<b>300 D Turbo</b>		07.93-05.96	105-108			LAB	0 265 006 111 <sup>3</sup>		
						RAB	0 265 006 109 <sup>3</sup>		
<b>300 D Turbo 4MATIC</b>		07.93-05.96	105-108		Fg.-Nr. →F128717	LAB	0 265 001 400 <sup>3</sup>		
						RAB	0 265 001 398 <sup>3</sup>		
					Fg.-Nr. F128718→	LAB	0 265 001 300 <sup>3</sup>		
						RAB	0 265 001 298 <sup>3</sup>		
<b>300 D Turbo</b>		07.93-05.96	105-108		Fg.-Nr. →F005649		0 265 002 011 <sup>4</sup>		
<b>300 D Turbo 4MATIC</b>					Fg.-Nr. F005650→		0 265 002 208 <sup>4</sup>		
<b>300 4MATIC</b>		07.93-06.95	132		Fg.-Nr. →F005649		0 265 002 011 <sup>4</sup>		
					Fg.-Nr. →F128717	LAB	0 265 001 400 <sup>3</sup>		
						RAB	0 265 001 398 <sup>3</sup>		
					Fg.-Nr. F005650→		0 265 002 208 <sup>4</sup>		
					Fg.-Nr. F128718→	LAB	0 265 001 300 <sup>3</sup>		
						RAB	0 265 001 298 <sup>3</sup>		



◀ MERCEDES-BENZ Serie E (T-Modell) [124]									
320	07.93-05.96	162	Fg.-Nr. →F264120	LAB	0 265 001 284 <sup>3</sup>				
				RAB	0 265 001 282 <sup>3</sup>				
				Fg.-Nr. F264121→	LAB	0 265 006 111 <sup>3</sup>			
					RAB	0 265 006 109 <sup>3</sup>			
	ABS, 07.93-05.96		162			0 265 002 210 <sup>4</sup>			
	OAS								
ASR 07.93-05.96		162		LAB	0 265 002 206 <sup>4</sup>				
				RAB	0 265 002 204 <sup>4</sup>				

**Serie E (T-Modell) [210]**

	200	05.96-05.99	100		0 986 473 096		← 56,93	1 987 470 506 <sup>8</sup>
					0 986 474 096		→ 56,93	1 987 470 506 <sup>8</sup>
		07.99-01.03	100		0 986 473 096		← 56,93	1 987 470 506 <sup>8</sup>
					0 986 474 096		→ 56,93	1 987 470 506 <sup>8</sup>
200 KOMPRESSOR	09.97-05.99	137		0 986 473 329		← 57	1 987 470 506 <sup>8</sup>	
				0 986 474 329		→ 57	1 987 470 506 <sup>8</sup>	
	07.99-01.03	137		0 986 473 329		← 57	1 987 470 506 <sup>8</sup>	
				0 986 474 329		→ 57	1 987 470 506 <sup>8</sup>	
	09.00-01.03	120		0 986 473 096		← 56,93	1 987 470 506 <sup>8</sup>	
				0 986 474 096		→ 56,93	1 987 470 506 <sup>8</sup>	
220 CDI	07.98-05.99	92		0 986 473 096		← 56,93	1 987 470 506 <sup>8</sup>	
				0 986 474 096		→ 56,93	1 987 470 506 <sup>8</sup>	
	07.99-01.03	100-105		0 986 473 096		← 56,93	1 987 470 506 <sup>8</sup>	
				0 986 474 096		→ 56,93	1 987 470 506 <sup>8</sup>	
230	05.96-08.97	110		0 986 473 096		← 56,93	1 987 470 506 <sup>8</sup>	
				0 986 474 096		→ 56,93	1 987 470 506 <sup>8</sup>	
240	06.99-01.03	125		0 986 473 096		← 56,93	1 987 470 506 <sup>8</sup>	
				0 986 474 096		→ 56,93	1 987 470 506 <sup>8</sup>	
	MFD 09.97-06.99	125		0 986 473 329		← 57	1 987 470 506 <sup>8</sup>	
				0 986 474 329		→ 57	1 987 470 506 <sup>8</sup>	
	OFD 09.97-06.99	125		0 986 473 096		← 56,93	1 987 470 506 <sup>8</sup>	
				0 986 474 096		→ 56,93	1 987 470 506 <sup>8</sup>	
250 D	05.96-08.99	83/110		0 986 473 096		← 56,93	1 987 470 506 <sup>8</sup>	
				0 986 474 096		→ 56,93	1 987 470 506 <sup>8</sup>	
				0 986 473 329		→ 57	1 987 470 506 <sup>8</sup>	
250 D Turbo	06.99-01.03	125		0 986 473 329		→ 57	1 987 470 506 <sup>8</sup>	
				0 986 474 329		→ 57	1 987 470 506 <sup>8</sup>	
270 CDI	06.99-01.03	125		0 986 473 329		→ 57	1 987 470 506 <sup>8</sup>	
				0 986 474 329		→ 57	1 987 470 506 <sup>8</sup>	
280	07.96-01.03	150		0 986 473 329		← 57		
				0 986 474 329		→ 57		
280 4MATIC	03.97-05.99	150		0 986 473 329		← 57	1 987 470 506 <sup>8</sup>	
				0 986 474 329		→ 57	1 987 470 506 <sup>8</sup>	
	07.99-01.03	150		0 986 473 329		← 57	1 987 470 506 <sup>8</sup>	
				0 986 474 329		→ 57	1 987 470 506 <sup>8</sup>	
	290 D Turbo	05.96-05.99	95		0 986 473 096		← 56,93	1 987 470 506 <sup>8</sup>
					0 986 474 096		→ 56,93	1 987 470 506 <sup>8</sup>
300 D Turbo	03.97-05.99	130		0 986 473 329		← 57	1 987 470 506 <sup>8</sup>	
				0 986 474 329		→ 57	1 987 470 506 <sup>8</sup>	
320	03.97-05.99	165		0 986 473 329		← 57	1 987 470 506 <sup>8</sup>	
				0 986 474 329		→ 57	1 987 470 506 <sup>8</sup>	
	07.99-01.03	165		0 986 473 329		← 57	1 987 470 506 <sup>8</sup>	
				0 986 474 329		→ 57	1 987 470 506 <sup>8</sup>	
	320 CDI	07.99-01.03	145		0 986 473 329		← 57	1 987 470 506 <sup>8</sup>
					0 986 474 329		→ 57	1 987 470 506 <sup>8</sup>
320 4MATIC	06.97-05.99	165		0 986 473 329		← 57	1 987 470 506 <sup>8</sup>	
				0 986 474 329		→ 57	1 987 470 506 <sup>8</sup>	
	07.99-02.03	165		0 986 473 329		← 57	1 987 470 506 <sup>8</sup>	
				0 986 474 329		→ 57	1 987 470 506 <sup>8</sup>	
	430	07.99-01.03	205		0 986 473 329		← 57	1 987 470 506 <sup>8</sup>
					0 986 474 329		→ 57	1 987 470 506 <sup>8</sup>





	<b>200</b>	05.96-05.99	100				0 986 473 967		← 40
							0 986 473 968		→ 40
		07.99-01.03	100				0 986 473 967		← 40
							0 986 473 968		→ 40
	<b>200 KOMPRESSOR</b>	09.97-05.99	137				0 986 473 967		← 40
							0 986 473 968		→ 40
		07.99-01.03	137				0 986 473 967		← 40
							0 986 473 968		→ 40
		09.00-01.03	120				0 986 473 967		← 40
							0 986 473 968		→ 40
	<b>220 CDI</b>	07.98-05.99	92				0 986 473 967		← 40
							0 986 473 968		→ 40
		07.99-01.03	100-105				0 986 473 967		← 40
							0 986 473 968		→ 40
	<b>230</b>	05.96-08.97	110				0 986 473 967		← 40
							0 986 473 968		→ 40
	<b>240</b>	09.97-01.03	125				0 986 473 967		← 40
							0 986 473 968		→ 40
	<b>250 D</b>	05.96-08.99	83/110				0 986 473 967		← 40
	<b>250 D Turbo</b>						0 986 473 968		→ 40
	<b>270 CDI</b>	06.99-01.03	125		NON		0 986 473 967		← 40
							0 986 473 968		→ 40
	<b>280</b>	07.96-01.03	150		NON		0 986 473 967		← 40
							0 986 473 968		→ 40
	<b>280 4MATIC</b>	03.97-05.99	150				0 986 473 967		← 40
							0 986 473 968		→ 40
		07.99-01.03	150				0 986 473 967		← 40
							0 986 473 968		→ 40
	<b>290 D Turbo</b>	05.96-05.99	95				0 986 473 967		← 40
							0 986 473 968		→ 40
	<b>300 D Turbo</b>	03.97-05.99	130				0 986 473 967		← 40
							0 986 473 968		→ 40
	<b>320</b>	03.97-05.99	165				0 986 473 967		← 40
							0 986 473 968		→ 40
		07.99-01.03	165				0 986 473 967		← 40
							0 986 473 968		→ 40
	<b>320 CDI</b>	07.99-01.03	145				0 986 473 967		← 40
							0 986 473 968		→ 40
	<b>320 4MATIC</b>	06.97-05.99	165				0 986 473 967		← 40
							0 986 473 968		→ 40
		07.99-02.03	165				0 986 473 967		← 40
							0 986 473 968		→ 40
	<b>420</b>	05.96-08.97	205				0 986 473 967		← 40
							0 986 473 968		→ 40
	<b>430</b>	09.97-05.99	205		Fg.-Nr. →A962231, Komp.Nr. Code 809		0 986 473 967		← 40
							0 986 473 968		→ 40
		07.99-01.03	205		Fg.-Nr. →A962231, Komp.Nr. Code 809		0 986 473 967		← 40
							0 986 473 968		→ 40

	<b>55 AMG</b>	03.98-05.99	260				1 987 477 849		← 1058
							1 987 477 850		→ 1031
						LLE	1 987 477 701		2613
		07.99-01.03	260				1 987 477 849		← 1058
							1 987 477 850		→ 1031
						LLE	1 987 477 701		2613
	<b>200</b>	05.96-05.99	100				1 987 477 849		← 1058
							1 987 477 850		→ 1031
						LLE	1 987 477 701		2613





		S							
◀ MERCEDES-BENZ Serie E (T-Modell) [210]									
200	07.99-01.03	100					1987 477 849	←	1058
							1987 477 850	→	1031
						LLE	1987 477 701		2613
200 KOMPRESSOR	09.97-05.99	137					1987 477 849	←	1058
							1987 477 850	→	1031
						LLE	1987 477 701		2613
	07.99-01.03	137					1987 477 849	←	1058
						LLE	1987 477 850	→	1031
						LLE	1987 477 701		2613
	09.00-01.03	120					1987 477 849	←	1058
						LLE	1987 477 850	→	1031
						LLE	1987 477 701		2613
220 CDI	07.98-05.99	92					1987 477 849	←	1058
							1987 477 850	→	1031
						LLE	1987 477 701		2613
	07.99-01.03	100-105				Fg.-Nr. 210.206	1987 477 849	←	1058
							1987 477 850	→	1031
						LLE	1987 477 701		2613
230	05.96-08.97	110					1987 477 849	←	1058
							1987 477 850	→	1031
						LLE	1987 477 701		2613
240	09.97-01.03	125					1987 477 849	←	1058
							1987 477 850	→	1031
						LLE	1987 477 701		2613
250 D	05.96-06.98	83					1987 477 849	←	1058
							1987 477 850	→	1031
						LLE	1987 477 701		2613
						Fg.-Nr. 210.210	1987 477 701		2613
250 D Turbo	09.97-08.99	110					1987 477 701		2613
							1987 477 849	←	1058
							1987 477 850	→	1031
270 CDI	06.99-01.03	125					1987 477 849	←	1058
							1987 477 850	→	1031
						LLE	1987 477 701		2613
						Fg.-Nr. 210.216	1987 477 701		2613
280	07.96-01.03	150				Fg.-Nr. 210.263	1987 477 701		2613
							1987 477 849	←	1058
280 4MATIC							1987 477 850	→	1031
280 4MATIC	03.97-05.99	150					1987 477 701		2613
							1987 477 850	→	1031
	07.99-01.03	150				LLE	1987 477 701		2613
290 D Turbo	05.96-05.99	95					1987 477 849	←	1058
							1987 477 850	→	1031
						LLE	1987 477 701		2613
						Fg.-Nr. 210.217	1987 477 701		2613
300 D Turbo	03.97-05.99	130					1987 477 849	←	1058
							1987 477 850	→	1031
						LLE	1987 477 701		2613
320	03.97-05.99	165					1987 477 849	←	1058
							1987 477 850	→	1031
						LLE	1987 477 701		2613
	07.99-01.03	165					1987 477 849	←	1058
						LLE	1987 477 850	→	1031
						LLE	1987 477 701		2613
320 CDI	07.99-01.03	145					1987 477 849	←	1058
							1987 477 850	→	1031
						LLE	1987 477 701		2613
320 4MATIC	06.97-05.99	165					1987 477 849	←	1058
							1987 477 850	→	1031
						LLE	1987 477 701		2613
	07.99-02.03	165					1987 477 849	←	1058
						LLE	1987 477 850	→	1031
						LLE	1987 477 701		2613
420	05.96-08.97	205					1987 477 849	←	1058
							1987 477 850	→	1031
						LLE	1987 477 701		2613



		S								
<b>430</b>										
<b>430 4MATIC</b>		06.97-01.03	205						1 987 477 849	← 1058
									1 987 477 850	→ 1031
							LLE		1 987 477 701	2613
<b>55 AMG</b>		03.98-05.99	260				LAB		0 265 006 178 <sup>4</sup>	
							RAB		0 265 006 190 <sup>3</sup>	
									0 265 006 188 <sup>3</sup>	
									0 265 006 194 <sup>4</sup>	
		07.99-01.03	260				LAB		0 265 006 178 <sup>4</sup>	
							RAB		0 265 006 190 <sup>3</sup>	
									0 265 006 188 <sup>3</sup>	
									0 265 006 194 <sup>4</sup>	
<b>200</b>		05.96-05.99	100				LAB		0 265 006 178 <sup>4</sup>	
							RAB		0 265 006 190 <sup>3</sup>	
									0 265 006 188 <sup>3</sup>	
									0 265 006 194 <sup>4</sup>	
		07.99-01.03	100				LAB		0 265 006 178 <sup>4</sup>	
							RAB		0 265 006 190 <sup>3</sup>	
									0 265 006 188 <sup>3</sup>	
									0 265 006 194 <sup>4</sup>	
<b>200 KOMPRESSOR</b>		09.97-05.99	137				LAB		0 265 006 178 <sup>4</sup>	
							RAB		0 265 006 190 <sup>3</sup>	
									0 265 006 188 <sup>3</sup>	
									0 265 006 194 <sup>4</sup>	
		07.99-01.03	137				LAB		0 265 006 178 <sup>4</sup>	
							RAB		0 265 006 190 <sup>3</sup>	
									0 265 006 188 <sup>3</sup>	
									0 265 006 194 <sup>4</sup>	
		09.00-01.03	120				LAB		0 265 006 178 <sup>4</sup>	
							RAB		0 265 006 190 <sup>3</sup>	
									0 265 006 188 <sup>3</sup>	
									0 265 006 194 <sup>4</sup>	
<b>220 CDI</b>		07.98-05.99	92				LAB		0 265 006 178 <sup>4</sup>	
							RAB		0 265 006 190 <sup>3</sup>	
									0 265 006 188 <sup>3</sup>	
									0 265 006 194 <sup>4</sup>	
		07.99-01.03	100-105				LAB		0 265 006 178 <sup>4</sup>	
							RAB		0 265 006 190 <sup>3</sup>	
									0 265 006 188 <sup>3</sup>	
									0 265 006 194 <sup>4</sup>	
<b>230</b>		05.96-08.97	110				LAB		0 265 006 178 <sup>4</sup>	
							RAB		0 265 006 190 <sup>3</sup>	
									0 265 006 188 <sup>3</sup>	
									0 265 006 194 <sup>4</sup>	
<b>240</b>		09.97-01.03	125				LAB		0 265 006 178 <sup>4</sup>	
							RAB		0 265 006 190 <sup>3</sup>	
									0 265 006 188 <sup>3</sup>	
									0 265 006 194 <sup>4</sup>	
<b>250 D</b>		05.96-08.99	83/110				LAB		0 265 006 178 <sup>4</sup>	
<b>250 D Turbo</b>							RAB		0 265 006 190 <sup>3</sup>	
									0 265 006 188 <sup>3</sup>	
									0 265 006 194 <sup>4</sup>	
<b>270 CDI</b>		06.99-01.03	125				LAB		0 265 006 178 <sup>4</sup>	
							RAB		0 265 006 190 <sup>3</sup>	
									0 265 006 188 <sup>3</sup>	
									0 265 006 194 <sup>4</sup>	
<b>280</b>		07.96-01.03	150				LAB		0 265 006 190 <sup>3</sup>	
							RAB		0 265 006 188 <sup>3</sup>	
									0 265 006 194 <sup>4</sup>	
<b>280, 4MATIC</b>		07.96-01.03	150				LAB		0 265 006 178 <sup>4</sup>	





◀ MERCEDES-BENZ Serie E (T-Modell) [210]						
280 4MATIC	03.97-05.99	150	LAB	0 265 006 358 <sup>3</sup>		
			RAB	0 265 006 194 <sup>4</sup>		
				0 265 006 356 <sup>3</sup>		
	07.99-01.03	150	LAB	0 265 006 358 <sup>3</sup>		
			RAB	0 265 006 194 <sup>4</sup>		
				0 265 006 356 <sup>3</sup>		
290 D Turbo	05.96-05.99	95	LAB	0 265 006 178 <sup>4</sup>		
			RAB	0 265 006 188 <sup>3</sup>		
				0 265 006 194 <sup>4</sup>		
300 D Turbo	03.97-05.99	130	LAB	0 265 006 178 <sup>4</sup>		
			RAB	0 265 006 188 <sup>3</sup>		
				0 265 006 194 <sup>4</sup>		
320	03.97-05.99	165	LAB	0 265 006 178 <sup>4</sup>		
			RAB	0 265 006 188 <sup>3</sup>		
				0 265 006 190 <sup>3</sup>		
	07.99-01.03	165	LAB	0 265 006 178 <sup>4</sup>		
			RAB	0 265 006 188 <sup>3</sup>		
				0 265 006 194 <sup>4</sup>		
320 CDI	07.99-01.03	145	LAB	0 265 006 178 <sup>4</sup>		
			RAB	0 265 006 188 <sup>3</sup>		
				0 265 006 190 <sup>3</sup>		
				0 265 006 194 <sup>4</sup>		
320 4MATIC	06.97-05.99	165	LAB	0 265 006 178 <sup>4</sup>		
			RAB	0 265 006 188 <sup>3</sup>		
				0 265 006 358 <sup>3</sup>		
				0 265 006 356 <sup>3</sup>		
	07.99-02.03	165	LAB	0 265 006 178 <sup>4</sup>		
			RAB	0 265 006 188 <sup>3</sup>		
				0 265 006 194 <sup>4</sup>		
				0 265 006 358 <sup>3</sup>		
				0 265 006 194 <sup>4</sup>		
				0 265 006 356 <sup>3</sup>		
420	05.96-08.97	205	LAB	0 265 006 178 <sup>4</sup>		
			RAB	0 265 006 188 <sup>3</sup>		
				0 265 006 190 <sup>3</sup>		
				0 265 006 194 <sup>4</sup>		
430	09.97-05.99	205	LAB	0 265 006 190 <sup>3</sup>		
			RAB	0 265 006 188 <sup>3</sup>		
				0 265 006 194 <sup>4</sup>		
	07.99-01.03	205	LAB	0 265 006 190 <sup>3</sup>		
			RAB	0 265 006 188 <sup>3</sup>		
				0 265 006 194 <sup>4</sup>		
430, 4MATIC	06.97-01.03	205	LAB	0 265 006 178 <sup>4</sup>		
430 4MATIC	06.97-01.03	205	LAB	0 265 006 358 <sup>3</sup>		
			RAB	0 265 006 194 <sup>4</sup>		
				0 265 006 356 <sup>3</sup>		











**Serie E (T-Modell) [211]**

	200 CDI	02.03-08.09	100/120/		0 204 204 787	← 60
	200 KOMPRESSOR		135		0 986 134 013	
					0 204 204 788	→ 60
					0 986 135 013	
220 CDI	02.03-08.09	100/110/	125		0 204 204 787	← 60
					0 986 134 013	
					0 204 204 788	→ 60
					0 986 135 013	

	S							
230	09.07-08.09	150				0 204 204 787 0 986 134 013	← 60 	
						0 204 204 788 0 986 135 013	→ 60 	
240	02.03-03.05	130				0 204 204 787 0 986 134 013	← 60 	
						0 204 204 788 0 986 135 013	→ 60 	
240 4MATIC	09.03-08.09	130				0 986 134 073 0 986 135 073	→ →	
270 CDI	02.03-03.05	120-130			TW	0 204 204 787 0 986 134 013	← 60 	
						0 204 204 788 0 986 135 013	→ 60 	
280	04.05-08.09	170			ATP	0 204 204 787 0 986 134 013	← 60 	
						0 204 204 788 0 986 135 013	→ 60 	
280 CDI	04.05-08.09	140			SBJ	0 204 204 787 0 986 134 013	← 60 	
						0 204 204 788 0 986 135 013	→ 60 	
280 CDI 4MATIC	04.05-08.09	140			ATP	0 986 134 073 0 986 135 073	→ →	
				Fg.-Nr. X 196565→	ATP	0 986 135 079 0 986 134 079	← 44 → 44	
280 4MATIC	04.05-08.09	170			ATP	0 986 134 073 0 986 135 073	→ →	
				Fg.-Nr. X 196565→	ATP	0 986 135 079 0 986 134 079	← 44 → 44	
320 CDI 4MATIC	04.05-08.09	165			ATP	0 986 134 073 0 986 135 073	→ →	
				Fg.-Nr. X 196565→	ATP	0 986 135 079 0 986 134 079	← 44 → 44	
320 4MATIC	09.03-03.05	165				0 986 134 073 0 986 135 073	→ →	
350 CGI	12.07-08.09	215			ATP	0 204 204 787 0 986 134 013	← 60 	
						0 204 204 788 0 986 135 013	→ 60 	
350 4MATIC	04.05-08.09	200			ATP	0 986 134 073 0 986 135 073	→ →	
				Fg.-Nr. X 196565→	ATP	0 986 135 079 0 986 134 079	← 44 → 44	
500 4MATIC	09.06-08.09	285				0 986 135 079 0 986 134 079	← 44 → 44	
200 CDI	04.07-08.09	100			TA	0 986 134 086 0 986 135 086	← 42 → 42	
					TA	0 986 134 055 0 986 135 055	← 42 → 42	
200 KOMPRESSOR	02.03-03.06	120			TA	0 986 134 086 0 986 135 086	← 42 → 42	
					TA	0 986 134 055 0 986 135 055	← 42 → 42	
	04.06-08.09	135			ATP,SPT, TA	0 986 134 055 0 986 135 055	← 42 → 42	
					ATP,TA, VSP	0 986 134 086 0 986 135 086	← 42 → 42	



<b>◀ MERCEDES-BENZ Serie E (T-Modell) [211]</b>									
<b>220 CDI</b>	02.03-08.09	100/110/ 125			TA	0986 <b>134 086</b>		42	
						0986 <b>135 086</b>		42	
					TA	0986 <b>134 055</b>		42	
						0986 <b>135 055</b>		42	
<b>230</b>	09.07-08.09	150			TA	0986 <b>134 086</b>		42	
						0986 <b>135 086</b>		42	
					TA	0986 <b>134 055</b>		42	
						0986 <b>135 055</b>		42	
<b>240</b> <b>240 4MATIC</b>	02.03-08.09	130			TA	0986 <b>134 086</b>		42	
						0986 <b>135 086</b>		42	
					TA	0986 <b>134 055</b>		42	
						0986 <b>135 055</b>		42	
<b>270 CDI</b>	02.03-03.05	120-130			TA	0986 <b>134 086</b>		42	
						0986 <b>135 086</b>		42	
					TA	0986 <b>134 055</b>		42	
						0986 <b>135 055</b>		42	
<b>280</b> <b>280 CDI</b>	04.05-08.09	140/170				0986 <b>134 055</b>		42	
						0986 <b>135 055</b>		42	
<b>280 CDI</b>	04.04-03.05	130				0986 <b>134 055</b>		42	
						0986 <b>135 055</b>		42	
<b>280 CDI 4MATIC</b> <b>280 4MATIC</b>	04.05-08.09	140/170			ATP,SPT	0986 <b>134 055</b>		42	
						0986 <b>135 055</b>		42	
					ATP,VSP	0986 <b>134 086</b>		42	
						0986 <b>135 086</b>		42	
<b>320</b>	02.03-03.05	165				0986 <b>134 055</b>		42	
						0986 <b>135 055</b>		42	
<b>320 CDI</b>	02.03-03.05	150				0986 <b>134 055</b>		42	
						0986 <b>135 055</b>		42	
<b>320 CDI</b> <b>320 CDI 4MATIC</b>	04.05-08.09	165			ATP,SPT	0986 <b>134 055</b>		42	
						0986 <b>135 055</b>		42	
					ATP,VSP	0986 <b>134 086</b>		42	
						0986 <b>135 086</b>		42	
<b>320 4MATIC</b>	09.03-03.05	165				0986 <b>134 055</b>		42	
						0986 <b>135 055</b>		42	
<b>350, CGI, 4MATIC</b>	02.05-08.09	200/215				0986 <b>134 055</b>		42	
						0986 <b>135 055</b>		42	
<b>500</b>	04.06-08.09	285						1987 <b>470 506<sup>8</sup></b>	
<b>500</b>	09.03-08.06	225				0986 <b>134 055</b>		42	
<b>500 4MATIC</b>						0986 <b>135 055</b>		42	
<b>500 4MATIC</b>	09.06-08.09	285				0986 <b>134 055</b>		42	
						0986 <b>135 055</b>		42	
	<b>55 AMG KOMPRESSOR</b>	09.03-05.06	350			1987 <b>477 897</b>		1726	
						LLE	1987 <b>477 851</b>	1952	
						RLE	1987 <b>477 898</b>	1433	
<b>63 AMG</b>	06.06-08.09	378				1987 <b>477 897</b>		1726	
						LLE	1987 <b>477 851</b>	1952	
						RLE	1987 <b>477 898</b>	1433	
<b>200 CDI</b>	04.07-08.09	100/120/135				1987 <b>477 897</b>		1726	
						<b>200 CDI</b>	02.03-08.09	100/120/	LLE
<b>200 KOMPRESSOR</b>		135				RLE	1987 <b>477 898</b>	1433	
<b>200 KOMPRESSOR</b>	02.03-08.09	100/120/135					1987 <b>477 897</b>		1726
<b>220 CDI</b>	02.03-08.09	100/110/ 125					1987 <b>477 897</b>		1726
						LLE	1987 <b>477 851</b>	1952	
						RLE	1987 <b>477 898</b>	1433	
<b>230</b>	09.07-08.09	150					1987 <b>477 897</b>		1726
						LLE	1987 <b>477 851</b>	1952	
						RLE	1987 <b>477 898</b>	1433	
<b>240</b>	02.03-03.05	130					1987 <b>477 897</b>		1726
<b>240</b> <b>240 4MATIC</b>	02.03-08.09	130				LLE	1987 <b>477 851</b>	1952	
						RLE	1987 <b>477 898</b>	1433	

								
240 4MATIC	09.03-08.09	130				1 987 477 897	↔ 1726	
270 CDI	02.03-03.05	120-130				1 987 477 897	↔ 1726	
						LLE	1952	
						RLE	1433	
280	04.05-08.09	130/140/170				1 987 477 897	↔ 1726	
280, CDI, CDI 4MATIC, 4MATIC	04.04-08.09	130/140/ 170				LLE	1952	
						RLE	1433	
280 CDI	04.04-08.09	130/140/170				1 987 477 897	↔ 1726	
280 CDI 4MATIC	04.05-08.09	130/140/170				1 987 477 897	↔ 1726	
280 4MATIC	04.05-08.09	130/140/170				1 987 477 897	↔ 1726	
320	02.03-03.05	150/165				1 987 477 897	↔ 1726	
320, CDI, CDI 4MATIC, 4MATIC	02.03-08.09	150/165				LLE	1952	
						RLE	1433	
320 CDI	02.03-08.09	150/165				1 987 477 897	↔ 1726	
320 CDI 4MATIC	04.05-08.09	150/165				1 987 477 897	↔ 1726	
320 4MATIC	09.03-03.05	150/165				1 987 477 897	↔ 1726	
350	02.05-08.09	200/215				1 987 477 897	↔ 1726	
350, CGI, 4MATIC	02.05-08.09	200/215				LLE	1952	
						RLE	1433	
350 CGI	12.07-08.09	200/215				1 987 477 897	↔ 1726	
350 4MATIC	04.05-08.09	200/215				1 987 477 897	↔ 1726	
500	09.03-08.09	225/285				1 987 477 897	↔ 1726	
500	09.03-08.09	225/285				LLE	1952	
500 4MATIC						RLE	1433	
500 4MATIC	09.03-08.09	225/285				1 987 477 897	↔ 1726	
 55 AMG KOMPRESSOR	09.03-05.06	350				0 265 007 500 <sup>4</sup>		
						0 265 008 097 <sup>3</sup>		
63 AMG	06.06-08.09	378				0 265 008 097 <sup>3</sup>		
						0 986 594 563 <sup>4</sup>		
200 CDI	04.07-08.09	100				0 265 008 097 <sup>3</sup>		
						0 986 594 563 <sup>4</sup>		
200 KOMPRESSOR	02.03-03.06	120				0 265 007 500 <sup>4</sup>		
						0 265 008 097 <sup>3</sup>		
	04.06-08.09	135				0 265 008 097 <sup>3</sup>		
						0 986 594 563 <sup>4</sup>		
220 CDI	02.03-08.09	100/110				0 265 007 500 <sup>4</sup>		
						0 265 008 097 <sup>3</sup>		
	04.06-08.09	125				0 265 008 097 <sup>3</sup>		
						0 986 594 563 <sup>4</sup>		
230	09.07-08.09	150				0 265 008 097 <sup>3</sup>		
						0 986 594 563 <sup>4</sup>		
240	02.03-03.05	130				0 265 008 097 <sup>3</sup>		
240, 4MATIC	02.03-08.09	130				0 265 007 500 <sup>4</sup>		
270 CDI	02.03-03.05	120-130				0 265 007 500 <sup>4</sup>		
						0 265 008 097 <sup>3</sup>		
280, CDI, CDI 4MATIC, 4MATIC	04.04-08.09	130/140/ 170				0 265 008 097 <sup>3</sup>		
						0 986 594 563 <sup>4</sup>		
320, CDI, CDI 4MATIC	02.03-08.09	165				0 265 008 097 <sup>3</sup>		
320, 4MATIC	02.03-03.05	165				0 265 007 500 <sup>4</sup>		
320 CDI	02.03-03.05	150				0 265 007 500 <sup>4</sup>		
						0 265 008 097 <sup>3</sup>		
320 CDI, CDI 4MATIC	04.05-08.09	165				0 986 594 563 <sup>4</sup>		
350, CGI, 4MATIC	02.05-08.09	200/215				0 265 008 097 <sup>3</sup>		
						0 986 594 563 <sup>4</sup>		
500	09.03-03.06	225				0 265 008 097 <sup>3</sup>		
500	09.03-08.06	225				0 265 007 500 <sup>4</sup>		
500 4MATIC	04.06-08.09	285				0 265 008 097 <sup>3</sup>		
						0 986 594 563 <sup>4</sup>		





◀ MERCEDES-BENZ

Serie E (T-Modell) [212]



	<b>200</b>	08.12→	135			1 987 470 506 <sup>8</sup>
	<b>200</b> BlueTec, CDI	08.09→	100			1 987 470 506 <sup>8</sup>
	<b>200</b> CGI	08.09-12.13	135	Mod.Jahr →2010		1 987 470 506 <sup>8</sup>
				Mod.Jahr 2011→		1 987 470 506 <sup>8</sup>
	<b>220</b> BlueTec, BlueTec 4MATIC, CDI	08.09→	125			1 987 470 506 <sup>8</sup>
	<b>250</b>	08.12→	155			1 987 470 506 <sup>8</sup>
	<b>250</b> BlueTec, BlueTec 4MATIC, CDI, CDI 4MATIC	08.09→	150			1 987 470 506 <sup>8</sup>
	<b>250</b> CGI	08.09-12.13	150	Mod.Jahr →2010		1 987 470 506 <sup>8</sup>
				Mod.Jahr 2011→		1 987 470 506 <sup>8</sup>
	<b>300</b> , BlueTec, BlueTec Hybrid, CDI, 4MATIC	12.09→	150/170/ 185			1 987 470 506 <sup>8</sup>
	<b>350</b> , BlueTec, CDI, CDI 4MATIC, CGI, 4MATIC	08.09→	155/170/185/195/ 200/215/225			1 987 470 506 <sup>8</sup>
	<b>400</b> , 4MATIC	01.13→	245			1 987 470 506 <sup>8</sup>
	<b>500</b> , 4MATIC	08.09→	285/300			1 987 470 506 <sup>8</sup>



	<b>63 AMG</b>	08.09→	386/410/430		1 987 482 329	↔ 743
	<b>63 AMG S</b>	11.12→	386/410/430		1 987 482 329	↔ 743
	<b>63 AMG S</b> 4MATIC	11.12→	386/410/430		1 987 482 329	↔ 743
	<b>63 AMG</b> 4MATIC	08.12→	386/410/430		1 987 482 329	↔ 743
	<b>200</b>	08.12→	100/135		1 987 482 329	↔ 743
	<b>200</b> BlueTec	07.14→	100/135		1 987 482 329	↔ 743
	<b>200</b> CDI	08.09→	100/135		1 987 482 329	↔ 743
	<b>200</b> CGI	08.09-12.13	100/135		1 987 482 329	↔ 743
	<b>220</b> BlueTec	07.14→	125		1 987 482 329	↔ 743
	<b>220</b> BlueTec 4MATIC	12.14→	125		1 987 482 329	↔ 743
	<b>220</b> CDI	08.09→	125		1 987 482 329	↔ 743
	<b>250</b>	08.12→	150/155		1 987 482 329	↔ 743
	<b>250</b> BlueTec	07.14→	150/155		1 987 482 329	↔ 743
	<b>250</b> BlueTec 4MATIC	07.14→	150/155		1 987 482 329	↔ 743
	<b>250</b> CDI	08.09→	150/155		1 987 482 329	↔ 743
	<b>250</b> CDI 4MATIC	01.11→	150/155		1 987 482 329	↔ 743
	<b>250</b> CGI	08.09-12.13	150/155		1 987 482 329	↔ 743
	<b>300</b>	02.10→	150/170/185		1 987 482 329	↔ 743
	<b>300</b> BlueTec	08.12→	150/170/185		1 987 482 329	↔ 743
	<b>300</b> BlueTec Hybrid	04.12→	150/170/185		1 987 482 329	↔ 743
	<b>300</b> CDI	12.09-12.13	150/170/185		1 987 482 329	↔ 743
	<b>300</b> 4MATIC	07.11→	150/170/185		1 987 482 329	↔ 743
	<b>350</b>	08.09→	155/170/185/195/200/215/225		1 987 482 329	↔ 743
	<b>350</b> BlueTec	08.09→	155/170/185/195/200/215/225		1 987 482 329	↔ 743
	<b>350</b> CDI	08.09→	155/170/185/195/200/215/225		1 987 482 329	↔ 743
	<b>350</b> CDI 4MATIC	08.09→	155/170/185/195/200/215/225		1 987 482 329	↔ 743
	<b>350</b> CGI	08.09-07.11	155/170/185/195/200/215/225		1 987 482 329	↔ 743
	<b>350</b> 4MATIC	08.09-07.11	155/170/185/195/200/215/225		1 987 482 329	↔ 743
		09.11→	155/170/185/195/200/215/225		1 987 482 329	↔ 743
	<b>400</b>	01.13→	245		1 987 482 329	↔ 743
	<b>400</b> 4MATIC	01.13→	245		1 987 482 329	↔ 743
	<b>500</b>	08.09→	285/300		1 987 482 329	↔ 743
	<b>500</b> 4MATIC	08.11→	285/300		1 987 482 329	↔ 743

	<b>63 AMG</b>	08.09→	386/410	LAB	0 265 008 135 <sup>3</sup>	
	<b>200</b> CDI	08.09→	100	LAB	0 265 008 135 <sup>3</sup>	
	<b>200</b> CGI	08.09-12.13	135	Mod.Jahr →2012	LAB	0 265 008 135 <sup>3</sup>
	<b>220</b> CDI	08.09→	125	Mod.Jahr →2012	LAB	0 265 008 135 <sup>3</sup>
	<b>250</b> CDI, CGI	08.09→	150	Mod.Jahr →2012	LAB	0 265 008 135 <sup>3</sup>

		S							
<b>300</b>		02.10-12.11	170			LAB	0 265 008 135 <sup>3</sup>		
		07.11→	185	Mod.Jahr →2012		LAB	0 265 008 135 <sup>3</sup>		
<b>300 BlueTec</b>		08.12→	170	Komp.Nr. 803		LAB	0 265 008 135 <sup>3</sup>		
<b>300 CDI</b>		12.09-12.10	150			LAB	0 265 008 135 <sup>3</sup>		
		07.10-12.13	170	Mod.Jahr →2012		LAB	0 265 008 135 <sup>3</sup>		
<b>350, CGI</b>		08.09→	200/215/225			LAB	0 265 008 135 <sup>3</sup>		
<b>350 BlueTec</b>		08.09-12.13	155	Mod.Jahr →2012		LAB	0 265 008 135 <sup>3</sup>		
		08.12→	185	Komp.Nr. 803		LAB	0 265 008 135 <sup>3</sup>		
<b>350 CDI</b>		08.09-11.10	170			LAB	0 265 008 135 <sup>3</sup>		
		12.10→	195	Mod.Jahr →2012		LAB	0 265 008 135 <sup>3</sup>		
<b>500</b>		08.09-07.11	285			LAB	0 265 008 135 <sup>3</sup>		
		08.11→	300	Mod.Jahr →2012		LAB	0 265 008 135 <sup>3</sup>		
<b>Serie E [124]</b>									
	<b>60 AMG</b>	07.93-06.95	280	Fg.-Nr. →B 927760			0 986 474 953		← 38
							0 986 474 954		→
				Fg.-Nr. B 927761→			0 986 473 748		← 40
							0 986 473 749		→ 40
	<b>200</b>	07.93-07.95	100				0 986 473 678		← 54 1 987 470 287 <sup>7</sup>
							0 986 473 678		← 54 1 987 474 486 <sup>8</sup>
							0 986 474 678		→ 54 1 987 470 287 <sup>7</sup>
	<b>200 D</b>	07.93-06.95	55				0 986 473 656		← 54 1 987 470 287 <sup>7</sup>
							0 986 473 656		← 54 1 987 474 486 <sup>8</sup>
							0 986 474 656		→ 54 1 987 470 287 <sup>7</sup>
	<b>220</b>	07.93-06.95	110				0 986 473 678		← 54 1 987 470 287 <sup>7</sup>
							0 986 473 678		← 54 1 987 474 486 <sup>8</sup>
							0 986 474 678		→ 54 1 987 470 287 <sup>7</sup>
	<b>250 D</b>	07.93-06.95	83			FKR	0 986 473 656		← 54 1 987 470 287 <sup>7</sup>
							0 986 473 656		← 54 1 987 474 486 <sup>8</sup>
							0 986 474 656		→ 54 1 987 470 287 <sup>7</sup>
						FLR	0 986 473 678		← 54 1 987 470 287 <sup>7</sup>
							0 986 474 678		→ 54 1 987 470 287 <sup>7</sup>
	<b>250 D Turbo</b>	07.93-06.95	93				0 986 473 678		← 54 1 987 470 287 <sup>7</sup>
							0 986 473 678		← 54 1 987 474 486 <sup>8</sup>
							0 986 474 678		→ 54 1 987 470 287 <sup>7</sup>
	<b>280</b>	07.93-06.95	142	Fg.-Nr. 124.028...			0 986 473 678		← 54 1 987 470 287 <sup>7</sup>
							0 986 473 678		← 54 1 987 474 486 <sup>8</sup>
							0 986 474 678		→ 54 1 987 470 287 <sup>7</sup>
	<b>300 D</b>	07.93-06.95	100				0 986 473 678		← 54 1 987 470 287 <sup>7</sup>
							0 986 474 678		→ 54 1 987 470 287 <sup>7</sup>
	<b>300 D Turbo</b>	07.93-06.95	108				0 986 473 678		← 54 1 987 470 287 <sup>7</sup>
							0 986 473 678		← 54 1 987 474 486 <sup>8</sup>
							0 986 474 678		→ 54 1 987 470 287 <sup>7</sup>
	<b>300 D Turbo 4MATIC</b>	07.93-06.95	108						1 987 470 287 <sup>7</sup>
	<b>300 4MATIC</b>	07.93-06.95	132						1 987 470 287 <sup>7</sup>
	<b>420</b>	07.93-06.95	205/210	Fg.-Nr. B 938569→			0 986 473 748		← 40
							0 986 473 749		→ 40
	<b>500</b>	07.93-06.95	235-240	Fg.-Nr. →B 927760			0 986 474 953		← 38
							0 986 474 954		→
				Fg.-Nr. B 927761→			0 986 473 748		← 40
							0 986 473 749		→ 40
		09.93-08.94	235	Fg.-Nr. →B 930494			0 986 474 953		← 38
							0 986 474 954		→
				Fg.-Nr. B 930495→			0 986 473 748		← 40
							0 986 473 749		→ 40
	<b>60 AMG</b>	07.93-06.95	280	Fg.-Nr. →B 927760					1 987 470 083







<b>◀ MERCEDES-BENZ Serie E [124]</b>									
<b>200</b>	07.93-07.95	55/100				0986 471 951	← 35		
<b>200 D</b>						0986 473 951	↻		
						0986 471 952	→ 35		
						0986 473 952	↻		
<b>220</b>	07.93-06.95	110				0986 471 951	← 35		
						0986 473 951	↻		
						0986 471 952	→ 35		
						0986 473 952	↻		
<b>250 D</b>	07.93-06.95	83			FKR	0986 471 951	← 35		
						0986 473 951	↻		
						0986 471 952	→ 35		
						0986 473 952	↻		
					FLR	0986 473 963	↻ ← 38	1987 470 083	
						0986 473 964	↻ → 38	1987 470 083	
<b>250 D Turbo</b>	07.93-06.95	93				0986 471 951	← 35		
						0986 473 951	↻		
						0986 471 952	→ 35		
						0986 473 952	↻		
<b>280</b>	07.93-06.95	142	Fg.-Nr. 124029...			0986 473 971	↻ ← 42		
						0986 473 972	↻ → 42		
	ABS, 07.93-06.95	142	Fg.-Nr. 124028...			0986 471 951	← 35		
	OAS					0986 473 951	↻		
						0986 471 952	→ 35		
						0986 473 952	↻		
<b>300 D</b>	07.93-06.95	100/108/				0986 471 951	← 35		
<b>300 D Turbo</b>		132				0986 473 951	↻		
<b>300 D Turbo 4MATIC</b>						0986 471 952	→ 35		
<b>300 4MATIC</b>						0986 473 952	↻		
<b>320</b>	07.93-06.95	162				0986 473 963	↻ ← 38	1987 470 083	
						0986 473 964	↻ → 38	1987 470 083	
<b>420</b>	07.93-06.95	205/210						1987 470 083	
<b>500</b>	07.93-06.95	235-240	Fg.-Nr. →B 927760					1987 470 083	
	09.93-08.94	235						1987 470 083	



<b>60 AMG</b>	07.93-06.95	280				1987 477 047	↔ 1060		
						1987 477 306	2496		
<b>200</b>	07.93-07.95	55/100				1987 477 047	↔ 1060		
<b>200</b>	07.93-07.95	55/100			LLE	1987 477 306	2496		
<b>200 D</b>					RLE	1987 482 497	1883		
<b>200 D</b>	07.93-06.95	55/100				1987 477 047	↔ 1060		
<b>220</b>	07.93-06.95	110				1987 477 047	↔ 1060		
						LLE	1987 477 306	2496	
						RLE	1987 482 497	1883	
<b>250 D</b>	07.93-06.95	83/93				1987 477 047	↔ 1060		
<b>250 D Turbo</b>	07.93-06.95	83/93				1987 477 047	↔ 1060		
<b>250 D</b>	07.93-06.95	83/93			LLE	1987 477 306	2496		
<b>250 D Turbo</b>					RLE	1987 482 497	1883		
<b>280</b>	07.93-06.95	142				1987 477 047	↔ 1060		
			Fg.-Nr. 124028...			LLE	1987 477 306	2496	
						RLE	1987 482 497	1883	
<b>300 D</b>	07.93-06.95	100/108/132				1987 477 047	↔ 1060		
<b>300 D Turbo</b>	07.93-06.95	100/108/132				1987 477 047	↔ 1060		
<b>300 D Turbo 4MATIC</b>	07.93-06.95	100/108/132				1987 477 047	↔ 1060		
<b>300 D, D Turbo, D Turbo 4MATIC, 4MATIC</b>	07.93-06.95	100/108/132			LLE	1987 477 306	2496		
<b>300 4MATIC</b>	07.93-06.95	100/108/132			RLE	1987 482 497	1883		
<b>320</b>	07.93-06.95	162				1987 477 047	↔ 1060		
						LLE	1987 477 306	2496	
						RLE	1987 482 497	1883	
<b>420</b>	07.93-06.95	205/210				1987 477 047	↔ 1060		
						1987 477 306	2496		

		S									
500		07.93-06.95	235-240				1 987 477 047	↔ 1060			
							1 987 477 306	2496			
				09.93-08.94	235				1 987 477 047	↔ 1060	
						LLE			1 987 477 306	2496	
	60 AMG	07.93-06.95	280		LAB		0 265 002 238 <sup>4</sup>				
					RAB		0 265 002 108 <sup>4</sup>				
				Fg.-Nr. →C013142	LAB		0 265 006 111 <sup>3</sup>				
					RAB		0 265 006 109 <sup>3</sup>				
				Fg.-Nr. C013141→	LAB		0 265 001 284 <sup>3</sup>				
					RAB		0 265 001 282 <sup>3</sup>				
200		07.93-07.95	100				0 265 002 208 <sup>4</sup>				
				Fg.-Nr. →C009355,	LAB		0 265 001 284 <sup>3</sup>				
				B891779→C009354,	RAB		0 265 001 282 <sup>3</sup>				
				Komp.Nr. Code 859							
	Fg.-Nr. C009356→,	LAB		0 265 006 111 <sup>3</sup>							
	B891779→C009354,	RAB		0 265 006 109 <sup>3</sup>							
	Komp.Nr. Code 859										
200 D		07.93-06.95	55	Fg.-Nr. →A060861	LAB		0 265 001 128 <sup>3</sup>				
					RAB		0 265 001 126 <sup>3</sup>				
				Fg.-Nr. →A203046			0 265 002 011 <sup>4</sup>				
				Fg.-Nr. A060862→	LAB		0 265 001 284 <sup>3</sup>				
				RAB		0 265 001 282 <sup>3</sup>					
	Fg.-Nr. A203047→					0 265 002 208 <sup>4</sup>					
220		07.93-06.95	110				0 265 002 208 <sup>4</sup>				
				Fg.-Nr. →C009355,	LAB		0 265 001 284 <sup>3</sup>				
				B891779→C009354,	RAB		0 265 001 282 <sup>3</sup>				
				Komp.Nr. Code 859							
	Fg.-Nr. C009356→,	LAB		0 265 006 111 <sup>3</sup>							
	B891779→C009354,	RAB		0 265 006 109 <sup>3</sup>							
	Komp.Nr. Code 859										
250 D		07.93-06.95	83				0 265 002 208 <sup>4</sup>				
					LAB		0 265 006 111 <sup>3</sup>				
					RAB		0 265 006 109 <sup>3</sup>				
250 D Turbo		07.93-06.95	93				0 265 001 284 <sup>3</sup>				
					RAB		0 265 001 282 <sup>3</sup>				
				Fg.-Nr. →A203046			0 265 002 011 <sup>4</sup>				
				Fg.-Nr. A203047→			0 265 002 208 <sup>4</sup>				
280		07.93-06.95	142	Fg.-Nr. →C009355,	LAB		0 265 001 284 <sup>3</sup>				
				B891779→C009354,	RAB		0 265 001 282 <sup>3</sup>				
				Komp.Nr. Code 859							
				Fg.-Nr. C009356→,	LAB		0 265 006 111 <sup>3</sup>				
	B891779→C009354,	RAB		0 265 006 109 <sup>3</sup>							
	Komp.Nr. Code 859										
	ABS, 07.93-06.95	142				0 265 002 210 <sup>4</sup>					
	OAS										
	ASR 07.93-06.95	142			LAB		0 265 002 206 <sup>4</sup>				
					RAB		0 265 002 204 <sup>4</sup>				
300 D		07.93-06.95	100				0 265 002 208 <sup>4</sup>				
					LAB		0 265 006 111 <sup>3</sup>				
					RAB		0 265 006 109 <sup>3</sup>				
300 D Turbo		07.93-06.95	108				0 265 001 284 <sup>3</sup>				
					RAB		0 265 001 282 <sup>3</sup>				
300 D Turbo 4MATIC		07.93-06.95	108				0 265 001 300 <sup>3</sup>				
					RAB		0 265 001 298 <sup>3</sup>				
300 D Turbo		07.93-06.95	108	Fg.-Nr. →A203046			0 265 002 011 <sup>4</sup>				
300 D Turbo 4MATIC				Fg.-Nr. A203047→			0 265 002 208 <sup>4</sup>				
300 4MATIC		07.93-06.95	132				0 265 002 208 <sup>4</sup>				
				Fg.-Nr. →C 009355	LAB		0 265 001 300 <sup>3</sup>				
					RAB		0 265 001 298 <sup>3</sup>				
				Fg.-Nr. C 009356→	LAB		0 265 001 400 <sup>3</sup>				
				RAB		0 265 001 398 <sup>3</sup>					



<b>◀ MERCEDES-BENZ Serie E [124]</b>								
<b>320</b>	07.93-06.95	162				0 265 002 210 <sup>4</sup>		
			Fg.-Nr. →C009355,	LAB		0 265 001 284 <sup>3</sup>		
			B891779→C009354,	RAB		0 265 001 282 <sup>3</sup>		
			Komp.Nr. Code 859					
			Fg.-Nr. C009356→,	LAB		0 265 006 111 <sup>3</sup>		
			B891779→C009354,	RAB		0 265 006 109 <sup>3</sup>		
			Komp.Nr. Code 859					
	ASR 07.93-06.95	162		LAB		0 265 002 206 <sup>4</sup>		
				RAB		0 265 002 204 <sup>4</sup>		
<b>420</b>	07.93-06.95	205/210	Fg.-Nr. →C013142	LAB		0 265 006 111 <sup>3</sup>		
				RAB		0 265 006 109 <sup>3</sup>		
			Fg.-Nr. C013141→	LAB		0 265 001 284 <sup>3</sup>		
				RAB		0 265 001 282 <sup>3</sup>		
	ABS, 07.93-06.95	205/210				0 265 002 210 <sup>4</sup>		
	OAS							
	ASR 07.93-06.95	205/210		LAB		0 265 002 238 <sup>4</sup>		
				RAB		0 265 002 108 <sup>4</sup>		
<b>500</b>	07.93-06.95	235-240		LAB		0 265 002 238 <sup>4</sup>		
				RAB		0 265 002 108 <sup>4</sup>		
			Fg.-Nr. →C013142	LAB		0 265 006 111 <sup>3</sup>		
				RAB		0 265 006 109 <sup>3</sup>		
			Fg.-Nr. C013141→	LAB		0 265 001 284 <sup>3</sup>		
				RAB		0 265 001 282 <sup>3</sup>		

**Serie E [210]**

	<b>200, CDI, D, KOMPRESSOR</b>	06.95-03.02	65/75/85/100/ 120/137			0 986 473 096		← 56,93 1 987 470 506 <sup>8</sup>
						0 986 474 096		→ 56,93 1 987 470 506 <sup>8</sup>
	<b>220 CDI</b>	07.99-03.02	100-105			0 986 473 096		← 56,93 1 987 470 506 <sup>8</sup>
						0 986 474 096		→ 56,93 1 987 470 506 <sup>8</sup>
	<b>220 CDI</b>	06.95-05.99	55-70/92			0 986 473 096		← 56,93 1 987 470 506 <sup>8</sup>
	<b>220 D</b>					0 986 474 096		→ 56,93 1 987 470 506 <sup>8</sup>
	<b>230</b>	06.95-08.97	110			0 986 473 096		← 56,93 1 987 470 506 <sup>8</sup>
						0 986 474 096		→ 56,93 1 987 470 506 <sup>8</sup>
	<b>240</b>	04.00-03.02	125			0 986 473 096		← 56,93 1 987 470 506 <sup>8</sup>
						0 986 474 096		→ 56,93 1 987 470 506 <sup>8</sup>
		MFD 09.97-04.00	125			0 986 473 329		← 57 1 987 470 506 <sup>8</sup>
						0 986 474 329		→ 57 1 987 470 506 <sup>8</sup>
		OFD 09.97-04.00	125			0 986 473 096		← 56,93 1 987 470 506 <sup>8</sup>
						0 986 474 096		→ 56,93 1 987 470 506 <sup>8</sup>
	<b>250 D</b>	06.95-05.99	83/110			0 986 473 096		← 56,93 1 987 470 506 <sup>8</sup>
	<b>250 D Turbo</b>					0 986 474 096		→ 56,93 1 987 470 506 <sup>8</sup>
	<b>270 CDI</b>	06.99-03.02	125			0 986 473 329		← 57 1 987 470 506 <sup>8</sup>
						0 986 474 329		→ 57 1 987 470 506 <sup>8</sup>
	<b>280</b>	06.95-01.03	142/150			0 986 473 329		← 57 1 987 470 506 <sup>8</sup>
	<b>280 4MATIC</b>					0 986 474 329		→ 57 1 987 470 506 <sup>8</sup>
	<b>290 D Turbo</b>	01.96-05.99	95			0 986 473 096		← 56,93 1 987 470 506 <sup>8</sup>
						0 986 474 096		→ 56,93 1 987 470 506 <sup>8</sup>
	<b>300 D</b>	06.95-02.97	100			0 986 473 096		← 56,93 1 987 470 506 <sup>8</sup>
						0 986 474 096		→ 56,93 1 987 470 506 <sup>8</sup>
	<b>300 D Turbo</b>	03.97-05.99	130			0 986 473 329		← 57 1 987 470 506 <sup>8</sup>
						0 986 474 329		→ 57 1 987 470 506 <sup>8</sup>
	<b>320, CDI, 4MATIC</b>	06.95-08.03	145/162/ 165			0 986 473 329		← 57 1 987 470 506 <sup>8</sup>
						0 986 474 329		→ 57 1 987 470 506 <sup>8</sup>
	<b>420</b>	01.96-08.97	205		ATP	0 986 473 329		← 57 1 987 470 506 <sup>8</sup>
						0 986 474 329		→ 57 1 987 470 506 <sup>8</sup>
	<b>200</b>	06.95-02.01	100	Fg.-Nr. →F 379346, Komp.Nr. Code 809	MZH	0 986 473 963		← 38 1 987 470 083
						0 986 473 964		→ 38 1 987 470 083

		S								
<b>200</b>	06.95-02.01	100	Fg.-Nr. F 379347→, Komp.Nr. Code 800	MEH	0 986 473 174	← 35,96	1 987 470 084			
					0 986 474 174	→ 35,96	1 987 470 084			
<b>200 CDI</b>	07.98-03.02	75/85			0 986 473 174	← 35,96	1 987 470 084			
					0 986 474 174	→ 35,96	1 987 470 084			
<b>200 D</b>	03.97-05.99	65	Fg.-Nr. →F 379346, Komp.Nr. Code 809	MZH	0 986 473 963	← 38	1 987 470 083			
					0 986 473 964	→ 38	1 987 470 083			
			Fg.-Nr. F 379347→, Komp.Nr. Code 800	MEH	0 986 473 174	← 35,96	1 987 470 084			
					0 986 474 174	→ 35,96	1 987 470 084			
<b>200 KOMPRESSOR</b>	09.97-08.00	137	Fg.-Nr. →A962231, Komp.Nr. Code 800		0 986 473 222	←	1 987 470 084			
					0 986 474 222	→	1 987 470 084			
				Fg.-Nr. A 962232→, Komp.Nr. Code 800, Fg.-Nr. X 000001→		0 986 473 174	← 35,96	1 987 470 084		
						0 986 474 174	→ 35,96	1 987 470 084		
	09.00-03.02	120			0 986 473 174	← 35,96	1 987 470 084			
					0 986 474 174	→ 35,96	1 987 470 084			
<b>220 CDI</b>	07.98-05.99	92			0 986 473 174	← 35,96	1 987 470 084			
					0 986 474 174	→ 35,96	1 987 470 084			
		07.99-03.02	100-105			0 986 473 174	← 35,96	1 987 470 084		
						0 986 474 174	→ 35,96	1 987 470 084		
<b>220 D</b>	06.95-05.99	55-70	Fg.-Nr. →F 379346, Komp.Nr. Code 809	MZH	0 986 473 963	← 38	1 987 470 083			
					0 986 473 964	→ 38	1 987 470 083			
				Fg.-Nr. F 379347→, Komp.Nr. Code 800	MEH	0 986 473 174	← 35,96	1 987 470 084		
						0 986 474 174	→ 35,96	1 987 470 084		
<b>230</b>	06.95-08.97	110	Fg.-Nr. →F 379346, Komp.Nr. Code 809	MZH	0 986 473 963	← 38	1 987 470 083			
					0 986 473 964	→ 38	1 987 470 083			
			Fg.-Nr. F 379347→, Komp.Nr. Code 800	MEH	0 986 473 174	← 35,96	1 987 470 084			
					0 986 474 174	→ 35,96	1 987 470 084			
<b>240</b>	04.00-03.02	125			0 986 473 174	← 35,96	1 987 470 084			
					0 986 474 174	→ 35,96	1 987 470 084			
		MFD 09.97-04.00	125	Fg.-Nr. →A 379346	MZH	0 986 473 276	← 36			
						0 986 474 276	→ 36			
				Fg.-Nr. A 379347→, X 000001→	MEH	0 986 473 222	←	1 987 470 084		
						0 986 474 222	→	1 987 470 084		
		OFD 09.97-04.00	125	Fg.-Nr. →F 379346, Komp.Nr. Code 809	MZH	0 986 473 963	← 38	1 987 470 083		
						0 986 473 964	→ 38	1 987 470 083		
				Fg.-Nr. F 379347→, Komp.Nr. Code 800	MEH	0 986 473 174	← 35,96	1 987 470 084		
						0 986 474 174	→ 35,96	1 987 470 084		
<b>250 D</b>	06.95-05.99	83	Fg.-Nr. →F 379346, Komp.Nr. Code 809	MZH	0 986 473 963	← 38	1 987 470 083			
					0 986 473 964	→ 38	1 987 470 083			
			Fg.-Nr. F 379347→, Komp.Nr. Code 800	MEH	0 986 473 174	← 35,96	1 987 470 084			
					0 986 474 174	→ 35,96	1 987 470 084			
<b>250 D Turbo</b>	09.97-05.99	110			0 986 473 174	← 35,96	1 987 470 084			
					0 986 474 174	→ 35,96	1 987 470 084			
<b>270 CDI</b>	06.99-03.02	125			0 986 473 222	←	1 987 470 084			
					0 986 474 222	→	1 987 470 084			
<b>280</b>	06.95-01.03	150		ERH,MZH	0 986 473 963	← 38	1 987 470 195			
					0 986 473 964	→ 38	1 987 470 195			
						Fg.-Nr. →A379346	MZH,NON	0 986 473 276	← 36	
								0 986 474 276	→ 36	
				Fg.-Nr. A379347→	MEH,NON	0 986 473 222	←	1 987 470 084		
						0 986 474 222	→	1 987 470 084		
	01.96-02.97	142		MEH	0 986 473 222	←	1 987 470 084			
				MZH	0 986 473 276	← 36				
					0 986 474 276	→ 36				
<b>280 4MATIC</b>	03.97-05.99	150	Fg.-Nr. →A 379346	MZH	0 986 473 276	← 36				
					0 986 474 276	→ 36				
				Fg.-Nr. A 379347→	MEH	0 986 473 222	←	1 987 470 084		
						0 986 474 222	→	1 987 470 084		
	07.99-01.03	150		ERH,MZH	0 986 473 967	← 40				
				MEH,NON	0 986 473 968	→ 40				
					0 986 473 222	←	1 987 470 084			
					0 986 474 222	→	1 987 470 084			



		S							
◀ MERCEDES-BENZ Serie E [210]									
290 D Turbo	01.96-05.99	95	Fg.-Nr. →F 379346, Komp.Nr. Code 809	MZH			0986 473 963	← 38	1987 470 083
							0986 473 964	→ 38	1987 470 083
			Fg.-Nr. F 379347→, Komp.Nr. Code 800	MEH			0986 473 174	← 35,96	1987 470 084
							0986 474 174	→ 35,96	1987 470 084
300 D	06.95-02.97	100	Fg.-Nr. →F 379346, Komp.Nr. Code 809	MZH			0986 473 963	← 38	1987 470 083
							0986 473 964	→ 38	1987 470 083
			Fg.-Nr. F 379347→, Komp.Nr. Code 800	MEH			0986 473 174	← 35,96	1987 470 084
							0986 474 174	→ 35,96	1987 470 084
300 D Turbo	03.97-05.99	130					0986 473 276	← 36	
							0986 474 276	→ 36	
320	06.95-02.97	162		MEH			0986 473 222	←	1987 470 084
							0986 474 222	→	1987 470 084
				MZH			0986 473 276	← 36	
							0986 474 276	→ 36	
	03.97-05.99	165		MEH			0986 473 222	←	1987 470 084
							0986 474 222	→	1987 470 084
				MZH			0986 473 276	← 36	
							0986 474 276	→ 36	
	07.99-08.03	165		FMS			0986 473 222	←	1987 470 084
							0986 474 222	→	1987 470 084
320 CDI	06.99-03.02	145					0986 473 222	←	1987 470 084
							0986 474 222	→	1987 470 084
320 4MATIC	09.97-05.99	165	Fg.-Nr. →A 379346	MZH			0986 473 276	← 36	
							0986 474 276	→ 36	
			Fg.-Nr. A 379347→	MEH			0986 473 222	←	1987 470 084
							0986 474 222	→	1987 470 084
	07.99-03.02	165					0986 473 222	←	1987 470 084
							0986 474 222	→	1987 470 084
420	01.96-08.97	205		MEH			0986 473 222	←	1987 470 084
							0986 474 222	→	1987 470 084
				MZH			0986 473 276	← 36	
							0986 474 276	→ 36	
430	09.97-05.99	205	Fg.-Nr. →A 379346	MZH			0986 473 276	← 36	
							0986 474 276	→ 36	
	50 AMG	01.96-08.97	205-235				1987 477 849	← 1058	
							1987 477 850	→ 1031	
	55 AMG	09.97-03.03	260				1987 477 849	← 1058	
							1987 477 850	→ 1031	
	200, CDI, D, KOMPRESSOR	06.95-03.02	65/75/85/ 100/120/ 137				1987 477 849	← 1058	
							1987 477 850	→ 1031	
	220 CDI	07.99-03.02	100-105				1987 477 849	← 1058	
							1987 477 850	→ 1031	
	220 CDI	06.95-05.99	55-70/92				1987 477 849	← 1058	
							1987 477 850	→ 1031	
	220 D						1987 477 701	← 2613	
230	06.95-08.97	110					1987 477 849	← 1058	
							1987 477 850	→ 1031	
							1987 477 701	← 2613	
240	09.97-03.02	125					1987 477 849	← 1058	
							1987 477 850	→ 1031	
							1987 477 701	← 2613	
250 D	06.95-05.99	83					1987 477 849	← 1058	
							1987 477 850	→ 1031	
							1987 477 701	← 2613	



		S							
250 D Turbo		09.97-05.99	110						
							1 987 477 701	2613	
							1 987 477 849	← 1058	
							1 987 477 850	→ 1031	
270 CDI		06.99-03.02	125				1 987 477 849	← 1058	
							1 987 477 850	→ 1031	
						LLE	1 987 477 701	2613	
280		06.95-01.03	142/150				1 987 477 849	← 1058	
280 4MATIC							1 987 477 850	→ 1031	
						LLE	1 987 477 701	2613	
290 D Turbo		01.96-05.99	95				1 987 477 849	← 1058	
							1 987 477 850	→ 1031	
						LLE	1 987 477 701	2613	
300 D		06.95-05.99	100/130				1 987 477 849	← 1058	
300 D Turbo							1 987 477 850	→ 1031	
						LLE	1 987 477 701	2613	
320		06.95-08.03	145/162/				1 987 477 849	← 1058	
320 CDI			165				1 987 477 850	→ 1031	
320 4MATIC						LLE	1 987 477 701	2613	
420		01.96-08.97	205				1 987 477 849	← 1058	
							1 987 477 850	→ 1031	
						LLE	1 987 477 701	2613	
430		09.97-03.02	205				1 987 477 849	← 1058	
430 4MATIC							1 987 477 850	→ 1031	
						LLE	1 987 477 701	2613	
50 AMG		01.96-08.97	205-235			LAB	0 265 006 178 <sup>4</sup>		
						RAB	0 265 006 190 <sup>3</sup>		
							0 265 006 188 <sup>3</sup>		
							0 265 006 194 <sup>4</sup>		
55 AMG		09.97-03.03	260			LAB	0 265 006 178 <sup>4</sup>		
						RAB	0 265 006 190 <sup>3</sup>		
							0 265 006 188 <sup>3</sup>		
							0 265 006 194 <sup>4</sup>		
200		06.95-03.02	65/75/85/			LAB	0 265 006 178 <sup>4</sup>		
200 CDI			100/120/			RAB	0 265 006 190 <sup>3</sup>		
200 D			137				0 265 006 188 <sup>3</sup>		
200 KOMPRESSOR							0 265 006 194 <sup>4</sup>		
220 CDI		07.99-03.02	100-105			LAB	0 265 006 178 <sup>4</sup>		
						RAB	0 265 006 190 <sup>3</sup>		
							0 265 006 188 <sup>3</sup>		
							0 265 006 194 <sup>4</sup>		
220 CDI		06.95-05.99	55-70/92			LAB	0 265 006 178 <sup>4</sup>		
220 D						RAB	0 265 006 190 <sup>3</sup>		
							0 265 006 188 <sup>3</sup>		
							0 265 006 194 <sup>4</sup>		
230		06.95-08.97	110			LAB	0 265 006 178 <sup>4</sup>		
						RAB	0 265 006 190 <sup>3</sup>		
							0 265 006 188 <sup>3</sup>		
							0 265 006 194 <sup>4</sup>		
240		09.97-03.02	125			LAB	0 265 006 178 <sup>4</sup>		
						RAB	0 265 006 190 <sup>3</sup>		
							0 265 006 188 <sup>3</sup>		
							0 265 006 194 <sup>4</sup>		
250 D		06.95-05.99	83/110			LAB	0 265 006 178 <sup>4</sup>		
250 D Turbo						RAB	0 265 006 190 <sup>3</sup>		
							0 265 006 188 <sup>3</sup>		
							0 265 006 194 <sup>4</sup>		
270 CDI		06.99-03.02	125			LAB	0 265 006 178 <sup>4</sup>		
						RAB	0 265 006 190 <sup>3</sup>		
							0 265 006 188 <sup>3</sup>		
							0 265 006 194 <sup>4</sup>		



		S								
◀ MERCEDES-BENZ Serie E [210]										
<b>280</b>		06.95-01.03	150			LAB	0 265 006 190 <sup>3</sup>			
							RAB	0 265 006 188 <sup>3</sup>		
								0 265 006 194 <sup>4</sup>		
		01.96-02.97	142			LAB	0 265 006 178 <sup>4</sup>			
							RAB	0 265 006 190 <sup>3</sup>		
								0 265 006 194 <sup>4</sup>		
<b>280, 4MATIC</b>		06.95-01.03	150			LAB	0 265 006 178 <sup>4</sup>			
<b>280 4MATIC</b>		03.97-05.99	150			LAB	0 265 006 358 <sup>3</sup>			
							RAB	0 265 006 194 <sup>4</sup>		
								0 265 006 356 <sup>3</sup>		
		07.99-01.03	150			LAB	0 265 006 358 <sup>3</sup>			
							RAB	0 265 006 194 <sup>4</sup>		
								0 265 006 356 <sup>3</sup>		
<b>290 D Turbo</b>		01.96-05.99	95			LAB	0 265 006 178 <sup>4</sup>			
							RAB	0 265 006 190 <sup>3</sup>		
								0 265 006 194 <sup>4</sup>		
<b>300 D</b>		06.95-05.99	100/130			LAB	0 265 006 178 <sup>4</sup>			
							RAB	0 265 006 190 <sup>3</sup>		
								0 265 006 188 <sup>3</sup>		
<b>300 D Turbo</b>						LAB	0 265 006 194 <sup>4</sup>			
							RAB	0 265 006 188 <sup>3</sup>		
								0 265 006 194 <sup>4</sup>		
<b>320</b>		06.95-02.97	162			LAB	0 265 006 178 <sup>4</sup>			
							RAB	0 265 006 190 <sup>3</sup>		
								0 265 006 188 <sup>3</sup>		
		03.97-05.99	165			LAB	0 265 006 178 <sup>4</sup>			
							RAB	0 265 006 190 <sup>3</sup>		
								0 265 006 188 <sup>3</sup>		
		07.99-08.03	165			LAB	0 265 006 194 <sup>4</sup>			
							RAB	0 265 006 178 <sup>4</sup>		
								0 265 006 190 <sup>3</sup>		
<b>320 CDI</b>		06.99-03.02	145			LAB	0 265 006 188 <sup>3</sup>			
							RAB	0 265 006 178 <sup>4</sup>		
								0 265 006 190 <sup>3</sup>		
<b>320 4MATIC</b>		09.97-05.99	165			LAB	0 265 006 194 <sup>4</sup>			
							RAB	0 265 006 178 <sup>4</sup>		
								0 265 006 358 <sup>3</sup>		
		07.99-03.02	165			LAB	0 265 006 194 <sup>4</sup>			
							RAB	0 265 006 178 <sup>4</sup>		
								0 265 006 358 <sup>3</sup>		
<b>420</b>		01.96-08.97	205			LAB	0 265 006 190 <sup>3</sup>			
							RAB	0 265 006 178 <sup>4</sup>		
								0 265 006 188 <sup>3</sup>		
<b>430</b>		09.97-05.99	205			LAB	0 265 006 194 <sup>4</sup>			
							RAB	0 265 006 190 <sup>3</sup>		
								0 265 006 188 <sup>3</sup>		
		07.99-03.02	205			LAB	0 265 006 178 <sup>4</sup>			
							RAB	0 265 006 190 <sup>3</sup>		
								0 265 006 188 <sup>3</sup>		
<b>430, 4MATIC</b>		09.97-03.02	205			LAB	0 265 006 194 <sup>4</sup>			
<b>430 4MATIC</b>		06.99-03.02	205			LAB	0 265 006 178 <sup>4</sup>			
							RAB	0 265 006 358 <sup>3</sup>		
								0 265 006 194 <sup>4</sup>		
						RAB	0 265 006 194 <sup>4</sup>			
							0 265 006 356 <sup>3</sup>			



		S							
<b>Serie E [211]</b>									
	<b>200 CDI</b>	07.02-03.09	75/90/100				0 204 204 787	← 60	
							0 986 134 013		
							0 204 204 788	→ 60	
							0 986 135 013		
	<b>200 KOMPRESSOR</b>	03.02-03.06	120		SBJ		0 204 204 787	← 60	
							0 986 134 013		
							0 204 204 788	→ 60	
							0 986 135 013		
		04.06-01.09	135		ATP		0 204 204 787	← 60	
							0 986 134 013		
							0 204 204 788	→ 60	
							0 986 135 013		
	<b>200 KOMPRESSOR NGT</b>	04.04-09.08	120				0 204 204 787	← 60	
							0 986 134 013		
							0 204 204 788	→ 60	
							0 986 135 013		
	<b>220 CDI</b>	03.02-01.09	100/110				0 204 204 787	← 60	
							0 986 134 013		
							0 204 204 788	→ 60	
							0 986 135 013		
		04.06-03.09	120-125		SBJ		0 204 204 787	← 60	
							0 986 134 013		
							0 204 204 788	→ 60	
							0 986 135 013		
	<b>230</b>	09.07-03.09	150				0 204 204 787	← 60	
							0 986 134 013		
							0 204 204 788	→ 60	
							0 986 135 013		
	<b>240</b>	03.02-03.05	130				0 204 204 787	← 60	
							0 986 134 013		
							0 204 204 788	→ 60	
							0 986 135 013		
	<b>240 4MATIC</b>	09.03-03.09	130				0 986 134 073	→	
							0 986 135 073	→	
	<b>270 CDI</b>	03.02-03.05	120-130				0 204 204 787	← 60	
							0 986 134 013		
							0 204 204 788	→ 60	
							0 986 135 013		
	<b>280</b>	04.05-03.09	170		ATP		0 204 204 787	← 60	
							0 986 134 013		
							0 204 204 788	→ 60	
							0 986 135 013		
	<b>280 CDI</b>	04.04-03.05	130		FMS		0 204 204 787	← 60	
							0 986 134 013		
							0 204 204 788	→ 60	
							0 986 135 013		
		04.05-03.09	140		ATP,FMS		0 204 204 787	← 60	
							0 986 134 013		
							0 204 204 788	→ 60	
							0 986 135 013		
	<b>280 CDI 4MATIC</b>	04.05-03.09	140		ATP		0 986 134 073	→	
							0 986 135 073	→	
						Fg.-Nr. X 196565→	ATP	0 986 135 079	← 44
								0 986 134 079	→ 44
	<b>280 4MATIC</b>	04.05-03.09	170		ATP		0 986 134 073	→	
							0 986 135 073	→	
						Fg.-Nr. X 196565→	ATP	0 986 135 079	← 44
								0 986 134 079	→ 44





<b>◀ MERCEDES-BENZ Serie E [211]</b>								
<b>300 BlueTec</b>	12.07-01.09	155			ATP,FMS	0 204 204 787 0 986 134 013	← 60 	
						0 204 204 788 0 986 135 013	→ 60 	
<b>320</b>	03.02-03.05	165	Fg.-Nr. A 400548→			0 204 204 787 0 986 134 013	← 60 	
						0 204 204 788 0 986 135 013	→ 60 	
<b>320 CDI</b>	04.05-03.09	165			ATP,FMS	0 204 204 787 0 986 134 013	← 60 	
						0 204 204 788 0 986 135 013	→ 60 	
<b>320 CDI 4MATIC</b>	04.05-01.09	165			ATP	0 986 134 073 0 986 135 073	→ →	
			Fg.-Nr. X 196565→		ATP	0 986 135 079 0 986 134 079	← 44 → 44	
<b>320 4MATIC</b>	09.03-03.05	165				0 986 134 073 0 986 135 073	→ →	
<b>350 CGI</b>	12.07-03.09	215			ATP	0 204 204 787 0 986 134 013	← 60 	
						0 204 204 788 0 986 135 013	→ 60 	
<b>350 4MATIC</b>	04.05-01.09	200			ATP	0 986 134 073 0 986 135 073	→ →	
			Fg.-Nr. X 196565→		ATP	0 986 135 079 0 986 134 079	← 44 → 44	
<b>500 4MATIC</b>	09.06-01.09	285			ATP	0 986 135 079 0 986 134 079	← 44 → 44	
<hr/>								
<b>200 CDI</b>	03.02-03.09	75/90/100/			TA	0 986 134 086 0 986 135 086	← 42 → 42	
<b>200 KOMPRESSOR</b>		120						
<b>200 KOMPRESSOR NGT</b>					TA	0 986 134 055 0 986 135 055	← 42 → 42	
<b>200 KOMPRESSOR</b>	04.06-01.09	135			ATP,SPT, TA	0 986 134 055 0 986 135 055	← 42 → 42	
					ATP,TA, VSP	0 986 134 086 0 986 135 086	← 42 → 42	
<b>220 CDI</b>	03.02-01.09	100/110			TA	0 986 134 086 0 986 135 086	← 42 → 42	
					TA	0 986 134 055 0 986 135 055	← 42 → 42	
	04.06-03.09	120-125			SBJ	0 986 134 055 0 986 135 055	← 42 → 42	
					SBJ	0 986 134 086 0 986 135 086	← 42 → 42	
<b>230</b>	09.07-03.09	150			TA	0 986 134 086 0 986 135 086	← 42 → 42	
					TA	0 986 134 055 0 986 135 055	← 42 → 42	
<b>240</b>	03.02-03.09	130			TA	0 986 134 086 0 986 135 086	← 42 → 42	
<b>240 4MATIC</b>					TA	0 986 134 055 0 986 135 055	← 42 → 42	
<b>270 CDI</b>	03.02-03.05	120-130			TA	0 986 134 086 0 986 135 086	← 42 → 42	
					TA	0 986 134 055 0 986 135 055	← 42 → 42	
<b>280</b>	04.05-03.09	140/170				0 986 134 055 0 986 135 055	← 42 → 42	
<b>280 CDI</b>						0 986 134 055 0 986 135 055	← 42 → 42	
<b>280 CDI</b>	04.04-03.05	130				0 986 134 055 0 986 135 055	← 42 → 42	



<b>280 CDI 4MATIC</b> <b>280 4MATIC</b>	04.05-03.09	140/170	ATP,SPT	0 986 <b>134 055</b>		← 42			
				0 986 <b>135 055</b>		→ 42			
				ATP,VSP	0 986 <b>134 086</b>		← 42		
					0 986 <b>135 086</b>		→ 42		
<b>300 BlueTec</b>	12.07-01.09	155		0 986 <b>134 055</b>		← 42			
				0 986 <b>135 055</b>		→ 42			
<b>320</b>	03.02-03.05	165	TA	0 986 <b>134 086</b>		← 42			
				0 986 <b>135 086</b>		→ 42			
			TA	0 986 <b>134 055</b>		← 42			
				0 986 <b>135 055</b>		→ 42			
<b>320 CDI</b>	11.02-08.06	150	TA	0 986 <b>134 086</b>		← 42			
				0 986 <b>135 086</b>		→ 42			
			TA	0 986 <b>134 055</b>		← 42			
				0 986 <b>135 055</b>		→ 42			
<b>320 CDI</b> <b>320 CDI 4MATIC</b>	04.05-03.09	165	ATP,SPT	0 986 <b>134 055</b>		← 42			
				0 986 <b>135 055</b>		→ 42			
			ATP,VSP	0 986 <b>134 086</b>		← 42			
				0 986 <b>135 086</b>		→ 42			
<b>320 4MATIC</b>	09.03-03.05	165	TA	0 986 <b>134 086</b>		← 42			
				0 986 <b>135 086</b>		→ 42			
			TA	0 986 <b>134 055</b>		← 42			
				0 986 <b>135 055</b>		→ 42			
<b>350, CGI, 4MATIC</b>	02.05-03.09	200/215		0 986 <b>134 055</b>		← 42			
				0 986 <b>135 055</b>		→ 42			
<b>400 CDI</b>	02.03-04.05	191		0 986 <b>134 055</b>		← 42			
				0 986 <b>135 055</b>		→ 42			
<b>420 CDI</b>	09.05-01.09	231		0 986 <b>134 055</b>		← 42			
				0 986 <b>135 055</b>		→ 42			
<b>500</b>	04.06-03.09	285						1 987 <b>470 506<sup>B</sup></b>	
<b>500</b>	03.02-08.06	225		0 986 <b>134 055</b>		← 42			
<b>500 4MATIC</b>				0 986 <b>135 055</b>		→ 42			
<b>500 4MATIC</b>	09.06-01.09	285		0 986 <b>134 055</b>		← 42			
				0 986 <b>135 055</b>		→ 42			
	<b>55 AMG KOMPRESSOR</b>	10.02-05.06	350		1 987 <b>477 897</b>		↔ 1726		
				LLE	1 987 <b>477 851</b>		1952		
				RLE	1 987 <b>477 898</b>		1433		
	<b>63 AMG</b>	06.06-01.09	378		1 987 <b>477 897</b>		↔ 1726		
LLE				1 987 <b>477 851</b>		1952			
				RLE	1 987 <b>477 898</b>		1433		
	<b>200 CDI</b>	07.02-03.09	75/90/100/120/135		1 987 <b>477 897</b>		↔ 1726		
	<b>200 CDI, KOMPRESSOR, KOMPRESSOR NGT</b>	03.02-03.09	75/90/100/120/135	LLE	1 987 <b>477 851</b>		1952		
				RLE	1 987 <b>477 898</b>		1433		
	<b>200 KOMPRESSOR</b>	03.02-01.09	75/90/100/120/135		1 987 <b>477 897</b>		↔ 1726		
	<b>200 KOMPRESSOR NGT</b>	04.04-09.08	75/90/100/120/135		1 987 <b>477 897</b>		↔ 1726		
	<b>220 CDI</b>	03.02-03.09	100/110/120-125		1 987 <b>477 897</b>		↔ 1726		
				LLE	1 987 <b>477 851</b>		1952		
				RLE	1 987 <b>477 898</b>		1433		
	<b>230</b>	09.07-03.09	150		1 987 <b>477 897</b>		↔ 1726		
				LLE	1 987 <b>477 851</b>		1952		
				RLE	1 987 <b>477 898</b>		1433		
	<b>240</b>	03.02-03.05	130		1 987 <b>477 897</b>		↔ 1726		
	<b>240 4MATIC</b>	03.02-03.09	130	LLE	1 987 <b>477 851</b>		1952		
				RLE	1 987 <b>477 898</b>		1433		
	<b>240 4MATIC</b>	09.03-03.09	130		1 987 <b>477 897</b>		↔ 1726		
	<b>270 CDI</b>	03.02-03.05	120-130		1 987 <b>477 897</b>		↔ 1726		
				LLE	1 987 <b>477 851</b>		1952		
				RLE	1 987 <b>477 898</b>		1433		
	<b>280</b>	04.05-03.09	130/140/170		1 987 <b>477 897</b>		↔ 1726		
	<b>280, CDI, CDI 4MATIC, 4MATIC</b>	04.04-03.09	130/140/170	LLE	1 987 <b>477 851</b>		1952		
				RLE	1 987 <b>477 898</b>		1433		



		S							
<b>◀ MERCEDES-BENZ Serie E [211]</b>									
280 CDI	04.04-03.09	130/140/170					1987 477 897	↔	1726
280 CDI 4MATIC	04.05-03.09	130/140/170					1987 477 897	↔	1726
280 4MATIC	04.05-03.09	130/140/170					1987 477 897	↔	1726
300 BlueTec	12.07-01.09	155					1987 477 897	↔	1726
						LLE	1987 477 851		1952
						RLE	1987 477 898		1433
320	03.02-03.05	150/165					1987 477 897	↔	1726
320, CDI, CDI 4MATIC, 4MATIC	03.02-03.09	150/165				LLE	1987 477 851		1952
						RLE	1987 477 898		1433
320 CDI	11.02-03.09	150/165					1987 477 897	↔	1726
320 CDI 4MATIC	04.05-01.09	150/165					1987 477 897	↔	1726
320 4MATIC	09.03-03.05	150/165					1987 477 897	↔	1726
350	02.05-03.09	200/215					1987 477 897	↔	1726
350, CGI, 4MATIC	02.05-03.09	200/215				LLE	1987 477 851		1952
						RLE	1987 477 898		1433
350 CGI	12.07-03.09	200/215					1987 477 897	↔	1726
350 4MATIC	04.05-01.09	200/215					1987 477 897	↔	1726
400 CDI	02.03-04.05	191					1987 477 897	↔	1726
						LLE	1987 477 851		1952
						RLE	1987 477 898		1433
420 CDI	09.05-01.09	231					1987 477 897	↔	1726
						LLE	1987 477 851		1952
						RLE	1987 477 898		1433
500	03.02-03.09	225/285					1987 477 897	↔	1726
500	03.02-03.09	225/285				LLE	1987 477 851		1952
500 4MATIC						RLE	1987 477 898		1433
500 4MATIC	09.03-01.09	225/285					1987 477 897	↔	1726
55 AMG KOMPRESSOR	10.02-05.06	350					0 265 007 500 <sup>4</sup>		
							0 265 008 097 <sup>3</sup>		
63 AMG	06.06-01.09	378					0 265 008 097 <sup>3</sup>		
							0 986 594 563 <sup>4</sup>		
200 CDI	07.02-12.06	75/90					0 265 007 500 <sup>4</sup>		
							0 265 008 097 <sup>3</sup>		
	04.06-03.09	100					0 265 008 097 <sup>3</sup>		
							0 986 594 563 <sup>4</sup>		
200 KOMPRESSOR	03.02-03.06	120					0 986 594 563 <sup>4</sup>		
	04.06-01.09	135					0 265 008 097 <sup>3</sup>		
							0 986 594 563 <sup>4</sup>		
200 KOMPRESSOR NGT	04.04-09.08	120					0 265 007 500 <sup>4</sup>		
200 KOMPRESSOR, KOMPRESSOR NGT	03.02-09.08	120					0 265 008 097 <sup>3</sup>		
220 CDI	03.02-01.09	100/110					0 265 007 500 <sup>4</sup>		
							0 265 008 097 <sup>3</sup>		
	04.06-03.09	120-125					0 265 008 097 <sup>3</sup>		
							0 986 594 563 <sup>4</sup>		
230	09.07-03.09	150					0 265 008 097 <sup>3</sup>		
							0 986 594 563 <sup>4</sup>		
240	03.02-03.05	130					0 265 008 097 <sup>3</sup>		
							0 986 594 563 <sup>4</sup>		
240 4MATIC	09.03-03.09	130					0 265 007 500 <sup>4</sup>		
270 CDI	03.02-03.05	120-130					0 265 007 500 <sup>4</sup>		
							0 265 008 097 <sup>3</sup>		
280, CDI, CDI 4MATIC, 4MATIC	04.04-03.09	130/140/170					0 265 008 097 <sup>3</sup>		
							0 986 594 563 <sup>4</sup>		
300 BlueTec	12.07-01.09	155					0 265 008 097 <sup>3</sup>		
							0 986 594 563 <sup>4</sup>		
320, CDI, CDI 4MATIC	03.02-03.09	165					0 265 008 097 <sup>3</sup>		
							0 986 594 563 <sup>4</sup>		
320 CDI	11.02-08.06	150					0 265 007 500 <sup>4</sup>		
							0 265 008 097 <sup>3</sup>		
320 4MATIC	09.03-03.05	165					0 265 007 500 <sup>4</sup>		
350, CGI, 4MATIC	02.05-03.09	200/215					0 265 008 097 <sup>3</sup>		
							0 986 594 563 <sup>4</sup>		

		S							
400 CDI		02.03-04.05	191				0 265 007 500 <sup>4</sup>		
							0 265 008 097 <sup>3</sup>		
420 CDI		09.05-01.09	231				0 265 008 097 <sup>3</sup>		
							0 986 594 563 <sup>4</sup>		
500		03.02-03.06	225				0 265 008 097 <sup>3</sup>		
		04.06-03.09	285				0 986 594 563 <sup>4</sup>		
							0 265 008 097 <sup>3</sup>		
							0 986 594 563 <sup>4</sup>		
500 4MATIC		09.03-08.06	225				0 265 007 500 <sup>4</sup>		
		09.06-01.09	285				0 986 594 563 <sup>4</sup>		

**Serie E [212]**

	180	12.12→	115						1 987 470 506 <sup>B</sup>
	200	08.12→	135						1 987 470 506 <sup>B</sup>
	200 BlueTec, CDI, NGT	04.09→	100/115/120						1 987 470 506 <sup>B</sup>
	200 CGI	04.09-12.13	135			FKR			1 987 470 506 <sup>B</sup>
						FLR			1 987 470 506 <sup>B</sup>
	220 BlueTec, BlueTec 4MATIC, CDI	12.08→	120-130						1 987 470 506 <sup>B</sup>
	250	05.09-12.11	150						1 987 470 506 <sup>B</sup>
		08.12→	155						1 987 470 506 <sup>B</sup>
	250 BlueTec	07.14→	150						1 987 470 506 <sup>B</sup>
	250 BlueTec 4MATIC	07.14→	150			NOR			1 987 470 506 <sup>B</sup>
						SBE			1 987 470 506 <sup>B</sup>
	250 CDI	12.08-02.09	150	Fg.-Nr. →A 007598, Komp.Nr. 1U9					1 987 470 506 <sup>B</sup>
		12.08→	150	Komp.Nr. 1U9					1 987 470 506 <sup>B</sup>
		03.09→	150	Fg.-Nr. A 007599→, Komp.Nr. 1U9					1 987 470 506 <sup>B</sup>
	250 CDI 4MATIC	01.11→	150			NOR			1 987 470 506 <sup>B</sup>
						SBE			1 987 470 506 <sup>B</sup>
	250 CGI	04.09-12.13	150			FKR			1 987 470 506 <sup>B</sup>
						FLR			1 987 470 506 <sup>B</sup>
	300, BlueTec, BlueTec Hybrid, CDI, L, 4MATIC	04.09→	150/170/ 185						1 987 470 506 <sup>B</sup>
	350, BlueTec, BlueTec 4MATIC, CDI, CDI 4MATIC, CGI, 4MATIC	08.08→	155/170/185-190/ 195/200/215/225						1 987 470 506 <sup>B</sup>
	400, 4MATIC	01.13→	245						1 987 470 506 <sup>B</sup>
	500, 4MATIC	01.09→	285/300						1 987 470 506 <sup>B</sup>

	63 AMG	04.09→	386/410/430				1 987 482 329	↔ 743	
	63 AMG S	11.12→	386/410/430				1 987 482 329	↔ 743	
	63 AMG S 4MATIC	11.12→	386/410/430				1 987 482 329	↔ 743	
	63 AMG 4MATIC	08.12→	386/410/430				1 987 482 329	↔ 743	
	180	12.12→	115				1 987 482 329	↔ 743	
	200	08.12→	100/115/120/135				1 987 482 329	↔ 743	
	200 BlueTec	07.14→	100/115/120/135				1 987 482 329	↔ 743	
	200 CDI	04.09→	100/115/120/135				1 987 482 329	↔ 743	
	200 CGI	04.09-12.13	100/115/120/135				1 987 482 329	↔ 743	
	200 NGT	01.11-04.13	100/115/120/135				1 987 482 329	↔ 743	
		07.13→	100/115/120/135				1 987 482 329	↔ 743	
	220 BlueTec	06.13→	120-130				1 987 482 329	↔ 743	
	220 BlueTec 4MATIC	01.15→	120-130				1 987 482 329	↔ 743	
	220 CDI	12.08→	120-130				1 987 482 329	↔ 743	
	250	05.09-12.11	150/155				1 987 482 329	↔ 743	
		08.12→	150/155				1 987 482 329	↔ 743	
	250 BlueTec	07.14→	150/155				1 987 482 329	↔ 743	
	250 BlueTec 4MATIC	07.14→	150/155				1 987 482 329	↔ 743	
	250 CDI	12.08→	150/155				1 987 482 329	↔ 743	
	250 CDI 4MATIC	01.11→	150/155				1 987 482 329	↔ 743	



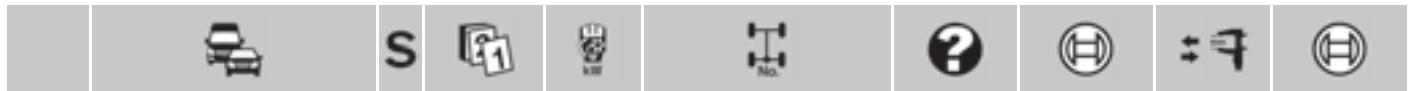















**MERCEDES-BENZ Serie E [212]**

250 CGI	04.09-12.13	150/155			1987 482 329	↔ 743
300	07.11→	150/170/185			1987 482 329	↔ 743
300 BlueTec	08.12→	150/170/185			1987 482 329	↔ 743
300 BlueTec Hybrid	04.12→	150/170/185			1987 482 329	↔ 743
300 CDI	12.09-12.13	150/170/185			1987 482 329	↔ 743
300 L	04.09→	150/170/185			1987 482 329	↔ 743
300 4MATIC	07.11-12.13	150/170/185			1987 482 329	↔ 743
350	04.09-07.11	155/170/185-190/195/200/215/225			1987 482 329	↔ 743
	09.11→	155/170/185-190/195/200/215/225			1987 482 329	↔ 743
350 BlueTec	04.09→	155/170/185-190/195/200/215/225			1987 482 329	↔ 743
350 BlueTec 4MATIC	08.12→	155/170/185-190/195/200/215/225			1987 482 329	↔ 743
350 CDI	08.08-12.13	155/170/185-190/195/200/215/225			1987 482 329	↔ 743
350 CDI 4MATIC	04.09→	155/170/185-190/195/200/215/225			1987 482 329	↔ 743
350 CGI	04.09-12.11	155/170/185-190/195/200/215/225			1987 482 329	↔ 743
350 4MATIC	01.09→	155/170/185-190/195/200/215/225			1987 482 329	↔ 743
400	01.13→	245			1987 482 329	↔ 743
400 4MATIC	01.13→	245			1987 482 329	↔ 743
500	04.09→	285/300			1987 482 329	↔ 743
500 4MATIC	01.09→	285/300			1987 482 329	↔ 743

	63 AMG	04.09-04.11	386		LAB	0 265 008 135 <sup>3</sup>	
		02.11-04.13	386	Mod.Jahr →2012	LAB	0 265 008 135 <sup>3</sup>	
		04.11→	410	Mod.Jahr →2012	LAB	0 265 008 135 <sup>3</sup>	
	200 CDI	04.09→	100	Mod.Jahr →2012	LAB	0 265 008 135 <sup>3</sup>	
	200 CGI	04.09-12.13	135	Mod.Jahr →2012	FKR,LAB	0 265 008 135 <sup>3</sup>	
	200 NGT	01.11-04.13	120		LAB	0 265 008 135 <sup>3</sup>	
	220 CDI	12.08→	120-125	Mod.Jahr →2012	LAB	0 265 008 135 <sup>3</sup>	
	250	05.09-12.11	150		LAB	0 265 008 135 <sup>3</sup>	
	250 CDI	12.08→	150	Mod.Jahr →2012	LAB	0 265 008 135 <sup>3</sup>	
	250 CGI	04.09-12.13	150		LAB	0 265 008 135 <sup>3</sup>	
	300	07.11→	185	Mod.Jahr →2012	LAB	0 265 008 135 <sup>3</sup>	
	300 CDI	12.09-12.10	150		LAB	0 265 008 135 <sup>3</sup>	
		07.10-12.13	170	Mod.Jahr →2012	LAB	0 265 008 135 <sup>3</sup>	
	300 L	04.09→	170		LAB	0 265 008 135 <sup>3</sup>	
	350	09.11→	225	Mod.Jahr →2012	LAB	0 265 008 135 <sup>3</sup>	
	350, CGI	04.09-12.11	200/215		LAB	0 265 008 135 <sup>3</sup>	
	350 BlueTec	04.09-12.13	155	Mod.Jahr →2012	LAB	0 265 008 135 <sup>3</sup>	
	350 CDI	08.08-11.10	170		LAB	0 265 008 135 <sup>3</sup>	
		12.10-12.13	195	Mod.Jahr →2012	LAB	0 265 008 135 <sup>3</sup>	
	500	04.09-08.11	285		LAB	0 265 008 135 <sup>3</sup>	
		09.11→	300	Mod.Jahr →2012	LAB	0 265 008 135 <sup>3</sup>	

**Serie G [461]**

	230	10.89-09.95	79/92			0 986 473 981	↔ 44
	230 E					0 986 473 982	↔ 44
	240 D	04.92-11.97	53			0 986 473 981	↔ 44
						0 986 473 982	↔ 44
	250 D	04.92-09.97	69		ATE	0 986 471 979	↔ 44
						0 986 473 979	↔ 44
						0 986 471 980	↔ 44
						0 986 473 980	↔ 44
	280 E	04.92-07.97	110			0 986 473 981	↔ 44
						0 986 473 982	↔ 44
	300 D	04.92-07.97	65			0 986 473 981	↔ 44
						0 986 473 982	↔ 44
	230	04.92-09.95	79		ATE	0 986 475 033	↔ 17,46
						0 986 475 044	↔ 22,22

		S											
230 E		10.89-09.95	92			ATE	0 986 475 033	↔ 17,46					
							0 986 475 044	↔ 22,22					
							0 986 475 033	↔ 17,46					
							0 986 475 044	↔ 22,22					
240 D		04.92-09.95	92			ATE	0 986 475 033	↔ 17,46					
							0 986 475 044	↔ 22,22					
250 D		04.93-09.95	90			ATE	0 986 475 033	↔ 17,46					
							0 986 475 044	↔ 22,22					
280 E		04.92-09.97	110			ATE	0 986 475 033	↔ 17,46					
							0 986 475 044	↔ 22,22					
290 D		04.92-09.97	69/70/72			ATE	0 986 475 033	↔ 17,46					
							0 986 475 044	↔ 22,22					
290 DT		04.97-09.01	90			ATE	0 986 475 033	↔ 17,46					
							0 986 475 044	↔ 22,22					
							0 986 475 033	↔ 17,46					
300 D		04.92-07.97	53/64/65			ATE	0 986 475 033	↔ 17,46					
							0 986 475 044	↔ 22,22					
	280 CDI	04.09→	135				0 204 102 910	← 48					
							0 204 102 911	→ 48					
							0 204 102 910	← 48					
							0 204 102 911	→ 48					
							0 204 102 910	← 48					
290 DT		04.97-09.01	90				0 204 102 911	→ 48					
							0 204 102 910	← 48					
300 CDI		09.09→	135				0 204 102 910	← 48					
							0 204 102 911	→ 48					
	280 CDI	04.09→	135	Komp.Nr. 504028 02			1 987 482 499	→ 2374					
							1 987 482 500	← 2230					
	280 CDI	04.09→	135			TW	0 265 002 262 <sup>3</sup>						
							290 DT	04.97-09.01	90		0 265 002 262 <sup>3</sup>		
<b>Serie G [463]</b>													
	55 AMG KOMPRESSOR	04.04-08.11	350-373	Vordera. 730.331, Komp.Nr. 504025 46			0 986 135 079	↔ 44					
							0 986 134 079	↔ 44					
	63 AMG	04.12-05.15	400	Komp.Nr. 504025 46				0 986 135 079	↔ 44				
								0 986 134 079	↔ 44				
	65 AMG	04.12-05.15	450	Komp.Nr. 504025 46				0 986 135 079	↔ 44				
								0 986 134 079	↔ 44				
								0 204 204 787	← 60				
								0 986 134 013	↔ 60				
	230	06.90-06.95	93	Fg.-Nr. 741.516K015604→			0 986 475 033	↔ 17,46					
							300	09.89-07.97	83/125/	Fg.-Nr. 741.516K015604→	0 986 475 033	↔ 17,46	
							300 D		126				
							300 D Turbo	09.96-11.00	130		0 986 475 033	↔ 17,46	
320	08.93-11.97	155	Fg.-Nr. 741.516K015604→		0 986 475 033	↔ 17,46							
350 D Turbo	09.93-06.96	100	Fg.-Nr. 741.516K015604→		0 986 475 033	↔ 17,46							
500	04.98-09.05	218	Hintera. 741.506				0 986 475 033	↔ 17,46					
							Hintera. 741.524	0 986 475 044	↔ 22,22				
500 AMG E	06.98-09.05	218					0 986 475 044	↔ 22,22					
							03.93-09.01	195	Fg.-Nr. 741.516K015604→	0 986 475 033	↔ 17,46		
	55 AMG KOMPRESSOR	04.04-08.11	350-373	Hintera. 742.606					1 987 470 506 <sup>3</sup>				



		S							
	◀ MERCEDES-BENZ Serie G [463]								
<b>63 AMG</b>	04.12-05.15	400	Komp.Nr. 504025 47						1 987 470 506 <sup>8</sup>
			Komp.Nr. 504025 94						1 987 470 506 <sup>8</sup>
<b>65 AMG</b>	04.12-05.15	450	Komp.Nr. 504025 94						1 987 470 506 <sup>8</sup>
<b>270 CDI</b>	10.01-08.06	115					0 204 102 910	← 48	
							0 204 102 911	→ 48	
<b>300 D Turbo</b>	09.96-11.00	130					0 204 102 910	← 48	
							0 204 102 911	→ 48	
<b>320</b>	06.97-08.06	154/158					0 204 102 910	← 48	
							0 204 102 911	→ 48	
<b>350 BlueTec</b>	07.10→	155-165					0 204 102 910	← 48	
							0 204 102 911	→ 48	
<b>400 CDI</b>	12.00-08.06	184					0 204 102 910	← 48	
							0 204 102 911	→ 48	
<b>500</b>	04.98→	218/285					0 204 102 910	← 48	
							0 204 102 911	→ 48	
	<b>55 AMG</b>	04.99-08.11	260/				1 987 482 499	→ 2374	
	<b>55 AMG KOMPRESSOR</b>		350-373				1 987 482 500	← 2230	
	<b>63 AMG</b>	04.12-05.15	400				1 987 482 499	→ 2374	
							1 987 482 500	← 2230	
	<b>65 AMG</b>	04.12-05.15	450				1 987 482 499	→ 2374	
							1 987 482 500	← 2230	
	<b>270 CDI</b>	10.01-08.06	115				1 987 482 499	→ 2374	
							1 987 482 500	← 2230	
	<b>320</b>	06.97-11.97	154				1 987 482 499	→ 2374	
							1 987 482 500	← 2230	
	<b>320 CDI</b>	09.06-12.09	165	Komp.Nr. 504028 02			1 987 482 499	→ 2374	
							1 987 482 500	← 2230	
	<b>350 BlueTec</b>	07.10→	155-165	Komp.Nr. 504028 02			1 987 482 499	→ 2374	
							1 987 482 500	← 2230	
	<b>400 CDI</b>	12.00-08.06	184				1 987 482 499	→ 2374	
							1 987 482 500	← 2230	
	<b>500</b>	06.98-09.05	218		4SB		1 987 482 499	→ 2374	
							1 987 482 500	← 2230	
		09.01-08.08	218				1 987 482 499	→ 2374	
							1 987 482 500	← 2230	
		06.08→	285	Komp.Nr. 504028 02			1 987 482 499	→ 2374	
							1 987 482 500	← 2230	
	<b>55 AMG</b>	04.99-03.04	260				0 265 002 262 <sup>3</sup>		
	<b>55 AMG KOMPRESSOR</b>	04.04-12.08	350-373	Fg.-Nr. →X 179465			0 265 002 262 <sup>3</sup>		
	<b>230</b>	06.90-06.95	93				0 265 002 262 <sup>3</sup>		
				Fg.-Nr. →082464	LAB		0 265 001 292 <sup>4</sup>		
					RAB		0 265 001 290 <sup>4</sup>		
	<b>270 CDI</b>	10.01-08.06	115				0 265 002 262 <sup>3</sup>		
	<b>300</b>	08.93-10.94	126				0 265 002 262 <sup>3</sup>		
		09.93-10.94	125				0 265 002 262 <sup>3</sup>		
				Fg.-Nr. →082464	LAB		0 265 001 292 <sup>4</sup>		
					RAB		0 265 001 290 <sup>4</sup>		
	<b>300 D</b>	09.89-07.97	83				0 265 002 262 <sup>3</sup>		
	<b>300 D Turbo</b>	09.96-11.00	130				0 265 002 262 <sup>3</sup>		
	<b>320</b>	08.93-08.06	154/155/158				0 265 002 262 <sup>3</sup>		
	<b>350 D Turbo</b>	09.93-06.96	100				0 265 002 262 <sup>3</sup>		
	<b>400 CDI</b>	12.00-08.06	184				0 265 002 262 <sup>3</sup>		
	<b>500</b>	04.98-08.08	218				0 265 002 262 <sup>3</sup>		
	<b>500 AMG E</b>	03.93-09.01	195				0 265 002 262 <sup>3</sup>		
				Fg.-Nr. →082464	LAB		0 265 001 292 <sup>4</sup>		
					RAB		0 265 001 290 <sup>4</sup>		



**Serie GL [164]**

		<b>320</b> CDI BlueTec 4MATIC, CDI 4MATIC	02.06-08.09	155/165			1 987 470 506 <sup>B</sup>
		<b>350</b> BlueTec 4MATIC, CDI 4MATIC	04.09-12.12	155/195			1 987 470 506 <sup>B</sup>
		<b>420</b> CDI 4MATIC	02.06-04.09	225			1 987 470 506 <sup>B</sup>
		<b>450</b> CDI 4MATIC, 4MATIC	02.06-12.12	225/250			1 987 470 506 <sup>B</sup>
		<b>500</b> 4MATIC	02.06-12.12	285			1 987 470 506 <sup>B</sup>
		<b>320</b> CDI BlueTec 4MATIC	09.08-08.09	155/165		1 987 482 024	↔ 817
		<b>320</b> CDI 4MATIC	02.06-04.09	155/165		1 987 482 024	↔ 817
		<b>350</b> BlueTec 4MATIC	04.09-12.12	155/165/195		1 987 482 024	↔ 817
		<b>350</b> CDI 4MATIC	05.09-12.12	155/165/195		1 987 482 024	↔ 817
		<b>420</b> CDI 4MATIC	02.06-04.09	225		1 987 482 024	↔ 817
		<b>450</b> CDI 4MATIC	05.09-12.12	225/250		1 987 482 024	↔ 817
		<b>450</b> 4MATIC	02.06-12.12	225/250		1 987 482 024	↔ 817
		<b>500</b> 4MATIC	02.06-12.12	285		1 987 482 024	↔ 817

**Serie GLK [204]**

		<b>200</b> , CDI	07.10→	100-105/135			1 987 470 506 <sup>B</sup>
		<b>220</b> BlueTec 4MATIC, CDI, CDI 4MATIC	06.08→	120-125			1 987 470 506 <sup>B</sup>
		<b>250</b> , BlueTec 4MATIC, CDI 4MATIC, 4MATIC	04.09→	150/155			1 987 470 506 <sup>B</sup>
		<b>280</b> 4MATIC	09.08-04.09	170			1 987 470 506 <sup>B</sup>
		<b>300</b> 4MATIC	05.09-12.13	170/183			1 987 470 506 <sup>B</sup>
		<b>320</b> CDI 4MATIC	09.08-04.09	165			1 987 470 506 <sup>B</sup>
		<b>350</b> , CDI 4MATIC, CGI 4MATIC, 4MATIC	09.08→	165/170/195/200/225			1 987 470 506 <sup>B</sup>
		<b>200</b> , CDI	07.10→	100-105/135		0 986 594 547 <sup>4</sup>	
		<b>220</b> BlueTec 4MATIC, CDI, CDI 4MATIC	06.08→	120-125		0 986 594 547 <sup>4</sup>	
		<b>250</b> , BlueTec 4MATIC, CDI 4MATIC, 4MATIC	04.09→	150/155		0 986 594 547 <sup>4</sup>	
		<b>280</b> 4MATIC	09.08-04.09	170		0 986 594 547 <sup>4</sup>	
		<b>300</b> 4MATIC	05.09-12.13	170/183		0 986 594 547 <sup>4</sup>	
		<b>320</b> CDI 4MATIC	09.08-04.09	165		0 986 594 547 <sup>4</sup>	
		<b>350</b> , CDI 4MATIC, CGI 4MATIC, 4MATIC	09.08→	165/170/195/200/225		0 986 594 547 <sup>4</sup>	

**Serie ML [163]**

		<b>55 AMG</b>	03.00-06.05	255	Fg.-Nr. →A 343160	0 986 134 045	↔ ← 40
						0 986 135 045	↔ → 40
					Fg.-Nr. A 343161→	0 986 134 045	↔ ← 40
						0 986 135 045	↔ → 40
		<b>230</b>	ABS 03.98-06.00	110		0 986 473 221	↔ ←
						0 986 474 221	↔ →
		<b>270</b> CDI	11.99-06.05	120	Fg.-Nr. →A 289559	0 986 473 221	↔ ←
						0 986 474 221	↔ →
					Fg.-Nr. A 289560→A 343160	0 986 134 045	↔ ← 40
						0 986 135 045	↔ → 40
					Fg.-Nr. A 343161→	0 986 134 045	↔ ← 40
						0 986 135 045	↔ → 40
		<b>320</b>	03.98-09.02	160	Fg.-Nr. →A 289559	0 986 473 221	↔ ←
						0 986 474 221	↔ →
					Fg.-Nr. A 289560→A 343160	0 986 134 045	↔ ← 40
						0 986 135 045	↔ → 40







	◀ MERCEDES-BENZ Serie ML [163]						
<b>320</b>	03.98-09.02	160	Fg.-Nr. A 343161→	0986 <b>134 045</b>		← 40	
				0986 <b>135 045</b>		→ 40	
<b>350</b>	08.02-06.05	173/180		0986 <b>134 045</b>		← 40	
				0986 <b>135 045</b>		→ 40	
<b>400 CDI</b>	09.01-06.05	184	Fg.-Nr. →A 343160	0986 <b>134 045</b>		← 40	
			Fg.-Nr. A 343161→	0986 <b>135 045</b>		→ 40	
				0986 <b>134 045</b>		← 40	
				0986 <b>135 045</b>		→ 40	
<b>430</b>	09.98-07.02	200		0986 <b>134 045</b>		← 40	
				0986 <b>135 045</b>		→ 40	
<b>500</b>	09.01-06.05	215	Fg.-Nr. →A 343160	0986 <b>134 045</b>		← 40	
			Fg.-Nr. A 343161→	0986 <b>135 045</b>		→ 40	

	<b>55 AMG</b>	03.00-06.05	255		1987 <b>477 903</b>	← 2025	
					1987 <b>477 904</b>	→ 1932	
				LLE	1987 <b>477 902</b>	1780	
				RLE	1987 <b>477 905</b>	1445	
<b>230</b>	03.98-06.00	110		1987 <b>477 903</b>	← 2025		
				1987 <b>477 904</b>	→ 1932		
				LLE	1987 <b>477 902</b>	1780	
				RLE	1987 <b>477 905</b>	1445	
<b>270 CDI</b>	11.99-06.05	120		1987 <b>477 903</b>	← 2025		
				1987 <b>477 904</b>	→ 1932		
				LLE	1987 <b>477 902</b>	1780	
				RLE	1987 <b>477 905</b>	1445	
<b>320</b>	03.98-09.02	160		1987 <b>477 903</b>	← 2025		
				1987 <b>477 904</b>	→ 1932		
				LLE	1987 <b>477 902</b>	1780	
				RLE	1987 <b>477 905</b>	1445	
<b>350</b>	08.02-06.05	173/180		1987 <b>477 903</b>	← 2025		
				1987 <b>477 904</b>	→ 1932		
				LLE	1987 <b>477 902</b>	1780	
				RLE	1987 <b>477 905</b>	1445	
<b>400 CDI</b>	09.01-06.05	184		1987 <b>477 903</b>	← 2025		
				1987 <b>477 904</b>	→ 1932		
				LLE	1987 <b>477 902</b>	1780	
				RLE	1987 <b>477 905</b>	1445	
<b>430</b>	09.98-07.02	200		1987 <b>477 903</b>	← 2025		
				1987 <b>477 904</b>	→ 1932		
				LLE	1987 <b>477 902</b>	1780	
				RLE	1987 <b>477 905</b>	1445	
<b>500</b>	09.01-06.05	215		1987 <b>477 903</b>	← 2025		
				1987 <b>477 904</b>	→ 1932		
				LLE	1987 <b>477 902</b>	1780	
				RLE	1987 <b>477 905</b>	1445	

**Serie ML [164]**

	<b>320 CDI 4MATIC</b>	03.05-04.09	165		0986 <b>135 079</b>		← 44	
					0986 <b>134 079</b>		→ 44	
	<b>63 AMG</b>	02.06-11.10	375					1987 <b>470 506<sup>8</sup></b>
	<b>280 CDI 4MATIC</b>	07.05-04.09	140	INB				1987 <b>470 506<sup>8</sup></b>
				INB				1987 <b>470 506<sup>8</sup></b>
	<b>300 CDI 4MATIC</b>	05.09-07.11	140/150	INB				1987 <b>470 506<sup>8</sup></b>
				INB				1987 <b>470 506<sup>8</sup></b>

		S							
350 BlueTec 4MATIC		05.09-07.11	155/165			B17			1 987 470 506 <sup>B</sup>
350 CDI 4MATIC						B18			1 987 470 506 <sup>B</sup>
350 CDI 4MATIC		09.05-08.11	170/200			INB			1 987 470 506 <sup>B</sup>
350 4MATIC						INB			1 987 470 506 <sup>B</sup>
420 CDI 4MATIC		02.06-04.09	225						1 987 470 506 <sup>B</sup>
450 CDI 4MATIC		05.09-01.11	225						1 987 470 506 <sup>B</sup>
500 4MATIC		09.05-07.11	225/285						1 987 470 506 <sup>B</sup>

	<b>63 AMG</b>	02.06-11.10	375				1 987 482 024	↔ 817	
	280 CDI 4MATIC	07.05-04.09	140				1 987 482 024	↔ 817	
	300 CDI 4MATIC	05.09-07.11	140/150				1 987 482 024	↔ 817	
	320 CDI 4MATIC	03.05-04.09	165				1 987 482 024	↔ 817	
	350 BlueTec 4MATIC	05.09-07.11	155/165/170/200				1 987 482 024	↔ 817	
	350 CDI 4MATIC	05.09-08.11	155/165/170/200				1 987 482 024	↔ 817	
	350 4MATIC	09.05-06.11	155/165/170/200				1 987 482 024	↔ 817	
	420 CDI 4MATIC	02.06-04.09	225				1 987 482 024	↔ 817	
	450 CDI 4MATIC	05.09-01.11	225				1 987 482 024	↔ 817	
	500 4MATIC	09.05-07.11	225/285				1 987 482 024	↔ 817	

**Serie R [251]**

	<b>63 AMG 4MATIC</b>	04.06-08.07	375						1 987 470 506 <sup>B</sup>
	<b>280</b>	05.07-04.09	170			INB			1 987 470 506 <sup>B</sup>
						INB			1 987 470 506 <sup>B</sup>
	280 CDI	04.06-04.09	140			INB			1 987 470 506 <sup>B</sup>
	280 CDI 4MATIC					INB			1 987 470 506 <sup>B</sup>
	280 4MATIC	07.09-12.11	170			INB			1 987 470 506 <sup>B</sup>
						INB			1 987 470 506 <sup>B</sup>
	<b>300</b>	05.09-09.11	170			INB			1 987 470 506 <sup>B</sup>
						INB			1 987 470 506 <sup>B</sup>
	300 CDI	05.09-05.10	140			INB			1 987 470 506 <sup>B</sup>
		05.10-10.12	140			INB			1 987 470 506 <sup>B</sup>
						B17			1 987 470 506 <sup>B</sup>
						B18			1 987 470 506 <sup>B</sup>
	300 CDI 4MATIC	05.09-05.10	140			INB			1 987 470 506 <sup>B</sup>
						INB			1 987 470 506 <sup>B</sup>
	320 CDI 4MATIC	09.05-04.09	165			INB			1 987 470 506 <sup>B</sup>
						INB			1 987 470 506 <sup>B</sup>
		06.07-05.09	165						1 987 470 506 <sup>B</sup>
	<b>350</b>	09.05-10.12	200			INB			1 987 470 506 <sup>B</sup>
	350 4MATIC					INB			1 987 470 506 <sup>B</sup>
	350 BlueTec 4MATIC	05.09-10.12	155						1 987 470 506 <sup>B</sup>
	350 CDI 4MATIC	05.09-05.10	165			INB			1 987 470 506 <sup>B</sup>
						INB			1 987 470 506 <sup>B</sup>
		05.10-10.12	195			B17			1 987 470 506 <sup>B</sup>
						B18			1 987 470 506 <sup>B</sup>
	350 4MATIC	06.11-10.12	225						1 987 470 506 <sup>B</sup>
	500 4MATIC	02.06-10.12	225/285						1 987 470 506 <sup>B</sup>

**Serie S (Coupé) [140]**

	<b>420</b>	03.94-05.96	205-210				0 986 473 748	↔ 40	
							0 986 473 749	↔ 40	
	<b>500</b>	09.93-09.97	235-240				0 986 473 748	↔ 40	
							0 986 473 749	↔ 40	
	<b>600</b>	06.93-05.96	290-300				0 986 473 748	↔ 40	
							0 986 473 749	↔ 40	



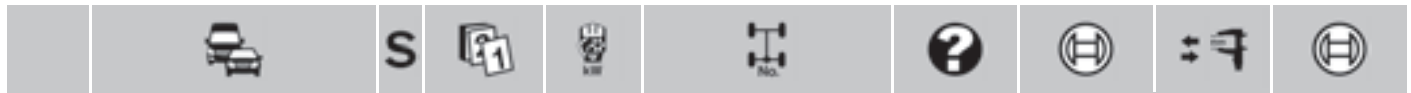

◀ MERCEDES-BENZ Serie S (Coupé) [140]



	420	03.94-05.96	205-210		1 987 477 749	← 1134			
					1 987 477 750	→ 1109			
	500	09.93-09.97	235-240		1 987 477 749	← 1134			
					1 987 477 750	→ 1109			
	600	06.93-05.96	290-300		1 987 477 749	← 1134			
					1 987 477 750	→ 1109			
	420	03.94-05.96	205-210	RLE	0 265 001 348 <sup>3</sup>				
				Fg.-Nr. →A212244	LAB,LLE	0 265 001 406 <sup>3</sup>			
				LLE,RAB	0 265 001 402 <sup>3</sup>				
				Fg.-Nr. →A212244	LAB	0 265 002 218 <sup>4</sup>			
					RAB	0 265 002 216 <sup>4</sup>			
				Fg.-Nr. A 212245→A 290166	LAB,LLE	0 265 001 296 <sup>3</sup>			
					LLE,RAB	0 265 001 350 <sup>3</sup>			
				Fg.-Nr. A 290167→	LAB,LLE	0 265 006 276 <sup>3</sup>			
					LLE,RAB	0 265 006 274 <sup>3</sup>			
				Fg.-Nr. A212245→	LAB	0 265 006 182 <sup>4</sup>			
					RAB	0 265 006 180 <sup>4</sup>			
		500	09.93-09.97	235-240	RLE	0 265 001 348 <sup>3</sup>			
					Fg.-Nr. →A212244	LAB,LLE	0 265 001 406 <sup>3</sup>		
						LLE,RAB	0 265 001 402 <sup>3</sup>		
					Fg.-Nr. A 212245→A 290166	LAB,LLE	0 265 001 296 <sup>3</sup>		
						LLE,RAB	0 265 001 350 <sup>3</sup>		
					Fg.-Nr. A 290167→	LAB,LLE	0 265 006 276 <sup>3</sup>		
						LLE,RAB	0 265 006 274 <sup>3</sup>		
			ASR	09.93-09.97	235-240	Fg.-Nr. →A212244	LAB	0 265 002 218 <sup>4</sup>	
							RAB	0 265 002 216 <sup>4</sup>	
					Fg.-Nr. A212245→	LAB	0 265 006 182 <sup>4</sup>		
						RAB	0 265 006 180 <sup>4</sup>		
		OAS	09.93-09.97	235-240			0 265 002 220 <sup>4</sup>		
	600	06.93-05.96	290-300	RLE	0 265 001 348 <sup>3</sup>				
				Fg.-Nr. →A212244	LAB,LLE	0 265 001 406 <sup>3</sup>			
					LLE,RAB	0 265 001 402 <sup>3</sup>			
				Fg.-Nr. →A212244	LAB	0 265 002 218 <sup>4</sup>			
					RAB	0 265 002 216 <sup>4</sup>			
				Fg.-Nr. A 212245→A 290166	LAB,LLE	0 265 001 296 <sup>3</sup>			
					LLE,RAB	0 265 001 350 <sup>3</sup>			
				Fg.-Nr. A 290167→	LAB,LLE	0 265 006 276 <sup>3</sup>			
					LLE,RAB	0 265 006 274 <sup>3</sup>			
				Fg.-Nr. A212245→	LAB	0 265 006 182 <sup>4</sup>			
					RAB	0 265 006 180 <sup>4</sup>			

Serie S [140]



	280	06.93-09.98	142-145		0 986 473 748	← 40	
					0 986 473 749	→ 40	
	300 D Turbo	06.96-09.98	130		0 986 473 748	← 40	
					0 986 473 749	→ 40	
	320	03.93-02.99	170	Fg.-Nr. →A023718	0 986 473 748	← 40	
					0 986 473 749	→ 40	
					Fg.-Nr. →A050547	0 986 473 748	← 40
						0 986 473 749	→ 40
					Fg.-Nr. A 023719→	0 986 473 748	← 40
						0 986 473 749	→ 40
			Fg.-Nr. A 050548→	0 986 473 748	← 40		
					0 986 473 749	→ 40	
	350 D Turbo	09.93-06.96	100-110		0 986 473 748	← 40	
						0 986 473 749	→ 40

		S							
420		06.93-09.98	205-210				0 986 473 748		40
							0 986 473 749		40
500		06.93-09.98	235-240				0 986 473 748		40
							0 986 473 749		40
600		06.93-09.98	290-300				0 986 473 748		40
							0 986 473 749		40
<hr/>									
	280	06.93-09.98	142-145				0 986 473 967		40
							0 986 473 968		40
	300 D Turbo	06.96-09.98	130				0 986 473 967		40
							0 986 473 968		40
	320	03.93-02.99	170				0 986 473 967		40
							0 986 473 968		40
	350 D Turbo	09.93-06.96	100-110				0 986 473 967		40
							0 986 473 968		40
<hr/>									
	280	06.93-09.98	142-145				1 987 477 749		1134
							1 987 477 750		1109
	300 D Turbo	06.96-09.98	130				1 987 477 749		1134
							1 987 477 750		1109
	320	03.93-02.99	170				1 987 477 749		1134
							1 987 477 750		1109
		05.93-02.99	170		RLE		1 987 477 844		2265
	350 D Turbo	09.93-06.96	100-110				1 987 477 749		1134
							1 987 477 750		1109
	420	06.93-09.98	205-210				1 987 477 749		1134
							1 987 477 750		1109
			210				1 987 477 749		1134
							1 987 477 750		1109
					RLE		1 987 477 844		2265
	500	06.93-09.98	235-240				1 987 477 749		1134
							1 987 477 750		1109
					FLR,RLE		1 987 477 844		2265
	600	06.93-09.98	290-300				1 987 477 749		1134
							1 987 477 750		1109
					FLR,RLE		1 987 477 844		2265
<hr/>									
	280	06.93-09.98	142-145			RLE	0 265 001 348 <sup>3</sup>		
				Fg.-Nr. →A 212244		LAB,LLE	0 265 001 406 <sup>3</sup>		
						LLE,RAB	0 265 001 402 <sup>3</sup>		
				Fg.-Nr. A 212245→A 290166		LAB,LLE	0 265 001 296 <sup>3</sup>		
						LLE,RAB	0 265 001 350 <sup>3</sup>		
				Fg.-Nr. A 290167→		LAB,LLE	0 265 006 276 <sup>3</sup>		
						LLE,RAB	0 265 006 274 <sup>3</sup>		
	ASR	06.93-09.98	142-145	Fg.-Nr. →A212244		LAB	0 265 002 218 <sup>4</sup>		
						RAB	0 265 002 234 <sup>4</sup>		
				Fg.-Nr. A212245→		LAB	0 265 006 182 <sup>4</sup>		
						RAB	0 265 006 180 <sup>4</sup>		
	OAS	06.93-09.98	142-145				0 265 002 220 <sup>4</sup>		
	300 D Turbo	06.96-09.98	130			LAB	0 265 006 182 <sup>4</sup>		
						RAB	0 265 006 180 <sup>4</sup>		
						RLE	0 265 001 348 <sup>3</sup>		
				Fg.-Nr. →A 212244		LAB,LLE	0 265 001 406 <sup>3</sup>		
						LLE,RAB	0 265 001 402 <sup>3</sup>		
				Fg.-Nr. A 212245→A 290166		LAB,LLE	0 265 001 296 <sup>3</sup>		
						LLE,RAB	0 265 001 350 <sup>3</sup>		
				Fg.-Nr. A 290167→		LAB,LLE	0 265 006 276 <sup>3</sup>		
						LLE,RAB	0 265 006 274 <sup>3</sup>		





**MERCEDES-BENZ Serie S [140]**

<b>320</b>	03.93-02.99	170	RLE	0 265 001 348 <sup>3</sup>			
			Fg.-Nr. →A 212244	LAB,LLE	0 265 001 406 <sup>3</sup>		
				LLE,RAB	0 265 001 402 <sup>3</sup>		
			Fg.-Nr. A 212245→A 290166	LAB,LLE	0 265 001 296 <sup>3</sup>		
				LLE,RAB	0 265 001 350 <sup>3</sup>		
			Fg.-Nr. A 290167→	LAB,LLE	0 265 006 276 <sup>3</sup>		
				LLE,RAB	0 265 006 274 <sup>3</sup>		
			ASR	Fg.-Nr. →A212244	LAB	0 265 002 218 <sup>4</sup>	
					RAB	0 265 002 234 <sup>4</sup>	
				Fg.-Nr. A212245→	LAB	0 265 006 182 <sup>4</sup>	
		RAB	0 265 006 180 <sup>4</sup>				
OAS			0 265 002 220 <sup>4</sup>				
<b>350 D Turbo</b>	09.93-06.96	100-110	RLE	0 265 001 348 <sup>3</sup>			
			Fg.-Nr. →A 212244	LAB,LLE	0 265 001 406 <sup>3</sup>		
				LLE,RAB	0 265 001 402 <sup>3</sup>		
			Fg.-Nr. A 212245→A 290166	LAB,LLE	0 265 001 296 <sup>3</sup>		
				LLE,RAB	0 265 001 350 <sup>3</sup>		
			Fg.-Nr. A 290167→	LAB,LLE	0 265 006 276 <sup>3</sup>		
				LLE,RAB	0 265 006 274 <sup>3</sup>		
			ASR		LAB	0 265 006 182 <sup>4</sup>	
					RAB	0 265 006 180 <sup>4</sup>	
			OAS			0 265 002 220 <sup>4</sup>	
			0 265 002 248 <sup>4</sup>				
<b>420</b>	06.93-09.98	205-210	RLE	0 265 001 348 <sup>3</sup>			
			Fg.-Nr. →A 212244	LAB,LLE	0 265 001 406 <sup>3</sup>		
				LLE,RAB	0 265 001 402 <sup>3</sup>		
			Fg.-Nr. A 212245→A 290166	LAB,LLE	0 265 001 296 <sup>3</sup>		
				LLE,RAB	0 265 001 350 <sup>3</sup>		
			Fg.-Nr. A 290167→	LAB,LLE	0 265 006 276 <sup>3</sup>		
				LLE,RAB	0 265 006 274 <sup>3</sup>		
			ASR	Fg.-Nr. →A212244	LAB	0 265 002 218 <sup>4</sup>	
					RAB	0 265 002 234 <sup>4</sup>	
				Fg.-Nr. A212245→	LAB	0 265 006 182 <sup>4</sup>	
		RAB	0 265 006 180 <sup>4</sup>				
OAS			0 265 002 220 <sup>4</sup>				
<b>500</b>	06.93-09.98	235-240	RLE	0 265 001 348 <sup>3</sup>			
			Fg.-Nr. →A 212244	LAB,LLE	0 265 001 406 <sup>3</sup>		
				LLE,RAB	0 265 001 402 <sup>3</sup>		
			Fg.-Nr. A 212245→A 290166	LAB,LLE	0 265 001 296 <sup>3</sup>		
				LLE,RAB	0 265 001 350 <sup>3</sup>		
			Fg.-Nr. A 290167→	LAB,LLE	0 265 006 276 <sup>3</sup>		
	LLE,RAB	0 265 006 274 <sup>3</sup>					
<b>600</b>	06.93-09.98	290-300	RLE	0 265 001 348 <sup>3</sup>			
			Fg.-Nr. →A 212244	LAB,LLE	0 265 001 406 <sup>3</sup>		
				LLE,RAB	0 265 001 402 <sup>3</sup>		
			Fg.-Nr. A 212245→A 290166	LAB,LLE	0 265 001 296 <sup>3</sup>		
				LLE,RAB	0 265 001 350 <sup>3</sup>		
			Fg.-Nr. A 290167→	LAB,LLE	0 265 006 276 <sup>3</sup>		
				LLE,RAB	0 265 006 274 <sup>3</sup>		
			ASR	Fg.-Nr. →A212244	LAB	0 265 002 218 <sup>4</sup>	
					RAB	0 265 002 216 <sup>4</sup>	
				Fg.-Nr. A212245→	LAB	0 265 006 182 <sup>4</sup>	
		RAB	0 265 006 180 <sup>4</sup>				
OAS			0 265 002 220 <sup>4</sup>				

**Serie S [220]**



	<b>350 4MATIC</b>	06.03-08.05	180	0 986 134 073		→
				0 986 135 073		→

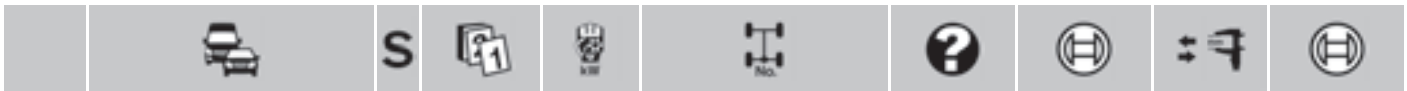

	<b>55 AMG</b>	09.00-08.05	265/368	LLE	1 987 477 901	2760		
	<b>55 AMG KOMPRESSOR</b>	09.00-08.06	265/368		1 987 477 899	← 992		
					1 987 477 900	→ 978		
	<b>280</b>	01.99-08.02	150	LLE	1 987 477 901	2760		
		01.99-08.05	150		1 987 477 899	← 992		
					1 987 477 900	→ 978		
	<b>320</b>	10.98-08.05	145/150/		1 987 477 899	← 992		
	<b>320 CDI</b>		165		1 987 477 900	→ 978		
				LLE	1 987 477 901	2760		
	<b>350</b>	09.02-08.06	180		1 987 477 899	← 992		
	<b>350 4MATIC</b>				1 987 477 900	→ 978		
				LLE	1 987 477 901	2760		
	<b>400 CDI</b>	06.99-08.05	184/191		1 987 477 899	← 992		
					1 987 477 900	→ 978		
				LLE	1 987 477 901	2760		
	<b>430</b>	10.98-01.06	205		1 987 477 899	← 992		
	<b>430 4MATIC</b>				1 987 477 900	→ 978		
				LLE	1 987 477 901	2760		
	<b>500</b>	10.98-09.05	225	FMS	1 987 477 899	← 992		
					1 987 477 900	→ 978		
		10.98-08.06	225		1 987 477 899	← 992		
					1 987 477 900	→ 978		
	<b>500, 4MATIC</b>	10.98-08.06	225	LLE	1 987 477 901	2760		
	<b>500 4MATIC</b>	09.02-09.05	225		1 987 477 899	← 992		
					1 987 477 900	→ 978		
	<b>600</b>	08.99-08.02	270	FMS	1 987 477 899	← 992		
					1 987 477 900	→ 978		
		09.02-01.06	368		1 987 477 899	← 992		
					1 987 477 900	→ 978		

	<b>55 AMG</b>	09.00-08.02	265	LAB	0 265 007 008 <sup>4</sup>			
				RAB	0 265 007 006 <sup>4</sup>			
		09.00-09.02	265		0 265 007 002 <sup>3</sup>			
				FMS,LAB	0 265 007 121 <sup>4</sup>			
				FMS,RAB	0 265 007 123 <sup>4</sup>			
				FMS,LAB	0 265 007 008 <sup>4</sup>			
				FMS,RAB	0 265 007 006 <sup>4</sup>			
	<b>55 AMG KOMPRESSOR</b>	09.02-08.06	368		0 265 007 002 <sup>3</sup>			
				LAB	0 265 007 121 <sup>4</sup>			
				RAB	0 265 007 123 <sup>4</sup>			
	<b>65 AMG</b>	02.04-08.06	450		0 265 007 128 <sup>3</sup>			
				FMS,LAB	0 265 007 121 <sup>4</sup>			
				FMS,RAB	0 265 007 123 <sup>4</sup>			
				FMS,LAB	0 265 007 008 <sup>4</sup>			
				FMS,RAB	0 265 007 006 <sup>4</sup>			
	<b>280</b>	01.99-08.05	150		0 265 007 002 <sup>3</sup>			
				LAB	0 265 007 008 <sup>4</sup>			
				RAB	0 265 007 006 <sup>4</sup>			
	<b>320</b>	10.98-08.02	165		0 265 007 002 <sup>3</sup>			
				LAB	0 265 007 008 <sup>4</sup>			
				FMS,LAB	0 265 007 008 <sup>4</sup>			
				FMS,RAB	0 265 007 006 <sup>4</sup>			
				RAB	0 265 007 006 <sup>4</sup>			
	<b>320 CDI</b>	06.99-08.05	145/150		0 265 007 002 <sup>3</sup>			
				FMS,LAB	0 265 007 121 <sup>4</sup>			
				FMS,RAB	0 265 007 123 <sup>4</sup>			
				LAB	0 265 007 008 <sup>4</sup>			
				FMS,LAB	0 265 007 008 <sup>4</sup>			
				FMS,RAB	0 265 007 006 <sup>4</sup>			
				RAB	0 265 007 006 <sup>4</sup>			



		S							
<b>Mercedes-Benz Serie S [220]</b>									
350		09.02-08.05	180			FMS,LAB	0 265 007 121 <sup>4</sup>		
						FMS,RAB	0 265 007 123 <sup>4</sup>		
		09.02-08.06	180			FMS,LAB	0 265 007 008 <sup>4</sup>		
						FMS,RAB	0 265 007 006 <sup>4</sup>		
350 4MATIC		06.03-08.05	180			LAB	0 265 007 002 <sup>3</sup>		
						RAB	0 265 007 008 <sup>4</sup>		
400 CDI		06.99-08.05	184/191			RAB	0 265 007 006 <sup>4</sup>		
							0 265 007 002 <sup>3</sup>		
430		10.98-09.05	205			FMS,LAB	0 265 007 121 <sup>4</sup>		
		10.98-01.06	205			FMS,RAB	0 265 007 123 <sup>4</sup>		
430 4MATIC		10.98-09.05	205			LAB	0 265 007 008 <sup>4</sup>		
						FMS,LAB	0 265 007 008 <sup>4</sup>		
430 4MATIC		09.02-09.05	205			FMS,RAB	0 265 007 006 <sup>4</sup>		
						RAB	0 265 007 006 <sup>4</sup>		
500		10.98-09.05	225			FMS,RAB	0 265 007 006 <sup>4</sup>		
		10.98-08.06	225				0 265 007 002 <sup>3</sup>		
500 4MATIC		10.98-09.05	225			RAB	0 265 007 006 <sup>4</sup>		
						FMS,LAB	0 265 007 121 <sup>4</sup>		
500 4MATIC		09.02-09.05	225			FMS,RAB	0 265 007 123 <sup>4</sup>		
						FMS,LAB	0 265 007 008 <sup>4</sup>		
500 4MATIC		10.98-08.06	225			LAB	0 265 007 008 <sup>4</sup>		
						FMS,RAB	0 265 007 006 <sup>4</sup>		
600		08.99-08.02	270			RAB	0 265 007 006 <sup>4</sup>		
						FMS,LAB	0 265 007 008 <sup>4</sup>		
600		08.99-08.05	270			FMS,RAB	0 265 007 006 <sup>4</sup>		
							0 265 007 002 <sup>3</sup>		
600		09.02-01.06	368			LAB	0 265 007 008 <sup>4</sup>		
						RAB	0 265 007 006 <sup>4</sup>		
600		09.02-01.06	368				0 265 007 128 <sup>3</sup>		
						LAB	0 265 007 121 <sup>4</sup>		
600		09.02-01.06	368			RAB	0 265 007 123 <sup>4</sup>		
<b>Serie S [221]</b>									
	63 AMG	12.06-12.13	386/400/420						1987 470 506 <sup>8</sup>
									65 AMG
	63 AMG	12.06-12.13	386/400/420						1987 470 506 <sup>8</sup>
									65 AMG
250 CDI		09.10-12.13	150						SBJ
									SBJ
280		09.05-06.09	170	Fg.-Nr. →A 293228, Komp.Nr. 800					SBJ
									SBJ
280		09.05-12.09	170						SBJ
									SBJ
280		10.08-12.09	170	Fg.-Nr. A 265576→, Komp.Nr. 800					0 986 134 055
									0 986 135 055
320 CDI		12.05-04.09	173						ATP
									ATP

		S									
320 CDI 4MATIC		12.06-04.09	173	Komp.Nr. 800			0 986 134 055		← 42		
							0 986 135 055		→ 42		
350		09.05-06.09	200	Fg.-Nr. →A 293228,	Komp.Nr. 800	ATP				1 987 470 506 <sup>B</sup>	
										ATP	1 987 470 506 <sup>B</sup>
350		09.05-01.11	200	Komp.Nr. 800	SBJ					1 987 470 506 <sup>B</sup>	
										SBJ	1 987 470 506 <sup>B</sup>
350 4MATIC		10.08-01.11	200	Fg.-Nr. A 265576→,	Komp.Nr. 800	SBJ				0 986 134 055	
										SBJ	← 42
350 BlueTec		07.10-12.13	190			SBJ				0 986 135 055	
											SBJ
350 BlueTec 4MATIC										0 986 134 055	
											SBJ
350 CDI		05.09-06.10	173	Komp.Nr. 800						0 986 135 055	
											SBJ
350 CDI 4MATIC				Komp.Nr. 800		SBJ				0 986 134 055	
											SBJ
350 CGI		09.10-12.13	225			SBJ				1 987 470 506 <sup>B</sup>	
											SBJ
350 CGI 4MATIC						SBJ				1 987 470 506 <sup>B</sup>	
											SBJ
350 4MATIC		04.07-06.09	200	Fg.-Nr. →A 293228,	Komp.Nr. 800	SBJ				1 987 470 506 <sup>B</sup>	
										SBJ	← 42
400 Hybrid		04.07-01.11	200			SBJ				1 987 470 506 <sup>B</sup>	
											SBJ
400 Hybrid		04.09-06.09	205	Fg.-Nr. →A 293228,	Komp.Nr. 800	SBJ				1 987 470 506 <sup>B</sup>	
										SBJ	← 42
420 CDI		12.06-04.09	235							0 986 134 055	
											SBJ
450, CDI, 4MATIC		06.06-07.10	235/250							0 986 135 055	
											SBJ
500, CGI, CGI 4MATIC, 4MATIC		09.05-12.13	285/320							0 986 134 055	
											SBJ
<b>Serie SL [129]</b>											
	280	MFD	09.95-05.98	142						0 986 473 748	
											0 986 473 749
		OFD	07.93-08.95	142							0 986 474 953
			06.98-08.01	150							0 986 474 953
320	07.93-05.98	170							0 986 474 953		
										0 986 474 954	→
MFD	09.95-05.98	170							0 986 473 748		
										0 986 473 749	→ 40
OFD	06.98-08.01	165							0 986 474 953		
										0 986 474 954	→
500	07.93-09.04	235-240							0 986 474 953		
										0 986 474 954	→
	09.93-05.98	235-240	Fg.-Nr. F 103937→						0 986 473 748		
										0 986 473 749	→ 40
MFD	09.95-09.04	235-240							0 986 473 748		
										0 986 473 749	→ 40
600	07.93-09.95	290							0 986 473 748		
										0 986 473 749	→ 40
	09.95-05.98	290	Fg.-Nr. F 103937→						0 986 473 748		
										0 986 473 749	→ 40
	280	07.93-05.98	142	Fg.-Nr. →F 125157						0 986 473 963	
										0 986 473 964	→ 38
										0 986 473 276	← 36
										0 986 474 276	→ 36





<b>◀ MERCEDES-BENZ Serie SL [129]</b>																			
<b>280</b>	OFD	06.98-08.01	150	Fg.-Nr. →Ident 07/99		0986 <b>473 276</b>		←	36										
						0986 <b>474 276</b>		→	36										
<b>320</b>		07.93-05.98	170	Fg.-Nr. →F 125157		0986 <b>473 963</b>		←	38										
						0986 <b>473 964</b>		→	38										
						Fg.-Nr. F 125158 →				0986 <b>473 276</b>		←	36						
										0986 <b>474 276</b>		→	36						
						09.93-09.95				170	0986 <b>473 963</b>		←	38					
						09.95-05.98				170	0986 <b>473 964</b>		→	38					
	OFD	06.98-08.01	165	Fg.-Nr. →Ident 07/99		0986 <b>473 276</b>		←	36										
						0986 <b>474 276</b>		→	36										
<b>500</b>		07.93-09.95	235-240			0986 <b>473 963</b>		←	38										
						0986 <b>473 964</b>		→	38										
						09.93-05.98	235-240	Fg.-Nr. →F 103936	0986 <b>473 963</b>		←	38							
									0986 <b>473 964</b>		→	38							
						Fg.-Nr. F 103937 →F 125157								1987 <b>470 083</b>					
						Fg.-Nr. F 125158 →				0986 <b>473 276</b>		←	36						
09.95-09.04				235-240	0986 <b>473 276</b>		←	36											
						0986 <b>474 276</b>		→	36										
<b>280</b>		07.93-05.98	142			1987 <b>477 812</b>		←	1044										
						1987 <b>477 814</b>		→	1014										
		06.98-08.01	150		LLE	1987 <b>477 811</b>			2297										
						1987 <b>477 814</b>		→	1014										
<b>320</b>		07.93-05.98	170			1987 <b>477 812</b>		←	1044										
						1987 <b>477 814</b>		→	1014										
		06.98-08.01	165		LLE	1987 <b>477 811</b>			2297										
						1987 <b>477 812</b>		←	1044										
						1987 <b>477 814</b>		→	1014										
						1987 <b>477 812</b>		←	1044										
<b>500</b>		07.93-09.04	235-240			1987 <b>477 812</b>		←	1044										
						1987 <b>477 814</b>		→	1014										
		06.98-08.01	225		LLE	1987 <b>477 811</b>			2297										
						1987 <b>477 812</b>		←	1044										
						1987 <b>477 814</b>		→	1014										
						1987 <b>477 812</b>		←	1044										
<b>600</b>		07.93-09.95	290			1987 <b>477 812</b>		←	1044										
						1987 <b>477 814</b>		→	1014										
		06.98-08.01	290		LLE	1987 <b>477 811</b>			2297										
						1987 <b>477 812</b>		←	1044										
						1987 <b>477 814</b>		→	1014										
						1987 <b>477 812</b>		←	1044										
<b>60 AMG</b>		07.93-06.98	280	Fg.-Nr. →F125157		LAB			0265 <b>006 132</b> <sup>3</sup>										
						RAB			0265 <b>006 130</b> <sup>3</sup>										
						Fg.-Nr. F125158 →				LAB			0265 <b>006 292</b> <sup>3</sup>						
										RAB			0265 <b>006 280</b> <sup>3</sup>						
						ASR	07.93-06.98	280	Fg.-Nr. →F105254	RAB			0265 <b>002 222</b> <sup>4</sup>						
										Fg.-Nr. F105255 →				LAB		0265 <b>006 186</b> <sup>4</sup>			
										RAB			0265 <b>006 184</b> <sup>4</sup>						
						OAS	07.93-06.98	280					0265 <b>002 214</b> <sup>4</sup>						
						<b>280</b>		07.93-05.98	142			LAB			0265 <b>006 132</b> <sup>3</sup>				
												RAB			0265 <b>006 130</b> <sup>3</sup>				
												06.98-08.01	150			LAB			0265 <b>006 186</b> <sup>4</sup>
																RAB			0265 <b>006 292</b> <sup>3</sup>
				RAB									0265 <b>006 184</b> <sup>4</sup>						
				RAB									0265 <b>006 280</b> <sup>3</sup>						
ASR	07.93-05.98	142	Fg.-Nr. →F105254	RAB			0265 <b>002 222</b> <sup>4</sup>												
				Fg.-Nr. F105255 →				LAB		0265 <b>006 186</b> <sup>4</sup>									
				RAB			0265 <b>006 184</b> <sup>4</sup>												
OAS	07.93-05.98	142					0265 <b>002 214</b> <sup>4</sup>												

		S													
320		07.93-05.98	170				LAB		0 265 006 132 <sup>3</sup>						
							RAB		0 265 006 130 <sup>3</sup>						
		06.98-08.01	165				LAB		0 265 006 186 <sup>4</sup>						
									0 265 006 292 <sup>3</sup>						
							RAB		0 265 006 184 <sup>4</sup>						
									0 265 006 280 <sup>3</sup>						
ASR	07.93-05.98	170					RAB		0 265 002 222 <sup>4</sup>						
							OAS		0 265 002 214 <sup>4</sup>						
500		07.93-09.04	235-240				Fg.-Nr. →F125157	LAB	0 265 006 132 <sup>3</sup>						
								RAB	0 265 006 130 <sup>3</sup>						
							Fg.-Nr. F125158→	LAB	0 265 006 292 <sup>3</sup>						
								RAB	0 265 006 280 <sup>3</sup>						
							06.98-09.01	225	LAB	0 265 006 186 <sup>4</sup>					
											0 265 006 292 <sup>3</sup>				
							RAB	0 265 006 184 <sup>4</sup>							
									0 265 006 280 <sup>3</sup>						
		ASR	07.93-09.04				235-240					RAB	0 265 002 222 <sup>4</sup>		
												LAB	0 265 006 186 <sup>4</sup>		
												RAB	0 265 006 184 <sup>4</sup>		
		OAS	07.93-09.04				235-240						0 265 002 214 <sup>4</sup>		
600		07.93-08.02	290				Fg.-Nr. →F105254	LAB	0 265 002 114 <sup>4</sup>						
								RAB	0 265 002 112 <sup>4</sup>						
							Fg.-Nr. →F125157	LAB	0 265 006 132 <sup>3</sup>						
								RAB	0 265 006 130 <sup>3</sup>						
							Fg.-Nr. →F125157, Komp.Nr. Code 805, Komp.Nr. Code 806							LAB	0 265 006 132 <sup>3</sup>
														LAB	0 265 006 186 <sup>4</sup>
		Fg.-Nr. F105255→										RAB	0 265 006 184 <sup>4</sup>		
												LAB	0 265 006 292 <sup>3</sup>		
		Fg.-Nr. F125158→										RAB	0 265 006 280 <sup>3</sup>		

**Serie SL [230]**

		280	01.08-04.09	170				SBJ	1 987 470 506 <sup>8</sup>		
								SBJ	1 987 470 506 <sup>8</sup>		
		300	05.09-12.11	170					BLA,SBJ	1 987 470 506 <sup>8</sup>	
									NOR,SBJ	1 987 470 506 <sup>8</sup>	
350		03.03-12.05	180					0 986 134 086	← 42		
								0 986 135 086	→ 42		
		01.06-12.07	200							1 987 470 506 <sup>8</sup>	
		01.08-12.11	232					SBJ		1 987 470 506 <sup>8</sup>	
								SBJ	0 986 134 055	← 42	
									0 986 135 055	→ 42	
500		10.01-12.05	225					0 986 134 055	← 42		
								0 986 135 055	→ 42		
		01.06-11.12	285							1 987 470 506 <sup>8</sup>	
		55 AMG	10.01-02.06	368				0 265 007 696 <sup>3</sup>			
										Fg.-Nr. →F 030151	0 265 007 635 <sup>4</sup>
			01.06-03.08	380					0 265 007 696 <sup>3</sup>		
		63 AMG	01.08-12.11	386						APG	0 265 008 097 <sup>3</sup>
										NPG	0 265 007 696 <sup>3</sup>
		65 AMG	09.04-12.11	450						BLA	0 265 008 097 <sup>3</sup>
										NOR	0 265 007 696 <sup>3</sup>
		280	01.08-04.09	170							0 265 007 696 <sup>3</sup>
		300	05.09-12.11	170							0 265 007 696 <sup>3</sup>



		S								
<b>◀ MERCEDES-BENZ Serie SL [230]</b>										
<b>350</b>		03.03-12.05	180				0 265 <b>007 696</b> <sup>3</sup>			
				Fg.-Nr. →F 030151			0 265 <b>007 635</b> <sup>4</sup>			
<b>500</b>		10.01-12.05	225				0 265 <b>007 696</b> <sup>3</sup>			
				Fg.-Nr. →F 030151			0 265 <b>007 635</b> <sup>4</sup>			
		Fg.-Nr. F 030152 →F 0134548			0 265 <b>007 694</b> <sup>4</sup>					
		01.06-11.12	285				0 265 <b>007 696</b> <sup>3</sup>			
<b>600</b>		03.03-11.12	368/380				0 265 <b>007 696</b> <sup>3</sup>			
<b>Serie SLK [170]</b>										
	<b>200</b>	09.96-03.04	100/120/ 135				0 986 <b>473 096</b>		← 56,93	1 987 <b>470 506</b> <sup>8</sup>
				200 KOMPRESSOR			0 986 <b>474 096</b>		→ 56,93	1 987 <b>470 506</b> <sup>8</sup>
	<b>230 KOMPRESSOR</b>	09.96-03.04	142/145				0 986 <b>473 096</b>		← 56,93	1 987 <b>470 506</b> <sup>8</sup>
							0 986 <b>474 096</b>		→ 56,93	1 987 <b>470 506</b> <sup>8</sup>
	<b>320</b>	06.99-03.04	160				0 986 <b>473 329</b>		← 57	1 987 <b>470 506</b> <sup>8</sup>
							0 986 <b>474 329</b>		→ 57	1 987 <b>470 506</b> <sup>8</sup>
	<b>200</b>	09.96-01.00	100	Fg.-Nr. →017687			0 986 <b>473 963</b>		← 38	1 987 <b>470 083</b>
					0 986 <b>473 964</b>		→ 38	1 987 <b>470 083</b>		
		04.97-01.00	100	Fg.-Nr. 017688→			0 986 <b>473 174</b>		← 35,96	1 987 <b>470 084</b>
							0 986 <b>474 174</b>		→ 35,96	1 987 <b>470 084</b>
	<b>200 KOMPRESSOR</b>	09.96-01.00	135	Fg.-Nr. →017687			0 986 <b>473 963</b>		← 38	1 987 <b>470 083</b>
							0 986 <b>473 964</b>		→ 38	1 987 <b>470 083</b>
		04.97-01.00	135	Fg.-Nr. 017688→			0 986 <b>473 174</b>		← 35,96	1 987 <b>470 084</b>
							0 986 <b>474 174</b>		→ 35,96	1 987 <b>470 084</b>
		02.00-03.04	120				0 986 <b>473 174</b>		← 35,96	1 987 <b>470 084</b>
							0 986 <b>474 174</b>		→ 35,96	1 987 <b>470 084</b>
	<b>230 KOMPRESSOR</b>	09.96-01.00	142	Fg.-Nr. →017687			0 986 <b>473 963</b>		← 38	1 987 <b>470 083</b>
							0 986 <b>473 964</b>		→ 38	1 987 <b>470 083</b>
		04.97-01.00	142	Fg.-Nr. 017688→			0 986 <b>473 174</b>		← 35,96	1 987 <b>470 084</b>
							0 986 <b>474 174</b>		→ 35,96	1 987 <b>470 084</b>
		02.00-03.04	145				0 986 <b>473 174</b>		← 35,96	1 987 <b>470 084</b>
							0 986 <b>474 174</b>		→ 35,96	1 987 <b>470 084</b>
	<b>320</b>	06.99-03.04	160				0 986 <b>473 174</b>		← 35,96	1 987 <b>470 084</b>
							0 986 <b>474 174</b>		→ 35,96	1 987 <b>470 084</b>
	<b>32 AMG KOMPRESSOR</b>	06.99-03.04	260				1 987 <b>477 628</b>		← 1005	
							1 987 <b>477 629</b>		→ 994	
	<b>200</b>	09.96-03.04	100/120/ 135				1 987 <b>477 628</b>		← 1005	
	<b>200 KOMPRESSOR</b>						1 987 <b>477 629</b>		→ 994	
	<b>230 KOMPRESSOR</b>	09.96-03.04	142/145				1 987 <b>477 628</b>		← 1005	
							1 987 <b>477 629</b>		→ 994	
	<b>320</b>	06.99-03.04	160				1 987 <b>477 628</b>		← 1005	
							1 987 <b>477 629</b>		→ 994	
<b>Serie SLK [171]</b>										
	<b>200 KOMPRESSOR</b>	04.04-11.07	120				0 986 <b>473 220</b>		← 57	
					0 986 <b>474 220</b>		→ 57			
		12.07-11.10	135	SBJ			0 986 <b>134 076</b>		← 57	
							0 986 <b>135 076</b>		→ 57	
				Komp.Nr. 809	SBJ		0 986 <b>473 490</b>		← 57	
							0 986 <b>474 490</b>		→ 57	
				Komp.Nr. 809	SBJ		0 986 <b>473 220</b>		← 57	
							0 986 <b>474 220</b>		→ 57	



		S							
280		05.05-02.09	170			SBJ	0 986 134 076		← 57
							0 986 135 076		→ 57
						SBJ	0 986 473 490		← 57
							0 986 474 490		→ 57
300		03.09-11.10	170			SBJ	0 986 134 076		← 57
							0 986 135 076		→ 57
						SBJ	0 986 473 490		← 57
							0 986 474 490		→ 57
350		03.06-02.11	200/224				0 986 134 076		← 57
							0 986 135 076		→ 57
<hr/>									
	200 KOMPRESSOR	04.04-11.07	120				0 986 473 282		← 36
							0 986 474 282		→ 36
		12.07-11.10	135			SBJ	0 986 134 039		←
							0 986 134 061		←
							0 986 135 039		→
							0 986 135 061		→
						SBJ	0 986 473 282		← 36
							0 986 474 282		→ 36
							0 986 473 282		← 36
							0 986 474 282		→ 36
280		05.05-02.09	170			SBJ	0 986 134 039		←
							0 986 134 061		←
							0 986 135 039		→
							0 986 135 061		→
						SBJ	0 986 473 282		← 36
							0 986 474 282		→ 36
							0 986 473 282		← 36
							0 986 474 282		→ 36
300		03.09-11.10	170			SBJ	0 986 134 039		←
							0 986 134 061		←
							0 986 135 039		→
							0 986 135 061		→
						SBJ	0 986 473 282		← 36
							0 986 474 282		→ 36
							0 986 473 282		← 36
							0 986 474 282		→ 36
350		04.04-11.07	200				0 986 134 039		←
		12.07-02.11	224				0 986 134 061		←
							0 986 135 039		→
							0 986 135 061		→
<hr/>									
	55 AMG	04.04-11.10	265				1 987 482 022		← 760
							1 987 482 023		→ 1004
	200 KOMPRESSOR	04.04-11.10	120/135				1 987 482 022		← 760
							1 987 482 023		→ 1004
	280	05.05-02.09	170				1 987 482 022		← 760
							1 987 482 023		→ 1004
	300	03.09-11.10	170				1 987 482 022		← 760
							1 987 482 023		→ 1004
	350	04.04-02.11	200/224				1 987 482 022		← 760
							1 987 482 023		→ 1004
<hr/>									
	55 AMG	04.04-11.09	265	Fg.-Nr. →F 229053		RAB	0 986 594 550 <sup>4</sup>		
		04.04-11.10	265				0 986 594 543 <sup>3</sup>		
						LAB	0 986 594 549 <sup>4</sup>		
	200 KOMPRESSOR	04.04-11.10	120/135				0 986 594 543 <sup>3</sup>		
						LAB	0 986 594 549 <sup>4</sup>		
						RAB	0 986 594 550 <sup>4</sup>		
	280	05.05-02.09	170				0 986 594 543 <sup>3</sup>		
						LAB	0 986 594 549 <sup>4</sup>		
						RAB	0 986 594 550 <sup>4</sup>		



		S															
<b>Mercedes-Benz Serie SLK [171]</b>																	
<b>300</b>		03.09-11.09	170	Fg.-Nr. →F 229053	RAB		0986 594 550 <sup>4</sup>										
		03.09-11.10	170				0986 594 543 <sup>3</sup>										
<b>350</b>		04.04-11.07	200				0986 594 549 <sup>4</sup>										
					LAB		0986 594 543 <sup>3</sup>										
						LAB		0986 594 549 <sup>4</sup>									
						RAB		0986 594 550 <sup>4</sup>									
		12.07-11.09	224	Fg.-Nr. →F 229053	RAB		0986 594 550 <sup>4</sup>										
12.07-02.11	224					0986 594 543 <sup>3</sup>											
					LAB		0986 594 549 <sup>4</sup>										
<b>Serie SLR (Coupé) [199]</b>																	
<b>5.4</b>		04.04-12.09	460/478				0 265 007 696 <sup>3</sup>										
		5.4 722 Edition															
<b>Serie SLR (Roadster) [199]</b>																	
<b>5.4</b>		04.07-12.09	460				0 265 007 696 <sup>3</sup>										
<b>Serie V [447]</b>																	
<b>200 CDI</b>		04.14→	100/120				0986 134 306		←								
							0986 134 336		←								
<b>250 BlueTec</b>		04.14→	140				0986 135 306		→								
							0986 135 336		→								
							0986 134 306		←								
							0986 134 336		←								
							0986 135 306		→								
							0986 135 336		→								
<b>Serie V [638]</b>																	
<b>200</b>		04.96-09.03	95				ATE,	0986 473 235		← 60							
							ITB,	0986 474 235		→ 60							
							BSY,	0 204 102 914		← 60							
							FDO,	0986 473 235									
							JUR	0986 473 362									
								0 204 102 915		→ 60							
								0986 474 235									
								0986 474 362									
							<b>200 CDI</b>		06.99-09.03	75				BSY,	0 204 102 914		← 60
														FDO,	0986 473 235		
JUR	0986 473 362																
	0 204 102 915		→ 60														
							0986 474 235										
							0986 474 362										
<b>220 CDI</b>		06.99-09.03	90				BSY,	0 204 102 914		← 60							
							FDO,	0986 473 235									
							JUR	0986 473 362									
								0 204 102 915		→ 60							
							0986 474 235										
							0986 474 362										
<b>230</b>		04.96-09.03	72/105				ATE,	0986 473 235		← 60							
							ITB	0986 474 235		→ 60							



		S							
<b>230</b> <b>230 TD</b>		04.96-09.03	72/105				BSY, 0 204 <b>102 914</b> FDO, 0 986 <b>473 235</b> JUR, 0 986 <b>473 362</b>	← 60 ↻ ↻	
							0 204 <b>102 915</b> 0 986 <b>474 235</b> 0 986 <b>474 362</b>	→ 60 ↻ ↻	
<b>280</b>		04.96-09.03	128				ATE, 0 986 <b>473 235</b> ITB, 0 986 <b>474 235</b> BSY, 0 204 <b>102 914</b> FDO, 0 986 <b>473 235</b> JUR, 0 986 <b>473 362</b>	↻ ← 60 ↻ → 60 ← 60 ↻ ↻	
							0 204 <b>102 915</b> 0 986 <b>474 235</b> 0 986 <b>474 362</b>	→ 60 ↻ ↻	
	<b>200</b> <b>200 CDI</b>	04.96-09.03	75/95				0 204 <b>102 916</b> 0 986 <b>473 360</b>	← 33 ↻	
							0 204 <b>102 917</b> 0 986 <b>474 360</b>	→ 33 ↻	
	<b>220 CDI</b>	06.99-09.03	90				0 204 <b>102 916</b> 0 986 <b>473 360</b>	← 33 ↻	
							0 204 <b>102 917</b> 0 986 <b>474 360</b>	→ 33 ↻	
	<b>230</b> <b>230 TD</b>	04.96-09.03	72/105				0 204 <b>102 916</b> 0 986 <b>473 360</b>	← 33 ↻	
							0 204 <b>102 917</b> 0 986 <b>474 360</b>	→ 33 ↻	
	<b>280</b>	04.96-09.03	128				0 204 <b>102 916</b> 0 986 <b>473 360</b>	← 33 ↻	
							0 204 <b>102 917</b> 0 986 <b>474 360</b>	→ 33 ↻	
	<b>200</b> <b>200 CDI</b> <b>220 CDI</b>	04.96-09.03	75/95				1 987 <b>477 199</b> RLE 1 987 <b>482 501</b>	1167 1270	
		06.99-09.03	90				1 987 <b>477 199</b> RLE 1 987 <b>482 501</b>	1167 1270	
	<b>230</b> <b>230 TD</b>	04.96-09.03	105 72				1 987 <b>477 199</b> RLE 1 987 <b>482 501</b>	1167 1270	
	<b>280</b>	04.96-09.03	128				1 987 <b>477 199</b> RLE 1 987 <b>482 501</b>	1167 1270	
	<b>200</b> <b>200 CDI</b> <b>220 CDI</b>	04.96-09.03	75/95				0 265 <b>006 214</b> <sup>3</sup> 0 265 <b>006 215</b> <sup>4</sup>		
		06.99-09.03	90				0 265 <b>006 214</b> <sup>3</sup> 0 265 <b>006 215</b> <sup>4</sup>		
	<b>230</b> <b>230 TD</b>	04.96-09.03	72/105				0 265 <b>006 214</b> <sup>3</sup> 0 265 <b>006 215</b> <sup>4</sup>		
	<b>280</b>	04.96-09.03	128				0 265 <b>006 214</b> <sup>3</sup> 0 265 <b>006 215</b> <sup>4</sup>		
<b>Serie 190 [201]</b>									
	<b>190 E 1.8</b>	09.91-04.94	80				0 986 <b>473 655</b> 0 986 <b>473 655</b> 0 986 <b>474 655</b>	↻ ← 54 ↻ ← 54 ↻ → 54	1 987 <b>470 287</b> <sup>7</sup> 1 987 <b>474 486</b> <sup>8</sup> 1 987 <b>470 287</b> <sup>7</sup>



◀ MERCEDES-BENZ Serie 190 [201]								
	190 E 1.8	09.91-04.94	80			0986 471 951	← 35	
						0986 473 951		
						0986 471 952	→ 35	
						0986 473 952		
	190 E 1.8	09.91-04.94	80			1987 477 324	1044	
	190 E 1.8	09.91-04.94	80		LAB	0265 001 288 <sup>3</sup>		
					RAB	0265 001 286 <sup>3</sup>		
		EDS 09.91-04.94	80			0265 002 232 <sup>4</sup>		
		OED 09.91-04.94	80			0265 002 230 <sup>4</sup>		
<b>Sprinter</b>								
	310 D	09.96-05.01	70		BSY, TEX	0986 473 231	← 45	
					TEX, WAB	0986 473 250	← 44	
					TEJ	0986 473 249	← 60	
						0986 474 249	→ 60	
	311 CDI	06.01-12.04	80		MVB, TEJ	0986 473 249	← 60	
						0986 474 249	→ 60	
	312 D	08.99-05.01	77/85		BSY, TEX	0986 473 231	← 45	
					TEX, WAB	0986 473 250	← 44	
					TEJ	0986 473 249	← 60	
						0986 474 249	→ 60	
	313 CDI	06.01-05.12	95		MVB, TEJ	0986 473 249	← 60	
						0986 474 249	→ 60	
	412 D	10.99-05.01	85		BSY	0204 102 912	← 45	
						0986 473 231		
						0204 102 913	→ 45	
						0986 474 231		
					TEJ	0986 473 249	← 60	
						0986 474 249	→ 60	
				Komp.Nr. 504015/03/06,	TNK	PEO	0986 473 250	← 44
				Komp.Nr. 504015/08/50			0986 474 250	→ 44
	311 CDI	06.01-12.04	80		ATE	0986 473 353	← 51,92	1987 470 506 <sup>8</sup>
						0986 473 363	← 44,93	
						0986 474 353	→ 51,92	1987 470 506 <sup>8</sup>
						0986 474 363	→ 44,93	
					BSY	0204 102 918	← 52	
						0986 473 359		
						0204 102 919	→ 52	
						0986 474 359		
	312 D	08.99-05.01	77/85		ATE	0986 473 353	← 51,92	1987 470 506 <sup>8</sup>
						0986 473 363	← 44,93	
						0986 474 353	→ 51,92	1987 470 506 <sup>8</sup>
						0986 474 363	→ 44,93	
					BSY	0204 102 918	← 52	
						0986 473 359		
						0204 102 919	→ 52	
						0986 474 359		



		S										
313 D	08.99-05.01	77/85	BSB	BSY	0 986 473 359			52				
					0 986 474 359			52				
					BSY, FDO	0 986 473 359			52			
						0 986 474 359			52			
					BSB,TEF	0 986 473 363			44,93			
						0 986 474 363			44,93			
					BSB,TEJ	0 986 473 353			51,92			
						0 986 474 353			51,92			
					Komp.Nr. 504015/03, Komp.Nr. 504015/50, Komp.Nr. 504015/56	TNK	0 986 473 250			44		
							0 986 474 250			44		
313 CDI	06.01-05.12	95	ATE	0 986 473 353			51,92	1 987 470 506 <sup>B</sup>				
				0 986 473 363			44,93					
				0 986 474 353			51,92	1 987 470 506 <sup>B</sup>				
				0 986 474 363			44,93					
			BSY	0 204 102 918			52					
				0 986 473 359								
				0 204 102 919			52					
				0 986 474 359								
				412 D	10.99-05.01	85	ATE	0 986 473 353			51,92	1 987 470 506 <sup>B</sup>
								0 986 473 363			44,93	
0 986 474 353			51,92					1 987 470 506 <sup>B</sup>				
0 986 474 363			44,93									
BSY	0 204 102 918						52					
	0 986 473 359											
	0 204 102 919						52					
	0 986 474 359											
	BSB	BSY	0 986 473 359					52				
			0 986 474 359					52				
BSB,TEF	0 986 473 363			44,93								
	0 986 474 363			44,93								
Komp.Nr. 504015/03, Komp.Nr. 504015/50, Komp.Nr. 504015/56	TNK	0 986 473 250			44							
		0 986 474 250			44							

**Sprinter [NCV3]**

	209 CDI	04.06-12.09	65	0 986 134 019			48		
				0 986 135 019			48		
	210 CDI	03.09→	70	0 986 134 019			48		
				0 986 135 019			48		
	211 CDI	04.06→	80/85	0 986 134 019			48		
				0 986 135 019			48		
	213 CDI	04.06→	95	0 986 134 019			48		
				0 986 135 019			48		
	215 CDI	04.06→	110	0 986 134 019			48		
				0 986 135 019			48		
	216 216 CDI	09.08→	115/120	0 986 134 019			48		
				0 986 135 019			48		
	218 CDI	04.06-03.09	135	0 986 134 019			48		
				0 986 135 019			48		
	219 CDI	03.09→	140	0 986 134 019			48		
				0 986 135 019			48		
	224	04.06→	190	0 986 134 019			48		
				0 986 135 019			48		
	309 CDI	04.06-12.09	65	ERH	0 986 134 035			52	
					0 986 135 035			52	
				NON	0 986 134 019			48	
					0 986 135 019			48	





	S							
◀ MERCEDES-BENZ Sprinter [NCV3]								
310 CDI	03.09→	70	ERH	0986 134 035		52		
				0986 135 035		52		
			NON	0986 134 019		48		
				0986 135 019		48		
311 CDI	04.06→	80/85		0986 134 019		48		
				0986 135 019		48		
313 CDI	04.06→	95	ERH	0986 134 035		52		
				0986 135 035		52		
			NON	0986 134 019		48		
				0986 135 019		48		
315 CDI	04.06→	110		0986 134 019		48		
				0986 135 019		48		
316	09.08→	115		0986 134 019		48		
316 NGT				0986 135 019		48		
316 CDI	03.09→	120	ERH	0986 134 035		52		
				0986 135 035		52		
			NON	0986 134 019		48		
				0986 135 019		48		
318 CDI	04.06-03.09	135	ERH	0986 134 035		52		
				0986 135 035		52		
			NON	0986 134 019		48		
				0986 135 019		48		
319 CDI	03.09→	140	ERH	0986 134 035		52		
				0986 135 035		52		
			NON	0986 134 019		48		
				0986 135 019		48		
324	04.06→	190		0986 134 019		48		
				0986 135 019		48		
411 CDI	04.06-09.11	80		0986 134 035		52		
				0986 135 035		52		
413 CDI	03.09→	95		0986 134 035		52		
				0986 135 035		52		
415 CDI	04.06-09.11	110		0986 134 035		52		
				0986 135 035		52		
416 CDI	03.09→	120		0986 134 035		52		
				0986 135 035		52		
418 CDI	04.06-03.09	135		0986 134 035		52		
				0986 135 035		52		
419 CDI	03.09→	140		0986 134 035		52		
				0986 135 035		52		
424	04.06→	190		0986 134 035		52		
				0986 135 035		52		
509 CDI	04.06-12.09	65		0986 134 035		52		
				0986 135 035		52		
510 CDI	03.09→	70		0986 134 035		52		
				0986 135 035		52		
511 CDI	04.06-09.11	80		0986 134 035		52		
				0986 135 035		52		
513 CDI	03.09→	95		0986 134 035		52		
				0986 135 035		52		
515 CDI	04.06→	110		0986 134 035		52		
				0986 135 035		52		
516, CDI, NGT	09.08→	115/120		0986 134 035		52		
				0986 135 035		52		
518 CDI	04.06-03.09	135		0986 134 035		52		
				0986 135 035		52		
519 CDI	03.09→	140		0986 134 035		52		
				0986 135 035		52		
524	04.06→	190		0986 134 035		52		
				0986 135 035		52		



		S							
	<b>209</b> CDI	04.06-12.09	65				0 204 004 519	← 51	
							0 986 134 046		
							0 204 004 520	→ 51	
							0 986 135 046		
	<b>210</b> CDI	03.09→	70				0 204 004 519	← 51	
							0 986 134 046		
							0 204 004 520	→ 51	
							0 986 135 046		
	<b>211</b> CDI	04.06→	80/85				0 204 004 519	← 51	
							0 986 134 046		
							0 204 004 520	→ 51	
							0 986 135 046		
	<b>213</b> CDI	04.06→	95				0 204 004 519	← 51	
							0 986 134 046		
							0 204 004 520	→ 51	
							0 986 135 046		
	<b>215</b> CDI	04.06→	110				0 204 004 519	← 51	
							0 986 134 046		
							0 204 004 520	→ 51	
							0 986 135 046		
	<b>216</b>	09.08→	115/120				0 204 004 519	← 51	
	<b>216</b> CDI						0 986 134 046		
							0 204 004 520	→ 51	
							0 986 135 046		
	<b>218</b> CDI	04.06-03.09	135				0 204 004 519	← 51	
							0 986 134 046		
							0 204 004 520	→ 51	
							0 986 135 046		
	<b>219</b> CDI	03.09→	140				0 204 004 519	← 51	
							0 986 134 046		
							0 204 004 520	→ 51	
							0 986 135 046		
	<b>224</b>	04.06→	190				0 204 004 519	← 51	
							0 986 134 046		
							0 204 004 520	→ 51	
							0 986 135 046		
	<b>309</b> CDI	04.06-12.09	65				0 204 004 519	← 51	
							0 986 134 046		
							0 204 004 520	→ 51	
							0 986 135 046		
	<b>310</b> CDI	03.09→	70				0 204 004 519	← 51	
							0 986 134 046		
							0 204 004 520	→ 51	
							0 986 135 046		
	<b>311</b> CDI	04.06→	80/85				0 204 004 519	← 51	
							0 986 134 046		
							0 204 004 520	→ 51	
							0 986 135 046		
	<b>313</b> CDI	04.06→	95				0 204 004 519	← 51	
							0 986 134 046		
							0 204 004 520	→ 51	
							0 986 135 046		
	<b>315</b> CDI	04.06→	110				0 204 004 519	← 51	
							0 986 134 046		
							0 204 004 520	→ 51	
							0 986 135 046		
	<b>316</b>	09.08→	115/120				0 204 004 519	← 51	
	<b>316</b> CDI						0 986 134 046		
	<b>316</b> NGT						0 204 004 520	→ 51	
							0 986 135 046		



		S							
◀ MERCEDES-BENZ Sprinter [NCV3]									
318 CDI		04.06-03.09	135				0 204 004 519	← 51	
							0 986 134 046		
							0 204 004 520	→ 51	
							0 986 135 046		
319 CDI		03.09→	140				0 204 004 519	← 51	
							0 986 134 046		
							0 204 004 520	→ 51	
							0 986 135 046		
324		04.06→	190				0 204 004 519	← 51	
							0 986 134 046		
							0 204 004 520	→ 51	
							0 986 135 046		
411 CDI		04.06-09.11	80				0 204 004 523	← 48	
							0 986 134 062		
							0 204 004 524	→ 48	
							0 986 135 062		
413 CDI		03.09→	95				0 204 004 523	← 48	
							0 986 134 062		
							0 204 004 524	→ 48	
							0 986 135 062		
415 CDI		04.06-09.11	110				0 204 004 523	← 48	
							0 986 134 062		
							0 204 004 524	→ 48	
							0 986 135 062		
416 CDI		03.09→	120				0 204 004 523	← 48	
							0 986 134 062		
							0 204 004 524	→ 48	
							0 986 135 062		
418 CDI		04.06-03.09	135				0 204 004 523	← 48	
							0 986 134 062		
							0 204 004 524	→ 48	
							0 986 135 062		
419 CDI		03.09→	140				0 204 004 523	← 48	
							0 986 134 062		
							0 204 004 524	→ 48	
							0 986 135 062		
424		04.06→	190				0 204 004 523	← 48	
							0 986 134 062		
							0 204 004 524	→ 48	
							0 986 135 062		
509 CDI		04.06-12.09	65				0 204 004 523	← 48	
							0 986 134 062		
							0 204 004 524	→ 48	
							0 986 135 062		
510 CDI		03.09→	70				0 204 004 523	← 48	
							0 986 134 062		
							0 204 004 524	→ 48	
							0 986 135 062		
511 CDI		04.06-09.11	80				0 204 004 523	← 48	
							0 986 134 062		
							0 204 004 524	→ 48	
							0 986 135 062		
513 CDI		03.09→	95				0 204 004 523	← 48	
							0 986 134 062		
							0 204 004 524	→ 48	
							0 986 135 062		
515 CDI		04.06→	110				0 204 004 523	← 48	
							0 986 134 062		
							0 204 004 524	→ 48	
							0 986 135 062		











		S							
<b>516</b>		09.08→	115/120				0 204 004 523	← 48	
<b>516</b> CDI							0 986 134 062		
<b>516</b> NGT							0 204 004 524	→ 48	
							0 986 135 062		
<b>518</b> CDI		04.06-03.09	135				0 204 004 523	← 48	
							0 986 134 062		
							0 204 004 524	→ 48	
							0 986 135 062		
<b>519</b> CDI		03.09→	140				0 204 004 523	← 48	
							0 986 134 062		
							0 204 004 524	→ 48	
							0 986 135 062		
<b>524</b>		04.06→	190				0 204 004 523	← 48	
							0 986 134 062		
							0 204 004 524	→ 48	
							0 986 135 062		
		<b>209</b> CDI	04.06-12.09	65			1 987 482 032	↔ 1666	
						FKR,TW	1 987 482 312	1374	
						FMR,TW	1 987 482 028	1867	
							1 987 482 030	1771	
							1 987 482 380	1805	
<b>210</b> CDI		03.09→	70				1 987 482 032	↔ 1666	
						FKR,TW	1 987 482 312	1374	
						FMR,TW	1 987 482 028	1867	
							1 987 482 030	1771	
							1 987 482 380	1805	
<b>211</b> CDI		04.06→	80/85				1 987 482 032	↔ 1666	
						FKR,TW	1 987 482 312	1374	
						FMR,TW	1 987 482 028	1867	
							1 987 482 030	1771	
							1 987 482 380	1805	
<b>213</b> CDI		04.06→	95				1 987 482 032	↔ 1666	
						FKR,TW	1 987 482 312	1374	
						FMR,TW	1 987 482 028	1867	
							1 987 482 030	1771	
							1 987 482 380	1805	
<b>215</b> CDI		04.06→	110				1 987 482 032	↔ 1666	
						FKR,TW	1 987 482 312	1374	
						FMR,TW	1 987 482 028	1867	
							1 987 482 030	1771	
							1 987 482 380	1805	
<b>216</b>		09.08→	115/120				1 987 482 032	↔ 1666	
<b>216</b>		09.08→	115/120			FKR,TW	1 987 482 312	1374	
<b>216</b> CDI						FMR,TW	1 987 482 028	1867	
							1 987 482 030	1771	
							1 987 482 380	1805	
<b>216</b> CDI		03.09→	115/120				1 987 482 032	↔ 1666	
<b>218</b> CDI		04.06-03.09	135				1 987 482 032	↔ 1666	
						FKR,TW	1 987 482 312	1374	
						FMR,TW	1 987 482 028	1867	
							1 987 482 030	1771	
							1 987 482 380	1805	
<b>219</b> CDI		03.09→	140				1 987 482 032	↔ 1666	
						FKR,TW	1 987 482 312	1374	
						FMR,TW	1 987 482 028	1867	
							1 987 482 030	1771	
							1 987 482 380	1805	
<b>224</b>		04.06→	190				1 987 482 032	↔ 1666	
						FKR,TW	1 987 482 312	1374	



		S							
◀ MERCEDES-BENZ Sprinter [NCV3]									
224	04.06→	190	FMR,TW	1987 482 028	1867				
				1987 482 030	1771				
				1987 482 380	1805				
309 CDI	04.06-12.09	65	FAN,TW	1987 482 028	1867				
				1987 482 029	2522				
				1987 482 030	1771				
				1987 482 312	1374				
				1987 482 380	1805				
310 CDI	03.09→	70	FKR,TW	1987 482 032	↔ 1666				
				1987 482 312	1374				
			FLR,TW	1987 482 029	2522				
				1987 482 381	2462				
			FMR,TW	1987 482 028	1867				
				1987 482 030	1771				
				1987 482 380	1805				
311 CDI	04.06-09.11	80	FKR,TW	1987 482 312	1374				
				FLR,TW	1987 482 029	2522			
			FMR,TW	1987 482 381	2462				
				1987 482 028	1867				
				1987 482 030	1771				
			06.11→	85	NAA	1987 482 032	↔ 1666		
	1987 482 032	↔ 1666							
	FKR,TW	1987 482 312			1374				
		FLR,TW			1987 482 029	2522			
	FMR,TW	1987 482 381			2462				
		1987 482 028			1867				
	313 CDI	04.06→	95	FAN,TW	1987 482 028	1867			
1987 482 029					2522				
1987 482 030					1771				
1987 482 312					1374				
1987 482 380					1805				
315 CDI	03.09→	95	FAN,TW	1987 482 381	2462				
				NAA	1987 482 032	↔ 1666			
	04.06-09.11	110	FKR,TW	1987 482 312	1374				
				FLR,TW	1987 482 029	2522			
	04.06→	110	FMR,TW	1987 482 381	2462				
				1987 482 028	1867				
				1987 482 030	1771				
06.11→	110			1987 482 032	↔ 1666				
				1987 482 032	↔ 1666				
316	09.08→	115							
316 NGT	09.08→	115	FLR,TW	1987 482 029	2522				
				1987 482 381	2462				
			FMR,TW	1987 482 028	1867				
				1987 482 030	1771				
				1987 482 380	1805				
316 CDI	03.09→	120	FAN,TW	1987 482 028	1867				
				1987 482 029	2522				
				1987 482 030	1771				
				1987 482 312	1374				
				1987 482 380	1805				
				1987 482 381	2462				
			NAA,TW	1987 482 032	↔ 1666				
316 NGT	09.08→	115							
318 CDI	04.06-03.09	135	FAN,TW	1987 482 028	1867				
				1987 482 029	2522				
				1987 482 030	1771				
				1987 482 312	1374				
				1987 482 380	1805				



									
319 CDI	03.09→	140	FAN,TW	1 987 482 028	1867				
				1 987 482 029	2522				
				1 987 482 030	1771				
				1 987 482 312	1374				
				1 987 482 380	1805				
				1 987 482 381	2462				
324	04.06→	190	NAA,TW	1 987 482 032	↔ 1666				
				1 987 482 032	↔ 1666				
			FLR,TW	1 987 482 029	2522				
				1 987 482 381	2462				
			FMR,TW	1 987 482 028	1867				
				1 987 482 030	1771				
411 CDI	04.06-09.11	80	FLR,TW	1 987 482 029	2522				
				1 987 482 028	1867				
			FMR,TW	1 987 482 030	1771				
				1 987 482 380	1805				
			413 CDI	03.09→	95	FLR,TW	1 987 482 029	2522	
1 987 482 381	2462								
FMR,TW	1 987 482 028	1867							
	1 987 482 030	1771							
1 987 482 380	1805								
415 CDI	04.06-09.11	110	FLR,TW	1 987 482 029	2522				
				1 987 482 028	1867				
			FMR,TW	1 987 482 030	1771				
				1 987 482 380	1805				
416 CDI	03.09→	120	FLR,TW	1 987 482 029	2522				
				1 987 482 381	2462				
			FMR,TW	1 987 482 028	1867				
				1 987 482 030	1771				
			1 987 482 380	1805					
418 CDI	04.06-03.09	135	FLR,TW	1 987 482 029	2522				
				1 987 482 028	1867				
			FMR,TW	1 987 482 030	1771				
				1 987 482 380	1805				
419 CDI	03.09→	140	FLR,TW	1 987 482 029	2522				
				1 987 482 381	2462				
			FMR,TW	1 987 482 028	1867				
				1 987 482 030	1771				
			1 987 482 380	1805					
424	04.06→	190	FLR,TW	1 987 482 029	2522				
				1 987 482 381	2462				
			FMR,TW	1 987 482 028	1867				
				1 987 482 030	1771				
			1 987 482 380	1805					
509 CDI	04.06-12.09	65	FLR,TW	1 987 482 539	↔ 1399				
				1 987 482 029	2522				
			FMR,TW	1 987 482 028	1867				
				1 987 482 030	1771				
			1 987 482 380	1805					
510 CDI	03.09→	70	FLR,TW	1 987 482 539	↔ 1399				
				1 987 482 029	2522				
			FMR,TW	1 987 482 381	2462				
				1 987 482 028	1867				
			1 987 482 030	1771					
511 CDI	04.06-09.11	80	FLR,TW	1 987 482 539	↔ 1399				
				1 987 482 029	2522				
			FMR,TW	1 987 482 028	1867				
				1 987 482 030	1771				
			1 987 482 380	1805					





◀ MERCEDES-BENZ Sprinter [NCV3]			
513 CDI	03.09→	95	1987 482 539 ↔ 1399
			FLR,TW 1987 482 029 2522
			1987 482 381 2462
			FMR,TW 1987 482 028 1867
			1987 482 030 1771
515 CDI	04.06→	110	1987 482 539 ↔ 1399
			FLR,TW 1987 482 029 2522
			FMR,TW 1987 482 028 1867
			1987 482 030 1771
			1987 482 380 1805
	06.11→	110	FLR,TW 1987 482 381 2462
516	09.08→	115/120	1987 482 539 ↔ 1399
516	09.08→	115/120	FLR,TW 1987 482 029 2522
516 CDI			1987 482 381 2462
516 NGT			FMR,TW 1987 482 028 1867
			1987 482 030 1771
			1987 482 380 1805
516 CDI	03.09→	115/120	1987 482 539 ↔ 1399
516 NGT	09.08→	115/120	1987 482 539 ↔ 1399
518 CDI	04.06-03.09	135	1987 482 539 ↔ 1399
			FLR,TW 1987 482 029 2522
			FMR,TW 1987 482 028 1867
			1987 482 030 1771
			1987 482 380 1805
519 CDI	03.09→	140	1987 482 539 ↔ 1399
			FLR,TW 1987 482 029 2522
			1987 482 381 2462
			FMR,TW 1987 482 028 1867
			1987 482 030 1771
			1987 482 380 1805
524	04.06→	190	1987 482 539 ↔ 1399
			FLR,TW 1987 482 029 2522
			1987 482 381 2462
			FMR,TW 1987 482 028 1867
			1987 482 030 1771
			1987 482 380 1805
209 CDI	04.06-12.09	65	LAB,TW 0 265 009 338 <sup>4</sup>
			RAB,TW 0 265 009 339 <sup>4</sup>
			TW 0 265 009 588 <sup>3</sup>
210 CDI	03.09→	70	LAB,TW 0 265 009 338 <sup>4</sup>
			RAB,TW 0 265 009 339 <sup>4</sup>
			TW 0 265 009 588 <sup>3</sup>
211 CDI	04.06→	80/85	LAB,TW 0 265 009 338 <sup>4</sup>
			RAB,TW 0 265 009 339 <sup>4</sup>
			TW 0 265 009 588 <sup>3</sup>
213 CDI	04.06→	95	LAB,TW 0 265 009 338 <sup>4</sup>
			RAB,TW 0 265 009 339 <sup>4</sup>
			TW 0 265 009 588 <sup>3</sup>
215 CDI	04.06→	110	LAB,TW 0 265 009 338 <sup>4</sup>
			RAB,TW 0 265 009 339 <sup>4</sup>
			TW 0 265 009 588 <sup>3</sup>
216	09.08→	115/120	LAB,TW 0 265 009 338 <sup>4</sup>
216 CDI			RAB,TW 0 265 009 339 <sup>4</sup>
			TW 0 265 009 588 <sup>3</sup>
218 CDI	04.06-03.09	135	LAB,TW 0 265 009 338 <sup>4</sup>
			RAB,TW 0 265 009 339 <sup>4</sup>
			TW 0 265 009 588 <sup>3</sup>
219 CDI	03.09→	140	LAB,TW 0 265 009 338 <sup>4</sup>
			RAB,TW 0 265 009 339 <sup>4</sup>
			TW 0 265 009 588 <sup>3</sup>



		S							
224		04.06→	190				LAB,TW	0 265 009 338 <sup>4</sup>	
							RAB,TW	0 265 009 339 <sup>4</sup>	
							TW	0 265 009 588 <sup>3</sup>	
309 CDI		04.06-12.09	65				LAB,TW	0 265 009 338 <sup>4</sup>	
							RAB,TW	0 265 009 339 <sup>4</sup>	
							TW	0 265 009 588 <sup>3</sup>	
310 CDI		03.09→	70				LAB,TW	0 265 009 338 <sup>4</sup>	
							RAB,TW	0 265 009 339 <sup>4</sup>	
							TW	0 265 009 588 <sup>3</sup>	
311 CDI		04.06-09.11	80				LAB,TW	0 265 009 338 <sup>4</sup>	
							NAA,TW	0 265 009 588 <sup>3</sup>	
							RAB,TW	0 265 009 339 <sup>4</sup>	
		06.11→	85				LAB,TW	0 265 009 338 <sup>4</sup>	
							RAB,TW	0 265 009 339 <sup>4</sup>	
							TW	0 265 009 588 <sup>3</sup>	
313 CDI		04.06-09.11	95				TW	0 265 009 588 <sup>3</sup>	
		04.06→	95				FAN,LAB	0 265 009 338 <sup>4</sup>	
							FAN,RAB	0 265 009 339 <sup>4</sup>	
		03.09→	95				NAA,TW	0 265 009 588 <sup>3</sup>	
315 CDI		04.06-09.11	110				NAA,TW	0 265 009 588 <sup>3</sup>	
		04.06→	110				LAB,TW	0 265 009 338 <sup>4</sup>	
							RAB,TW	0 265 009 339 <sup>4</sup>	
		06.11→	110				TW	0 265 009 588 <sup>3</sup>	
316 316 NGT		09.08→	115				LAB,TW	0 265 009 338 <sup>4</sup>	
							RAB,TW	0 265 009 339 <sup>4</sup>	
							TW	0 265 009 588 <sup>3</sup>	
316 CDI		03.09→	120				FAN,LAB	0 265 009 338 <sup>4</sup>	
							FAN,RAB	0 265 009 339 <sup>4</sup>	
							NAA,TW	0 265 009 588 <sup>3</sup>	
318 CDI		04.06-03.09	135				FAN,LAB	0 265 009 338 <sup>4</sup>	
							FAN,RAB	0 265 009 339 <sup>4</sup>	
							NAA,TW	0 265 009 588 <sup>3</sup>	
319 CDI		03.09→	140				FAN,LAB	0 265 009 338 <sup>4</sup>	
							FAN,RAB	0 265 009 339 <sup>4</sup>	
							NAA,TW	0 265 009 588 <sup>3</sup>	
324		04.06→	190				LAB,TW	0 265 009 338 <sup>4</sup>	
							RAB,TW	0 265 009 339 <sup>4</sup>	
							TW	0 265 009 588 <sup>3</sup>	
411 CDI		04.06-09.11	80				LAB,TW	0 265 009 340 <sup>4</sup>	
							RAB,TW	0 265 009 341 <sup>4</sup>	
							TW	0 265 009 588 <sup>3</sup>	
413 CDI		03.09→	95				LAB,TW	0 265 009 340 <sup>4</sup>	
							RAB,TW	0 265 009 341 <sup>4</sup>	
							TW	0 265 009 588 <sup>3</sup>	
415 CDI		04.06-09.11	110				LAB,TW	0 265 009 340 <sup>4</sup>	
							NAA,TW	0 265 009 588 <sup>3</sup>	
							RAB,TW	0 265 009 341 <sup>4</sup>	
416 CDI		03.09→	120				LAB,TW	0 265 009 340 <sup>4</sup>	
							RAB,TW	0 265 009 341 <sup>4</sup>	
							TW	0 265 009 588 <sup>3</sup>	
418 CDI		04.06-03.09	135				LAB,TW	0 265 009 340 <sup>4</sup>	
							RAB,TW	0 265 009 341 <sup>4</sup>	
							TW	0 265 009 588 <sup>3</sup>	
419 CDI		03.09→	140				LAB,TW	0 265 009 340 <sup>4</sup>	
							RAB,TW	0 265 009 341 <sup>4</sup>	
							TW	0 265 009 588 <sup>3</sup>	
424		04.06→	190				LAB,TW	0 265 009 340 <sup>4</sup>	
							RAB,TW	0 265 009 341 <sup>4</sup>	
							TW	0 265 009 588 <sup>3</sup>	
509 CDI		04.06-12.09	65				LAB,TW	0 265 009 340 <sup>4</sup>	
							RAB,TW	0 265 009 341 <sup>4</sup>	
							TW	0 265 009 588 <sup>3</sup>	





			S							
<b>Mercedes-Benz Sprinter [NCV3]</b>										
510	CDI	03.09→	70					LAB,TW	0 265 009 340 <sup>4</sup>	
								RAB,TW	0 265 009 341 <sup>4</sup>	
								TW	0 265 009 588 <sup>3</sup>	
511	CDI	04.06-09.11	80					LAB,TW	0 265 009 340 <sup>4</sup>	
								RAB,TW	0 265 009 341 <sup>4</sup>	
								TW	0 265 009 588 <sup>3</sup>	
513	CDI	03.09→	95					LAB,TW	0 265 009 340 <sup>4</sup>	
								NAA,TW	0 265 009 588 <sup>3</sup>	
								RAB,TW	0 265 009 341 <sup>4</sup>	
515	CDI	04.06→	110					LAB,TW	0 265 009 340 <sup>4</sup>	
								NAA,TW	0 265 009 588 <sup>3</sup>	
								RAB,TW	0 265 009 341 <sup>4</sup>	
516		09.08→	115					LAB,TW	0 265 009 340 <sup>4</sup>	
516	NGT							RAB,TW	0 265 009 341 <sup>4</sup>	
								TW	0 265 009 588 <sup>3</sup>	
516	CDI	03.09→	120					LAB,TW	0 265 009 340 <sup>4</sup>	
								NAA,TW	0 265 009 588 <sup>3</sup>	
								RAB,TW	0 265 009 341 <sup>4</sup>	
518	CDI	04.06-03.09	135					LAB,TW	0 265 009 340 <sup>4</sup>	
								NAA,TW	0 265 009 588 <sup>3</sup>	
								RAB,TW	0 265 009 341 <sup>4</sup>	
519	CDI	03.09→	140					LAB,TW	0 265 009 340 <sup>4</sup>	
								NAA,TW	0 265 009 588 <sup>3</sup>	
								RAB,TW	0 265 009 341 <sup>4</sup>	
524		04.06→	190					LAB,TW	0 265 009 340 <sup>4</sup>	
								RAB,TW	0 265 009 341 <sup>4</sup>	
								TW	0 265 009 588 <sup>3</sup>	
<b>Sprinter [T1N]</b>										
208	CDI	02.95-05.06	58-60	Komp.Nr. 504015/03/06,	TNK	PEO		0 986 473 250		← 44
208	D			Komp.Nr. 504015/08/50				0 986 474 250		→ 44
				Komp.Nr. 504015/04/07,	TEJ,TNK			0 986 473 249		← 60
				Komp.Nr. 504025/28/29				0 986 474 249		→ 60
				Komp.Nr. 504015/06/08,	TNK	BSY		0 204 102 912		← 45
				Komp.Nr. 504015/15				0 986 473 231		
								0 204 102 913		→ 45
								0 986 474 231		
				Komp.Nr. 504025/13	TNK	ATE		0 986 473 353		← 51,92
								0 986 474 353		→ 51,92
210	D	01.97-03.00	75	Komp.Nr. 504015/03/06,	TNK	PEO		0 986 473 250		← 44
				Komp.Nr. 504015/08/50				0 986 474 250		→ 44
				Komp.Nr. 504015/04/07,	TEJ,TNK			0 986 473 249		← 60
				Komp.Nr. 504025/28/29				0 986 474 249		→ 60
				Komp.Nr. 504015/06/08,	TNK	BSY		0 204 102 912		← 45
				Komp.Nr. 504015/15				0 986 473 231		
								0 204 102 913		→ 45
								0 986 474 231		
				Komp.Nr. 504025/13	TNK	ATE		0 986 473 353		← 51,92
								0 986 474 353		→ 51,92
211	CDI	04.00-05.06	80	Komp.Nr. 504015/03/06,	TNK	PEO		0 986 473 250		← 44
				Komp.Nr. 504015/08/50				0 986 474 250		→ 44
				Komp.Nr. 504015/04/07,	TEJ,TNK			0 986 473 249		← 60
				Komp.Nr. 504025/28/29				0 986 474 249		→ 60
				Komp.Nr. 504015/06/08,	TNK	BSY		0 204 102 912		← 45
				Komp.Nr. 504015/15				0 986 473 231		
								0 204 102 913		→ 45
								0 986 474 231		
				Komp.Nr. 504025/13	TNK	ATE		0 986 473 353		← 51,92
								0 986 474 353		→ 51,92

		S								
<b>212 D</b>	02.95-03.00	90	Komp.Nr. 504015/03/06, Komp.Nr. 504015/08/50	TNK	PEO	0 986 473 250		← 44		
						0 986 474 250		→ 44		
			Komp.Nr. 504015/04/07, Komp.Nr. 504025/28/29	TEJ,TNK	0 986 473 249		← 60			
					0 986 474 249		→ 60			
			Komp.Nr. 504015/06/08, Komp.Nr. 504015/15	TNK	BSY	0 204 102 912		← 45		
						0 986 473 231				
						0 204 102 913		→ 45		
			Komp.Nr. 504025/13	TNK	ATE	0 986 473 353		← 51,92		
						0 986 474 353		→ 51,92		
			<b>213 CDI</b>	04.00-05.06	95	Komp.Nr. 504015/03/06, Komp.Nr. 504015/08/50	TNK	PEO	0 986 473 250	
0 986 474 250		→ 44								
Komp.Nr. 504015/04/07, Komp.Nr. 504025/28/29	TEJ,TNK	0 986 473 249					← 60			
		0 986 474 249					→ 60			
Komp.Nr. 504015/06/08, Komp.Nr. 504015/15	TNK	BSY				0 204 102 912		← 45		
						0 986 473 231				
						0 204 102 913		→ 45		
Komp.Nr. 504025/13	TNK	ATE				0 986 473 353		← 51,92		
						0 986 474 353		→ 51,92		
<b>214</b> <b>214 NGT</b>	02.95-05.06	95/ 105-108				Komp.Nr. 504015/03/06, Komp.Nr. 504015/08/50	TNK	PEO	0 986 473 250	
			0 986 474 250		→ 44					
			Komp.Nr. 504015/04/07, Komp.Nr. 504025/28/29	TEJ,TNK	0 986 473 249		← 60			
					0 986 474 249		→ 60			
			Komp.Nr. 504015/06/08, Komp.Nr. 504015/15	TNK	BSY	0 204 102 912		← 45		
						0 986 473 231				
						0 204 102 913		→ 45		
			Komp.Nr. 504025/13	TNK	ATE	0 986 473 353		← 51,92		
						0 986 474 353		→ 51,92		
			<b>216 CDI</b>	04.00-05.06	115	Komp.Nr. 504015/03/06, Komp.Nr. 504015/08/50	TNK	PEO	0 986 473 250	
0 986 474 250		→ 44								
Komp.Nr. 504015/04/07, Komp.Nr. 504025/28/29	TEJ,TNK	0 986 473 249					← 60			
		0 986 474 249					→ 60			
Komp.Nr. 504015/06/08, Komp.Nr. 504015/15	TNK	BSY				0 204 102 912		← 45		
						0 986 473 231				
						0 204 102 913		→ 45		
Komp.Nr. 504025/13	TNK	ATE				0 986 473 353		← 51,92		
						0 986 474 353		→ 51,92		
<b>308 CDI</b> <b>308 D</b> <b>308 D James Cook</b>	02.95-05.06	58/60				Komp.Nr. 504015/03/06, Komp.Nr. 504015/08/50	TNK	PEO	0 986 473 250	
			0 986 474 250		→ 44					
			Komp.Nr. 504015/04/07, Komp.Nr. 504025/28/29	TEJ,TNK	0 986 473 249		← 60			
					0 986 474 249		→ 60			
			Komp.Nr. 504015/06/08, Komp.Nr. 504015/15	TNK	BSY	0 204 102 912		← 45		
						0 986 473 231				
						0 204 102 913		→ 45		
			Komp.Nr. 504025/13	TNK	ATE	0 986 473 353		← 51,92		
						0 986 474 353		→ 51,92		
			<b>310 D</b> <b>310 D James Cook</b>	01.97-03.00	75	Komp.Nr. 504015/03/06, Komp.Nr. 504015/08/50	TNK	PEO	0 986 473 250	
0 986 474 250		→ 44								
Komp.Nr. 504015/04/07, Komp.Nr. 504025/28/29	TEJ,TNK	0 986 473 249					← 60			
		0 986 474 249					→ 60			
Komp.Nr. 504015/06/08, Komp.Nr. 504015/15	TNK	BSY				0 204 102 912		← 45		
						0 986 473 231				
						0 204 102 913		→ 45		
Komp.Nr. 504025/13	TNK	ATE				0 986 473 353		← 51,92		
						0 986 474 353		→ 51,92		
<b>311 CDI</b>	04.00-05.06	80				Komp.Nr. 504015/03/06, Komp.Nr. 504015/08/50	TNK	PEO	0 986 473 250	
			0 986 474 250		→ 44					



			S										
◀ MERCEDES-BENZ Sprinter [T1N]													
311 CDI	04.00-05.06	80	Komp.Nr. 504015/04/07, Komp.Nr. 504025/28/29	TEJ,TNK						0986 473 249  ← 60			
										0986 474 249  → 60			
										Komp.Nr. 504015/06/08, Komp.Nr. 504015/15	TNK	BSY	0204 102 912 ← 45
													0986 473 231
										Komp.Nr. 504025/13	TNK	ATE	0204 102 913 → 45
													0986 474 231
										0986 473 353  ← 51,92			
										0986 474 353  → 51,92			
312 D 312 D James Cook	02.95-03.00	90	Komp.Nr. 504015/03/06, Komp.Nr. 504015/08/50	TNK	PEO					0986 473 250  ← 44			
										0986 474 250  → 44			
										Komp.Nr. 504015/04/07, Komp.Nr. 504025/28/29	TEJ,TNK		0986 473 249  ← 60
													0986 474 249  → 60
										Komp.Nr. 504015/06/08, Komp.Nr. 504015/15	TNK	BSY	0204 102 912 ← 45
													0986 473 231
										Komp.Nr. 504025/13	TNK	ATE	0204 102 913 → 45
													0986 474 231
0986 473 353  ← 51,92													
0986 474 353  → 51,92													
313 CDI 313 CDI 4x4	04.00-05.06	95	Komp.Nr. 504015/03/06, Komp.Nr. 504015/08/50	TNK	PEO					0986 473 250  ← 44			
										0986 474 250  → 44			
										Komp.Nr. 504015/04/07, Komp.Nr. 504025/28/29	TEJ,TNK		0986 473 249  ← 60
													0986 474 249  → 60
										Komp.Nr. 504015/06/08, Komp.Nr. 504015/15	TNK	BSY	0204 102 912 ← 45
													0986 473 231
										Komp.Nr. 504025/13	TNK	ATE	0204 102 913 → 45
													0986 474 231
0986 473 353  ← 51,92													
0986 474 353  → 51,92													
314 314 James Cook 314 NGT	02.95-05.06	95/ 105-108	Komp.Nr. 504015/03/06, Komp.Nr. 504015/08/50	TNK	PEO					0986 473 250  ← 44			
										0986 474 250  → 44			
										Komp.Nr. 504015/04/07, Komp.Nr. 504025/28/29	TEJ,TNK		0986 473 249  ← 60
													0986 474 249  → 60
										Komp.Nr. 504015/06/08, Komp.Nr. 504015/15	TNK	BSY	0204 102 912 ← 45
													0986 473 231
										Komp.Nr. 504025/13	TNK	ATE	0204 102 913 → 45
													0986 474 231
0986 473 353  ← 51,92													
0986 474 353  → 51,92													
316 CDI 316 CDI James Cook	04.00-05.06	115	Komp.Nr. 504015/03/06, Komp.Nr. 504015/08/50	TNK	PEO					0986 473 250  ← 44			
										0986 474 250  → 44			
										Komp.Nr. 504015/04/07, Komp.Nr. 504025/28/29	TEJ,TNK		0986 473 249  ← 60
													0986 474 249  → 60
										Komp.Nr. 504015/06/08, Komp.Nr. 504015/15	TNK	BSY	0204 102 912 ← 45
													0986 473 231
										Komp.Nr. 504025/13	TNK	ATE	0204 102 913 → 45
													0986 474 231
0986 473 353  ← 51,92													
0986 474 353  → 51,92													
408 CDI 408 D	02.95-05.06	58/60								ATE 0986 473 353  ← 51,92			
										0986 474 353  → 51,92			
										BSY	0204 102 912 ← 45		
											0986 473 231		
										PEO	0204 102 913 → 45		
											0986 474 231		
										0986 473 250  ← 44			
										0986 474 250  → 44			
410 D	01.97-03.00	75								ATE 0986 473 353  ← 51,92			
										0986 474 353  → 51,92			
										BSY	0204 102 912 ← 45		
											0986 473 231		
											0204 102 913 → 45		
											0986 474 231		



		S								
<b>410 D</b>		01.97-03.00	75					PEO	0 986 473 250	44
									0 986 474 250	44
<b>411 CDI</b>		04.00-05.06	80					ATE	0 986 473 353	51,92
									0 986 474 353	51,92
								BSY	0 204 102 912	45
									0 986 473 231	
									0 204 102 913	45
									0 986 474 231	
								PEO	0 986 473 250	44
									0 986 474 250	44
<b>412 D</b>		02.95-03.00	90					ATE	0 986 473 353	51,92
									0 986 474 353	51,92
								BSY	0 204 102 912	45
									0 986 473 231	
									0 204 102 913	45
									0 986 474 231	
								PEO	0 986 473 250	44
									0 986 474 250	44
<b>413 CDI</b>		04.00-05.06	95					ATE	0 986 473 353	51,92
									0 986 474 353	51,92
								BSY	0 204 102 912	45
									0 986 473 231	
									0 204 102 913	45
									0 986 474 231	
								PEO	0 986 473 250	44
									0 986 474 250	44
<b>414</b>		02.95-05.06	105-108					ATE	0 986 473 353	51,92
									0 986 474 353	51,92
								BSY	0 204 102 912	45
									0 986 473 231	
									0 204 102 913	45
									0 986 474 231	
								PEO	0 986 473 250	44
									0 986 474 250	44
<b>416 CDI</b>		04.00-05.06	115					ATE	0 986 473 353	51,92
									0 986 474 353	51,92
								BSY	0 204 102 912	45
									0 986 473 231	
									0 204 102 913	45
									0 986 474 231	
								PEO	0 986 473 250	44
									0 986 474 250	44
	<b>208 CDI</b>	02.95-05.06	58-60						0 986 473 363	44,93
	<b>208 D</b>								0 986 474 363	44,93
	<b>210 D</b>	01.97-03.00	75						0 986 473 363	44,93
									0 986 474 363	44,93
	<b>211 CDI</b>	04.00-05.06	80						0 986 473 363	44,93
									0 986 474 363	44,93
	<b>212 D</b>	02.95-03.00	90						0 986 473 363	44,93
									0 986 474 363	44,93
	<b>213 CDI</b>	04.00-05.06	95						0 986 473 363	44,93
									0 986 474 363	44,93
	<b>214</b>	02.95-05.06	95/105-108						0 986 473 363	44,93
	<b>214 NGT</b>								0 986 474 363	44,93
	<b>216 CDI</b>	04.00-05.06	115						0 986 473 363	44,93
									0 986 474 363	44,93
	<b>308 CDI</b>	04.00-05.06	60			Hintera. →027033,741.409, TW			0 986 473 359	52
						Komp.Nr. 504025/02			0 986 474 359	52



◀ MERCEDES-BENZ Sprinter [T1N]														
308 CDI	04.00-05.06	60	Hintera. 741.408/411	ATE	0986 473 353		← 51,92	1987 470 506 <sup>8</sup>						
					0986 474 353		→ 51,92	1987 470 506 <sup>8</sup>						
					BSY	0204 102 918		← 52						
						0986 473 359								
					0204 102 919		→ 52							
					0986 474 359									
					Hintera. 741.409, Komp.Nr. 504025/13							1987 470 506 <sup>8</sup>		
					Hintera. 027034→, 741.409, Komp.Nr. 504025/02				0986 473 353		← 51,92			
									0986 474 353		→ 51,92			
308 D 308 D James Cook	02.95-03.00	58	BSB	ATE	0986 473 353		← 51,92	1987 470 506 <sup>8</sup>						
					0986 474 353		→ 51,92	1987 470 506 <sup>8</sup>						
				BSY	0204 102 918		← 52							
					0986 473 359									
					0204 102 919		→ 52							
					0986 474 359									
				BSB	BSY,	0986 473 359		← 52						
						FDO	0986 474 359		→ 52					
					BSY,	0986 473 359		← 52						
						JUR	0986 474 359		→ 52					
				BSB,TEJ	0986 473 353		← 51,92							
					0986 474 353		→ 51,92							
				310 D 310 D James Cook	01.97-03.00	75	BSB	ATE	0986 473 353		← 51,92	1987 470 506 <sup>8</sup>		
									0986 474 353		→ 51,92	1987 470 506 <sup>8</sup>		
								BSY	0204 102 918		← 52			
									0986 473 359					
0204 102 919		→ 52												
0986 474 359														
BSB	BSY,	0986 473 359						← 52						
		FDO	0986 474 359						→ 52					
	BSY,	0986 473 359						← 52						
		JUR	0986 474 359						→ 52					
BSB,TEJ	0986 473 353		← 51,92											
	0986 474 353		→ 51,92											
311 CDI	04.00-05.06	80	Hintera. →027033, 741.409, TW Komp.Nr. 504025/02	ATE	0986 473 353		← 51,92	1987 470 506 <sup>8</sup>						
					0986 474 353		→ 51,92	1987 470 506 <sup>8</sup>						
				BSY	0204 102 918		← 52							
					0986 473 359									
					0204 102 919		→ 52							
					0986 474 359									
				Hintera. 741.409, Komp.Nr. 504025/13							1987 470 506 <sup>8</sup>			
				Hintera. 027034→, 741.409, Komp.Nr. 504025/02				0986 473 353		← 51,92				
					0986 474 353		→ 51,92							
	08.02-05.06	80	BSB	ATE	0986 473 353		← 51,92	1987 470 506 <sup>8</sup>						
					0986 474 353		→ 51,92	1987 470 506 <sup>8</sup>						
				BSY	0204 102 918		← 52							
					0986 473 359									
					0204 102 919		→ 52							
					0986 474 359									
BSB				BSY,	0986 473 359		← 52							
					FDO	0986 474 359		→ 52						
	BSY,	0986 473 359		← 52										
		JUR	0986 474 359		→ 52									
BSB,TEJ	0986 473 353		← 51,92											
	0986 474 353		→ 51,92											
312 D 312 D James Cook	02.95-03.00	90	BSB	ATE	0986 473 353		← 51,92	1987 470 506 <sup>8</sup>						
					0986 474 353		→ 51,92	1987 470 506 <sup>8</sup>						
				BSY	0204 102 918		← 52							
					0986 473 359									
					0204 102 919		→ 52							
					0986 474 359									











			S							
<b>312 D</b> 312 D James Cook	02.95-03.00	90	BSB	BSY,	0 986 473 359		←	52		
				FDO	0 986 474 359		→	52		
				BSY,	0 986 473 359		←	52		
				JUR	0 986 474 359		→	52		
				BSB,TEJ	0 986 473 353		←	51,92		
					0 986 474 353		→	51,92		
<b>313 CDI</b> 313 CDI 4x4	04.00-05.06	95	BSB	ATE	0 986 473 353		←	51,92	1 987 470 506 <sup>B</sup>	
					0 986 474 353		→	51,92	1 987 470 506 <sup>B</sup>	
			BSY	0 204 102 918		←	52			
				0 986 473 359						
				0 204 102 919		→	52			
				0 986 474 359						
			BSB	BSY,	0 986 473 359		←	52		
				FDO	0 986 474 359		→	52		
				BSY,	0 986 473 359		←	52		
				JUR	0 986 474 359		→	52		
BSB,TEJ	0 986 473 353			←	51,92					
	0 986 474 353			→	51,92					
<b>314</b> 314 James Cook 314 NGT	02.95-05.06	95/105-108	BSB	ATE	0 986 473 353		←	51,92	1 987 470 506 <sup>B</sup>	
					0 986 474 353		→	51,92	1 987 470 506 <sup>B</sup>	
			BSY	0 204 102 918		←	52			
				0 986 473 359						
				0 204 102 919		→	52			
				0 986 474 359						
			BSB	BSY,	0 986 473 359		←	52		
				FDO	0 986 474 359		→	52		
				BSY,	0 986 473 359		←	52		
				JUR	0 986 474 359		→	52		
BSB,TEJ	0 986 473 353			←	51,92					
	0 986 474 353			→	51,92					
<b>316 CDI</b> 316 CDI James Cook	04.00-05.06	115	BSB	ATE	0 986 473 353		←	51,92	1 987 470 506 <sup>B</sup>	
					0 986 474 353		→	51,92	1 987 470 506 <sup>B</sup>	
			BSY	0 204 102 918		←	52			
				0 986 473 359						
				0 204 102 919		→	52			
				0 986 474 359						
			BSB	BSY,	0 986 473 359		←	52		
				FDO	0 986 474 359		→	52		
				BSY,	0 986 473 359		←	52		
				JUR	0 986 474 359		→	52		
BSB,TEJ	0 986 473 353			←	51,92					
	0 986 474 353			→	51,92					
<b>408 CDI</b> 408 D	02.95-05.06	58/60	TNK	WAB	0 986 473 250		←	44		
					0 986 474 250		→	44		
			TNK	BSY	0 204 102 912		←	45		
					0 986 473 231					
					0 204 102 913		→	45		
					0 986 474 231					
			WAB	0 986 473 250		←	44			
				0 986 474 250		→	44			
				BSY	0 204 102 912		←	45		
					0 986 473 231					
	0 204 102 913			→	45					
	0 986 474 231									
<b>410 D</b>	01.97-03.00	75	TNK	WAB	0 986 473 250		←	44		
					0 986 474 250		→	44		
			TNK	BSY	0 204 102 912		←	45		
					0 986 473 231					
					0 204 102 913		→	45		
					0 986 474 231					
			WAB	0 986 473 250		←	44			
				0 986 474 250		→	44			
				BSY	0 204 102 912		←	45		
					0 986 473 231					
	0 204 102 913			→	45					
	0 986 474 231									
<b>411 CDI</b>	04.00-05.06	80	TNK	WAB	0 986 473 250		←	44		
					0 986 474 250		→	44		
			TNK	BSY	0 204 102 912		←	45		
					0 986 473 231					
					0 204 102 913		→	45		
					0 986 474 231					
			WAB	0 986 473 250		←	44			
				0 986 474 250		→	44			
				BSY	0 204 102 912		←	45		
					0 986 473 231					
	0 204 102 913			→	45					
	0 986 474 231									
<b>412 D</b>	02.95-03.00	90	TNK	WAB	0 986 473 250		←	44		
					0 986 474 250		→	44		



		S													
◀ MERCEDES-BENZ Sprinter [T1N]															
412 D	02.95-03.00	90	Komp.Nr. 504015/92	TNK	BSY	0 204 102 912		←	45						
						0 986 473 231									
						0 204 102 913		→	45						
413 CDI	04.00-05.06	95	Komp.Nr. 504015/03	TNK	WAB	0 986 473 250		←	44						
						0 986 474 250		→	44						
			<del>Komp.Nr. 504015/92</del>	TNK	BSY	0 204 102 912		←	45						
						0 986 473 231									
						0 204 102 913		→	45						
						0 986 474 231									
414	02.95-05.06	105-108	Komp.Nr. 504015/03	TNK	WAB	0 986 473 250		←	44						
						0 986 474 250		→	44						
			<del>Komp.Nr. 504015/92</del>	TNK	BSY	0 204 102 912		←	45						
						0 986 473 231									
						0 204 102 913		→	45						
						0 986 474 231									
416 CDI	04.00-05.06	115	Komp.Nr. 504015/03	TNK	WAB	0 986 473 250		←	44						
						0 986 474 250		→	44						
			<del>Komp.Nr. 504015/92</del>	TNK	BSY	0 204 102 912		←	45						
						0 986 473 231									
						0 204 102 913		→	45						
						0 986 474 231									
208 CDI	04.00-05.06	60				BDS,R30	1 987 477 856		1415						
						<del>BDS,R30</del>	1 987 477 853		1435						
						Komp.Nr. 500038/02	R35,TNK	1 987 477 854		1990					
						Komp.Nr. 500038/03	R40,TNK	1 987 477 855		2460					
						Komp.Nr. 504013/01	TNK	1 987 477 852		1513					
						Komp.Nr. 504013/02	TNK	1 987 477 858	←	1525					
								1 987 477 859	→	1526					
						Komp.Nr. 504013/03	TNK	1 987 477 702	→	1680					
								1 987 477 703	←	1680					
						Komp.Nr. 504013/04	TNK	1 987 477 857		1545					
						Komp.Nr. 504013/05	TNK	1 987 477 860	←	1570					
								1 987 477 861	→	1565					
						208 D	02.95-03.00	58-60				MBB	1 987 477 118	→	1845
													1 987 477 119	←	1845
	BDS,R30	1 987 477 856		1415											
<del>BDS,R30</del>	1 987 477 853		1435												
Komp.Nr. 500038/02	R35,TNK	1 987 477 854		1990											
Komp.Nr. 500038/03	R40,TNK	1 987 477 855		2460											
Komp.Nr. 504013/01	TNK	1 987 477 852		1513											
Komp.Nr. 504013/02	TNK	1 987 477 858	←	1525											
		1 987 477 859	→	1526											
Komp.Nr. 504013/03	TNK	1 987 477 702	→	1680											
		1 987 477 703	←	1680											
Komp.Nr. 504013/04	TNK	1 987 477 857		1545											
Komp.Nr. 504013/05	TNK	1 987 477 860	←	1570											
		1 987 477 861	→	1565											
210 D	01.97-03.00	75				BDS,R30	1 987 477 856		1415						
						<del>BDS,R30</del>	1 987 477 853		1435						
						Komp.Nr. 500038/02	R35,TNK	1 987 477 854		1990					
						Komp.Nr. 500038/03	R40,TNK	1 987 477 855		2460					
						Komp.Nr. 504013/01	TNK	1 987 477 852		1513					
						Komp.Nr. 504013/02	TNK	1 987 477 858	←	1525					
								1 987 477 859	→	1526					
						Komp.Nr. 504013/03	TNK	1 987 477 702	→	1680					
								1 987 477 703	←	1680					
						Komp.Nr. 504013/04	TNK	1 987 477 857		1545					
						Komp.Nr. 504013/05	TNK	1 987 477 860	←	1570					
								1 987 477 861	→	1565					



																
<b>211 CDI</b>		04.00-05.06	80				BDS,R30	1 987 477 856	1415							
							<del>BDS,R30</del>	1 987 477 853	1435							
							Komp.Nr. 500038/02	R35,TNK	1 987 477 854	1990						
							Komp.Nr. 500038/03	R40,TNK	1 987 477 855	2460						
							Komp.Nr. 504013/01	TNK	1 987 477 852	↔ 1513						
							Komp.Nr. 504013/02	TNK	1 987 477 858	← 1525						
									1 987 477 859	→ 1526						
							Komp.Nr. 504013/03	TNK	1 987 477 702	→ 1680						
									1 987 477 703	← 1680						
							Komp.Nr. 504013/04	TNK	1 987 477 857	↔ 1545						
							Komp.Nr. 504013/05	TNK	1 987 477 860	← 1570						
									1 987 477 861	→ 1565						
							<b>212 D</b>		02.95-03.00	90				MBB	1 987 477 118	→ 1845
															1 987 477 119	← 1845
	BDS,R30	1 987 477 856	1415													
	<del>BDS,R30</del>	1 987 477 853	1435													
Komp.Nr. 500038/02	R35,TNK	1 987 477 854	1990													
Komp.Nr. 500038/03	R40,TNK	1 987 477 855	2460													
Komp.Nr. 504013/01	TNK	1 987 477 852	↔ 1513													
Komp.Nr. 504013/02	TNK	1 987 477 858	← 1525													
		1 987 477 859	→ 1526													
Komp.Nr. 504013/03	TNK	1 987 477 702	→ 1680													
		1 987 477 703	← 1680													
Komp.Nr. 504013/04	TNK	1 987 477 857	↔ 1545													
Komp.Nr. 504013/05	TNK	1 987 477 860	← 1570													
		1 987 477 861	→ 1565													
<b>213 CDI</b>		04.00-05.06	95				BDS,R30	1 987 477 856	1415							
							<del>BDS,R30</del>	1 987 477 853	1435							
							Komp.Nr. 500038/02	R35,TNK	1 987 477 854	1990						
							Komp.Nr. 500038/03	R40,TNK	1 987 477 855	2460						
							Komp.Nr. 504013/01	TNK	1 987 477 852	↔ 1513						
							Komp.Nr. 504013/02	TNK	1 987 477 858	← 1525						
									1 987 477 859	→ 1526						
							Komp.Nr. 504013/03	TNK	1 987 477 702	→ 1680						
									1 987 477 703	← 1680						
							Komp.Nr. 504013/04	TNK	1 987 477 857	↔ 1545						
							Komp.Nr. 504013/05	TNK	1 987 477 860	← 1570						
									1 987 477 861	→ 1565						
							<b>214</b>		02.95-03.00	105				MBB	1 987 477 118	→ 1845
															1 987 477 119	← 1845
	BDS,R30	1 987 477 856	1415													
	<del>BDS,R30</del>	1 987 477 853	1435													
Komp.Nr. 500038/02	R35,TNK	1 987 477 854	1990													
Komp.Nr. 500038/03	R40,TNK	1 987 477 855	2460													
Komp.Nr. 504013/01	TNK	1 987 477 852	↔ 1513													
Komp.Nr. 504013/02	TNK	1 987 477 858	← 1525													
		1 987 477 859	→ 1526													
Komp.Nr. 504013/03	TNK	1 987 477 702	→ 1680													
		1 987 477 703	← 1680													
Komp.Nr. 504013/04	TNK	1 987 477 857	↔ 1545													
Komp.Nr. 504013/05	TNK	1 987 477 860	← 1570													
		1 987 477 861	→ 1565													
04.00-05.06		105-108					BDS,R30	1 987 477 856	1415							
							<del>BDS,R30</del>	1 987 477 853	1435							
							Komp.Nr. 500038/02	R35,TNK	1 987 477 854	1990						
							Komp.Nr. 500038/03	R40,TNK	1 987 477 855	2460						
							Komp.Nr. 504013/01	TNK	1 987 477 852	↔ 1513						
							Komp.Nr. 504013/02	TNK	1 987 477 858	← 1525						
									1 987 477 859	→ 1526						
Komp.Nr. 504013/03	TNK	1 987 477 702	→ 1680													
		1 987 477 703	← 1680													
Komp.Nr. 504013/04	TNK	1 987 477 857	↔ 1545													





		S							
◀ MERCEDES-BENZ Sprinter [T1N]									
<b>214</b>	04.00-05.06	105-108	Komp.Nr. 504013/05	TNK	1987 477 860	← 1570			
					1987 477 861	→ 1565			
<b>214 NGT</b>	04.00-05.06	95		BDS,R30	1987 477 856	1415			
				<del>BDS,R30</del>	1987 477 853	1435			
			Komp.Nr. 500038/02	R35,TNK	1987 477 854	1990			
			Komp.Nr. 500038/03	R40,TNK	1987 477 855	2460			
			Komp.Nr. 504013/01	TNK	1987 477 852	↔ 1513			
			Komp.Nr. 504013/02	TNK	1987 477 858	← 1525			
					1987 477 859	→ 1526			
			Komp.Nr. 504013/03	TNK	1987 477 702	→ 1680			
					1987 477 703	← 1680			
			Komp.Nr. 504013/04	TNK	1987 477 857	↔ 1545			
			Komp.Nr. 504013/05	TNK	1987 477 860	← 1570			
					1987 477 861	→ 1565			
<b>216 CDI</b>	04.00-05.06	115		BDS,R30	1987 477 856	1415			
				<del>BDS,R30</del>	1987 477 853	1435			
			Komp.Nr. 500038/02	R35,TNK	1987 477 854	1990			
			Komp.Nr. 500038/03	R40,TNK	1987 477 855	2460			
			Komp.Nr. 504013/01	TNK	1987 477 852	↔ 1513			
			Komp.Nr. 504013/02	TNK	1987 477 858	← 1525			
					1987 477 859	→ 1526			
			Komp.Nr. 504013/03	TNK	1987 477 702	→ 1680			
					1987 477 703	← 1680			
			Komp.Nr. 504013/04	TNK	1987 477 857	↔ 1545			
			Komp.Nr. 504013/05	TNK	1987 477 860	← 1570			
					1987 477 861	→ 1565			
<b>308 CDI</b>	04.00-05.06	60		R30,TW	1987 477 853	1435			
					1987 477 856	1415			
				R35,TW	1987 477 854	1990			
					1987 482 131	1970			
				R40,TW	1987 477 855	2460			
					1987 477 880	2440			
			Komp.Nr. 504013/01	TNK	1987 477 852	↔ 1513			
			Komp.Nr. 504013/04	TNK	1987 477 857	↔ 1545			
<b>308 D</b>	02.95-03.00	58	Hintera. 741.408,	TNK	1987 477 857	↔ 1545			
			Komp.Nr. 504013/04						
<b>308 D James Cook</b>	02.95-03.00	58	Hintera. 741.408,	TNK	1987 477 857	↔ 1545			
			Komp.Nr. 504013/04						
<b>308 D</b>	02.95-03.00	58		BDS,R30	1987 477 856	1415			
<b>308 D James Cook</b>				<del>BDS,R30</del>	1987 477 853	1435			
			Komp.Nr. 500038/02	R35,TNK	1987 477 854	1990			
			Komp.Nr. 500038/03	R40,TNK	1987 477 855	2460			
			Komp.Nr. 500038/04	R35,TNK	1987 482 131	1970			
			Komp.Nr. 500038/05	R40,TNK	1987 477 880	2440			
			Komp.Nr. 504013/02	TNK	1987 477 858	← 1525			
					1987 477 859	→ 1526			
			Komp.Nr. 504013/05	TNK	1987 477 860	← 1570			
					1987 477 861	→ 1565			
<b>310 D</b>	01.97-03.00	75	Hintera. 741.408,	TNK	1987 477 857	↔ 1545			
			Komp.Nr. 504013/04						
<b>310 D James Cook</b>	01.97-03.00	75	Hintera. 741.408,	TNK	1987 477 857	↔ 1545			
			Komp.Nr. 504013/04						
<b>310 D</b>	01.97-03.00	75		BDS,R30	1987 477 856	1415			
<b>310 D James Cook</b>				<del>BDS,R30</del>	1987 477 853	1435			
			Komp.Nr. 500038/02	R35,TNK	1987 477 854	1990			
			Komp.Nr. 500038/03	R40,TNK	1987 477 855	2460			
			Komp.Nr. 500038/04	R35,TNK	1987 482 131	1970			
			Komp.Nr. 500038/05	R40,TNK	1987 477 880	2440			
			Komp.Nr. 504013/02	TNK	1987 477 858	← 1525			
					1987 477 859	→ 1526			
			Komp.Nr. 504013/05	TNK	1987 477 860	← 1570			
					1987 477 861	→ 1565			



		S													
311 CDI	04.00-05.06	80			R30,TW	1 987 477 853	1435								
						1 987 477 856	1415								
						R35,TW	1 987 477 854	1990							
							1 987 482 131	1970							
							1 987 477 855	2460							
						R40,TW	1 987 477 880	2440							
							Komp.Nr. 504013/01	TNK	1 987 477 852	↔ 1513					
						Komp.Nr. 504013/04	TNK	1 987 477 857	↔ 1545						
						08.02-05.06	80				BDS,R30	1 987 477 856	1415		
											<del>BDS,R30</del>	1 987 477 853	1435		
Hintera. 741.408,	TNK	1 987 477 857	↔ 1545												
Komp.Nr. 504013/04															
Komp.Nr. 500038/02	R35,TNK	1 987 477 854	1990												
Komp.Nr. 500038/03	R40,TNK	1 987 477 855	2460												
Komp.Nr. 500038/04	R35,TNK	1 987 482 131	1970												
Komp.Nr. 500038/05	R40,TNK	1 987 477 880	2440												
Komp.Nr. 504013/02	TNK	1 987 477 858	← 1525												
		1 987 477 859	→ 1526												
Komp.Nr. 504013/05	TNK	1 987 477 860	← 1570												
		1 987 477 861	→ 1565												
312 D	02.95-03.00	90		Hintera. 741.408,	TNK	1 987 477 857	↔ 1545								
Komp.Nr. 504013/04															
312 D James Cook	02.95-03.00	90		Hintera. 741.408,	TNK	1 987 477 857	↔ 1545								
Komp.Nr. 504013/04															
312 D	02.95-03.00	90			BDS,R30	1 987 477 856	1415								
312 D James Cook					<del>BDS,R30</del>	1 987 477 853	1435								
Komp.Nr. 500038/02					R35,TNK	1 987 477 854	1990								
						1 987 477 855	2460								
						1 987 482 131	1970								
						1 987 477 880	2440								
						1 987 477 858	← 1525								
						1 987 477 859	→ 1526								
Komp.Nr. 504013/05					TNK	1 987 477 860	← 1570								
						1 987 477 861	→ 1565								
313 CDI	04.00-05.06	95		Hintera. 741.408,	TNK	1 987 477 857	↔ 1545								
Komp.Nr. 504013/04															
313 CDI 4x4	08.02-05.06	95		Hintera. 741.408,	TNK	1 987 477 857	↔ 1545								
Komp.Nr. 504013/04															
313 CDI 313 CDI 4x4	04.00-05.06	95			BDS,R30	1 987 477 856	1415								
						<del>BDS,R30</del>	1 987 477 853	1435							
						Komp.Nr. 500038/02	R35,TNK	1 987 477 854	1990						
						Komp.Nr. 500038/03	R40,TNK	1 987 477 855	2460						
						Komp.Nr. 500038/04	R35,TNK	1 987 482 131	1970						
						Komp.Nr. 500038/05	R40,TNK	1 987 477 880	2440						
						Komp.Nr. 504013/02	TNK	1 987 477 858	← 1525						
								1 987 477 859	→ 1526						
						Komp.Nr. 504013/05	TNK	1 987 477 860	← 1570						
								1 987 477 861	→ 1565						
314	02.95-05.06	95/ 105-108		Hintera. 741.408,	TNK	1 987 477 857	↔ 1545								
Komp.Nr. 504013/04															
314 314 James Cook 314 NGT	02.95-05.06	95/ 105-108			BDS,R30	1 987 477 856	1415								
						<del>BDS,R30</del>	1 987 477 853	1435							
						Komp.Nr. 500038/02	R35,TNK	1 987 477 854	1990						
						Komp.Nr. 500038/03	R40,TNK	1 987 477 855	2460						
						Komp.Nr. 500038/04	R35,TNK	1 987 482 131	1970						
						Komp.Nr. 500038/05	R40,TNK	1 987 477 880	2440						
						Komp.Nr. 504013/02	TNK	1 987 477 858	← 1525						
								1 987 477 859	→ 1526						
						Komp.Nr. 504013/05	TNK	1 987 477 860	← 1570						
								1 987 477 861	→ 1565						
314 James Cook	02.95-05.06	95/ 105-108		Hintera. 741.408,	TNK	1 987 477 857	↔ 1545								
Komp.Nr. 504013/04															



		S							
<b>◀ MERCEDES-BENZ Sprinter [T1N]</b>									
<b>314</b>	NGT	04.00-05.06	95/ 105-108	Hintera. 741.408, Komp.Nr. 504013/04	TNK	1987 477 857	↔	1545	
<b>316</b>	CDI	04.00-05.06	115	Hintera. 741.408, Komp.Nr. 504013/04	TNK	1987 477 857	↔	1545	
<b>316</b>	CDI James Cook	04.01-05.06	115	Hintera. 741.408, Komp.Nr. 504013/04	TNK	1987 477 857	↔	1545	
<b>316</b>	CDI	04.00-05.06	115		BDS,R30	1987 477 856		1415	
<b>316</b>	CDI James Cook				<del>BDS,R30</del>	1987 477 853		1435	
				Komp.Nr. 500038/02	R35,TNK	1987 477 854		1990	
				Komp.Nr. 500038/03	R40,TNK	1987 477 855		2460	
				Komp.Nr. 500038/04	R35,TNK	1987 482 131		1970	
				Komp.Nr. 500038/05	R40,TNK	1987 477 880		2440	
				Komp.Nr. 504013/02	TNK	1987 477 858	←	1525	
						1987 477 859	→	1526	
				Komp.Nr. 504013/05	TNK	1987 477 860	←	1570	
						1987 477 861	→	1565	
<b>408</b>	CDI	04.00-05.06	60		BDS,R30	1987 477 856		1415	
					<del>BDS,R30</del>	1987 477 853		1435	
				Komp.Nr. 500038/02	R35,TNK	1987 477 854		1990	
				Komp.Nr. 500038/03	R40,TNK	1987 477 855		2460	
				Komp.Nr. 504013/01	TNK	1987 477 852	↔	1513	
				Komp.Nr. 504013/02	TNK	1987 477 858	←	1525	
						1987 477 859	→	1526	
				Komp.Nr. 504013/03	TNK	1987 477 702	→	1680	
						1987 477 703	←	1680	
				Komp.Nr. 504013/04	TNK	1987 477 857	↔	1545	
				Komp.Nr. 504013/05	TNK	1987 477 860	←	1570	
						1987 477 861	→	1565	
<b>408</b>	D	02.95-03.00	58		MBB	1987 477 118	→	1845	
						1987 477 119	←	1845	
					BDS,R30	1987 477 856		1415	
					<del>BDS,R30</del>	1987 477 853		1435	
				Komp.Nr. 500038/02	R35,TNK	1987 477 854		1990	
				Komp.Nr. 500038/03	R40,TNK	1987 477 855		2460	
				Komp.Nr. 504013/01	TNK	1987 477 852	↔	1513	
				Komp.Nr. 504013/02	TNK	1987 477 858	←	1525	
						1987 477 859	→	1526	
				Komp.Nr. 504013/03	TNK	1987 477 702	→	1680	
						1987 477 703	←	1680	
				Komp.Nr. 504013/04	TNK	1987 477 857	↔	1545	
				Komp.Nr. 504013/05	TNK	1987 477 860	←	1570	
						1987 477 861	→	1565	
<b>410</b>	D	01.97-03.00	75		BDS,R30	1987 477 856		1415	
					<del>BDS,R30</del>	1987 477 853		1435	
				Komp.Nr. 500038/02	R35,TNK	1987 477 854		1990	
				Komp.Nr. 500038/03	R40,TNK	1987 477 855		2460	
				Komp.Nr. 504013/01	TNK	1987 477 852	↔	1513	
				Komp.Nr. 504013/02	TNK	1987 477 858	←	1525	
						1987 477 859	→	1526	
				Komp.Nr. 504013/03	TNK	1987 477 702	→	1680	
						1987 477 703	←	1680	
				Komp.Nr. 504013/04	TNK	1987 477 857	↔	1545	
				Komp.Nr. 504013/05	TNK	1987 477 860	←	1570	
						1987 477 861	→	1565	
<b>411</b>	CDI	04.00-05.06	80		BDS,R30	1987 477 856		1415	
					<del>BDS,R30</del>	1987 477 853		1435	
				Komp.Nr. 500038/02	R35,TNK	1987 477 854		1990	
				Komp.Nr. 500038/03	R40,TNK	1987 477 855		2460	
				Komp.Nr. 504013/01	TNK	1987 477 852	↔	1513	
				Komp.Nr. 504013/02	TNK	1987 477 858	←	1525	
						1987 477 859	→	1526	
				Komp.Nr. 504013/03	TNK	1987 477 702	→	1680	
						1987 477 703	←	1680	



		S									
411 CDI	04.00-05.06	80	Komp.Nr. 504013/04	TNK	1 987 477 857	↔ 1545					
					Komp.Nr. 504013/05	TNK	1 987 477 860	← 1570			
							1 987 477 861	→ 1565			
412 D	02.95-03.00	90			BDS,R30	1 987 477 856	1415				
					<del>BDS,R30</del>	1 987 477 853	1435				
					Komp.Nr. 500038/02	R35,TNK	1 987 477 854	1990			
					Komp.Nr. 500038/03	R40,TNK	1 987 477 855	2460			
					Komp.Nr. 504013/01	TNK	1 987 477 852	↔ 1513			
					Komp.Nr. 504013/02	TNK	1 987 477 858	← 1525			
							1 987 477 859	→ 1526			
					Komp.Nr. 504013/03	TNK	1 987 477 702	→ 1680			
							1 987 477 703	← 1680			
					Komp.Nr. 504013/04	TNK	1 987 477 857	↔ 1545			
					Komp.Nr. 504013/05	TNK	1 987 477 860	← 1570			
1 987 477 861	→ 1565										
413 CDI	04.00-05.06	95			BDS,R30	1 987 477 856	1415				
					<del>BDS,R30</del>	1 987 477 853	1435				
					Komp.Nr. 500038/02	R35,TNK	1 987 477 854	1990			
					Komp.Nr. 500038/03	R40,TNK	1 987 477 855	2460			
					Komp.Nr. 504013/01	TNK	1 987 477 852	↔ 1513			
					Komp.Nr. 504013/02	TNK	1 987 477 858	← 1525			
							1 987 477 859	→ 1526			
					Komp.Nr. 504013/03	TNK	1 987 477 702	→ 1680			
							1 987 477 703	← 1680			
					Komp.Nr. 504013/04	TNK	1 987 477 857	↔ 1545			
					Komp.Nr. 504013/05	TNK	1 987 477 860	← 1570			
1 987 477 861	→ 1565										
414	02.95-05.06	105-108			BDS,R30	1 987 477 856	1415				
					<del>BDS,R30</del>	1 987 477 853	1435				
					Komp.Nr. 500038/02	R35,TNK	1 987 477 854	1990			
					Komp.Nr. 500038/03	R40,TNK	1 987 477 855	2460			
					Komp.Nr. 504013/01	TNK	1 987 477 852	↔ 1513			
					Komp.Nr. 504013/02	TNK	1 987 477 858	← 1525			
							1 987 477 859	→ 1526			
					Komp.Nr. 504013/03	TNK	1 987 477 702	→ 1680			
							1 987 477 703	← 1680			
					Komp.Nr. 504013/04	TNK	1 987 477 857	↔ 1545			
					Komp.Nr. 504013/05	TNK	1 987 477 860	← 1570			
1 987 477 861	→ 1565										
416 CDI	04.00-05.06	115			BDS,R30	1 987 477 856	1415				
					<del>BDS,R30</del>	1 987 477 853	1435				
					Komp.Nr. 500038/02	R35,TNK	1 987 477 854	1990			
					Komp.Nr. 500038/03	R40,TNK	1 987 477 855	2460			
					Komp.Nr. 504013/01	TNK	1 987 477 852	↔ 1513			
					Komp.Nr. 504013/02	TNK	1 987 477 858	← 1525			
	1 987 477 859	→ 1526									
	Komp.Nr. 504013/03	TNK	1 987 477 702	→ 1680							
			1 987 477 703	← 1680							
	Komp.Nr. 504013/04	TNK	1 987 477 857	↔ 1545							
	Komp.Nr. 504013/05	TNK	1 987 477 860	← 1570							
			1 987 477 861	→ 1565							
	10.04-05.06	115				1 987 477 855	2460				
					Komp.Nr. B E 2	1 987 477 880	2440				
	208 CDI	02.95-05.06	58-60		H01	0 265 004 009 <sup>3</sup>					
	208 D					0 265 004 010 <sup>4</sup>					
	210 D	01.97-03.00	75		H01	0 265 004 009 <sup>3</sup>					
						0 265 004 010 <sup>4</sup>					
211 CDI	04.00-05.06	80			H01	0 265 004 009 <sup>3</sup>					
						0 265 004 010 <sup>4</sup>					
212 D	02.95-03.00	90			H01	0 265 004 009 <sup>3</sup>					
						0 265 004 010 <sup>4</sup>					



		S							
<b>Mercedes-Benz Sprinter [T1N]</b>									
	213 CDI	04.00-05.06	95			H01	0 265 004 009 <sup>3</sup>		
							0 265 004 010 <sup>4</sup>		
	214	02.95-05.06	95/105-108			H01	0 265 004 009 <sup>3</sup>		
	214 NGT						0 265 004 010 <sup>4</sup>		
	216 CDI	04.00-05.06	115			H01	0 265 004 009 <sup>3</sup>		
							0 265 004 010 <sup>4</sup>		
	308 CDI, D, D James Cook	02.95-05.06	58/60			H01	0 265 004 009 <sup>3</sup>		
							0 265 004 010 <sup>4</sup>		
	310 D	01.97-03.00	75			H01	0 265 004 009 <sup>3</sup>		
	310 D James Cook						0 265 004 010 <sup>4</sup>		
	311 CDI	04.00-05.06	80			H01	0 265 004 009 <sup>3</sup>		
							0 265 004 010 <sup>4</sup>		
	312 D	02.95-03.00	90			H01	0 265 004 009 <sup>3</sup>		
	312 D James Cook						0 265 004 010 <sup>4</sup>		
	313 CDI	04.00-05.06	95			H01	0 265 004 009 <sup>3</sup>		
	313 CDI 4x4						0 265 004 010 <sup>4</sup>		
	314, James Cook, NGT	02.95-05.06	95/105-108			H01	0 265 004 009 <sup>3</sup>		
							0 265 004 010 <sup>4</sup>		
	316 CDI	04.00-05.06	115			H01	0 265 004 009 <sup>3</sup>		
	316 CDI James Cook						0 265 004 010 <sup>4</sup>		
	408 CDI	02.95-05.06	58/60			H01	0 265 004 009 <sup>3</sup>		
	408 D						0 265 004 010 <sup>4</sup>		
	410 D	01.97-03.00	75			H01	0 265 004 009 <sup>3</sup>		
							0 265 004 010 <sup>4</sup>		
	411 CDI	04.00-05.06	80			H01	0 265 004 009 <sup>3</sup>		
							0 265 004 010 <sup>4</sup>		
	412 D	02.95-03.00	90			H01	0 265 004 009 <sup>3</sup>		
							0 265 004 010 <sup>4</sup>		
	413 CDI	04.00-05.06	95			H01	0 265 004 009 <sup>3</sup>		
							0 265 004 010 <sup>4</sup>		
	414	02.95-05.06	105-108			H01	0 265 004 009 <sup>3</sup>		
							0 265 004 010 <sup>4</sup>		
	416 CDI	04.00-05.06	115			H01	0 265 004 009 <sup>3</sup>		
							0 265 004 010 <sup>4</sup>		
	616 CDI	02.01-05.06	115			H01	0 265 004 009 <sup>3</sup>		
							0 265 004 010 <sup>4</sup>		
<b>Vaneo [414]</b>									
	1.6	02.02-08.05	60/75				0 986 134 029		← 30
							0 986 135 029		→ 30
	1.7 CDI	02.02-08.05	55/67				0 986 134 029		← 30
							0 986 135 029		→ 30
	1.9	02.02-08.05	92				0 986 134 029		← 30
							0 986 135 029		→ 30
	1.6	02.02-08.05	60/75				1 987 477 801		← 1038
							1 987 477 810		→ 685
							1 987 482 130		1463
	1.7 CDI	02.02-08.05	55/67				1 987 477 801		← 1038
							1 987 477 810		→ 685
							1 987 482 130		1463
	1.9	02.02-08.05	92				1 987 477 801		← 1038
							1 987 477 810		→ 685
							1 987 482 130		1463
	1.6	02.02-08.05	60/75				0 265 006 372 <sup>4</sup>		
						LAB	0 265 006 370 <sup>3</sup>		
						RAB	0 265 006 368 <sup>3</sup>		

			S							
1.7 CDI	02.02-08.05	55/67						0 265 006 372 <sup>4</sup>		
								LAB 0 265 006 370 <sup>3</sup>		
								RAB 0 265 006 368 <sup>3</sup>		
1.9	02.02-08.05	92						0 265 006 372 <sup>4</sup>		
								LAB 0 265 006 370 <sup>3</sup>		
								RAB 0 265 006 368 <sup>3</sup>		
<b>Viano [639]</b>										
	2.0 CDI	09.03-10.06	80	Fg.-Nr. →056377				0 204 204 673	← 48	
								0 986 134 032		
								0 204 204 674	→ 48	
								0 986 135 032		
				Fg.-Nr. 056378→				0 204 004 513	← 48	
								0 986 134 032		
								0 204 004 514	→ 48	
								0 986 135 032		
		11.06-08.10	85	Fg.-Nr. →3342257	NAA			0 204 004 513	← 48	
								0 986 134 032		
								0 204 004 514	→ 48	
								0 986 135 032		
				Fg.-Nr. →407625	AA			0 204 004 513	← 48	
								0 986 134 032		
								0 204 004 514	→ 48	
								0 986 135 032		
				Fg.-Nr. 3342258→	NAA			0 986 134 306	←	
								0 986 134 336	←	
								0 986 135 306	→	
								0 986 135 336	→	
				Fg.-Nr. 407626→	AA			0 986 134 306	←	
								0 986 134 336	←	
								0 986 135 306	→	
								0 986 135 336	→	
		07.10→	100					0 986 134 306	←	
								0 986 134 336	←	
								0 986 135 306	→	
								0 986 135 336	→	
2.2 CDI	09.03-12.10	110	Fg.-Nr. →3342257	NAA				0 204 004 513	← 48	
								0 986 134 032		
								0 204 004 514	→ 48	
								0 986 135 032		
			Fg.-Nr. →407625	AA				0 204 004 513	← 48	
								0 986 134 032		
								0 204 004 514	→ 48	
								0 986 135 032		
			Fg.-Nr. 3342258→	NAA				0 986 134 306	←	
								0 986 134 336	←	
								0 986 135 306	→	
								0 986 135 336	→	
			Fg.-Nr. 407626→	AA				0 986 134 306	←	
								0 986 134 336	←	
								0 986 135 306	→	
								0 986 135 336	→	
		07.10→	120					0 986 134 306	←	
								0 986 134 336	←	
								0 986 135 306	→	
								0 986 135 336	→	
3.0 CDI	04.06-08.10	150	Fg.-Nr. →3342257					0 204 004 513	← 48	
								0 986 134 032		
								0 204 004 514	→ 48	
								0 986 135 032		



◀ MERCEDES-BENZ Viano [639]								
<b>3.0 CDI</b>	04.06-08.10	150	Fg.-Nr. 3342258→	0986 <b>134 306</b>				
				0986 <b>134 336</b>				
	07.10→	165	Fg.-Nr. →056377	0986 <b>135 306</b>				
				0986 <b>135 336</b>				
				0986 <b>134 306</b>				
				0986 <b>134 336</b>				
<b>3.2</b>	09.03-12.07	140/160	Fg.-Nr. →056377	0204 <b>204 673</b>		48		
				0986 <b>134 032</b>				
	Fg.-Nr. 056378→			0204 <b>204 674</b>		48		
				0986 <b>135 032</b>				
				0204 <b>004 513</b>		48		
				0986 <b>134 032</b>				
<b>3.5</b>	09.07→	190	Fg.-Nr. →3342257	0204 <b>004 513</b>		48		
				0986 <b>134 032</b>				
	Fg.-Nr. 3342258→			0204 <b>004 514</b>		48		
				0986 <b>135 032</b>				
				0986 <b>134 306</b>				
				0986 <b>134 336</b>				
<b>3.7</b>	06.04-08.07	170	Fg.-Nr. →056377	0204 <b>204 673</b>		48		
				0986 <b>134 032</b>				
	Fg.-Nr. 056378→			0204 <b>204 674</b>		48		
				0986 <b>135 032</b>				
				0204 <b>004 513</b>		48		
				0986 <b>134 032</b>				
<b>2.0 CDI</b>	09.03→	80/85/100		0204 <b>004 515</b>		38		
				0986 <b>473 338</b>				
	Fg.-Nr. 056378→			0204 <b>004 516</b>		38		
				0986 <b>474 338</b>				
				0204 <b>004 515</b>		38		
				0986 <b>473 338</b>				
<b>2.2 CDI</b>	09.03→	110/120		0204 <b>004 515</b>		38		
				0986 <b>473 338</b>				
	Fg.-Nr. 056378→			0204 <b>004 516</b>		38		
				0986 <b>474 338</b>				
				0204 <b>004 515</b>		38		
				0986 <b>473 338</b>				
<b>3.0 CDI</b>	04.06→	150/165		0204 <b>004 515</b>		38		
				0986 <b>473 338</b>				
	Fg.-Nr. 056378→			0204 <b>004 516</b>		38		
				0986 <b>474 338</b>				
				0204 <b>004 515</b>		38		
				0986 <b>473 338</b>				
<b>3.2</b>	09.03-12.07	140/160		0204 <b>004 515</b>		38		
				0986 <b>473 338</b>				
	Fg.-Nr. 056378→			0204 <b>004 516</b>		38		
				0986 <b>474 338</b>				
				0204 <b>004 515</b>		38		
				0986 <b>473 338</b>				
<b>3.5</b>	09.07→	190		0204 <b>004 515</b>		38		
				0986 <b>473 338</b>				
	Fg.-Nr. 056378→			0204 <b>004 516</b>		38		
				0986 <b>474 338</b>				
				0204 <b>004 515</b>		38		
				0986 <b>473 338</b>				
<b>3.7</b>	06.04-08.07	170		0204 <b>004 515</b>		38		
				0986 <b>473 338</b>				
	Fg.-Nr. 056378→			0204 <b>004 516</b>		38		
				0986 <b>474 338</b>				
				0204 <b>004 515</b>		38		
				0986 <b>473 338</b>				





	2.0 CDI	09.03-10.06	80			1 987 482 025	→ 1152	
						1 987 482 026	← 1285	
					LKR	1 987 477 197	2799	
					RKR	1 987 477 198	2432	
		11.06→	85/100			1 987 482 025	→ 1152	
						1 987 482 026	← 1285	
					LKR,NAA	1 987 477 197	2799	
					RKR	1 987 477 198	2432	
	2.2 CDI	09.03→	110/120			1 987 482 025	→ 1152	
						1 987 482 026	← 1285	
					LKR,NAA	1 987 477 197	2799	
					RKR	1 987 477 198	2432	
	3.0 CDI	04.06→	150/165			1 987 482 025	→ 1152	
						1 987 482 026	← 1285	
					LKR	1 987 477 197	2799	
					RKR	1 987 477 198	2432	
	3.2	09.03-12.07	140/160			1 987 482 025	→ 1152	
						1 987 482 026	← 1285	
					LKR	1 987 477 197	2799	
					RKR	1 987 477 198	2432	
	3.5	09.07→	190			1 987 482 025	→ 1152	
						1 987 482 026	← 1285	
					LKR	1 987 477 197	2799	
					RKR	1 987 477 198	2432	
	3.7	06.04-08.07	170			1 987 482 025	→ 1152	
						1 987 482 026	← 1285	
					LKR	1 987 477 197	2799	
					RKR	1 987 477 198	2432	

**Vito [638]**

	108 CDI	11.95-09.03	60		BSY,	0 204 102 914	← 60	
	108 D				FDO,	0 986 473 235		
					JUR	0 986 473 362		
						0 204 102 915	→ 60	
						0 986 474 235		
						0 986 474 362		
	108 D	11.95-09.03	60		ATE,	0 986 473 235	← 60	
					ITB	0 986 474 235	→ 60	
	110 CDI	04.99-09.03	75		BSY,	0 204 102 914	← 60	
					FDO,	0 986 473 235		
					JUR	0 986 473 362		
						0 204 102 915	→ 60	
						0 986 474 235		
						0 986 474 362		
	110 D	11.95-09.03	72		ATE,	0 986 473 235	← 60	
					ITB	0 986 474 235	→ 60	
					BSY,	0 204 102 914	← 60	
					FDO,	0 986 473 235		
					JUR	0 986 473 362		
						0 204 102 915	→ 60	
						0 986 474 235		
						0 986 474 362		
	112 CDI	04.99-09.03	90		BSY,	0 204 102 914	← 60	
					FDO,	0 986 473 235		
					JUR	0 986 473 362		
						0 204 102 915	→ 60	
						0 986 474 235		
						0 986 474 362		







	◀ MERCEDES-BENZ Vito [638]				
113	11.95-09.03	95	BSY, 0 204 102 914	← 60	
			FDO, 0 986 473 235		
			JUR 0 986 473 362		
			0 204 102 915	→ 60	
			0 986 474 235		
			0 986 474 362		
		100	ATE, 0 986 473 235	← 60	
			ITB 0 986 474 235	→ 60	
			BSY, 0 204 102 914	← 60	
			FDO, 0 986 473 235		
			JUR 0 986 473 362		
			0 204 102 915	→ 60	
			0 986 474 235		
			0 986 474 362		
114	11.95-09.03	105	ATE, 0 986 473 235	← 60	
			ITB 0 986 474 235	→ 60	
			BSY, 0 204 102 914	← 60	
			FDO, 0 986 473 235		
			JUR 0 986 473 362		
			0 204 102 915	→ 60	
			0 986 474 235		
			0 986 474 362		

	108 CDI	11.95-09.03	60	0 204 102 916	← 33
	108 D			0 986 473 360	
				0 204 102 917	→ 33
				0 986 474 360	
	110 CDI	11.95-09.03	72/75	0 204 102 916	← 33
	110 D			0 986 473 360	
				0 204 102 917	→ 33
				0 986 474 360	
	112 CDI	04.99-09.03	90	0 204 102 916	← 33
				0 986 473 360	
				0 204 102 917	→ 33
				0 986 474 360	
	113	11.95-09.03	95/100	0 204 102 916	← 33
				0 986 473 360	
				0 204 102 917	→ 33
				0 986 474 360	
	114	11.95-09.03	105	0 204 102 916	← 33
				0 986 473 360	
				0 204 102 917	→ 33
				0 986 474 360	

	108 CDI	11.95-09.03	60	1 987 477 199	1167
	108 D			RLE 1 987 482 501	1270
	110 CDI	04.99-09.03	75	1 987 477 199	1167
				RLE 1 987 482 501	1270
	110 D	11.95-09.03	72	1 987 477 199	1167
	112 CDI	04.99-09.03	90	1 987 477 199	1167
				RLE 1 987 482 501	1270
	113	11.95-09.03	95/100	1 987 477 199	1167
				RLE 1 987 482 501	1270
	114	11.95-09.03	105	1 987 477 199	1167
				RLE 1 987 482 501	1270

	108 CDI	11.95-09.03	60	0 265 006 214 <sup>3</sup>	
	108 D			0 265 006 215 <sup>4</sup>	

		S							
<b>110</b> CDI		11.95-09.03	72/75				0 265 006 214 <sup>3</sup>		
<b>110</b> D							0 265 006 215 <sup>4</sup>		
<b>112</b> CDI		04.99-09.03	90				0 265 006 214 <sup>3</sup>		
							0 265 006 215 <sup>4</sup>		
<b>113</b>		11.95-09.03	95/100				0 265 006 214 <sup>3</sup>		
							0 265 006 215 <sup>4</sup>		
<b>114</b>		11.95-09.03	105				0 265 006 214 <sup>3</sup>		
							0 265 006 215 <sup>4</sup>		
<b>Vito [639]</b>									
	<b>E-Cell</b>	07.10→	60				0 986 134 306		←
							0 986 134 336		←
							0 986 135 306		→
							0 986 135 336		→
<b>109</b> CDI		10.03-10.06	65	Fg.-Nr. →056377			0 204 204 673		← 48
							0 986 134 032		
							0 204 204 674		→ 48
							0 986 135 032		
				Fg.-Nr. 056378→			0 204 004 513		← 48
							0 986 134 032		
							0 204 004 514		→ 48
							0 986 135 032		
		11.06-07.10	70	Fg.-Nr. →3342257			0 204 004 513		← 48
							0 986 134 032		
							0 204 004 514		→ 48
							0 986 135 032		
				Fg.-Nr. 3342258→			0 986 134 306		←
							0 986 134 336		←
							0 986 135 306		→
							0 986 135 336		→
<b>110</b> CDI		07.10→	70				0 986 134 306		←
							0 986 134 336		←
							0 986 135 306		→
							0 986 135 336		→
<b>111</b> CDI		10.03-07.10	80	Fg.-Nr. →056377			0 204 204 673		← 48
							0 986 134 032		
							0 204 204 674		→ 48
							0 986 135 032		
				Fg.-Nr. 056378→			0 204 004 513		← 48
							0 986 134 032		
							0 204 004 514		→ 48
							0 986 135 032		
		11.06-07.10	85	Fg.-Nr. →3342257	NAA		0 204 004 513		← 48
							0 986 134 032		
							0 204 004 514		→ 48
							0 986 135 032		
				Fg.-Nr. →407625	AA		0 204 004 513		← 48
							0 986 134 032		
							0 204 004 514		→ 48
							0 986 135 032		
				Fg.-Nr. 3342258→	NAA		0 986 134 306		←
							0 986 134 336		←
							0 986 135 306		→
							0 986 135 336		→
				Fg.-Nr. 407626→	AA		0 986 134 306		←
							0 986 134 336		←
							0 986 135 306		→
							0 986 135 336		→



		S							
◀ MERCEDES-BENZ Vito [639]									
113	CDI	07.10→	100				0986 134 306		←
							0986 134 336		←
							0986 135 306		→
							0986 135 336		→
115	CDI	10.03-07.10	110	Fg.-Nr. →3342257	NAA		0204 004 513		← 48
							0986 134 032		
							0204 004 514		→ 48
							0986 135 032		
				Fg.-Nr. →407625	AA		0204 004 513		← 48
							0986 134 032		
							0204 004 514		→ 48
							0986 135 032		
				Fg.-Nr. 3342258→	NAA		0986 134 306		←
							0986 134 336		←
							0986 135 306		→
							0986 135 336		→
				Fg.-Nr. 407626→	AA		0986 134 306		←
							0986 134 336		←
							0986 135 306		→
							0986 135 336		→
116	CDI	07.10→	120				0986 134 306		←
							0986 134 336		←
							0986 135 306		→
							0986 135 336		→
119		10.03-12.10	140	Fg.-Nr. →3342257			0204 004 513		← 48
							0986 134 032		
							0204 004 514		→ 48
							0986 135 032		
				Fg.-Nr. 3342258→			0986 134 306		←
							0986 134 336		←
							0986 135 306		→
							0986 135 336		→
120	CDI	04.06-07.10	150	Fg.-Nr. →3342257			0204 004 513		← 48
							0986 134 032		
							0204 004 514		→ 48
							0986 135 032		
				Fg.-Nr. 3342258→			0986 134 306		←
							0986 134 336		←
							0986 135 306		→
							0986 135 336		→
122		10.03-12.10	160	Fg.-Nr. →3342257			0204 004 513		← 48
							0986 134 032		
							0204 004 514		→ 48
							0986 135 032		
				Fg.-Nr. 3342258→			0986 134 306		←
							0986 134 336		←
							0986 135 306		→
							0986 135 336		→
122	CDI	07.10→	165				0986 134 306		←
							0986 134 336		←
							0986 135 306		→
							0986 135 336		→
123		06.04-08.07	170	Fg.-Nr. →056377			0204 204 673		← 48
							0986 134 032		
							0204 204 674		→ 48
							0986 135 032		
				Fg.-Nr. 056378→			0204 004 513		← 48
							0986 134 032		
							0204 004 514		→ 48
							0986 135 032		



		S							
126		09.07→	190	Fg.-Nr. →3342257			0 204 004 513	← 48	
							0 986 134 032		
							0 204 004 514	→ 48	
							0 986 135 032		
				Fg.-Nr. 3342258→			0 986 134 306	←	
							0 986 134 336	←	
							0 986 135 306	→	
							0 986 135 336	→	
<hr/>									
	E-Cell	07.10→	60				0 204 004 515	← 38	
							0 986 473 338		
							0 204 004 516	→ 38	
							0 986 474 338		
109	CDI	10.03-07.10	65/70				0 204 004 515	← 38	
							0 986 473 338		
							0 204 004 516	→ 38	
							0 986 474 338		
110	CDI	07.10→	70				0 204 004 515	← 38	
							0 986 473 338		
							0 204 004 516	→ 38	
							0 986 474 338		
111	CDI	10.03-07.10	80/85				0 204 004 515	← 38	
							0 986 473 338		
							0 204 004 516	→ 38	
							0 986 474 338		
113	CDI	07.10→	100				0 204 004 515	← 38	
							0 986 473 338		
							0 204 004 516	→ 38	
							0 986 474 338		
115	CDI	10.03-07.10	110				0 204 004 515	← 38	
							0 986 473 338		
							0 204 004 516	→ 38	
							0 986 474 338		
116	CDI	07.10→	120				0 204 004 515	← 38	
							0 986 473 338		
							0 204 004 516	→ 38	
							0 986 474 338		
119		10.03-12.10	140				0 204 004 515	← 38	
							0 986 473 338		
							0 204 004 516	→ 38	
							0 986 474 338		
120	CDI	04.06-07.10	150				0 204 004 515	← 38	
							0 986 473 338		
							0 204 004 516	→ 38	
							0 986 474 338		
122		10.03→	160/165				0 204 004 515	← 38	
122	CDI						0 986 473 338		
							0 204 004 516	→ 38	
							0 986 474 338		
123		06.04-08.07	170				0 204 004 515	← 38	
							0 986 473 338		
							0 204 004 516	→ 38	
							0 986 474 338		
126		09.07→	190				0 204 004 515	← 38	
							0 986 473 338		
							0 204 004 516	→ 38	
							0 986 474 338		





◀ MERCEDES-BENZ Vito [639]



	109 CDI	10.03-07.10	65/70			1987 482 025	→ 1152	
						1987 482 026	← 1285	
						LKR	1987 477 197	2799
						RKR	1987 477 198	2432
110 CDI	07.10→	70				1987 482 025	→ 1152	
						1987 482 026	← 1285	
						LKR	1987 477 197	2799
						RKR	1987 477 198	2432
111 CDI	10.03-07.10	80				1987 482 025	→ 1152	
						1987 482 026	← 1285	
						LKR	1987 477 197	2799
						RKR	1987 477 198	2432
		11.06-07.10	85			1987 482 025	→ 1152	
						1987 482 026	← 1285	
						LKR,NAA	1987 477 197	2799
						RKR	1987 477 198	2432
113 CDI	07.10→	100				1987 482 025	→ 1152	
						1987 482 026	← 1285	
						LKR,NAA	1987 477 197	2799
						RKR	1987 477 198	2432
115 CDI	10.03-07.10	110				1987 482 025	→ 1152	
						1987 482 026	← 1285	
						LKR,NAA	1987 477 197	2799
						RKR	1987 477 198	2432
116 CDI	07.10→	120				1987 482 025	→ 1152	
						1987 482 026	← 1285	
						LKR,NAA	1987 477 197	2799
						RKR	1987 477 198	2432
119	10.03-12.10	140				1987 482 025	→ 1152	
						1987 482 026	← 1285	
						LKR	1987 477 197	2799
						RKR	1987 477 198	2432
120 CDI	04.06-07.10	150				1987 482 025	→ 1152	
						1987 482 026	← 1285	
						LKR	1987 477 197	2799
						RKR	1987 477 198	2432
122 122 CDI	10.03→	160/165				1987 482 025	→ 1152	
						1987 482 026	← 1285	
						LKR	1987 477 197	2799
						RKR	1987 477 198	2432
123	06.04-08.07	170				1987 482 025	→ 1152	
						1987 482 026	← 1285	
						LKR	1987 477 197	2799
						RKR	1987 477 198	2432
126	09.07→	190				1987 482 025	→ 1152	
						1987 482 026	← 1285	
						LKR	1987 477 197	2799
						RKR	1987 477 198	2432

2t [T1]



	208 D	10.88-06.95	58-60	Fg.-Nr. VA→ BM:730.403,404	EBR	0986 471 979	← 44
						0986 471 980	→ 44
				Fg.-Nr. VA→ BM:730.445,446	ZBR	0986 473 981	← 44
						0986 473 982	→ 44
210 210 D	08.82-06.95	70-77		Fg.-Nr. VA→ BM:730.403,404	EBR	0986 471 979	← 44
						0986 471 980	→ 44
				Fg.-Nr. VA→ BM:730.445,446	ZBR	0986 473 981	← 44
						0986 473 982	→ 44

		S								
	208 D	10.88-06.95	58-60					0 986 475 023	↔ 15	
	210, D	08.82-06.95	70-77					0 986 475 023	↔ 15	
	208 D	10.88-06.95	58-60					MBB 1 987 477 118	→ 1845	
								1 987 477 119	← 1845	
								PEO 1 987 477 211	1798	
								MI,R33 1 987 477 209	1130	
								MI,R37 1 987 477 210	1480	
								30R,MI 1 987 477 208	830	
	210	08.82-06.95	70-77					MBB 1 987 477 118	→ 1845	
	210 D							1 987 477 119	← 1845	
								PEO 1 987 477 211	1798	
								MI,R33 1 987 477 209	1130	
								MI,R37 1 987 477 210	1480	
								30R,MI 1 987 477 208	830	
	208 D	10.88-06.95	58-60					0 265 001 126 <sup>3</sup>		
	210, D	01.88-06.95	70-77					0 265 001 126 <sup>3</sup>		
<b>3t [T1]</b>										
	308 D	10.88-06.95	58-60	Fg.-Nr. VA-BM:→ 730.404,447	EBR			0 986 471 979	← 44	
								0 986 471 980	→ 44	
				Fg.-Nr. VA-BM:→ 730.446,448	ZBR			0 986 473 981	← 44	
								0 986 473 982	→ 44	
	310	08.82-06.95	70-77	Fg.-Nr. VA-BM:→ 730.404,447	EBR			0 986 471 979	← 44	
	310 D							0 986 471 980	→ 44	
				Fg.-Nr. VA-BM:→ 730.446,448	ZBR			0 986 473 981	← 44	
								0 986 473 982	→ 44	
	308 D	10.88-06.95	58-60					0 986 475 023	↔ 15	
	310, D	08.82-06.95	70-77					0 986 475 023	↔ 15	
	308 D	10.88-06.95	58-60					MBB 1 987 477 118	→ 1845	
								1 987 477 119	← 1845	
								PEO 1 987 477 211	1798	
								MI,R33 1 987 477 209	1130	
								MI,R37 1 987 477 210	1480	
								30R,MI 1 987 477 208	830	
	310	08.82-06.95	70-77					MBB 1 987 477 118	→ 1845	
	310 D							1 987 477 119	← 1845	
								PEO 1 987 477 211	1798	
								MI,R33 1 987 477 209	1130	
								MI,R37 1 987 477 210	1480	
								30R,MI 1 987 477 208	830	
<b>4t [T1]</b>										
	408 D	11.88-06.95	58-60	Fg.-Nr. VA:→A025460	EBR			0 986 471 979	← 44	
								0 986 471 980	→ 44	
				Fg.-Nr. VA: A 025461→	ATE,			0 986 474 955	← 44	
					JUR			0 986 474 956	→ 44	



		S							
<b>◀ MERCEDES-BENZ 4t [T1]</b>									
	410	08.82-06.95	70-77	Fg.-Nr. VA:→A 025460	EBR		0986 471 979	← 44	
	410 D						0986 471 980	→ 44	
				Fg.-Nr. VA: A 025461→		ATE,	0986 474 955	← 44	
						JUR	0986 474 956	→ 44	
	408 D	11.88-06.95	58-60				0986 475 042	↔ 22,2	
	410, D	08.82-06.95	70-77				0986 475 042	↔ 22,2	
	408 D	11.88-06.95	58-60				1987 477 121	→ 1744	
							1987 477 122	← 1744	
	410 D	11.88-06.95	70-72				1987 477 121	→ 1744	
							1987 477 122	← 1744	
<b>311 Sprinter [909]</b>									
	CDI	11.13→	80			BSY	0 204 102 912	← 45	
							0986 473 231	↻	
							0 204 102 913	→ 45	
							0986 474 231	↻	
						WAB	0986 473 250	↻ ← 44	
							0986 474 250	↻ → 44	
						TEJ	0986 473 249	↻ ← 60	
							0986 474 249	↻ → 60	
	CDI	11.13→	80			ATE	0986 473 353	↻ ← 51,92	1987 470 506 <sup>8</sup>
							0986 474 353	↻ → 51,92	1987 470 506 <sup>8</sup>
						BSY	0 204 102 918	← 52	
							0986 473 359	↻	
							0 204 102 919	→ 52	
							0986 474 359	↻	
	CDI	11.13→	80			R35	1987 477 854	1990	
						R40	1987 477 855	2460	
						TW	1987 477 852	↔ 1513	
							1987 477 857	↔ 1545	
<b>411 Sprinter [909]</b>									
	CDI	11.13→	80			ATE	0986 473 353	↻ ← 51,92	
							0986 474 353	↻ → 51,92	
						BSY	0 204 102 912	← 45	
							0986 473 231	↻	
							0 204 102 913	→ 45	
							0986 474 231	↻	
						WAB	0986 473 250	↻ ← 44	
							0986 474 250	↻ → 44	
	CDI	11.13→	80			ATE	0986 473 353	↻ ← 51,92	1987 470 506 <sup>8</sup>
							0986 474 353	↻ → 51,92	1987 470 506 <sup>8</sup>
						BSY	0 204 102 918	← 52	
							0986 473 359	↻	
							0 204 102 919	→ 52	
							0986 474 359	↻	

































			S							
<hr/>										
	CDI	11.13→	80					1 987 477 880	2440	
							TW	1 987 477 852	↔ 1513	
								1 987 477 857	↔ 1545	
<hr/>										
<b>MG</b>										
<hr/>										
<b>MG TF</b>										
<hr/>										
	115 1.6i	03.02-05.05	85					0 986 474 772	← 48	
								0 986 474 773	→ 48	
	120 1.8i	03.02-05.05	88					0 986 474 772	← 48	
								0 986 474 773	→ 48	
	135 1.8i	03.02→	100					0 986 474 772	← 48	
								0 986 474 773	→ 48	
<hr/>										
	115 1.6i	03.02-05.05	85					0 265 006 269 <sup>3</sup>		
					Fg.-Nr. AD 9638→	LAB		0 265 006 270 <sup>4</sup>		
						RAB		0 265 006 271 <sup>4</sup>		
	120 1.8i	03.02-05.05	88					0 265 006 269 <sup>3</sup>		
					Fg.-Nr. AD 9638→	LAB		0 265 006 270 <sup>4</sup>		
						RAB		0 265 006 271 <sup>4</sup>		
	135 1.8i	03.02→	100					0 265 006 269 <sup>3</sup>		
					Fg.-Nr. AD 9638→	LAB		0 265 006 270 <sup>4</sup>		
						RAB		0 265 006 271 <sup>4</sup>		
	160 1.8i	03.02-05.05	118					0 265 006 269 <sup>3</sup>		
					Fg.-Nr. AD 9638→	LAB		0 265 006 270 <sup>4</sup>		
						RAB		0 265 006 271 <sup>4</sup>		
<hr/>										
<b>MGF</b>										
<hr/>										
	1.6 i 16V	10.01-03.02	82					0 986 474 772	← 48	
								0 986 474 773	→ 48	
	1.8 i 16V	10.95-03.02	88/107					0 986 474 772	← 48	
								0 986 474 773	→ 48	
<hr/>										
	1.6 i 16V	10.01-03.02	82					0 265 006 269 <sup>3</sup>		
						LAB		0 265 006 270 <sup>4</sup>		
						RAB		0 265 006 271 <sup>4</sup>		
	1.8 i 16V	10.95-03.02	88/107/					0 265 006 269 <sup>3</sup>		
	1.8 16V Trophy		118			LAB		0 265 006 270 <sup>4</sup>		
						RAB		0 265 006 271 <sup>4</sup>		
<hr/>										
<b>ZR</b>										
<hr/>										
	2.0 D Turbo	10.01-05.05	74/82					1 987 477 888	→ 1812	
								1 987 477 889	← 1782	
					Fg.-Nr. →XD 454425	HTB		1 987 477 886	→ 1713	
								1 987 477 887	← 1743	
	105 1.4i 16V	10.01-05.05	76					1 987 477 888	→ 1812	
								1 987 477 889	← 1782	
					Fg.-Nr. →XD 454425	HTB		1 987 477 886	→ 1713	
								1 987 477 887	← 1743	













































		S							
<b>MG ZR</b>									
	120 1.8i 16V	10.01-05.05	86		4SB		1987 477 888	→ 1812	
							1987 477 889	← 1782	
				Fg.-Nr. →XD 454425	HTB		1987 477 886	→ 1713	
							1987 477 887	← 1743	
	160 1.8i 16V	10.01-05.05	118		4SB		1987 477 888	→ 1812	
							1987 477 889	← 1782	
				Fg.-Nr. →XD 454425	HTB		1987 477 886	→ 1713	
							1987 477 887	← 1743	
<b>ZS</b>									
	2.0 D Turbo	10.01-05.05	74/82				0265 006 307 <sup>4</sup>		
					LAB		0265 006 305 <sup>3</sup>		
					RAB		0265 006 306 <sup>3</sup>		
	105 1.4i 16V	10.01-05.05	76				0265 006 307 <sup>4</sup>		
					LAB		0265 006 305 <sup>3</sup>		
					RAB		0265 006 306 <sup>3</sup>		
	120 1.8i 16V	10.01-05.05	86				0265 006 307 <sup>4</sup>		
					LAB		0265 006 305 <sup>3</sup>		
					RAB		0265 006 306 <sup>3</sup>		
	160 1.8i 16V	10.01-05.05	118				0265 006 307 <sup>4</sup>		
					LAB		0265 006 305 <sup>3</sup>		
					RAB		0265 006 306 <sup>3</sup>		
<b>M</b>									
	110 1.6i 16V	03.05-05.05	80		INB		0986 474 778	← 54	
							0986 474 779	→ 54	
					INB		0986 473 088	← 54	
							0986 474 088	→ 54	
	110 1.6i 16V	03.05-05.05	80	Fg.-Nr. →AD 074464			0986 475 808	→ 19,05	
							0986 475 809	← 19,05	
				Fg.-Nr. AD 074465→			0986 475 854	← 19,05	
				YD 558484			0986 475 855	→ 19,05	
	110 1.6i 16V	03.05-05.05	80				0986 474 780	← 30,2	
							0986 474 781	→ 30,2	
	2.0 TD	10.01-05.05	74				1987 482 120	→ 1636	
	110 1.6i 16V	03.05-05.05	80		STB		1987 477 512	← 1485	
							1987 477 513	→ 1510	
				Fg.-Nr. WD 250029→			1987 482 119	→ 1655	
				WD 322148			1987 482 120	← 1636	
				Fg.-Nr. WD 322149→			1987 482 120	← 1636	
	120 1.8i 16V	10.01-05.05	86				1987 482 120	→ 1636	
	180 2.5i 24V	10.01-05.05	130				1987 482 120	→ 1636	
	2.0 TD	10.01-05.05	74		LAB		0265 006 258 <sup>3</sup>		
					RAB		0265 006 259 <sup>3</sup>		
					4SB,LAB		0265 006 267 <sup>4</sup>		
					4SB,RAB		0265 006 268 <sup>4</sup>		
	110 1.6i 16V	03.05-05.05	80		4SB,LAB		0265 006 267 <sup>4</sup>		
					4SB,RAB		0265 006 268 <sup>4</sup>		
				Fg.-Nr. →YD 471063	GS,LAB		0265 006 258 <sup>3</sup>		
					GS,RAB		0265 006 259 <sup>3</sup>		
				Fg.-Nr. YD 471064→	LAB		0265 006 258 <sup>3</sup>		
					RAB		0265 006 259 <sup>3</sup>		

		S							
<b>120</b>	1.8i 16V	10.01-05.05	86			LAB	0 265 006 258 <sup>3</sup>		
						RAB	0 265 006 259 <sup>3</sup>		
						4SB,LAB	0 265 006 267 <sup>4</sup>		
						4SB,RAB	0 265 006 268 <sup>4</sup>		
<b>180</b>	2.5i 24V	10.01-05.05	130			LAB	0 265 006 258 <sup>3</sup>		
						RAB	0 265 006 259 <sup>3</sup>		
						4SB,LAB	0 265 006 267 <sup>4</sup>		
						4SB,RAB	0 265 006 268 <sup>4</sup>		
<b>ZT</b>									
									
	<b>160</b> 2.5i 24V	10.01-05.05	118				0 986 473 990	 ← 57	
							0 986 474 990	 → 57	
	<b>190</b> 2.5i 24V	10.01-05.05	140				0 986 473 990	 ← 57	
							0 986 474 990	 → 57	
	<b>260</b> 4.6i Power	03.02-05.05	191				0 986 473 990	 ← 57	
							0 986 474 990	 → 57	
									
	<b>1.8</b> i 16V, T 16V	03.02-05.05	88/118				1 987 477 885	1570	
	<b>135</b> 2.0 CDTi	10.02-05.05	96				1 987 477 885	1570	
	<b>160</b> 2.5i 24V	10.01-05.05	118				1 987 477 885	1570	
	<b>190</b> 2.0 CDT, 2.5i 24V	10.01-05.05	85/140				1 987 477 885	1570	
	<b>1.8</b> i 16V	03.02-05.05	88/118				0 986 594 538 <sup>3</sup>		
	<b>1.8</b> T 16V						0 986 594 539 <sup>4</sup>		
	<b>135</b> 2.0 CDTi	10.02-05.05	96				0 986 594 538 <sup>3</sup>		
							0 986 594 539 <sup>4</sup>		
	<b>160</b> 2.5i 24V	10.01-05.05	118				0 986 594 538 <sup>3</sup>		
							0 986 594 539 <sup>4</sup>		
	<b>190</b> 2.0 CDT	10.01-05.05	85/140				0 986 594 538 <sup>3</sup>		
	<b>190</b> 2.5i 24V						0 986 594 539 <sup>4</sup>		
	<b>260</b> 4.6i Power	03.02-05.05	191				0 986 594 538 <sup>3</sup>		
<b>ZT-Tourer</b>									
									
	<b>160</b> 2.5i 24V	10.01-05.05	118				0 986 473 990	 ← 57	
							0 986 474 990	 → 57	
	<b>190</b> 2.5i 24V	10.01-05.05	140				0 986 473 990	 ← 57	
							0 986 474 990	 → 57	
	<b>260</b> 4.6i Power	03.03-05.05	191				0 986 473 990	 ← 57	
							0 986 474 990	 → 57	
									
	<b>135</b> 2.0 CDTi	10.02-05.05	96				1 987 477 885	1570	
	<b>160</b> 2.5i 24V	10.01-05.05	118				1 987 477 885	1570	
	<b>190</b> 1.8 T 16V, 1.8i 16V, 2.0 CDT, 2.5i 24V	10.01-05.05	85/88/118/ 140				1 987 477 885	1570	
	<b>135</b> 2.0 CDTi	10.02-05.05	96				0 986 594 538 <sup>3</sup>		
							0 986 594 539 <sup>4</sup>		
	<b>160</b> 2.5i 24V	10.01-05.05	118				0 986 594 538 <sup>3</sup>		
							0 986 594 539 <sup>4</sup>		
	<b>190</b> 1.8 T 16V, 1.8i 16V, 2.0 CDT, 2.5i 24V	10.01-05.05	85/88/118/ 140				0 986 594 538 <sup>3</sup>		
							0 986 594 539 <sup>4</sup>		
	<b>260</b> 4.6i Power	03.03-05.05	191				0 986 594 538 <sup>3</sup>		



		S				?			
<b>MINI (BMW)</b>									
<b>Cooper Cabrio [R 52]</b>									
	1.6 1.6 S	07.04-07.08	85/120-125				0986 <b>473 415</b>	← 48	F 026 <b>A06 623</b> <sup>7</sup>
							0986 <b>474 415</b>	→ 48	F 026 <b>A06 623</b> <sup>7</sup>
	1.6 1.6 S	07.04-07.08	85/120-125				0986 <b>473 414</b>	← 34	
							0986 <b>474 414</b>	→ 34	
	1.6 1.6 S	07.04-07.08	85/120-125				1987 <b>482 230</b>	→ 1435	
							1987 <b>482 231</b>	← 1433	
	1.6 1.6 S	07.04-07.08	85/120-125				0986 <b>594 536</b> <sup>3</sup>		
							0986 <b>594 537</b> <sup>4</sup>		
<b>Cooper Cabrio [R 57]</b>									
	1.6, D, S	03.09→	82/85-90/ 128/135/147				0986 <b>134 289</b>	← 54	
							0986 <b>135 289</b>	→ 54	
	2.0D 2.0SD	03.11→	82/105				0986 <b>134 289</b>	← 54	
							0986 <b>135 289</b>	→ 54	
	1.6, D, S	03.09→	82/85-90/ 128/135/147				0986 <b>134 080</b>	← 36	
							0986 <b>135 080</b>	→ 36	
	2.0D 2.0SD	03.11→	82/105				0986 <b>134 080</b>	← 36	
							0986 <b>135 080</b>	→ 36	
	1.6, D, S	03.09→	82/85-90/ 128/135/147				1987 <b>482 226</b>	→ 1402	
							1987 <b>482 227</b>	← 1393	
	2.0D 2.0SD	03.11→	82/105				1987 <b>482 226</b>	→ 1402	
							1987 <b>482 227</b>	← 1393	
	1.6, D, S	03.09→	82/85-90/ 128/135/147				0265 <b>007 807</b> <sup>3</sup>		
							0265 <b>007 808</b> <sup>4</sup>		
	2.0D 2.0SD	03.11→	82/105				0265 <b>007 807</b> <sup>3</sup>		
							0265 <b>007 808</b> <sup>4</sup>		
<b>Cooper Cabrio [R 58]</b>									
	1.6	09.11→	85-90				0986 <b>134 289</b>	← 54	
							0986 <b>135 289</b>	→ 54	
	1.6	09.11→	85-90				0986 <b>134 080</b>	← 36	
							0986 <b>135 080</b>	→ 36	
	1.6	09.11→	85-90				1987 <b>482 226</b>	→ 1402	
							1987 <b>482 227</b>	← 1393	



		S							
	1.6	09.11→	85-90				0 265 007 807 <sup>3</sup>		
							0 265 007 808 <sup>4</sup>		
<b>Cooper Clubman [R 55]</b>									
									
	1.6, D, S	11.07-06.14	80/82/85-90/ 120-128/135/147				0 986 134 289	 ← 54	
							0 986 135 289	 → 54	
	2.0D	03.11-06.14	82/100-105				0 986 134 289	 ← 54	
	2.0SD						0 986 135 289	 → 54	
									
	1.6, D, S	11.07-06.14	80/82/85-90/ 120-128/135/147				0 986 134 080	 ← 36	
							0 986 135 080	 → 36	
	2.0D	03.11-06.14	82/100-105				0 986 134 080	 ← 36	
	2.0SD						0 986 135 080	 → 36	
									
	1.6, D, S	11.07-06.14	80/82/85-90/ 120-128/135/147				1 987 482 228	→ 1483	
							1 987 482 229	← 1474	
	2.0D	03.11-06.14	82/100-105				1 987 482 228	→ 1483	
	2.0SD						1 987 482 229	← 1474	
	1.6, D, S	11.07-06.14	80/82/85-90/ 120-128/135/147				0 265 007 807 <sup>3</sup>		
							0 265 007 808 <sup>4</sup>		
	2.0D	03.11-06.14	82/100-105				0 265 007 807 <sup>3</sup>		
	2.0SD						0 265 007 808 <sup>4</sup>		
<b>Cooper Clubvan [R 55]</b>									
									
	1.6	02.13-06.14	82/90				0 986 134 289	 ← 54	
	1.6D						0 986 135 289	 → 54	
	2.0D	02.13-06.14	82				0 986 134 289	 ← 54	
							0 986 135 289	 → 54	
									
	1.6	02.13-06.14	82/90				0 986 134 080	 ← 36	
	1.6D						0 986 135 080	 → 36	
	2.0D	02.13-06.14	82				0 986 134 080	 ← 36	
							0 986 135 080	 → 36	
									
	1.6	02.13-06.14	82/90				1 987 482 228	→ 1483	
	1.6D						1 987 482 229	← 1474	
	2.0D	02.13-06.14	82				1 987 482 228	→ 1483	
							1 987 482 229	← 1474	
	1.6	02.13-06.14	82/90				0 265 007 807 <sup>3</sup>		
	1.6D						0 265 007 808 <sup>4</sup>		
	2.0D	02.13-06.14	82				0 265 007 807 <sup>3</sup>		
							0 265 007 808 <sup>4</sup>		
<b>Cooper Countryman [R 60]</b>									
									
	1.6, ALL4, D, D ALL4, S, S ALL4	09.10→	82/85-90/120/ 135/140/147				0 265 008 525 <sup>4</sup>		
							0 265 008 526 <sup>3</sup>		
	2.0D, D ALL4, SD, SD ALL4	03.11→	82/100-105				0 265 008 525 <sup>4</sup>		
							0 265 008 526 <sup>3</sup>		



		S				?			
◀ MINI									
<b>Cooper Coupé [R 58]</b>									
	1.6 S	09.11→	120/135/147				0986 134 289	← 54	
							0986 135 289	→ 54	
	2.0 SD	09.11→	100-105				0986 134 289	← 54	
							0986 135 289	→ 54	
	1.6 S	09.11→	120/135/147				0986 134 080	← 36	
							0986 135 080	→ 36	
	2.0 SD	09.11→	100-105				0986 134 080	← 36	
							0986 135 080	→ 36	
	1.6 S	09.11→	120/135/147				1987 482 226	→ 1402	
							1987 482 227	← 1393	
	2.0 SD	09.11→	100-105				1987 482 226	→ 1402	
							1987 482 227	← 1393	
	1.6 S	09.11→	120/135/147				0265 007 807 <sup>3</sup>		
							0265 007 808 <sup>4</sup>		
	2.0 SD	09.11→	100-105				0265 007 807 <sup>3</sup>		
							0265 007 808 <sup>4</sup>		
<b>Cooper One Cabrio [R 52]</b>									
	1.6	07.04-07.08	66				0986 473 415	← 48	F 026 A06 623 <sup>7</sup>
							0986 474 415	→ 48	F 026 A06 623 <sup>7</sup>
	1.6	07.04-07.08	66				0986 473 414	← 34	
							0986 474 414	→ 34	
	1.6	07.04-07.08	66				1987 482 230	→ 1435	
							1987 482 231	← 1433	
	1.6	07.04-07.08	66				0986 594 536 <sup>3</sup>		
							0986 594 537 <sup>4</sup>		
<b>Cooper One Cabrio [R 57]</b>									
	1.6	03.10→	72				0986 134 289	← 54	
							0986 135 289	→ 54	
	1.6	03.10→	72				0986 134 080	← 36	
							0986 135 080	→ 36	
	1.6	03.10→	72				1987 482 226	→ 1402	
							1987 482 227	← 1393	



		S							
	1.6	03.10→	72				0 265 007 807 <sup>3</sup>		
							0 265 007 808 <sup>4</sup>		
<b>Cooper One Clubman [R 55]</b>									
	1.4	03.09-02.10	70				0 986 134 289		← 54
							0 986 135 289		→ 54
	1.6	03.10-06.14	66/72				0 986 134 289		← 54
	1.6D						0 986 135 289		→ 54
	1.4	03.09-02.10	70				0 986 134 080		← 36
							0 986 135 080		→ 36
	1.6	03.10-06.14	66/72				0 986 134 080		← 36
	1.6D						0 986 135 080		→ 36
	1.4	03.09-02.10	70				1 987 482 228		→ 1483
							1 987 482 229		← 1474
	1.6	03.10-06.14	66/72				1 987 482 228		→ 1483
	1.6D						1 987 482 229		← 1474
	1.4	03.09-02.10	70				0 265 007 807 <sup>3</sup>		
							0 265 007 808 <sup>4</sup>		
	1.6	03.10-06.14	66/72				0 265 007 807 <sup>3</sup>		
	1.6D						0 265 007 808 <sup>4</sup>		
<b>Cooper One Countryman [R 60]</b>									
	1.6	09.10→	66/72				0 265 008 525 <sup>4</sup>		
	1.6D						0 265 008 526 <sup>3</sup>		
<b>Cooper One [R 50]</b>									
	1.4D	09.02-11.06	55/65				0 986 473 415		← 48 F 026 A06 623 <sup>7</sup>
	1.4i						0 986 474 415		→ 48 F 026 A06 623 <sup>7</sup>
	1.6	06.01-11.06	66				0 986 473 415		← 48 F 026 A06 623 <sup>7</sup>
							0 986 474 415		→ 48 F 026 A06 623 <sup>7</sup>
	1.4D	09.05-11.06	65				0 986 473 414		← 34
							0 986 474 414		→ 34
	1.4D	09.02-04.03	55				0 986 473 273		← 34
	1.4i						0 986 474 273		→ 34
		05.03-09.05	55				0 986 473 414		← 34
							0 986 474 414		→ 34
	1.6	06.01-04.03	66				0 986 473 273		← 34
							0 986 474 273		→ 34
		05.03-11.06	66				0 986 473 414		← 34
							0 986 474 414		→ 34
	1.4D	09.02-11.06	55/65				1 987 482 230		→ 1435
	1.4i						1 987 482 231		← 1433
	1.6	06.01-11.06	66				1 987 482 230		→ 1435
							1 987 482 231		← 1433



		S				?			
◀ MINI Cooper One [R 50]									
	1.4D	09.02-11.06	55/65				0986 594 536 <sup>3</sup>		
	1.4i						0986 594 537 <sup>4</sup>		
	1.6	06.01-11.06	66				0986 594 536 <sup>3</sup>		
							0986 594 537 <sup>4</sup>		
<b>Cooper One [R 56]</b>									
	1.4	03.07-02.10	55/70				0986 134 289		← 54
							0986 135 289		→ 54
	1.6	09.09-11.13	55/66/72				0986 134 289		← 54
	1.6D						0986 135 289		→ 54
	1.4	03.07-02.10	55/70				0986 134 080		← 36
							0986 135 080		→ 36
	1.6	09.09-11.13	55/66/72				0986 134 080		← 36
	1.6D						0986 135 080		→ 36
	1.4	03.07-02.10	55/70				1987 482 226		→ 1402
							1987 482 227		← 1393
	1.6	09.09-11.13	55/66/72				1987 482 226		→ 1402
	1.6D						1987 482 227		← 1393
	1.4	03.07-02.10	55/70				0265 007 807 <sup>3</sup>		
							0265 007 808 <sup>4</sup>		
	1.6	09.09-11.13	55/66/72				0265 007 807 <sup>3</sup>		
	1.6D						0265 007 808 <sup>4</sup>		
<b>Cooper Paceman [R 61]</b>									
	1.6, ALL4, D, D ALL4, S, S ALL4	03.13→	82/85-90/ 135/140				0265 008 525 <sup>4</sup>		
							0265 008 526 <sup>3</sup>		
	2.0D, D ALL4, SD, SD ALL4	03.13→	82/100-105				0265 008 525 <sup>4</sup>		
							0265 008 526 <sup>3</sup>		
<b>Cooper [R 50]</b>									
	1.6	06.01-11.07	85				0986 473 415		← 48
							0986 474 415		→ 48
	1.6	06.01-04.03	85				0986 473 273		← 34
							0986 474 273		→ 34
		05.03-11.07	85				0986 473 414		← 34
							0986 474 414		→ 34
	1.6	06.01-11.07	85				1987 482 230		→ 1435
							1987 482 231		← 1433
	1.6	06.01-11.07	85				0986 594 536 <sup>3</sup>		
							0986 594 537 <sup>4</sup>		



		S							
<b>Cooper [R 56]</b>									
	1.6, D, S	11.06-11.13	80/82/85-90/120/ 128/135/147				0 986 134 289		← 54
							0 986 135 289		→ 54
	2.0D	03.11-11.13	82/100-105				0 986 134 289		← 54
	2.0SD						0 986 135 289		→ 54
	1.6, D, S	11.06-11.13	80/82/85-90/120/ 128/135/147				0 986 134 080		← 36
							0 986 135 080		→ 36
	2.0D	03.11-11.13	82/100-105				0 986 134 080		← 36
	2.0SD						0 986 135 080		→ 36
	1.6, D, S	11.06-11.13	80/82/85-90/120/ 128/135/147				1 987 482 226		→ 1402
							1 987 482 227		← 1393
	2.0D	03.11-11.13	82/100-105				1 987 482 226		→ 1402
	2.0SD						1 987 482 227		← 1393
	1.6, D, S	11.06-11.13	80/82/85-90/120/ 128/135/147				0 265 007 807 <sup>3</sup>		
							0 265 007 808 <sup>4</sup>		
	2.0D	03.11-11.13	82/100-105				0 265 007 807 <sup>3</sup>		
	2.0SD						0 265 007 808 <sup>4</sup>		
<b>Cooper Roadster [R 59]</b>									
	1.6	02.12→	85-90/120/				0 986 134 289		← 54
	1.6 S		135/147				0 986 135 289		→ 54
	2.0SD	02.12→	100-105				0 986 134 289		← 54
							0 986 135 289		→ 54
	1.6	02.12→	85-90/120/				0 986 134 080		← 36
	1.6 S		135/147				0 986 135 080		→ 36
	2.0SD	02.12→	100-105				0 986 134 080		← 36
							0 986 135 080		→ 36
	1.6	02.12→	85-90/120/				1 987 482 226		→ 1402
	1.6 S		135/147				1 987 482 227		← 1393
	2.0SD	02.12→	100-105				1 987 482 226		→ 1402
							1 987 482 227		← 1393
	1.6	02.12→	85-90/120/				0 265 007 807 <sup>3</sup>		
	1.6 S		135/147				0 265 007 808 <sup>4</sup>		
	2.0SD	02.12→	100-105				0 265 007 807 <sup>3</sup>		
							0 265 007 808 <sup>4</sup>		
<b>Cooper S [R 53]</b>									
	1.6	03.02-07.04	120				0 986 473 415		← 48
							0 986 474 415		→ 48
		08.04-11.06	125		SBJ		0 986 473 415		← 48
							0 986 474 415		→ 48
									F 026 A06 623 <sup>7</sup>
									F 026 A06 623 <sup>7</sup>





		S							
<b>MINI Cooper S [R 53]</b>									
	1.6	03.02-04.03	120				0986 473 273		← 34
							0986 474 273		→ 34
		05.03-07.04	120				0986 473 414		← 34
							0986 474 414		→ 34
		08.04-11.06	125				0986 473 414		← 34
							0986 474 414		→ 34
	1.6	03.02-11.06	120/125				1987 482 230		→ 1435
							1987 482 231		← 1433
	1.6	03.02-11.06	120/125				0986 594 536 <sup>3</sup>		
							0986 594 537 <sup>4</sup>		
<b>John Cooper Works Cabrio [R 52]</b>									
	1.6	08.04-07.08	154				0986 473 414		← 34
							0986 474 414		→ 34
	1.6	08.04-07.08	154				1987 482 230		→ 1435
							1987 482 231		← 1433
	1.6	08.04-07.08	154				0986 594 536 <sup>3</sup>		
							0986 594 537 <sup>4</sup>		
<b>John Cooper Works Cabrio [R 57]</b>									
	1.6	03.09→	155				1987 482 226		→ 1402
							1987 482 227		← 1393
	1.6	03.09→	155				0265 007 807 <sup>3</sup>		
							0265 007 808 <sup>4</sup>		
<b>John Cooper Works Clubman [R 55]</b>									
	1.6	07.08-06.14	155				1987 482 228		→ 1483
							1987 482 229		← 1474
	1.6	07.08-06.14	155				0265 007 807 <sup>3</sup>		
							0265 007 808 <sup>4</sup>		
<b>John Cooper Works Countryman [R 60]</b>									
	1.6 All4	11.12→	160				0265 008 525 <sup>4</sup>		
							0265 008 526 <sup>3</sup>		
<b>John Cooper Works Coupé [R 58]</b>									
	1.6	09.11→	155				1987 482 226		→ 1402
							1987 482 227		← 1393



		S								
	1.6	09.11→	155					0 265 007 807 <sup>3</sup>		
								0 265 007 808 <sup>4</sup>		
<b>John Cooper Works Paceman [R 61]</b>										
	1.6 ALL4	03.13→	160					0 265 008 525 <sup>4</sup>		
								0 265 008 526 <sup>3</sup>		
<b>John Cooper Works [R 53]</b>										
	1.6	10.03-11.06	147/ 154-160					0 986 473 414		← 34
								0 986 474 414		→ 34
	1.6	10.03-11.06	147/ 154-160					1 987 482 230		→ 1435
								1 987 482 231		← 1433
	1.6	10.03-11.06	147/ 154-160					0 986 594 536 <sup>3</sup>		
								0 986 594 537 <sup>4</sup>		
<b>John Cooper Works [R 56]</b>										
	1.6 1.6 GP	07.08-11.13	155/160					1 987 482 226		→ 1402
								1 987 482 227		← 1393
	1.6 1.6 GP	07.08-11.13	155/160					0 265 007 807 <sup>3</sup>		
								0 265 007 808 <sup>4</sup>		
<b>John Cooper Works Roadster [R 59]</b>										
	1.6	02.12→	155					1 987 482 226		→ 1402
								1 987 482 227		← 1393
	1.6	02.12→	155					0 265 007 807 <sup>3</sup>		
								0 265 007 808 <sup>4</sup>		
<b>MITSUBISHI</b>										
<b>ASX [GA]</b>										
	1.6	04.10-06.12	86					1 987 482 517		← 1645
								1 987 482 518		→ 1627
	1.8	05.10→	103					1 987 482 517		← 1645
								1 987 482 518		→ 1627
	1.8 Di-D	04.10-06.12	85 110					1 987 482 518		→ 1627
	1.8 Di-D	04.10-06.12	85					1 987 482 517		← 1645
	1.8 Di-D 4x4	04.10-06.12	110					1 987 482 517		← 1645
	1.8 Di-D 4x4	04.10-06.12	85 110					1 987 482 519		→ 1632
								1 987 482 519		→ 1632
	2.0	05.10-08.12	109-110					1 987 482 518		→ 1627
		05.10→	109-110					1 987 482 517		← 1645
		09.12→	109-110					1 987 482 519		→ 1632





	◀ MITSUBISHI ASX [GA]						
	2.0 4x4	05.10→	110			1987 482 517	← 1645
						1987 482 519	→ 1632

Canter							
	2.8 D	05.98-05.99	69			F 026 A06 001	←
					OE	F 026 A06 003	→
					UE	F 026 A06 002	←
						F 026 A06 004	→

Canter [FE]							
	2.8 D	10.96-04.98	69			F 026 A07 680	←

Carisma [DA]							
	1.3 i 16V	07.01-12.03	60			0986 473 274	← 54
						0986 474 274	→ 54
	1.6 i 16V	05.96-02.99	66/73			0986 473 044	← 54
						0986 474 044	→ 54
					284	0986 473 274	← 54
						0986 474 274	→ 54
		03.99-12.03	73-76			0986 473 274	← 54
						0986 474 274	→ 54
					284	0986 473 274	← 54
						0986 474 274	→ 54
	1.8 GDI	05.96-06.00	85/92/103			0986 473 274	← 54
	1.8 i 16V					0986 474 274	→ 54
					284	0986 473 274	← 54
						0986 474 274	→ 54
	1.9 D Turbo	05.96-02.99	66			0986 473 044	← 54
						0986 474 044	→ 54
		03.99-06.00	66			0986 473 274	← 54
						0986 474 274	→ 54
	1.9 DI-D	07.00-12.03	75/85			0986 473 274	← 54
						0986 474 274	→ 54

	1.6 i 16V	05.96-09.98	66/73			0986 475 948	↔ 19
		10.98-02.99	66/73			F 026 002 566	↔ 19,05
		03.99-12.03	73-76			F 026 002 566	↔ 19,05
	1.8 GDI	05.96-09.98	85/92			0986 475 948	↔ 19
	1.8 i 16V	10.98-12.03	85/92			F 026 002 566	↔ 19,05
	1.8 i 16V	05.96-04.97	103			0986 475 948	↔ 19
	1.9 D Turbo	05.96-09.98	66			0986 475 948	↔ 19
		10.98-06.00	66			F 026 002 566	↔ 19,05

	1.3 i 16V	07.01-12.03	60			0986 473 354	← 38,1
						0986 474 354	→ 38,1
	1.6 i 16V	05.96-12.03	66/73-76			0986 473 354	← 38,1
						0986 474 354	→ 38,1
	1.8 GDI	05.97-02.99	92			0986 473 045	← 35
						0986 474 045	→ 35
		06.99-12.03	92			0986 473 354	← 38,1
						0986 474 354	→ 38,1
	1.8 i 16V	05.96-04.97	103			0986 473 045	← 35
						0986 474 045	→ 35



		S							
1.8i 16V		05.96-02.99	85				0 986 473 045		← 35
							0 986 474 045		→ 35
1.9 Di-D		07.00-12.03	75/85				0 986 473 354		← 38,1
							0 986 474 354		→ 38,1
1.3i 16V		07.01-11.02	60				1 987 482 245		← 1588
							1 987 482 246		→ 1525
1.6i 16V		05.96-02.99	66/73				1 987 477 676		← 1511
		03.99-05.00	73-76				1 987 477 677		→ 1511
		07.00-12.03	73-76				1 987 477 676		← 1511
							1 987 477 677		→ 1511
1.8 GDI		03.99-06.00	92				1 987 482 245		← 1588
		06.99-12.03	92				1 987 482 246		→ 1525
		ABO 05.97-02.99	92				1 987 477 676		← 1511
							1 987 477 677		→ 1511
1.8i 16V		ABO 05.96-04.97	103				1 987 477 676		← 1511
		05.96-02.99	85				1 987 477 677		→ 1511
							1 987 477 676		← 1511
							1 987 477 677		→ 1511
1.9 D Turbo		05.96-06.00	66				1 987 477 676		← 1511
							1 987 477 677		→ 1511
1.9 Di-D		07.00-12.03	75/85				1 987 482 245		← 1588
							1 987 482 246		→ 1525
1.3i 16V		07.01-12.03	60			LAB	0 265 006 224 <sup>3</sup>		
						RAB	0 265 006 223 <sup>3</sup>		
1.6i 16V		05.96-06.00	66/73-76			LAB,TBR	0 265 006 327 <sup>4</sup>		
		05.96-12.03	66/73-76			RAB,TBR	0 265 006 294 <sup>4</sup>		
						LAB	0 265 006 224 <sup>3</sup>		
						RAB	0 265 006 223 <sup>3</sup>		
1.8 GDI		05.96-06.00	85/92/103			LAB,TBR	0 265 006 327 <sup>4</sup>		
1.8i 16V		05.96-12.03	85/92/103			LAB	0 265 006 224 <sup>3</sup>		
						RAB	0 265 006 223 <sup>3</sup>		
						RAB,TBR	0 265 006 294 <sup>4</sup>		
1.9 D Turbo		05.96-06.00	66			LAB	0 265 006 224 <sup>3</sup>		
							0 265 006 327 <sup>4</sup>		
						RAB	0 265 006 223 <sup>3</sup>		
							0 265 006 294 <sup>4</sup>		
1.9 Di-D		07.00-12.03	75/85			LAB	0 265 006 224 <sup>3</sup>		
						RAB	0 265 006 223 <sup>3</sup>		
<b>Carisma Hatchback [DA]</b>									
1.6i 16V		05.95-02.99	66/73				0 986 473 044		← 54
							0 986 474 044		→ 54
						284	0 986 473 274		← 54
							0 986 474 274		→ 54
		03.99-12.03	73-76				0 986 473 274		← 54
							0 986 474 274		→ 54
						284	0 986 473 274		← 54
							0 986 474 274		→ 54
1.8 GDI		05.95-06.00	85/92/103				0 986 473 274		← 54
1.8i 16V							0 986 474 274		→ 54
						284	0 986 473 274		← 54
							0 986 474 274		→ 54



		S							
	<b>◀ MITSUBISHI Carisma Hatchback [DA]</b>								
1.9 D Turbo	05.96-02.99	66					0986 473 044		54
	03.99-06.00	66					0986 474 044		54
1.9 DI-D	07.00-12.03	75/85					0986 473 274		54
							0986 474 274		54
1.6 i 16V	05.95-09.98	66/73					0986 475 948		19
	10.98-02.99	66/73					F 026 002 566		19,05
1.8 GDI	05.95-09.98	85/92					0986 475 948		19
	10.98-12.03	73-76					F 026 002 566		19,05
1.8 i 16V	05.95-04.97	103					0986 475 948		19
1.9 D Turbo	05.96-09.98	66					0986 475 948		19
	10.98-06.00	66					F 026 002 566		19,05
1.6 i 16V	05.95-04.96	66					0986 473 045		35
	05.96-02.99	66					0986 474 045		35
1.8 GDI	05.97-02.99	92					0986 473 354		38,1
	06.99-12.03	92					0986 474 354		38,1
1.8 i 16V	05.95-04.97	103					0986 473 045		35
	05.95-02.99	85					0986 474 045		35
1.9 DI-D	07.00-12.03	75/85					0986 473 354		38,1
							0986 474 354		38,1
1.6 i 16V	05.95-02.99	66/73					1987 477 676		1511
	03.99-05.00	73-76					1987 477 677		1511
1.8 GDI	03.99-06.00	92					1987 477 676		1511
	06.99-12.03	92					1987 477 677		1511
1.8 i 16V	05.95-04.97	103					1987 477 676		1511
	05.95-02.99	85					1987 477 677		1511
1.9 D Turbo	05.96-06.00	66					1987 477 676		1511
	07.00-12.03	75/85					1987 477 677		1511
1.9 DI-D	07.00-12.03	75/85					1987 482 245		1588
							1987 482 246		1525
1.6 i 16V	05.95-04.96	66				LAB,TBR	0265 006 328 <sup>4</sup>		
	05.95-02.99	66				RAB,TBR	0265 006 225 <sup>4</sup>		
1.6 i 16V	05.95-04.96	66				LAB	0265 006 224 <sup>3</sup>		
	05.95-02.99	66				RAB	0265 006 223 <sup>3</sup>		

		S								
<b>1.6i 16V</b>	05.96-02.99	66					LAB,TBR	0 265 <b>006 327</b> <sup>4</sup>		
							RAB,TBR	0 265 <b>006 294</b> <sup>4</sup>		
	05.97-06.00	73-76						LAB,TBR	0 265 <b>006 327</b> <sup>4</sup>	
								RAB,TBR	0 265 <b>006 294</b> <sup>4</sup>	
	05.97-12.03	73-76						LAB	0 265 <b>006 224</b> <sup>3</sup>	
								RAB	0 265 <b>006 223</b> <sup>3</sup>	
<b>1.8 GDI</b>	05.97-06.00	92					LAB,TBR	0 265 <b>006 327</b> <sup>4</sup>		
	05.97-12.03	92					LAB	0 265 <b>006 224</b> <sup>3</sup>		
							RAB,TBR	0 265 <b>006 294</b> <sup>4</sup>		
<b>1.8i 16V</b>	05.95-04.96	85					LAB,TBR	0 265 <b>006 328</b> <sup>4</sup>		
							RAB,TBR	0 265 <b>006 225</b> <sup>4</sup>		
		103						LAB,TBR	0 265 <b>006 328</b> <sup>4</sup>	
								RAB,TBR	0 265 <b>006 225</b> <sup>4</sup>	
	05.95-04.97	103						LAB	0 265 <b>006 224</b> <sup>3</sup>	
		85						LAB	0 265 <b>006 224</b> <sup>3</sup>	
								RAB	0 265 <b>006 223</b> <sup>3</sup>	
	05.96-04.97	103						LAB,TBR	0 265 <b>006 329</b> <sup>4</sup>	
								RAB,TBR	0 265 <b>006 360</b> <sup>4</sup>	
	05.96-02.99	85						LAB,TBR	0 265 <b>006 327</b> <sup>4</sup>	
RAB,TBR								0 265 <b>006 294</b> <sup>4</sup>		
<b>1.9 D Turbo</b>	05.96-06.00	66					LAB	0 265 <b>006 224</b> <sup>3</sup>		
								0 265 <b>006 327</b> <sup>4</sup>		
							RAB	0 265 <b>006 223</b> <sup>3</sup>		
<b>1.9 DI-D</b>	07.00-12.03	75/85					LAB	0 265 <b>006 224</b> <sup>3</sup>		
							RAB	0 265 <b>006 223</b> <sup>3</sup>		

**Colt Cabrio [CZ]**

	<b>1.5</b>	03.06-07.08	80				0 986 <b>134 338</b>		54
							0 986 <b>135 338</b>		54
	<b>1.5</b> <b>1.5 Turbo</b>	03.06-07.08	80/110				0 986 <b>134 223</b>		
							0 986 <b>135 223</b>		
	<b>1.5</b> <b>1.5 Turbo</b>	03.06-07.08	80/110				1 987 <b>482 271</b>		1540
							1 987 <b>482 272</b>		1570
	<b>1.5</b>	03.06-07.08	80				0 265 <b>007 637</b> <sup>3</sup>		
							0 265 <b>007 638</b> <sup>4</sup>		
	<b>1.5 Turbo</b>	05.06-07.08	110					0 265 <b>007 638</b> <sup>4</sup>	
								LAB	0 265 <b>007 637</b> <sup>3</sup>
							RAB	0 265 <b>007 683</b> <sup>3</sup>	

**Colt [CA/CC]**

	<b>1.3i 12V</b>	ABO	12.91-11.95	55					F 026 <b>A08 184</b> <sup>6</sup>	
		ABS	12.91-11.95	55			0 986 <b>473 380</b>		53,95	F 026 <b>A03 470</b> <sup>7</sup>
	<b>1.6i, i 16V 2WD, i 16V 4WD</b>	12.91-12.96	66/83				0 986 <b>474 380</b>		53,95	F 026 <b>A03 470</b> <sup>7</sup>
							0 986 <b>473 380</b>		53,95	F 026 <b>A03 470</b> <sup>7</sup>
	<b>1.8i</b>	12.91-11.95	103						F 026 <b>A03 486</b> <sup>6</sup>	



















































◀ MITSUBISHI Colt [CA/CC]								
	1.3 i 12V	12.91-11.95	55			0986 475 668	↔ 19	
	1.6 i	12.91-12.96	66			0986 475 914	↔ 17,46	
	1.6 i 16V 2WD	12.91-11.95	83			0986 475 914	↔ 17,46	
	1.6 i 16V 4WD	12.91-11.95	83			0986 475 665	↔ 17,4	
	1.3 i 12V	12.91-11.95	55			0986 473 227	👁️ ← 30	
						0986 474 227	👁️ → 30	
	1.6 i, i 16V 2WD, i 16V 4WD	12.91-12.96	66/83			0986 473 227	👁️ ← 30	
						0986 474 227	👁️ → 30	
	1.8 i	12.91-11.95	103			0986 473 227	👁️ ← 30	
						0986 474 227	👁️ → 30	
Colt [CJ]								
	1.3 i 12V	11.95-06.03	55/60			0986 473 380	👁️ ← 53,95	F 026 A03 470 <sup>7</sup>
	1.3 i 16V					0986 474 380	👁️ → 53,95	F 026 A03 470 <sup>7</sup>
	1.5	11.95-05.00	69			0986 473 380	👁️ ← 53,95	F 026 A03 470 <sup>7</sup>
						0986 474 380	👁️ → 53,95	F 026 A03 470 <sup>7</sup>
	1.6 i 16V	11.95-06.03	66/76			0986 473 380	👁️ ← 53,95	F 026 A03 470 <sup>7</sup>
						0986 474 380	👁️ → 53,95	F 026 A03 470 <sup>7</sup>
	1.3 i 12V	ABO 11.95-06.03	55/60			0986 475 668	↔ 19	
	1.3 i 16V	ABS 11.95-06.03	55/60			0986 475 914	↔ 17,46	
	1.5	11.95-05.00	69			0986 475 668	↔ 19	
	1.5 i	10.04-10.12	77			0986 475 948	↔ 19	
	1.6 i 16V	ABO 11.95-06.03	66/76			0986 475 668	↔ 19	
		ABS 11.95-06.03	66/76			0986 475 914	↔ 17,46	
	1.3 i 12V	11.95-06.03	55/60			1987 482 062	← 1395	
	1.3 i 16V					1987 482 063	→ 1350	
	1.5	11.95-05.00	69			1987 482 062	← 1395	
						1987 482 063	→ 1350	
	1.6 i 16V	11.95-06.03	66/76			1987 482 062	← 1395	
						1987 482 063	→ 1350	
	1.3 i 12V	11.95-06.03	55/60		RAB	F 01G 09F 0DZ <sup>3</sup>		
	1.3 i 16V	03.98-06.03	55/60			F 01G 09F 0EJ <sup>4</sup>		
	1.6 i 16V	11.95-06.03	66/76		RAB	F 01G 09F 0DZ <sup>3</sup>		
		03.98-06.03	66/76			F 01G 09F 0EJ <sup>4</sup>		
Colt [CZ]								
	1.1	08.04-12.12	55			0986 134 338	👁️ ← 54	
						0986 135 338	👁️ → 54	
	1.3	04.04-04.13	70			0986 134 338	👁️ ← 54	
						0986 135 338	👁️ → 54	
	1.5	04.04-06.10	50/70/80			0986 134 338	👁️ ← 54	
	1.5 DI-D					0986 135 338	👁️ → 54	
	1.1	08.04-12.12	55			0986 475 956	↔ 19	
	1.3	04.04-04.13	70			0986 475 956	↔ 19	
	1.5 DI-D	08.04-09.08	50/70			0986 475 956	↔ 19	



		S							
	1.1	08.04-12.12	55				0 986 134 223		←
							0 986 135 223		→
	1.3	04.04-04.13	70				0 986 134 223		←
							0 986 135 223		→
	1.5, DI-D, Turbo	04.04-04.13	50/70/80/ 110				0 986 134 223		←
							0 986 135 223		→
	1.1	08.04-12.12	55			HTB	1 987 482 247	←	1525
						4SB	1 987 482 271	←	1540
							1 987 482 272	→	1570
	1.3	04.04-04.13	70			HTB	1 987 482 247	←	1525
						4SB	1 987 482 271	←	1540
							1 987 482 272	→	1570
	1.5	04.04-04.13	80/110				1 987 482 271	←	1540
	1.5 Turbo						1 987 482 272	→	1570
	1.5 DI-D	08.04-09.08	50/70			HTB	1 987 482 247	←	1525
						4SB	1 987 482 271	←	1540
						1 987 482 272	→	1570	
	1.1	08.04-05.09	55				0 265 007 637 <sup>3</sup>		
		08.04-12.12	55				0 265 007 638 <sup>4</sup>		
	1.3	04.04-05.09	70				0 265 007 637 <sup>3</sup>		
		04.04-04.13	70				0 265 007 638 <sup>4</sup>		
	1.5	04.04-05.09	50/70/80				0 265 007 637 <sup>3</sup>		
	1.5 DI-D	04.04-06.10	50/70/80				0 265 007 638 <sup>4</sup>		
	1.5 Turbo	01.05-05.09	110			LAB	0 265 007 637 <sup>3</sup>		
	01.05-04.13	110			RAB	0 265 007 683 <sup>3</sup>			
<b>Colt Plus</b>									
	1.5 i	10.04-10.12	77				0 986 475 948	↔	19
<b>Eclipse [D2/3]</b>									
	1.8 i	01.90-03.94	68				0 986 473 049		← 53,9 F 026 A03 486 <sup>7</sup>
							0 986 474 049		→ 53,9 F 026 A03 486 <sup>7</sup>
	2.0 i 16V	01.90-03.94	110				0 986 473 396		← 60,21 F 026 A03 473 <sup>7</sup>
							0 986 474 396		→ 60,21 F 026 A03 473 <sup>7</sup>
		08.95-04.99	104				0 986 473 391		← 60,21 F 026 A03 473 <sup>7</sup>
							0 986 474 391		→ 60,21 F 026 A03 473 <sup>7</sup>
	2.0 i 16V Turbo	08.90-03.94	147				0 986 473 049		← 53,9 F 026 A03 486 <sup>7</sup>
							0 986 474 049		→ 53,9 F 026 A03 486 <sup>7</sup>
2.0 i 16V 4WD	04.91-03.94	110						F 026 A08 129 <sup>7</sup>	
	2.0 i 16V	01.90-03.94	110				0 986 473 047		← 34,8
							0 986 474 047		→ 34,8
<b>Galant</b>									
	2.0 i	01.97-08.97	100				0 986 473 391		← 60,21 F 026 A03 473 <sup>7</sup>
							0 986 474 391		→ 60,21 F 026 A03 473 <sup>7</sup>
		09.97-10.02	100						F 026 A03 467 <sup>7</sup>





								
<b>◀ MITSUBISHI Galant</b>								
								
	2.0i	01.97-12.03	100			0986 473 205	 ← 35	
						0986 474 205	 → 35	
								
	2.0i	01.97-12.03	100			1987 477 862	← 1851	
						1987 482 183	→ 1876	
<b>Galant [EA]</b>								
								
	2.0 D Turbo	10.96-07.98	66/100			0986 473 391	 ← 60,21	F 026 A03 473 <sup>7</sup>
	2.0 i 16V	08.98-02.00	66/100			0986 474 391	 → 60,21	F 026 A03 473 <sup>7</sup>
	2.4 GDI	12.98-02.00	110					F 026 A03 467 <sup>7</sup>
	2.5 i V6-24	10.96-11.97	118			0986 473 391	 ← 60,21	F 026 A03 473 <sup>7</sup>
		12.97-02.00	118			0986 474 391	 → 60,21	F 026 A03 467 <sup>7</sup>
								
	2.0 i 16V	10.96-05.03	100			0986 473 205	 ← 35	
						0986 474 205	 → 35	
	2.4 GDI	12.98-05.03	110			0986 473 205	 ← 35	
						0986 474 205	 → 35	
	2.5 i V6-24	10.96-05.03	118			0986 473 205	 ← 35	
						0986 474 205	 → 35	
								
	2.0 i 16V	10.96-05.03	100			1987 477 862	← 1851	
						1987 482 183	→ 1876	
	2.4 GDI	12.98-05.03	110			1987 477 862	← 1851	
						1987 482 183	→ 1876	
	2.5 i V6-24	10.96-05.03	118			1987 477 862	← 1851	
						1987 482 183	→ 1876	
<b>Galant [E5...8]</b>								
								
	1.8 i 16V	ABO 11.92-05.96	85-93					F 026 A03 486 <sup>6</sup>
		ABS 11.92-05.96	85-93			0986 473 391	 ← 60,21	F 026 A03 473 <sup>7</sup>
						0986 474 391	 → 60,21	F 026 A03 473 <sup>7</sup>
	2.0 D Turbo	ABO 11.92-10.96	66-69					F 026 A03 486 <sup>6</sup>
		ABS 11.92-10.96	66-69			0986 473 391	 ← 60,21	F 026 A03 473 <sup>7</sup>
						0986 474 391	 → 60,21	F 026 A03 473 <sup>7</sup>
	2.0 i V6-24, i V6-24 4WS, i 16V, i 16V 4WD	11.92-05.96	101/110			0986 473 391	 ← 60,21	F 026 A03 473 <sup>7</sup>
						0986 474 391	 → 60,21	F 026 A03 473 <sup>7</sup>
	2.5 i V6-24	11.92-05.96	125					F 026 A03 467 <sup>7</sup>
								
	1.8 i 16V	11.92-05.96	85-93			0986 473 205	 ← 35	
						0986 474 205	 → 35	
	2.0 D Turbo	11.92-10.96	66-69			0986 473 205	 ← 35	
						0986 474 205	 → 35	
	2.0 i V6-24	11.92-05.96	110			0986 473 205	 ← 35	
	2.0 i V6-24 4WS					0986 474 205	 → 35	
	2.0 i 16V	11.92-05.96	101			0986 473 205	 ← 35	
						0986 474 205	 → 35	
	2.0 i 16V 4WD	11.92-05.96	101					F 026 A06 616 <sup>7</sup>
	2.5 i V6-24	11.92-05.96	125					F 026 A06 616 <sup>7</sup>





**Galant Hatchback [E5...8]**

	<b>1.8i 16V</b>	ABO 11.92-05.96 93							F 026 <b>A03 486</b> <sup>6</sup>
		ABS 11.92-05.96 93			0 986 <b>473 391</b>		← 60,21	F 026 <b>A03 473</b> <sup>7</sup>	
					0 986 <b>474 391</b>		→ 60,21	F 026 <b>A03 473</b> <sup>7</sup>	
	<b>2.0D Turbo</b>	ABO 11.92-10.96 66-69						F 026 <b>A03 486</b> <sup>6</sup>	
		ABS 11.92-10.96 66-69			0 986 <b>473 391</b>		← 60,21	F 026 <b>A03 473</b> <sup>7</sup>	
					0 986 <b>474 391</b>		→ 60,21	F 026 <b>A03 473</b> <sup>7</sup>	
	<b>2.0i V6-24, i V6-24 4WS, i 16V, i 16V 4WD</b>	11.92-05.96 101/110			0 986 <b>473 391</b>		← 60,21	F 026 <b>A03 473</b> <sup>7</sup>	
					0 986 <b>474 391</b>		→ 60,21	F 026 <b>A03 473</b> <sup>7</sup>	
	<b>2.5i V6-24</b>	11.92-05.96 125						F 026 <b>A03 467</b> <sup>7</sup>	

	<b>1.8i 16V</b>	11.92-05.96 93			0 986 <b>473 205</b>		← 35		
					0 986 <b>474 205</b>		→ 35		
	<b>2.0D Turbo</b>	11.92-10.96 66-69			0 986 <b>473 205</b>		← 35		
					0 986 <b>474 205</b>		→ 35		
	<b>2.0i V6-24</b>	11.92-05.96 110			0 986 <b>473 205</b>		← 35		
	<b>2.0i V6-24 4WS</b>				0 986 <b>474 205</b>		→ 35		
	<b>2.0i 16V</b>	11.92-05.96 101			0 986 <b>473 205</b>		← 35		
					0 986 <b>474 205</b>		→ 35		
	<b>2.0i 16V 4WD</b>	11.92-05.96 101						F 026 <b>A06 616</b> <sup>7</sup>	
	<b>2.5i V6-24</b>	11.92-05.96 125						F 026 <b>A06 616</b> <sup>7</sup>	

**Galant Station Wagon**

	<b>2.5i V6-24</b>	10.96-11.97 118			0 986 <b>473 391</b>		← 60,21	F 026 <b>A03 473</b> <sup>7</sup>	
					0 986 <b>474 391</b>		→ 60,21	F 026 <b>A03 473</b> <sup>7</sup>	
		12.97-02.00 118						F 026 <b>A03 467</b> <sup>7</sup>	

	<b>2.5i V6-24</b>	10.96-09.02 118			0 986 <b>473 205</b>		← 35		
					0 986 <b>474 205</b>		→ 35		

	<b>2.5i V6-24</b>	10.96-09.02 118			1 987 <b>477 862</b>		← 1851		
					1 987 <b>482 183</b>		→ 1876		

**Galant Station Wagon [EA]**

	<b>2.0D Turbo</b>	10.96-07.98 66/100			0 986 <b>473 391</b>		← 60,21	F 026 <b>A03 473</b> <sup>7</sup>	
	<b>2.0i 16V</b>				0 986 <b>474 391</b>		→ 60,21	F 026 <b>A03 473</b> <sup>7</sup>	
		08.98-02.00 66/100						F 026 <b>A03 473</b> <sup>7</sup>	
	<b>2.4 GDI</b>	12.98-02.00 110						F 026 <b>A03 467</b> <sup>7</sup>	





























	<b>2.0i 16V</b>	10.96-09.02 100			0 986 <b>473 205</b>		← 35		
					0 986 <b>474 205</b>		→ 35		
	<b>2.4 GDI</b>	12.98-09.02 110			0 986 <b>473 205</b>		← 35		
					0 986 <b>474 205</b>		→ 35		

	<b>2.0i 16V</b>	10.96-09.02 100			1 987 <b>477 862</b>		← 1851		
					1 987 <b>482 183</b>		→ 1876		
	<b>2.4 GDI</b>	12.98-09.02 110			1 987 <b>477 862</b>		← 1851		
					1 987 <b>482 183</b>		→ 1876		



























◀ MITSUBISHI								
<b>Grandis</b>								
	2.0 DI-D	06.05-11.10	100-103					F 026 <b>A06 147</b> <sup>7</sup>
	2.4	01.04-11.10	121					F 026 <b>A06 147</b> <sup>7</sup>
	2.0 DI-D	06.05-11.10	100-103					F 026 <b>A06 143</b> <sup>7</sup>
	2.4	01.04-11.10	121					F 026 <b>A06 143</b> <sup>7</sup>
<b>i-MiEV</b>								
		10.10→	47-49			0986 <b>475 948</b>	↔ 19	
		10.10→	47-49			0265 <b>008 370</b> <sup>3</sup>		
					LAB	0265 <b>008 668</b> <sup>4</sup>		
					RAB	0265 <b>008 669</b> <sup>4</sup>		
<b>L 200</b>								
	2.5 D Turbo	08.97-12.03	64			0986 <b>473 048</b>	↔ 57	
						0986 <b>473 153</b>	↔ 42,73	F 026 <b>A03 467</b> <sup>7</sup>
						0986 <b>474 048</b>	→ 57	
						0986 <b>474 153</b>	→ 42,73	F 026 <b>A03 467</b> <sup>7</sup>
	2.5 D Turbo	08.97-12.03	64			0986 <b>475 921</b>	→ 22,2	
						0986 <b>475 922</b>	← 22,2	
<b>L 200 Endeavor</b>								
	2.5 D	06.95→	55-57			0986 <b>475 919</b>	→ 23,8	
						0986 <b>475 920</b>	← 23,8	
<b>L 200 Forte [K7]</b>								
	2.4 i4x4	ABO 01.96-07.99	97			0986 <b>473 169</b>	↔ 60,21	F 026 <b>A03 473</b> <sup>7</sup>
		08.99-06.01	97			0986 <b>474 169</b>	↔ 60,21	F 026 <b>A03 473</b> <sup>7</sup>
		ABS 01.96→	97			0986 <b>473 153</b>	↔ 42,73	F 026 <b>A06 622</b> <sup>7</sup>
						0986 <b>474 153</b>	↔ 42,73	F 026 <b>A03 467</b> <sup>7</sup>
	2.5 D Turbo Interc.	ABO 01.97-05.00	73-85			0986 <b>473 169</b>	↔ 60,21	F 026 <b>A03 473</b> <sup>7</sup>
		06.00→	73-85			0986 <b>474 169</b>	↔ 60,21	F 026 <b>A03 473</b> <sup>7</sup>
		ABS 01.97→	73-85			0986 <b>473 153</b>	↔ 42,73	F 026 <b>A03 467</b> <sup>7</sup>
						0986 <b>474 153</b>	↔ 42,73	F 026 <b>A03 467</b> <sup>7</sup>
	2.4 i4x4	01.96-01.00	97			0986 <b>475 919</b>	→ 23,8	
		02.00→	97			0986 <b>475 920</b>	← 23,8	
						F 026 <b>A05 985</b>	→	
						F 026 <b>A05 986</b>	←	



		S							
		2.5 D Turbo Interc.	01.97-01.00	73-85			0 986 475 919	→ 23,8	
			02.00→	73-85			0 986 475 920	← 23,8	
							F 026 A05 985	→	
							F 026 A05 986	←	
		2.4 i 4x4	01.96-06.01	97			1 987 482 069	→ 1995	
			01.96→	97			1 987 482 068	← 1995	
		2.5 D Turbo Interc.	01.97→	73-85			1 987 482 068	← 1995	
							1 987 482 069	→ 1995	
<b>L 200 [KA]</b>									
		2.5 DI-D	04.10→	94-100		TW			F 026 A06 622 <sup>7</sup>
		2.5 DI-D	ABO 04.10→	94-100		TW	F 026 A06 944	←	
							F 026 A06 945	→	
			ABS 04.10→	94-100		TW	F 026 A06 945	↔	
		2.5 DI-D	04.10→	94-100		BFE	1 987 482 514	244	
						BFE, TW	1 987 482 515	← 2023	
							1 987 482 516	→ 2018	
<b>L 200 [KB]</b>									
		2.5 DI-D 4x4	12.05→	100/123/ 131					F 026 A06 622 <sup>7</sup>
		2.5 DI-D 4x4	ABO 12.05→	100			F 026 A06 944	←	
							F 026 A06 945	→	
			10.07→	123			F 026 A06 944	←	
							F 026 A06 945	→	
			04.10→	131			F 026 A06 944	←	
							F 026 A06 945	→	
			ABS 12.05→	100			F 026 A06 945	↔	
			10.07→	123			F 026 A06 945	↔	
			04.10→	131			F 026 A06 945	↔	
		2.5 DI-D 4x4	12.05→	100/123/ 131		BFE	1 987 482 514	244	
							1 987 482 515	← 2023	
							1 987 482 516	→ 2018	
<b>L 200 [KL]</b>									
		2.4 DI-D	02.15→	113/133					F 026 A06 622 <sup>7</sup>
		2.4 DI-D	02.15→	113/133			F 026 A06 945	↔	



















































◀ MITSUBISHI								
<b>L 200 [K0-K3]</b>								
	1.6		11.86-03.95	48		0986 473 046	← 57	F 026 A08 098 <sup>7</sup>
						0986 474 046	→ 576	F 026 A08 098 <sup>7</sup>
	2.0 2WD		11.86-05.95	65		0986 473 046	← 57	F 026 A08 098 <sup>7</sup>
						0986 474 046	→ 576	F 026 A08 098 <sup>7</sup>
	2.0 4WD		11.86-05.94	65		0986 473 048	← 57	
						0986 474 048	→ 57	
	2.4 i 2WD		06.90-11.97	82-87		0986 473 046	← 57	F 026 A08 098 <sup>7</sup>
						0986 474 046	→ 576	F 026 A08 098 <sup>7</sup>
	2.4 i 4WD		06.94-11.97	82		0986 473 048	← 57	
						0986 474 048	→ 57	
	2.5 D Turbo 4WD		11.92-03.01	73		0986 473 048	← 57	
						0986 474 048	→ 57	
2.5 D 2WD		10.84-05.96	54		0986 473 046	← 57	F 026 A08 098 <sup>7</sup>	
					0986 474 046	→ 576	F 026 A08 098 <sup>7</sup>	
2.6 4x4		11.89-05.95	76		0986 473 048	← 57		
					0986 474 048	→ 57		
	1.6		11.86-03.95	48		0986 475 919	→ 23,8	
						0986 475 920	← 23,8	
	2.0 2WD		11.86-05.95	65		0986 475 919	→ 23,8	
						0986 475 920	← 23,8	
	2.0 4WD		11.86-05.94	65		0986 475 921	→ 22,2	
						0986 475 922	← 22,2	
	2.4 i 2WD		06.90-11.97	82-87		0986 475 919	→ 23,8	
						0986 475 920	← 23,8	
	2.4 i 4WD		06.94-11.97	82		0986 475 921	→ 22,2	
						0986 475 922	← 22,2	
	2.5 D Turbo 4WD		11.92-03.01	73		0986 475 921	→ 22,2	
						0986 475 922	← 22,2	
2.5 D 2WD		10.84-05.96	54		0986 475 919	→ 23,8		
					0986 475 920	← 23,8		
2.6 4x4		11.89-05.95	76		0986 475 919	→ 23,8		
					0986 475 920	← 23,8		
	1.6		11.86-03.95	48		1987 482 066	← 1888	
						1987 482 067	→ 2350	
	2.0 2WD		11.86-05.95	65		1987 482 066	← 1888	
						1987 482 067	→ 2350	
	2.4 i 2WD		06.90-11.97	82-87	FLR	1987 482 066	← 1888	
						1987 482 067	→ 2350	
2.5 D 2WD		10.84-05.96	54		1987 482 066	← 1888		
					1987 482 067	→ 2350		
<b>L 200 [K6/K7]</b>								
	2.0 i 16V		05.00-06.01	90				F 026 A06 622 <sup>7</sup>
	2.4 i 4WD	ABO	01.96-07.99	97		0986 473 169	← 60,21	F 026 A03 473 <sup>7</sup>
						0986 474 169	→ 60,21	F 026 A03 473 <sup>7</sup>
			08.99-12.07	97				F 026 A06 622 <sup>7</sup>
		ABS	01.96-12.07	97		0986 473 153	← 42,73	F 026 A03 467 <sup>7</sup>
						0986 474 153	→ 42,73	F 026 A03 467 <sup>7</sup>
2.5 D Turbo Interc. 2WD	ABO	05.00-12.07	74-85				F 026 A06 622 <sup>7</sup>	
	ABS	01.96-12.07	74-85				F 026 A03 467 <sup>7</sup>	

								
2.5 D Turbo Interc. 4WD	ABO	01.96-07.99	73-85			0 986 473 169	 ← 60,21	F 026 A03 473 <sup>7</sup>
						0 986 474 169	 → 60,21	F 026 A03 473 <sup>7</sup>
		08.99-12.07	73-85					F 026 A06 622 <sup>7</sup>
2.5 D 2WD	ABO	06.00-06.01	55-64					F 026 A06 622 <sup>7</sup>
	ABS	06.95-06.01	55-64					F 026 A03 467 <sup>7</sup>
2.5 D, D Turbo Interc. 4WD, D 4WD	ABS	01.96-12.07	64/73-85			0 986 473 153	 ← 42,73	F 026 A03 467 <sup>7</sup>
						0 986 474 153	 → 42,73	F 026 A03 467 <sup>7</sup>
2.5 D	ABO	01.96-05.00	64			0 986 473 169	 ← 60,21	F 026 A03 473 <sup>7</sup>
2.5 D 4WD		06.00-06.01	64			0 986 474 169	 → 60,21	F 026 A03 473 <sup>7</sup>
								F 026 A06 622 <sup>7</sup>
								
	2.0 i 16V	01.96-01.00	90			0 986 475 919	→ 23,8	
						0 986 475 920	← 23,8	
						F 026 A05 985	→	
		02.00-06.01	90			F 026 A05 986	←	
2.4 i 4WD		01.96-01.00	97			0 986 475 919	→ 23,8	
						0 986 475 920	← 23,8	
						F 026 A05 985	→	
		02.00-12.07	97			F 026 A05 986	←	
2.5 D Turbo Interc. 2WD		01.96-01.00	74-85			0 986 475 919	→ 23,8	
						0 986 475 920	← 23,8	
						0 986 475 919	→ 23,8	
						0 986 475 920	← 23,8	
						F 026 A05 985	→	
		11.02-02.03	74-85			F 026 A05 986	←	
		03.03-12.07	74-85			F 026 A05 985	→	
						F 026 A05 986	←	
2.5 D		06.95-01.00	55-64/			0 986 475 919	→ 23,8	
2.5 D Turbo Interc. 4WD			73-85			0 986 475 920	← 23,8	
2.5 D 2WD		02.00-12.07	55-64/			F 026 A05 985	→	
2.5 D 4WD			73-85			F 026 A05 986	←	
								
	2.4 i 4WD	01.96-06.01	97			1 987 482 069	→ 1995	
		01.96-12.07	97			1 987 482 068	← 1995	
2.5 D Turbo Interc. 4WD		01.96-12.07	73-85		TW	1 987 482 068	← 1995	
						1 987 482 069	→ 1995	
						1 987 482 401	← 1720	
						1 987 482 402	→ 2360	
						1 987 482 401	← 1720	
2.5 D		01.96-06.01	64			1 987 482 401	← 1720	
2.5 D 4WD						1 987 482 402	→ 2360	
<b>L 300 Truck [L]</b>								
								
	1.6	11.86-05.94	48-51					F 026 A08 036 <sup>7</sup>
						2.5 D	11.86-05.94	52
								
	1.6	11.86-05.94	48-51			0 986 475 718	← 20,6	
						0 986 475 719	→ 20,6	
						0 986 475 718	← 20,6	
						0 986 475 719	→ 20,6	
2.5 D		11.86-05.94	52			0 986 475 718	← 20,6	
						0 986 475 719	→ 20,6	
<b>L 300 Truck [P]</b>								
								
	2.0 i 16V	06.94-04.00	65/85			0 986 475 921	→ 22,2	
						2.0 16V		0 986 475 922



























		S				?			
	<b>◀ MITSUBISHI L 300 Truck [P]</b>								
	2.5 D Turbo	06.94-12.01	64				0986 475 921	→ 22,2	
							0986 475 922	← 22,2	
	<b>L 300 Van [P]</b>								
	1.6 2WD	11.86-05.94	48-51				0986 473 046	← 57	F 026 A08 0987
							0986 474 046	→ 576	F 026 A08 0987
	2.0 i 2WD	11.88-12.01	65/66				0986 473 046	← 57	F 026 A08 0987
	2.0 2WD						0986 474 046	→ 576	F 026 A08 0987
	2.4 i 2WD	11.91-05.94	82				0986 473 046	← 57	F 026 A08 0987
							0986 474 046	→ 576	F 026 A08 0987
	2.4 i 4WD	11.88-05.94	82				0986 473 048	← 57	
							0986 474 048	→ 57	
	2.5 D Turbo 4WD	11.88-12.01	62-64				0986 473 048	← 57	
							0986 474 048	→ 57	
	2.5 D 2WD	11.86-12.00	51-53				0986 473 046	← 57	F 026 A08 0987
							0986 474 046	→ 576	F 026 A08 0987
	1.6 2WD	11.86-05.94	48-51				0986 475 718	← 20,6	
							0986 475 719	→ 20,6	
	2.0 i 2WD	11.88-12.01	65/66				0986 475 718	← 20,6	
	2.0 2WD						0986 475 719	→ 20,6	
	2.4 i 2WD	11.88-05.94	82				0986 475 718	← 20,6	
	2.4 i 4WD						0986 475 719	→ 20,6	
	2.5 D Turbo 4WD	11.86-12.01	51-53/ 62-64				0986 475 718	← 20,6	
	2.5 D 2WD						0986 475 719	→ 20,6	
	<b>L 300 Wagon [P]</b>								
	1.6	11.86-05.94	48-51				0986 473 046	← 57	F 026 A08 0987
							0986 474 046	→ 576	F 026 A08 0987
	2.0 i 2WD	06.96-08.97	83				0986 473 046	← 57	F 026 A08 0987
							0986 474 046	→ 576	F 026 A08 0987
	2.0 2WD	11.86-06.95	66				0986 473 046	← 57	F 026 A08 0987
							0986 474 046	→ 576	F 026 A08 0987
	2.4 i 2WD	11.90-05.96	82				0986 473 046	← 57	F 026 A08 0987
							0986 474 046	→ 576	F 026 A08 0987
	2.4 i 4WD	11.88-06.95	82				0986 473 048	← 57	
							0986 474 048	→ 57	
	2.5 D Turbo 4WD	12.87-05.96	62-64				0986 473 048	← 57	
							0986 474 048	→ 57	
	2.5 D 2WD long	11.86-12.00	51				0986 473 046	← 57	F 026 A08 0987
	2.5 D 2WD short						0986 474 046	→ 576	F 026 A08 0987
	1.6	11.86-05.94	48-51				0986 475 718	← 20,6	
							0986 475 719	→ 20,6	
	2.0 i 2WD	06.96-08.97	83				0986 475 718	← 20,6	
							0986 475 719	→ 20,6	
	2.0 2WD	11.86-06.95	66				0986 475 718	← 20,6	
							0986 475 719	→ 20,6	
	2.4 i 2WD	11.88-05.96	82				0986 475 718	← 20,6	
	2.4 i 4WD						0986 475 719	→ 20,6	
	2.5 D Turbo 4WD, D 2WD long, D 2WD short	11.86-12.00	51/62-64				0986 475 718	← 20,6	
							0986 475 719	→ 20,6	



								
<b>L 400</b>								
								
	2.0i	ABO	12.94-03.01	83-85		0 986 473 169		← 60,21
						0 986 474 169		→ 60,21
		ABS	12.94-03.01	83-85		0 986 473 507		← 43
						0 986 474 507		→ 43
	2.4i		12.94-03.01	97		0 986 473 153		← 42,73 F 026 A03 467 <sup>7</sup>
						0 986 474 153		→ 42,73 F 026 A03 467 <sup>7</sup>
	2.5 D Turbo 2WD	ABO	12.94-03.01	64		0 986 473 169		← 60,21
						0 986 474 169		→ 60,21
		ABS	12.94-03.01	64		0 986 473 507		← 43
						0 986 474 507		→ 43
	2.5 D Turbo 4WD		12.94-03.01	64		0 986 473 153		← 42,73 F 026 A03 467 <sup>7</sup>
						0 986 474 153		→ 42,73 F 026 A03 467 <sup>7</sup>
								
	2.0i		12.94-03.01	83-85	FKR	0 986 475 921		↔ 22,2
					FLR	0 986 475 919		↔ 23,8
	2.4i		12.94-03.01	97		0 986 475 921		↔ 22,2
	2.5 D Turbo 2WD		12.94-03.01	64	FKR	0 986 475 921		↔ 22,2
					FLR	0 986 475 919		↔ 23,8
	2.5 D Turbo 4WD		12.94-03.01	64		0 986 475 921		↔ 22,2
<b>Lancer</b>								
								
	1.6i		07.99-02.01	81				F 026 A03 486 <sup>7</sup>
	1.8i		01.90→	91				F 026 A03 486 <sup>7</sup>
								
	1.6i		12.95-09.00	73,5		0 986 475 668		↔ 19
			07.99-02.01	81		0 986 475 668		↔ 19
			10.00-12.07	73,5		0 986 475 948		↔ 19
			11.03→	81		0 986 475 948		↔ 19
	1.8i		01.90-06.99	91		0 986 475 914		↔ 17,46
								
	1.6i		07.99-02.01	81		F 01G 09F 0EK <sup>4</sup>		
					RAB	F 01G 09F 0DZ <sup>3</sup>		
	1.8i		01.90→	91		F 01G 09F 0DZ <sup>3</sup>		
			03.98-06.99	91		F 01G 09F 0EJ <sup>4</sup>		
		07.99→	91		F 01G 09F 0EK <sup>4</sup>			
<b>Lancer [CA/CB/CD]</b>								
								
	1.3i	ABO	07.93-12.96	58				F 026 A08 184 <sup>6</sup>
		ABS	07.93-12.96	58		0 986 473 380		← 53,95 F 026 A03 470 <sup>7</sup>
					0 986 474 380		→ 53,95 F 026 A03 470 <sup>7</sup>	
	1.5		12.91-10.96	67				F 026 A08 184 <sup>6</sup>
	1.6i 16V		05.92-12.96	66/83		0 986 473 380		← 53,95 F 026 A03 470 <sup>7</sup>
						0 986 474 380		→ 53,95 F 026 A03 470 <sup>7</sup>
	1.8i 16V		05.92-12.96	100-103				F 026 A03 486 <sup>6</sup>
	2.0D		05.92-12.96	50/54		0 986 473 380		← 53,95 F 026 A03 470 <sup>7</sup>
						0 986 474 380		→ 53,95 F 026 A03 470 <sup>7</sup>







































								
◀ MITSUBISHI Lancer [CA/CB/CD]								
								
	1.3i	07.93-12.96	58			0986 475 668	↔ 19	
	1.5	12.91-10.96	67			0986 475 668	↔ 19	
	1.6i 16V	05.92-12.96	66/83			0986 475 914	↔ 17,46	
	2.0D	05.92-12.96	50/54			0986 475 914	↔ 17,46	
	1.3i	07.93-12.96	58			0986 473 227	👁️ ← 30	
						0986 474 227	👁️ → 30	
	1.6i 16V	05.92-12.96	66/83			0986 473 227	👁️ ← 30	
						0986 474 227	👁️ → 30	
	1.8i 16V	05.92-12.96	100-103			0986 473 227	👁️ ← 30	
						0986 474 227	👁️ → 30	
2.0D		05.92-12.96	50/54			0986 473 227	👁️ ← 30	
						0986 474 227	👁️ → 30	
								
	1.3i	07.93-12.96	58	TBR		1987 482 163	→ 1510	
	1.5	12.91-10.96	67			1987 482 163	→ 1510	
	1.6i 16V	05.92-12.96	66/83	TBR		1987 482 163	→ 1510	
	2.0D	05.92-12.96	50/54	TBR		1987 482 163	→ 1510	
<b>Lancer [CC]</b>								
								
	1.5	10.92-06.96	65					F 026 A08 184 <sup>6</sup>
								
	1.5	10.92-06.96	65			0986 475 668	↔ 19	
								
	1.5	10.92-06.96	65			1987 482 163	→ 1510	
<b>Lancer [CK/CP/CN]</b>								
								
	1.3i 12V	11.95-05.01	55			0986 473 380	👁️ ← 53,95	F 026 A03 470 <sup>7</sup>
						0986 474 380	👁️ → 53,95	F 026 A03 470 <sup>7</sup>
1.5		11.95-09.00	67-69			0986 473 380	👁️ ← 53,95	F 026 A03 470 <sup>7</sup>
						0986 474 380	👁️ → 53,95	F 026 A03 470 <sup>7</sup>
1.6i 16V	11.95-09.00	66			0986 473 380	👁️ ← 53,95	F 026 A03 470 <sup>7</sup>	
						0986 474 380	👁️ → 53,95	F 026 A03 470 <sup>7</sup>
								
	1.3i 12V	ABO 11.95-05.01	55			0986 475 668	↔ 19	
		ABS 11.95-05.01	55			0986 475 914	↔ 17,46	
	1.5	11.95-09.00	67-69			0986 475 668	↔ 19	
	1.6i 16V	11.95-09.00	66			0986 475 668	↔ 19	
								
	1.3i 12V	11.95-05.01	55	RAB		F 01G 09F 0DZ <sup>3</sup>		
		03.98-05.01	55			F 01G 09F 0EJ <sup>4</sup>		

		S				?			
<b>Lancer [CS/CT]</b>									
	1.3i	06.03-04.10	60						F 026 A06 143 <sup>7</sup>
	1.6i	06.03-04.10	72						F 026 A06 143 <sup>7</sup>
	2.0i	06.02-04.10	99						F 026 A06 143 <sup>7</sup>
	1.3i	06.03-04.10	60				1 987 482 533	← 1535	
							1 987 482 534	→ 1525	
	1.6i	06.03-04.10	72				1 987 482 533	← 1535	
							1 987 482 534	→ 1525	
	2.0i	06.02-04.10	99				1 987 482 533	← 1535	
							1 987 482 534	→ 1525	
<b>Lancer [CY/CZ]</b>									
	1.5	03.07-09.11	80				1 987 482 520	← 1596	
							1 987 482 521	→ 1620	
	1.6	07.10→	86				1 987 482 520	← 1596	
							1 987 482 521	→ 1620	
	1.8	02.08→	85/103-105/				1 987 482 520	← 1596	
	1.8 Di-D		110				1 987 482 521	→ 1620	
	2.0 Di-D	02.08-08.10	103				1 987 482 520	← 1596	
							1 987 482 521	→ 1620	
<b>Lancer [C1/C3]</b>									
	1.3i	01.89-12.94	55				0 986 475 914	↔ 17,46	
<b>Lancer [C6/C7]</b>									
	1.3	06.90-07.95	44			INB			F 026 A03 470 <sup>7</sup>
						INB			F 026 A08 184 <sup>7</sup>
	1.3	06.90-07.95	44				0 986 475 668	↔ 19	
	1.5 12V	06.92-07.95	67				0 986 475 668	↔ 19	
	1.3	04.88-07.95	44				1 987 477 674	← 1485	
							1 987 477 675	→ 1490	
	1.5 12V	06.92-07.95	67				1 987 477 674	← 1485	
							1 987 477 675	→ 1490	
<b>Lancer Evo4 [CK/CP/CN]</b>									
	2.0i Turbo	08.96-06.97	199			15Z			F 026 A03 467 <sup>7</sup>
						16Z			F 026 A03 467 <sup>7</sup>
	2.0i Turbo	08.96-06.97	199			LAB	F 01G 09F 0EN <sup>3</sup>		
							F 01G 09F 0ER <sup>4</sup>		



		S							
	◀ MITSUBISHI Lancer Evo4 [CK/CP/CN]								
	2.0 i Turbo	08.96-06.97	199			RAB	F 01G 09F 0EP <sup>3</sup>		F 01G 09F 0ES <sup>4</sup>
<b>Lancer Evo5/6 [CK/CP/CN]</b>									
	2.0 i Turbo	01.98-09.00	206			FSB			F 026 A03 467 <sup>7</sup>
	2.0 i Turbo	01.98-09.00	206			LAB	F 01G 09F 0EN <sup>3</sup>		F 01G 09F 0ER <sup>4</sup>
						RAB	F 01G 09F 0EP <sup>3</sup>		F 01G 09F 0ES <sup>4</sup>
<b>Lancer Evo7 [CS/CT]</b>									
	2.0 i Turbo 4x4	12.00-12.03	206			FSB			F 026 A03 467 <sup>7</sup>
<b>Lancer Evo8 [CS/CT]</b>									
	2.0 i Turbo 4x4	09.02-07.05	195			FSB			F 026 A03 467 <sup>7</sup>
<b>Lancer Hatchback [C6/C7]</b>									
	1.3 i	06.92-07.95	55						F 026 A03 470 <sup>7</sup>
	1.6 i 16V	ABO 06.92-07.95	83						F 026 A03 470 <sup>7</sup>
		ABS 06.92-07.95	83				0986 473 049	← 53,9	F 026 A03 486 <sup>7</sup>
							0986 474 049	→ 53,9	F 026 A03 486 <sup>7</sup>
	1.6 i 16V 4WD	06.92-07.95	83						F 026 A03 470 <sup>7</sup>
	1.8 i 16V	06.92-07.95	103				0986 473 049	← 53,9	F 026 A03 486 <sup>7</sup>
							0986 474 049	→ 53,9	F 026 A03 486 <sup>7</sup>
	2.0 D	06.92-07.95	50						F 026 A03 470 <sup>7</sup>
	1.3 i	06.92-07.95	55				0986 475 668	↔ 19	
	1.6 i 16V, i 16V 4WD	06.92-07.95	83				0986 475 668	↔ 19	
	2.0 D	06.92-07.95	50				0986 475 668	↔ 19	
	1.6 i 16V	06.92-07.95	83				0986 473 047	← 34,8	
							0986 474 047	→ 34,8	
	1.8 i 16V	ABO 06.92-07.95	103				0986 474 814	← 30,2	
							0986 474 815	→ 30,2	
		ABS 06.92-07.95	103				0986 473 047	← 34,8	
							0986 474 047	→ 34,8	
	1.3 i	06.92-07.95	55				1987 477 674	← 1485	
							1987 477 675	→ 1490	
	1.6 i 16V	06.92-07.95	83			TBR	1987 477 674	← 1485	
							1987 477 675	→ 1490	
	2.0 D	06.92-07.95	50				1987 477 674	← 1485	
							1987 477 675	→ 1490	

























		S							
	1.6i16V	06.92-07.95	83			LAB	F 01G 09F 00U <sup>4</sup>		
						RAB	F 01G 09F 00V <sup>4</sup>		
	1.8i16V	06.92-07.95	103			LAB	F 01G 09F 00U <sup>4</sup>		
						RAB	F 01G 09F 00V <sup>4</sup>		
<b>Lancer [MG21/41]</b>									
									
	1.5i	09.88-09.10	64				0 986 473 380	 53,95	F 026 A03 470 <sup>7</sup>
							0 986 474 380	 53,95	F 026 A03 470 <sup>7</sup>
	2.0D	09.98→	50				0 986 473 380	 53,95	F 026 A03 470 <sup>7</sup>
							0 986 474 380	 53,95	F 026 A03 470 <sup>7</sup>
									
	1.5i	09.88-09.10	64				0 986 475 668	↔ 19	
	2.0D	09.98→	50				0 986 475 668	↔ 19	
<b>Lancer Ralliart [CY/CZ]</b>									
									
	2.0 4x4	06.08-09.11	177						F 026 A03 467 <sup>7</sup>
									
	2.0 4x4	06.08-09.11	177						F 026 A06 143 <sup>7</sup>
									
	2.0 4x4	03.07-05.08	177				1 987 482 520	← 1596	
							1 987 482 521	→ 1620	
		10.11-06.12	177				1 987 482 520	← 1596	
							1 987 482 521	→ 1620	
<b>Lancer Sedan [CA/CB/CD]</b>									
									
	1.5i	07.93-12.97	68				0 986 473 380	 53,95	F 026 A03 470 <sup>7</sup>
							0 986 474 380	 53,95	F 026 A03 470 <sup>7</sup>
	1.6i16V	01.93-12.96	83				0 986 473 380	 53,95	F 026 A03 470 <sup>7</sup>
							0 986 474 380	 53,95	F 026 A03 470 <sup>7</sup>
									
	1.5i	07.93-12.97	68				0 986 475 914	↔ 17,46	
	1.6i16V	01.93-12.96	83				0 986 475 914	↔ 17,46	
									
	1.5i	07.93-12.97	68				1 987 482 163	→ 1510	
	1.6i16V	01.93-12.96	83			TBR	1 987 482 163	→ 1510	
<b>Lancer Sedan [CK/CP/CN]</b>									
									
	1.8i	05.96-05.01	85						F 026 A03 486 <sup>6</sup>



		S							
◀ MITSUBISHI Lancer Sedan [CK/CP/CN]									
	1.8 i	05.96-05.01	85				0986 475 914	↔ 17,46	
	1.8 i	05.96-05.01	85		RAB		F 01G 09F 0DZ <sup>3</sup>		
Lancer Sedan [C1/C3]									
	1.5	06.91-12.94	66				0986 475 914	↔ 17,46	
Lancer Sportback [CX]									
	1.5	07.08-06.10	80				1987 482 520	← 1596	
							1987 482 521	→ 1620	
	1.6	07.10→	86				1987 482 520	← 1596	
							1987 482 521	→ 1620	
	1.8	07.08→	85/103/				1987 482 520	← 1596	
	1.8 DI-D		110				1987 482 521	→ 1620	
	2.0 DI-D	08.08-08.10	103				1987 482 520	← 1596	
							1987 482 521	→ 1620	
Lancer Sportback Ralliart [CX]									
	2.0 4x4	07.08-09.11	177						F 026 A03 467 <sup>7</sup>
	2.0 4x4	07.08-09.11	177						F 026 A06 143 <sup>7</sup>
Lancer Station Wagon [CA/CB/CD]									
	1.6 i 16V	06.92-09.00	83				0986 473 380	← 53,95	F 026 A03 470 <sup>7</sup>
							0986 474 380	→ 53,95	F 026 A03 470 <sup>7</sup>
	1.6 i 16V 4WD	06.92-09.00	83						F 026 A03 486 <sup>6</sup>
	2.0 D	06.92-05.96	50/54				0986 473 380	← 53,95	F 026 A03 470 <sup>7</sup>
							0986 474 380	→ 53,95	F 026 A03 470 <sup>7</sup>
	1.6 i 16V	06.92-09.00	83				0986 475 668	↔ 19	
	1.6 i 16V 4WD	06.92-09.00	83				0986 475 663	↔ 19	
	2.0 D	06.92-05.96	50/54				0986 475 668	↔ 19	
Lancer Station Wagon [CS/CT]									
	1.6 i	06.03-06.08	72						F 026 A06 143 <sup>7</sup>
	2.0 i	06.03-06.08	99						F 026 A06 143 <sup>7</sup>



									
									
	1.6i	06.03-06.08	72				1 987 482 533	← 1535	
							1 987 482 534	→ 1525	
	2.0i	06.03-06.08	99				1 987 482 533	← 1535	
							1 987 482 534	→ 1525	
<b>Outlander</b>									
									
	2.4i 4WD	10.03-07.07	92-100				F 026 A09 606	↔	
<b>Outlander [CU]</b>									
									
	2.0i Turbo 4WD, i 2WD, i 4WD	02.03-09.07	100/148						F 026 A03 467 <sup>7</sup>
	2.4i 4x4	09.03-09.07	118						F 026 A03 467 <sup>7</sup>
									
	2.0i 2WD, i 4WD	02.03-09.07	100						F 026 A06 143 <sup>7</sup>
	2.4i 4x4	09.03-09.07	118						F 026 A06 143 <sup>7</sup>
<b>Outlander [CW]</b>									
									
	2.0, DI-D 4x4, 4x4	02.07-12.12	103/108-110						F 026 A03 467 <sup>7</sup>
	2.2 DI-D, DI-D 4x4	09.07-12.12	103/115/130						F 026 A03 467 <sup>7</sup>
	2.4, 4x4	09.07-12.12	125						F 026 A03 467 <sup>7</sup>
	3.0 4x4	09.07-12.12	162						F 026 A03 467 <sup>7</sup>
									
	2.0 DI-D 4x4	02.07-08.09	103						F 026 A06 143 <sup>7</sup>
	2.2 DI-D, DI-D 4x4	07.10-12.12	130		7SP				F 026 A06 143 <sup>7</sup>
	2.2 DI-D 4x4	09.07-12.12	115						F 026 A06 143 <sup>7</sup>
		07.10-12.12	103		7SP				F 026 A06 143 <sup>7</sup>
	2.4	09.07-12.12	125						F 026 A06 143 <sup>7</sup>
	2.4 4x4	09.07-08.09	125						F 026 A06 143 <sup>7</sup>
		07.11-12.12	125						F 026 A06 143 <sup>7</sup>
	3.0 4x4	09.07-12.12	162						F 026 A06 143 <sup>7</sup>
									
	2.0	09.07-12.12	108				1 987 482 517	← 1645	
							1 987 482 518	→ 1627	
	2.0 DI-D 4x4	02.07-08.09	103				1 987 482 274	→ 1627	
							1 987 482 275	← 1645	
		09.09-06.10	103				1 987 482 517	← 1645	
							1 987 482 519	→ 1632	
	2.0 4x4	06.09-12.12	108-110				1 987 482 517	← 1645	
							1 987 482 519	→ 1632	
	2.2 DI-D	07.10-12.12	130		5SP		1 987 482 518	→ 1627	
	2.2 DI-D	07.10-12.12	130		5SP		1 987 482 517	← 1645	
	2.2 DI-D 4x4				7SP		1 987 482 275	← 1645	
	2.2 DI-D 4x4	09.07-12.12	115				1 987 482 274	→ 1627	
							1 987 482 275	← 1645	
		07.10-12.12	103		5SP		1 987 482 517	← 1645	
							1 987 482 519	→ 1632	
					7SP		1 987 482 274	→ 1627	
							1 987 482 275	← 1645	



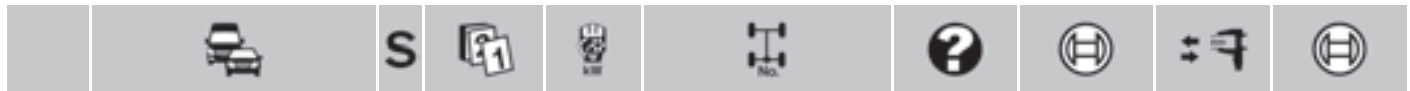

	<b>◀ MITSUBISHI Outlander [CW]</b>									
	2.2 DI-D 4x4	07.10-12.12	130		5SP	1987 482 519	→	1632		
					7SP	1987 482 274	→	1627		
	2.4	09.07-08.09	125			1987 482 275	←	1645		
		07.11-12.12	125			1987 482 274	→	1627		
						1987 482 275	←	1645		
	2.4 4x4	09.07-08.09	125			1987 482 274	→	1627		
						1987 482 275	←	1645		
		09.09-06.11	125			1987 482 517	←	1645		
						1987 482 519	→	1632		
		07.11-12.12	125			1987 482 274	→	1627		
						1987 482 275	←	1645		
	3.0 4x4	09.07-12.12	162			1987 482 274	→	1627		
						1987 482 275	←	1645		

**Outlander [GF]**

	PHEV 4WD	05.13→	87							F 026 A03 467 <sup>7</sup>
	2.0, 4WD	04.12→	110							F 026 A03 467 <sup>7</sup>
	2.2 DI-D, DI-D 4WD	04.12→	110							F 026 A03 467 <sup>7</sup>

**Pajero Cabrio [V]**

	2.5 D 4WD	04.91-05.95	62							F 026 A03 466 <sup>7</sup>
		06.95-05.99	62			0986 473 169	←	60,21	F 026 A03 473 <sup>7</sup>	
						0986 474 169	→	60,21	F 026 A03 473 <sup>7</sup>	
	2.5 TD Interc.	12.90-05.01	73-77			0986 473 153	←	42,73	F 026 A03 467 <sup>7</sup>	
						0986 474 153	→	42,73	F 026 A03 467 <sup>7</sup>	
	3000 V6	12.90-05.01	110/133			0986 473 153	←	42,73	F 026 A03 467 <sup>7</sup>	
	3000 V6 24V					0986 474 153	→	42,73	F 026 A03 467 <sup>7</sup>	

	2.5 D 4WD	04.91-05.99	62			0986 475 919	→	23,8		
						0986 475 920	←	23,8		
	2.5 TD Interc.	12.90-05.01	73-77			0986 473 140	←	42,72	F 026 A03 495 <sup>7</sup>	
						0986 474 140	→	42,72	F 026 A03 495 <sup>7</sup>	
	3000 V6	12.90-05.01	110/133			0986 473 140	←	42,72	F 026 A03 495 <sup>7</sup>	
	3000 V6 24V					0986 474 140	→	42,72	F 026 A03 495 <sup>7</sup>	

	3000 V6	12.90-05.94	110		LAB	F 01G 09F 01P <sup>3</sup>				
					RAB	F 01G 09F 01R <sup>3</sup>				
	3000 V6 24V	06.94-08.95	133		LAB	F 01G 09F 036 <sup>3</sup>				
					RAB	F 01G 09F 01R <sup>3</sup>				

**Pajero [NH/NJ/NK]**

	3.0 i 4WD	05.91-08.97	109			0986 AB8 190	←	22,23		
						0986 AB8 191	→	22,23		

**Pajero [NM]**

	3.5 i	05.00→	140			0986 134 024	←	45		
						0986 135 024	→	45		

		S				?			
	3.5i	05.00→	140				0 986 134 009	← 45	F 026 A06 148 <sup>7</sup>
							0 986 135 009	→ 45	F 026 A06 148 <sup>7</sup>
<b>Pajero Pinin [H]</b>									
	1.8	09.01-02.05	84				F 026 A09 606	↔	
<b>Pajero Sport [K]</b>									
	2.5 TD	08.98-02.09	73-85/98		15Z		0 986 473 153	← 42,73	F 026 A03 467 <sup>7</sup>
	2.5 TD+						0 986 474 153	→ 42,73	F 026 A03 467 <sup>7</sup>
					16Z				F 026 A03 467 <sup>7</sup>
	3.0i V6	07.96-02.09	130						F 026 A03 467 <sup>7</sup>
	2.5 TD, TD+	08.98-02.09	73-85/98						F 026 A06 092 <sup>7</sup>
	3.0i V6	07.96-02.09	130						F 026 A06 092 <sup>7</sup>
<b>Pajero Sport [KH]</b>									
	2.5 DI-D	10.09→	131						F 026 A06 622 <sup>7</sup>
	3.0	07.08→	162-163						F 026 A06 622 <sup>7</sup>
	3.2 DI-D	07.08-09.09	120						F 026 A06 622 <sup>7</sup>
	3.5	12.08-09.09	149						F 026 A06 622 <sup>7</sup>
	3.2 DI-D	07.08-09.09	120				F 026 A06 945	↔	
	3.5	12.08-09.09	149				F 026 A06 945	↔	
	2.5 DI-D	10.09→	131						F 026 A06 092 <sup>7</sup>
	3.0	07.08→	162-163						F 026 A06 092 <sup>7</sup>
	2.5 DI-D	10.09→	131				1 987 482 514	244	
	3.0	07.08→	162-163				1 987 482 514	244	
	3.2 DI-D	07.08-09.09	120				1 987 482 514	244	
	3.5	12.08-09.09	149				1 987 482 514	244	
<b>Pajero [V]</b>									
	2.4i	12.90-05.94	82-100				0 986 473 153	← 42,73	F 026 A03 467 <sup>7</sup>
							0 986 474 153	→ 42,73	F 026 A03 467 <sup>7</sup>
	2.5 TD	04.91-05.95	62						F 026 A03 466 <sup>7</sup>
		06.95-05.99	62				0 986 473 169	← 60,21	F 026 A03 473 <sup>7</sup>
							0 986 474 169	→ 60,21	F 026 A03 473 <sup>7</sup>
	2.5 TD Interc.	12.90-06.00	73-77				0 986 473 153	← 42,73	F 026 A03 467 <sup>7</sup>
							0 986 474 153	→ 42,73	F 026 A03 467 <sup>7</sup>
	2.6 4WD	04.91-05.95	88						F 026 A03 466 <sup>7</sup>
	2.8 D	06.94-05.99	92				0 986 473 153	← 42,73	F 026 A03 467 <sup>7</sup>
							0 986 474 153	→ 42,73	F 026 A03 467 <sup>7</sup>
	2.8 TD	07.95-12.98	92			Fg.-Nr. *NUFL6*→, *NUFR6*→	0 986 473 153	← 42,73	F 026 A03 467 <sup>7</sup>
							0 986 474 153	→ 42,73	F 026 A03 467 <sup>7</sup>





		S									
	<b>◀ MITSUBISHI Pajero [V]</b>										
	2.8 TD Interc.	11.93-04.00	103				0986 473 153		← 42,73 F 026 A03 467 <sup>7</sup>		
							0986 474 153		→ 42,73 F 026 A03 467 <sup>7</sup>		
	3.0 i	06.92-05.97	110				0986 473 153		← 42,73 F 026 A03 467 <sup>7</sup>		
							0986 474 153		→ 42,73 F 026 A03 467 <sup>7</sup>		
							04.99→	109	0986 473 153		← 42,73 F 026 A03 467 <sup>7</sup>
									0986 474 153		→ 42,73 F 026 A03 467 <sup>7</sup>
	3.2 DI-D	01.00→	121				0986 134 024		← 45		
							0986 135 024		→ 45		
	3.5 V6-24	11.93-02.00	143-154						F 026 A03 467 <sup>7</sup>		
	3000 V6	12.90-02.00	110/130				0986 473 153		← 42,73 F 026 A03 467 <sup>7</sup>		
	3000 V6 24V						0986 474 153		→ 42,73 F 026 A03 467 <sup>7</sup>		
	2.5 TD	04.91-05.99	62				0986 475 919		→ 23,8		
							0986 475 920		← 23,8		
	2.6 4WD	04.91-05.95	88				0986 475 919		→ 23,8		
							0986 475 920		← 23,8		
	2.8 D	06.94-05.99	92				0986 475 919		→ 23,8		
							0986 475 920		← 23,8		
	2.4 i	12.90-05.94	82-100				0986 473 140		← 42,72 F 026 A03 495 <sup>7</sup>		
							0986 474 140		→ 42,72 F 026 A03 495 <sup>7</sup>		
	2.5 TD Interc.	12.90-06.00	73-77					0986 473 140		← 42,72 F 026 A03 495 <sup>7</sup>	
								0986 474 140		→ 42,72 F 026 A03 495 <sup>7</sup>	
	2.8 TD	11.93-04.00	92/103					0986 473 140		← 42,72 F 026 A03 495 <sup>7</sup>	
								0986 474 140		→ 42,72 F 026 A03 495 <sup>7</sup>	
	2.8 TD Interc.							0986 473 140		← 42,72 F 026 A03 495 <sup>7</sup>	
								0986 474 140		→ 42,72 F 026 A03 495 <sup>7</sup>	
	3.0 i	06.92→	109/110					0986 473 140		← 42,72 F 026 A03 495 <sup>7</sup>	
								0986 474 140		→ 42,72 F 026 A03 495 <sup>7</sup>	
	3.2 DI-D	01.00→	121					0986 134 009		← 45 F 026 A06 148 <sup>7</sup>	
								0986 135 009		→ 45 F 026 A06 148 <sup>7</sup>	
	3.5 V6-24	11.93-02.00	143-154					0986 473 140		← 42,72 F 026 A03 495 <sup>7</sup>	
								0986 474 140		→ 42,72 F 026 A03 495 <sup>7</sup>	
	3000 V6	12.90-02.00	110/130					0986 473 140		← 42,72 F 026 A03 495 <sup>7</sup>	
								0986 474 140		→ 42,72 F 026 A03 495 <sup>7</sup>	
3000 V6 24V							0986 473 140		← 42,72 F 026 A03 495 <sup>7</sup>		
							0986 474 140		→ 42,72 F 026 A03 495 <sup>7</sup>		
	2.5 TD Interc.	12.90-08.95	73-77				LAB		F 01G 09F 01P <sup>3</sup>		
							RAB		F 01G 09F 01R <sup>3</sup>		
		09.95-05.96	73-77					LAB		F 01G 09F 09P <sup>3</sup>	
								RAB		F 01G 09F 09R <sup>3</sup>	
	2.8 TD Interc.	11.93-08.95	103					LAB		F 01G 09F 036 <sup>3</sup>	
								RAB		F 01G 09F 01R <sup>3</sup>	
		09.95-05.96	103					LAB		F 01G 09F 09S <sup>3</sup>	
								RAB		F 01G 09F 09R <sup>3</sup>	
	3.5 V6-24	11.93-08.95	143-154					RAB		F 01G 09F 01R <sup>3</sup>	
								LAB		F 01G 09F 036 <sup>3</sup>	
								RAB		F 01G 09F 09R <sup>3</sup>	
	3000 V6	12.90-05.94	110					LAB		F 01G 09F 01P <sup>3</sup>	
RAB									F 01G 09F 01R <sup>3</sup>		
3000 V6 24V	06.94-08.95	130					RAB		F 01G 09F 01R <sup>3</sup>		
							LAB		F 01G 09F 036 <sup>3</sup>		
							RAB		F 01G 09F 09R <sup>3</sup>		
<b>Pajero [V60; V70]</b>											
	2.5 TD Interc.	02.00-08.06	73-85				0986 134 024		← 45		
							0986 135 024		→ 45		
	3.2 DI-D 4WD	02.00-08.06	118-121				0986 134 024		← 45		
							0986 135 024		→ 45		



		S							
	3.5 GDI	02.00-08.06	149				0 986 134 024		← 45
							0 986 135 024		→ 45
	2.5 TD Interc.	02.00-08.06	73-85				0 986 134 009		← 45 F 026 A06 148 <sup>7</sup>
							0 986 135 009		→ 45 F 026 A06 148 <sup>7</sup>
	3.2 DI-D 4WD	02.00-08.06	118-121				0 986 134 009		← 45 F 026 A06 148 <sup>7</sup>
							0 986 135 009		→ 45 F 026 A06 148 <sup>7</sup>
	3.5 GDI	02.00-08.06	149				0 986 134 009		← 45 F 026 A06 148 <sup>7</sup>
							0 986 135 009		→ 45 F 026 A06 148 <sup>7</sup>
<b>Pajero [V80; V90]</b>									
	3.0	09.08→	131				0 986 134 024		← 45
							0 986 135 024		→ 45
	3.2 DI-D	09.06-05.10	118-125/ 140/147				0 986 134 024		← 45
		06.10→	118-125/140/147				0 986 135 024		→ 45
	3.8	09.06-05.10	184				0 986 134 024		← 45 F 026 A06 147 <sup>7</sup>
		06.10→	184				0 986 135 024		→ 45
	3.0	09.08→	131				0 986 134 009		← 45 F 026 A06 148 <sup>7</sup>
							0 986 135 009		→ 45 F 026 A06 148 <sup>7</sup>
	3.2 DI-D	09.06→	118-125/ 140/147				0 986 134 009		← 45 F 026 A06 148 <sup>7</sup>
							0 986 135 009		→ 45 F 026 A06 148 <sup>7</sup>
	3.8	09.06→	184				0 986 134 009		← 45 F 026 A06 148 <sup>7</sup>
							0 986 135 009		→ 45 F 026 A06 148 <sup>7</sup>
<b>Space Gear</b>									
	2.0 i	ABO 12.94-03.01	83-85				0 986 473 169		← 60,21
		ABS 12.94-03.01	83-85				0 986 474 169		→ 60,21
							0 986 473 507		← 43
							0 986 474 507		→ 43
	2.4 i 2WD	12.94-03.01	94-97				0 986 473 507		← 43
							0 986 474 507		→ 43
	2.4 i 4WD	12.94-03.01	94-97				0 986 473 153		← 42,73 F 026 A03 467 <sup>7</sup>
							0 986 474 153		→ 42,73 F 026 A03 467 <sup>7</sup>
	2.5 D Turbo Interc. 2WD	12.94-03.01	73				0 986 473 507		← 43
							0 986 474 507		→ 43
	2.5 D Turbo Interc. 4WD	12.94-03.01	73				0 986 473 153		← 42,73 F 026 A03 467 <sup>7</sup>
							0 986 474 153		→ 42,73 F 026 A03 467 <sup>7</sup>
	2.5 D Turbo 2WD long	06.94-03.01	64				0 986 473 507		← 43
	2.5 D Turbo 2WD short						0 986 474 507		→ 43
	2.0 i	12.94-03.01	83-85				0 986 475 921		↔ 22,2
	2.4 i 2WD	12.94-03.01	94-97				0 986 475 921		↔ 22,2
	2.5 D Turbo Interc. 2WD, D Turbo 2WD long, D Turbo 2WD short	06.94-03.01	64/73				0 986 475 921		↔ 22,2
	2.4 i 4WD	12.94-03.01	94-97						F 026 A06 616 <sup>7</sup>
	2.5 D Turbo Interc. 4WD	12.94-03.01	73						F 026 A06 616 <sup>7</sup>



		S				?			
◀ MITSUBISHI									
<b>Space Runner</b>									
	<b>1.8 i</b>	06.91-05.99	85-90				0986 473 049	← 53,9	F 026 A03 486 <sup>7</sup>
	<b>1.8 i 16V 4WD</b>						0986 474 049	→ 53,9	F 026 A03 486 <sup>7</sup>
	<b>2.0 D Turbo</b>	06.92-05.99	60				0986 473 049	← 53,9	F 026 A03 486 <sup>7</sup>
							0986 474 049	→ 53,9	F 026 A03 486 <sup>7</sup>
	<b>2.0 i 16V</b>	05.99-04.00	98						F 026 A03 467 <sup>7</sup>
	<b>2.4 GDI</b>	05.99-04.00	110						F 026 A03 467 <sup>7</sup>
	<b>1.8 i</b>	06.91-05.99	85-90				0986 475 668	↔ 19	
	<b>1.8 i 16V 4WD</b>	06.91-05.99	85-90				0986 475 663	↔ 19	
	<b>2.0 D Turbo</b>	06.92-05.99	60				0986 475 668	↔ 19	
	<b>1.8 i</b>	06.91-05.99	85-90		LAB		F 01G 09F 095 <sup>4</sup>		
					RAB		F 01G 09F 01N <sup>3</sup>		
							F 01G 09F 096 <sup>4</sup>		
	<b>1.8 i, i 16V 4WD</b>	06.91-05.99	85-90		LAB		F 01G 09F 01M <sup>3</sup>		
	<b>1.8 i 16V 4WD</b>	06.91-05.99	85-90		LAB		F 01G 09F 05T <sup>4</sup>		
					RAB		F 01G 09F 01N <sup>3</sup>		
							F 01G 09F 05U <sup>4</sup>		
	<b>2.0 D Turbo</b>	09.94-05.99	60		LAB		F 01G 09F 01M <sup>3</sup>		
							F 01G 09F 095 <sup>4</sup>		
					RAB		F 01G 09F 01N <sup>3</sup>		
							F 01G 09F 096 <sup>4</sup>		
<b>Space Star [A0]</b>									
	<b>1.0</b>	11.12→	52				0986 475 948	↔ 19	
	<b>1.2</b>	11.12→	57-59				0986 475 948	↔ 19	
<b>Space Wagon [N]</b>									
	<b>2.0 D Turbo</b>	06.92-11.00	60				0986 473 049	← 53,9	F 026 A03 486 <sup>7</sup>
							0986 473 396	← 60,21	F 026 A03 473 <sup>7</sup>
							0986 474 049	→ 53,9	F 026 A03 486 <sup>7</sup>
							0986 474 396	→ 60,21	F 026 A03 473 <sup>7</sup>
	<b>2.0 i 16V</b>	06.92-11.00	98-101				0986 473 049	← 53,9	F 026 A03 486 <sup>7</sup>
							0986 474 049	→ 53,9	F 026 A03 486 <sup>7</sup>
		06.00-01.04	98						F 026 A03 467 <sup>7</sup>
	<b>2.0 i 16V 4WD</b>	06.92-11.00	98				0986 473 049	← 53,9	F 026 A03 486 <sup>7</sup>
							0986 474 049	→ 53,9	F 026 A03 486 <sup>7</sup>
	<b>2.4 GDI</b>	07.98-01.04	96-121						F 026 A03 467 <sup>7</sup>
	<b>2.4 GDI 4WD</b>	07.98-01.04	110						F 026 A03 467 <sup>7</sup>
	<b>2.4 i 16V</b>	05.91-05.96	97				0986 473 049	← 53,9	F 026 A03 486 <sup>7</sup>
							0986 474 049	→ 53,9	F 026 A03 486 <sup>7</sup>
	<b>2.0 D Turbo, i 16V, i 16V 4WD</b>	06.92-11.00	60/98-101				0986 475 663	↔ 19	
	<b>2.4 GDI</b>	07.98-01.04	96-121				F 026 A09 606	↔	
	<b>2.4 i 16V</b>	05.91-05.96	97				0986 475 663	↔ 19	
	<b>2.0 i 16V</b>	06.00-01.04	98						F 026 A06 616 <sup>7</sup>
	<b>2.4 GDI, GDI 4WD</b>	07.98-01.04	96-121						F 026 A06 616 <sup>7</sup>



		S								
	2.0i 16V	06.00-01.04	98				1 987 477 864	↔	1917	
	2.4 GDI	09.99-01.04	96-121				1 987 477 864	↔	1917	
	2.4 GDI 4WD	09.99-01.04	96-121				1 987 477 864	↔	1917	
	2.0 D Turbo	06.92-11.00	60				LAB	F 01G 09F 01M <sup>3</sup>		
							RAB	F 01G 09F 01N <sup>3</sup>		
	2.0i 16V	06.92-11.00	98-101					LAB	F 01G 09F 01M <sup>3</sup>	
								RAB	F 01G 09F 01N <sup>3</sup>	
	2.0i 16V 4WD	06.92-11.00	98					LAB	F 01G 09F 01M <sup>3</sup>	
								RAB	F 01G 09F 01N <sup>3</sup>	
	2.4i 16V	05.91-05.96	97					LAB	F 01G 09F 01M <sup>3</sup>	
								RAB	F 01G 09F 01N <sup>3</sup>	
	<b>Spacestar [DG]</b>									
		1.3i	06.98-12.04	60				0 986 473 274		← 54
								0 986 474 274		→ 54
1.6i		04.01-12.04	72					0 986 473 274		← 54
								0 986 474 274		→ 54
1.8 GDI		08.98-12.04	82/87-90					0 986 473 274		← 54
1.8i								0 986 474 274		→ 54
1.9 Di-D	06.00-12.04	75/85					0 986 473 274		← 54	
							0 986 474 274		→ 54	
	1.3i	06.98-09.98	60				0 986 475 948	↔	19	
		10.98-12.04	60				F 026 002 566	↔	19,05	
	1.8 GDI	10.98-08.02	87-90				F 026 002 566	↔	19,05	
	1.3i	06.98-12.04	60				0 986 473 354		← 38,1	
							0 986 474 354		→ 38,1	
	1.6i	04.01-12.04	72					0 986 473 354		← 38,1
								0 986 474 354		→ 38,1
	1.8 GDI	08.98-12.04	82/87-90					0 986 473 354		← 38,1
	1.8i							0 986 474 354		→ 38,1
1.9 Di-D	06.00-12.04	75/85					0 986 473 354		← 38,1	
							0 986 474 354		→ 38,1	
	1.3i	06.00-04.02	60				1 987 482 399	←	1573	
								1 987 482 400	→	1551
		05.02-12.04	60					1 987 482 064	←	1563
	1.6i	04.01-04.02	72					1 987 482 065	→	1540
								1 987 482 399	←	1573
								1 987 482 400	→	1551
	1.8 GDI	06.00-08.02	87-90					1 987 482 064	←	1563
								1 987 482 065	→	1540
								1 987 482 399	←	1573
							1 987 482 400	→	1551	





	◀ MITSUBISHI Spacestar [DG]							
	1.8 i	09.02-12.04	82			1987 482 064	← 1563	
						1987 482 065	→ 1540	
	1.9 DI-D	06.00-04.02	75			1987 482 399	← 1573	
						1987 482 400	→ 1551	
		05.02-12.04	75			1987 482 064	← 1563	
						1987 482 065	→ 1540	
		09.02-12.04	85			1987 482 064	← 1563	
						1987 482 065	→ 1540	

	1.3 i	06.98-04.02	60	HTB,LAB	0 265 006 327 <sup>4</sup>			
				HTB,RAB	0 265 006 294 <sup>4</sup>			
		06.98-12.04	60	LAB	0 265 006 224 <sup>3</sup>			
				RAB	0 265 006 223 <sup>3</sup>			
	1.6 i	04.01-12.04	72	LAB	0 265 006 224 <sup>3</sup>			
				RAB	0 265 006 223 <sup>3</sup>			
	1.8 GDI	08.98-08.02	87-90	HTB,LAB	0 265 006 327 <sup>4</sup>			
				HTB,RAB	0 265 006 294 <sup>4</sup>			
				LAB	0 265 006 224 <sup>3</sup>			
				RAB	0 265 006 223 <sup>3</sup>			
	1.8 i	09.02-12.04	82	LAB	0 265 006 224 <sup>3</sup>			
				RAB	0 265 006 223 <sup>3</sup>			
	1.9 DI-D	06.00-12.04	75/85	LAB	0 265 006 224 <sup>3</sup>			
				RAB	0 265 006 223 <sup>3</sup>			

**Triton**

	2.5 D	08.05→	85-131		0 986 AB8 135	→ 22,23		
	2.5 D 4WD				0 986 AB8 136	← 22,23		

**Triton [MJ]**

	2.5 DT 4x4	08.91-10.96	62		0 986 AB8 135	→ 22,23		
					0 986 AB8 136	← 22,23		

**Triton [MK]**

	2.4	10.96-12.03	97		0 986 AB8 135	→ 22,23		
					0 986 AB8 136	← 22,23		
	2.8 DT 4x4	01.03→	92		0 986 AB8 135	→ 22,23		
					0 986 AB8 136	← 22,23		

**3000 GT**

	3.0 i 24V Bi-Turbo 4WD 4WS	06.92-12.00	206-210	LAB	F 01G 09F 05J <sup>3</sup>			
					F 01G 09F 05L <sup>4</sup>			
				RAB	F 01G 09F 05K <sup>3</sup>			
					F 01G 09F 05M <sup>4</sup>			

**NISSAN**

















**AD Van**

	1.5 i	06.99-12.06	74-78					F 026 A03 540 <sup>7</sup>
--	-------	-------------	-------	--	--	--	--	----------------------------

		S									
	1.5i	06.99-09.00	74-78		LAB		F 01G 09F 0GA <sup>3</sup>				
					RAB		F 01G 09F 0GB <sup>3</sup>				
		10.00-09.02	74-78		RAB		F 01G 09F 0P4 <sup>3</sup>				
		10.00-10.02	74-78		LAB		F 01G 09F 0H6 <sup>3</sup>				
<b>Almera Hatchback [N15]</b>											
	1.4i	07.95-01.98	55-64				0 986 473 051		← 54		
							0 986 474 051		→ 54		
		ABO	01.98-04.00	55-64				0 986 473 051		← 54	
								0 986 474 051		→ 54	
		ABS	07.97-04.00	55-64				0 986 473 264		← 54	
									0 986 474 264		→ 54
		1.6i	07.95-01.98	66-73				0 986 473 051		← 54	
									0 986 474 051		→ 54
				01.98-01.99	66-73				0 986 473 264		← 54
									0 986 474 264		→ 54
				ABO	01.99-04.00	66-73			0 986 473 264		← 54
									0 986 474 264		→ 54
			ABS	08.97-01.98	66-73			0 986 473 264		← 54	
								0 986 474 264		→ 54	
		01.99-04.00	66-73				0 986 473 264		← 54		
							0 986 474 264		→ 54		
	2.0D	07.95-07.97	55				0 986 473 051		← 54		
								0 986 474 051		→ 54	
			ABO	08.97-10.99	55			0 986 473 051		← 54	
								0 986 474 051		→ 54	
			ABS	08.97-10.99	55			0 986 473 264		← 54	
								0 986 474 264		→ 54	
			ABS, ASR	11.99-04.00	55			0 986 473 051		← 54	
			ABS, OAS	11.99-04.00	55			0 986 473 264		← 54	
							0 986 474 264		→ 54		
	2.0i	04.96-06.97	105						F 026 A03 504 <sup>7</sup>		
	1.4i	07.95-04.00	55-64				0 986 475 670		↔ 15,8		
	1.6i	07.95-04.00	66-73				0 986 475 670		↔ 15,8		
	2.0D	07.95-04.00	55				0 986 475 670		↔ 15,8		
	1.4i	ABS	07.95-01.98	55-64	TW		0 986 473 092		← 30,15		
							0 986 474 092		→ 30,15		
			07.97-01.98	55-64	TW		0 986 473 093		← 33,9		
						0 986 474 093		→ 33,9			
			01.98-10.99	55-64			0 986 473 093		← 33,9		
					0 986 474 093		→ 33,9				
				ABS, ASR	10.99-04.00	55-64			0 986 473 092		← 30,15
									0 986 474 092		→ 30,15
				ABS, OAS	10.99-04.00	55-64			0 986 473 093		← 33,9
									0 986 474 093		→ 33,9
			1.6i	ABS	07.95-01.98	66-73			0 986 473 092		← 30,15
								0 986 474 092		→ 30,15	
		01.98-04.00		66-73				0 986 473 093		← 33,9	
							0 986 474 093		→ 33,9		
	2.0D	ABS	07.95-01.98	55			0 986 473 092		← 30,15		
						0 986 474 092		→ 30,15			
			02.98-10.99	55				0 986 473 093		← 33,9	
							0 986 474 093		→ 33,9		



		S								
<b>NISSAN Almera Hatchback [N15]</b>										
	2.0D	ABS, 11.99-04.00	55				0986 473 092		← 30,15	
		ASR					0986 474 092		→ 30,15	
		ABS, 11.99-04.00	55				0986 473 093		← 33,9	
		OAS					0986 474 093		→ 33,9	
	2.0i	04.96-04.00	105				0986 473 093		← 33,9	
							0986 474 093		→ 33,9	
<hr/>										
	1.4i	07.95-04.00	55-64				1987 477 534		250	
		ABO 07.95-04.00	55-64				1987 477 535		→ 1662	
							1987 477 537		← 1660	
		ABS 07.95-04.00	55-64				1987 477 536		→ 1677	
	1.6i	07.95-04.00	66-73				1987 477 534		250	
		ABO 07.95-04.00	66-73				1987 477 535		→ 1662	
							1987 477 537		← 1660	
		ABS 07.95-04.00	66-73				1987 477 536		→ 1677	
	2.0D	07.95-04.00	55				1987 477 534		250	
		ABO 07.95-04.00	55				1987 477 535		→ 1662	
							1987 477 537		← 1660	
		ABS 07.95-04.00	55				1987 477 536		→ 1677	
	2.0i	04.96-04.00	105				1987 477 534		250	
							1987 477 536		→ 1677	
							1987 477 538		← 1676	
							1987 477 538		← 1676	
	<hr/>									
	<b>Almera Hatchback [N16E]</b>									
<hr/>										
	1.5 D Turbo	ABS 01.00-11.06	60/66/72				0986 473 054		← 57,2 F 026 A03 543 <sup>7</sup>	
							0986 474 054		→ 57,2 F 026 A03 543 <sup>7</sup>	
	1.8i	01.00-11.06	84/85				0986 473 054		← 57,2 F 026 A03 543 <sup>7</sup>	
							0986 474 054		→ 57,2 F 026 A03 543 <sup>7</sup>	
	2.2 D Turbo	01.00-11.06	81/82/100				0986 473 054		← 57,2 F 026 A03 543 <sup>7</sup>	
							0986 474 054		→ 57,2 F 026 A03 543 <sup>7</sup>	
<hr/>										
	1.5 D Turbo	03.03-11.06	60				0986 475 938		↔ 17,46	
	1.5i	01.01-11.06	66/72				0986 475 938		↔ 17,46	
<hr/>										
	1.5 D Turbo	04.03-11.06	60				0986 473 346		← 38	
							0986 473 055		← 34	
	1.5i	01.00-01.01	66				0986 474 055		→ 34	
							0986 473 055		← 34	
	2.2 D Turbo	01.00-02.01	81				0986 474 055		→ 34	
							0986 473 055		← 34	
<hr/>										
	1.5 D Turbo	10.02-11.06	60				1987 477 913		221	
		ABS 10.02-11.06	60				1987 477 914		→ 1661	
							1987 477 915		← 1650	
							1987 477 914		→ 1661	
	1.5i	01.00-01.01	66				1987 477 915		← 1650	
		01.00-07.02	66				1987 477 913		221	
		08.02-11.06	72				1987 477 913		221	
		ABS 03.01-07.02	66				1987 477 914		→ 1661	
							1987 477 915		← 1650	
		08.02-11.06	72				1987 477 914		→ 1661	
						1987 477 915		← 1650		

		S							
1.8 i		01.00-11.06	84/85				1 987 477 913	221	
							1 987 477 914	→ 1661	
							1 987 477 915	← 1650	
2.2 D Turbo		01.00-11.06	81/82/100				1 987 477 913	221	
							1 987 477 914	→ 1661	
							1 987 477 915	← 1650	
 1.5 D Turbo		10.02-11.06	60			LAB	0 265 006 702 <sup>3</sup>		
						RAB	0 265 006 703 <sup>3</sup>		
1.5 i		01.00-08.00	66			LAB	0 265 006 605 <sup>3</sup>		
						RAB	0 265 006 606 <sup>3</sup>		
		09.00-07.02	66			LAB	0 265 006 702 <sup>3</sup>		
						RAB	0 265 006 703 <sup>3</sup>		
		08.02-11.06	72			LAB	0 265 007 553 <sup>3</sup>		
						RAB	0 265 007 552 <sup>3</sup>		
1.8 i		01.00-08.00	84			LAB	0 265 006 605 <sup>3</sup>		
						RAB	0 265 006 606 <sup>3</sup>		
		09.00-07.02	84			LAB	0 265 006 702 <sup>3</sup>		
						RAB	0 265 006 703 <sup>3</sup>		
		08.02-11.06	85			LAB	0 265 007 553 <sup>3</sup>		
						RAB	0 265 007 552 <sup>3</sup>		
		MFD 02.03-11.06	85			LAB	0 265 007 555 <sup>4</sup>		
						RAB	0 265 007 554 <sup>4</sup>		
2.2 D Turbo		01.00-08.00	81			LAB	0 265 006 605 <sup>3</sup>		
						RAB	0 265 006 606 <sup>3</sup>		
		09.00-02.03	81			LAB	0 265 006 702 <sup>3</sup>		
						RAB	0 265 006 703 <sup>3</sup>		
		02.03-11.06	82/100			LAB	0 265 007 553 <sup>3</sup>		
							0 265 007 555 <sup>4</sup>		
						RAB	0 265 007 552 <sup>3</sup>		
							0 265 007 554 <sup>4</sup>		
<b>Almera [H14/15/17]</b>									
									
 1.8 i		ABS 12.00→	88				0 986 473 054	↻ ← 57,2	
							0 986 474 054	↻ → 57,2	
									
 1.6 i		ABO 01.00→	81				F 026 A02 404	↔	
1.8 i		ABO 12.00→	88				F 026 A02 404	↔	
	 1.8 i	ABS 12.00→	88				0 986 473 093	↻ ← 33,9	
							0 986 474 093	↻ → 33,9	
<b>Almera Sedan [N15]</b>									
									
 1.4 i		07.95-01.98	55-64				0 986 473 051	↻ ← 54	
							0 986 474 051	↻ → 54	
		ABO 01.98-04.00	55-64				0 986 473 051	↻ ← 54	
							0 986 474 051	↻ → 54	
		ABS 07.97-04.00	55-64				0 986 473 264	↻ ← 54	
							0 986 474 264	↻ → 54	
1.6 i		07.95-01.98	66-73				0 986 473 051	↻ ← 54	
							0 986 474 051	↻ → 54	
		01.98-01.99	66-73				0 986 473 264	↻ ← 54	
							0 986 474 264	↻ → 54	
		ABO 01.99-04.00	66-73				0 986 473 264	↻ ← 54	
							0 986 474 264	↻ → 54	
		ABS 08.97-01.98	66-73				0 986 473 264	↻ ← 54	
							0 986 474 264	↻ → 54	

























		S											
◀ NISSAN Almera Sedan [N15]													
1.6 i	ABS	01.99-04.00	66-73				0986 473 264		← 54				
							0986 474 264		→ 54				
2.0 D		07.95-07.97	55				0986 473 051		← 54				
							0986 474 051		→ 54				
							ABO	08.97-10.99	55	0986 473 051		← 54	
							0986 474 051		→ 54				
							ABS	08.97-10.99	55	0986 473 264		← 54	
							0986 474 264		→ 54				
							ABS, ASR	11.99-04.00	55	0986 473 051		← 54	
							0986 474 051		→ 54				
							ABS, OAS	11.99-04.00	55	0986 473 264		← 54	
							0986 474 264		→ 54				
1.4 i		07.95-04.00	55-64				0986 475 670		↔ 15,8				
							1.6 i	07.95-04.00	66-73	0986 475 670		↔ 15,8	
							2.0 D	07.95-04.00	55	0986 475 670		↔ 15,8	
1.4 i	ABS	07.95-01.98	55-64			TW	0986 473 092		← 30,15				
							0986 474 092		→ 30,15				
		07.97-01.98	55-64			TW	0986 473 093		← 33,9				
							0986 474 093		→ 33,9				
		01.98-10.99	55-64				0986 473 093		← 33,9				
							0986 474 093		→ 33,9				
		ABS,ASR10.99-04.0055-64							0986 473 092		← 30,15		
									0986 474 092		→ 30,15		
		ABS,OAS10.99-04.0055-64							0986 473 093		← 33,9		
									0986 474 093		→ 33,9		
1.6 i	ABS	07.95-01.98	66-73				0986 473 092		← 30,15				
							0986 474 092		→ 30,15				
		01.98-04.00	66-73				0986 473 093		← 33,9				
							0986 474 093		→ 33,9				
2.0 D	ABS	07.95-01.98	55				0986 473 092		← 30,15				
							0986 474 092		→ 30,15				
		02.98-10.99	55				0986 473 093		← 33,9				
							0986 474 093		→ 33,9				
		ABS,ASR11.99-04.0055							0986 473 092		← 30,15		
									0986 474 092		→ 30,15		
		ABS,OAS11.99-04.0055							0986 473 093		← 33,9		
									0986 474 093		→ 33,9		
1.4 i		07.95-04.00	55-64				1987 477 534		250				
							ABO	07.95-04.00	55-64	1987 477 535		→ 1662	
				07.95-04.00	55-64				1987 477 537		← 1660		
									1987 477 536		→ 1677		
				07.95-04.00	55-64				1987 477 538		← 1676		
									1987 477 538		← 1676		
		1.6 i		07.95-04.00	66-73				1987 477 534		250		
									ABO	07.95-04.00	66-73	1987 477 535	
						07.95-04.00	66-73				1987 477 537		← 1660
											1987 477 536		→ 1677
				07.95-04.00	66-73				1987 477 538		← 1676		
									1987 477 538		← 1676		
2.0 D		07.95-04.00	55				1987 477 534		250				
							ABO	07.95-04.00	55	1987 477 535		→ 1662	
				07.95-04.00	55				1987 477 537		← 1660		
									1987 477 536		→ 1677		
		07.95-04.00	55				1987 477 538		← 1676				
							1987 477 538		← 1676				

		S							
<b>Almera Sedan [N16]</b>									
	1.5 i	ABS	04.00-03.01	66			0 986 473 054		← 57,2
							0 986 474 054		→ 57,2
	1.8 i		04.00-03.01	84			0 986 473 054		← 57,2
							0 986 474 054		→ 57,2
	2.2 D Turbo		04.00-03.01	81			0 986 473 054		← 57,2
							0 986 474 054		→ 57,2
	1.5 i		04.00-03.01	66			0 986 475 938		↔ 17,46
	1.5 i		04.00-03.01	66			0 986 473 093		← 33,9
							0 986 474 093		→ 33,9
	1.8 i		04.00-03.01	84			0 986 473 093		← 33,9
							0 986 474 093		→ 33,9
	2.2 D Turbo		04.00-03.01	81			0 986 473 093		← 33,9
							0 986 474 093		→ 33,9
	1.5 i		04.00-03.01	66			1 987 477 226		236
	1.8 i		04.00-03.01	84			1 987 477 226		236
	2.2 D Turbo		04.00-03.01	81			1 987 477 226		236
	1.5 i		04.00-07.00	66	LAB	F 01G 09F OGA <sup>3</sup>			
					RAB	F 01G 09F OGB <sup>3</sup>			
			08.00-03.01	66	LAB	F 01G 09F OH6 <sup>3</sup>			
					RAB	F 01G 09F OP4 <sup>3</sup>			
	1.8 i		04.00-07.00	84	LAB	F 01G 09F OGA <sup>3</sup>			
					RAB	F 01G 09F OGB <sup>3</sup>			
			08.00-03.01	84	LAB	F 01G 09F OH6 <sup>3</sup>			
					RAB	F 01G 09F OP4 <sup>3</sup>			
	2.2 D Turbo		04.00-07.00	81	LAB	F 01G 09F OGA <sup>3</sup>			
					RAB	F 01G 09F OGB <sup>3</sup>			
			08.00-03.01	81	LAB	F 01G 09F OH6 <sup>3</sup>			
					RAB	F 01G 09F OP4 <sup>3</sup>			
<b>Almera Sedan [N16E]</b>									
	1.5 D Turbo	ABS	03.01-11.06	60/66/72			0 986 473 054		← 57,2
	1.5 i						0 986 474 054		→ 57,2
	1.8 i		03.01-11.06	84/85			0 986 473 054		← 57,2
							0 986 474 054		→ 57,2
	2.2 D Turbo		03.01-11.06	81/82/100			0 986 473 054		← 57,2
							0 986 474 054		→ 57,2
	1.5 D Turbo		03.03-11.06	60			0 986 475 938		↔ 17,46
	1.5 i		03.01-11.06	66/72			0 986 475 938		↔ 17,46
	1.5 D Turbo		04.03-11.06	60			0 986 473 346		← 38
	1.5 D Turbo		03.01-11.06	60/66/72			1 987 477 913		221
	1.5 i		03.01-11.06	60/66/72			1 987 477 914		→ 1661
		ABS						1 987 477 915	



		S							
<b>NISSAN Almera Sedan [N16E]</b>									
	1.8 i	03.01-11.06	84/85				1987 477 913	221	
							1987 477 914	→ 1661	
							1987 477 915	← 1650	
	2.2 D Turbo	03.01-11.06	81/82/100				1987 477 913	221	
							1987 477 914	→ 1661	
							1987 477 915	← 1650	
	1.5 D Turbo	10.02-11.06	60			LAB	0 265 006 702 <sup>3</sup>		
						RAB	0 265 006 703 <sup>3</sup>		
	1.5 i	03.01-07.02	66			LAB	0 265 006 702 <sup>3</sup>		
						RAB	0 265 006 703 <sup>3</sup>		
		08.02-11.06	72			LAB	0 265 007 553 <sup>3</sup>		
						RAB	0 265 007 552 <sup>3</sup>		
	1.8 i	03.01-07.02	84			LAB	0 265 006 702 <sup>3</sup>		
						RAB	0 265 006 703 <sup>3</sup>		
		08.02-11.06	85			LAB	0 265 007 553 <sup>3</sup>		
						RAB	0 265 007 552 <sup>3</sup>		
	MFD	02.03-11.06	85			LAB	0 265 007 555 <sup>4</sup>		
						RAB	0 265 007 554 <sup>4</sup>		
	2.2 D Turbo	03.01-02.03	81			LAB	0 265 006 702 <sup>3</sup>		
						RAB	0 265 006 703 <sup>3</sup>		
		02.03-11.06	82/100			LAB	0 265 007 553 <sup>3</sup>		
							0 265 007 554 <sup>4</sup>		
						RAB	0 265 007 552 <sup>3</sup>		
							0 265 007 554 <sup>4</sup>		
<b>Almera Tino [V10M]</b>									
	1.8 i	05.00-12.05	84-85				0 986 473 485	← 57	
							0 986 474 485	→ 57	
	2.0 i	05.00-01.03	99-100				0 986 473 485	← 57	
							0 986 474 485	→ 57	
	2.2 D Turbo	05.00-12.05	81-84/100				0 986 473 485	← 57	
							0 986 474 485	→ 57	
	1.8 i	05.01-02.03	84-85				0 986 473 346	← 38	
							0 986 474 346	→ 38	
	2.0 i	05.01-01.03	99-100				0 986 473 346	← 38	
							0 986 474 346	→ 38	
	2.2 D Turbo	05.01-01.03	81-84				0 986 473 346	← 38	
							0 986 474 346	→ 38	
	1.8 i	05.00-12.05	84-85				1987 477 913	221	
							1987 477 943	→ 1670	
							1987 477 944	← 1660	
	2.0 i	05.00-01.03	99-100				1987 477 913	221	
							1987 477 943	→ 1670	
							1987 477 944	← 1660	
	2.2 D Turbo	05.00-12.05	81-84/100				1987 477 913	221	
							1987 477 943	→ 1670	
							1987 477 944	← 1660	
	1.8 i	12.00-02.03	84-85			LAB	0 265 006 704 <sup>3</sup>		
						RAB	0 265 006 705 <sup>3</sup>		
		03.03-12.05	84-85			LAB	0 265 007 557 <sup>3</sup>		
							0 265 007 559 <sup>4</sup>		
						RAB	0 265 007 556 <sup>3</sup>		
							0 265 007 558 <sup>4</sup>		

		S							
2.0i		12.00-01.03	99-100			LAB	0 265 006 704 <sup>3</sup>		
						RAB	0 265 006 705 <sup>3</sup>		
2.2D Turbo		12.00-01.03	81-84			LAB	0 265 006 704 <sup>3</sup>		
						RAB	0 265 006 705 <sup>3</sup>		
		02.03-12.05	82/100			LAB	0 265 007 557 <sup>3</sup>		
						RAB	0 265 007 558 <sup>4</sup>		
							0 265 007 559 <sup>4</sup>		
							0 265 007 556 <sup>3</sup>		
							0 265 007 558 <sup>4</sup>		
<b>Altima [L31]</b>									
									
	2.5	09.01-08.04	131			LAB	0 265 007 416 <sup>4</sup>		
						RAB	0 265 007 415 <sup>4</sup>		
		09.01-12.06	131			LAB	0 265 007 413 <sup>3</sup>		
						RAB	0 265 007 414 <sup>3</sup>		
							0 265 007 413 <sup>3</sup>		
		09.04-12.06	131			LAB	0 265 007 762 <sup>4</sup>		
						RAB	0 265 007 763 <sup>4</sup>		
3.5		09.01-08.04	183			LAB	0 265 007 416 <sup>4</sup>		
						RAB	0 265 007 415 <sup>4</sup>		
		09.01-10.06	183			LAB	0 265 007 413 <sup>3</sup>		
						RAB	0 265 007 414 <sup>3</sup>		
		03.04→	183			LAB	0 265 007 414 <sup>3</sup>		
						RAB	0 265 007 413 <sup>3</sup>		
		09.04→	183			LAB	0 265 007 762 <sup>4</sup>		
						RAB	0 265 007 763 <sup>4</sup>		
<b>Altima [U13]</b>									
									
	2.4i	06.92-05.97	110-112				1 987 477 534	250	
<b>Bluebird</b>									
									
	1.8i	09.91-11.95	92				0 986 AB8 156	↔ 17,46	
									
	1.8i	09.91-11.95	92				1 987 477 534	250	
<b>Bluebird Sylphy</b>									
									
	1.5i	12.05-12.12	80				0 265 008 373 <sup>3</sup>		
						LAB	0 265 008 519 <sup>4</sup>		
						RAB	0 265 008 520 <sup>4</sup>		
<b>Cabstar</b>									
									
	3.5	11.96-12.99	87			TW	F 01G 09G 00T	←	
							F 01G 09G 008	→	
							F 01G 09G 08N	←	



		S							
◀ NISSAN									
<b>Cabstar E [TLO]</b>									
	3.0 D Turbo	10.98-08.06	81/88				0 204 001 937	← 48	
							0 986 473 272		
							0 204 001 938	→ 48	
							0 986 474 272		
<b>Cabstar [F 24]</b>									
	2.5 D Turbo	11.11→	90		OZB,TW		1 987 482 395	← 985	
					TW,ZWB		1 987 482 397	← 898	
<b>Cabstar [F23]</b>									
	2.0	07.92-05.94	66						F 026 A08 149 <sup>7</sup>
	2.5 D	07.92-05.96	59						F 026 A08 149 <sup>7</sup>
	2.0	07.92-05.94	66				0 986 475 669	↔ 25,4	
	2.5 D	07.92-05.96	59		OZB		0 986 475 669	↔ 25,4	
					ZWB		F 01G 09G 0DT	↔	
<b>Cabstar [F24]</b>									
	2.5 D Turbo	09.06→	81/96/100/ 107		OZB,TW		1 987 482 395	← 985	
					TW,ZWB		1 987 482 397	← 898	
	3.0 D Turbo	09.06→	110		3T5,TW		1 987 482 397	← 898	
							1 987 482 398	→ 898	
<b>Cabstar ZZ</b>									
	4.6	11.99→	90		TW		F 01G 09G 0DG	←	
							F 01G 09G 0DH	←	
							F 01G 09G 00U	→	
							F 01G 09G 009	→	
	4.6	11.99→	90		TW		F 01G 09G 0DW	→	
							F 01G 09G 08R	→	
							F 01G 09G 09N	←	
<b>Cabstar 20</b>									
	3.2	10.99→	70						F 026 A08 149 <sup>7</sup>
<b>Cedric Sedan [Y30]</b>									
	2.0	06.86-07.95					0 986 J03 701	→	
							0 986 J03 738	→	
							0 986 J03 764	←	
							0 986 J03 789	←	



		S				?			
	2.0		04.87-07.95						F 026 A03 481 <sup>7</sup>
<b>Cedric Wagon [Y30]</b>									
	3.0		06.86-07.95				0 986 J03 701	→	
							0 986 J03 738	→	
							0 986 J03 764	←	
							0 986 J03 789	←	
	3.0		04.87-07.95						F 026 A03 481 <sup>7</sup>
<b>Cube [Z12]</b>									
	1.5 dCi		10.09-05.10	81			0 986 134 251	←	
							0 986 135 251	→	
	1.6		08.09-05.10	81			0 986 134 251	←	
							0 986 135 251	→	
	1.5 dCi		10.09-03.11	81			0 265 008 373 <sup>3</sup>		
						LAB	0 265 008 519 <sup>4</sup>		
						RAB	0 265 008 520 <sup>4</sup>		
	1.6		08.09-03.11	81			0 265 008 373 <sup>3</sup>		
						LAB	0 265 008 519 <sup>4</sup>		
						RAB	0 265 008 520 <sup>4</sup>		
<b>Evalia [M20M]</b>									
	1.5 dCi		10.10→	63-66/ 81-84			0 265 008 396 <sup>3</sup>		
						LAB	0 265 008 600 <sup>4</sup>		
						RAB	0 265 008 601 <sup>4</sup>		
	1.6		01.11→	81			0 265 008 396 <sup>3</sup>		
						LAB	0 265 008 600 <sup>4</sup>		
						RAB	0 265 008 601 <sup>4</sup>		
<b>E20</b>									
	1.8		05.81-12.96	61			F 01G 09G 00K	→	F 01G 09G 02C
							F 01G 09G 00R	→	
							F 01G 09G 01C	←	F 01G 09G 02C
							F 01G 09G 01J	←	
							F 026 A02 136	→	
							F 026 A02 137	←	
	2.0		05.81-12.96				F 01G 09G 00R	←	
							F 01G 09G 01J	→	
							F 026 A02 136	←	
							F 026 A02 137	→	
<b>Frontier</b>									
	2.7D		05.00→	65-66			0 986 475 758	↔ 23,8	



		S							
◀ NISSAN Frontier									
	2.7 D	05.00→	65-66			LAB	F 01G 09F 0A4 <sup>3</sup>		
						RAB	F 01G 09F 0A5 <sup>3</sup>		
<b>Hardbody [D21]</b>									
	2.7 TD 4x4	05.02-06.06	76						F 026 A08 150 <sup>7</sup>
	2.7 TD 4x4	05.02-06.06	76						0 986 J04 338
<b>Hardbody [D22]</b>									
	2.5 D Turbo	01.06-06.08	98						F 026 A03 481 <sup>7</sup>
	2.5 D Turbo 4x4	05.08→	98				F 026 A07 635	↔	
	3.2 D 4x4	05.02-12.08	76						0 986 J04 338
	2.5 D Turbo	01.06-06.08	98				1 987 482 343	← 2250	
							1 987 482 344	→ 1730	
	2.5 D Turbo	01.06-06.08	98			LAB	F 01G 09F 0D9 <sup>3</sup>		
						RAB	F 01G 09F 0A5 <sup>3</sup>		
	2.5 D Turbo 4x4	05.08→	98			LAB	F 01G 09F 0EX <sup>3</sup>		
							F 01G 09F 0FJ <sup>4</sup>		
						RAB	F 01G 09F 0EY <sup>3</sup>		
							F 01G 09F 0FK <sup>4</sup>		
	3.2 D 4x4	05.02-12.08	76			LAB	F 01G 09F 0EX <sup>3</sup>		
							F 01G 09F 0FL <sup>4</sup>		
						RAB	F 01G 09F 0EY <sup>3</sup>		
							F 01G 09F 0FK <sup>4</sup>		
<b>Interstar [X70]</b>									
	1.9 dCi 80	07.02-10.03	59-60			TW	0 204 103 969	← 45	
							0 204 103 970	→ 45	
		ABO 11.03-06.10	59-60			TW	0 204 103 969	← 45	
							0 204 103 970	→ 45	
	2.2 dCi 90	07.02-10.03	66			TW	0 204 103 969	← 45	
							0 204 103 970	→ 45	
		ABO 11.03-06.10	66			TW	0 204 103 969	← 45	
							0 204 103 970	→ 45	
	2.5 dCi 100	ABO 11.03-06.10	73-74			TW	0 204 103 969	← 45	
							0 204 103 970	→ 45	
	2.5 dCi 120	07.02-10.03	84-88			TW	0 204 103 969	← 45	
							0 204 103 970	→ 45	
		ABO 11.03-06.10	84-88			TW	0 204 103 969	← 45	
							0 204 103 970	→ 45	
	3.0 D Turbo dCi 140	ABO 11.03-06.10	99-100			TW	0 204 103 969	← 45	
							0 204 103 970	→ 45	



		S							
	1.9 dCi 80	07.02-06.10	59-60				0 204 004 320	← 42	
							0 986 473 260		
							0 204 004 321	→ 42	
							0 986 474 260		
	2.2 dCi 90	07.02-06.10	66				0 204 004 320	← 42	
							0 986 473 260		
							0 204 004 321	→ 42	
							0 986 474 260		
	2.5 dCi 100	07.02-06.10	73-74/				0 204 004 320	← 42	
	2.5 dCi 120		84-88				0 986 473 260		
							0 204 004 321	→ 42	
							0 986 474 260		
	3.0 D Turbo dCi 140	11.03-06.10	99-100				0 204 004 320	← 42	
							0 986 473 260		
							0 204 004 321	→ 42	
							0 986 474 260		
	1.9 dCi 80	07.02-06.10	59-60				1 987 482 012	1175	
						FKR	1 987 482 013	1420	
						FLR	1 987 477 261	1737	
	2.2 dCi 90	07.02-06.10	66				1 987 482 012	1175	
						FKR	1 987 482 013	1420	
						FLR	1 987 477 261	1737	
	2.5 dCi 100	07.02-06.10	73-74/				1 987 482 012	1175	
	2.5 dCi 120		84-88			FKR	1 987 482 013	1420	
						FLR	1 987 477 261	1737	
	3.0 D Turbo dCi 140	11.03-06.10	99-100				1 987 482 012	1175	
						FKR	1 987 482 013	1420	
						FLR	1 987 477 261	1737	
<b>Kubistar [X76]</b>									
	1.1 i 8V	07.03-03.09	44/55-56			ERH	F 026 002 483	↔ 22,2	
	1.1 i 16V					NON	F 026 002 482	↔ 22	
	1.4 i	07.03-03.09	55			ERH	F 026 002 483	↔ 22,2	
						NON	F 026 002 482	↔ 22	
	1.5 D Turbo 60, D Turbo 70, D Turbo 80	07.03-03.09	40-45/48-50/ 60-62			ERH	F 026 002 483	↔ 22,2	
						NON	F 026 002 482	↔ 22	
	1.6 i	07.03-03.09	70-71			ERH	F 026 002 483	↔ 22,2	
						NON	F 026 002 482	↔ 22	
	1.1 i 8V	07.03-03.09	44/55-56			NON	1 987 477 632	← 1423	
	1.1 i 16V						1 987 477 633	→ 1421	
	1.4 i	07.03-03.09	55			NON	1 987 477 632	← 1423	
							1 987 477 633	→ 1421	
	1.5 D Turbo 60, D Turbo 70, D Turbo 80	07.03-03.09	40-45/48-50/ 60-62			NON	1 987 477 632	← 1423	
							1 987 477 633	→ 1421	
	1.6 i	07.03-03.09	70-71			NON	1 987 477 632	← 1423	
							1 987 477 633	→ 1421	
<b>March</b>									
	1.2 i	07.10→	58				0 986 AB8 157	↔ 15,88	





		S				?			
◀ NISSAN									
<b>Maxima [A34]</b>									
	3.5	02.03-04.04	195						F 026 A03 5397
<b>Maxima [J30]</b>									
	3.0i	09.88-06.94	125/128	LAB	F 01G 09F 00W <sup>4</sup>				
				RAB	F 01G 09F 00X <sup>4</sup>				
					F 01G 09F 04S <sup>3</sup>				
		02.90-06.94	122	RAB	F 01G 09F 04S <sup>3</sup>				
					F 01G 09F 04S <sup>4</sup>				
<b>Maxima QX [A32]</b>									
	2.0i	10.94-07.96	103	LAB	F 01G 09F 07Z <sup>4</sup>				
					F 01G 09F 08H <sup>3</sup>				
				RAB	F 01G 09F 08J <sup>3</sup>				
					F 01G 09F 08O <sup>4</sup>				
		08.96-10.99	103	LAB	F 01G 09F 0A2 <sup>4</sup>				
				RAB	F 01G 09F 0A3 <sup>4</sup>				
		08.96-01.00	103	LAB	F 01G 09F 0EL <sup>3</sup>				
				RAB	F 01G 09F 0EM <sup>3</sup>				
	3.0i	10.94-07.96	142	LAB	F 01G 09F 07Z <sup>4</sup>				
					F 01G 09F 08H <sup>3</sup>				
				RAB	F 01G 09F 08J <sup>3</sup>				
					F 01G 09F 08O <sup>4</sup>				
		08.96-10.99	142	LAB	F 01G 09F 0A2 <sup>4</sup>				
				RAB	F 01G 09F 0A3 <sup>4</sup>				
		08.96-01.00	142	LAB	F 01G 09F 0EL <sup>3</sup>				
				RAB	F 01G 09F 0EM <sup>3</sup>				
<b>Maxima QX [CA33]</b>									
	3.0i	08.96→	147	LAB	F 01G 09F 0EL <sup>3</sup>				
				RAB	F 01G 09F 0EM <sup>3</sup>				
		11.97→	147	LAB	F 01G 09F 0A2 <sup>4</sup>				
<b>Micra CC [K12E]</b>									
	1.4i	09.05-10.10	65		0986 473 420		← 54		
					0986 474 420		→ 54		
	1.6i	09.05-10.10	81		0986 473 420		← 54		
					0986 474 420		→ 54		
	1.4i	09.05-10.10	65		0986 475 933		↔ 19,05		
	1.6i	09.05-10.10	81		0986 475 933		↔ 19,05		
	1.4i	09.05-10.10	65		1987 477 979		200		
					1987 477 980		→ 1604		
					1987 477 992		← 1540		
	1.6i	09.05-10.10	81		1987 477 979		200		
					1987 477 980		→ 1604		
					1987 477 992		← 1540		





	1.4i	09.05-10.10	65		0 265 007 537 <sup>3</sup>	
				LAB	0 265 008 323 <sup>4</sup>	
				RAB	0 265 008 324 <sup>4</sup>	
	1.6i	09.05-10.10	81		0 265 007 537 <sup>3</sup>	
				LAB	0 265 008 323 <sup>4</sup>	
				RAB	0 265 008 324 <sup>4</sup>	

**Micra [K11E]**



	1.0i	08.92-07.00	40-44		0 986 473 001	← 54		
					0 986 474 001	→ 48		
				ABO	08.00-10.02	40-44	0 986 473 001	← 54
							0 986 474 001	→ 48
				ABS	08.00-04.01	40-44	0 986 134 043	← 48
							0 986 135 043	→ 48
				1.3i	08.92-10.00	55	0 986 473 001	← 54
							0 986 474 001	→ 48
				1.4i	ABO 07.00-10.02	60	0 986 473 001	← 54
					ABS 07.00-03.01	60	0 986 134 043	← 48
			0 986 135 043	→ 48				
1.5D	02.98-07.00	42	0 986 473 001	← 54				
			0 986 474 001	→ 48				
	ABO 07.00-10.02	42	0 986 473 001	← 54				
			0 986 474 001	→ 48				
	ABS 07.00-03.01	42	0 986 134 043	← 48				
			0 986 135 043	→ 48				



	1.0i	08.92-10.02	40-44		0 986 475 674	↔ 17,46		
				1.3i	08.92-07.00	55	0 986 475 674	↔ 17,46
				1.4i	07.00-10.02	60	0 986 475 674	↔ 17,46
				1.5D	02.98-10.02	42	0 986 475 674	↔ 17,46

	1.0i	08.92-02.98	40-44		0 986 474 839	← 30,1
				1.3i	08.92-10.00	55

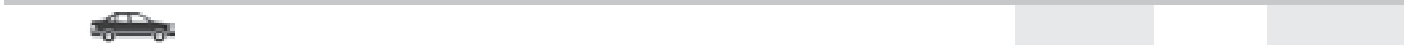

	1.0i	08.92-02.98	40-44	TBR	1 987 477 394	→ 1433			
					1 987 477 534	250			
				SBR	1 987 482 150	← 1287			
					1 987 482 151	→ 1310			
				1.3i	08.92-02.98	55	TBR	1 987 477 394	→ 1433
								1 987 477 534	250
					08.92-10.00	55	SBR	1 987 482 150	← 1287
								1 987 482 151	→ 1310
				1.4i	07.00-10.02	60		1 987 477 534	250
				1.5D	02.98-07.00	42		1 987 477 394	→ 1433
	02.98-10.02	42					1 987 477 534	250	

	1.0i	01.96-02.98	40-44	RBA	0 265 006 256 <sup>4</sup>							
					01.96-07.00	40-44	LAB	RBA	0 265 006 255 <sup>3</sup>			
					01.96-11.00	40-44	RAB	RBA	0 265 006 254 <sup>3</sup>			
					03.98-10.02	40-44		RBA	0 265 006 382 <sup>4</sup>			
					08.00-11.00	40-44	LAB		0 265 006 658 <sup>3</sup>			
					12.00-10.02	40-44	LAB		0 265 006 714 <sup>3</sup>			
							RAB		0 265 006 715 <sup>3</sup>			
				1.3i	01.96-02.98	55		RBA	0 265 006 256 <sup>4</sup>			
								01.96-10.00	55	LAB	RBA	0 265 006 255 <sup>3</sup>
										RAB	RBA	0 265 006 254 <sup>3</sup>



		S							
	◀ NISSAN Micra [K11E]								
1.3 i		03.98-07.00	55			RBA	0 265 006 382 <sup>4</sup>		
1.4 i		07.00-11.00	60			LAB	0 265 006 658 <sup>3</sup>		
					RAB	0 265 006 254 <sup>3</sup>			
		07.00-10.02	60				0 265 006 382 <sup>4</sup>		
		12.00-10.02	60			LAB	0 265 006 714 <sup>3</sup>		
1.5 D		07.00-11.00	42			RAB	0 265 006 715 <sup>3</sup>		
					LAB	0 265 006 658 <sup>3</sup>			
		07.00-10.02	42				0 265 006 382 <sup>4</sup>		
		12.00-10.02	42			LAB	0 265 006 714 <sup>3</sup>		
						RAB	0 265 006 715 <sup>3</sup>		
<b>Micra [K12E]</b>									
	1.0 i	11.02-05.05	48				0 986 473 420		← 54
							0 986 474 420		→ 54
	1.2 i	11.02-10.10	48/59				0 986 473 420		← 54
							0 986 474 420		→ 54
	1.4 i	11.02-10.10	65				0 986 473 420		← 54
							0 986 474 420		→ 54
	1.5 D Turbo	02.03-10.10	48-50/ 60-63				0 986 473 420		← 54
							0 986 474 420		→ 54
	1.6 i	06.05-10.10	81				0 986 473 420		← 54
							0 986 474 420		→ 54
	1.0 i	11.02-05.05	48				0 986 475 933		↔ 19,05
							0 986 475 933		↔ 19,05
	1.2 i	11.02-10.10	48/59				0 986 475 933		↔ 19,05
							0 986 475 933		↔ 19,05
	1.5 D Turbo	02.03-10.10	48-50/60-63				0 986 475 933		↔ 19,05
							0 986 475 933		↔ 19,05
	1.6 i	06.05-10.10	81				0 986 475 933		↔ 19,05
							0 986 475 933		↔ 19,05
	1.0 i	11.02-05.05	48				1 987 477 979		200
							1 987 477 980		→ 1604
	1.2 i	11.02-10.10	48/59				1 987 477 992		← 1540
							1 987 477 979		200
	1.4 i	11.02-10.10	65				1 987 477 980		→ 1604
							1 987 477 992		← 1540
	1.5 D Turbo	02.03-10.10	48-50/ 60-63				1 987 477 979		200
							1 987 477 980		→ 1604
	1.6 i	06.05-10.10	81				1 987 477 992		← 1540
							1 987 477 979		200
	1.0 i	11.02-05.05	48				1 987 477 980		→ 1604
							1 987 477 992		← 1540
	1.0 i	11.02-05.05	48				0 265 007 537 <sup>3</sup>		
							LAB	0 265 008 323 <sup>4</sup>	
	1.2 i	11.02-10.10	48/59				RAB	0 265 008 324 <sup>4</sup>	
								0 265 007 537 <sup>3</sup>	
	1.4 i	11.02-10.10	65				LAB	0 265 008 323 <sup>4</sup>	
							RAB	0 265 008 324 <sup>4</sup>	
	1.5 D Turbo	02.03-10.10	48-50/ 60-63				0 265 007 537 <sup>3</sup>		
							LAB	0 265 008 323 <sup>4</sup>	
							RAB	0 265 008 324 <sup>4</sup>	



		S								
1.6i		06.05-10.10	81							0 265 007 537 <sup>3</sup>
										LAB 0 265 008 323 <sup>4</sup>
										RAB 0 265 008 324 <sup>4</sup>
<b>Micra [K13K]</b>										
	1.2 DIG-S	07.10→	59/72							0 204 716 708 ↔
	1.2i									
	1.5	05.11→	74							0 204 716 708 ↔
	1.2 DIG-S	07.10→	59/72							0 265 008 311 <sup>3</sup>
	1.2i									LAB 0 265 008 312 <sup>4</sup>
										RAB 0 265 008 313 <sup>4</sup>
	1.5	05.11→	74							0 265 008 311 <sup>3</sup>
										LAB 0 265 008 312 <sup>4</sup>
										RAB 0 265 008 313 <sup>4</sup>
<b>Navara [D40]</b>										
	2.5 dCi, 4x4	05.05→	106/120/126-128/140							F 026 002 005 ↔ 22,2
	3.0 dCi 4x4	05.10→	170							F 026 002 005 ↔ 22,2
	2.5 dCi, 4x4	05.05→	106/120/ 126-128/140							1 987 482 424 → 2211
										1 987 482 425 ← 2440
	3.0 dCi 4x4	05.10→	170							1 987 482 424 → 2211
										1 987 482 425 ← 2440
<b>Note [E11]</b>										
	1.5 dCi 70, 86, 90, 105	01.06→	50/63/66/76							0 986 473 420 ↻ ← 54
										0 986 474 420 ↻ → 54
	1.6	01.06→	81							0 986 473 420 ↻ ← 54
										0 986 474 420 ↻ → 54
	1.5 dCi 70, 86, 90, 105	01.06→	50/63/66/76							0 986 475 933 ↔ 19,05
	1.5i	01.05-08.12	80-85			AG				F 026 A06 938 ↔
	1.6	01.06→	81							0 986 475 933 ↔ 19,05
	1.5 dCi 70, 86, 90, 105	01.06→	50/63/66/76							1 987 477 979 200
	1.6	01.06→	81							1 987 477 979 200
		1.5 dCi 70, 86, 90, 105	01.06→	50/63/66/76						0 265 007 537 <sup>3</sup>
										LAB 0 265 008 323 <sup>4</sup>
										RAB 0 265 008 324 <sup>4</sup>
	1.6	01.06→	81							0 265 007 537 <sup>3</sup>
										LAB 0 265 008 323 <sup>4</sup>
										RAB 0 265 008 324 <sup>4</sup>
<b>Note [E11E]</b>										
	1.4	01.06→	65							0 986 473 420 ↻ ← 54
										0 986 474 420 ↻ → 54



		S							
◀ NISSAN Note [E11E]									
	1.4	01.06→	65				0986 475 933		↔ 19,05
	1.4	01.06→	65				1987 477 979		200
	1.4	01.06→	65				0 265 007 537 <sup>3</sup>		
						LAB	0 265 008 323 <sup>4</sup>		
						RAB	0 265 008 324 <sup>4</sup>		
Note [E12]									
	1.2, DIG-S	08.13→	59/72				0 204 716 708		↔
	1.5 DCi Turbo	12.13→	66				0 204 716 708		↔
	1.2, DIG-S	08.13→	59/72				0 265 008 311 <sup>3</sup>		
						LAB	0 265 008 312 <sup>4</sup>		
						RAB	0 265 008 313 <sup>4</sup>		
	1.5 DCi Turbo	12.13→	66				0 265 008 311 <sup>3</sup>		
						LAB	0 265 008 312 <sup>4</sup>		
						RAB	0 265 008 313 <sup>4</sup>		
NP300 [D22SS]									
	2.5 dCi	08.10→	98			T26	F 026 A06 939		↔
						295	F 026 A07 635		↔
	2.5 dCi 4x4	08.10→	98				F 026 A07 635		↔
	2.5 dCi	08.10→	98			HBV	1 987 482 343		← 2250
							1 987 482 344		→ 1730
	2.5 dCi	08.10→	98			LAB	0 265 008 507 <sup>3</sup>		
							0 265 008 508 <sup>3</sup>		
							0 265 008 587 <sup>4</sup>		
						RAB	0 265 008 506 <sup>3</sup>		
							0 265 008 509 <sup>3</sup>		
							0 265 008 588 <sup>4</sup>		
	2.5 dCi 4x4	08.10→	98			LAB	F 01G 09F 0EX <sup>3</sup>		
							F 01G 09F 0FL <sup>4</sup>		
							0 265 008 508 <sup>3</sup>		
							0 265 008 510 <sup>4</sup>		
						RAB	F 01G 09F 0EY <sup>3</sup>		
							F 01G 09F 0FK <sup>4</sup>		
							0 265 008 509 <sup>3</sup>		
							0 265 008 511 <sup>4</sup>		
NV200 [M20]									
	1.5 dCi	08.09-05.10	63				0 265 008 396 <sup>3</sup>		
						LAB	0 265 008 600 <sup>4</sup>		
						RAB	0 265 008 601 <sup>4</sup>		



1.6		08.09-05.10	81						0 265 008 396 <sup>3</sup>
									LAB 0 265 008 600 <sup>4</sup>
									RAB 0 265 008 601 <sup>4</sup>
<b>NV200 [M20M]</b>									
	1.5 dCi	11.09→	63/66/78						0 265 008 396 <sup>3</sup>
									LAB 0 265 008 600 <sup>4</sup>
									RAB 0 265 008 601 <sup>4</sup>
	1.6	11.09→	81						0 265 008 396 <sup>3</sup>
									LAB 0 265 008 600 <sup>4</sup>
									RAB 0 265 008 601 <sup>4</sup>
<b>Pathfinder</b>									
	3.3i	09.95-07.02	125						F 026 A03 544 <sup>7</sup>
	3.3i	09.95-04.06	125						F 01G 09G 06A ↔ F 026 002 392 ↔ 22,22
<b>Pathfinder [D21]</b>									
	3.0i 4WD	08.93-07.95	113						F 026 A03 481 <sup>7</sup>
	3.0i 4WD	07.92-07.95	113						0 986 475 758 ↔ 23,8
<b>Pathfinder [R50]</b>									
	3.3i	09.95→	110-125						F 026 A03 498 <sup>7</sup>
	3.3i 4x4	10.97-07.02	110-125						F 026 A03 544 <sup>7</sup>
	3.5i	07.00→	162						F 026 A03 544 <sup>7</sup>
	3.5 4x4								
	3.3i	09.95→	110-125						F 01G 09G 066 ↔
	3.3i 4x4	10.97-07.02	110-125						F 01G 09G 06A ↔
	3.5i	07.00-06.01	162						F 01G 09G 06A ↔
		07.01-07.04	162						F 026 A07 635 ↔
	3.5 4x4	07.02→	162						F 026 A07 635 ↔
	3.3i	09.95→	110-125						LAB F 01G 09F 0DK <sup>4</sup>
	3.3i 4x4								RAB F 01G 09F 06U <sup>3</sup>
									F 01G 09F 0DL <sup>4</sup>
									F 01G 09F 06V <sup>3</sup>
	3.5i	07.00-09.00	162						LAB F 01G 09F 0DK <sup>4</sup>
									RAB F 01G 09F 06U <sup>3</sup>
									F 01G 09F 0DL <sup>4</sup>
									F 01G 09F 06V <sup>3</sup>
		10.00-08.02	162						LAB F 01G 09F 0HF <sup>4</sup>
									RAB F 01G 09F 0HG <sup>4</sup>



		S							
<b>NISSAN Pathfinder [R50]</b>									
	3.5 i	10.00-07.04	162			LAB	F 01G 09F 0H7 <sup>3</sup>		
		09.02-07.04	162				F 01G 09F 0HF <sup>4</sup>		
	3.5 i, 4x4	10.00→	162			RAB	F 01G 09F 0H8 <sup>3</sup>		
	3.5 4x4	07.02→	162				F 01G 09F 0HF <sup>4</sup>		
						LAB	F 01G 09F 0H7 <sup>3</sup>		
<b>Patrol GR [Y60]</b>									
	4.2	08.87-09.97	92/125				0986 475 669	↔ 25,4	
				4.2D					
	4.2D	08.87-09.97	92						F 026 A08 091 <sup>7</sup>
<b>Patrol GR [Y61]</b>									
	2.8 D Turbo, 4x4	10.97-02.00	95-96						F 026 A03 471 <sup>7</sup>
	3.0 dCi 4x4, Di Hardtop 4x4, Di 4x4	02.00-03.10	116/118						F 026 A03 471 <sup>7</sup>
	4.2D	10.97→	107						F 026 A03 471 <sup>7</sup>
	4.5 i	08.97→	147						F 026 A03 471 <sup>7</sup>
	2.8 D Turbo	10.97-02.00	95-96						F 026 A03 472 <sup>7</sup>
	2.8 D Turbo 4x4	10.97-02.00	95-96						F 026 A03 499 <sup>7</sup>
	3.0 dCi 4x4	01.07-03.10	118						F 026 A03 499 <sup>7</sup>
	3.0 Di Hardtop 4x4	02.00-06.04	116						F 026 A03 499 <sup>7</sup>
		12.06-03.10	116						F 026 A03 499 <sup>7</sup>
	3.0 Di 4x4	02.00-06.04	116						F 026 A03 499 <sup>7</sup>
		12.06-03.10	116						F 026 A03 499 <sup>7</sup>
	4.2D	10.97→	107						F 026 A03 472 <sup>7</sup>
	4.5 i	08.97→	147						F 026 A03 472 <sup>7</sup>
	2.8 D Turbo	10.97-02.00	95-96			LAB	F 01G 09F 0F8 <sup>4</sup>		
						RAB	F 01G 09F 07F <sup>3</sup>		
							F 01G 09F 0F7 <sup>4</sup>		
	2.8 D Turbo 4x4	10.97-02.00	95-96			LAB	F 01G 09F 0F7 <sup>4</sup>		
						RAB	F 01G 09F 0HY <sup>3</sup>		
							F 01G 09F 0F8 <sup>4</sup>		
	3.0 dCi 4x4	02.00-03.10	116/118			LAB	F 01G 09F 0F7 <sup>4</sup>		
							F 01G 09F 0HY <sup>3</sup>		
	3.0 Di Hardtop 4x4					RAB	F 01G 09F 0F8 <sup>4</sup>		
							F 01G 09F 0HZ <sup>3</sup>		
	3.0 Di 4x4					RAB	F 01G 09F 0F8 <sup>4</sup>		
							F 01G 09F 0HZ <sup>3</sup>		
	4.5 i	08.97→	147			LAB	F 01G 09F 0F8 <sup>4</sup>		
							F 01G 09F 07F <sup>3</sup>		
						RAB	F 01G 09F 0F7 <sup>4</sup>		
	4.8	10.02-03.10	180-185			LAB	F 01G 09F 0F7 <sup>4</sup>		
						RAB	F 01G 09F 0HY <sup>3</sup>		
							F 01G 09F 0F8 <sup>4</sup>		
	4.8 i 4x4	08.04→	190			LAB	F 01G 09F 0HZ <sup>3</sup>		
							0265 008 565 <sup>4</sup>		
					RAB	0265 008 566 <sup>3</sup>			
						0265 008 567 <sup>4</sup>			
						0265 008 568 <sup>3</sup>			



		S				?			
<b>Patrol [260]</b>									
	2.8 D, Turbo	03.91-05.98	57/70/80/85				0 204 011 273	↔ 25,4	
	3.0	03.91-05.98	99				0 204 011 273	↔ 25,4	
<b>Pickup [D21]</b>									
	2.0	09.85-09.95	65						F 026 A08 150 <sup>7</sup>
	2.4 i, i 4x4	04.92-02.98	91-93						F 026 A03 481 <sup>7</sup>
	2.0	09.85-09.95	65				F 026 A02 133	↔	
		10.89-09.95	65				0 986 475 758	↔ 23,8	
		04.92-05.94	64				0 986 475 758	↔ 23,8	
	2.4 i	04.92-02.98	91-93				0 986 475 758	↔ 23,8	
	2.4 i 2WD	03.92-01.97	93				0 986 475 758	↔ 23,8	
	2.4 i 4x4	04.92-02.98	91-93				F 026 A07 681	↔	
	2.5 D	10.88-02.98	59-63				0 986 475 758	↔ 23,8	
	2.5 D 4WD	05.92-02.98	59-63				F 026 A07 681	↔	
	2.7 D	08.87-01.97	73				0 986 J04 012	↔	
	2.7 D 2WD	10.89-01.97	62				0 986 475 758	↔ 23,8	
	2.7 D 4WD	08.87-01.97	73				0 986 J04 037	↔	
<b>Pickup [D22]</b>									
	2.4 i, i 4WD	02.98-10.03	88/98						F 026 A03 481 <sup>7</sup>
	2.5 D Turbo	11.01-10.03	98		NOR				F 026 A03 481 <sup>7</sup>
	2.5 D, D Turbo 4WD, D 4WD	02.98-11.01	61/76						F 026 A03 481 <sup>7</sup>
	2.7 D 2WD	02.97→	64						F 026 A08 150 <sup>7</sup>
	3.2 D 4WD	02.97-12.07	76		TW				F 026 A03 481 <sup>7</sup>
	2.4 i	02.98-11.01	88		DOP		F 01G 09G 06A	↔	
					SDK		0 986 475 758	↔ 23,8	
		11.01-02.02	98				0 986 475 758	↔ 23,8	
		02.07-01.08	98				F 026 A06 939	↔	
	2.4 i 4WD	02.98-11.01	88				F 01G 09G 06A	↔	
		11.01-01.08	98				F 026 A07 635	↔	
	2.5 D Turbo	11.01-02.02	98		NOR		0 986 475 758	↔ 23,8	
		11.01-01.08	98		SA		F 026 A07 635	↔	
		02.07-01.08	98		NOR		F 026 A06 939	↔	
	2.5 D Turbo 4WD	05.98-11.01	76				F 01G 09G 06A	↔	
		11.01-01.08	98				F 026 A07 635	↔	
	2.5 D, D 4WD	02.98-11.01	61				0 986 475 758	↔ 23,8	
	2.5 dCi	02.08-12.11	98		T26		F 026 A06 939	↔	
					295		F 026 A07 635	↔	
	2.5 dCi 4x4	02.08-12.11	98				F 026 A07 635	↔	
	2.7 D 2WD	02.97→	64				0 986 475 758	↔ 23,8	
	3.2 D 4WD	02.97-10.01	76				F 01G 09G 06A	↔	
		11.01-12.07	76				F 026 A07 635	↔	
	2.4 i	11.01-01.08	98				1 987 482 343	← 2250	
	2.4 i 4WD						1 987 482 344	→ 1730	
	2.5 D Turbo	11.01-01.08	98				1 987 482 343	← 2250	
	2.5 D Turbo 4WD						1 987 482 344	→ 1730	







NISSAN Pickup [D22]

	2.5 dCi	02.08-12.11	98	HBV	1987 <b>482 343</b>	← 2250
					1987 <b>482 344</b>	→ 1730
	2.4 i	07.98-11.01	88	LAB	F 01G <b>09F 0A4</b> <sup>3</sup>	
		11.01-01.08	98	RAB	F 01G <b>09F 0A5</b> <sup>3</sup>	
				LAB	F 01G <b>09F 0BY</b> <sup>3</sup>	
				RAB	F 01G <b>09F 0BZ</b> <sup>3</sup>	
	2.4 i 4WD	02.98-11.01	88	LAB	F 01G <b>09F 0EX</b> <sup>3</sup>	
				RAB	F 01G <b>09F 0FJ</b> <sup>4</sup>	
		11.01-01.08	98	LAB	F 01G <b>09F 0FK</b> <sup>4</sup>	
				RAB	F 01G <b>09F 0FK</b> <sup>4</sup>	
				RAB	F 01G <b>09F 0HR</b> <sup>3</sup>	
	2.5 D Turbo	11.01-03.03	98	4-K,LAB	F 01G <b>09F 0J0</b> <sup>4</sup>	
		11.01-09.03	98	LAB,NOR	F 01G <b>09F 0A4</b> <sup>3</sup>	
		11.01-01.08	98	LAB,SA	F 01G <b>09F 0EX</b> <sup>3</sup>	
				NOR,RAB	F 01G <b>09F 0A5</b> <sup>3</sup>	
				RAB,SA	F 01G <b>09F 0EY</b> <sup>3</sup>	
				4-K,RAB	F 01G <b>09F 0HV</b> <sup>4</sup>	
		04.03-01.08	98	4-K,LAB	F 01G <b>09F 0HU</b> <sup>4</sup>	
		10.03-01.08	98	LAB,NOR	F 01G <b>09F 0D9</b> <sup>3</sup>	
	2.5 D Turbo 4WD	05.98-11.01	76	LAB	F 01G <b>09F 0EX</b> <sup>3</sup>	
				RAB	F 01G <b>09F 0FK</b> <sup>4</sup>	
		11.01-01.08	98	LAB	F 01G <b>09F 0EX</b> <sup>3</sup>	
				RAB	F 01G <b>09F 0FJ</b> <sup>4</sup>	
				RAB	F 01G <b>09F 0FL</b> <sup>4</sup>	
				RAB	F 01G <b>09F 0EY</b> <sup>3</sup>	
				RAB	F 01G <b>09F 0FK</b> <sup>4</sup>	
	2.5 D	07.98-11.01	61	LAB	F 01G <b>09F 0A4</b> <sup>3</sup>	
	2.5 D 4WD			RAB	F 01G <b>09F 0A5</b> <sup>3</sup>	
	2.5 dCi	02.08-12.11	98	LAB,TW	F 01G <b>09F 0D9</b> <sup>3</sup>	
				RAB,TW	F 01G <b>09F 0A5</b> <sup>3</sup>	
				295,TW	F 01G <b>09F 0HV</b> <sup>4</sup>	
		12.09-12.11	98	LAB,TW	0 265 <b>008 507</b> <sup>3</sup>	
				RAB,TW	0 265 <b>008 508</b> <sup>3</sup>	
				RAB,TW	0 265 <b>008 506</b> <sup>3</sup>	
				295,TW	0 265 <b>008 509</b> <sup>3</sup>	
				295,TW	0 265 <b>008 588</b> <sup>4</sup>	
	2.5 dCi	02.08-12.11	98	LAB,TW	F 01G <b>09F 0EX</b> <sup>3</sup>	
	2.5 dCi 4x4			RAB,TW	F 01G <b>09F 0EY</b> <sup>3</sup>	
	2.5 dCi 4x4	02.08-12.11	98	LAB,TW	F 01G <b>09F 0FJ</b> <sup>4</sup>	
				RAB,TW	F 01G <b>09F 0FL</b> <sup>4</sup>	
				RAB,TW	F 01G <b>09F 0FK</b> <sup>4</sup>	
		12.09-12.11	98	LAB,TW	0 265 <b>008 508</b> <sup>3</sup>	
				RAB,TW	0 265 <b>008 510</b> <sup>4</sup>	
				RAB,TW	0 265 <b>008 509</b> <sup>3</sup>	
				RAB,TW	0 265 <b>008 511</b> <sup>4</sup>	
	3.2 D 4WD	02.97-10.01	76	LAB	F 01G <b>09F 0FL</b> <sup>4</sup>	
		02.97-12.07	76	LAB	F 01G <b>09F 0EX</b> <sup>3</sup>	
				RAB	F 01G <b>09F 0EY</b> <sup>3</sup>	
				RAB	F 01G <b>09F 0FK</b> <sup>4</sup>	
		11.01-12.07	76	LAB	F 01G <b>09F 0FJ</b> <sup>4</sup>	









































Pixo Hatchback [UA0]

	1.0	03.09→	50		F 026 <b>002 009</b>	↔ 19,05
--	-----	--------	----	--	----------------------	---------

		S							
<b>Prairie Pro [M11]</b>									
	2.4i	04.92-07.94	98				0 986 475 675	↔ 17,4	
<b>Primastar [X83]</b>									
	1.9 dCi 80	07.02-12.07	59-60/74				1 987 482 387	↔ 1498	
	1.9 dCi 80	07.02-12.07	59-60/74		FKR,MI		1 987 482 043	1190	
	1.9 dCi 100				FLR,MI		1 987 482 145	1585	
					LLE		1 987 482 042	508	
	1.9 dCi 100	07.02-12.07	59-60/74				1 987 482 387	↔ 1498	
	2.0 dCi 90	10.06→	66/84-85/86-88				1 987 482 387	↔ 1498	
	2.0 dCi 90	02.03→	66/84-85/		FKR,MI		1 987 482 043	1190	
	2.0 dCi 115		86-88		FLR,MI		1 987 482 145	1585	
	2.0i				LLE		1 987 482 042	508	
	2.0 dCi 115	10.06→	66/84-85/86-88				1 987 482 387	↔ 1498	
	2.0i	02.03-11.11	66/84-85/86-88				1 987 482 387	↔ 1498	
	2.5 dCi 135	09.03-11.11	99				1 987 482 387	↔ 1498	
					FKR,MI		1 987 482 043	1190	
					FLR,MI		1 987 482 145	1585	
					LLE		1 987 482 042	508	
	2.5 dCi 150	10.06→	107-110				1 987 482 387	↔ 1498	
					FKR,MI		1 987 482 043	1190	
					FLR,MI		1 987 482 145	1585	
<b>Primera Hatchback [P10E]</b>									
	2.0D	01.91-06.96	55				0 204 102 370	← 54	0 204 104 154 <sup>7</sup>
							0 204 103 370		
							0 204 102 745	→ 54	0 204 104 154 <sup>7</sup>
							0 204 103 745		
	2.0i	06.90-06.96	110				0 986 473 136	← 57,1	
	2.0i 4WD						0 986 474 136	→ 57,1	
	1.6i	05.93-09.94	71-75				F 026 002 220	← 20,6	
							F 026 002 221	→ 20,6	
		10.94-06.96	71-75				F 026 002 462	→ 20,6	
							F 026 002 464	← 20,6	
	2.0i	06.90-06.96	110				0 986 473 243	← 34	
							0 986 474 243	→ 34	
	2.0i 4WD	04.91-06.96	110				0 986 473 050	← 34	
							0 986 474 050	→ 34	
	2.0D	01.91-06.96	55				1 987 477 399	→ 1603	
							1 987 477 405	← 1623	
	2.0i	06.90-06.96	110				1 987 477 754	→ 1491	
							1 987 477 759	← 1516	
	2.0i	06.90-06.96	110		LAB		0 265 001 274 <sup>3</sup>		
							0 265 001 276 <sup>4</sup>		
					RAB		0 265 001 273 <sup>3</sup>		
							0 265 001 275 <sup>4</sup>		
		09.94-06.96	85-92		LAB		0 265 001 274 <sup>3</sup>		
							0 265 001 276 <sup>4</sup>		





















		S							
	<b>NISSAN Primera Hatchback [P10E]</b>								
<b>2.0 i</b>		09.94-06.96	85-92			RAB	0 265 <b>001 273</b> <sup>3</sup>		
							0 265 <b>001 275</b> <sup>4</sup>		
<b>2.0 i 4WD</b>		04.91-09.94	110			LAB	0 265 <b>001 313</b> <sup>3</sup>		
						RAB	0 265 <b>001 312</b> <sup>3</sup>		
		09.94-06.96	110			LAB	0 265 <b>001 276</b> <sup>4</sup>		
		10.94-06.96	110			LAB	0 265 <b>001 274</b> <sup>3</sup>		
						RAB	0 265 <b>001 273</b> <sup>3</sup>		
							0 265 <b>001 275</b> <sup>4</sup>		
<b>Primera Hatchback [P11E]</b>									
	<b>1.6 i</b>	06.96-04.98	66-73				0 986 <b>473 054</b>		← 57,2
							0 986 <b>474 054</b>		→ 57,2
		04.98-05.99	66-73			NOR	0 986 <b>473 054</b>		← 57,2
							0 986 <b>474 054</b>		→ 57,2
						SA	0 986 <b>473 054</b>		← 57,2
							0 986 <b>474 054</b>		→ 57,2
		06.99-12.99	73			NOR	0 986 <b>473 054</b>		← 57,2
							0 986 <b>474 054</b>		→ 57,2
		06.99-12.01	73			SA	0 986 <b>473 054</b>		← 57,2
							0 986 <b>474 054</b>		→ 57,2
		09.00-12.01	78			SA	0 986 <b>473 054</b>		← 57,2
							0 986 <b>474 054</b>		→ 57,2
	<b>1.8 i</b>	06.99-12.99	84			NOR	0 986 <b>473 054</b>		← 57,2
							0 986 <b>474 054</b>		→ 57,2
		06.99-12.01	84			SA	0 986 <b>473 054</b>		← 57,2
							0 986 <b>474 054</b>		→ 57,2
	<b>2.0 D Turbo</b>	06.96-04.98	66				0 986 <b>473 054</b>		← 57,2
							0 986 <b>474 054</b>		→ 57,2
		04.98-06.99	66			TSE	0 986 <b>473 054</b>		← 57,2
							0 986 <b>474 054</b>		→ 57,2
		04.98-12.99	66			NOR	0 986 <b>473 054</b>		← 57,2
							0 986 <b>474 054</b>		→ 57,2
		04.98-12.01	66			SA	0 986 <b>473 054</b>		← 57,2
							0 986 <b>474 054</b>		→ 57,2
	<b>2.0 i</b>	06.96-10.97	85				0 986 <b>473 054</b>		← 57,2
							0 986 <b>474 054</b>		→ 57,2
		06.96-04.98	96				0 986 <b>473 054</b>		← 57,2
							0 986 <b>474 054</b>		→ 57,2
		04.98-06.99	96			TSE	0 986 <b>473 054</b>		← 57,2
							0 986 <b>474 054</b>		→ 57,2
		06.99-12.01	103			AG	0 986 <b>473 054</b>		← 57,2
							0 986 <b>474 054</b>		→ 57,2
		ABO 04.98-06.99	96				0 986 <b>473 054</b>		← 57,2
							0 986 <b>474 054</b>		→ 57,2
		ABS 04.98-06.99	96				0 986 <b>473 054</b>		← 57,2
							0 986 <b>474 054</b>		→ 57,2
	<b>2.0 i GT</b>	06.96-06.99	110				0 986 <b>473 054</b>		← 57,2
							0 986 <b>474 054</b>		→ 57,2
	<b>1.6 i</b>	06.96-05.99	66-73				F 026 <b>002 006</b>		↔ 20,6
		01.01-12.01	73/78				0 986 <b>475 938</b>		↔ 17,46
	<b>1.8 i</b>	01.01-12.01	84				0 986 <b>475 938</b>		↔ 17,46
	<b>2.0 D Turbo</b>	06.96-12.01	66				F 026 <b>002 006</b>		↔ 20,6
		01.01-12.01	66				0 986 <b>475 938</b>		↔ 17,46
	<b>1.6 i</b>	10.97-05.99	66-73				0 986 <b>473 055</b>		← 34
							0 986 <b>474 055</b>		→ 34
		06.99-01.01	73/78			NOR	0 986 <b>473 055</b>		← 34
							0 986 <b>474 055</b>		→ 34

		S							
<b>1.6i</b>	06.99-03.01	73/78				SA	0 986 473 055		← 34
							0 986 474 055		→ 34
<b>1.8i</b>	06.99-01.01	84				NOR	0 986 473 055		← 34
							0 986 474 055		→ 34
	06.99-03.01	84				SA	0 986 473 055		← 34
							0 986 474 055		→ 34
<b>2.0D Turbo</b>	10.97-04.98	66					0 986 473 055		← 34
							0 986 474 055		→ 34
	04.98-06.99	66				TSE	0 986 473 055		← 34
							0 986 474 055		→ 34
	06.99-01.01	66				NOR	0 986 473 055		← 34
							0 986 474 055		→ 34
	06.99-03.01	66				SA	0 986 473 055		← 34
							0 986 474 055		→ 34
ABO	04.98-06.99	66				GXA,SLX	0 986 473 055		← 34
							0 986 474 055		→ 34
ABS	04.98-06.99	66				GXA,SLX	0 986 473 055		← 34
							0 986 474 055		→ 34
<b>2.0i</b>	06.96-10.97	85					0 986 473 055		← 34
							0 986 474 055		→ 34
	06.96-04.98	96					0 986 473 055		← 34
							0 986 474 055		→ 34
	06.99-03.01	103					0 986 473 055		← 34
							0 986 474 055		→ 34
ABO	04.98-06.99	96					0 986 473 055		← 34
							0 986 474 055		→ 34
ABS	04.98-06.99	96					0 986 473 055		← 34
							0 986 474 055		→ 34
<b>2.0i GT</b>	06.96-06.99	110					0 986 473 055		← 34
							0 986 474 055		→ 34
<hr/>									
									
	<b>1.6i</b>	06.96-10.97	66-73				1 987 477 752		→ 1640
							1 987 477 758		← 1620
		06.96-05.99	66-73				1 987 477 982		303
							11.97-05.99	66-73	
							1 987 477 758		← 1620
							1 987 477 758		← 1620
		09.00-01.01	78			TW	1 987 477 231		↔ 1660
							09.00-03.01	78	
							1 987 477 981		← 1642
		04.01-12.01	78			SA,TW	1 987 477 231		↔ 1660
							ABO	06.99-09.00	73
							1 987 477 758		← 1620
ABS		06.99-12.01	73				1 987 477 755		→ 1668
<b>1.8i</b>	06.99-12.01	84					1 987 477 982		303
							10.00-12.01	84	
ABO	06.99-09.00	84					1 987 477 753		→ 1657
ABS	06.99-12.01	84					1 987 477 755		→ 1668
<b>2.0D Turbo</b>	06.96-10.97	66					1 987 477 752		→ 1640
	06.96-12.01	66					1 987 477 982		303
							11.97-04.98	66	
							1 987 477 758		← 1620





Model	Year Range	Power	Code	Price	Price
<b>NISSAN Primera Hatchback [P11E]</b>					
2.0 D Turbo	11.97-04.98	66	TBR	1987 477 752	→ 1640
				1987 477 758	← 1620
	05.98-06.99	66		1987 477 753	→ 1657
				1987 477 758	← 1620
	ABO 07.99-09.00	66		1987 477 753	→ 1657
				1987 477 758	← 1620
	10.00-01.01	66		1987 477 231	↔ 1660
				1987 477 755	→ 1668
	ABS 07.99-03.01	66		1987 477 981	← 1642
				1987 477 231	↔ 1660
04.01-12.01	66		1987 477 231	↔ 1660	
			1987 477 753	→ 1657	
2.0 i	06.96-06.99	85/96		1987 477 753	→ 1657
				1987 477 758	← 1620
	06.99-03.01	103		1987 477 982	303
				1987 477 755	→ 1668
	06.99-12.01	103		1987 477 981	← 1642
1987 477 982				303	
04.01-12.01	103		1987 477 231	↔ 1660	
2.0 i GT	06.96-06.99	110		1987 477 753	→ 1657
				1987 477 758	← 1620
				1987 477 982	303
1.6 i	06.96-08.97	66-73	LAB	0 265 006 237 <sup>4</sup>	
				RAB	0 265 006 236 <sup>4</sup>
	06.96-05.99	66-73		LAB	0 265 006 233 <sup>3</sup>
				RAB	0 265 006 232 <sup>3</sup>
	09.97-04.98	66-73		LAB	0 265 006 379 <sup>4</sup>
				RAB	0 265 006 378 <sup>4</sup>
	05.98-05.99	66-73		LAB	0 265 006 237 <sup>4</sup>
				RAB	0 265 006 236 <sup>4</sup>
	06.99-08.00	73		LAB	0 265 006 237 <sup>4</sup>
				RAB	0 265 006 236 <sup>4</sup>
	06.99-12.01	73		LAB	0 265 006 233 <sup>3</sup>
				RAB	0 265 006 232 <sup>3</sup>
	09.00-09.00	78		LAB,TW	0 265 006 237 <sup>4</sup>
				RAB,TW	0 265 006 236 <sup>4</sup>
	09.00-12.01	73		LAB	0 265 006 708 <sup>4</sup>
				RAB	0 265 006 709 <sup>4</sup>
	78			LAB	0 265 006 233 <sup>3</sup>
				RAB	0 265 006 708 <sup>4</sup>
RAB				0 265 006 232 <sup>3</sup>	
0 265 006 709 <sup>4</sup>			RAB	0 265 006 709 <sup>4</sup>	
			LAB	0 265 006 237 <sup>4</sup>	
			RAB	0 265 006 236 <sup>4</sup>	
1.8 i	06.99-08.00	84		LAB	0 265 006 237 <sup>4</sup>
				RAB	0 265 006 236 <sup>4</sup>
	06.99-12.01	84		LAB	0 265 006 233 <sup>3</sup>
				RAB	0 265 006 232 <sup>3</sup>
09.00-12.01	84		LAB	0 265 006 708 <sup>4</sup>	
			RAB	0 265 006 709 <sup>4</sup>	
2.0 D Turbo	06.96-08.97	66		LAB	0 265 006 237 <sup>4</sup>
				RAB	0 265 006 236 <sup>4</sup>
	06.96-12.01	66		LAB	0 265 006 233 <sup>3</sup>
				RAB	0 265 006 232 <sup>3</sup>
	09.97-04.98	66		LAB	0 265 006 379 <sup>4</sup>
				RAB	0 265 006 378 <sup>4</sup>
	05.98-08.00	66		LAB	0 265 006 237 <sup>4</sup>
				RAB	0 265 006 236 <sup>4</sup>
	09.00-12.01	66		LAB	0 265 006 708 <sup>4</sup>
				RAB	0 265 006 709 <sup>4</sup>
2.0 i	06.96-08.97	85/96		LAB	0 265 006 237 <sup>4</sup>
				RAB	0 265 006 236 <sup>4</sup>
	96			LAB	0 265 006 237 <sup>4</sup>
				RAB	0 265 006 236 <sup>4</sup>
	06.96-10.97	85/96		LAB	0 265 006 237 <sup>4</sup>
				RAB	0 265 006 232 <sup>3</sup>

		S																			
2.0i																					
										06.96-06.99	85/96	LAB	0 265 006 233 <sup>3</sup>								
											96	RAB	0 265 006 232 <sup>3</sup>								
										09.97-10.97	85/96	LAB	0 265 006 379 <sup>4</sup>								
												RAB	0 265 006 378 <sup>4</sup>								
										09.97-04.98	96	LAB	0 265 006 379 <sup>4</sup>								
												RAB	0 265 006 378 <sup>4</sup>								
										05.98-06.99	96	LAB	0 265 006 237 <sup>4</sup>								
												RAB	0 265 006 236 <sup>4</sup>								
										06.99-08.00	103	LAB	0 265 006 237 <sup>4</sup>								
												RAB	0 265 006 236 <sup>4</sup>								
										06.99-12.01	103	LAB	0 265 006 233 <sup>3</sup>								
												RAB	0 265 006 232 <sup>3</sup>								
										09.00-12.01	103	LAB	0 265 006 708 <sup>4</sup>								
		RAB	0 265 006 709 <sup>4</sup>																		
2.0iGT																					
										06.96-08.97	110	LAB	0 265 006 237 <sup>4</sup>								
												RAB	0 265 006 236 <sup>4</sup>								
										06.96-06.99	110	LAB	0 265 006 233 <sup>3</sup>								
												RAB	0 265 006 232 <sup>3</sup>								
										09.97-04.98	110	LAB	0 265 006 379 <sup>4</sup>								
												RAB	0 265 006 378 <sup>4</sup>								
										05.98-06.99	110	LAB	0 265 006 237 <sup>4</sup>								
		RAB	0 265 006 236 <sup>4</sup>																		
<b>Primera Hatchback [P12E]</b>																					
																					
	1.6		05.02-01.07	78-80																	
										0986 473 485	 ← 57										
										0986 474 485	 → 57										
										1.8	05.02-01.07	85									
																				0986 473 485	 ← 57
										1.9D Turbo	01.03-01.07	85-88									
																				0986 473 485	 ← 57
										2.0	05.02-01.07	103									
																				0986 473 485	 ← 57
2.2D Turbo	05.02-01.07	93/100-102																			
										0986 474 485	 → 57										
																					
	1.6		05.02-06.10	78-80																	
										1987 477 226	236										
										1987 482 303	← 2224										
										1987 482 304	→ 1778										
										1.8	05.02-07.10	85									
																				1987 477 226	236
																				1987 482 303	← 2224
										1.9D Turbo	01.03-07.10	85-88									
																				1987 477 226	236
																				1987 482 303	← 2224
										2.0	05.02-07.10	103									
																				1987 477 226	236
																				1987 482 303	← 2224
										2.2D Turbo	05.02-09.10	93/100-102									
																				1987 482 304	→ 1778
1987 477 226	236																				
	1.6		05.02-09.02	78-80																	
										LAB	0 265 007 465 <sup>4</sup>										
										RAB	0 265 007 466 <sup>4</sup>										
										05.02-06.10	78-80										
																			LAB	0 265 007 463 <sup>3</sup>	
										10.02-06.10	78-80										
																				LAB	0 265 007 632 <sup>4</sup>
1.8	05.02-09.02	85																			
										LAB	0 265 007 465 <sup>4</sup>										



		S								
<b>NISSAN Primera Hatchback [P12E]</b>										
1.8		05.02-07.10	85				LAB	0 265 007 463 <sup>3</sup>		
							RAB	0 265 007 464 <sup>3</sup>		
		10.02-07.10	85				LAB	0 265 007 632 <sup>4</sup>		
							RAB	0 265 007 633 <sup>4</sup>		
1.9 D Turbo		01.03-07.10	85-88				LAB	0 265 007 463 <sup>3</sup>		
								0 265 007 632 <sup>4</sup>		
							RAB	0 265 007 464 <sup>3</sup>		
								0 265 007 633 <sup>4</sup>		
								0 265 007 465 <sup>4</sup>		
							RAB	0 265 007 466 <sup>4</sup>		
2.0		05.02-09.02	103				LAB	0 265 007 465 <sup>4</sup>		
							RAB	0 265 007 466 <sup>4</sup>		
		05.02-07.10	103				LAB	0 265 007 463 <sup>3</sup>		
							RAB	0 265 007 464 <sup>3</sup>		
10.02-07.10	103	LAB	0 265 007 632 <sup>4</sup>							
		RAB	0 265 007 633 <sup>4</sup>							
2.2 D Turbo		05.02-09.02	93				LAB	0 265 007 465 <sup>4</sup>		
							RAB	0 265 007 466 <sup>4</sup>		
		05.02-08.10	93				LAB	0 265 007 463 <sup>3</sup>		
							RAB	0 265 007 464 <sup>3</sup>		
		10.02-08.10	93				LAB	0 265 007 632 <sup>4</sup>		
							RAB	0 265 007 633 <sup>4</sup>		
01.03-09.10	100-102	LAB	0 265 007 463 <sup>3</sup>							
		RAB	0 265 007 464 <sup>3</sup>							
							0 265 007 633 <sup>4</sup>			
<b>Primera [P11E]</b>										
	1.6 i	ABO	09.98-12.00	81				0 986 473 054	← 57,2	
								0 986 474 054	→ 57,2	
	2.0 i		01.01→	103		TW			F 026 A03 543 <sup>7</sup>	
								0 986 473 054	← 57,2	F 026 A03 543 <sup>7</sup>
								0 986 474 054	→ 57,2	F 026 A03 543 <sup>7</sup>
<b>Primera [P12E]</b>										
	1.6		12.01-01.07	78-80				0 986 473 485	← 57	
								0 986 474 485	→ 57	
	1.8		12.01-01.07	85				0 986 473 485	← 57	
								0 986 474 485	→ 57	
	1.9 D Turbo		01.03-01.07	85-88				0 986 473 485	← 57	
								0 986 474 485	→ 57	
	2.0		12.01-01.07	103				0 986 473 485	← 57	
								0 986 474 485	→ 57	
	2.2 D Turbo		12.01-01.07	93/100-102				0 986 473 485	← 57	
								0 986 474 485	→ 57	
	1.6		12.01-06.10	78-80				1 987 477 226	236	
								1 987 482 303	← 2224	
								1 987 482 304	→ 1778	
	1.8		12.01-06.10	85				1 987 477 226	236	
								1 987 482 303	← 2224	
								1 987 482 304	→ 1778	
	1.9 D Turbo		01.03-07.10	85-88				1 987 477 226	236	
								1 987 482 303	← 2224	
								1 987 482 304	→ 1778	
	2.0		12.01-07.10	103				1 987 477 226	236	
								1 987 482 303	← 2224	
								1 987 482 304	→ 1778	

	S							
2.2D Turbo	12.01-09.10	93/100-102				1 987 477 226	236	
						1 987 482 303	← 2224	
						1 987 482 304	→ 1778	
1.6	12.01-09.02	78-80			LAB	0 265 007 465 <sup>4</sup>		
					RAB	0 265 007 466 <sup>4</sup>		
	12.01-06.10	78-80			LAB	0 265 007 463 <sup>3</sup>		
					RAB	0 265 007 464 <sup>3</sup>		
	10.02-06.10	78-80			LAB	0 265 007 632 <sup>4</sup>		
					RAB	0 265 007 633 <sup>4</sup>		
1.8	12.01-09.02	85			LAB	0 265 007 465 <sup>4</sup>		
					RAB	0 265 007 466 <sup>4</sup>		
	12.01-06.10	85			LAB	0 265 007 463 <sup>3</sup>		
					RAB	0 265 007 464 <sup>3</sup>		
	10.02-06.10	85			LAB	0 265 007 632 <sup>4</sup>		
					RAB	0 265 007 633 <sup>4</sup>		
1.9D Turbo	01.03-07.10	85-88			LAB	0 265 007 463 <sup>3</sup>		
						0 265 007 632 <sup>4</sup>		
					RAB	0 265 007 464 <sup>3</sup>		
						0 265 007 633 <sup>4</sup>		
2.0	12.01-09.02	103			LAB	0 265 007 465 <sup>4</sup>		
					RAB	0 265 007 466 <sup>4</sup>		
	12.01-07.10	103			LAB	0 265 007 463 <sup>3</sup>		
					RAB	0 265 007 464 <sup>3</sup>		
	10.02-07.10	103			LAB	0 265 007 632 <sup>4</sup>		
					RAB	0 265 007 633 <sup>4</sup>		
2.2D Turbo	12.01-09.02	93			LAB	0 265 007 465 <sup>4</sup>		
					RAB	0 265 007 466 <sup>4</sup>		
	12.01-08.10	93			LAB	0 265 007 463 <sup>3</sup>		
					RAB	0 265 007 464 <sup>3</sup>		
	10.02-08.10	93			LAB	0 265 007 632 <sup>4</sup>		
					RAB	0 265 007 633 <sup>4</sup>		
	01.03-09.10	100-102			LAB	0 265 007 463 <sup>3</sup>		
						0 265 007 632 <sup>4</sup>		
					RAB	0 265 007 464 <sup>3</sup>		
						0 265 007 633 <sup>4</sup>		
<b>Primera Sedan [P10E]</b>								
2.0D	01.91-06.96	55				0 204 102 370	← 54	0 204 104 154 <sup>7</sup>
						0 204 103 370		
						0 204 102 745	→ 54	0 204 104 154 <sup>7</sup>
						0 204 103 745		
2.0i	06.90-06.96	110				0 986 473 136	← 57,1	
2.0i 4WD						0 986 474 136	→ 57,1	
1.6i	05.93-09.94	71-75				F 026 002 220	← 20,6	
						F 026 002 221	→ 20,6	
	10.94-06.96	71-75				F 026 002 462	→ 20,6	
						F 026 002 464	← 20,6	
2.0i	06.90-06.96	110				0 986 473 243	← 34	
						0 986 474 243	→ 34	
2.0i 4WD	04.91-06.96	110				0 986 473 050	← 34	
						0 986 474 050	→ 34	
2.0D	01.91-06.96	55				1 987 477 399	→ 1603	
						1 987 477 405	← 1623	







◀ NISSAN Primera Sedan [P10E]

2.0i	06.90-06.96	110		1987 477 754	→ 1491
				1987 477 759	← 1516
2.0i	06.90-06.96	110	LAB	0 265 001 274 <sup>3</sup>	
			RAB	0 265 001 276 <sup>4</sup>	
	09.94-06.96	85-92	LAB	0 265 001 275 <sup>4</sup>	
			LAB	0 265 001 274 <sup>3</sup>	
			RAB	0 265 001 276 <sup>4</sup>	
			RAB	0 265 001 273 <sup>3</sup>	
2.0i4WD	04.91-09.94	110	LAB	0 265 001 313 <sup>3</sup>	
			RAB	0 265 001 312 <sup>3</sup>	
	09.94-06.96	110	LAB	0 265 001 276 <sup>4</sup>	
			LAB	0 265 001 274 <sup>3</sup>	
10.94-06.96	110	LAB	0 265 001 273 <sup>3</sup>		
		RAB	0 265 001 275 <sup>4</sup>		

**Primera Sedan [P11E]**

1.6i	06.96-04.98	66-73		0 986 473 054	☞ ← 57,2
				0 986 474 054	☞ → 57,2
1.6i	04.98-05.99	66-73	NOR	0 986 473 054	☞ ← 57,2
			SA	0 986 474 054	☞ → 57,2
			NOR	0 986 473 054	☞ ← 57,2
			SA	0 986 474 054	☞ → 57,2
1.6i	06.99-12.99	73	NOR	0 986 473 054	☞ ← 57,2
			SA	0 986 474 054	☞ → 57,2
1.6i	06.99-12.01	73	SA	0 986 473 054	☞ ← 57,2
			SA	0 986 474 054	☞ → 57,2
1.6i	09.00-12.01	78	SA	0 986 473 054	☞ ← 57,2
			SA	0 986 474 054	☞ → 57,2
1.8i	06.99-12.99	84	NOR	0 986 473 054	☞ ← 57,2
			SA	0 986 474 054	☞ → 57,2
1.8i	06.99-12.01	84	SA	0 986 473 054	☞ ← 57,2
			SA	0 986 474 054	☞ → 57,2
2.0D Turbo	06.96-04.98	66		0 986 473 054	☞ ← 57,2
				0 986 474 054	☞ → 57,2
2.0D Turbo	04.98-06.99	66	TSE	0 986 473 054	☞ ← 57,2
			TSE	0 986 474 054	☞ → 57,2
2.0D Turbo	04.98-12.99	66	NOR	0 986 473 054	☞ ← 57,2
			NOR	0 986 474 054	☞ → 57,2
2.0D Turbo	04.98-12.01	66	SA	0 986 473 054	☞ ← 57,2
			SA	0 986 474 054	☞ → 57,2
2.0i	06.96-10.97	85		0 986 473 054	☞ ← 57,2
				0 986 474 054	☞ → 57,2
2.0i	06.96-04.98	96		0 986 473 054	☞ ← 57,2
				0 986 474 054	☞ → 57,2
2.0i	04.98-06.99	96	TSE	0 986 473 054	☞ ← 57,2
			TSE	0 986 474 054	☞ → 57,2
2.0i	06.99-12.01	103	AG	0 986 473 054	☞ ← 57,2
			AG	0 986 474 054	☞ → 57,2
2.0i	04.98-06.99	96	ABO	0 986 473 054	☞ ← 57,2
			ABO	0 986 474 054	☞ → 57,2
2.0i	04.98-06.99	96	ABS	0 986 473 054	☞ ← 57,2
			ABS	0 986 474 054	☞ → 57,2
2.0iGT	06.96-06.99	110		0 986 473 054	☞ ← 57,2
				0 986 474 054	☞ → 57,2



	<b>1.6 i</b>	06.96-05.99	66-73		F 026 <b>002 006</b>	↔ 20,6
		01.01-12.01	73/78		0 986 <b>475 938</b>	↔ 17,46
	<b>1.8 i</b>	01.01-12.01	84		0 986 <b>475 938</b>	↔ 17,46
		<b>2.0 D Turbo</b>	06.96-12.01	66		F 026 <b>002 006</b>
		01.01-12.01	66		0 986 <b>475 938</b>	↔ 17,46

	<b>1.6 i</b>	10.97-05.99	66-73		0 986 <b>473 055</b>	☞ ← 34
					0 986 <b>474 055</b>	☞ → 34
		06.99-01.01	73/78	NOR	0 986 <b>473 055</b>	☞ ← 34
					0 986 <b>474 055</b>	☞ → 34
		06.99-03.01	73/78	SA	0 986 <b>473 055</b>	☞ ← 34
				0 986 <b>474 055</b>	☞ → 34	
	<b>1.8 i</b>	06.99-01.01	84	NOR	0 986 <b>473 055</b>	☞ ← 34
					0 986 <b>474 055</b>	☞ → 34
		06.99-03.01	84	SA	0 986 <b>473 055</b>	☞ ← 34
					0 986 <b>474 055</b>	☞ → 34
	<b>2.0 D Turbo</b>	10.97-04.98	66		0 986 <b>473 055</b>	☞ ← 34
					0 986 <b>474 055</b>	☞ → 34
		04.98-06.99	66	TSE	0 986 <b>473 055</b>	☞ ← 34
					0 986 <b>474 055</b>	☞ → 34
		06.99-01.01	66	NOR	0 986 <b>473 055</b>	☞ ← 34
					0 986 <b>474 055</b>	☞ → 34
		06.99-03.01	66	SA	0 986 <b>473 055</b>	☞ ← 34
					0 986 <b>474 055</b>	☞ → 34
		ABO 04.98-06.99	66	GXA,SLX	0 986 <b>473 055</b>	☞ ← 34
					0 986 <b>474 055</b>	☞ → 34
		ABS 04.98-06.99	66	GXA,SLX	0 986 <b>473 055</b>	☞ ← 34
					0 986 <b>474 055</b>	☞ → 34
	<b>2.0 i</b>	06.96-10.97	85		0 986 <b>473 055</b>	☞ ← 34
					0 986 <b>474 055</b>	☞ → 34
06.96-04.98		96		0 986 <b>473 055</b>	☞ ← 34	
				0 986 <b>474 055</b>	☞ → 34	
06.99-03.01		103		0 986 <b>473 055</b>	☞ ← 34	
				0 986 <b>474 055</b>	☞ → 34	
ABO 04.98-06.99		96		0 986 <b>473 055</b>	☞ ← 34	
				0 986 <b>474 055</b>	☞ → 34	
<b>2.0 i GT</b>	06.96-06.99	110		0 986 <b>473 055</b>	☞ ← 34	
				0 986 <b>474 055</b>	☞ → 34	







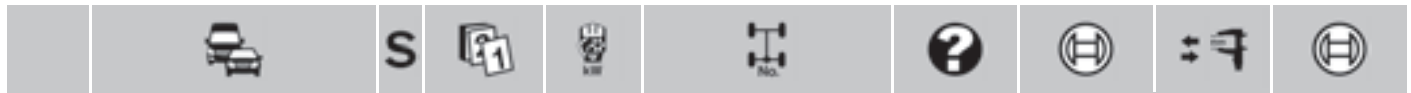



	<b>1.6 i</b>	06.96-10.97	66-73		1 987 <b>477 752</b>	→ 1640	
					1 987 <b>477 758</b>	← 1620	
		06.96-05.99	66-73		1 987 <b>477 982</b>	303	
		11.97-05.99	66-73		SBR	1 987 <b>477 753</b>	→ 1657
						1 987 <b>477 758</b>	← 1620
						1 987 <b>477 752</b>	→ 1640
						1 987 <b>477 758</b>	← 1620
		06.99-12.01	73			1 987 <b>477 982</b>	303
						09.00-01.01	78
		09.00-03.01	78		SA,TW	1 987 <b>477 755</b>	→ 1668
						1 987 <b>477 981</b>	← 1642
		09.00-12.01	78			1 987 <b>477 982</b>	303
		04.01-12.01	78		SA,TW	1 987 <b>477 231</b>	↔ 1660
		ABO 06.99-09.00	73			1 987 <b>477 753</b>	→ 1657
						1 987 <b>477 758</b>	← 1620
		10.00-12.01	73			1 987 <b>477 231</b>	↔ 1660
		ABS 06.99-12.01	73			1 987 <b>477 755</b>	→ 1668
						1 987 <b>477 981</b>	← 1642

















Model	Year Range	Power	Options	Part No.	Quantity	
<b>NISSAN Primera Sedan [P11E]</b>						
1.8 i	06.99-12.01	84		1987 477 982	303	
	10.00-12.01	84	SA,TW	1987 477 231	↔ 1660	
	ABO 06.99-09.00	84		1987 477 753	→ 1657	
				1987 477 758	← 1620	
	ABS 06.99-12.01	84		1987 477 755	→ 1668	
				1987 477 981	← 1642	
	2.0 D Turbo	06.96-10.97	66		1987 477 752	→ 1640
					1987 477 758	← 1620
		06.96-12.01	66		1987 477 982	303
		11.97-04.98	66	SBR	1987 477 753	→ 1657
				1987 477 758	← 1620	
			TBR	1987 477 752	→ 1640	
				1987 477 758	← 1620	
05.98-06.99		66		1987 477 753	→ 1657	
				1987 477 758	← 1620	
ABO 07.99-09.00		66		1987 477 753	→ 1657	
				1987 477 758	← 1620	
10.00-01.01		66		1987 477 231	↔ 1660	
ABS 07.99-03.01	66		1987 477 755	→ 1668		
			1987 477 981	← 1642		
04.01-12.01	66		1987 477 231	↔ 1660		
2.0 i	06.96-06.99	85/96		1987 477 753	→ 1657	
				1987 477 758	← 1620	
				1987 477 982	303	
	06.99-03.01	103		1987 477 755	→ 1668	
				1987 477 981	← 1642	
	06.99-12.01	103		1987 477 982	303	
04.01-12.01	103		1987 477 231	↔ 1660		
2.0 i GT	06.96-06.99	110		1987 477 753	→ 1657	
				1987 477 758	← 1620	
				1987 477 982	303	
1.6 i	06.96-08.97	66-73	LAB	0 265 006 237 <sup>4</sup>		
			RAB	0 265 006 236 <sup>4</sup>		
	06.96-05.99	66-73	LAB	0 265 006 233 <sup>3</sup>		
			RAB	0 265 006 232 <sup>3</sup>		
	09.97-04.98	66-73	LAB	0 265 006 379 <sup>4</sup>		
			RAB	0 265 006 378 <sup>4</sup>		
	05.98-05.99	66-73	LAB	0 265 006 237 <sup>4</sup>		
			RAB	0 265 006 236 <sup>4</sup>		
	06.99-08.00	73	LAB	0 265 006 237 <sup>4</sup>		
			RAB	0 265 006 236 <sup>4</sup>		
	06.99-12.01	73	LAB	0 265 006 233 <sup>3</sup>		
			RAB	0 265 006 232 <sup>3</sup>		
	09.00-09.00	78	LAB,TW	0 265 006 237 <sup>4</sup>		
			RAB,TW	0 265 006 236 <sup>4</sup>		
	09.00-12.01	73	LAB	0 265 006 708 <sup>4</sup>		
			RAB	0 265 006 709 <sup>4</sup>		
	78		LAB	0 265 006 233 <sup>3</sup>		
				0 265 006 708 <sup>4</sup>		
			RAB	0 265 006 232 <sup>3</sup>		
				0 265 006 709 <sup>4</sup>		
1.8 i	06.99-08.00	84	LAB	0 265 006 237 <sup>4</sup>		
			RAB	0 265 006 236 <sup>4</sup>		
	06.99-12.01	84	LAB	0 265 006 233 <sup>3</sup>		
			RAB	0 265 006 232 <sup>3</sup>		
09.00-12.01	84	LAB	0 265 006 708 <sup>4</sup>			
		RAB	0 265 006 709 <sup>4</sup>			
2.0 D Turbo	06.96-08.97	66	LAB	0 265 006 237 <sup>4</sup>		
			RAB	0 265 006 236 <sup>4</sup>		
	06.96-12.01	66	LAB	0 265 006 233 <sup>3</sup>		
			RAB	0 265 006 232 <sup>3</sup>		

		S								
<b>2.0D Turbo</b>	09.97-04.98	66					LAB	0 265 006 379 <sup>4</sup>		
							RAB	0 265 006 378 <sup>4</sup>		
	05.98-08.00	66						LAB	0 265 006 237 <sup>4</sup>	
								RAB	0 265 006 236 <sup>4</sup>	
09.00-12.01	66						LAB	0 265 006 708 <sup>4</sup>		
							RAB	0 265 006 709 <sup>4</sup>		
<b>2.0i</b>	06.96-08.97	85/96					LAB	0 265 006 237 <sup>4</sup>		
							RAB	0 265 006 236 <sup>4</sup>		
							LAB	0 265 006 237 <sup>4</sup>		
							RAB	0 265 006 236 <sup>4</sup>		
	06.96-10.97	85/96						RAB	0 265 006 232 <sup>3</sup>	
	06.96-06.99	85/96						LAB	0 265 006 233 <sup>3</sup>	
								RAB	0 265 006 232 <sup>3</sup>	
	09.97-10.97	85/96						LAB	0 265 006 379 <sup>4</sup>	
								RAB	0 265 006 378 <sup>4</sup>	
	09.97-04.98	96						LAB	0 265 006 379 <sup>4</sup>	
								RAB	0 265 006 378 <sup>4</sup>	
	05.98-06.99	96						LAB	0 265 006 237 <sup>4</sup>	
								RAB	0 265 006 236 <sup>4</sup>	
06.99-08.00	103						LAB	0 265 006 237 <sup>4</sup>		
							RAB	0 265 006 236 <sup>4</sup>		
06.99-12.01	103						LAB	0 265 006 233 <sup>3</sup>		
							RAB	0 265 006 232 <sup>3</sup>		
09.00-12.01	103						LAB	0 265 006 708 <sup>4</sup>		
							RAB	0 265 006 709 <sup>4</sup>		
<b>2.0i GT</b>	06.96-08.97	110					LAB	0 265 006 237 <sup>4</sup>		
							RAB	0 265 006 236 <sup>4</sup>		
	06.96-06.99	110						LAB	0 265 006 233 <sup>3</sup>	
								RAB	0 265 006 232 <sup>3</sup>	
	09.97-04.98	110						LAB	0 265 006 379 <sup>4</sup>	
RAB								0 265 006 378 <sup>4</sup>		
05.98-06.99	110						LAB	0 265 006 237 <sup>4</sup>		
							RAB	0 265 006 236 <sup>4</sup>		

**Primera Wagon [P12E]**

									
	<b>1.6</b>	12.01-01.07	80				0 986 473 485	 ← 57	
							0 986 474 485	 → 57	
	<b>1.8</b>	12.01-01.07	85				0 986 473 485	 ← 57	
							0 986 474 485	 → 57	
	<b>1.9D Turbo</b>	01.03-01.07	85-88				0 986 473 485	 ← 57	
							0 986 474 485	 → 57	
	<b>2.0</b>	12.01-01.07	103				0 986 473 485	 ← 57	
							0 986 474 485	 → 57	
	<b>2.2D Turbo</b>	12.01-01.07	93/100-102				0 986 473 485	 ← 57	
							0 986 474 485	 → 57	
	<b>1.6</b>	12.01-06.10	80				1 987 477 226	236	
							1 987 482 303	← 2224	
							1 987 482 304	→ 1778	
	<b>1.8</b>	12.01-06.10	85					1 987 477 226	236
								1 987 482 303	← 2224
								1 987 482 304	→ 1778
	<b>1.9D Turbo</b>	01.03-07.10	85-88					1 987 477 226	236
								1 987 482 303	← 2224
								1 987 482 304	→ 1778
	<b>2.0</b>	12.01-07.10	103					1 987 477 226	236
								1 987 482 303	← 2224
								1 987 482 304	→ 1778



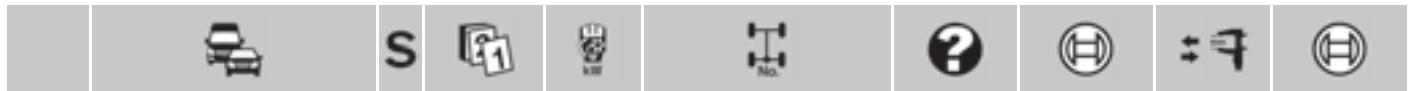

◀ NISSAN Primera Wagon [P12E]								
2.2 D Turbo	12.01-09.10	93/100-102				1987 477 226	236	
						1987 482 303	← 2224	
						1987 482 304	→ 1778	
1.6	12.01-09.02	80		LAB		0 265 007 465 <sup>4</sup>		
						RAB	0 265 007 466 <sup>4</sup>	
	12.01-06.10	80			LAB		0 265 007 463 <sup>3</sup>	
							RAB	0 265 007 464 <sup>3</sup>
	10.02-06.10	80			LAB		0 265 007 632 <sup>4</sup>	
							RAB	0 265 007 633 <sup>4</sup>
1.8	12.01-09.02	85		LAB		0 265 007 465 <sup>4</sup>		
						RAB	0 265 007 466 <sup>4</sup>	
	12.01-06.10	85			LAB		0 265 007 463 <sup>3</sup>	
RAB							0 265 007 464 <sup>3</sup>	
10.02-06.10	85			LAB		0 265 007 632 <sup>4</sup>		
						RAB	0 265 007 633 <sup>4</sup>	
						RAB	0 265 007 633 <sup>4</sup>	
1.9 D Turbo	01.03-07.10	85-88		LAB		0 265 007 463 <sup>3</sup>		
						RAB	0 265 007 464 <sup>3</sup>	
						RAB	0 265 007 633 <sup>4</sup>	
2.0	12.01-09.02	103		LAB		0 265 007 465 <sup>4</sup>		
						RAB	0 265 007 466 <sup>4</sup>	
	12.01-07.10	103			LAB		0 265 007 463 <sup>3</sup>	
							RAB	0 265 007 464 <sup>3</sup>
	10.02-07.10	103			LAB		0 265 007 632 <sup>4</sup>	
							RAB	0 265 007 633 <sup>4</sup>
2.2 D Turbo	12.01-09.02	93		LAB		0 265 007 465 <sup>4</sup>		
						RAB	0 265 007 466 <sup>4</sup>	
	12.01-08.10	93			LAB		0 265 007 463 <sup>3</sup>	
							RAB	0 265 007 464 <sup>3</sup>
	10.02-08.10	93			LAB		0 265 007 632 <sup>4</sup>	
							RAB	0 265 007 633 <sup>4</sup>
01.03-09.10	100-102			LAB		0 265 007 463 <sup>3</sup>		
						RAB	0 265 007 464 <sup>3</sup>	
						0 265 007 633 <sup>4</sup>		

**Primera Wagon [WP11E]**

1.6 i	01.98-03.01	66/73				0986 473 055	👁️ ← 34
						0986 474 055	👁️ → 34
1.8 i	06.99-03.01	84				0986 473 055	👁️ ← 34
						0986 474 055	👁️ → 34
2.0 D Turbo	01.98-03.01	66/85/96/				0986 473 055	👁️ ← 34
						0986 474 055	👁️ → 34
2.0 i		103				0986 474 055	👁️ → 34

1.6 i	01.98-12.01	66/73				1987 477 755	→ 1668	
						1987 477 981	← 1642	
1.8 i	06.99-03.01	84				1987 477 755	→ 1668	
						1987 477 981	← 1642	
	04.01-12.01	84				1987 477 231	↔ 1660	
2.0 D Turbo	01.98-03.01	66				1987 477 755	→ 1668	
						1987 477 981	← 1642	
	04.01-12.01	66				1987 477 231	↔ 1660	
2.0 i	01.98-06.99	85/96				1987 477 755	→ 1668	
						1987 477 981	← 1642	
	06.99-03.01	103					1987 477 755	→ 1668
							1987 477 981	← 1642
04.01-12.01	103					1987 477 231	↔ 1660	

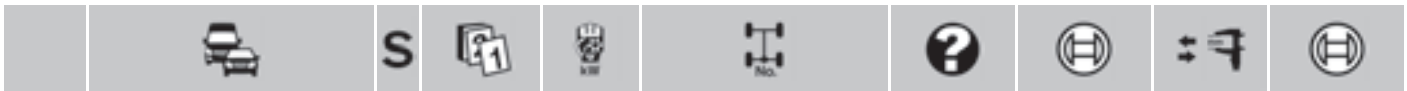

	1.6 i	01.98-06.99	66	LAB	0 265 006 233 <sup>3</sup>		
				RAB	0 265 006 237 <sup>4</sup>		
			73	LAB	0 265 006 232 <sup>3</sup>		
				RAB	0 265 006 236 <sup>4</sup>		
		01.98-12.01	73	LAB	0 265 006 237 <sup>4</sup>		
				RAB	0 265 006 232 <sup>3</sup>		
		06.99-12.01	73	LAB	0 265 006 233 <sup>3</sup>		
				RAB	0 265 006 379 <sup>4</sup>		
	1.8 i	06.99-12.01	84	LAB	0 265 006 378 <sup>4</sup>		
				RAB	0 265 006 233 <sup>3</sup>		
					0 265 006 379 <sup>4</sup>		
					0 265 006 378 <sup>4</sup>		
	2.0D Turbo	01.98-06.99	66	LAB	0 265 006 237 <sup>4</sup>		
				RAB	0 265 006 236 <sup>4</sup>		
		01.98-12.01	66	LAB	0 265 006 233 <sup>3</sup>		
				RAB	0 265 006 232 <sup>3</sup>		
		07.99-12.01	66	LAB	0 265 006 379 <sup>4</sup>		
				RAB	0 265 006 378 <sup>4</sup>		
	2.0 i	01.98-06.99	85/96	LAB	0 265 006 233 <sup>3</sup>		
				RAB	0 265 006 237 <sup>4</sup>		
					0 265 006 232 <sup>3</sup>		
					0 265 006 236 <sup>4</sup>		
		06.99-12.01	103	LAB	0 265 006 233 <sup>3</sup>		
				RAB	0 265 006 379 <sup>4</sup>		
					0 265 006 232 <sup>3</sup>		
					0 265 006 378 <sup>4</sup>		

**Primera Wagon [W10]**

	1.6 i	04.93-12.97	66-75		0 986 475 558	↔ 20,63	
	2.0D	07.90-04.96	55		0 986 475 558	↔ 20,63	
	2.0 i	07.90-07.94	85/89		0 986 473 383	↺ 38,1	
					0 986 474 383	↻ 38,1	
	1.6 i	04.93-12.97	66-75	LAB	F 01G 09F 01C <sup>4</sup>		
				RAB	F 01G 09F 04G <sup>3</sup>		
					F 01G 09F 01D <sup>4</sup>		
					F 01G 09F 05C <sup>3</sup>		
	2.0D	04.93-04.96	55	LAB	F 01G 09F 01C <sup>4</sup>		
				RAB	F 01G 09F 04G <sup>3</sup>		
					F 01G 09F 01D <sup>4</sup>		
					F 01G 09F 05C <sup>3</sup>		
	2.0 i	07.90-07.94	85	LAB	F 01G 09F 01C <sup>4</sup>		
				RAB	F 01G 09F 04G <sup>3</sup>		
					0 265 001 274 <sup>3</sup>		
					0 265 001 276 <sup>4</sup>		
				RAB	F 01G 09F 01D <sup>4</sup>		
					F 01G 09F 05C <sup>3</sup>		
					0 265 001 273 <sup>3</sup>		
					0 265 001 275 <sup>4</sup>		
			89	LAB	F 01G 09F 01C <sup>4</sup>		
					F 01G 09F 04G <sup>3</sup>		
					0 265 001 274 <sup>3</sup>		
					0 265 001 276 <sup>4</sup>		



		S							
<b>NISSAN Primera Wagon [W10]</b>									
		2.0i	07.90-07.94	89		RAB	F 01G 09F 01D <sup>4</sup>		
							F 01G 09F 05C <sup>3</sup>		
							0 265 001 273 <sup>3</sup>		
							0 265 001 275 <sup>4</sup>		
			07.94-12.97	85-92		LAB	F 01G 09F 01C <sup>4</sup>		
							F 01G 09F 04G <sup>3</sup>		
						RAB	F 01G 09F 01D <sup>4</sup>		
							F 01G 09F 05C <sup>3</sup>		
<b>Pulsar</b>									
		1.5i	08.95-10.99	77			0 986 473 051	← 54	F 026 A03 540 <sup>7</sup>
		1.5i 4WD					0 986 474 051	→ 54	F 026 A03 540 <sup>7</sup>
		1.5i 4WD	01.95-10.99	77		TW	0 986 475 670	↔ 15,8	
		1.5i	01.95-08.00	77		TW	1 987 477 535	→ 1662	
		1.5i 4WD					1 987 477 537	← 1660	
			08.95-02.98	77		TW	1 987 477 536	→ 1677	
							1 987 477 538	← 1676	
			08.95-10.99	77			1 987 477 534	250	
<b>Pulsar [C13]</b>									
		1.2 DIG-T	07.14→	85		AG			F 026 A03 539 <sup>7</sup>
						GS			F 026 A03 539 <sup>7</sup>
		1.5 dCi	07.14→	81					F 026 A03 539 <sup>7</sup>
<b>Pulsar Hatchback [N14]</b>									
		2.0i	08.91-05.95	105			0 986 473 264	← 54	F 026 A03 468 <sup>7</sup>
							0 986 474 264	→ 54	F 026 A03 468 <sup>7</sup>
		2.0i	08.91-05.95	105			0 986 473 091	← 30,1	F 026 A08 107 <sup>7</sup>
							0 986 474 091	→ 30,1	F 026 A08 107 <sup>7</sup>
		2.0i	08.91-05.95	105			1 987 477 398	→ 1311	
							1 987 477 404	← 1311	
		2.0i	08.91-05.95	105		LAB	F 01G 09F 016 <sup>4</sup>		
							F 01G 09F 04Z <sup>3</sup>		
						RAB	F 01G 09F 017 <sup>4</sup>		
							F 01G 09F 050 <sup>3</sup>		
<b>Pulsar Hatchback [N15]</b>									
		1.6	08.95-06.00	86			0 986 473 051	← 54	F 026 A03 469 <sup>7</sup>
							0 986 474 051	→ 54	F 026 A03 469 <sup>7</sup>
		2.0i	08.95-06.97	105					F 026 A03 504 <sup>7</sup>



		S							
	1.6	08.95-06.00	86				0 986 475 670	↔ 15,8	
	1.6	08.95-06.00	86				0 986 473 092	↔ 30,15	
	2.0i	08.95-06.00	105				0 986 473 093	↔ 33,9	
							0 986 474 093	↔ 33,9	
	1.6	ABO 08.95-06.00	86				1 987 477 535	→ 1662	
							1 987 477 537	← 1660	
<b>Pulsar [N14]</b>									
	1.6 1.6 i	08.91-05.95	86						F 026 A08 104 <sup>7</sup>
	1.6 1.6 i	08.91-05.95	86				0 986 475 670	↔ 15,8	
	1.6 1.6 i	08.91-05.95	86				0 986 473 091	↔ 30,1	F 026 A08 107 <sup>7</sup>
							0 986 474 091	↔ 30,1	F 026 A08 107 <sup>7</sup>
	1.6 1.6 i	08.91-05.95	86		STB		1 987 477 397	→ 1412	
							1 987 477 403	← 1412	
					4SB		1 987 477 398	→ 1311	
							1 987 477 404	← 1311	
<b>Pulsar [N16]</b>									
	1.3	12.99-07.09	65		TW				F 026 A03 540 <sup>7</sup>
	1.3	12.99-07.09	65		TW		0 986 AB8 153	↔ 15,88	
							0 986 475 938	↔ 17,46	
	1.3	12.99-09.00	65		LAB		F 01G 09F OGA <sup>3</sup>		
					RAB		F 01G 09F OGB <sup>3</sup>		
		10.00-07.09	65		LAB		F 01G 09F OH6 <sup>3</sup>		
					RAB		F 01G 09F OP4 <sup>3</sup>		
<b>Pulsar Sedan [N15]</b>									
	1.6	08.95-06.00	81-86				0 986 473 051	↔ 54	F 026 A03 469 <sup>7</sup>
							0 986 474 051	↔ 54	F 026 A03 469 <sup>7</sup>





		S							
◀ NISSAN Pulsar Sedan [N15]									
	1.6	08.95-06.00	81-86				0986 475 670	↔ 15,8	
	1.6	08.95-06.00	81-86				0986 473 092	↔ 30,15	
							0986 474 092	↔ 30,15	
	1.6	ABO 08.95-06.00	81-86				1987 477 535	→ 1662	
							1987 477 537	← 1660	
Qashqai [J10]									
	1.5 dCi	12.06→	76-78/81				0986 134 299	↔ 60	
							0986 135 299	↔ 60	
	1.6, dCi, dCi 4x4	12.06→	84-89/96				0986 134 299	↔ 60	
							0986 135 299	↔ 60	
	2.0, dCi, dCi 4x4, 4x4	12.06→	103-106/ 110				0986 134 299	↔ 60	
							0986 135 299	↔ 60	
	1.5 dCi	12.06-06.10	76-78/81				0986 134 251	↔	
							0986 135 251	↔	
	1.6	12.06-06.10	84-89				0986 134 251	↔	
							0986 135 251	↔	
	2.0, dCi, dCi 4x4, 4x4	12.06-06.10	103-106/ 110				0986 134 251	↔	
							0986 135 251	↔	
	1.5 dCi	12.06→	76-78/81				1987 482 337	262	
							1987 482 338	← 1703	
							1987 482 339	→ 1705	
	1.6	12.06→	84-89/96				1987 482 337	262	
	1.6 dCi						1987 482 338	← 1703	
	1.6 dCi 4x4						1987 482 339	→ 1705	
	2.0, dCi, dCi 4x4, 4x4	12.06→	103-106/ 110				1987 482 337	262	
							1987 482 338	← 1703	
							1987 482 339	→ 1705	
	1.5 dCi	12.06-08.10	76-78/81				0265 007 908 <sup>4</sup>		
		12.06→	76-78/81				0265 007 905 <sup>3</sup>		
		09.10→	76-78/81				0265 008 620 <sup>4</sup>		
	1.6	12.06-08.10	84-89				0265 007 908 <sup>4</sup>		
		12.06→	84-89				0265 007 905 <sup>3</sup>		
		09.10→	84-89				0265 008 620 <sup>4</sup>		
	1.6, dCi	11.10→	86/96				0265 008 620 <sup>4</sup>		
	1.6, dCi, dCi 4x4	11.10→	86/96				0265 007 905 <sup>3</sup>		
	2.0	12.06-08.10	103-106				0265 007 908 <sup>4</sup>		
		12.06→	103-106				0265 007 905 <sup>3</sup>		
		09.10→	103-106				0265 008 620 <sup>4</sup>		
	2.0 dCi	04.07-08.10	110				0265 007 908 <sup>4</sup>		
		09.10→	110				0265 008 620 <sup>4</sup>		
	2.0 dCi, dCi 4x4	04.07→	110				0265 007 905 <sup>3</sup>		
	2.0 dCi 4x4	04.07-08.10	110				0265 007 909 <sup>4</sup>		
	2.0 4x4	12.06-08.10	103-104				0265 007 909 <sup>4</sup>		
		12.06→	103-104				0265 007 905 <sup>3</sup>		



		S				?			
<b>Qashqai+2 [JJ10]</b>									
	1.5 dCi	08.08→	78/81				0 986 134 299		← 60
							0 986 135 299		→ 60
	1.6	08.08→	84/86				0 986 134 299		← 60
							0 986 135 299		→ 60
	2.0	08.08→	104				0 986 134 299		← 60
							0 986 135 299		→ 60
	2.0 4x4	01.12→	104				0 986 134 299		← 60
							0 986 135 299		→ 60
	1.5 dCi	08.08→	78/81				1 987 482 337		262
							1 987 482 340		← 1833
							1 987 482 341		→ 1835
	1.6	08.08→	84/86/96				1 987 482 337		262
	1.6 dCi						1 987 482 340		← 1833
	1.6 dCi 4x4						1 987 482 341		→ 1835
	2.0, dCi, dCi 4x4, 4x4	08.08→	104/110				1 987 482 337		262
							1 987 482 340		← 1833
							1 987 482 341		→ 1835
	1.5 dCi	08.08-03.10	78/81				0 265 007 908 <sup>4</sup>		
		08.08→	78/81				0 265 007 905 <sup>3</sup>		
		04.10→	78/81				0 265 008 620 <sup>4</sup>		
	1.6	08.08-03.10	84				0 265 007 908 <sup>4</sup>		
		08.08→	84				0 265 007 905 <sup>3</sup>		
		04.10→	84				0 265 008 620 <sup>4</sup>		
	1.6, dCi	11.10→	86/96				0 265 008 620 <sup>4</sup>		
	1.6, dCi, dCi 4x4	11.10→	86/96				0 265 007 905 <sup>3</sup>		
	2.0, dCi	08.08-03.10	104/110				0 265 007 908 <sup>4</sup>		
		04.10→	104/110				0 265 008 620 <sup>4</sup>		
	2.0, dCi, dCi 4x4, 4x4	08.08→	104/110				0 265 007 905 <sup>3</sup>		
	2.0 dCi 4x4, 4x4	08.08-03.10	104/110				0 265 007 909 <sup>4</sup>		
<b>Quest [V40]</b>									
	3.0	04.92-09.98	113			LAB	0 265 001 317 <sup>3</sup>		
							0 265 001 319 <sup>4</sup>		
						RAB	0 265 001 318 <sup>4</sup>		
		09.95-09.98	113			RAB	0 265 001 415 <sup>3</sup>		
<b>Safari</b>									
	4.5	08.97→	147						F 026 A03 471 <sup>7</sup>
	4.5	08.97-12.01	147				0 986 475 669		↔ 25,4
	4.5	08.97→	147			LAB	F 01G 09F 0F7 <sup>4</sup>		
							F 01G 09F 0HY <sup>3</sup>		
						RAB	F 01G 09F 0F8 <sup>4</sup>		
							F 01G 09F 0HZ <sup>3</sup>		



		S							
◀ NISSAN									
<b>Sentra</b>									
	1.4	05.92-06.97	63				0986 473 053	← 48,1	
							0986 474 053	→ 48,1	
	1.6	05.92-06.97	73/79				0986 473 053	← 48,1	
	1.6i						0986 474 053	→ 48,1	
	1.4	05.92-06.97	63		EFV		0986 475 670	↔ 15,8	
	1.6,i	05.92-06.97	73/79		EFV		0986 475 670	↔ 15,8	
<b>Sentra [B17R]</b>									
	1.6	09.14→	86						F 026 A03 539 <sup>7</sup>
<b>Serena [C23M]</b>									
	1.6i	07.92-11.01	71		TW				0 204 104 141 <sup>7</sup>
		10.93-11.01	71				0986 134 307	←	
							0986 135 307	→	
	2.0D	07.92-09.94	49		TW				0 204 104 141 <sup>7</sup>
		10.93-09.94	49				0986 134 307	←	
							0986 135 307	→	
	2.0i	10.93-11.01	93-96				0986 134 307	←	
							0986 135 307	→	
	2.3D	09.94-11.01	55				0986 473 132	← 42,78	
							0986 474 132	→ 42,78	
					TW				0 204 104 141 <sup>7</sup>
	1.6i	07.92-11.01	71				0986 475 759	↔ 23,8	
		12.97-11.01	71		TW		0986 475 915	↔ 25,4	
	2.0D,i	07.92-11.01	49/93-96				0986 475 759	↔ 23,8	
	2.3D	09.94-11.01	55				0986 475 759	↔ 23,8	
	1.6i	07.92-01.94	71				1987 477 816	← 1234	
	2.0D	07.92-01.94	49		LAU,LXA,SLX		1987 477 816	← 1234	
	2.0i	07.92-06.96	93-96		LAB		F 01G 09F 05R <sup>4</sup>		
					RAB		F 01G 09F 05S <sup>4</sup>		
		07.92-11.01	93-96		LAB		F 01G 09F 069 <sup>3</sup>		
					RAB		F 01G 09F 06A <sup>3</sup>		
		07.96-11.01	93-96		LAB		F 01G 09F 06W <sup>4</sup>		
					RAB		F 01G 09F 06X <sup>4</sup>		
<b>Sunny</b>									
	1.6i	01.94→	88				0986 473 051	← 54	F 026 A03 540 <sup>7</sup>
							0986 474 051	→ 54	F 026 A03 540 <sup>7</sup>
	2.0D	01.94-09.99	56				0986 473 051	← 54	F 026 A03 540 <sup>7</sup>
							0986 474 051	→ 54	F 026 A03 540 <sup>7</sup>



		S							
	1.3i	01.94→	63						0 986 475 670 ↔ 15,8
		01.01-10.04	64-66				AKE		F 026 A02 404 ↔
	1.6i	01.94→	88					TW	0 986 475 670 ↔ 15,8
	2.0D	01.94-09.99	56					TW	0 986 475 670 ↔ 15,8
	1.6i	01.94→	88						1 987 477 534 250
								TW	1 987 477 535 → 1662
									1 987 477 536 → 1677
									1 987 477 537 ← 1660
									1 987 477 538 ← 1676
	2.0D	01.94-09.99	56						1 987 477 534 250
								TW	1 987 477 535 → 1662
									1 987 477 537 ← 1660
		07.97-06.98	56					TW	1 987 477 536 → 1677
									1 987 477 538 ← 1676
<b>Sunny Hatchback [N14]</b>									
	1.4	10.92-05.95	58-64						0 986 473 053 ← 48,1
	1.4i								0 986 474 053 → 48,1
	1.6	10.92-05.95	70/75-81						0 986 473 053 ← 48,1
	1.6i								0 986 474 053 → 48,1
	2.0D	09.91-05.95	55						0 986 473 053 ← 48,1
									0 986 474 053 → 48,1
	2.0i	03.92-09.94	105						F 026 A03 504 <sup>7</sup>
	1.4.i	10.92-05.95	58-64						0 986 475 670 ↔ 15,8
	1.6.i	10.92-05.95	70/75-81						0 986 475 670 ↔ 15,8
	2.0D	10.90-05.95	55						0 986 475 670 ↔ 15,8
	1.4	10.92-05.95	58-64						0 986 473 091 ← 30,1 F 026 A08 107 <sup>7</sup>
	1.4i								0 986 474 091 → 30,1 F 026 A08 107 <sup>7</sup>
	1.6	ABS 10.92-05.95	70						0 986 473 091 ← 30,1 F 026 A08 107 <sup>7</sup>
									0 986 474 091 → 30,1 F 026 A08 107 <sup>7</sup>
	1.6i	10.92-05.95	75-81						0 986 473 091 ← 30,1 F 026 A08 107 <sup>7</sup>
									0 986 474 091 → 30,1 F 026 A08 107 <sup>7</sup>
	2.0D	10.92-05.95	55						0 986 473 091 ← 30,1 F 026 A08 107 <sup>7</sup>
									0 986 474 091 → 30,1 F 026 A08 107 <sup>7</sup>
		ABS 10.92-05.95	55						0 986 473 091 ← 30,1 F 026 A08 107 <sup>7</sup>
									0 986 474 091 → 30,1 F 026 A08 107 <sup>7</sup>
	1.4	ABO 10.92-05.95	58-64						1 987 477 397 → 1412
	1.4i								1 987 477 403 ← 1412
		ABS 10.92-05.95	58-64						1 987 477 398 → 1311
									1 987 477 404 ← 1311
	1.6	ABO 10.92-05.95	70/75-81						1 987 477 397 → 1412
	1.6i								1 987 477 403 ← 1412
		ABS 10.92-05.95	70/75-81						1 987 477 398 → 1311
									1 987 477 404 ← 1311
	2.0D	ABO 10.90-05.95	55						1 987 477 397 → 1412
									1 987 477 403 ← 1412
		ABS 10.92-05.95	55						1 987 477 398 → 1311
									1 987 477 404 ← 1311
	2.0i	10.90-09.94	105						1 987 477 398 → 1311
									1 987 477 404 ← 1311



◀ NISSAN Sunny Hatchback [N14]									
	1.4	10.92-05.95	58-64		LAB	F 01G 09F 016 <sup>4</sup>			
	1.4i				RAB	F 01G 09F 042 <sup>3</sup>			
						F 01G 09F 017 <sup>4</sup>			
						F 01G 09F 050 <sup>3</sup>			
	1.6	10.92-05.95	70/75-81		LAB	F 01G 09F 016 <sup>4</sup>			
	1.6i				RAB	F 01G 09F 042 <sup>3</sup>			
						F 01G 09F 017 <sup>4</sup>			
						F 01G 09F 050 <sup>3</sup>			
	2.0D	10.92-05.95	55		LAB	F 01G 09F 016 <sup>4</sup>			
					RAB	F 01G 09F 042 <sup>3</sup>			
						F 01G 09F 017 <sup>4</sup>			
						F 01G 09F 050 <sup>3</sup>			
	2.0i	10.90-09.94	105		LAB	F 01G 09F 016 <sup>4</sup>			
					RAB	F 01G 09F 042 <sup>3</sup>			
						F 01G 09F 017 <sup>4</sup>			
						F 01G 09F 050 <sup>3</sup>			
<b>Sunny Neo [N16]</b>									
	1.6i	10.00→	81			0986 AB8 153		↔ 15,88	
<b>Sunny [N17K]</b>									
	1.5	12.11→	73			0204 716 708		↔	
	1.5	12.11→	73			0265 008 311 <sup>3</sup>			
					LAB	0265 008 312 <sup>4</sup>			
					RAB	0265 008 313 <sup>4</sup>			
<b>Sunny Sedan [N14]</b>									
	1.4	10.92-05.95	58-64			0986 473 053		← 48,1	
	1.4i					0986 474 053		→ 48,1	
	1.6, i, i4WD, 4WD	09.91-10.95	66/70/ 75-81			0986 473 053		← 48,1	
						0986 474 053		→ 48,1	
	2.0D	09.91-05.95	55			0986 473 053		← 48,1	
						0986 474 053		→ 48,1	
	1.4, i	10.92-05.95	58-64			0986 475 670		↔ 15,8	
	1.6, i	10.92-05.95	70/75-81			0986 475 670		↔ 15,8	
	2.0D	10.90-05.95	55			0986 475 670		↔ 15,8	
	1.4	10.92-05.95	58-64			0986 473 091		← 30,1	F 026 A08 107 <sup>7</sup>
	1.4i					0986 474 091		→ 30,1	F 026 A08 107 <sup>7</sup>
	1.6	ABS	10.92-05.95	70		0986 473 091		← 30,1	F 026 A08 107 <sup>7</sup>
						0986 474 091		→ 30,1	F 026 A08 107 <sup>7</sup>
	1.6i		10.92-05.95	75-81		0986 473 091		← 30,1	F 026 A08 107 <sup>7</sup>
						0986 474 091		→ 30,1	F 026 A08 107 <sup>7</sup>
	1.6i 4WD	ABS	10.92-05.95	75-81					F 026 A08 107 <sup>7</sup>
	1.6 4WD	ABS	10.90-10.95	66					F 026 A08 107 <sup>7</sup>
	2.0D		10.92-05.95	55		0986 473 091		← 30,1	F 026 A08 107 <sup>7</sup>
						0986 474 091		→ 30,1	F 026 A08 107 <sup>7</sup>
			ABS	10.92-05.95	55		0986 473 091		← 30,1
						0986 474 091		→ 30,1	F 026 A08 107 <sup>7</sup>













N

		S							
	<b>1.4</b> <b>1.4i</b>	ABO	10.92-05.95	58-64			1 987 477 397	→ 1412	
							1 987 477 403	← 1412	
		ABS	10.92-05.95	58-64			1 987 477 398	→ 1311	
							1 987 477 404	← 1311	
	<b>1.6</b> <b>1.6i</b>	ABO	10.92-05.95	70/75-81			1 987 477 397	→ 1412	
							1 987 477 403	← 1412	
		ABS	10.92-05.95	70/75-81			1 987 477 398	→ 1311	
							1 987 477 404	← 1311	
	<b>2.0D</b>	ABO	10.90-05.95	55			1 987 477 397	→ 1412	
							1 987 477 403	← 1412	
		ABS	10.92-05.95	55			1 987 477 398	→ 1311	
							1 987 477 404	← 1311	
	<b>1.4</b> <b>1.4i</b>		10.92-05.95	58-64	LAB		F 01G 09F 016 <sup>4</sup>		
					RAB		F 01G 09F 04Z <sup>3</sup>		
							F 01G 09F 017 <sup>4</sup>		
							F 01G 09F 050 <sup>3</sup>		
	<b>1.6</b>		10.92-05.95	70	LAB		F 01G 09F 016 <sup>4</sup>		
					RAB		F 01G 09F 04Z <sup>3</sup>		
							F 01G 09F 017 <sup>4</sup>		
							F 01G 09F 050 <sup>3</sup>		
	<b>1.6i</b>		10.92-05.95	75-81	LAB		F 01G 09F 016 <sup>4</sup>		
					RAB		F 01G 09F 04Z <sup>3</sup>		
							F 01G 09F 017 <sup>4</sup>		
							F 01G 09F 050 <sup>3</sup>		
	<b>1.6i 4WD</b>		10.92-05.95	75-81	LAB		F 01G 09F 057 <sup>3</sup>		
					RAB		F 01G 09F 059 <sup>4</sup>		
							F 01G 09F 05A <sup>4</sup>		
							F 01G 09F 058 <sup>3</sup>		
	<b>1.6 4WD</b>		10.90-10.95	66	LAB		F 01G 09F 057 <sup>3</sup>		
					RAB		F 01G 09F 059 <sup>4</sup>		
							F 01G 09F 05A <sup>4</sup>		
							F 01G 09F 058 <sup>3</sup>		
	<b>2.0D</b>		10.92-05.95	55	LAB		F 01G 09F 016 <sup>4</sup>		
					RAB		F 01G 09F 04Z <sup>3</sup>		
							F 01G 09F 017 <sup>4</sup>		
							F 01G 09F 050 <sup>3</sup>		
<b>Sunny Wagon [Y10]</b>									
	<b>1.6i 4WD</b>	ABS	10.92-07.95	75-81					F 026 A08 104 <sup>7</sup>
	<b>1.6, i, i 4WD, 4WD</b>		11.90-03.00	66/70/75-81			0 986 475 675	↔ 17,4	
	<b>1.7D</b>		05.92-04.98	40			0 986 475 675	↔ 17,4	
	<b>2.0D</b>		11.90-03.00	55			0 986 475 675	↔ 17,4	
<b>Teana</b>									
	<b>2.3i</b>		02.03-06.08	127					F 026 A03 539 <sup>7</sup>
	<b>3.5i</b>		06.08→	185			0 986 475 933	↔ 19,05	



		S				?			
◀ NISSAN Teana									
	2.5 i	06.08→	136				0 265 008 374 <sup>3</sup>		
							0 265 008 376 <sup>4</sup>		
<b>Teana [J31]</b>									
	2.0	04.06-02.08	100						F 026 A03 539 <sup>7</sup>
	2.3	04.06-02.08	127						F 026 A03 539 <sup>7</sup>
	3.5	07.06-02.08	180						F 026 A03 539 <sup>7</sup>
<b>Teana [J32]</b>									
	2.5	02.08→	132-136				0 265 008 374 <sup>3</sup>		
							0 265 008 376 <sup>4</sup>		
	3.5	02.08→	180-185				0 265 008 374 <sup>3</sup>		
							0 265 008 376 <sup>4</sup>		
<b>Teana [J32R]</b>									
	2.5	06.09→	134				0 265 008 374 <sup>3</sup>		
							0 265 008 376 <sup>4</sup>		
	2.5 4x4	03.10-09.12	123		LAB		0 265 008 250 <sup>4</sup>		
					RAB		0 265 008 378 <sup>4</sup>		
		03.10→	123				0 265 008 375 <sup>3</sup>		
	3.5	06.09→	183				0 265 008 374 <sup>3</sup>		
							0 265 008 376 <sup>4</sup>		
<b>Terrano I [WD21]</b>									
	3.0 i	01.90-10.95	109						F 026 A03 481 <sup>7</sup>
	3.0 i 4WD								
	2.4	09.89-11.95	76				F 026 A02 242	↔	
	2.7 D	09.89-11.95	62				F 026 A02 242	↔	
<b>Terrano II [R20]</b>									
	2.4 i 4x4	02.93-05.96	91				0 986 134 307		←
							0 986 135 307		→
	2.7 D Turbo 4x4	02.93-05.96	74				0 986 134 307		←
							0 986 135 307		→
	2.4 i 4x4	02.93-05.96	91				0 986 475 759	↔	23,8
		05.96-10.99	87				0 986 475 759	↔	23,8
							0 986 475 915	↔	25,4
		11.96-12.99	85				0 986 475 759	↔	23,8
		11.99-02.02	87				F 026 002 172	↔	22,2
		11.99-12.06	87				F 026 002 241	↔	23,81
		ABS 11.99-02.02	87				F 026 002 171	↔	20,6
	2.7 D Turbo 4x4	02.93-10.99	74				0 986 475 759	↔	23,8
		01.96-10.99	91-92				0 986 475 759	↔	23,8
		06.96-10.99	74		254		0 986 475 915	↔	25,4
			91-92		254		0 986 475 915	↔	25,4



		S									
2.7 D Turbo 4x4		11.96→	92				0 986 475 759	↔ 23,8			
		11.98-12.99	92				0 986 475 915	↔ 25,4			
		11.99-02.02	74				F 026 002 172	↔ 22,2			
			91-92				F 026 002 171	↔ 20,6			
		11.99-12.06	91-92				F 026 002 172	↔ 22,2			
							0 204 011 241	↔ 23,8			
		01.00→	92				F 026 002 171	↔ 20,6			
							F 026 002 172	↔ 22,2			
		ABO	11.99-02.02	74			F 026 002 241	↔ 23,81			
		ABS	11.99-02.02	74			F 026 002 171	↔ 20,6			
3.0 D Turbo 4x4		02.02-12.06	113				F 026 002 172	↔ 22,2			
							F 026 002 241	↔ 23,81			
2.4 i 4x4			02.93-05.96	91			1 987 477 756	← 1324			
							1 987 477 757	↔ 1470			
			05.96-01.98	87			1 987 477 982	303			
			05.96-10.99	87			1 987 477 756	← 1324			
							1 987 477 757	↔ 1470			
			11.96-01.98	85			1 987 482 152	→ 1355			
			11.96-12.99	85			1 987 477 756	← 1324			
			01.98-12.99	85			1 987 477 757	→ 1470			
			11.99-12.06	87			1 987 482 048	← 1365			
							1 987 482 049	→ 1394			
							1 987 482 050	← 1510			
							1 987 482 051	→ 1520			
			2.7 D Turbo 4x4		02.93-10.99	74			1 987 477 756	← 1324	
									1 987 477 757	↔ 1470	
				01.96-10.99	91-92			1 987 477 756	← 1324		
								1 987 477 757	↔ 1470		
06.96-01.98	91-92				1 987 477 982	303					
11.96-01.98	92				1 987 482 152	→ 1355					
11.96→	92				1 987 477 756	← 1324					
01.98→	92				1 987 477 757	→ 1470					
11.99-02.02	74				1 987 482 048	← 1365					
					1 987 482 049	→ 1394					
				1 987 482 050	← 1510						
				1 987 482 051	→ 1520						
3.0 D Turbo 4x4		02.02-12.06	113			1 987 482 048	← 1365				
						1 987 482 049	→ 1394				
					1 987 482 050	← 1510					
					1 987 482 051	→ 1520					
	2.4 i 4x4			05.96-02.02	87			0 265 006 285 <sup>4</sup>			
								LAB	0 265 006 670 <sup>3</sup>		
								RAB	0 265 006 671 <sup>3</sup>		
				05.96-12.06	87			0 265 006 281 <sup>4</sup>			
				11.96-12.99	85			0 265 006 281 <sup>4</sup>			
								LAB	0 265 006 670 <sup>3</sup>		
							RAB	0 265 006 671 <sup>3</sup>			
03.02-12.06				87			0 265 006 779 <sup>4</sup>				
							LAB	0 265 006 756 <sup>3</sup>			
							RAB	0 265 006 755 <sup>3</sup>			
2.7 D Turbo 4x4		01.96-02.02	91-92			LAB	0 265 006 670 <sup>3</sup>				
						RAB	0 265 006 671 <sup>3</sup>				
	01.96-06.02	91-92				0 265 006 281 <sup>4</sup>					
						0 265 006 285 <sup>4</sup>					





























		S							
	◀ NISSAN Terrano II [R20]								
	2.7 D Turbo 4x4	11.96→	92				0 265 006 281 <sup>4</sup>		
						LAB	0 265 006 670 <sup>3</sup>		
						RAB	0 265 006 671 <sup>3</sup>		
		11.98→	92				0 265 006 285 <sup>4</sup>		
		10.99-02.02	74				0 265 006 281 <sup>4</sup>		
							0 265 006 285 <sup>4</sup>		
						LAB	0 265 006 670 <sup>3</sup>		
						RAB	0 265 006 671 <sup>3</sup>		
		03.02-12.06	91-92			LAB	0 265 006 756 <sup>3</sup>		
						RAB	0 265 006 755 <sup>3</sup>		
		07.02-12.06	91-92				0 265 006 778 <sup>4</sup>		
							0 265 006 779 <sup>4</sup>		
	3.0 D Turbo 4x4	02.02-06.02	113				0 265 006 281 <sup>4</sup>		
							0 265 006 285 <sup>4</sup>		
		02.02-12.06	113			LAB	0 265 006 756 <sup>3</sup>		
						RAB	0 265 006 755 <sup>3</sup>		
		07.02-12.06	113				0 265 006 778 <sup>4</sup>		
							0 265 006 779 <sup>4</sup>		
<b>Tiida</b>									
	1.8 i	01.05-08.12	93-94				0 986 AB8 154	↔ 15,88	
	1.5 i	09.04-08.12	80				0 265 008 373 <sup>3</sup>		
						LAB	0 265 008 519 <sup>4</sup>		
						RAB	0 265 008 520 <sup>4</sup>		
	1.8 i	01.05-08.12	93-94				0 265 008 373 <sup>3</sup>		
						LAB	0 265 008 519 <sup>4</sup>		
						RAB	0 265 008 520 <sup>4</sup>		
<b>Tiida [C11]</b>									
	1.5 dCi	02.07-03.10	78						F 026 A03 539 <sup>7</sup>
	1.6	02.07-03.10	81						F 026 A03 539 <sup>7</sup>
	1.8	02.07-03.10	93						F 026 A03 539 <sup>7</sup>
	1.5 dCi	02.07-03.10	78				0 986 134 251	←	
							0 986 135 251	→	
	1.6	02.07→	81				0 986 134 251	←	
							0 986 135 251	→	
	1.8	02.07-03.10	93				0 986 134 251	←	
							0 986 135 251	→	
<b>Tiida Hatchback [C11]</b>									
	1.5 dCi	03.07-03.10	78						F 026 A03 539 <sup>7</sup>
	1.6	03.07-03.10	81						F 026 A03 539 <sup>7</sup>
	1.8	03.07-03.10	93						F 026 A03 539 <sup>7</sup>
	1.5 dCi	03.07-03.10	78				0 986 134 251	←	
							0 986 135 251	→	
	1.6	03.07→	81				0 986 134 251	←	
							0 986 135 251	→	



		S							
	1.8	03.07-03.10	93				0 986 134 251		
							0 986 135 251		
<b>Tiida Hatchback [C11X]</b>									
	1.8	06.06-03.10	92				0 986 AB8 154	↔ 15,88	
<b>Tiida Latio</b>									
	1.8i	01.05-10.12	94				0 986 AB8 154	↔ 15,88	
	1.5i	10.04-10.12	80				0 265 008 373 <sup>3</sup>		
						LAB	0 265 008 519 <sup>4</sup>		
						RAB	0 265 008 520 <sup>4</sup>		
<b>Tiida Latio [SC11]</b>									
	1.6	08.05-09.08	81-84						F 026 A06 611 <sup>7</sup>
	1.8	08.05-09.08	94						F 026 A06 611 <sup>7</sup>
	1.6	08.05-08.10	81-84			TW	0 986 AB8 154	↔ 15,88	
	1.8	08.05-08.10	94			TW	0 986 AB8 154	↔ 15,88	
	1.6	08.05-08.10	81-84				0 265 008 373 <sup>3</sup>		
						LAB	0 265 008 519 <sup>4</sup>		
						RAB	0 265 008 520 <sup>4</sup>		
	1.8	08.05-08.10	94				0 265 008 373 <sup>3</sup>		
						LAB	0 265 008 519 <sup>4</sup>		
						RAB	0 265 008 520 <sup>4</sup>		
<b>Trade</b>									
	2.0D	04.92-12.98	41/46				0 204 102 295	← 52	
							0 204 102 296	→ 52	
							0 204 103 296		
	2.8D	04.92-12.98	57-60				0 204 102 295	← 52	
							0 204 102 296	→ 52	
							0 204 103 296		
	3.0D	04.93-12.98	63/78				0 204 102 295	← 52	
	3.0D Turbo						0 204 102 296	→ 52	
							0 204 103 296		
<b>Urvan [E24]</b>									
	2.4	11.86-06.97	74						F 026 A03 481 <sup>7</sup>
	2.7D	11.86-06.97	62						F 026 A03 481 <sup>7</sup>



									
◀ NISSAN Urvan [E24]									
									
	2.0	02.87-07.94	64-66			F 026 <b>A02 242</b>	↔		
	2.4	11.86-06.97	74			F 026 <b>A02 242</b>	↔		
						0986 <b>J04 037</b>	↔		
	2.4i	05.89-07.94	74-76			F 026 <b>A02 242</b>	↔		
	2.5D	12.88-07.94	59			F 026 <b>A02 242</b>	↔		
		03.89-06.97	63			F 026 <b>A02 238</b>	↔		
					0986 <b>J04 037</b>	↔			
2.7D	11.86-06.97	62			F 026 <b>A02 242</b>	↔			
<b>Vanette Cargo [C23M]</b>									
									
	1.6i	07.92-11.01	71-72		TW			0 204 <b>104 141</b> <sup>7</sup>	
		10.93-11.01	71-72			0986 <b>134 307</b>	↔		
						0986 <b>135 307</b>	↔		
2.0D	07.92-09.94	49			TW			0 204 <b>104 141</b> <sup>7</sup>	
	10.93-09.94	49				0986 <b>134 307</b>	↔		
						0986 <b>135 307</b>	↔		
2.3D	09.94-11.01	55							
						0986 <b>473 132</b>	↔	42,78	
						0986 <b>474 132</b>	↔	42,78	
					TW			0 204 <b>104 141</b> <sup>7</sup>	
									
	1.6i	07.92-11.01	71-72			0986 <b>475 759</b>	↔	23,8	
		12.97-11.01	71-72		TW	0986 <b>475 915</b>	↔	25,4	
	2.0D	07.92-09.94	49			0986 <b>475 759</b>	↔	23,8	
	2.3D	09.94-11.01	55			0986 <b>475 759</b>	↔	23,8	
									
	1.6i	07.92-01.94	71-72			1987 <b>477 816</b>	←	1234	
	2.0D	07.92-01.94	49		LAU,LXA, SLX	1987 <b>477 816</b>	←	1234	
<b>Vanette [C220]</b>									
									
	2.0D	05.88-11.94	44/47-49			0986 <b>475 558</b>	↔	20,63	
<b>Xterra</b>									
									
	2.8D	02.03-07.05	97					F 026 <b>A03 481</b> <sup>7</sup>	
<b>X-Trail</b>									
									
	2.0i4WD	10.00-08.07	110					F 026 <b>A03 544</b> <sup>7</sup>	
									
	2.0	08.07→	101			0986 <b>134 253</b>	↔		
						0986 <b>135 253</b>	↔		
	2.0i4WD	10.00-06.06	110				0986 <b>134 040</b>	↔	35
							0986 <b>135 040</b>	↔	35
		07.06-08.07	110					F 026 <b>A06 135</b> <sup>7</sup>	

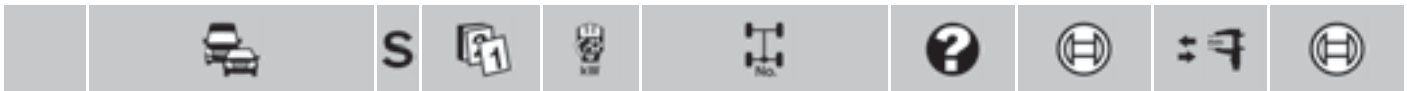

	2.0	08.07→	101			1 987 482 342	317	
--	-----	--------	-----	--	--	---------------	-----	--

**X-Trail [T30]**

	2.0i 4x4	11.01→	103	TW		0 986 473 488	☞ ← 44	
						0 986 135 300	☞ →	
						0 986 474 488	☞ →	
	2.0 4x2	06.01-09.06	103			0 986 473 488	☞ ← 44	
	2.0 4x4					0 986 135 300	☞ →	
						0 986 474 488	☞ →	
		10.06-03.07	103					F 026 A03 544 <sup>7</sup>
	2.2 D Turbo 4x2	09.03-09.06	100			0 986 473 488	☞ ← 44	
	2.2 D Turbo 4x4					0 986 135 300	☞ →	
						0 986 474 488	☞ →	
		10.06-03.07	100					F 026 A03 544 <sup>7</sup>
	2.2 D Turbo 4x4	06.01-08.06	84			0 986 473 488	☞ ← 44	
						0 986 135 300	☞ →	
						0 986 474 488	☞ →	
	2.5	12.06→	121					F 026 A03 544 <sup>7</sup>
	2.5 4x4	09.02-03.07	121			0 986 473 488	☞ ← 44	
						0 986 135 300	☞ →	
						0 986 474 488	☞ →	
		10.06-03.07	121					F 026 A03 544 <sup>7</sup>

	2.0i 4x4	11.01→	103	TW		0 986 135 040	☞ ← 35	
						0 986 134 040	☞ → 35	
	2.0 4x2	06.01-06.06	103			0 986 134 040	☞ ← 35	
	2.0 4x4					0 986 135 040	☞ → 35	
		07.06-03.07	103					F 026 A06 135 <sup>7</sup>
	2.2 D Turbo 4x2	09.03-06.06	100			0 986 134 040	☞ ← 35	
	2.2 D Turbo 4x4					0 986 135 040	☞ → 35	
		07.06-03.07	100					F 026 A06 135 <sup>7</sup>
	2.2 D Turbo 4x4	06.01-08.06	84			0 986 134 040	☞ ← 35	
						0 986 135 040	☞ → 35	
	2.5	12.06-03.10	121					F 026 A06 135 <sup>7</sup>
	2.5 4x4	09.02-06.06	121			0 986 134 040	☞ ← 35	
						0 986 135 040	☞ → 35	
		07.06-03.07	121					F 026 A06 135 <sup>7</sup>

	2.0 4x2, 4x4	06.01-03.07	103			1 987 477 226	236	
	2.2 D Turbo 4x2, D Turbo 4x4	06.01-03.07	84/100			1 987 477 226	236	
	2.5 4x4	09.02-03.07	121			1 987 477 226	236	

**X-Trail [T31]**

	2.0, dCi, dCi 4x4, 4x4	04.07→	104-106/ 110/127			0 986 134 299	☞ ← 60	
						0 986 135 299	☞ → 60	
	2.5 4x4	04.07→	124			0 986 134 299	☞ ← 60	
						0 986 135 299	☞ → 60	

	2.0, dCi, dCi 4x4, 4x4	04.07→	104-106/ 110/127			0 986 134 253	☞ ←	
						0 986 135 253	☞ →	



		S							
	<b>NISSAN X-Trail [T31]</b>								
	2.5 4x4	04.07→	124				0986 134 253		←
							0986 135 253		→
	<b>2.0, dCi, dCi 4x4, 4x4</b>								
	2.0, dCi, dCi 4x4, 4x4	04.07→	104-106/110/127				1987 482 342		317
	2.5 4x4	04.07→	124				1987 482 342		317
	<b>X-Trail [T31R]</b>								
	<b>2.0 dCi 4x4</b>								
	2.0 dCi 4x4	10.09→	104/110/127				0986 134 299		← 60
	2.0 4x4						0986 135 299		→ 60
	2.5 4x4	10.09→	124				0986 134 299		← 60
							0986 135 299		→ 60
	<b>2.0 dCi 4x4</b>								
	2.0 dCi 4x4	10.09→	104/110/127				0986 134 253		←
	2.0 4x4						0986 135 253		→
	2.5 4x4	10.09→	124				0986 134 253		←
							0986 135 253		→
	<b>2.0 dCi 4x4, 4x4</b>								
	2.0 dCi 4x4, 4x4	10.09→	104/110/127				1987 482 342		317
	2.5 4x4	10.09→	124				1987 482 342		317
	<b>100 NX [B13]</b>								
	<b>1.6 i</b>								
	1.6 i	10.92-10.94	75-81				0986 473 053		← 48,1
							0986 474 053		→ 48,1
	<b>1.6 i</b>								
	1.6 i	10.92-10.94	75-81				0986 475 670		↔ 15,8
	<b>1.6 i</b>								
	1.6 i	ABS	10.92-10.94	75-81			0986 473 091		← 30,1
							0986 474 091		→ 30,1
	<b>1.6 i</b>								
	1.6 i	ABO	10.92-10.94	75-81			1987 477 397		→ 1412
							1987 477 403		← 1412
		ABS	10.92-10.94	75-81			1987 477 398		→ 1311
							1987 477 404		← 1311
	<b>1.6 i</b>								
	1.6 i		10.92-10.94	75-81		LAB	F 01G 09F 016 <sup>4</sup>		
							F 01G 09F 04Z <sup>3</sup>		
						RAB	F 01G 09F 017 <sup>4</sup>		
							F 01G 09F 050 <sup>3</sup>		
	<b>300 ZX [Z32]</b>								
	<b>3.0 i Biturbo</b>								
	3.0 i Biturbo	01.90-03.96	197-208				F 01G 09F 04Y <sup>4</sup>		
						LAB	F 01G 09F 04V <sup>3</sup>		
						RAB	F 01G 09F 04W <sup>3</sup>		





**350 Z Cabriolet [Z33]**



	3.5	06.02-07.05	206				F 026 A03 539 <sup>7</sup>
--	-----	-------------	-----	--	--	--	----------------------------

**370 Z Coupé [Z34]**



	3.7	10.08-06.09	241-243	LAB	0 265 008 190 <sup>4</sup>		
				RAB	0 265 008 191 <sup>4</sup>		
		10.08→	241-243	TW	0 265 008 025 <sup>3</sup>		
					0 265 008 381 <sup>3</sup>		
		04.09-02.10	241-243	RAB	0 265 008 025 <sup>3</sup>		
		04.09→	241-243	LAB	0 265 008 381 <sup>3</sup>		
		07.09-10.10	241-243	LAB	0 265 008 564 <sup>4</sup>		
		07.09→	241-243	RAB	0 265 008 563 <sup>4</sup>		
	03.10→	241-243	RAB	0 265 008 381 <sup>3</sup>			
	11.10→	241-243	LAB	0 265 008 530 <sup>4</sup>			

**370 Z Roadster [Z34]**



	3.7	11.09-02.10	241		0 265 008 025 <sup>3</sup>		
		11.09-10.10	241	LAB	0 265 008 564 <sup>4</sup>		
		11.09→	241	RAB	0 265 008 563 <sup>4</sup>		
		03.10→	241		0 265 008 381 <sup>3</sup>		
		11.10→	241	LAB	0 265 008 530 <sup>4</sup>		

**370Z Coupé [Z34]**



	3.7 Nismo	03.13→	253		0 265 008 381 <sup>3</sup>		
				LAB	0 265 008 530 <sup>4</sup>		
				RAB	0 265 008 563 <sup>4</sup>		

**OPEL**

**Adam**



	1.0	07.14→	66/85	257	0 204 902 032	← 54		
					0 986 473 487			
					0 204 902 033	→ 54		
					0 986 474 487			
	1.2	03.13→	51	257	0 204 902 032	← 54		
					0 986 473 487			
					0 204 902 033	→ 54		
					0 986 474 487			
					308, SBJ		1 987 470 005 <sup>7</sup>	
					308, SBJ	0 986 473 062	← 57	1 987 470 005 <sup>7</sup>
						0 986 474 062	→ 57	1 987 470 005 <sup>7</sup>
1.4 1.4 LPG 1.4 Turbo	03.13→	64/74/110	257	0 204 902 032	← 54			
				0 986 473 487				
				0 204 902 033	→ 54			
				0 986 474 487				
			308, SBJ		1 987 470 005 <sup>7</sup>			
			308, SBJ	0 986 473 062	← 57	1 987 470 005 <sup>7</sup>		
				0 986 474 062	→ 57	1 987 470 005 <sup>7</sup>		



		<b>S</b>							
<b>◀ OPEL Adam</b>									
	<b>1.0</b>	07.14→	66/85				0986 <b>475 949</b>	↔ 19,05	
	<b>1.2</b>	03.13→	51				0986 <b>475 949</b>	↔ 19,05	
	<b>1.4, LPG, Turbo</b>	03.13→	64/74/110				0986 <b>475 949</b>	↔ 19,05	
	<b>1.0</b>	07.14→	66/85				0265 <b>008 089</b> <sup>3</sup>		
	<b>1.2</b>	03.13→	51				0265 <b>008 089</b> <sup>3</sup>		
	<b>1.4, LPG, Turbo</b>	03.13→	64/74/110				0265 <b>008 089</b> <sup>3</sup>		
<b>Agila [A]</b>									
	<b>1.0 i</b>	06.00-02.08	43/44						0 204 <b>104 299</b> <sup>8</sup>
	<b>1.0 Twinport</b>					Fg.-Nr. →3G002367, →3G002706	0 204 <b>102 950</b>	← 48	
							0986 <b>473 344</b>		
							0 204 <b>102 951</b>	→ 48	
							0986 <b>474 344</b>		
						Fg.-Nr. 3G000001→			0 204 <b>104 298</b> <sup>7</sup>
						Fg.-Nr. 3G002368→, 3G002707→	0 204 <b>204 711</b>	← 48	
							0986 <b>473 343</b>		
							0 204 <b>204 712</b>	→ 48	
							0986 <b>474 343</b>		
	<b>1.2 i</b>	06.00-06.04	55			Fg.-Nr. →3G002367, →3G002706	0 204 <b>102 950</b>	← 48	
							0986 <b>473 344</b>		
							0 204 <b>102 951</b>	→ 48	
							0986 <b>474 344</b>		
						Fg.-Nr. 3G000001→			0 204 <b>104 298</b> <sup>7</sup>
						Fg.-Nr. 3G002368→, 3G002707→	0 204 <b>204 711</b>	← 48	
							0986 <b>473 343</b>		
							0 204 <b>204 712</b>	→ 48	
							0986 <b>474 343</b>		
	<b>1.2 Twinport</b>	07.04-02.08	59			Fg.-Nr. 3G000001→			0 204 <b>104 299</b> <sup>8</sup>
						Fg.-Nr. 3G002368→, 3G002707→	0 204 <b>204 711</b>	← 48	
							0986 <b>473 343</b>		
							0 204 <b>204 712</b>	→ 48	
							0986 <b>474 343</b>		
	<b>1.3 CDTI</b>	08.03-02.08	51			Fg.-Nr. →3G002367, →3G002706	0 204 <b>102 950</b>	← 48	
							0986 <b>473 344</b>		
							0 204 <b>102 951</b>	→ 48	
							0986 <b>474 344</b>		
						Fg.-Nr. 3G000001→			0 204 <b>104 298</b> <sup>7</sup>
						Fg.-Nr. 3G002368→, 3G002707→	0 204 <b>204 711</b>	← 48	
							0986 <b>473 343</b>		
							0 204 <b>204 712</b>	→ 48	
							0986 <b>474 343</b>		
	<b>1.0 i, Twinport</b>	06.00-02.08	43/44				0986 <b>475 886</b>	↔ 15,87	
	<b>1.2 i, Twinport</b>	06.00-02.08	55/59				0986 <b>475 886</b>	↔ 15,87	
	<b>1.3 CDTI</b>	08.03-02.08	51				0986 <b>475 886</b>	↔ 15,87	
	<b>1.0 i</b>	06.00-02.08	43/44			Fg.-Nr. →1G075421	1987 <b>477 771</b>	← 1518	
	<b>1.0 Twinport</b>						1987 <b>477 995</b>	→ 1507	
						Fg.-Nr. 1G075422→2G999999	1987 <b>477 771</b>	← 1518	
							1987 <b>477 772</b>	→ 1498	

1.0i	06.00-02.08	43/44	Fg.-Nr. 3G000001→			1 987 482 136	→ 1530	
1.0Twinport						1 987 482 137	← 1536	
1.2i	06.00-02.08	55/59	Fg.-Nr. →1G075421			1 987 477 771	← 1518	
1.2Twinport			Fg.-Nr. 1G075422→2G999999			1 987 477 995	→ 1507	
						1 987 477 771	← 1518	
			Fg.-Nr. 3G000001→			1 987 482 136	→ 1530	
						1 987 482 137	← 1536	
1.3CDTI	08.03-02.08	51	Fg.-Nr. →1G075421			1 987 477 771	← 1518	
			Fg.-Nr. 1G075422→2G999999			1 987 477 995	→ 1507	
						1 987 477 771	← 1518	
			Fg.-Nr. 3G000001→			1 987 477 772	→ 1498	
						1 987 482 136	→ 1530	
						1 987 482 137	← 1536	
<b>Agila [B]</b>								
	1.0Twinport	03.08→	48-50			0 986 475 951	↔ 19,05	
	1.2Twinport	03.08→	63-69			0 986 475 951	↔ 19,05	
	1.3CDTI	03.08→	55			0 986 475 951	↔ 19,05	
	1.0Twinport	03.08→	48-50			1 987 482 427	→ 1600	
						1 987 482 428	← 1600	
	1.2Twinport	03.08→	63-69			1 987 482 427	→ 1600	
						1 987 482 428	← 1600	
	1.3CDTI	03.08→	55			1 987 482 427	→ 1600	
						1 987 482 428	← 1600	
<b>Antara</b>								
	2.0CDTI	05.06-12.11	93/110	Fg.-Nr. →80999999,	FEB	1 987 482 293	← 1431	
	2.0CDTI 4x4			→AB999999, →A3999999		1 987 482 294	→ 1454	
	2.4	05.06-12.11	104	Fg.-Nr. →80999999,	FEB	1 987 482 293	← 1431	
	2.4 4x4			→AB999999, →A3999999		1 987 482 294	→ 1454	
	3.2 V6 4x4	05.06-12.11	165-167		FEB	1 987 482 293	← 1431	
						1 987 482 294	→ 1454	
<b>Arena</b>								
	1.9D	03.98-08.01	44			0 204 102 054	→ 45	
						0 204 103 054		
	2.5D	03.98-08.01	55			0 204 102 054	→ 45	
						0 204 103 054		
	1.9D	03.98-08.01	44			1 987 477 662	↔ 747	
		ABO 03.98-08.01	44			1 987 477 663	← 1330	
						1 987 477 665	→ 1424	
		ABS 03.98-08.01	44			1 987 477 664	← 1295	
						1 987 477 666	→ 1390	
	2.5D	03.98-08.01	55			1 987 477 662	↔ 747	
		ABO 03.98-08.01	55			1 987 477 663	← 1330	
						1 987 477 665	→ 1424	
		ABS 03.98-08.01	55			1 987 477 664	← 1295	
						1 987 477 666	→ 1390	





			S										
◀ OPEL													
<b>Astra Cabrio [F]</b>													
	1.4 i	09.91-02.98	44					0986 471 895	←	48			
								0986 473 895					
		0986 471 896	→					48					
		0986 473 896											
		03.92-02.98	60					0986 471 899	←	48			
								0986 473 899					
			0986 473 901										
			0986 471 900	→	48								
			0986 473 900										
			0986 473 902										
			04.96-02.98	66	NOR	0986 471 899	←	48					
						0986 473 899							
				0986 473 901									
				0986 471 900		→	48						
				0986 473 900									
				0986 473 902									
				VEA	0986 473 905		←	52					
					0986 473 906		→	52					
1.6 i	09.91-02.98	52/55		Fg.-Nr. →T2500013, →T5000073, →T8100000	0986 471 895	←	48						
					0986 473 895								
					0986 471 896	→	48						
					0986 473 896								
							0986 471 899	←	48				
							0986 473 899						
			0986 473 901										
					0986 471 900	→	48						
					0986 473 900								
					0986 473 902								
					09.94-02.98	74	0986 473 905		←	52			
							0986 473 906		→	52			
1.8 i	09.91-02.98	66			0986 471 901	←	48						
					0986 473 901								
					0986 471 902	→	48						
					0986 473 902								
					09.93-08.98	85/92	0986 473 905		←	52			
							0986 473 906		→	52			
2.0 i	09.91-02.98	85/100/ 110			0986 473 905		←	52					
					0986 473 906		→	52					
	1.4 i	09.91-02.98			44/60/66			0986 475 143	↔	19,05			
	1.6 i	09.91-02.98			52/55/74			0986 475 143	↔	19,05			
	1.8 i	09.91-08.98	66/85/92			0986 475 143	↔	19,05					
	2.0 i	09.91-02.98	85/100/110			0986 475 143	↔	19,05					
	1.4 i	09.91-02.98	44/60/66			0986 473 947		←	35				
										0986 473 948		→	35
	1.6 i	09.91-02.98	52/55/74			0986 473 947		←	35				
						0986 473 948		→	35				
	1.8 i	09.91-08.98	66/85/92			0986 473 947		←	35				
						0986 473 948		→	35				
	2.0 i	09.91-02.98	85/100/ 110			0986 473 947		←	35				
						0986 473 948		→	35				
		1.4 i	09.91-02.98			44/60/66			HTB	1987 477 129		1690	
									4SB	1987 477 766		1575	

		S								
1.6i		09.91-02.98	52/55/74			HTB	1 987 477 129	1690		
						4SB	1 987 477 766	1575		
1.8i		09.91-08.98	66/85/92			HTB	1 987 477 129	1690		
						4SB	1 987 477 766	1575		
2.0i		09.91-02.98	85/100/ 110			HTB	1 987 477 129	1690		
						4SB	1 987 477 766	1575		
	1.4i	09.91-02.98	44/60/66				0 986 594 026 <sup>3</sup>			
	1.6i	09.91-02.98	52/55/74				0 986 594 026 <sup>3</sup>			
	1.8i	09.91-08.98	66/85/92				0 986 594 026 <sup>3</sup>			
	2.0i	09.91-02.98	85/100/ 110				0 986 594 026 <sup>3</sup>			
<b>Astra Cabrio [G]</b>										
	1.4i	09.97-08.05	66				0 986 473 057		← 52	
							0 986 474 057		→ 52	
	1.6i	09.97-08.05	74/76				0 986 473 057		← 52	
	1.6 Twinport						0 986 474 057		→ 52	
	1.7 CDTI	03.03-08.05	59				0 986 473 057		← 52	
							0 986 474 057		→ 52	
	1.8i	09.00-08.05	92			AG	0 986 473 057		← 52	
							0 986 474 057		→ 52	
						GS	0 986 473 062		← 57	
							0 986 474 062		→ 57	
	2.0 Turbo	03.02-08.05	141-147				0 986 473 062		← 57	
							0 986 474 062		→ 57	
	2.2 DTI	09.00-08.05	92/108				0 986 473 062		← 57	
	2.2i						0 986 474 062		→ 57	
	1.4i	09.97-08.05	66				0 986 475 143		↔ 19,05	
	1.6i	09.97-08.05	74				0 986 475 143		↔ 19,05	
	1.4i	09.97-08.05	66			BSY	0 986 473 324		← 34	
							0 986 474 324		→ 34	
						LUC	0 986 473 223		← 38,1	
							0 986 474 223		→ 38,1	
	1.6i	09.97-08.00	74			BSY	0 986 473 324		← 34	
							0 986 474 324		→ 34	
		09.00-08.05	74				0 986 473 325		← 36	
							0 986 474 325		→ 36	
						LUC	0 986 474 261		→ 36	
						Fg.-Nr. 4B000001→	LUC	0 986 473 474		← 36
							0 986 474 474		→ 36	
	1.6 Twinport	03.03-08.05	76			Fg.-Nr. →3B999999	LUC	0 986 474 261		→ 36
						Fg.-Nr. 4B000001→	LUC	0 986 473 474		← 36
							0 986 474 474		→ 36	
	1.7 CDTI	03.03-08.05	59				LUC	0 986 473 223		← 38,1
								0 986 474 223		→ 38,1
	1.8i	09.00-08.05	92					0 986 473 326		← 38
								0 986 474 326		→ 38
							LUC	0 986 473 223		← 38,1
								0 986 474 223		→ 38,1
	2.0 Turbo	03.02-08.05	141-147					0 986 473 326		← 38
								0 986 474 326		→ 38
							LUC	0 986 473 223		← 38,1
								0 986 474 223		→ 38,1
	2.2 DTI	03.02-08.05	92				LUC	0 986 473 223		← 38,1
								0 986 474 223		→ 38,1



			S							
2.2 i	09.00-08.05	108						0 986 473 326		← 38
								0 986 474 326		→ 38
							LUC	0 986 473 223		← 38,1
								0 986 474 223		→ 38,1
	1.4 i	09.97-08.05	66			STB		1 987 477 764		1254
						4SB	Fg.-Nr. →22006460, →25003001, →16999999, →28006254, →1B999999	1 987 477 527		1593
						4SB	Fg.-Nr. 22006461→32999999, 25003002→35999999, 26000001→36999999, 28006255→38999999, 2B000001→3B999999	1 987 482 102		1592
						4SB	Fg.-Nr. 42000001→, 45000001→, 46000001→, 48000001→, 4B000001→	1 987 482 537		1587
	1.6 i	09.97-08.05	74/76			STB		1 987 477 764		1254
	1.6 Twinport					4SB	Fg.-Nr. →22006460, →25003001, →16999999, →28006254, →1B999999	1 987 477 527		1593
						4SB	Fg.-Nr. 22006461→32999999, 25003002→35999999, 26000001→36999999, 28006255→38999999, 2B000001→3B999999	1 987 482 102		1592
						4SB	Fg.-Nr. 42000001→, 45000001→, 46000001→, 48000001→, 4B000001→	1 987 482 537		1587
	1.7 CDTI	03.03-08.05	59			STB		1 987 477 764		1254
						4SB	Fg.-Nr. →22006460, →25003001, →16999999, →28006254, →1B999999	1 987 477 527		1593
						4SB	Fg.-Nr. 22006461→32999999, 25003002→35999999, 26000001→36999999, 28006255→38999999, 2B000001→3B999999	1 987 482 102		1592
						4SB	Fg.-Nr. 42000001→, 45000001→, 46000001→, 48000001→, 4B000001→	1 987 482 537		1587
	1.8 i	09.00-08.05	92			STB		1 987 477 764		1254
						4SB	Fg.-Nr. →22006460, →25003001, →16999999, →28006254, →1B999999	1 987 477 527		1593
						4SB	Fg.-Nr. 22006461→32999999, 25003002→35999999, 26000001→36999999, 28006255→38999999, 2B000001→3B999999	1 987 482 102		1592
						4SB	Fg.-Nr. 42000001→, 45000001→, 46000001→, 48000001→, 4B000001→	1 987 482 537		1587
	2.0 Turbo	03.02-08.05	141-147			STB		1 987 477 764		1254
						4SB	Fg.-Nr. →22006460, →25003001, →16999999, →28006254, →1B999999	1 987 477 527		1593

		S							
<b>2.0 Turbo</b>		03.02-08.05	141-147	Fg.-Nr. 22006461→32999999, 4SB 25003002→35999999, 26000001→36999999, 28006255→38999999, 2B000001→3B999999			1 987 <b>482 102</b>		1592
				Fg.-Nr. 42000001→, 4SB 45000001→, 46000001→, 48000001→, 4B000001→			1 987 <b>482 537</b>		1587
<b>2.2 DTI</b>		09.00-08.05	92/108		STB		1 987 <b>477 764</b>		1254
<b>2.2 i</b>				Fg.-Nr. →22006460, 4SB →25003001, →16999999, →28006254, →1B999999			1 987 <b>477 527</b>		1593
				Fg.-Nr. 22006461→32999999, 4SB 25003002→35999999, 26000001→36999999, 28006255→38999999, 2B000001→3B999999			1 987 <b>482 102</b>		1592
				Fg.-Nr. 42000001→, 4SB 45000001→, 46000001→, 48000001→, 4B000001→			1 987 <b>482 537</b>		1587









**Astra Caravan [F]**

<b>1.4 i</b>		09.91-02.98	44				0 986 <b>471 895</b>		48
							0 986 <b>473 895</b>		
							0 986 <b>471 896</b>		48
							0 986 <b>473 896</b>		
		03.92-02.98	60	Fg.-Nr. →T2500013, →T5000073, →T8100000			0 986 <b>471 895</b>		48
							0 986 <b>473 895</b>		
							0 986 <b>471 896</b>		48
							0 986 <b>473 896</b>		
				Fg.-Nr. T2500014→, T5000074→, T8100001→			0 986 <b>471 899</b>		48
							0 986 <b>473 899</b>		
							0 986 <b>473 901</b>		
							0 986 <b>471 900</b>		48
							0 986 <b>473 900</b>		
							0 986 <b>473 902</b>		
		04.96-02.98	66		NOR		0 986 <b>471 899</b>		48
							0 986 <b>473 899</b>		
							0 986 <b>473 901</b>		
							0 986 <b>471 900</b>		48
							0 986 <b>473 900</b>		
							0 986 <b>473 902</b>		
					VEA		0 986 <b>473 905</b>		52
							0 986 <b>473 906</b>		52
<b>1.6 i</b>		09.91-02.98	52/55	Fg.-Nr. →T2500013, →T5000073, →T8100000			0 986 <b>471 895</b>		48
							0 986 <b>473 895</b>		
							0 986 <b>471 896</b>		48
							0 986 <b>473 896</b>		
				Fg.-Nr. T2500014→, T5000074→, T8100001→			0 986 <b>471 899</b>		48
							0 986 <b>473 899</b>		
							0 986 <b>473 901</b>		
							0 986 <b>471 900</b>		48
							0 986 <b>473 900</b>		
							0 986 <b>473 902</b>		
		03.92-02.98	74				0 986 <b>471 899</b>		48
							0 986 <b>473 899</b>		
							0 986 <b>473 901</b>		
							0 986 <b>471 900</b>		48
							0 986 <b>473 900</b>		
							0 986 <b>473 902</b>		

		S								
<b>◀ OPEL Astra Caravan [F]</b>										
	1.6 i	09.94-02.98	74				0986 473 905		← 52	
							0986 473 906		→ 52	
	1.7 D	12.91-02.98	42-44/50/		NOR		0986 471 899		← 48	
							0986 473 899			
	1.7 TD			60				0986 473 901		
								0986 471 900		→ 48
						VEA		0986 473 900		
								0986 473 902		
1.8 i	09.91-02.98	66					0986 471 901		← 48	
							0986 473 901			
		09.93-08.98	82/85/92				0986 473 905		← 52	
	2.0 i	09.91-02.98	85/100/				0986 473 905		← 52	
							0986 473 906		→ 52	
	1.4 i	09.91-02.98	44/60/66				0986 475 143		↔ 19,05	
							0986 475 143		↔ 19,05	
	1.6 i	09.91-02.98	52/55/74					0986 475 143		↔ 19,05
								0986 475 143		↔ 19,05
	1.7 D, TD	12.91-02.98	42-44/50/60					0986 475 143		↔ 19,05
	1.8 i	09.91-08.98	66/82/85/92					0986 475 143		↔ 19,05
2.0 i	09.91-02.98	85/100/110					0986 475 143		↔ 19,05	
	1.4 i	09.91-02.98	44/60/66				0986 473 947		← 35	
							0986 473 948		→ 35	
	1.6 i	09.91-02.98	52/55/74					0986 473 947		← 35
								0986 473 948		→ 35
	1.7 TD	12.91-02.98	50/60					0986 473 947		← 35
								0986 473 948		→ 35
1.8 i	09.91-08.98	66/82/85/	92				0986 473 947		← 35	
							0986 473 948		→ 35	
2.0 i	09.91-02.98	85/100/	110				0986 473 947		← 35	
							0986 473 948		→ 35	
	1.4 i	09.91-02.98	44/60/66				1987 477 258		1398	
							1987 477 258		1398	
	1.6 i	09.91-02.98	52/55/74					1987 477 258		1398
								1987 477 258		1398
	1.7 D, TD	12.91-02.98	42-44/50/60					1987 477 258		1398
	1.8 i	09.91-08.98	66/82/85/92					1987 477 258		1398
2.0 i	09.91-02.98	85					1987 477 258		1398	
	1.4 i	09.91-02.98	44/60/66				0986 594 026 <sup>3</sup>			
							0986 594 026 <sup>3</sup>			
	1.6 i	09.91-02.98	52/55/74					0986 594 026 <sup>3</sup>		
								0986 594 026 <sup>3</sup>		
	1.7 D, TD	12.91-02.98	42-44/50/					0986 594 026 <sup>3</sup>		
	1.8 i	09.91-08.98	66/82/85/92					0986 594 026 <sup>3</sup>		
2.0 i	09.91-02.98	85/100/110					0986 594 026 <sup>3</sup>			
<b>Astra Caravan [G]</b>										
	1.2 i	09.97-09.03	48/55		4SB		0986 473 057		← 52	
							0986 474 057		→ 52	
						STB		0986 473 058		← 48
								0986 474 058		→ 48
	1.4 i	09.97-07.09	66					0986 473 057		← 52
	1.4 Twinport							0986 474 057		→ 52
1.6 i	09.97-06.04	55/62					0986 473 057		← 52	
							0986 474 057		→ 52	

		S								
1.6 i CNG		09.02-06.04	69-73				0 986 473 062		57	1 987 470 005 <sup>7</sup>
							0 986 474 062		57	1 987 470 005 <sup>7</sup>
1.6 i		09.97-07.09	74/76				0 986 473 057		52	
1.6 i Twinport							0 986 474 057		52	
1.7 CDTI, DT, DTI		03.98-07.09	50/55/59				0 986 473 057		52	
							0 986 474 057		52	
1.8 i		ABO 09.97-06.04	85/92				0 986 473 057		52	
							0 986 474 057		52	
		ABS 09.97-06.04	85/92				0 986 473 062		57	1 987 470 005 <sup>7</sup>
							0 986 474 062		57	1 987 470 005 <sup>7</sup>
2.0 DT		ABO 03.98-06.04	60				0 986 473 057		52	
2.0 DTL							0 986 474 057		52	
		ABS 03.98-06.04	60				0 986 473 062		57	1 987 470 005 <sup>7</sup>
							0 986 474 062		57	1 987 470 005 <sup>7</sup>
2.0 DTI, i, Turbo		09.97-06.04	74/100/ 118/141-147				0 986 473 062		57	1 987 470 005 <sup>7</sup>
							0 986 474 062		57	1 987 470 005 <sup>7</sup>
2.2 DTI		09.00-06.04	92/108				0 986 473 062		57	1 987 470 005 <sup>7</sup>
2.2 i							0 986 474 062		57	1 987 470 005 <sup>7</sup>
	1.2 i	09.97-09.03	48/55				0 986 475 143		19,05	
	1.4 i, Twinport	09.97-07.09	66				0 986 475 143		19,05	
	1.6 i, i CNG, i Twinport	09.97-07.09	55/62/69-73/74/76				0 986 475 143		19,05	
	1.7 CDTI, DT, DTI	03.98-07.09	50/55/59				0 986 475 143		19,05	
	2.0 DTI, Turbo	09.00-06.04	74/141-147				0 986 475 143		19,05	
	2.2 DTI, i	09.00-06.04	92/108				0 986 475 143		19,05	
	1.2 i	09.97-09.03	48/55				0 986 473 324		34	
							0 986 474 324		34	
	1.4 i	09.97-07.09	66		BSY		0 986 473 324		34	
	1.4 Twinport						0 986 474 324		34	
	1.6 i	09.97-06.04	55/62		BSY		0 986 473 324		34	
			74		BSY		0 986 474 324		34	
							0 986 474 324		34	
	1.6 i CNG	09.02-06.04	69-73	Fg.-Nr. →42000001, →45000001, →46000001, →48000001			0 986 473 258		38	
							0 986 474 258		38	
				Fg.-Nr. 32000001→32999999, 35000001→35999999, 36000001→ 36999999, 38000001→38999999	LUC		0 986 474 261		36	
	1.6 i Twinport	03.03-07.09	76		LUC		0 986 473 252		34	
				Fg.-Nr. →32999999, →35999999, →36999999, →38999999	LUC		0 986 474 261		36	
	1.7 CDTI	03.03-07.09	59		LUC		0 986 473 252		34	
	1.7 DT	03.98-06.04	50/55		BSY		0 986 473 324		34	
	1.7 DTI						0 986 474 324		34	
					LUC		0 986 473 252		34	
	1.8 i	ABO 09.97-08.00	85				0 986 473 324		34	
							0 986 474 324		34	
		09.00-06.04	92	Fg.-Nr. Y2147600→, Y5154289→, Y6069184→, Y8074628→	BSY		0 986 473 324		34	
							0 986 474 324		34	
		03.01-06.04	85	Fg.-Nr. Y2147600→, Y5154289→, Y6069184→, Y8074628→	BSY		0 986 473 324		34	
							0 986 474 324		34	
		ABS 09.97-08.00	85				0 986 473 325		36	
							0 986 474 325		36	
		09.00-06.04	92	Fg.-Nr. →32999999, →35999999, →36999999, →38999999	LUC		0 986 474 261		36	
				Fg.-Nr. Y2147600→, Y5133295→, Y6069184→, Y8074628→	BSY		0 986 473 325		36	
							0 986 474 325		36	
				Fg.-Nr. 42000001→, 45000001→, 46000001→, 48000001→	LUC		0 986 134 313			
							0 986 135 313			
		03.01-06.04	85		LUC		0 986 474 261		36	

		S										
◀ OPEL Astra Caravan [G]												
1.8 i	ABS	03.01-06.04	85	Fg.-Nr. Y2147600→, Y5133295→, Y6069184→, Y8074628→	BSY	0986 473 325		←	36			
						0986 474 325		→	36			
2.0 DT	ABO	03.98-08.00	60		BSY	0986 473 324		←	34			
						0986 474 324		→	34			
	ABS	03.98-08.00	60		0986 473 325		←	36				
					0986 474 325		→	36				
2.0 DTI		09.00-06.04	74		BSY	0986 473 325		←	36			
						0986 474 325		→	36			
					LUC	0986 474 261		→	36			
2.0 DTL	ABO	09.00-06.04	60	Fg.-Nr. Y2147600→, Y5154289→, Y6069184→, Y8074628→	BSY	0986 473 324		←	34			
						0986 474 324		→	34			
	ABS	09.00-06.04	60		LUC	0986 474 261		→	36			
					BSY	0986 473 325		←	36			
	2.0 i		09.97-06.04	100	Fg.-Nr. Y2147600→, Y5133295→, Y6069184→, Y8074628→	BSY	0986 473 325		←	36		
							0986 474 325		→	36		
LUC						0986 473 252		←	34			
						Fg.-Nr. →22999999, →25999999, →26999999, →28999999	LUC	0986 474 261		→	36	
						Fg.-Nr. 32000001→32999999, 35000001→35999999, 36000001→36999999, 38000001→38999999	LUC	0986 474 261		→	36	
						Fg.-Nr. 42000001→, 45000001→, 46000001→, 48000001→	LUC	0986 134 313		←		
				LUC	0986 135 313		→					
		10.99-09.02	118		LUC	0986 473 252		←	34			
				Fg.-Nr. →Y2147599, →Y5151036, →Y6069183, →Y0874627	BSY	0986 473 326		←	38			
						0986 474 326		→	38			
2.0 Turbo		09.01-06.04	141-147		LUC	0986 473 223		←	38,1			
						0986 474 223		→	38,1			
						Fg.-Nr. →42000001, →45000001, →46000001, →48000001	LUC	0986 473 258		←	38	
								0986 474 258		→	38	
						Fg.-Nr. 32000001→32999999, 35000001→35999999, 36000001→36999999, 38000001→38999999	LUC	0986 474 261		→	36	
2.2 DTI		09.01-06.04	92	Fg.-Nr. 32000001→, 35000001→, 36000001→, 38000001→	LUC	0986 473 261		←	36			
						0986 474 261		→	36			
2.2 i		09.00-06.04	108		BSY	0986 473 325		←	36			
						0986 474 325		→	36			
					LUC	0986 474 261		→	36			
1.2 i		09.97-09.03	48		STB	1987 477 764			1254			
					4SB	1987 477 527			1593			
		09.00-09.03	55		STB	1987 477 764			1254			
					4SB	1987 477 527			1593			
							Fg.-Nr. →22006460, →25003001, →16999999, →28006254, →1B999999	4SB	1987 482 102			1592
							Fg.-Nr. 22006461→, 25003002→, 26000001→, 28006255→, 2B000001→	4SB	1987 482 102			1592
1.4 i, Twinport		09.97-07.09	66		STB	1987 477 764			1254			
					4SB	1987 477 527			1593			
							Fg.-Nr. →22006460, →25003001, →16999999, →28006254, →1B999999	4SB	1987 482 102			1592
							Fg.-Nr. 22006461→32999999, 25003002→35999999, 26000001→36999999, 28006255→38999999, 2B000001→3B999999	4SB	1987 482 102			1592
							Fg.-Nr. 42000001→, 45000001→, 46000001→, 48000001→, 4B000001→	4SB	1987 482 537			1587

										
<b>1.6 i</b>	09.97-06.04	55/62		STB			1 987 <b>477 764</b>	1254		
			Fg.-Nr. →22006460, →25003001, →16999999, →28006254, →1B999999	4 SB			1 987 <b>477 527</b>	1593		
			Fg.-Nr. 22006461→32999999, 25003002→35999999, 26000001→36999999, 28006255→38999999, 2B000001→3B999999	4SB			1 987 <b>482 102</b>	1592		
			Fg.-Nr. 42000001→, 45000001→, 46000001→, 48000001→, 4B000001→	4SB			1 987 <b>482 537</b>	1587		
74				STB			1 987 <b>477 764</b>	1254		
			Fg.-Nr. →22006460, →25003001, →16999999, →28006254, →1B999999	4SB			1 987 <b>477 527</b>	1593		
			Fg.-Nr. 22006461→32999999, 25003002→35999999, 26000001→36999999, 28006255→38999999, 2B000001→3B999999	4SB			1 987 <b>482 102</b>	1592		
			Fg.-Nr. 42000001→, 45000001→, 46000001→, 48000001→, 4B000001→	4SB			1 987 <b>482 537</b>	1587		
<b>1.6 i CNG</b>	09.02-06.04	69-73		STB			1 987 <b>477 764</b>	1254		
				4SB			1 987 <b>477 527</b>	1593		
<b>1.6 i Twinport</b>	03.03-07.09	76		STB			1 987 <b>477 764</b>	1254		
				4SB			1 987 <b>477 527</b>	1593		
<b>1.7 CDTI</b>	03.03-07.09	59	Fg.-Nr. →22006460, →25003001, →16999999, →28006254, →1B999999	4SB			1 987 <b>477 527</b>	1593		
<b>1.7 DT, DTI</b>	03.98-06.04	50/55		STB			1 987 <b>477 764</b>	1254		
			Fg.-Nr. →X2240264, →X6125306, →X8116202	4SB			1 987 <b>477 767</b>	1577		
			Fg.-Nr. X2240265→, X6125307→, X8116203→	4SB			1 987 <b>477 527</b>	1593		
<b>1.8 i</b>	09.97-08.00	85		STB			1 987 <b>477 764</b>	1254		
				4SB			1 987 <b>477 527</b>	1593		
	09.00-06.04	92		STB				1 987 <b>477 764</b>	1254	
			Fg.-Nr. →22006460, →25003001, →16999999, →28006254, →1B999999	4SB			1 987 <b>477 527</b>	1593		
			Fg.-Nr. 22006461→32999999, 25003002→35999999, 26000001→36999999, 28006255→38999999, 2B000001→3B999999	4SB			1 987 <b>482 102</b>	1592		
			Fg.-Nr. 42000001→, 45000001→, 46000001→, 48000001→, 4B000001→	4SB			1 987 <b>482 537</b>	1587		
<b>2.0 DT</b>	03.98-08.00	60		4SB			1 987 <b>477 527</b>	1593		





		S							
<b>◀ OPEL Astra Caravan [G]</b>									
2.0 DT		03.98-06.04	60			STB	1987 477 764	1254	
2.0 DTL									
2.0 DTI		09.00-06.04	74			STB	1987 477 764	1254	
				Fg.-Nr. →22006460, →25003001, →16999999, →28006254, →1B999999		4SB	1987 477 527	1593	
2.0 DTL		09.00-06.04	60			4SB	1987 477 527	1593	
				Fg.-Nr. →22006460, →25003001, →16999999, →28006254, →1B999999					
2.0 i		09.97-06.04	100			STB	1987 477 764	1254	
				Fg.-Nr. →22006460, →25003001, →16999999, →28006254, →1B999999		4SB	1987 477 527	1593	
				Fg.-Nr. 22006461→32999999, 25003002→35999999, 26000001→36999999, 28006255→38999999, 2B000001→3B999999		4SB	1987 482 102	1592	
				Fg.-Nr. 42000001→, 45000001→, 46000001→, 48000001→, 4B000001→		4SB	1987 482 537	1587	
		10.99-09.02	118			STB	1987 477 764	1254	
						4SB	1987 477 527	1593	
2.0 Turbo		09.01-06.04	141-147			STB	1987 477 764	1254	
				Fg.-Nr. →22006460, →25003001, →16999999, →28006254, →1B999999		4SB	1987 477 527	1593	
				Fg.-Nr. 22006461→32999999, 25003002→35999999, 26000001→36999999, 28006255→38999999, 2B000001→3B999999		4SB	1987 482 102	1592	
				Fg.-Nr. 42000001→, 45000001→, 46000001→, 48000001→, 4B000001→		4SB	1987 482 537	1587	
2.2 DTI		09.01-06.04	92			STB	1987 477 764	1254	
				Fg.-Nr. →22006460, →25003001, →16999999, →28006254, →1B999999		4SB	1987 477 527	1593	
2.2 i		09.00-06.04	108			STB	1987 477 764	1254	
				Fg.-Nr. →22006460, →25003001, →16999999, →28006254, →1B999999		4SB	1987 477 527	1593	
				Fg.-Nr. 22006461→32999999, 25003002→35999999, 26000001→36999999, 28006255→38999999, 2B000001→3B999999		4SB	1987 482 102	1592	
				Fg.-Nr. 42000001→, 45000001→, 46000001→, 48000001→, 4B000001→		4SB	1987 482 537	1587	
<b>Astra Caravan [H]</b>									
1.2 Twinport		03.07-03.09	59				0986 473 062	← 57	1987 470 005 <sup>7</sup>
							0986 474 062	→ 57	1987 470 005 <sup>7</sup>
1.3 CDTI		08.05-03.10	66			SBJ	0986 473 062	← 57	1987 470 005 <sup>7</sup>
							0986 474 062	→ 57	1987 470 005 <sup>7</sup>
1.4		08.04-03.10	55/66				0986 473 062	← 57	1987 470 005 <sup>7</sup>
1.4 Twinport							0986 474 062	→ 57	1987 470 005 <sup>7</sup>
1.6		03.07-03.10	85				0986 473 062	← 57	1987 470 005 <sup>7</sup>
							0986 474 062	→ 57	1987 470 005 <sup>7</sup>

		S								
<b>1.6</b>		01.11→	85			SBJ	0 986 473 062		← 57	1 987 470 005 <sup>7</sup>
							0 986 474 062		→ 57	1 987 470 005 <sup>7</sup>
<b>1.6</b> Twinport		08.04-03.07	77				0 986 473 062		← 57	1 987 470 005 <sup>7</sup>
							0 986 474 062		→ 57	1 987 470 005 <sup>7</sup>
		09.07-03.09	77				0 986 473 062		← 57	1 987 470 005 <sup>7</sup>
							0 986 474 062		→ 57	1 987 470 005 <sup>7</sup>
<b>1.7</b> CDTI		08.04-03.07	59/74				0 986 473 062		← 57	1 987 470 005 <sup>7</sup>
							0 986 474 062		→ 57	1 987 470 005 <sup>7</sup>
		02.07-03.10	81/92				0 986 473 062		← 57	1 987 470 005 <sup>7</sup>
							0 986 474 062		→ 57	1 987 470 005 <sup>7</sup>
		02.07→	81/92			SBJ	0 986 473 062		← 57	1 987 470 005 <sup>7</sup>
							0 986 474 062		→ 57	1 987 470 005 <sup>7</sup>
<b>1.8</b> i		08.04-02.09	92				0 986 473 062		← 57	1 987 470 005 <sup>7</sup>
							0 986 474 062		→ 57	1 987 470 005 <sup>7</sup>
		08.05-03.10	103			SBJ	0 986 473 062		← 57	1 987 470 005 <sup>7</sup>
							0 986 474 062		→ 57	1 987 470 005 <sup>7</sup>
		01.11→	103			SBJ	0 986 473 062		← 57	1 987 470 005 <sup>7</sup>
							0 986 474 062		→ 57	1 987 470 005 <sup>7</sup>
<b>1.9</b> CDTI		09.04-03.10	88/110				0 986 473 062		← 57	1 987 470 005 <sup>7</sup>
							0 986 474 062		→ 57	1 987 470 005 <sup>7</sup>
		09.05-07.10	74			SBJ	0 986 473 062		← 57	1 987 470 005 <sup>7</sup>
							0 986 474 062		→ 57	1 987 470 005 <sup>7</sup>
<b>2.0</b> Turbo		08.04-03.10	125/147/ 177				0 986 473 062		← 57	1 987 470 005 <sup>7</sup>
							0 986 474 062		→ 57	1 987 470 005 <sup>7</sup>
	<b>1.2</b> Twinport	03.07-03.09	59				0 986 475 869		↔ 20,64	
	<b>1.3</b> CDTI	08.05-03.10	66				0 986 475 869		↔ 20,64	
	<b>1.6</b>	03.07-03.10	85			TW	0 986 475 869		↔ 20,64	
							0 986 475 949		↔ 19,05	
		01.11→	85				0 986 475 949		↔ 19,05	
	<b>1.6</b> Twinport	08.04-03.07	77			TW	0 986 475 869		↔ 20,64	
							0 986 475 949		↔ 19,05	
	<b>1.7</b> CDTI	08.04→	74/81			TW	0 986 475 869		↔ 20,64	
							0 986 475 949		↔ 19,05	
		03.10→	92				0 986 475 949		↔ 19,05	
	<b>1.8</b> i	08.04-02.09	92			TW	0 986 475 869		↔ 20,64	
							0 986 475 949		↔ 19,05	
		08.05-03.10	103				0 986 475 869		↔ 20,64	
		01.11→	103				0 986 475 949		↔ 19,05	
	<b>1.9</b> CDTI	09.04-03.10	88/110				0 986 475 869		↔ 20,64	
		09.05-07.10	74				0 986 475 869		↔ 20,64	
							Fg.-Nr. →72999999, →75999999, →78999999, →7G999999			
							Fg.-Nr. 82000001→, 85000001→, 88000001→, 8G000001→			
							0 986 475 949		↔ 19,05	
	<b>1.2</b> Twinport	03.07-03.09	59			4LO	0 986 473 474		← 36	
							0 986 474 474		→ 36	
						5LO	0 986 473 258		← 38	
							0 986 474 258		→ 38	
	<b>1.3</b> CDTI	08.05-03.10	66			4LO	0 986 473 474		← 36	
							0 986 474 474		→ 36	
						5LO	0 986 473 258		← 38	
							0 986 474 258		→ 38	
	<b>1.4</b>	08.04-03.10	55/66			4LO	0 986 473 474		← 36	
	<b>1.4</b> Twinport						0 986 474 474		→ 36	
						5LO	0 986 473 258		← 38	
							0 986 474 258		→ 38	
	<b>1.6</b>	03.07-03.10	85			4LO	0 986 473 474		← 36	
							0 986 474 474		→ 36	
						5LO	0 986 473 258		← 38	
							0 986 474 258		→ 38	



◀ OPEL Astra Caravan [H]									
1.6	01.11→	85	SBJ	0986 473 258	← 38				
				0986 474 258	→ 38				
1.6 Turbo	09.07-03.10	132	4LO	0986 473 474	← 36				
				0986 474 474	→ 36				
			5LO	0986 473 258	← 38				
				0986 474 258	→ 38				
1.6 Twinport	08.04-03.07	77	4LO	0986 473 474	← 36				
				0986 474 474	→ 36				
			5LO	0986 473 258	← 38				
				0986 474 258	→ 38				
	09.07-03.09	77	4LO	0986 473 474	← 36				
				0986 474 474	→ 36				
			5LO	0986 473 258	← 38				
				0986 474 258	→ 38				
1.7 CDTI	08.04-03.07	59/74	4LO	0986 473 474	← 36				
				0986 474 474	→ 36				
			5LO	0986 473 258	← 38				
				0986 474 258	→ 38				
	02.07-03.10	81/92	4LO	0986 473 474	← 36				
				0986 474 474	→ 36				
			5LO	0986 473 258	← 38				
				0986 474 258	→ 38				
	02.07→	81/92	4LO,SBJ	0986 473 474	← 36				
				0986 474 474	→ 36				
			5LO,SBJ	0986 473 258	← 38				
				0986 474 258	→ 38				
1.8 i	08.04-02.09	92	4LO	0986 473 474	← 36				
				0986 474 474	→ 36				
			5LO	0986 473 258	← 38				
				0986 474 258	→ 38				
	08.05-03.10	103	4LO	0986 473 474	← 36				
				0986 474 474	→ 36				
			5LO	0986 473 258	← 38				
				0986 474 258	→ 38				
	01.11→	103	SBJ	0986 473 258	← 38				
				0986 474 258	→ 38				
			4LO	0986 473 474	← 36				
				0986 474 474	→ 36				
1.9 CDTI	09.04-03.10	88/110	4LO	0986 473 474	← 36				
				0986 474 474	→ 36				
			5LO	0986 473 258	← 38				
				0986 474 258	→ 38				
	09.05-07.10	74	4LO,SBJ	0986 473 474	← 36				
				0986 474 474	→ 36				
			5LO,SBJ	0986 473 258	← 38				
				0986 474 258	→ 38				
08.04-03.10	125/147/ 177	4LO	0986 473 474	← 36					
			0986 474 474	→ 36					
		5LO	0986 473 258	← 38					
			0986 474 258	→ 38					

1.2 Twinport	03.07-03.09	59	STB	1987 477 908	1326				
			4SB	1987 477 934	1760				
1.3 CDTI	08.05-03.10	66	STB	1987 477 908	1326				
			4SB	1987 477 934	1760				
1.4	08.04-03.10	55/66	STB	1987 477 908	1326				
1.4 Twinport			4SB	1987 477 934	1760				
1.6	03.07-03.10	85	STB	1987 477 908	1326				
			4SB	1987 477 934	1760				
	01.11→	85	STB	1987 477 908	1326				
			STB,TW	1987 482 382	187				
				1987 482 449	182				
			4SB	1987 477 934	1760				

		S									
<b>1.6 Turbo</b>	09.07-03.10	132					STB	1 987 477 908	1326		
							4SB	1 987 477 934	1760		
<b>1.6 Twinport</b>	08.04-03.07	77					STB	1 987 477 908	1326		
							4SB	1 987 477 934	1760		
	09.07-03.09	77					STB	1 987 477 908	1326		
							4SB	1 987 477 934	1760		
<b>1.7 CDTI</b>	08.04-09.05	59					STB	1 987 477 908	1326		
							4SB	1 987 477 934	1760		
	08.04-03.07	74						STB	1 987 477 908	1326	
								STB,TW	1 987 482 382	187	
									1 987 482 449	182	
								4SB	1 987 477 934	1760	
	02.07-03.10	81						4SB	1 987 477 934	1760	
	02.07→	81						STB	1 987 477 908	1326	
								STB,TW	1 987 482 382	187	
								1 987 482 449	182		
							4SB,TW	1 987 477 934	1760		
							STB	1 987 477 908	1326		
03.10→	92						STB	1 987 482 382	187		
							4SB,TW	1 987 477 934	1760		
<b>1.8 i</b>	08.04-02.09	92					STB	1 987 477 908	1326		
							4SB	1 987 477 934	1760		
	08.05-03.10	103						STB	1 987 477 908	1326	
								4SB	1 987 477 909	1665	
								Fg.-Nr. 82→, 85→, 88→, 8G→	STB	1 987 482 382	187
	01.11→	103						STB	1 987 477 908	1326	
								STB,TW	1 987 482 382	187	
								1 987 482 449	182		
							4SB	1 987 477 934	1760		
<b>1.9 CDTI</b>	09.04-03.10	88/110					STB	1 987 477 908	1326		
							4SB	1 987 477 934	1760		
	09.05-07.10	74						STB	1 987 477 908	1326	
								STB,TW	1 987 482 382	187	
								1 987 482 449	182		
							4SB,TW	1 987 477 934	1760		
<b>2.0 Turbo</b>	08.04-03.10	125/147/ 177					STB	1 987 477 908	1326		
							4SB	1 987 477 934	1760		

**Astra Classic Caravan [F]**

	<b>1.4 i</b>	09.97-08.02	44					0 986 471 895	← 48								
								0 986 473 895									
								0 986 471 896	→ 48								
								0 986 473 896									
	<b>1.6 i</b>	09.97-08.02	55					0 986 471 899	← 48								
								0 986 473 899									
								0 986 473 901									
								0 986 471 900	→ 48								
								0 986 473 900									
								0 986 473 902									
								74							ATE	0 986 473 905	← 52
																0 986 473 906	→ 52
	<b>1.4 i</b>	09.97-08.02	44					0 986 475 143	↔ 19,05								
	<b>1.6 i</b>	09.97-08.02	55/74					0 986 475 143	↔ 19,05								
	<b>1.4 i</b>	09.97-08.02	44					0 986 473 947	← 35								
								0 986 473 948	→ 35								















		S							
◀ OPEL Astra Classic Caravan [F]									
	1.4 i	09.97-08.02	44				1987 477 258	1398	
	1.6 i	09.97-08.02	55/74				1987 477 258	1398	
	1.4 i	09.97-08.02	44				0986 594 026 <sup>3</sup>		
	1.6 i	09.97-08.02	55/74				0986 594 026 <sup>3</sup>		
<b>Astra Classic [F]</b>									
	1.4 i	09.97-08.02	44				0986 471 895	← 48	
							0986 473 895	↻	
							0986 471 896	→ 48	
							0986 473 896	↻	
	1.6 i	09.97-08.02	55				0986 471 899	← 48	
							0986 473 899	↻	
							0986 473 901	↻	
							0986 471 900	→ 48	
							0986 473 900	↻	
							0986 473 902	↻	
			74			ATE	0986 473 905	↻ ← 52	
							0986 473 906	↻ → 52	
	1.4 i	09.97-08.02	44				0986 475 143	↔ 19,05	
	1.6 i	09.97-08.02	55/74				0986 475 143	↔ 19,05	
	1.4 i	09.97-08.02	44				1987 477 129	1690	
	1.6 i	09.97-08.02	55/74				1987 477 129	1690	
	1.4 i	09.97-08.02	44				0986 594 026 <sup>3</sup>		
	1.6 i	09.97-08.02	55/74				0986 594 026 <sup>3</sup>		
<b>Astra Coupé [G]</b>									
	1.6 Twinport	03.03-02.05	76				0986 473 062	↻ ← 57	1987 470 005 <sup>7</sup>
							0986 474 062	↻ → 57	1987 470 005 <sup>7</sup>
	1.7 CDTI	03.03-02.05	59				0986 473 062	↻ ← 57	1987 470 005 <sup>7</sup>
							0986 474 062	↻ → 57	1987 470 005 <sup>7</sup>
	1.8 i	09.97-02.05	85/92				0986 473 062	↻ ← 57	1987 470 005 <sup>7</sup>
							0986 474 062	↻ → 57	1987 470 005 <sup>7</sup>
	2.0 Turbo	09.00-02.05	141-147				0986 473 062	↻ ← 57	1987 470 005 <sup>7</sup>
							0986 474 062	↻ → 57	1987 470 005 <sup>7</sup>
	2.2 DTI	09.00-02.05	92/108				0986 473 062	↻ ← 57	1987 470 005 <sup>7</sup>
	2.2 i						0986 474 062	↻ → 57	1987 470 005 <sup>7</sup>
	1.6 Twinport	03.03-02.05	76			BSY	0986 473 326	↻ ← 38	
							0986 474 326	↻ → 38	
						Fg.-Nr. →34999999	LUC	0986 473 223	↻ ← 38,1
								0986 474 223	↻ → 38,1
						Fg.-Nr. 4B000001→	LUC	0986 473 258	↻ ← 38
								0986 474 258	↻ → 38
	1.7 CDTI	03.03-02.05	59			LUC	0986 473 223	↻ ← 38,1	
								0986 474 223	↻ → 38,1

		S							
1.8i		09.97-02.05	85/92						
							0 986 473 326		← 38
							0 986 474 326		→ 38
						LUC	0 986 473 223		← 38,1
							0 986 474 223		→ 38,1
2.0 Turbo		09.00-02.05	141-147				0 986 473 326		← 38
							0 986 474 326		→ 38
						LUC	0 986 473 223		← 38,1
							0 986 474 223		→ 38,1
2.2 DTI		03.02-02.05	92			LUC	0 986 473 223		← 38,1
							0 986 474 223		→ 38,1
2.2i		09.00-02.05	108				0 986 473 326		← 38
							0 986 474 326		→ 38
						LUC	0 986 473 223		← 38,1
							0 986 474 223		→ 38,1

1.6 Twinport		03.03-02.05	76				1 987 482 537		1587
1.7 CDTI		03.03-02.05	59	Fg.-Nr. →22006460, →25003001, →16999999, →28006254, →1B999999			1 987 477 527		1593
1.8i		09.97-08.00	85		STB		1 987 477 764		1254
		09.00-02.05	92		STB		1 987 477 764		1254
				Fg.-Nr. →22006460, →25003001, →16999999, →28006254, →1B999999	4SB		1 987 477 527		1593
				Fg.-Nr. 22006461→32999999, 4SB 25003002→35999999, 26000001→36999999, 28006255→38999999, 2B000001→3B999999			1 987 482 102		1592
				Fg.-Nr. 42000001→, 45000001→, 46000001→, 48000001→, 4B000001→	4SB		1 987 482 537		1587
		03.01-02.05	85	Fg.-Nr. →22006460, →25003001, →16999999, →28006254, →1B999999			1 987 477 527		1593
2.0 Turbo		09.00-02.05	141-147		STB		1 987 477 764		1254
				Fg.-Nr. →22006460, →25003001, →16999999, →28006254, →1B999999			1 987 477 527		1593
2.2 DTI		03.02-02.05	92		STB		1 987 477 764		1254
				Fg.-Nr. →22006460, →25003001, →16999999, →28006254, →1B999999			1 987 477 527		1593
2.2i		09.00-02.05	108	Fg.-Nr. →22006460, →25003001, →16999999, →28006254, →1B999999			1 987 477 527		1593







































<b>Astra [F]</b>									
1.4i		09.91-02.98	44				0 986 471 895		← 48
							0 986 473 895		
							0 986 471 896		→ 48
							0 986 473 896		
		03.92-02.98	60		LIM,VEA		0 986 473 905		← 52
							0 986 473 906		→ 52
				Fg.-Nr. →T2500013, →T5000073, →T8100000			0 986 471 895		← 48
							0 986 473 895		
							0 986 471 896		→ 48
							0 986 473 896		

		S								
◀ OPEL Astra [F]										
1.4 i	03.92-02.98	60	Fg.-Nr. T2500014→, T5000074→, T8100001→	0986 471 899	← 48					
				0986 473 899						
				0986 473 901						
				0986 471 900	→ 48					
				0986 473 900						
	04.96-02.98	66	NOR	0986 471 899	← 48					
				0986 473 899						
				0986 473 901						
				0986 471 900	→ 48					
				0986 473 900						
VEA	0986 473 902									
	0986 473 905	← 52								
				0986 473 906	→ 52					
1.6 i	09.91-02.98	52/55/74	Fg.-Nr. →T2500013, →T5000073, →T8100000	0986 471 895	← 48					
				0986 473 895						
				0986 471 896	→ 48					
				0986 473 896						
				0986 471 899	← 48					
	09.94-02.98	74	VEA	0986 473 899						
				0986 473 901						
				0986 471 900	→ 48					
				0986 473 900						
				0986 473 902						
VEA	0986 473 905	← 52								
	0986 473 906	→ 52								
1.7 D 1.7 TD	12.91-02.98	42-44/50/ 60	NOR	0986 471 899	← 48					
				0986 473 899						
				0986 473 901						
				0986 471 900	→ 48					
				0986 473 900						
	VEA	0986 473 902								
		0986 473 905	← 52							
		0986 473 906	→ 52							
		0986 471 901	← 48							
		0986 473 901								
1.8 i	09.91-02.98	66	VEA	0986 471 901	← 48					
				0986 473 901						
				0986 471 902	→ 48					
				0986 473 902						
				0986 473 905	← 52					
	09.93-08.98	82/85/92	0986 473 906	→ 52						
			0986 471 901	← 48						
			0986 473 901							
			0986 471 902	→ 48						
			0986 473 902							
2.0 i	09.91-02.98	85/100/ 110	VEA	0986 473 905	← 52					
				0986 473 906	→ 52					
				0986 471 901	← 48					
				0986 473 901						
				0986 471 902	→ 48					
	09.92-02.96	52	0986 473 905	← 52						
			0986 473 906	→ 52						
			0986 471 901	← 48						
			0986 473 901							
			0986 471 902	→ 48						
1.4 i	09.91-02.98	44/60	Fg.-Nr. →P2999999, →P3999999, →P4999999, →P5999999, →P6999999, →P8999999	0986 475 143	↔ 19,05					
				0986 475 032	↔ 17,46					
				0986 475 143	↔ 19,05					
				0986 475 143	↔ 19,05					
				0986 475 032	↔ 17,46					
	04.96-02.98	66	0986 475 143	↔ 19,05						
			0986 475 143	↔ 19,05						
			0986 475 032	↔ 17,46						
			0986 475 143	↔ 19,05						
			0986 475 032	↔ 17,46						
09.92-02.96	52	0986 475 143	↔ 19,05							
		0986 475 143	↔ 19,05							
		0986 475 032	↔ 17,46							
		0986 475 143	↔ 19,05							
		0986 475 032	↔ 17,46							
12.91-08.94	42-44	Fg.-Nr. →P2999999, →P3999999, →P4999999, →P5999999, →P6999999, →P8999999	0986 475 143	↔ 19,05						
			0986 475 143	↔ 19,05						
			0986 475 032	↔ 17,46						
			0986 475 143	↔ 19,05						
			0986 475 032	↔ 17,46						

		S							
1.7 TD		12.91-02.98	60				0 986 475 143	↔ 19,05	
						Fg.-Nr. →P2999999, →P3999999, →P4999999, →P5999999, →P6999999, →P8999999	0 986 475 032	↔ 17,46	
		09.94-02.98	50				0 986 475 143	↔ 19,05	
1.8 i		09.91-08.98	66/82/85/92				0 986 475 143	↔ 19,05	
2.0 i		09.91-02.98	85				0 986 475 143	↔ 19,05	
						Fg.-Nr. →P2999999, →P3999999, →P4999999, →P5999999, →P6999999, →P8999999	0 986 475 032	↔ 17,46	
 1.4 i		03.92-02.98	60/66				0 986 473 947	↔ ← 35	
							0 986 473 948	↔ → 35	
1.6 i		03.92-02.98	74				0 986 473 947	↔ ← 35	
							0 986 473 948	↔ → 35	
1.7 TD		09.94-02.98	50				0 986 473 947	↔ ← 35	
							0 986 473 948	↔ → 35	
1.8 i		09.91-08.98	66/85/92				0 986 473 947	↔ ← 35	
							0 986 473 948	↔ → 35	
2.0 i		09.91-02.98	85/100/ 110				0 986 473 947	↔ ← 35	
							0 986 473 948	↔ → 35	
									
 1.4 i		09.91-02.98	44/60/66		HTB		1 987 477 129	1690	
					4SB		1 987 477 766	1575	
1.6 i		09.91-02.98	52/55/74		HTB		1 987 477 129	1690	
					4SB		1 987 477 766	1575	
1.7 D		12.91-02.98	42-44/50/		HTB		1 987 477 129	1690	
1.7 TD			60		4SB		1 987 477 766	1575	
1.8 i		09.91-08.98	66/82/85/ 92		HTB		1 987 477 129	1690	
					4SB		1 987 477 766	1575	
2.0 i		09.91-02.98	85/100/ 110		HTB		1 987 477 129	1690	
					4SB		1 987 477 766	1575	
 1.4 i		09.91-02.98	44/60/66				0 986 594 026 <sup>3</sup>		
1.6 i		09.91-02.98	52/55/74				0 986 594 026 <sup>3</sup>		
1.7 D, TD		12.91-02.98	42-44/50/60				0 986 594 026 <sup>3</sup>		
1.8 i		09.91-08.98	66/85/92				0 986 594 026 <sup>3</sup>		
2.0 i		09.91-02.98	85/100/110				0 986 594 026 <sup>3</sup>		
<b>Astra [G]</b>									
									
 1.2 i		09.97-09.03	48		4SB		0 986 473 057	↔ ← 52	
							0 986 474 057	↔ → 52	
						Fg.-Nr. →12999999, STB →15999999, →16999999, →18999999	0 986 473 058	↔ ← 48	
							0 986 474 058	↔ → 48	
1.4 i		09.97-01.04	66				0 986 473 057	↔ ← 52	
							0 986 474 057	↔ → 52	
1.6 i		09.97-01.04	74				0 986 473 057	↔ ← 52	
							0 986 474 057	↔ → 52	
		09.97-01.05	55/62				0 986 473 057	↔ ← 52	
							0 986 474 057	↔ → 52	
		10.99-12.05	74				0 986 473 062	↔ ← 57	
							0 986 474 062	↔ → 57	
1.6 i Twinport		03.03-07.09	76				0 986 473 057	↔ ← 52	
							0 986 474 057	↔ → 52	
1.7 CDTI, DT, DTI		03.98-01.04	50/55/59				0 986 473 057	↔ ← 52	
							0 986 474 057	↔ → 52	











<b>◀ OPEL Astra [G]</b>								
1.8 i		10.99-12.05	85/92				0986 473 062	☞ ← 57
							0986 474 062	☞ → 57
ABO		09.97-01.04	85/92				0986 473 057	☞ ← 52
							0986 474 057	☞ → 52
ABS		09.97-01.04	85/92				0986 473 062	☞ ← 57
							1987 470 0057	
2.0 DT	ABO	03.98-01.04	60				0986 473 057	☞ ← 52
							0986 474 057	☞ → 52
2.0 DTL	ABS	03.98-01.04	60				0986 473 062	☞ ← 57
							1987 470 0057	
2.0 DTI		09.99-01.05	74				0986 473 062	☞ ← 57
							1987 470 0057	
2.0 i		09.97-01.04	100				0986 473 062	☞ ← 57
							1987 470 0057	
2.0 i		10.99-12.01	100				0986 473 062	☞ ← 57
							1987 470 0057	
2.0 i		10.99-02.04	118/ 141-147				0986 473 062	☞ ← 57
							1987 470 0057	
2.0 Turbo							0986 474 062	☞ → 57
2.2 DTI		09.00-01.04	92/108				0986 473 062	☞ ← 57
2.2 i							0986 474 062	☞ → 57
1.2 i		09.97-09.03	48/55				0986 475 143	↔ 19,05
							0986 475 143	↔ 19,05
1.4 i, Twinport		09.97-06.09	66				0986 475 143	↔ 19,05
1.6 i, i Twinport		09.97-07.09	55/62/74/76				0986 475 143	↔ 19,05
1.7 CDTI, DT, DTI		03.98-01.04	50/55/59				0986 475 143	↔ 19,05
2.0 DTI, Turbo		09.99-01.05	74/141-147				0986 475 143	↔ 19,05
2.2 DTI, i		09.00-01.04	92/108				0986 475 143	↔ 19,05
1.2 i		09.97-09.03	48				0986 473 324	☞ ← 34
							0986 474 324	☞ → 34
		09.00-09.03	55				0986 473 324	☞ ← 34
							0986 474 324	☞ → 34
	LUC						0986 473 252	☞ ← 34
1.4 i		09.97-01.04	66			BSY	0986 473 324	☞ ← 34
							0986 474 324	☞ → 34
1.4 Twinport		09.03-06.09	66				0986 134 313	☞ ←
							0986 135 313	☞ →
1.6 i		09.97-01.04	74			BSY	0986 473 324	☞ ← 34
							0986 474 324	☞ → 34
		09.97-01.05	55/62			BSY	0986 473 324	☞ ← 34
							0986 474 324	☞ → 34
		10.99-12.05	74				0986 473 325	☞ ← 36
							0986 474 325	☞ → 36
1.6 i Twinport		03.03-07.09	76			LUC	0986 473 252	☞ ← 34
							0986 474 261	☞ → 36
							Fg.-Nr. →32999999, →35999999, →36999999, →38999999	
1.7 CDTI		03.03-01.04	59			LUC	0986 473 252	☞ ← 34
1.7 DT		03.98-01.04	50/55			BSY	0986 473 324	☞ ← 34
1.7 DTI							0986 474 324	☞ → 34
							0986 473 252	☞ ← 34
1.8 i		10.99-12.02	85				0986 473 325	☞ ← 36
							0986 474 325	☞ → 36
ABO		09.97-08.00	85				0986 473 324	☞ ← 34
							0986 474 324	☞ → 34
		09.00-01.04	92			BSY	0986 473 324	☞ ← 34
							0986 474 324	☞ → 34
		03.01-01.04	85			BSY	0986 473 324	☞ ← 34
							0986 474 324	☞ → 34
ABS		09.97-08.00	85				0986 473 325	☞ ← 36
							0986 474 325	☞ → 36

		S				?				
1.8i	ABS	09.00-01.04	92	Fg.-Nr. →32999999, →35999999, →36999999, →38999999	LUC	0 986 474 261		→	36	
					BSY	0 986 473 325		←	36	
		03.01-01.04	85	Fg.-Nr. Y2147600→, Y5133295→, Y6069184→, Y8074628→	LUC	0 986 474 261		→	36	
					BSY	0 986 473 325		←	36	
		01.03-12.05	92	Fg.-Nr. Y8074628→	LUC	0 986 473 325		←	36	
					BSY	0 986 474 325		→	36	
2.0DT	ABO	03.98-08.00	60		LUC	0 986 473 324		←	34	
	ABS	03.98-08.00	60		LUC	0 986 474 324		→	34	
2.0DTI		09.99-01.05	74		BSY	0 986 473 325		←	36	
					LUC	0 986 474 325		→	36	
2.0DTL	ABO	09.00-01.04	60	Fg.-Nr. Y2147600→, Y5154289→, Y6069184→, Y8074628→	BSY	0 986 473 324		←	34	
					LUC	0 986 474 324		→	34	
	ABS	09.00-01.04	60	Fg.-Nr. Y2147600→, Y5133295→, Y6069184→, Y8074628→	LUC	0 986 474 261		→	36	
					BSY	0 986 473 325		←	36	
2.0i		09.97-01.04	100	Fg.-Nr. →22999999, →25999999, →26999999, →28999999	BSY	0 986 473 325		←	36	
					LUC	0 986 473 252		←	34	
					LUC	0 986 474 261		→	36	
					LUC	0 986 134 313		←		
		10.99-09.02	118	Fg.-Nr. →Y2147599, →Y5151036, →Y6069183, →Y0874627	LUC	0 986 473 252		←	34	
					BSY	0 986 473 326		←	38	
		ABS	10.99-12.01	100	Fg.-Nr. Y8074628→	LUC	0 986 474 326		→	38
						LUC	0 986 473 325		←	36
2.0Turbo		09.02-02.04	141-147	Fg.-Nr. →42000001, →45000001, →46000001, →48000001	LUC	0 986 473 223		←	38,1	
					LUC	0 986 474 223		→	38,1	
					LUC	0 986 473 258		←	38	
					LUC	0 986 474 258		→	38	
2.2DTI		09.01-01.04	92	Fg.-Nr. 32000001→, 35000001→, 36000001→, 38000001→	LUC	0 986 474 261		→	36	
					LUC	0 986 473 261		←	36	
2.2i		09.00-01.04	108		BSY	0 986 473 325		←	36	
					LUC	0 986 474 325		→	36	
					LUC	0 986 474 261		→	36	
1.2i		09.97-09.03	48		STB	1 987 477 764			1254	
					4SB	1 987 477 527			1593	
		09.00-09.03	55	Fg.-Nr. →22006460, →25003001, →16999999, →28006254, →1B999999	STB	1 987 477 764				1254
					4SB	1 987 477 527			1593	
				Fg.-Nr. 22006461→, 25003002→, 26000001→, 28006255→, 2B000001→	4SB	1 987 482 102			1592	



		S							
1.4 i	09.97-01.04	66		STB		1987	<b>477 764</b>	1254	
			Fg.-Nr. →22006460,	4SB	1987	<b>477 527</b>	1593		
			→25003001, →16999999, →28006254, →1B999999						
			Fg.-Nr. 22006461→32999999, 4SB		1987	<b>482 102</b>	1592		
			25003002→35999999, 26000001→36999999, 28006255→38999999, 2B000001→3B999999						
			Fg.-Nr. 42000001→, 45000001→, 46000001→, 48000001→, 4B000001→	4SB	1987	<b>482 537</b>	1587		
1.4 Twinport	09.03-06.09	66		STB		1987	<b>477 764</b>	1254	
			Fg.-Nr. →32999999,	4SB	1987	<b>482 102</b>	1592		
			→35999999, →36999999, →38999999, →3B999999						
			Fg.-Nr. 42000001→, 45000001→, 46000001→, 48000001→, 4B000001→, 4G000001→	4SB	1987	<b>482 537</b>	1587		
1.6 i	09.97-01.05	55/62/74		STB		1987	<b>477 764</b>	1254	
			Fg.-Nr. →22006460,	4SB	1987	<b>477 527</b>	1593		
			→25003001, →16999999, →28006254, →1B999999						
			Fg.-Nr. 22006461→32999999, 4SB		1987	<b>482 102</b>	1592		
			25003002→35999999, 26000001→36999999, 28006255→38999999, 2B000001→3B999999						
			Fg.-Nr. 42000001→, 45000001→, 46000001→, 48000001→, 4B000001→	4SB	1987	<b>482 537</b>	1587		
1.6 i Twinport	03.03-07.09	76		STB		1987	<b>477 764</b>	1254	
				4SB	1987	<b>477 527</b>	1593		
1.7 CDTI	03.03-01.04	59		STB		1987	<b>477 764</b>	1254	
			Fg.-Nr. →22006460,	4SB	1987	<b>477 527</b>	1593		
			→25003001, →16999999, →28006254, →1B999999						
1.7 DT, DTI	03.98-01.04	50/55		STB		1987	<b>477 764</b>	1254	
			Fg.-Nr. →X2240264,	4SB	1987	<b>477 767</b>	1577		
			→X6125306, →X8116202						
			Fg.-Nr. X2240265→, X6125307→, X8116203→	4SB	1987	<b>477 527</b>	1593		
1.8 i	09.97-08.00	85		STB		1987	<b>477 764</b>	1254	
				4SB	1987	<b>477 527</b>	1593		
	09.00-01.04	92		STB		1987	<b>477 764</b>	1254	
			Fg.-Nr. →22006460,	4SB	1987	<b>477 527</b>	1593		
			→25003001, →16999999, →28006254, →1B999999						
			Fg.-Nr. 22006461→32999999, 4SB		1987	<b>482 102</b>	1592		
			25003002→35999999, 26000001→36999999, 28006255→38999999, 2B000001→3B999999						
			Fg.-Nr. 42000001→, 45000001→, 46000001→, 48000001→, 4B000001→	4SB	1987	<b>482 537</b>	1587		
03.01-01.04	85		STB		1987	<b>477 764</b>	1254		
		Fg.-Nr. →22006460,	4SB	1987	<b>477 527</b>	1593			
			→25003001, →16999999, →28006254, →1B999999						

		<b>S</b>							
<b>1.8i</b>	03.01-01.04	85	Fg.-Nr. 22006461→32999999, 4SB 25003002→35999999, 26000001→36999999, 28006255→38999999, 2B000001→3B999999				1 987 <b>482 102</b>	1592	
			Fg.-Nr. 42000001→, 4SB 45000001→, 46000001→, 48000001→, 4B000001→				1 987 <b>482 537</b>	1587	
<b>2.0DT</b>	03.98-08.00	60		4SB			1 987 <b>477 527</b>	1593	
<b>2.0DT, DTL</b>	03.98-01.04	60		STB			1 987 <b>477 764</b>	1254	
<b>2.0DTI</b>	09.99-01.05	74		STB			1 987 <b>477 764</b>	1254	
			Fg.-Nr. →22006460, →25003001, →16999999, →28006254, →1B999999	4SB			1 987 <b>477 527</b>	1593	
<b>2.0DTL</b>	09.00-01.04	60	Fg.-Nr. →22006460, →25003001, →16999999, →28006254, →1B999999	4SB			1 987 <b>477 527</b>	1593	
<b>2.0i</b>	09.97-01.04	100		STB			1 987 <b>477 764</b>	1254	
			Fg.-Nr. →22006460, →25003001, →16999999, →28006254, →1B999999	4SB			1 987 <b>477 527</b>	1593	
			Fg.-Nr. 22006461→32999999, 4SB 25003002→35999999, 26000001→36999999, 28006255→38999999, 2B000001→3B999999				1 987 <b>482 102</b>	1592	
			Fg.-Nr. 42000001→, 45000001→, 46000001→, 48000001→, 4B000001→	4SB			1 987 <b>482 537</b>	1587	
	10.99-09.02	118		STB			1 987 <b>477 764</b>	1254	
				4SB			1 987 <b>477 527</b>	1593	
<b>2.0 Turbo</b>	09.02-02.04	141-147		STB			1 987 <b>477 764</b>	1254	
			Fg.-Nr. →22006460, →25003001, →16999999, →28006254, →1B999999	4SB			1 987 <b>477 527</b>	1593	
			Fg.-Nr. 22006461→32999999, 4SB 25003002→35999999, 26000001→36999999, 28006255→38999999, 2B000001→3B999999				1 987 <b>482 102</b>	1592	
			Fg.-Nr. 42000001→, 45000001→, 46000001→, 48000001→, 4B000001→	4SB			1 987 <b>482 537</b>	1587	
<b>2.2DTI</b>	09.01-01.04	92		STB			1 987 <b>477 764</b>	1254	
			Fg.-Nr. →22006460, →25003001, →16999999, →28006254, →1B999999	4SB			1 987 <b>477 527</b>	1593	
<b>2.2i</b>	09.00-01.04	108		STB			1 987 <b>477 764</b>	1254	
			Fg.-Nr. →22006460, →25003001, →16999999, →28006254, →1B999999	4SB			1 987 <b>477 527</b>	1593	
			Fg.-Nr. 22006461→32999999, 4SB 25003002→35999999, 26000001→36999999, 28006255→38999999, 2B000001→3B999999				1 987 <b>482 102</b>	1592	
			Fg.-Nr. 42000001→, 45000001→, 46000001→, 48000001→, 4B000001→	4SB			1 987 <b>482 537</b>	1587	



◀ OPEL									
Astra GTC [H]									
	1.3 CDTI	06.05-02.09	66		SBJ	0986 473 062		57	1987 470 0057
						0986 474 062		57	1987 470 0057
	1.4 Twinport	03.05-03.09	55/66		SBJ	0986 473 062		57	1987 470 0057
						0986 474 062		57	1987 470 0057
	1.6 i	12.06-09.09	85		SBJ	0986 473 062		57	1987 470 0057
						0986 474 062		57	1987 470 0057
		01.11-12.12	85		SBJ	0986 473 062		57	1987 470 0057
						0986 474 062		57	1987 470 0057
	1.6 Turbo	02.07-09.10	132		SBJ	0986 473 062		57	1987 470 0057
						0986 474 062		57	1987 470 0057
		01.11-12.12	132		SBJ	0986 473 062		57	1987 470 0057
						0986 474 062		57	1987 470 0057
	1.6 Twinport	03.05-03.08	77		SBJ	0986 473 062		57	1987 470 0057
						0986 474 062		57	1987 470 0057
	1.7 CDTI	03.05-12.12	59/74/81/ 92		SBJ	0986 473 062		57	1987 470 0057
						0986 474 062		57	1987 470 0057
	1.8 i	03.05-12.12	92/103		SBJ	0986 473 062		57	1987 470 0057
						0986 474 062		57	1987 470 0057
	1.9	03.05-07.10	74/88/110		SBJ	0986 473 062		57	1987 470 0057
	1.9 CDTI					0986 474 062		57	1987 470 0057
2.0 Turbo	03.05-09.09	125/147/ 177		SBJ	0986 473 062		57	1987 470 0057	
					0986 474 062		57	1987 470 0057	
	1.3 CDTI	06.05-02.09	66			0986 475 869		20,64	
	1.4 Twinport	03.05-03.09	55/66			0986 475 869		20,64	
	1.6 i	12.06-09.09	85			0986 475 949		19,05	
		01.11-12.12	85			0986 475 949		19,05	
	1.6 Turbo	02.07-09.10	132		TW	0986 475 869		20,64	
						0986 475 949		19,05	
		01.11-12.12	132			0986 475 949		19,05	
	1.6 Twinport	03.05-03.08	77			0986 475 869		20,64	
	1.7 CDTI	03.05-03.07	59/74			0986 475 869		20,64	
		10.09-12.12	81			0986 475 949		19,05	
	1.8 i	03.05-03.08	92			0986 475 869		20,64	
		11.07-12.10	103		TW	0986 475 869		20,64	
						0986 475 949		19,05	
		01.11-12.12	103			0986 475 949		19,05	
	1.9	07.05-07.10	74			0986 475 869		20,64	
						Fg.-Nr. →72999999, →75999999, →78999999, →7G999999			
						Fg.-Nr. 82000001→, 85000001→, 88000001→, 8G000001→	0986 475 949		19,05
			88			Fg.-Nr. →72999999, →75999999, →78999999, →7G999999	0986 475 869		20,64
						Fg.-Nr. 82000001→, 85000001→, 88000001→, 8G000001→	0986 475 949		19,05
	1.9 CDTI	03.05-03.08	88			0986 475 869		20,64	
	03.05-09.09	110			0986 475 869		20,64		
2.0 Turbo	03.05-09.09	125/147			0986 475 869		20,64		
	1.3 CDTI	06.05-02.09	66		4L0,SBJ	0986 473 474		36	
						0986 474 474		36	
					5L0,SBJ	0986 473 258		38	
						0986 474 258		38	
	1.4 Twinport	03.05-03.09	55/66		4L0,SBJ	0986 473 474		36	
						0986 474 474		36	
				5L0,SBJ	0986 473 258		38		
					0986 474 258		38		

		<b>S</b>															
<b>1.6 i</b>	12.06-09.09	85					4LO, <b>SBJ</b>	0 986 473 474	← 36								
								0 986 474 474	→ 36								
	01.11-12.12	85						5LO, <b>SBJ</b>	0 986 473 258	← 38							
									0 986 474 258	→ 38							
									0 986 473 474	← 36							
									0 986 474 474	→ 36							
<b>1.6 Turbo</b>	02.07-09.10	132					<b>SBJ</b>	0 986 473 258	← 38								
								0 986 474 258	→ 38								
	01.11-12.12	132						4LO, <b>SBJ</b>	0 986 473 474	← 36							
									0 986 474 474	→ 36							
									0 986 473 258	← 38							
									0 986 474 258	→ 38							
<b>1.6 Twinport</b>	03.05-03.08	77					4LO, <b>SBJ</b>	0 986 473 474	← 36								
								0 986 474 474	→ 36								
								5LO, <b>SBJ</b>	0 986 473 258	← 38							
									0 986 474 258	→ 38							
									0 986 473 474	← 36							
									0 986 474 474	→ 36							
<b>1.7 CDTI</b>	03.05-12.12	59/74/81/ 92					4LO, <b>SBJ</b>	0 986 473 474	← 36								
								0 986 474 474	→ 36								
								5LO, <b>SBJ</b>	0 986 473 258	← 38							
									0 986 474 258	→ 38							
									0 986 473 474	← 36							
									0 986 474 474	→ 36							
<b>1.8 i</b>	03.05-12.12	92/103					4LO, <b>SBJ</b>	0 986 473 474	← 36								
								0 986 474 474	→ 36								
								5LO, <b>SBJ</b>	0 986 473 258	← 38							
									0 986 474 258	→ 38							
									0 986 473 474	← 36							
									0 986 474 474	→ 36							
<b>1.9</b> <b>1.9 CDTI</b>	03.05-07.10	74/88/110					4LO, <b>SBJ</b>	0 986 473 474	← 36								
								0 986 474 474	→ 36								
								5LO, <b>SBJ</b>	0 986 473 258	← 38							
									0 986 474 258	→ 38							
									0 986 473 474	← 36							
									0 986 474 474	→ 36							
<b>2.0 Turbo</b>	03.05-09.09	125/147/ 177					4LO, <b>SBJ</b>	0 986 473 474	← 36								
								0 986 474 474	→ 36								
								5LO, <b>SBJ</b>	0 986 473 258	← 38							
									0 986 474 258	→ 38							
									0 986 473 474	← 36							
									0 986 474 474	→ 36							
	<b>1.3 CDTI</b>	06.05-02.09	66				STB	1 987 477 908	1326								
							4SB	1 987 477 909	1665								
	<b>1.4 Twinport</b>	03.05-03.09	55/66					STB	1 987 477 908	1326							
								4SB	1 987 477 909	1665							
	<b>1.6 i</b>	12.06-09.09	85					STB	1 987 477 908	1326							
								4SB	1 987 477 909	1665							
		01.11-12.12	85						Fg.-Nr. 82→, 85→, 88→, 8G→	STB	1 987 482 382	187					
										STB	1 987 477 908	1326					
										STB,TW	1 987 482 382	187					
											1 987 482 449	182					
	<b>1.6 Turbo</b>	02.07-09.10	132					4SB,TW	1 987 477 909	1665							
									STB	1 987 477 908	1326						
									STB,TW	1 987 482 382	187						
											1 987 482 449	182					
										4SB,TW	1 987 477 909	1665					
										STB	1 987 477 908	1326					
	<b>1.6 Twinport</b>	03.05-03.08	77					STB	1 987 477 908	1326							
								4SB	1 987 477 909	1665							
									STB	1 987 477 908	1326						
									4SB	1 987 477 909	1665						
									02.07-03.09	92					STB	1 987 477 908	1326
															4SB	1 987 477 909	1665
	<b>1.7 CDTI</b>	03.05-03.07	59/74					STB	1 987 477 908	1326							
								4SB	1 987 477 909	1665							
02.07-09.09		81						Fg.-Nr. 82→, 85→, 88→, 8G→	STB	1 987 482 382	187						



◀ OPEL Astra GTC [H]						
1.7 CDTI	02.07-12.12	81	STB	1987 477 908	1326	
			4SB	1987 477 909	1665	
1.8 i	03.05-03.08	92	STB	1987 482 382	187	
			4SB	1987 477 908	1326	
	11.07-12.10	103	STB,TW	1987 482 382	187	
				1987 482 449	182	
	11.07-12.12	103	STB	1987 477 908	1326	
			4SB,TW	1987 477 909	1665	
01.11-12.12	103	STB	1987 482 382	187		
1.9	07.05-07.10	74	STB	1987 477 908	1326	
			STB,TW	1987 482 382	187	
			1987 482 449	182		
			4SB,TW	1987 477 909	1665	
		88	STB,TW	1987 482 382	187	
			1987 482 449	182		
			4SB,TW	1987 477 909	1665	
1.9, CDTI	03.05-07.10	88	STB	1987 477 908	1326	
1.9 CDTI	03.05-03.08	88	4SB	1987 477 909	1665	
			STB	1987 477 908	1326	
	03.05-09.09	110	4SB	1987 477 909	1665	
			Fg.-Nr. 82→, 85→, 88→, 8G→	STB	1987 482 382	187
2.0 Turbo	03.05-02.09	125	STB	1987 477 908	1326	
			4SB	1987 477 909	1665	
	03.05-09.09	147	STB	1987 477 908	1326	
			4SB	1987 477 909	1665	
			Fg.-Nr. 82→, 85→, 88→, 8G→	STB	1987 482 382	187
	08.05-03.09	177	STB	1987 477 908	1326	
			4SB	1987 477 909	1665	

**Astra GTC [J]**

1.4	09.11→	74/88/103	D32	0986 134 319	← 60	
				0986 135 319	→ 60	
1.4 Turbo				0986 134 319	← 60	
1.6 Turbo	09.11→	125/132/ 147	D32	0986 135 319	→ 60	
				0986 134 319	← 60	
1.7	11.11→	81/96	D32	0986 134 319	← 60	
				0986 135 319	→ 60	
1.8	11.11→	103	D32	0986 134 319	← 60	
				0986 135 319	→ 60	
2.0	09.11→	96/121/ 143/206	D32	0986 134 319	← 60	
				0986 135 319	→ 60	

1.4	09.11→	74/88/103	FEB	1987 482 535	→ 1816	
				1987 482 536	← 1812	
1.4 Turbo				1987 482 535	→ 1816	
1.6 Turbo	09.11→	125/132/ 147	FEB	1987 482 536	← 1812	
				1987 482 535	→ 1816	
1.7	11.11→	81/96	FEB	1987 482 535	→ 1816	
				1987 482 536	← 1812	
1.8	11.11→	103	FEB	1987 482 535	→ 1816	
				1987 482 536	← 1812	
2.0	09.11→	96/121/ 143/206	FEB	1987 482 535	→ 1816	
				1987 482 536	← 1812	

**Astra [H]**

1.2 i Twinport	03.07-03.09	59		0986 473 062	← 57	1987 470 005 <sup>7</sup>
				0986 474 062	→ 57	1987 470 005 <sup>7</sup>

1.3 CDTI	08.05-03.10	66			SBJ	0 986 473 062	← 57	1 987 470 005 <sup>7</sup>
						0 986 474 062	→ 57	1 987 470 005 <sup>7</sup>
1.4 i	03.04-03.10	55/66				0 986 473 062	← 57	1 987 470 005 <sup>7</sup>
1.4 Twinport						0 986 474 062	→ 57	1 987 470 005 <sup>7</sup>
1.6	01.07-03.10	85				0 986 473 062	← 57	1 987 470 005 <sup>7</sup>
	07.10→	85			SBJ	0 986 474 062	→ 57	1 987 470 005 <sup>7</sup>
						0 986 473 062	← 57	1 987 470 005 <sup>7</sup>
						0 986 474 062	→ 57	1 987 470 005 <sup>7</sup>
1.6 Twinport	03.04-03.09	77				0 986 473 062	← 57	1 987 470 005 <sup>7</sup>
						0 986 474 062	→ 57	1 987 470 005 <sup>7</sup>
1.7 CDTI	03.04-03.10	59/74/81				0 986 473 062	← 57	1 987 470 005 <sup>7</sup>
	02.07-03.10	92				0 986 474 062	→ 57	1 987 470 005 <sup>7</sup>
	04.09→	92			SBJ	0 986 473 062	← 57	1 987 470 005 <sup>7</sup>
						0 986 474 062	→ 57	1 987 470 005 <sup>7</sup>
1.8	07.10→	103			SBJ	0 986 473 062	← 57	1 987 470 005 <sup>7</sup>
						0 986 474 062	→ 57	1 987 470 005 <sup>7</sup>
1.8 i	03.04-02.09	92				0 986 473 062	← 57	1 987 470 005 <sup>7</sup>
	08.05-03.10	103			SBJ	0 986 474 062	→ 57	1 987 470 005 <sup>7</sup>
						0 986 473 062	← 57	1 987 470 005 <sup>7</sup>
						0 986 474 062	→ 57	1 987 470 005 <sup>7</sup>
1.9 CDTI	04.04-03.10	88/110				0 986 473 062	← 57	1 987 470 005 <sup>7</sup>
	10.05-09.09	74			SBJ	0 986 474 062	→ 57	1 987 470 005 <sup>7</sup>
						0 986 473 062	← 57	1 987 470 005 <sup>7</sup>
						0 986 474 062	→ 57	1 987 470 005 <sup>7</sup>
2.0 Turbo	03.04-03.10	125/147/ 177				0 986 473 062	← 57	1 987 470 005 <sup>7</sup>
						0 986 474 062	→ 57	1 987 470 005 <sup>7</sup>
2.2 Direct	04.04-03.10	110			SBJ	0 986 473 062	← 57	1 987 470 005 <sup>7</sup>
						0 986 474 062	→ 57	1 987 470 005 <sup>7</sup>

	1.2 i Twinport	03.07-03.09	59			0 986 475 869	↔ 20,64	
	1.3 CDTI	08.05-03.10	66			0 986 475 869	↔ 20,64	
	1.4 Twinport	03.04-03.10	66		TW	0 986 475 869	↔ 20,64	
						0 986 475 949	↔ 19,05	
	1.6	01.07-03.10	85		TW	0 986 475 949	↔ 19,05	
						Fg.-Nr. →72999999, →75999999, →78999999, →7G999999	0 986 475 869	↔ 20,64
		07.10→	85				0 986 475 949	↔ 19,05
	1.6 Twinport	03.04-03.07	77			Fg.-Nr. →72999999, →75999999, →78999999, →7G999999	0 986 475 869	↔ 20,64
						Fg.-Nr. 82000001→, 85000001→, 88000001→, 8G000001→	0 986 475 949	↔ 19,05
	1.7 CDTI	03.04-08.07	59/74		TW	0 986 475 869	↔ 20,64	
		04.09→	92				0 986 475 949	↔ 19,05
	1.8	07.10→	103				0 986 475 949	↔ 19,05
	1.8 i	03.04-02.09	92			Fg.-Nr. →72999999, →75999999, →78999999, →7G999999	0 986 475 869	↔ 20,64
						Fg.-Nr. 82000001→, 85000001→, 88000001→, 8G000001→	0 986 475 949	↔ 19,05
		08.05-03.10	103				0 986 475 869	↔ 20,64
	1.9 CDTI	04.04-03.10	88/110				0 986 475 869	↔ 20,64
		10.05-09.09	74		TW	0 986 475 869	↔ 20,64	
							0 986 475 949	↔ 19,05

	1.2 i Twinport	03.07-03.09	59		4LO,SBJ	0 986 473 474	← 36	
						0 986 474 474	→ 36	
					5LO,SBJ	0 986 473 258	← 38	
						0 986 474 258	→ 38	





		S								
	◀ OPEL Astra [H]									
1.3 CDTI	08.05-03.10	66			4LO,SBJ		0986 473 474		← 36	
							0986 474 474		→ 36	
					5LO,SBJ		0986 473 258		← 38	
							0986 474 258		→ 38	
1.4 i	03.04-03.10	55/66			SPF		0986 473 258		← 38	
							0986 474 258		→ 38	
1.4 Twinport					SPN		0986 473 474		← 36	
							0986 474 474		→ 36	
1.6	01.07-03.10	85			4LO		0986 473 474		← 36	
							0986 474 474		→ 36	
							0986 473 258		← 38	
							0986 474 258		→ 38	
	07.10→	85			SBJ		0986 473 258		← 38	
							0986 474 258		→ 38	
1.6 Turbo	02.07-03.10	132			4LO		0986 473 474		← 36	
							0986 474 474		→ 36	
							0986 473 258		← 38	
							0986 474 258		→ 38	
1.6 Twinport	03.04-03.09	77			4LO		0986 473 474		← 36	
							0986 474 474		→ 36	
							0986 473 258		← 38	
							0986 474 258		→ 38	
1.7 CDTI	03.04-03.10	59/74/81					0986 473 258		← 38	
							0986 474 258		→ 38	
		02.07-03.10	92					0986 473 258		← 38
								0986 474 258		→ 38
	04.09→	92			4LO,SBJ		0986 473 474		← 36	
							0986 474 474		→ 36	
							0986 473 258		← 38	
							0986 474 258		→ 38	
1.8	07.10→	103			SBJ		0986 473 258		← 38	
							0986 474 258		→ 38	
1.8 i	03.04-02.09	92					0986 473 258		← 38	
							0986 474 258		→ 38	
		08.05-03.10	103			4LO,SBJ		0986 473 474		← 36
								0986 474 474		→ 36
					5LO,SBJ		0986 473 258		← 38	
							0986 474 258		→ 38	
							0986 473 258		← 38	
							0986 474 258		→ 38	
1.9 CDTI	04.04-03.10	88/110					0986 473 258		← 38	
							0986 474 258		→ 38	
		10.05-09.09	74			4LO,SBJ		0986 473 474		← 36
								0986 474 474		→ 36
					5LO,SBJ		0986 473 258		← 38	
							0986 474 258		→ 38	
2.0 Turbo	03.04-03.10	125/147/ 177					0986 473 258		← 38	
							0986 474 258		→ 38	
2.2 Direct	04.04-03.10	110			4LO,SBJ		0986 473 474		← 36	
							0986 474 474		→ 36	
							0986 473 258		← 38	
							0986 474 258		→ 38	
	1.2 i Twinport	03.07-03.09	59				1987 477 908		1326	
							4SB		1665	
	1.3 CDTI	08.05-03.10	66				1987 477 908		1326	
							4SB		1665	
							Fg.-Nr. 82→, 85→, 88→, 8G→		187	
	1.4 i	09.04-09.05	55				1987 477 908		1326	
							4SB		1665	
	1.4 Twinport	03.04-03.10	66				1987 477 908		1326	
							4SB		1665	
							1987 482 382		187	
							Fg.-Nr. 82→, 85→, 88→, 8G→		187	

		S									
<b>1.6</b>	01.07-03.10	85					STB	1 987 477 908	1326		
							4SB	1 987 477 909	1665		
	07.10→	85					Fg.-Nr. 82→, 85→, 88→, 8G→	STB	1 987 482 382	187	
							STB	1 987 477 908	1326		
							STB,TW	1 987 482 382	187		
								1 987 482 449	182		
						4SB	1 987 477 934	1760			
<b>1.6 Turbo</b>	02.07-03.10	132					STB	1 987 477 908	1326		
							4SB	1 987 477 909	1665		
							Fg.-Nr. 82→, 85→, 88→, 8G→	STB	1 987 482 382	187	
<b>1.6 Twinport</b>	03.04-03.09	77					STB	1 987 477 908	1326		
							4SB	1 987 477 909	1665		
<b>1.7 CDTI</b>	03.04-08.07	59/74					STB	1 987 477 908	1326		
							4SB	1 987 477 909	1665		
	02.07-03.10	81						STB	1 987 477 908	1326	
								4SB	1 987 477 909	1665	
								Fg.-Nr. 82→, 85→, 88→, 8G→	STB	1 987 482 382	187
								4SB	1 987 477 909	1665	
								Fg.-Nr. 82→, 85→, 88→, 8G→	STB	1 987 482 382	187
								4SB	1 987 477 909	1665	
		02.07→	92					STB	1 987 477 908	1326	
		04.09→	92					STB	1 987 482 382	187	
<b>1.8</b>	07.10→	103					STB	1 987 477 908	1326		
							STB,TW	1 987 482 382	187		
								1 987 482 449	182		
								4SB	1 987 477 934	1760	
	<b>1.8 i</b>	03.04-02.09	92					STB	1 987 477 908	1326	
4SB								1 987 477 909	1665		
	08.05-03.10	103					STB	1 987 477 908	1326		
							4SB	1 987 477 909	1665		
							Fg.-Nr. 82→, 85→, 88→, 8G→	STB	1 987 482 382	187	
								1 987 477 908	1326		
<b>1.9 CDTI</b>	04.04-03.10	88/110					STB	1 987 477 908	1326		
							4SB	1 987 477 909	1665		
	10.05-09.09	74						Fg.-Nr. 82→, 85→, 88→, 8G→	STB	1 987 482 382	187
								STB	1 987 477 908	1326	
								STB,TW	1 987 482 382	187	
							4SB,TW	1 987 477 909	1665		
<b>2.0 Turbo</b>	03.04-02.09	125					STB	1 987 477 908	1326		
							4SB	1 987 477 909	1665		
	04.04-03.10	147/177						STB	1 987 477 908	1326	
								4SB	1 987 477 909	1665	
							Fg.-Nr. 82→, 85→, 88→, 8G→	STB	1 987 482 382	187	
<b>2.2 Direct</b>	04.04-03.10	110						1 987 477 909	1665		

**Astra [J]**

	<b>1.3 CDTI</b>	09.09→	66-70			D32	0 986 134 319		← 60
							0 986 135 319		→ 60
	<b>1.4, i, i Turbo, Turbo</b>	09.09→	64/74/88/ 103			D32	0 986 134 319		← 60
							0 986 135 319		→ 60
	<b>1.6, CDTI, GTC, i, i Turbo, Turbo</b>	09.09→	81/85/100/ 125/132			D32	0 986 134 319		← 60
							0 986 135 319		→ 60
	<b>1.7 CDTI</b>	09.09→	74/81/92/ 96			D32	0 986 134 319		← 60
							0 986 135 319		→ 60
	<b>2.0 CDTI</b>	09.09→	118/121/ 143			D32	0 986 134 319		← 60
							0 986 135 319		→ 60
	<b>1.3 CDTI</b>	09.09→	66-70			FEB	1 987 482 502		→ 1814
							1 987 482 503		← 1812

		S				?			
	<b>◀ OPEL Astra [J]</b>								
	1.4, i, i Turbo, Turbo	09.09→	64/74/88/ 103			FEB	1987 482 502	→ 1814	
							1987 482 503	← 1812	
	1.6	09.09→	85			FEB	1987 482 502	→ 1814	
	1.6 i						1987 482 503	← 1812	
	1.6 CDTI	12.13→	100			FEB	1987 482 502	→ 1814	
							1987 482 503	← 1812	
		02.14→	81			FEB	1987 482 502	→ 1814	
							1987 482 503	← 1812	
	1.6 GTC	06.14→	81			FEB	1987 482 535	→ 1816	
							1987 482 536	← 1812	
			100			FEB	1987 482 535	→ 1816	
							1987 482 536	← 1812	
	1.6 i Turbo	09.09→	125/132			FEB	1987 482 502	→ 1814	
	1.6 Turbo						1987 482 503	← 1812	
	1.7 CDTI	09.09→	74/81/92/ 96			FEB	1987 482 502	→ 1814	
							1987 482 503	← 1812	
	2.0 CDTI	09.09→	118/121/ 143			FEB	1987 482 502	→ 1814	
							1987 482 503	← 1812	
<b>Astra Limousine [J]</b>									
	1.6 CDTI	12.13→	81/100			D32	0986 134 319	← 60	
							0986 135 319	→ 60	
	1.6 CDTI	12.13→	81/100			FEB	1987 482 502	→ 1814	
							1987 482 503	← 1812	
<b>Astra Sporte Tourer [J]</b>									
	1.4 i Turbo	03.15→	88			D32	0986 134 319	← 60	
							0986 135 319	→ 60	
	1.4 i Turbo	03.15→	88			FEB	1987 482 502	→ 1814	
							1987 482 503	← 1812	
<b>Astra Sports Tourer [J]</b>									
	1.3 CDTI	09.10→	67-70			D32	0986 134 319	← 60	
							0986 135 319	→ 60	
	1.4 i	09.10→	74/88/103			D32	0986 134 319	← 60	
	1.4 i Turbo						0986 135 319	→ 60	
	1.6 CDTI, i, i Turbo, Turbo	09.10→	81/85/100/ 125/132			D32	0986 134 319	← 60	
							0986 135 319	→ 60	
	1.7 CDTI	09.10→	74/81/92/ 96			D32	0986 134 319	← 60	
							0986 135 319	→ 60	
	2.0 CDTI	09.10→	118/121/ 143			D32	0986 134 319	← 60	
							0986 135 319	→ 60	
	1.3 CDTI	09.10→	67-70			FEB	1987 482 502	→ 1814	
							1987 482 503	← 1812	
	1.4 i	09.10→	74/88/103			FEB	1987 482 502	→ 1814	
	1.4 i Turbo						1987 482 503	← 1812	
	1.6 CDTI, i, in Turbo, Turbo	09.10→	81/85/100/ 125/132			FEB	1987 482 502	→ 1814	
							1987 482 503	← 1812	

		S							
1.7 CDTi	09.10→	74/81/92/96				FEB	1 987 482 502	→ 1814	
							1 987 482 503	← 1812	
2.0 CDTi	09.10→	118/121/143				FEB	1 987 482 502	→ 1814	
							1 987 482 503	← 1812	
<b>Astra TwinTop [H]</b>									
	1.6 i, i Turbo, Turbo	09.05-10.10	76-77/85/132			SBJ	0 986 473 062	↔ 57	1 987 470 005 <sup>7</sup>
							0 986 474 062	↔ 57	1 987 470 005 <sup>7</sup>
	1.8 i	09.05-10.10	103			SBJ	0 986 473 062	↔ 57	1 987 470 005 <sup>7</sup>
							0 986 474 062	↔ 57	1 987 470 005 <sup>7</sup>
	1.9 CDTi	09.05-10.10	110			SBJ	0 986 473 062	↔ 57	1 987 470 005 <sup>7</sup>
							0 986 474 062	↔ 57	1 987 470 005 <sup>7</sup>
	2.0 i Turbo	09.05-10.10	125/147			SBJ	0 986 473 062	↔ 57	1 987 470 005 <sup>7</sup>
							0 986 474 062	↔ 57	1 987 470 005 <sup>7</sup>
	1.6 i	09.05-03.08	76-77				0 986 475 869	↔ 20,64	
							0 986 475 949	↔ 19,05	
		01.07-10.10	85				0 986 475 949	↔ 19,05	
						TW	0 986 475 869	↔ 20,64	
							0 986 475 949	↔ 19,05	
	1.6 i Turbo	02.07-10.10	132			TW	0 986 475 869	↔ 20,64	
	1.6 Turbo						0 986 475 949	↔ 19,05	
	1.8 i	09.05-10.10	103			TW	0 986 475 869	↔ 20,64	
							0 986 475 949	↔ 19,05	
	1.9 CDTi	09.05-10.10	110	Fg.-Nr. →72999999, →75999999, →78999999, →7G999999			0 986 475 869	↔ 20,64	
				Fg.-Nr. 82000001→, 85000001→, 88000001→, 8G000001→			0 986 475 949	↔ 19,05	
	2.0 i Turbo	09.05-02.09	125				0 986 475 869	↔ 20,64	
		09.05-10.10	147			TW	0 986 475 869	↔ 20,64	
							0 986 475 949	↔ 19,05	
	1.6 i	09.05-10.10	76-77/85/132			4LO,SBJ	0 986 473 474	↔ 36	
	1.6 i Turbo						0 986 474 474	↔ 36	
	1.6 Turbo					5LO,SBJ	0 986 473 258	↔ 38	
							0 986 474 258	↔ 38	
	1.8 i	09.05-10.10	103			4LO,SBJ	0 986 473 474	↔ 36	
							0 986 474 474	↔ 36	
						5LO,SBJ	0 986 473 258	↔ 38	
							0 986 474 258	↔ 38	
	1.9 CDTi	09.05-10.10	110			4LO,SBJ	0 986 473 474	↔ 36	
							0 986 474 474	↔ 36	
						5LO,SBJ	0 986 473 258	↔ 38	
							0 986 474 258	↔ 38	
	2.0 i Turbo	09.05-10.10	125/147			4LO,SBJ	0 986 473 474	↔ 36	
							0 986 474 474	↔ 36	
						5LO,SBJ	0 986 473 258	↔ 38	
							0 986 474 258	↔ 38	
	1.6 i	09.05-03.08	76-77			STB	1 987 477 908		1326
						4SB	1 987 477 909		1665
						Fg.-Nr. →82, →85, →88, →8G	STB		1 987 482 449
						Fg.-Nr. 82→, 85→, 88→, 8G→	STB		1 987 482 382
	1.6 i	01.07-10.10	85/132			STB	1 987 477 908		1326
	1.6 i Turbo					STB,TW	1 987 482 382		187
	1.6 Turbo						1 987 482 449		182
						4SB,TW	1 987 477 909		1665

		S							
<b>OPEL Astra TwinTop [H]</b>									
1.8 i		09.05-10.10	103				1987 477 909	1665	
						STB	1987 477 908	1326	
						STB,TW	1987 482 382	187	
							1987 482 449	182	
						4SB,TW	1987 477 909	1665	
1.9 CDTi		09.05-10.10	110			STB	1987 477 908	1326	
						STB,TW	1987 482 382	187	
							1987 482 449	182	
						4SB,TW	1987 477 909	1665	
2.0 i Turbo		09.05-02.09	125			STB	1987 477 908	1326	
						4SB	1987 477 909	1665	
						Fg.-Nr. →82, →85, →88, →8G	STB	1987 482 449	182
						Fg.-Nr. 82→, 85→, 88→, 8G→	STB	1987 482 382	187
		09.05-10.10	147			STB	1987 477 908	1326	
						STB,TW	1987 482 382	187	
							1987 482 449	182	
						4SB,TW	1987 477 909	1665	
<b>Calibra</b>									
	2.0 i	06.90-03.97	85/100/110			AA	0986 473 913	← 54	
							0986 473 914	→ 54	
						NAA	0986 473 905	← 52	
							0986 473 906	→ 52	
	2.0 i Turbo	03.92-03.97	150			Fg.-Nr. T1000001→, T9000001→	0986 473 056	← 57	1987 470 005 <sup>7</sup>
							0986 474 056	→ 57	1987 470 005 <sup>7</sup>
	2.5 iV6	04.93-03.97	125			Fg.-Nr. T1000001→, T9000001→	0986 473 056	← 57	1987 470 005 <sup>7</sup>
							0986 474 056	→ 57	1987 470 005 <sup>7</sup>
	2.0 i	06.90-03.97	85/100/110/150				0986 473 947	← 35	
	2.0 i Turbo						0986 473 948	→ 35	
	2.5 iV6	04.93-03.97	125			Fg.-Nr. →T1000582, →T9000000	0986 473 943	← 33	
							0986 473 944	→ 33	
						Fg.-Nr. T1000583→, T9000001→	0986 473 947	← 35	
							0986 473 948	→ 35	
						ATE	0986 473 949	← 35	
							0986 473 950	→ 35	
	2.0 i	06.90-03.97	85/100/110/150				1987 477 130	↔ 1498	
	2.0 i Turbo	03.92-03.97	85/100/110/150				1987 477 130	↔ 1498	
	2.5 iV6	04.93-03.97	125				1987 477 130	↔ 1498	
	2.0 i	06.90-03.97	85			Fg.-Nr. →M1999999	0265 001 206 <sup>3</sup>		
						AA,LAB	0265 001 226 <sup>4</sup>		
						LAB,NAA	0265 001 233 <sup>4</sup>		
						NAA,RAB	0265 001 232 <sup>4</sup>		
						Fg.-Nr. N1000001→	AA,LAB	0265 006 487 <sup>4</sup>	
							AA,RAB	0265 006 486 <sup>4</sup>	
							LAB,NAA	0265 003 094 <sup>4</sup>	
							NAA,RAB	0265 003 093 <sup>4</sup>	
		09.93-08.96	100			Fg.-Nr. →M1999999	0265 001 206 <sup>3</sup>		
							LAB,NAA	0265 001 233 <sup>4</sup>	
						Fg.-Nr. N1000001→	AA,LAB	0265 006 487 <sup>4</sup>	
							AA,RAB	0265 006 486 <sup>4</sup>	
							LAB,NAA	0265 003 094 <sup>4</sup>	
							NAA,RAB	0265 003 093 <sup>4</sup>	
	2.0 i	06.90-03.97	110/150			Fg.-Nr. →M1999999	0265 001 206 <sup>3</sup>		
	2.0 i Turbo						AA,LAB	0265 001 226 <sup>4</sup>	
							LAB,NAA	0265 001 233 <sup>4</sup>	

		S							
2.0i		06.90-03.97	110/150	Fg.-Nr. →M1999999	NAA,RAB	0 265 001 232 <sup>4</sup>			
2.0i Turbo				Fg.-Nr. N1000001→	AA,LAB	0 265 006 487 <sup>4</sup>			
					AA,RAB	0 265 006 486 <sup>4</sup>			
					LAB,NAA	0 265 003 094 <sup>4</sup>			
					NAA,RAB	0 265 003 093 <sup>4</sup>			
2.5i V6		04.93-03.97	125	Fg.-Nr. →M1999999		0 265 001 206 <sup>3</sup>			
					LAB,NAA	0 265 001 233 <sup>4</sup>			
				Fg.-Nr. N1000001→	AA,LAB	0 265 006 487 <sup>4</sup>			
					AA,RAB	0 265 006 486 <sup>4</sup>			
					LAB,NAA	0 265 003 094 <sup>4</sup>			
					NAA,RAB	0 265 003 093 <sup>4</sup>			
<b>Campo Pick-Up [TF0]</b>									
	2.2D	08.87-09.96	39-45		AA	0 986 473 306		← 60	
						0 986 474 306		→ 60	
	2.3	09.91-09.96	65-72		AA	0 986 473 306		← 60	
	2.3i					0 986 474 306		→ 60	
	2.5D	02.89-08.97	56		AA	0 986 473 306		← 60	
	2.5TD					0 986 474 306		→ 60	
	3.1TD	03.95-08.97	80		AA	0 986 473 306		← 60	
						0 986 474 306		→ 60	
	2.2D	08.87-09.95	39-45			0 986 475 807		↔ 25,4	
	2.3, i	09.91-09.95	65-72			0 986 475 807		↔ 25,4	
	2.5D, TD	02.89-09.95	56			0 986 475 807		↔ 25,4	
	3.1TD	03.95-09.95	80			0 986 475 807		↔ 25,4	
<b>Campo Pick-Up [TF1]</b>									
	2.5DI	03.97-08.03	56/74		AA	0 986 473 306		← 60	
	2.5DTI					0 986 474 306		→ 60	
	3.1TDS	03.97-08.02	80		AA	0 986 473 306		← 60	
						0 986 474 306		→ 60	
	2.5DI, DTI	03.97-08.03	56/74			0 986 475 807		↔ 25,4	
	3.1TDS	03.97-08.02	80			0 986 475 807		↔ 25,4	
<b>Cascada</b>									
	1.4 Turbo	03.13→	88/103			0 986 134 319		← 60	
						0 986 135 319		→ 60	
	1.6 Turbo	03.13→	125/147			0 986 134 319		← 60	
						0 986 135 319		→ 60	
	2.0 CDTI	03.13→	121/143			0 986 134 319		← 60	
						0 986 135 319		→ 60	
	1.4 Turbo	03.13→	88/103		FEB	1 987 482 535		→ 1816	
						1 987 482 536		← 1812	
	1.6 Turbo	03.13→	125/147		FEB	1 987 482 535		→ 1816	
						1 987 482 536		← 1812	
	2.0 CDTI	03.13→	121/143		FEB	1 987 482 535		→ 1816	
						1 987 482 536		← 1812	





◀ OPEL

**Combo**



	<b>1.2 i</b>	09.94-10.01	33	0986 471 899	← 48
				0986 473 899	
				0986 473 901	
				0986 471 900	→ 48
				0986 473 900	
				0986 473 902	
	<b>1.4 i</b>	09.94-10.01	44/60	0986 471 899	← 48
				0986 473 899	
				0986 473 901	
				0986 471 900	→ 48
				0986 473 900	
				0986 473 902	
08.99-10.01		66	0986 471 899	← 48	
			0986 473 899		
			0986 473 901		
			0986 471 900	→ 48	
			0986 473 900		
			0986 473 902		
08.08→	66	0986 471 899	← 48		
		0986 473 899			
		0986 473 901			
		0986 471 900	→ 48		
		0986 473 900			
		0986 473 902			
<b>1.7 D</b>	09.94-10.01	44	0986 471 899	← 48	
			0986 473 899		
			0986 473 901		
			0986 471 900	→ 48	
			0986 473 900		
			0986 473 902		



	<b>1.2 i</b>	09.94-10.01	33	0986 475 029	↔ 19,05					
				<b>1.4 i</b>	09.94-10.01	44/60	0986 475 029	↔ 19,05		
							08.99-10.01	66	0986 475 029	↔ 19,05
							08.08→	66	0986 475 029	↔ 19,05
					<b>1.7 D</b>	09.94-10.01	44	0986 475 029	↔ 19,05	



	<b>1.2 i</b>	09.94-10.01	33	1987 477 769	1659					
				<b>1.4 i</b>	09.94-10.01	44/60	1987 477 769	1659		
							08.99-10.01	66	1987 477 769	1659
							08.08→	66	1987 477 769	1659
					<b>1.7 D</b>	09.94-10.01	44	1987 477 769	1659	

	<b>1.2 i</b>	09.94-10.01	33	0986 594 025 <sup>4</sup>				
				0986 594 028 <sup>3</sup>				
				<b>1.4 i</b>	09.94-10.01	44/60	0986 594 025 <sup>4</sup>	
							0986 594 028 <sup>3</sup>	
							08.99-10.01	66
					08.08→	66	0986 594 028 <sup>3</sup>	
	0986 594 025 <sup>4</sup>							
	0986 594 028 <sup>3</sup>							
	<b>1.7 D</b>	09.94-10.01	44	0986 594 025 <sup>4</sup>				
				0986 594 028 <sup>3</sup>				



**Combo [D]**

	<b>1.3</b>	02.12→	66		TW	0 986 475 971	↔ 25,4
	<b>1.4</b>	02.12→	70/88		TW	0 986 475 971	↔ 25,4
	<b>1.6</b>	02.12→	66/74/77		TW	0 986 475 971	↔ 25,4
	<b>2.0</b>	02.12→	99		TW	0 986 475 971	↔ 25,4

**Combo [Tour]**

	<b>1.3 CDTI</b>	09.04-09.07	51			0 986 473 991	↔ 54
						0 986 474 991	↔ 54
		10.05-01.12	55		TW	0 986 473 062	↔ 57
						0 986 473 991	↔ 54
						0 986 474 062	↔ 57
						0 986 474 991	↔ 54
	<b>1.4 i Twinport</b>	09.04-01.11	66		TW	0 986 473 062	↔ 57
						0 986 473 991	↔ 54
						0 986 474 062	↔ 57
						0 986 474 991	↔ 54
	<b>1.6 CNG</b>	04.05-01.11	69/71			0 986 473 062	↔ 57
						0 986 474 062	↔ 57
	<b>1.6 i</b>	10.01-08.03	64			0 986 473 991	↔ 54
						0 986 474 991	↔ 54
	<b>1.7 CDTI</b>	09.04-01.11	74			0 986 473 062	↔ 57
						0 986 474 062	↔ 57
	<b>1.7 DI</b>	10.01-08.03	48/55			0 986 473 991	↔ 54
	<b>1.7 DTI</b>					0 986 474 991	↔ 54

	<b>1.3 CDTI</b>	09.04-01.12	51/55			0 986 475 143	↔ 19,05
	<b>1.4 i Twinport</b>	09.04-01.11	66			0 986 475 143	↔ 19,05
	<b>1.6 i</b>	10.01-08.04	64			0 986 475 143	↔ 19,05
	<b>1.7 CDTI</b>	09.04-01.11	74			0 986 475 869	↔ 20,64
	<b>1.7 DI, DTI</b>	10.01-08.04	48/55			0 986 475 143	↔ 19,05

	<b>1.3 CDTI</b>	09.04-01.12	51/55			0 986 473 258	↔ 38
						0 986 474 258	↔ 38
	<b>1.4 i Twinport</b>	09.04-01.11	66			0 986 473 258	↔ 38
						0 986 474 258	↔ 38
	<b>1.6 CNG</b>	04.05-01.11	69/71			0 986 473 258	↔ 38
						0 986 474 258	↔ 38
	<b>1.6 i</b>	10.01-08.04	64			0 986 473 258	↔ 38
						0 986 474 258	↔ 38
	<b>1.7 CDTI, DI, DTI</b>	10.01-01.11	48/55/74			0 986 473 258	↔ 38
						0 986 474 258	↔ 38

	<b>1.3 CDTI</b>	09.04-09.07	51			1 987 482 449	182
					HTB	1 987 477 869	1235
		10.05-01.12	55			1 987 482 449	182
					HTB,MI	1 987 477 869	1235
					4SB,MI	1 987 482 138	1582
		ABO 09.04-09.07	51		4SB	1 987 477 869	1235
		ABS 09.04-09.07	51		4SB	1 987 482 138	1582
	<b>1.4 i Twinport</b>	09.04-01.11	66			1 987 482 449	182
					HTB,MI	1 987 477 869	1235
					4SB,MI	1 987 482 138	1582
	<b>1.6 CNG</b>	04.05-05.06	71			1 987 482 449	182
					HTB	1 987 477 869	1235















































**◀ OPEL Combo [Tour]**

<b>1.6 CNG</b>	06.06-01.11	69			1987 <b>482 449</b>	182
			MI		1987 <b>482 138</b>	1582
	ABO 04.05-05.06	71		4SB	1987 <b>477 869</b>	1235
	ABS 04.05-05.06	71		4SB	1987 <b>482 138</b>	1582
<b>1.6 i</b>	10.01-08.04	64			1987 <b>482 449</b>	182
				HTB	1987 <b>477 869</b>	1235
	ABO 10.01-08.04	64		4SB	1987 <b>477 869</b>	1235
	ABS 10.01-08.04	64		4SB	1987 <b>482 138</b>	1582
<b>1.7 CDTI</b>	09.04-01.11	74			1987 <b>482 449</b>	182
				HTB,MI	1987 <b>477 869</b>	1235
				4SB,MI	1987 <b>482 138</b>	1582
<b>1.7 DI</b>	10.01-08.04	48			1987 <b>482 449</b>	182
				HTB	1987 <b>477 869</b>	1235
	ABO 10.01-08.04	48		4SB	1987 <b>477 869</b>	1235
<b>1.7 DI, DTI</b>	ABS 10.01-08.04	48/55		4SB	1987 <b>482 138</b>	1582
<b>1.7 DTI</b>	10.01-08.04	55			1987 <b>482 449</b>	182
				HTB	1987 <b>477 869</b>	1235
	ABO 10.01-08.04	55		4SB	1987 <b>477 869</b>	1235

<b>1.3 CDTI</b>	09.04-01.12	51/55			0986 <b>594 027<sup>3</sup></b>	
<b>1.4 i Twinport</b>	09.04-01.11	66			0986 <b>594 027<sup>3</sup></b>	
<b>1.6 CNG</b>	04.05-01.11	69/71			0986 <b>594 027<sup>3</sup></b>	
<b>1.6 i</b>	10.01-08.04	64			0986 <b>594 027<sup>3</sup></b>	
<b>1.7 CDTI</b>	10.01-01.11	48/55/74			0986 <b>594 027<sup>3</sup></b>	
<b>1.7 DI</b>						
<b>1.7 DTI</b>						

**Corsa [A]**

<b>1.0 S</b>	09.82-08.94	33	Fg.-Nr. →M4999999	DMO	0986 <b>471 462</b>	← 48	1987 <b>470 496<sup>7</sup></b>
					0986 <b>473 462</b>	↻	1987 <b>470 498<sup>8</sup></b>
					0986 <b>472 462</b>	→ 48	1987 <b>470 496<sup>7</sup></b>
					0986 <b>474 462</b>	↻	
			Fg.-Nr. N4000001→	ATE	0986 <b>471 895</b>	← 48	
					0986 <b>473 895</b>	↻	
					0986 <b>471 896</b>	→ 48	
					0986 <b>473 896</b>	↻	
<b>1.2</b>	09.86-08.94	38	Fg.-Nr. →M4999999	DMO	0986 <b>471 462</b>	← 48	1987 <b>470 496<sup>7</sup></b>
					0986 <b>473 462</b>	↻	1987 <b>470 498<sup>8</sup></b>
					0986 <b>472 462</b>	→ 48	1987 <b>470 496<sup>7</sup></b>
					0986 <b>474 462</b>	↻	
	01.87-08.94	33	Fg.-Nr. →M4999999	DMO	0986 <b>471 462</b>	← 48	1987 <b>470 498<sup>8</sup></b>
					0986 <b>473 462</b>	↻	
					0986 <b>472 462</b>	→ 48	1987 <b>470 498<sup>8</sup></b>
					0986 <b>474 462</b>	↻	
<b>1.2</b>	01.87-08.94	33	Fg.-Nr. →M4999999	DMO	0986 <b>471 462</b>	← 48	1987 <b>470 496<sup>7</sup></b>
<b>1.2 i</b>					0986 <b>473 462</b>	↻	
<b>1.2 i</b>	09.90-08.94	33	Fg.-Nr. →M4999999	DMO	0986 <b>471 462</b>	← 48	1987 <b>470 498<sup>8</sup></b>
					0986 <b>473 462</b>	↻	
					0986 <b>472 462</b>	→ 48	1987 <b>470 496<sup>7</sup></b>
					0986 <b>474 462</b>	↻	
			Fg.-Nr. N4000001→	ATE	0986 <b>471 895</b>	← 48	
					0986 <b>473 895</b>	↻	
					0986 <b>471 896</b>	→ 48	
					0986 <b>473 896</b>	↻	
<b>1.2 S</b>	09.82-08.94	40-44	Fg.-Nr. →M4999999	DMO	0986 <b>471 462</b>	← 48	1987 <b>470 496<sup>7</sup></b>
					0986 <b>473 462</b>	↻	1987 <b>470 498<sup>8</sup></b>
					0986 <b>472 462</b>	→ 48	1987 <b>470 496<sup>7</sup></b>
					0986 <b>474 462</b>	↻	

		S										
1.2 S	09.82-08.94	40-44	Fg.-Nr. N4000001→	ATE	0 986 471 895	← 48						
					0 986 473 895							
					0 986 471 896	→ 48						
					0 986 473 896							
	09.86-08.94	37-40	Fg.-Nr. →M4999999	DMO	0 986 471 462	← 48	1 987 470 496 <sup>7</sup>					
					0 986 473 462		1 987 470 498 <sup>8</sup>					
					0 986 472 462	→ 48	1 987 470 496 <sup>7</sup>					
					0 986 474 462							
		Fg.-Nr. N4000001→	ATE	0 986 471 895	← 48							
				0 986 473 895								
				0 986 471 896	→ 48							
				0 986 473 896								
1.3 S	09.82-08.94	51	Fg.-Nr. →M4999999	DMO	0 986 471 462	← 48	1 987 470 496 <sup>7</sup>					
					0 986 473 462		1 987 470 498 <sup>8</sup>					
					0 986 472 462	→ 48	1 987 470 496 <sup>7</sup>					
					0 986 474 462							
1.4 1.4 i	01.90-08.94	40-44/53	Fg.-Nr. →M4999999	DMO	0 986 471 462	← 48	1 987 470 496 <sup>7</sup>					
					0 986 473 462		1 987 470 498 <sup>8</sup>					
					0 986 472 462	→ 48	1 987 470 496 <sup>7</sup>					
					0 986 474 462							
			Fg.-Nr. N4000001→	ATE	0 986 471 895	← 48						
					0 986 473 895							
					0 986 471 896	→ 48						
					0 986 473 896							
1.4 i	09.91-08.94	60	Fg.-Nr. N4000001→	ATE	0 986 471 899	← 48						
					0 986 473 899							
					0 986 473 901							
					0 986 471 900	→ 48						
						0 986 473 900						
						0 986 473 902						
1.5 D 1.5 TD	09.87-08.94	37/49	Fg.-Nr. →M4999999	DMO	0 986 471 463	← 48	1 987 470 496 <sup>7</sup>					
					0 986 473 463		1 987 470 498 <sup>8</sup>					
					0 986 472 463	→ 48	1 987 470 496 <sup>7</sup>					
					0 986 474 463							
			Fg.-Nr. N4000001→	ATE	0 986 471 895	← 48						
					0 986 473 895							
					0 986 471 896	→ 48						
					0 986 473 896							
1.6 i	05.88-08.94	74	Fg.-Nr. →M4999999	DMO	0 986 471 464	← 52	1 987 470 498 <sup>8</sup>					
					0 986 473 464							
					0 986 472 464	→ 52	1 987 470 498 <sup>8</sup>					
					0 986 474 464							
			Fg.-Nr. N4000001→	ATE	0 986 471 899	← 48						
					0 986 473 899							
					0 986 473 901							
					0 986 471 900	→ 48						
						0 986 473 900						
						0 986 473 902						
04.89-08.94	55	Fg.-Nr. →M4999999	DMO	0 986 471 463	← 48	1 987 470 496 <sup>7</sup>						
				0 986 473 463		1 987 470 498 <sup>8</sup>						
				0 986 472 463	→ 48	1 987 470 496 <sup>7</sup>						
				0 986 474 463								
			Fg.-Nr. N4000001→	ATE	0 986 471 899	← 48						
					0 986 473 899							
					0 986 473 901							
					0 986 471 900	→ 48						
					0 986 473 900							
					0 986 473 902							





◀ OPEL Corsa [A]



	1.0 S	09.82-08.94	33	Fg.-Nr. →F4999999	0986 <b>475 453</b>	↔ 14,29
				Fg.-Nr. G4000001→M4999999	0986 <b>475 022</b>	↔ 14,29
				Fg.-Nr. N4000001→	0986 <b>475 032</b>	↔ 17,46
1.2, i, S	09.82-08.94	33/37-44	Fg.-Nr. →F4999999	F026 <b>002 123</b>	↔ 17,5	
			Fg.-Nr. G4000001→	0986 <b>475 032</b>	↔ 17,46	
1.3 S	09.82-08.94	51	Fg.-Nr. →F4999999	F026 <b>002 123</b>	↔ 17,5	
			Fg.-Nr. G4000001→	0986 <b>475 032</b>	↔ 17,46	
1.4	01.90-08.94	40-44/53	Fg.-Nr. →F4999999	F026 <b>002 123</b>	↔ 17,5	
			Fg.-Nr. G4000001→	0986 <b>475 032</b>	↔ 17,46	
1.4 i	09.91-08.94	60	Fg.-Nr. G4000001→	0986 <b>475 032</b>	↔ 17,46	
			Fg.-Nr. →F4999999	F026 <b>002 123</b>	↔ 17,5	
1.5 D	09.87-08.94	37/49	Fg.-Nr. →F4999999	F026 <b>002 123</b>	↔ 17,5	
			Fg.-Nr. G4000001→	0986 <b>475 032</b>	↔ 17,46	
1.6 i	05.88-08.94	55/74	Fg.-Nr. →F4999999	F026 <b>002 123</b>	↔ 17,5	
			Fg.-Nr. G4000001→	0986 <b>475 032</b>	↔ 17,46	



	1.0 S	09.82-08.94	33	Fg.-Nr. →F4999999	1987 <b>477 131</b>	← 822
				Fg.-Nr. G4000001→N4052760	1987 <b>477 132</b>	→ 1435
				Fg.-Nr. N4052761→	1987 <b>477 133</b>	← 960
				Fg.-Nr. N4052761→	1987 <b>477 134</b>	→ 1400
1.2	09.82-08.94	33/37-44	Fg.-Nr. →F4999999	1987 <b>477 131</b>	← 822	
				1987 <b>477 132</b>	→ 1435	
				1987 <b>477 133</b>	← 960	
				1987 <b>477 134</b>	→ 1400	
1.2 S	09.82-08.94	33/37-44	Fg.-Nr. G4000001→N4052760	1987 <b>477 131</b>	← 822	
				1987 <b>477 132</b>	→ 1435	
				1987 <b>477 133</b>	← 960	
				1987 <b>477 134</b>	→ 1400	
1.3 S	09.82-08.94	51	Fg.-Nr. →F4999999	1987 <b>477 131</b>	← 822	
				1987 <b>477 132</b>	→ 1435	
				1987 <b>477 133</b>	← 960	
				1987 <b>477 134</b>	→ 1400	
1.4	01.90-08.94	40-44/53	Fg.-Nr. →F4999999	1987 <b>477 131</b>	← 822	
				1987 <b>477 132</b>	→ 1435	
				1987 <b>477 133</b>	← 960	
				1987 <b>477 134</b>	→ 1400	
1.4 i	09.91-08.94	60	Fg.-Nr. G4000001→N4052760	1987 <b>477 131</b>	← 822	
				1987 <b>477 132</b>	→ 1435	
				1987 <b>477 133</b>	← 960	
				1987 <b>477 134</b>	→ 1400	
1.4 i	09.91-08.94	60	Fg.-Nr. N4052761→	1987 <b>477 307</b>	→ 1035	
				1987 <b>477 308</b>	← 1260	
				1987 <b>477 307</b>	→ 1035	
				1987 <b>477 308</b>	← 1260	
1.5 D	09.87-08.94	37/49	Fg.-Nr. →F4999999	1987 <b>477 131</b>	← 822	
				1987 <b>477 132</b>	→ 1435	
				1987 <b>477 133</b>	← 960	
				1987 <b>477 134</b>	→ 1400	
1.5 TD	09.87-08.94	37/49	Fg.-Nr. G4000001→N4052760	1987 <b>477 131</b>	← 822	
				1987 <b>477 132</b>	→ 1435	
				1987 <b>477 133</b>	← 960	
				1987 <b>477 134</b>	→ 1400	
1.6 i	05.88-08.94	55/74	Fg.-Nr. →F4999999	1987 <b>477 131</b>	← 822	
				1987 <b>477 132</b>	→ 1435	
				1987 <b>477 133</b>	← 960	
				1987 <b>477 134</b>	→ 1400	
1.6 i	05.88-08.94	55/74	Fg.-Nr. G4000001→N4052760	1987 <b>477 131</b>	← 822	
				1987 <b>477 132</b>	→ 1435	
				1987 <b>477 133</b>	← 960	
				1987 <b>477 134</b>	→ 1400	
1.6 i	05.88-08.94	55/74	Fg.-Nr. N4052761→	1987 <b>477 307</b>	→ 1035	
				1987 <b>477 308</b>	← 1260	
				1987 <b>477 307</b>	→ 1035	
				1987 <b>477 308</b>	← 1260	





**Corsa [B]**

	<b>1.0i</b>	09.96-09.00	40			0 986 471 895	← 48		
						0 986 473 895			
						0 986 471 896	→ 48		
						0 986 473 896			
<b>1.2i</b>	03.93-08.00	33		AG, KL		0 986 471 899	← 48		
						0 986 473 899			
						0 986 473 901			
						0 986 471 900	→ 48		
						0 986 473 900			
						0 986 473 902			
		09.97-08.00	48		AG, KL		0 986 471 899	← 48	
							0 986 473 899		
							0 986 473 901		
					KL		0 986 471 900	→ 48	
							0 986 473 900		
							0 986 473 902		
0 986 471 895							← 48		
0 986 473 895									
0 986 471 896							→ 48		
<b>1.4i</b>	03.93-08.00	60				Fg.-Nr. →V3023597, →V4166925, →V6066279	0 986 471 899	← 48	
							0 986 473 899		
							0 986 473 901		
							0 986 471 900	→ 48	
							0 986 473 900		
							0 986 473 902		
			63/66		AG		Fg.-Nr. V3023598→, V4166926→, V6066200→	0 986 471 895	← 48
								0 986 473 895	
								0 986 471 896	→ 48
					AG, KL		0 986 473 896		
							0 986 471 899	← 48	
							0 986 473 899		
0 986 473 901									
0 986 471 900							→ 48		
0 986 473 900									
	03.93-09.00	44		AG, KL		0 986 473 902			
						0 986 471 899	← 48		
						0 986 473 899			
						0 986 473 901			
						0 986 471 900	→ 48		
						0 986 473 900			
				KL		0 986 473 902			
						0 986 471 895	← 48		
						0 986 473 895			
						0 986 471 896	→ 48		
						0 986 473 896			
						0 986 473 896			
<b>1.5D</b>	03.93-08.00	37/49			KL		0 986 471 895	← 48	
							<b>1.5TD</b>	0 986 473 895	
							<b>1.5XD</b>	0 986 471 896	→ 48
							<b>1.5XTD</b>	0 986 473 896	





	<b>◀ OPEL Corsa [B]</b>						
	1.6 GSI	03.93-08.00	74/78/80		0986 471 901	← 48	
	1.6 i				0986 473 901	↻	
	1.6 i GSI				0986 471 902	→ 48	
					0986 473 902	↻	
	1.7 D	03.93-08.00	44	KL	0986 471 899	← 48	
					0986 473 899	↻	
					0986 473 901	↻	
					0986 471 900	→ 48	
					0986 473 900	↻	
					0986 473 902	↻	
				KL	0986 471 895	← 48	
					0986 473 895	↻	
					0986 471 896	→ 48	
					0986 473 896	↻	

	1.0 i	09.96-09.00	40		0986 475 143	↔ 19,05	
	1.2 i	03.93-08.00	33/48		0986 475 143	↔ 19,05	
	1.4 i	03.93-12.05	44/60/63/65/66		0986 475 143	↔ 19,05	
	1.5 D, TD, XD, XTD	03.93-08.00	37/49		0986 475 143	↔ 19,05	
	1.6 GSI, i, i GSI	03.93-12.05	68/74/78/80		0986 475 143	↔ 19,05	
	1.7 D	03.93-08.00	44		0986 475 143	↔ 19,05	

	1.0 i	09.96-09.00	40		1987 477 309	← 1373	
					1987 477 310	→ 1078	
	1.2 i	03.93-08.00	33/48		1987 477 309	← 1373	
					1987 477 310	→ 1078	
	1.4 i	03.93-12.05	44/60/63/ 65/66		1987 477 309	← 1373	
					1987 477 310	→ 1078	
	1.5 D, TD, XD, XTD	03.93-08.00	37/49		1987 477 309	← 1373	
					1987 477 310	→ 1078	
	1.6 GSI, i, i GSI	03.93-12.05	68/74/78/ 80		1987 477 309	← 1373	
					1987 477 310	→ 1078	
	1.7 D	03.93-08.00	44		1987 477 309	← 1373	
					1987 477 310	→ 1078	

	1.0 i	09.96-09.00	40		0986 594 025 <sup>4</sup>		
					0986 594 028 <sup>3</sup>		
	1.2 i	03.93-08.00	33/48		0986 594 025 <sup>4</sup>		
					0986 594 028 <sup>3</sup>		
	1.4 i	03.93-09.00	44/60/63/ 66		0986 594 025 <sup>4</sup>		
					0986 594 028 <sup>3</sup>		
	1.5 D, TD, XD, XTD	03.93-08.00	37/49		0986 594 025 <sup>4</sup>		
					0986 594 028 <sup>3</sup>		
	1.6 GSI, i, i GSI	03.93-08.00	74/78/80		0986 594 025 <sup>4</sup>		
					0986 594 028 <sup>3</sup>		
	1.7 D	03.93-08.00	44		0986 594 025 <sup>4</sup>		
					0986 594 028 <sup>3</sup>		

<b>Corsa [C]</b>							
	1.0 i 12V	ABO	09.00-09.06	43/44	0986 473 271	↻ ← 48	
	1.0 Twinport				0986 474 271	↻ → 48	
		ABS	09.00-09.06	43/44	0986 473 257	↻ ← 48	
					0986 474 257	↻ → 48	
	1.2 i Twinport	ABO	09.00-09.06	55/59	0986 473 271	↻ ← 48	
	1.2 i 16V				0986 474 271	↻ → 48	
		ABS	09.00-09.06	55/59	0986 473 257	↻ ← 48	
					0986 474 257	↻ → 48	

		S							
<b>1.3</b> CDTI			09.03-09.06	51/55			0 986 473 991		← 54
							0 986 474 991		→ 54
<b>1.4</b> i 16V			09.00-09.06	66			0 986 473 991		← 54
<b>1.4</b> Twinport							0 986 474 991		→ 54
<b>1.7</b> CDTI			09.03-09.06	74			0 986 473 062		← 57
							0 986 474 062		→ 57
									1 987 470 005 <sup>7</sup>
<b>1.7</b> DI			09.00-08.03	48			0 986 473 257		← 48
							0 986 474 257		→ 48
<b>1.7</b> DTI			09.00-08.03	55			0 986 473 991		← 54
							0 986 474 991		→ 54
<b>1.8</b> i 16V			09.01-08.05	92			0 986 473 991		← 54
							0 986 474 991		→ 54
	<b>1.0</b> i 12V, Twinport		09.00-09.06	43/44			0 986 475 143		↔ 19,05
	<b>1.2</b> i Twinport, i 16V		09.00-09.06	55/59			0 986 475 143		↔ 19,05
	<b>1.3</b> CDTI		09.03-09.06	51			0 986 475 143		↔ 19,05
	<b>1.4</b> i Sail, i 16V, Twinport		09.00-09.06	65/66			0 986 475 143		↔ 19,05
	<b>1.6</b> i		09.01-08.05	62			0 986 475 143		↔ 19,05
	<b>1.7</b> CDTI		09.03-09.06	74			0 986 475 869		↔ 20,64
	<b>1.7</b> DI, DTI		09.00-08.03	48/55			0 986 475 143		↔ 19,05
	<b>1.3</b> CDTI		09.03-09.06	51/55			0 986 473 256		←
							0 986 474 256		→
	<b>1.4</b> i 16V		09.00-09.06	66			0 986 473 256		←
	<b>1.4</b> Twinport						0 986 474 256		→
	<b>1.6</b> i		09.01-08.05	62			0 986 473 256		←
							0 986 474 256		→
	<b>1.7</b> CDTI		09.00-09.06	48/55/74			0 986 473 256		←
	<b>1.7</b> DI, DTI						0 986 474 256		→
	<b>1.8</b> i 16V		09.01-08.05	92			0 986 473 256		←
							0 986 474 256		→
	<b>1.0</b> i 12V	ABO	09.00-08.03	43/44			1 987 482 251		↔ 217
		ABS	09.00-08.03	43/44			1 987 482 461		↔ 217
	<b>1.0</b> i 12V		09.00-09.06	43/44			1 987 477 667		330
	<b>1.0</b> Twinport					MI	1 987 477 661		→ 832
						Fg.-Nr. →14195342	MI	1 987 477 660	← 1095
						Fg.-Nr. 14195343→	MI,SSZ	1 987 477 660	← 1095
							MI,SSZ	1 987 477 529	← 1106
	<b>1.0</b> Twinport	ABO	09.03-09.06	43/44			1 987 482 251		↔ 217
		ABS	09.03-09.06	43/44			1 987 482 461		↔ 217
	<b>1.2</b> i Twinport	ABO	07.04-09.06	55/59			1 987 482 251		↔ 217
		ABS	07.04-09.06	55/59			1 987 482 461		↔ 217
	<b>1.2</b> i Twinport		09.00-09.06	55/59			1 987 477 667		330
	<b>1.2</b> i 16V					MI	1 987 477 661		→ 832
						Fg.-Nr. →14195342	MI	1 987 477 660	← 1095
						Fg.-Nr. 14195343→	MI,SSZ	1 987 477 660	← 1095
							MI,SSZ	1 987 477 529	← 1106
	<b>1.2</b> i 16V	ABO	09.00-06.04	55/59			1 987 482 251		↔ 217
		ABS	09.00-06.04	55/59			1 987 482 461		↔ 217
	<b>1.3</b> CDTI		09.03-09.06	51			1 987 477 667		330
						HTB,MI	1 987 477 661		→ 832
						HTB,MI,SSZ	1 987 477 660		← 1095
						HTB,MI,SSZ	1 987 477 529		← 1106
						4SB	1 987 477 669		→ 1143
							1 987 477 670		← 1426
			09.05-09.06	55			HTB,MI	1 987 477 661	→ 832
							HTB,MI,SSZ	1 987 477 660	← 1095
							HTB,MI,SSZ	1 987 477 529	← 1106

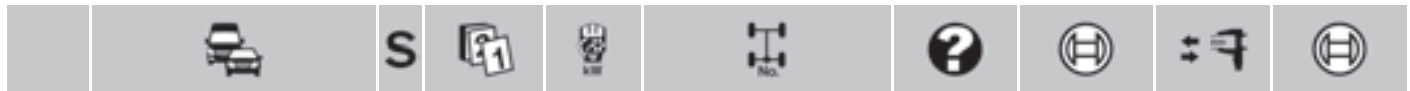

◀ OPEL Corsa [C]

1.3 CDTI		09.05-09.06	55	4SB	1987 477 669	→ 1143	
					1987 477 670	← 1426	
	ABO	09.03-09.06	51/55	HTB	1987 482 251	↔ 217	
	ABS	09.03-09.06	51/55	HTB	1987 482 461	↔ 217	
1.4 i Sail		06.03-12.05	65		1987 477 309	← 1373	
					1987 477 310	→ 1078	
1.4 i 16V	ABO	09.00-08.03	66	HTB	1987 482 251	↔ 217	
	ABS	09.00-08.03	66	HTB	1987 482 461	↔ 217	
1.4 i 16V		09.00-09.06	66		1987 477 667	330	
1.4 Twinport				HTB,MI	1987 477 661	→ 832	
				HTB,MI,SSZ	1987 477 660	← 1095	
				HTB,MI,SSZ	1987 477 529	← 1106	
				4SB	1987 477 669	→ 1143	
1.4 Twinport	ABO	09.03-09.06	66	HTB	1987 482 251	↔ 217	
	ABS	09.03-09.06	66	HTB	1987 482 461	↔ 217	
1.6 i		09.01-08.05	62		1987 477 667	330	
					HTB,MI	1987 477 661	→ 832
					HTB,MI,SSZ	1987 477 660	← 1095
					HTB,MI,SSZ	1987 477 529	← 1106
					4SB	1987 477 669	→ 1143
						1987 477 670	← 1426
	ABO	09.01-08.05	62	HTB	1987 482 251	↔ 217	
	ABS	09.01-08.05	62	HTB	1987 482 461	↔ 217	
1.7 CDTI	ABO	09.03-09.06	48/55/74	HTB	1987 482 251	↔ 217	
	ABS	09.03-09.06	48/55/74	HTB	1987 482 461	↔ 217	
1.7 CDTI		09.00-09.06	48/55/74		1987 477 667	330	
1.7 DI				HTB,MI	1987 477 661	→ 832	
				HTB,MI,SSZ	1987 477 660	← 1095	
1.7 DTI				HTB,MI,SSZ	1987 477 529	← 1106	
				4SB	1987 477 669	→ 1143	
					1987 477 670	← 1426	
1.7 DI	ABO	09.00-08.03	48/55/74	HTB	1987 482 251	↔ 217	
	ABS	09.00-08.03	48/55/74	HTB	1987 482 461	↔ 217	
1.7 DTI	ABO	09.00-08.03	48/55/74	HTB	1987 482 251	↔ 217	
	ABS	09.00-08.03	48/55/74	HTB	1987 482 461	↔ 217	
1.8 i 16V		09.01-08.05	92		1987 477 667	330	
					1987 477 669	→ 1143	
					1987 477 670	← 1426	

	1.0 i 12V, Twinport	09.00-09.06	43/44		0986 594 027 <sup>3</sup>	
	1.2 i Twinport, i 16V	09.00-09.06	55/59		0986 594 027 <sup>3</sup>	
	1.3 CDTI	09.03-09.06	51/55		0986 594 027 <sup>3</sup>	
	1.4 i 16V, Twinport	09.00-09.06	66		0986 594 027 <sup>3</sup>	
	1.6 i	09.01-08.05	62		0986 594 027 <sup>3</sup>	
	1.7 CDTI, DI, DTI	09.00-09.06	48/55/74		0986 594 027 <sup>3</sup>	
	1.8 i 16V	09.01-08.05	92		0986 594 027 <sup>3</sup>	

Corsa [D]



	1.0 Twinport	07.06-10.09	44	INB	0 204 902 032	← 54
					0986 473 487	
					0 204 902 033	→ 54
					0986 474 487	
				INB	0 204 902 030	←
					0 204 902 031	→
					0 204 902 032	← 54
					0986 473 487	
	12.09-→	48			0 204 902 033	→ 54
					0986 474 487	

		S							
<b>1.2</b> LPG		07.06→	51/57/59/				0 204 902 032	←	54
<b>1.2</b> Twinport			63				0 986 473 487		
							0 204 902 033	→	54
							0 986 474 487		
<b>1.3</b> CDTI		07.06-06.10	55		D84		0 204 004 566	←	54
							0 986 134 077		
							0 204 004 567	→	54
							0 986 135 077		
					257		0 204 902 032	←	54
							0 986 473 487		
							0 204 902 033	→	54
							0 986 474 487		
		07.06-07.10	66				0 204 004 566	←	54
							0 986 134 077		
							0 204 004 567	→	54
							0 986 135 077		
		10.06-02.09	66		D84		0 204 004 566	←	54
							0 986 134 077		
							0 204 004 567	→	54
							0 986 135 077		
					257		0 204 902 032	←	54
							0 986 473 487		
							0 204 902 033	→	54
							0 986 474 487		
		12.09→	70		D84		0 204 004 566	←	54
							0 986 134 077		
							0 204 004 567	→	54
							0 986 135 077		
					257		0 204 902 032	←	54
							0 986 473 487		
							0 204 902 033	→	54
							0 986 474 487		
		01.11→	55				0 204 902 032	←	54
							0 986 473 487		
							0 204 902 033	→	54
							0 986 474 487		
<b>1.4</b> LPG		09.09-11.10	64			Fg.-Nr. →74098700, →76034354	0 204 004 564	→	54
							0 986 473 487		
							0 204 004 565	←	54
							0 986 474 487		
						Fg.-Nr. 74098701→, 76034355→	0 204 902 032	←	54
							0 986 473 487		
							0 204 902 033	→	54
							0 986 474 487		
<b>1.4</b> Twinport		07.06-11.10	66			Fg.-Nr. →74098700, →76034354	0 204 004 564	→	54
							0 986 473 487		
							0 204 004 565	←	54
							0 986 474 487		
						Fg.-Nr. 74098701→, 76034355→	0 204 902 032	←	54
							0 986 473 487		
							0 204 902 033	→	54
							0 986 474 487		
		12.09→	64				0 204 902 032	←	54
							0 986 473 487		
							0 204 902 033	→	54
							0 986 474 487		
			74				0 204 902 032	←	54
							0 986 473 487		
							0 204 902 033	→	54
							0 986 474 487		
<b>1.6</b> i OPC Turbo		02.07-10.09	141						1 987 470 005 <sup>7</sup>
		11.09→	141			Fg.-Nr. →B4157375, →B6047744KZB			1 987 470 005 <sup>7</sup>
						Fg.-Nr. B4157376→, B6047745→KZU			1 987 470 005 <sup>7</sup>





		S							
<b>◀ OPEL Corsa [D]</b>									
	<b>1.6 i OPC Turbo</b>	10.11→	155						1 987 470 005 <sup>7</sup>
	<b>1.6 i Turbo</b>	02.07→	110				0 986 473 062	← 57	1 987 470 005 <sup>7</sup>
							0 986 474 062	→ 57	1 987 470 005 <sup>7</sup>
	<b>1.0 Twinport</b>	07.06-10.09	44				0 986 475 949	↔ 19,05	
		12.09→	48				0 986 475 949	↔ 19,05	
	<b>1.2 LPG, Twinport</b>	07.06→	51/57/59/63				0 986 475 949	↔ 19,05	
	<b>1.3 CDTI</b>	07.06→	55/66/70				0 986 475 949	↔ 19,05	
	<b>1.4 LPG, Twinport</b>	07.06→	64/66/74				0 986 475 949	↔ 19,05	
	<b>1.7 CDTI</b>	07.06-02.09	92				0 204 902 004	← 36	
							0 986 134 342		
							0 204 902 005	→ 36	
							0 986 135 342		
		07.06-06.10	92	Fg.-Nr. →84039950, →86011416			0 204 902 004	← 36	
							0 986 134 342		
							0 204 902 005	→ 36	
							0 986 135 342		
	<b>1.0 Twinport</b>	07.06-10.09	44				1 987 482 283		1463
		12.09→	48				1 987 482 283		1463
	<b>1.2 LPG</b>	07.06-12.11	57/59		TW		1 987 482 038		1477
	<b>1.2 Twinport</b>						1 987 482 283		1463
	<b>1.2 Twinport</b>	12.09→	51				1 987 482 283		1463
			63				1 987 482 283		1463
	<b>1.3 CDTI</b>	07.06-06.10	55		TW		1 987 482 283		1463
		07.06-07.10	66				1 987 482 283		1463
		10.06-02.09	66	Fg.-Nr. →74178796, →76065272			1 987 482 038		1477
				Fg.-Nr. 74178797→, 76065273→			1 987 482 282		1478
		10.10→	70				1 987 482 283		1463
	<b>1.4 LPG</b>	07.06-11.10	64/66	Fg.-Nr. →74178796, →76065272			1 987 482 038		1477
	<b>1.4 Twinport</b>			Fg.-Nr. 74178797→, 76065273→			1 987 482 282		1478
	<b>1.7 CDTI</b>	07.06-02.09	92	Fg.-Nr. →74178796, →76065258			1 987 482 039	↔ 1475	
				Fg.-Nr. 74178797→, 76065259→			1 987 482 198	↔ 1460	
		07.06-06.10	92	Fg.-Nr. →74178796, →76065258			1 987 482 039		1475
	<b>1.0 Twinport</b>	07.06-10.09	44				0 265 007 896 <sup>4</sup>		
							0 265 008 089 <sup>3</sup>		
		12.09→	48				0 265 007 896 <sup>4</sup>		
							0 265 008 089 <sup>3</sup>		
	<b>1.2 LPG</b>	07.06→	51/57/59/				0 265 007 896 <sup>4</sup>		
	<b>1.2 Twinport</b>		63				0 265 008 089 <sup>3</sup>		
	<b>1.3 CDTI</b>	07.06-06.10	55				0 265 007 896 <sup>4</sup>		
							0 265 008 089 <sup>3</sup>		
		07.06-07.10	66				0 265 007 896 <sup>4</sup>		
							0 265 008 089 <sup>3</sup>		
		10.06-02.09	66		STB		0 265 007 896 <sup>4</sup>		
					4SB		0 265 007 769 <sup>4</sup>		
		12.09→	70				0 265 007 896 <sup>4</sup>		
							0 265 008 089 <sup>3</sup>		
		01.11→	55				0 265 007 896 <sup>4</sup>		
							0 265 008 089 <sup>3</sup>		
	<b>1.4 LPG</b>	07.06→	64/66/74				0 265 007 896 <sup>4</sup>		
	<b>1.4 Twinport</b>						0 265 008 089 <sup>3</sup>		
	<b>1.4 Twinport Turbo</b>	07.12→	88				0 265 008 089 <sup>3</sup>		
	<b>1.6 i OPC Turbo</b>	10.11→	155				0 265 008 089 <sup>3</sup>		
				Fg.-Nr. →B4999999, →B6999999			0 265 007 769 <sup>4</sup>		
	<b>1.6 i OPC Turbo</b>	02.07-10.09	110/141				0 265 007 769 <sup>4</sup>		
	<b>1.6 i Turbo</b>	02.07→	110/141				0 265 008 089 <sup>3</sup>		
		11.09→	110/141	Fg.-Nr. →B4999999, →B6999999			0 265 007 769 <sup>4</sup>		

		S							
1.7 CDTI		07.06-02.09	92			STB	0 265 007 896 <sup>4</sup>		
						4SB	0 265 007 769 <sup>4</sup>		
		07.06-06.10	92				0 265 007 769 <sup>4</sup>		
							0 265 008 089 <sup>3</sup>		
		12.09→	96				0 265 008 089 <sup>3</sup>		
						Fg.-Nr. →B4999999, →B6999999	0 265 007 769 <sup>4</sup>		
<b>Corsa [E]</b>									
	1.0	10.14→	66/85			308, SBJ			1987 470 005 <sup>7</sup>
						308, SBJ	0 986 473 062	← 57	1987 470 005 <sup>7</sup>
							0 986 474 062	→ 57	1987 470 005 <sup>7</sup>
	1.2	10.14→	51			308, SBJ			1987 470 005 <sup>7</sup>
						308, SBJ	0 986 473 062	← 57	1987 470 005 <sup>7</sup>
							0 986 474 062	→ 57	1987 470 005 <sup>7</sup>
	1.3	10.14→	55/70			308, SBJ			1987 470 005 <sup>7</sup>
						308, SBJ	0 986 473 062	← 57	1987 470 005 <sup>7</sup>
							0 986 474 062	→ 57	1987 470 005 <sup>7</sup>
	1.4	10.14→	55/66/74/ 110			308, SBJ			1987 470 005 <sup>7</sup>
						308, SBJ	0 986 473 062	← 57	1987 470 005 <sup>7</sup>
							0 986 474 062	→ 57	1987 470 005 <sup>7</sup>
	1.6	03.15→	148-152			308, SBJ			1987 470 005 <sup>7</sup>
						308, SBJ	0 986 473 062	← 57	1987 470 005 <sup>7</sup>
							0 986 474 062	→ 57	1987 470 005 <sup>7</sup>
	1.0	10.14→	66/85				0 986 475 949	↔ 19,05	
	1.2	10.14→	51				0 986 475 949	↔ 19,05	
	1.3	10.14→	55/70				0 986 475 949	↔ 19,05	
	1.4	10.14→	55/66/74/110				0 986 475 949	↔ 19,05	
	1.6	03.15→	148-152				0 986 475 949	↔ 19,05	
	1.0	10.14→	66/85				0 265 008 089 <sup>3</sup>		
	1.2	10.14→	51				0 265 008 089 <sup>3</sup>		
	1.3	10.14→	55/70				0 265 008 089 <sup>3</sup>		
	1.4	10.14→	55/66/74/110				0 265 008 089 <sup>3</sup>		
	1.6	03.15→	148-152				0 265 008 089 <sup>3</sup>		
<b>Corsa Hatchback [C]</b>									
	1.4 i Swing	07.01-09.03	65				0 986 475 143	↔ 19,05	
	1.6 i Sail, i Swing	01.00→	68				0 986 475 143	↔ 19,05	
	1.4 i Swing	07.01-09.03	65				1987 477 309	← 1373	
							1987 477 310	→ 1078	
	1.6 i Sail	01.00→	68				1987 477 309	← 1373	
	1.6 i Swing						1987 477 310	→ 1078	
<b>Frontera [A]</b>									
	2.0 i	09.91-08.98	85			Fg.-Nr. →SV720102	0 986 473 306	← 60	
							0 986 474 306	→ 60	
						Fg.-Nr. SV720103→	0 986 473 060	← 60,2	
							0 986 474 060	→ 60,2	
	2.2 i	02.95-08.98	100			Fg.-Nr. →SV720102	0 986 473 306	← 60	
							0 986 474 306	→ 60	













































		S								
<b>◀ OPEL Frontera [A]</b>										
	2.2 i	02.95-08.98	100	Fg.-Nr. SV720103→	0986 473 060		←	60,2		
					0986 474 060		→	60,2		
	2.3 TD	09.91-08.95	74	Fg.-Nr. →SV720102	0986 473 306		←	60		
					0986 474 306		→	60		
				Fg.-Nr. SV720103→	0986 473 060		←	60,2		
					0986 474 060		→	60,2		
	2.4 i	09.91-08.95	92	Fg.-Nr. →SV720102	0986 473 306		←	60		
					0986 474 306		→	60		
				Fg.-Nr. SV720103→	0986 473 060		←	60,2		
					0986 474 060		→	60,2		
	2.5 TDS Turbo	06.96-08.98	85	Fg.-Nr. →SV720102	0986 473 306		←	60		
					0986 474 306		→	60		
				Fg.-Nr. SV720103→	0986 473 060		←	60,2		
					0986 474 060		→	60,2		
	2.8 TDI	02.95-08.98	83	Fg.-Nr. →SV720102	0986 473 306		←	60		
					0986 474 306		→	60		
				Fg.-Nr. SV720103→	0986 473 060		←	60,2		
					0986 474 060		→	60,2		
	2.0 i	09.91-08.98	85		0986 475 807		↔	25,4		
	2.2 i	02.95-08.98	100		0986 475 807		↔	25,4		
	2.3 TD	09.91-08.95	74		0986 475 807		↔	25,4		
	2.4 i	09.91-08.95	92		0986 475 807		↔	25,4		
	2.5 TDS Turbo	06.96-08.98	85		0986 475 807		↔	25,4		
	2.8 TDI	02.95-08.98	83		0986 475 807		↔	25,4		
	2.0 i	02.95-08.98	85		0986 473 059		←	41,2	1987 470 518 <sup>7</sup>	
					0986 474 059		→	41,2	1987 470 518 <sup>7</sup>	
	2.2 i	02.95-08.98	100			0986 473 059		←	41,2	1987 470 518 <sup>7</sup>
						0986 474 059		→	41,2	1987 470 518 <sup>7</sup>
	2.5 TDS Turbo	06.96-08.98	85			0986 473 059		←	41,2	1987 470 518 <sup>7</sup>
						0986 474 059		→	41,2	1987 470 518 <sup>7</sup>
2.8 TDI	02.95-08.98	83			0986 473 059		←	41,2	1987 470 518 <sup>7</sup>	
					0986 474 059		→	41,2	1987 470 518 <sup>7</sup>	
	2.0 i	02.95-08.98	85	Fg.-Nr. WV615055→	1987 482 110		→	1936		
					1987 482 111		←	1936		
					1987 482 170		→	1500		
					1987 482 171		←	1500		
	2.2 i	02.95-08.98	100	Fg.-Nr. WV615055→	1987 482 110		→	1936		
					1987 482 111		←	1936		
					1987 482 170		→	1500		
					1987 482 171		←	1500		
	2.5 TDS Turbo	06.96-08.98	85	Fg.-Nr. WV615055→	1987 482 110		→	1936		
					1987 482 111		←	1936		
					1987 482 170		→	1500		
					1987 482 171		←	1500		
2.8 TDI	02.95-08.98	83	Fg.-Nr. WV615055→	1987 482 110		→	1936			
				1987 482 111		←	1936			
				1987 482 170		→	1500			
				1987 482 171		←	1500			
<b>Frontera [B]</b>										
	2.2 DTI	09.98-09.04	85/88/100		0986 473 060		←	60,2		
	2.2 i				0986 474 060		→	60,2		
	3.2 i	09.98-09.04	151		0986 473 060		←	60,2		
					0986 474 060		→	60,2		

		S							
	2.2 DTI	09.98-09.04	85/88/100				0 986 473 059	← 41,2	1 987 470 518 <sup>7</sup>
	2.2 i						0 986 474 059	→ 41,2	1 987 470 518 <sup>7</sup>
	3.2 i	09.98-09.04	151				0 986 473 059	← 41,2	1 987 470 518 <sup>7</sup>
							0 986 474 059	→ 41,2	1 987 470 518 <sup>7</sup>
<b>Insignia Sports Tourer [35]</b>									
	1.4	09.11→	103		D32		0 986 134 319	← 60	
	1.4 LPG						0 986 135 319	→ 60	
	1.6	02.09→	85/125/ 132		D32		0 986 134 319	← 60	
							0 986 135 319	→ 60	
	1.8	02.09→	103		D32		0 986 134 319	← 60	
							0 986 135 319	→ 60	
	2.0 CDTI, CDTI 4x4, Turbo, Turbo 4x4	02.09→	81/88/96/103/118/ 125/140-143/162/184		D32		0 986 134 319	← 60	
							0 986 135 319	→ 60	
	1.4	09.11→	103		31D,FEB, TW		0 986 134 337	← 41	
							0 986 135 337	→ 41	
	1.6	02.09→	85/125/ 132		31D,FEB, TW		0 986 134 337	← 41	
							0 986 135 337	→ 41	
	1.8	02.09→	103		31D,FEB, TW		0 986 134 337	← 41	
							0 986 135 337	→ 41	
	2.0 CDTI, CDTI 4x4, Turbo, Turbo 4x4	02.09→	81/88/96/103/118/ 140-143/162/184		31D,FEB, TW		0 986 134 337	← 41	
							0 986 135 337	→ 41	
	2.8 Turbo 4x4	02.09→	191/239		FEB,TW		0 986 134 337	← 41	
							0 986 135 337	→ 41	
	2.0 CDTI 4x4	07.09→	118/140- 143/162	Fg.-Nr. →A1006683	FEB		1 987 482 333	↔ 2005	
	2.0 Turbo 4x4	02.09→	118/140- 143/162	Fg.-Nr. →A1006683	FEB		1 987 482 333	↔ 2005	
	2.8 Turbo 4x4	02.09→	191/239	Fg.-Nr. →A1006683	FEB		1 987 482 333	↔ 2005	
<b>Insignia [68]</b>									
	1.4 Turbo	09.11→	103		D32		0 986 134 319	← 60	
	1.4 Turbo LPG						0 986 135 319	→ 60	
	1.6	09.08→	85/125/ 132		D32		0 986 134 319	← 60	
							0 986 135 319	→ 60	
	1.8	09.08→	103		D32		0 986 134 319	← 60	
							0 986 135 319	→ 60	
	2.0 CDTI, CDTI 4x4, Turbo, Turbo 4x4	09.08→	81/88/96/103/118/125/ 140-143/162/184		D32		0 986 134 319	← 60	
							0 986 135 319	→ 60	
	1.4 Turbo	09.11→	103		31D,FEB, TW		0 986 134 337	← 41	
							0 986 135 337	→ 41	
	1.6	09.08→	85/125/ 132		31D,FEB, TW		0 986 134 337	← 41	
							0 986 135 337	→ 41	
	1.8	09.08→	103		31D,FEB, TW		0 986 134 337	← 41	
							0 986 135 337	→ 41	
	2.0 CDTI, CDTI 4x4, Turbo, Turbo 4x4	09.08→	81/88/96/103/118/125/ 140-143/162/184		31D,FEB, TW		0 986 134 337	← 41	
							0 986 135 337	→ 41	
	2.8 Turbo 4x4	09.08→	191/239		FEB,TW		0 986 134 337	← 41	
							0 986 135 337	→ 41	



		S							
◀ OPEL Insignia [68]									
	2.0 CDTI 4x4	07.09→	140-143/ 162	Fg.-Nr. →A1006683	FEB	1987 482 333	↔	2005	
	2.0 Turbo 4x4	09.08→	140-143/ 162	Fg.-Nr. →A1006683	FEB	1987 482 333	↔	2005	
	2.8 Turbo 4x4	09.08→	191/239	Fg.-Nr. →A1006683	FEB	1987 482 333	↔	2005	
Insignia [69]									
	1.4 Turbo	09.11→	103		D32	0986 134 319		← 60	
						0986 135 319		→ 60	
	1.6	09.08→	85/125/ 132		D32	0986 134 319		← 60	
						0986 135 319		→ 60	
	1.8	09.08→	103		D32	0986 134 319		← 60	
						0986 135 319		→ 60	
	2.0 CDTI, CDTI 4x4, Turbo, Turbo 4x4	09.08→	81/88/96/103/118/125/ 140-143/162/184		D32	0986 134 319		← 60	
						0986 135 319		→ 60	
	1.4 Turbo	09.11→	103		31D,FEB, TW	0986 134 337		← 41	
						0986 135 337		→ 41	
	1.6	09.08→	85/125/ 132		31D,FEB, TW	0986 134 337		← 41	
						0986 135 337		→ 41	
	1.8	09.08→	103		31D,FEB, TW	0986 134 337		← 41	
						0986 135 337		→ 41	
	2.0 CDTI, CDTI 4x4, Turbo, Turbo 4x4	09.08→	81/88/96/103/118/ 140-143/162/184		31D,FEB, TW	0986 134 337		← 41	
						0986 135 337		→ 41	
	2.8 Turbo 4x4	09.08→	191/239		FEB,TW	0986 134 337		← 41	
						0986 135 337		→ 41	
	2.0 CDTI 4x4	07.09→	140-143/ 162	Fg.-Nr. →A1006683	FEB	1987 482 333	↔	2005	
	2.0 Turbo 4x4	09.08→	140-143/ 162	Fg.-Nr. →A1006683	FEB	1987 482 333	↔	2005	
	2.8 Turbo 4x4	09.08→	191/239	Fg.-Nr. →A1006683	FEB	1987 482 333	↔	2005	
Meriva [A]									
	1.3 CDTI	09.03-03.10	51/55			0986 473 062		← 57	1987 470 005 <sup>7</sup>
						0986 474 062		→ 57	1987 470 005 <sup>7</sup>
	1.4 i Twinport	07.04-03.10	66		4LO	0986 473 991		← 54	
						0986 474 991		→ 54	
					5LO	0986 473 062		← 57	1987 470 005 <sup>7</sup>
						0986 474 062		→ 57	1987 470 005 <sup>7</sup>
	1.6 i	03.03-09.05	64			0986 473 991		← 54	
						0986 474 991		→ 54	
	1.6 i 16V Twinport	03.03-03.10	74/77			0986 473 062		← 57	1987 470 005 <sup>7</sup>
						0986 474 062		→ 57	1987 470 005 <sup>7</sup>
	1.7 CDTI	03.03-03.10	55/74/92			0986 473 062		← 57	1987 470 005 <sup>7</sup>
	1.7 DTI					0986 474 062		→ 57	1987 470 005 <sup>7</sup>
	1.8 i 16V	03.03-03.10	92			0986 473 062		← 57	1987 470 005 <sup>7</sup>
						0986 474 062		→ 57	1987 470 005 <sup>7</sup>
	1.3 CDTI	09.03-03.10	51/55	Fg.-Nr. →34999999		0986 473 223		← 38,1	
						0986 474 223		→ 38,1	

		S							
<b>1.3 CDTI</b>		09.03-03.10	51/55	Fg.-Nr. 44000001→			0 986 473 258	 ← 38	
							0 986 474 258	 → 38	
<b>1.4 i Twinport</b>		07.04-03.10	66				0 986 473 474	 ← 36	
							0 986 474 474	 → 36	
<b>1.6 i</b>		03.03-09.05	64	Fg.-Nr. →34999999			0 986 473 261	 ← 36	
				Fg.-Nr. 44000001→			0 986 474 261	 → 36	
							0 986 473 474	 ← 36	
							0 986 474 474	 → 36	
<b>1.6 i 16V Twinport</b>		03.03-01.06	74	Fg.-Nr. →34999999			0 986 473 223	 ← 38,1	
				Fg.-Nr. 44000001→			0 986 474 223	 → 38,1	
							0 986 473 258	 ← 38	
							0 986 474 258	 → 38	
<b>1.7 CDTI</b>		03.03-03.10	55/74/92	Fg.-Nr. →34999999			0 986 473 223	 ← 38,1	
<b>1.7 DTI</b>				Fg.-Nr. 44000001→			0 986 474 223	 → 38,1	
							0 986 473 258	 ← 38	
							0 986 474 258	 → 38	
<b>1.8 i 16V</b>		03.03-03.10	92	Fg.-Nr. →34999999			0 986 473 223	 ← 38,1	
				Fg.-Nr. 44000001→			0 986 474 223	 → 38,1	
							0 986 473 258	 ← 38	
							0 986 474 258	 → 38	
									
	<b>1.3 CDTI</b>	09.03-03.10	51/55	Fg.-Nr. →34999999			1 987 477 936		1610
				Fg.-Nr. 44000001→			1 987 477 935		1615
	<b>1.4 i Twinport</b>	07.04-03.10	66	Fg.-Nr. →34999999			1 987 477 936		1610
				Fg.-Nr. 44000001→			1 987 477 935		1615
	<b>1.6 i, i OPC Turbo, i 16V Twinport</b>	03.03-03.10	64/74/77/132	Fg.-Nr. →34999999			1 987 477 936		1610
				Fg.-Nr. 44000001→			1 987 477 935		1615
	<b>1.7 CDTI</b>	03.03-03.10	55/74/92	Fg.-Nr. →34999999			1 987 477 936		1610
	<b>1.7 DTI</b>			Fg.-Nr. 44000001→			1 987 477 935		1615
	<b>1.8 i 16V</b>	03.03-03.10	92	Fg.-Nr. →34999999			1 987 477 936		1610
				Fg.-Nr. 44000001→			1 987 477 935		1615
	<b>1.3 CDTI</b>	09.03-03.10	51/55				0 986 594 027 <sup>3</sup>		
	<b>1.4 i Twinport</b>	07.04-03.10	66				0 986 594 027 <sup>3</sup>		
	<b>1.6 i, i OPC Turbo, i 16V Twinport</b>	03.03-03.10	64/74/77/132				0 986 594 027 <sup>3</sup>		
	<b>1.7 CDTI, DTI</b>	03.03-09.09	55/74				0 986 594 027 <sup>3</sup>		
	<b>1.8 i 16V</b>	03.03-03.10	92				0 986 594 027 <sup>3</sup>		
<b>Meriva [B]</b>									
									
	<b>1.3 CDTI</b>	04.10→	55/70				0 986 473 062	 ← 57	1 987 470 005 <sup>7</sup>
							0 986 474 062	 → 57	1 987 470 005 <sup>7</sup>
	<b>1.4 ecoFLEX, Ecotec, Turbo</b>	04.10→	74/88/103				0 986 473 062	 ← 57	1 987 470 005 <sup>7</sup>
							0 986 474 062	 → 57	1 987 470 005 <sup>7</sup>
	<b>1.6 CDTI</b>	10.13→	70/81/100				0 986 473 062	 ← 57	1 987 470 005 <sup>7</sup>
							0 986 474 062	 → 57	1 987 470 005 <sup>7</sup>
	<b>1.7 CDTI</b>	06.10→	74/81/96				0 986 473 062	 ← 57	1 987 470 005 <sup>7</sup>
							0 986 474 062	 → 57	1 987 470 005 <sup>7</sup>
									
	<b>1.3 CDTI</b>	04.10→	55/70	Fg.-Nr. →C4094247			0 265 008 331 <sup>3</sup>		
				Fg.-Nr. C4094248→			0 265 008 331 <sup>3</sup>		
	<b>1.4 ecoFLEX, Ecotec, Turbo</b>	04.10→	88/103	Fg.-Nr. →C4094247			0 265 008 331 <sup>3</sup>		
				Fg.-Nr. C4094248→			0 265 008 331 <sup>3</sup>		
	<b>1.4 Ecotec</b>	04.10→	74				0 265 008 331 <sup>3</sup>		
	<b>1.6 CDTI</b>	10.13→	70/81/100				0 265 008 331 <sup>3</sup>		
	<b>1.7 CDTI</b>	06.10→	74/81/96	Fg.-Nr. →C4094247			0 265 008 331 <sup>3</sup>		
				Fg.-Nr. C4094248→			0 265 008 331 <sup>3</sup>		

		S				?			
◀ OPEL									
<b>Monterey [A]</b>									
	3.1 TD	09.91-12.97	84				0986 473 060	← 60,2	
							0986 474 060	→ 60,2	
	3.2 i	04.92-12.97	130				0986 473 060	← 60,2	
							0986 474 060	→ 60,2	
	3.1 TD	09.91-12.97	84				0986 473 059	← 41,2	1987 470 518 <sup>7</sup>
							0986 474 059	→ 41,2	1987 470 518 <sup>7</sup>
	3.2 i	04.92-12.97	130				0986 473 059	← 41,2	1987 470 518 <sup>7</sup>
							0986 474 059	→ 41,2	1987 470 518 <sup>7</sup>
<b>Monterey [B]</b>									
	3.0 DTI	02.98-12.99	117				0986 473 060	← 60,2	
							0986 474 060	→ 60,2	
	3.5 iV6	02.98-12.99	158				0986 473 060	← 60,2	
							0986 474 060	→ 60,2	
	3.0 DTI	02.98-12.99	117				0986 473 059	← 41,2	1987 470 518 <sup>7</sup>
							0986 474 059	→ 41,2	1987 470 518 <sup>7</sup>
	3.5 iV6	02.98-12.99	158				0986 473 059	← 41,2	1987 470 518 <sup>7</sup>
							0986 474 059	→ 41,2	1987 470 518 <sup>7</sup>
<b>Movano [A]</b>									
	1.9 D	01.99-10.05	59/60		15Z		0204 102 730	← 45	
	1.9 DTI						0204 103 730		
							0204 102 731	→ 45	
							0204 103 731		
					16Z		0986 473 328	← 45	
							0986 474 328	→ 45	
	2.2 DTI	09.00-10.05	66		15Z		0204 102 730	← 45	
							0204 103 730		
							0204 102 731	→ 45	
							0204 103 731		
					16Z		0986 473 328	← 45	
							0986 474 328	→ 45	
	2.5 D	10.98-03.10	59/73-74		15Z		0204 102 730	← 45	
	2.5 DTI						0204 103 730		
							0204 102 731	→ 45	
							0204 103 731		
					16Z		0986 473 328	← 45	
							0986 474 328	→ 45	
	2.5 DTI	10.01-10.07	84		15Z		0204 102 730	← 45	
							0204 103 730		
							0204 102 731	→ 45	
							0204 103 731		
					16Z		0986 473 328	← 45	
							0986 474 328	→ 45	
		08.06-03.10	88/107		15Z		0204 102 730	← 45	
							0204 103 730		
							0204 102 731	→ 45	
							0204 103 731		

<b>2.5 DTI</b>	09.06-06.10	74			15Z	0 204 <b>102 730</b>	← 45	
						0 204 <b>103 730</b>		
						0 204 <b>102 731</b>	→ 45	
						0 204 <b>103 731</b>		
	ABO 08.06-06.10	74/88/107			16Z	0 986 <b>473 328</b>	← 45	
						0 986 <b>474 328</b>	→ 45	
<b>2.8 DTI</b>	06.98-09.02	84			15Z	0 204 <b>102 730</b>	← 45	
						0 204 <b>103 730</b>		
						0 204 <b>102 731</b>	→ 45	
						0 204 <b>103 731</b>		
					16Z	0 986 <b>473 328</b>	← 45	
						0 986 <b>474 328</b>	→ 45	
<b>3.0 CDTI</b>	03.03-10.05	100			15Z	0 204 <b>102 730</b>	← 45	
						0 204 <b>103 730</b>		
						0 204 <b>102 731</b>	→ 45	
						0 204 <b>103 731</b>		
					16Z	0 986 <b>473 328</b>	← 45	
						0 986 <b>474 328</b>	→ 45	
	<b>1.9 D</b>	01.99-10.05	59/60			F 026 <b>002 532</b>	← 23,8	
	<b>1.9 DTI</b>					F 026 <b>002 533</b>	→ 23,8	
	<b>2.2 DTI</b>	09.00-10.05	66			F 026 <b>002 532</b>	← 23,8	
						F 026 <b>002 533</b>	→ 23,8	
	<b>2.5 D</b>	10.98-06.10	59/73-74/			F 026 <b>002 532</b>	← 23,8	
	<b>2.5 DTI</b>		84/88			F 026 <b>002 533</b>	→ 23,8	
	<b>2.8 DTI</b>	06.98-09.02	84			F 026 <b>002 532</b>	← 23,8	
						F 026 <b>002 533</b>	→ 23,8	
	<b>3.0 CDTI</b>	03.03-10.05	100			F 026 <b>002 532</b>	← 23,8	
						F 026 <b>002 533</b>	→ 23,8	
	<b>1.9 D</b>	01.99-10.01	59			0 204 <b>004 320</b>	← 42	
						0 986 <b>473 260</b>		
						0 204 <b>004 321</b>	→ 42	
						0 986 <b>474 260</b>		
	<b>1.9 DTI</b>	10.01-10.05	60			0 204 <b>004 320</b>	← 42	
						0 986 <b>473 260</b>		
						0 204 <b>004 321</b>	→ 42	
						0 986 <b>474 260</b>		
	<b>2.2 DTI</b>	09.00-10.05	66			0 204 <b>004 320</b>	← 42	
						0 986 <b>473 260</b>		
						0 204 <b>004 321</b>	→ 42	
						0 986 <b>474 260</b>		
	<b>2.5 D</b>	10.98-09.01	59			0 204 <b>004 320</b>	← 42	
						0 986 <b>473 260</b>		
						0 204 <b>004 321</b>	→ 42	
						0 986 <b>474 260</b>		
	<b>2.5 DTI</b>	10.01-10.07	84			0 204 <b>004 320</b>	← 42	
						0 986 <b>473 260</b>		
						0 204 <b>004 321</b>	→ 42	
						0 986 <b>474 260</b>		
		10.01-03.10	73-74			0 204 <b>004 320</b>	← 42	
						0 986 <b>473 260</b>		
						0 204 <b>004 321</b>	→ 42	
						0 986 <b>474 260</b>		
		08.06-03.10	88/107			0 204 <b>004 320</b>	← 42	
						0 986 <b>473 260</b>		
						0 204 <b>004 321</b>	→ 42	
						0 986 <b>474 260</b>		





		S											
<b>◀ OPEL Movano [A]</b>													
	2.5 DTI	09.06-06.10	74				0 204 004 320	← 42					
							0 986 473 260						
	0 204 004 321	→ 42											
	0 986 474 260												
	2.8 DTI	06.98-09.02	84				0 204 004 320	← 42					
							0 986 473 260						
			0 204 004 321	→ 42									
			0 986 474 260										
3.0 CDTI	09.03-10.05	100	0 204 004 320	← 42									
			0 986 473 260										
			0 204 004 321	→ 42									
			0 986 474 260										
<b>U</b>													
	1.9 D	01.99-10.01	59/60				1 987 477 261	↔ 1737					
							1 987 482 013	↔ 1420					
	1.9 D, DTI	01.99-10.05	59/60				1 987 482 012	1175					
							1.9 DTI	10.01-10.05	59/60	ABM	1 987 477 261	↔ 1737	
								1 987 482 013	↔ 1420				
	2.2 DTI	09.00-10.05	66				1 987 482 012	1175					
							ABM	1 987 477 261	↔ 1737				
							1 987 482 013	↔ 1420					
	2.5 D	10.98-09.01	59/73-74				1 987 477 261	↔ 1737					
							1 987 482 013	↔ 1420					
	2.5 D, DTI	10.98-03.10	59/73-74				1 987 482 012	1175					
							2.5 DTI	10.01-10.07	84	ABM	1 987 482 012	1175	
								1 987 477 261	↔ 1737				
								1 987 482 013	↔ 1420				
		10.01-03.10	59/73-74				ABM	1 987 477 261	↔ 1737				
								1 987 482 013	↔ 1420				
		08.06-03.10	88					1 987 482 012	1175				
							ABM	1 987 477 261	↔ 1737				
								1 987 482 013	↔ 1420				
							ABM,TW	1 987 477 261	↔ 1737				
								1 987 482 013	↔ 1420				
			107					1 987 482 012	1175				
							ABM,TW	1 987 477 261	↔ 1737				
								1 987 482 013	↔ 1420				
		09.06-06.10	74					1 987 482 012	1175				
							ABM,TW	1 987 477 261	↔ 1737				
								1 987 482 013	↔ 1420				
	2.8 DTI	06.98-09.02	84				1 987 482 012	1175					
ABM				1 987 477 261	↔ 1737								
				1 987 482 013	↔ 1420								
3.0 CDTI	03.03-10.05	100	1 987 482 012	1175									
			ABM	1 987 477 261	↔ 1737								
				1 987 482 013	↔ 1420								
<b>Omega [A]</b>													
	1.8	09.86-03.94	60/65/66/85	Fg.-Nr. →L1019854			DMO	0 986 471 004	← 54	1 987 470 060 <sup>7</sup>			
								0 986 473 004		1 987 470 498 <sup>8</sup>			
								0 986 472 004	→ 54	1 987 470 060 <sup>7</sup>			
	1.8 S							0 986 474 004					
									Fg.-Nr. L1019855→	ATE	0 986 473 913	← 54	1 987 470 060 <sup>7</sup>
											0 986 473 913	← 54	1 987 470 498 <sup>8</sup>
								0 986 473 914	→ 54	1 987 470 060 <sup>7</sup>			
	2.0 i	09.86-03.94	85/90	Fg.-Nr. →K1000098				DMO	0 986 471 005	← 54	1 987 470 060 <sup>7</sup>		
									0 986 473 005		1 987 470 498 <sup>8</sup>		
									0 986 472 005	→ 54	1 987 470 060 <sup>7</sup>		
								0 986 474 005					

		S							
2.0i	09.86-03.94	85/90	Fg.-Nr. K1000099→	ATE	0 986 473 913		← 54	1 987 470 060 <sup>7</sup>	
					0 986 473 913		← 54	1 987 470 498 <sup>8</sup>	
					0 986 473 914		→ 54	1 987 470 060 <sup>7</sup>	
2.3D 2.3TD	09.86-03.94	54/74	Fg.-Nr. →L1019854	DMO	0 986 471 004		← 54	1 987 470 060 <sup>7</sup>	
					0 986 473 004			1 987 470 498 <sup>8</sup>	
					0 986 472 004		→ 54	1 987 470 060 <sup>7</sup>	
			Fg.-Nr. L1019855→	ATE	0 986 473 913		← 54	1 987 470 060 <sup>7</sup>	
					0 986 473 913		← 54	1 987 470 498 <sup>8</sup>	
					0 986 473 914		→ 54	1 987 470 060 <sup>7</sup>	
2.4i	09.88-03.94	92	Fg.-Nr. →K1000098	DMO	0 986 471 005		← 54	1 987 470 060 <sup>7</sup>	
					0 986 473 005			1 987 470 498 <sup>8</sup>	
					0 986 472 005		→ 54	1 987 470 060 <sup>7</sup>	
			Fg.-Nr. K1000099→	ATE	0 986 473 913		← 54	1 987 470 060 <sup>7</sup>	
					0 986 473 913		← 54	1 987 470 498 <sup>8</sup>	
					0 986 473 914		→ 54	1 987 470 060 <sup>7</sup>	
2.6i	09.90-03.94	110	Fg.-Nr. →L1999999	ATE	0 986 474 860		← 60		
					0 986 474 861		→ 60		
			Fg.-Nr. M1000001→	GIR	0 986 473 820		← 57		
					0 986 473 821		→ 57		
3.0i	01.88-03.94	130	Fg.-Nr. →L1999999	ATE	0 986 474 860		← 60		
					0 986 474 861		→ 60		
			Fg.-Nr. M1000001→	GIR	0 986 473 820		← 57		
					0 986 473 821		→ 57		
	09.89-03.94	147-150		GIR	0 986 473 820		← 57		
					0 986 473 821		→ 57		
<hr/>									
1.8 1.8i 1.8S	09.86-03.94	60/65/66/ 85	Fg.-Nr. →K1000098	LIM	0 986 473 945		←		
					0 986 473 947		←		
					0 986 473 946		→		
					0 986 473 948		→		
			Fg.-Nr. →K1042197	KOB	0 986 473 957		← 38		
					0 986 473 958		→ 38		
			Fg.-Nr. K1000099→	LIM	0 986 473 949		← 35		
					0 986 473 950		→ 35		
			Fg.-Nr. K1042198→	KOB	0 986 473 307		← 40		
					0 986 474 307		→ 40		
2.0i	09.86-03.94	85/90	Fg.-Nr. →K1000098	LIM	0 986 473 945		←		
					0 986 473 947		←		
					0 986 473 946		→		
					0 986 473 948		→		
			Fg.-Nr. →K1042197	KOB	0 986 473 957		← 38		
					0 986 473 958		→ 38		
			Fg.-Nr. K1000099→	LIM	0 986 473 949		← 35		
					0 986 473 950		→ 35		
			Fg.-Nr. K1042198→	KOB	0 986 473 307		← 40		
					0 986 474 307		→ 40		
2.3D 2.3TD	09.86-03.94	54/74	Fg.-Nr. →K1000098	LIM	0 986 473 945		←		
					0 986 473 947		←		
					0 986 473 946		→		
					0 986 473 948		→		
			Fg.-Nr. →K1042197	KOB	0 986 473 957		← 38		
					0 986 473 958		→ 38		
			Fg.-Nr. K1000099→	LIM	0 986 473 949		← 35		
					0 986 473 950		→ 35		
			Fg.-Nr. K1042198→	KOB	0 986 473 307		← 40		
					0 986 474 307		→ 40		





	◀ OPEL Omega [A]										
	2.4 i	09.88-03.94	92	Fg.-Nr. →K1000098	LIM	0986 473 945					
						0986 473 947					
						0986 473 946					
						0986 473 948					
				Fg.-Nr. →K1042197	KOB	0986 473 957					38
						0986 473 958					38
	Fg.-Nr. K1000099→	LIM	0986 473 949		35						
			0986 473 950		35						
	Fg.-Nr. K1042198→	KOB	0986 473 307		40						
			0986 474 307		40						
	2.6 i	09.90-03.94	110		KOB	0986 473 307		40			
						0986 474 307		40			
Fg.-Nr. →K1000098				LIM	0986 473 945						
					0986 473 947						
					0986 473 946						
					0986 473 948						
Fg.-Nr. K1000099→	LIM	0986 473 949		35							
		0986 473 950		35							
3.0 i	01.88-03.94	130		KOB	0986 473 307		40				
					0986 474 307		40				
			Fg.-Nr. →K1000098	LIM	0986 473 945						
					0986 473 947						
					0986 473 946						
					0986 473 948						
Fg.-Nr. K1000099→	LIM	0986 473 949		35							
		0986 473 950		35							
	09.89-03.94	147-150		KOB	0986 473 307		40				
				0986 474 307		40					
			LIM	0986 473 957		38					
				0986 473 958		38					



	1.8	09.86-03.94	60/65/66/85		1987 477 250		1550
	1.8 i	09.86-03.94	60/65/66/85		1987 477 250		1550
	1.8 S	09.86-03.94	60/65/66/85		1987 477 250		1550
	2.0 i	09.86-03.94	85/90		1987 477 250		1550
	2.3 D	09.86-03.94	54/74		1987 477 250		1550
	2.3 TD	09.88-03.94	54/74		1987 477 250		1550
	2.4 i	09.88-03.94	92		1987 477 250		1550
	2.6 i	09.90-03.94	110		1987 477 250		1550
	3.0 i	01.88-03.94	130/147-150		1987 477 250		1550
	3.6 i	01.90-03.94	277-281		1987 477 250		1550

	1.8	09.86-03.94	60/65/66/		0265 001 134		
	1.8 i		85	Fg.-Nr. →J1185909	0265 001 143		
	1.8 S			Fg.-Nr. J1185910→	0265 001 220		
	2.0 i	09.86-03.94	85/90		0265 001 134		
				Fg.-Nr. →J1185909	0265 001 143		
				Fg.-Nr. J1185910→	0265 001 220		
	2.3 D	09.86-03.94	54/74		0265 001 134		
	2.3 TD			Fg.-Nr. →J1185909	0265 001 143		
				Fg.-Nr. J1185910→	0265 001 220		
	2.4 i	09.88-03.94	92		0265 001 134		
				Fg.-Nr. →J1185909	0265 001 143		
				Fg.-Nr. J1185910→	0265 001 220		
	2.6 i	09.90-03.94	110		0265 001 134		
				Fg.-Nr. →J1185909	0265 001 143		
				Fg.-Nr. J1185910→	0265 001 220		
	3.0 i	01.88-03.94	130/ 147-150		0265 001 134		
				Fg.-Nr. →J1185909	0265 001 143		
				Fg.-Nr. J1185910→	0265 001 220		



**Omega [B]**

Model	Year Range	Power	Options	Part Number	Direction
<b>2.0 DTI Turbo</b>	09.97-08.00	74		0 986 473 820	← 57
				0 986 473 821	→ 57
<b>2.0i</b>	09.93-08.99	85/100	ERH,KOB	0 986 473 820	← 57
				0 986 473 821	→ 57
			Fg.-Nr. →V1999999	0 986 473 297	← 54
				0 986 474 297	→ 54
			Fg.-Nr. W1000001→	0 986 473 820	← 57
				0 986 473 821	→ 57
<b>2.2 DTI</b>	09.99-09.03	88/103-106		0 986 473 820	← 57
<b>2.2i</b>				0 986 473 821	→ 57
<b>2.5 DTI Turbo</b>	06.01-09.03	110		0 986 473 820	← 57
				0 986 473 821	→ 57
<b>2.5i</b>	04.94-11.00	125		0 986 473 820	← 57
				0 986 473 821	→ 57
<b>2.5 TD</b>	04.94-02.01	96		0 986 473 820	← 57
				0 986 473 821	→ 57
<b>2.6i</b>	09.00-09.03	132		0 986 473 820	← 57
				0 986 473 821	→ 57
<b>3.0i</b>	04.94-02.01	155		0 986 473 820	← 57
				0 986 473 821	→ 57
<b>3.2i</b>	09.00-09.03	160		0 986 473 820	← 57
				0 986 473 821	→ 57
<b>2.0 DTI Turbo</b>	09.93-08.00	74/85/100	Fg.-Nr. →W1069516	0 986 473 119	← 39,93
<b>2.0i</b>				0 986 474 119	→ 39,93
			Fg.-Nr. W1069517→Y1999999	0 986 473 119	← 39,93
				0 986 474 119	→ 39,93
			Fg.-Nr. 11000001→11999999	0 986 134 041	← 42
				0 986 135 041	→ 42
<b>2.2 DTI</b>	09.99-09.03	88/103-106	Fg.-Nr. →W1069516	0 986 473 119	← 39,93
<b>2.2i</b>				0 986 474 119	→ 39,93
			Fg.-Nr. W1069517→Y1999999	0 986 473 119	← 39,93
				0 986 474 119	→ 39,93
			Fg.-Nr. 11000001→	0 986 134 041	← 42
				0 986 135 041	→ 42
<b>2.5 DTI Turbo</b>	06.01-09.03	110	Fg.-Nr. 21000001→	0 986 134 041	← 42
				0 986 135 041	→ 42
<b>2.5i</b>	04.94-11.00	125	Fg.-Nr. →W1069516	0 986 473 119	← 39,93
				0 986 474 119	→ 39,93
			Fg.-Nr. W1069517→Y1999999	0 986 473 119	← 39,93
				0 986 474 119	→ 39,93
			Fg.-Nr. 11000001→	0 986 134 041	← 42
				0 986 135 041	→ 42
<b>2.5 TD</b>	04.94-02.01	96	Fg.-Nr. →W1069516	0 986 473 119	← 39,93
				0 986 474 119	→ 39,93
			Fg.-Nr. W1069517→Y1999999	0 986 473 119	← 39,93
				0 986 474 119	→ 39,93
			Fg.-Nr. 11000001→11999999	0 986 134 041	← 42
				0 986 135 041	→ 42
	04.96-11.00	96	Fg.-Nr. 11000001→	0 986 134 041	← 42
				0 986 135 041	→ 42
<b>2.6i</b>	09.00-09.03	132	Fg.-Nr. 21000001→	0 986 134 041	← 42
				0 986 135 041	→ 42
<b>3.0i</b>	04.94-02.01	155	Fg.-Nr. →W1069516	0 986 473 119	← 39,93
				0 986 474 119	→ 39,93
			Fg.-Nr. W1069517→Y1999999	0 986 473 119	← 39,93
				0 986 474 119	→ 39,93



		S											
<b>◀ OPEL Omega [B]</b>													
	3.0 i	04.94-02.01	155	Fg.-Nr. 11000001→11999999			0986 <b>134 041</b>		← 42				
							0986 <b>135 041</b>		→ 42				
	3.2 i	09.00-09.03	160	Fg.-Nr. 21000001→			0986 <b>134 041</b>		← 42				
							0986 <b>135 041</b>		→ 42				
	2.0 DTI Turbo, i	09.93-08.00	74/85/100				1987 <b>477 250</b>		1550				
	2.2 DTI, i	09.99-09.03	88/103-106				1987 <b>477 250</b>		1550				
	2.5 DTI Turbo	06.01-09.03	110				1987 <b>477 250</b>		1550				
	2.5 i	04.94-11.00	125				1987 <b>477 250</b>		1550				
	2.5 TD	04.94-02.01	96				1987 <b>477 250</b>		1550				
	2.6 i	09.00-09.03	132				1987 <b>477 250</b>		1550				
	3.0 i	04.94-02.01	155				1987 <b>477 250</b>		1550				
	3.2 i	09.00-09.03	160				1987 <b>477 250</b>		1550				
<b>Signum</b>													
	1.8 i	05.03-02.05	90	Fg.-Nr. →51064146			0986 <b>134 018</b>		← 57				
							0986 <b>135 018</b>		→ 57				
							Fg.-Nr. 51064147→	0986 <b>134 018</b>		← 57			
		09.05-09.08	103		BHO	0986 <b>135 018</b>		→ 57					
						0986 <b>134 081</b>		← 57					
						0986 <b>135 081</b>		→ 57					
				BHO	0986 <b>134 018</b>		← 57						
					0986 <b>135 018</b>		→ 57						
	1.9 CDTI	04.04-09.08	74/88/110	Fg.-Nr. →51064146				0986 <b>134 018</b>		← 57			
								0986 <b>135 018</b>		→ 57			
								Fg.-Nr. 51064147→	0986 <b>134 018</b>		← 57		
							0986 <b>135 018</b>		→ 57				
							2.0 DTI	05.03-09.05	74	Fg.-Nr. →51064146			
0986 <b>135 018</b>		→ 57											
Fg.-Nr. 51064147→	0986 <b>134 018</b>		← 57										
							0986 <b>135 018</b>		→ 57				
							2.0 Turbo	05.03-09.08	129				
0986 <b>474 308</b>		→ 60											
2.2 Direct	05.03-09.08	86-92/114	Fg.-Nr. →51064146				0986 <b>134 018</b>		← 57				
							0986 <b>135 018</b>		→ 57				
							Fg.-Nr. 51064147→	0986 <b>134 018</b>		← 57			
							0986 <b>135 018</b>		→ 57				
							3.0 CDTI	05.03-09.08	130-135	Fg.-Nr. →31068238			
0986 <b>474 308</b>		→ 60											
Fg.-Nr. 31068239→	0986 <b>135 056</b>		← 60										
							0986 <b>134 056</b>		→ 60				
							3.2 V6	05.03-09.05	155	Fg.-Nr. →31068238			
0986 <b>474 308</b>		→ 60											
Fg.-Nr. 31068239→	0986 <b>135 056</b>		← 60										
							0986 <b>134 056</b>		→ 60				
	1.8 i	05.03-02.05	90	Fg.-Nr. →41085480		INB	0986 <b>473 172</b>		← 37,93				
							0986 <b>474 172</b>		→ 37,93				
							Fg.-Nr. 41085481→	0986 <b>134 070</b>		← 40			
		09.05-09.08	103		Fg.-Nr. →41085480		INB	0986 <b>135 070</b>		→ 40			
								0986 <b>473 172</b>		← 37,93			
								0986 <b>474 172</b>		→ 37,93			
								0986 <b>134 070</b>		← 40			
								0986 <b>135 070</b>		→ 40			
	1.9 CDTI	04.04-09.08	74/88/110	Fg.-Nr. →41085480			INB	0986 <b>473 172</b>		← 37,93			
								0986 <b>474 172</b>		→ 37,93			
								Fg.-Nr. 41085481→	0986 <b>134 070</b>		← 40		
							0986 <b>135 070</b>		→ 40				





		S							
<b>2.0 DTI</b> <b>2.0 Turbo</b>		05.03-09.08	74/129	Fg.-Nr. →41085480	INB		0 986 <b>473 172</b>		← 37,93
							0 986 <b>474 172</b>		→ 37,93
				Fg.-Nr. 41085481→	INB		0 986 <b>134 070</b>		← 40
							0 986 <b>135 070</b>		→ 40
<b>2.2 Direct</b> <b>2.2 DTI</b>		05.03-09.08	86-92/114	Fg.-Nr. →41085480	INB		0 986 <b>473 172</b>		← 37,93
							0 986 <b>474 172</b>		→ 37,93
				Fg.-Nr. 41085481→	INB		0 986 <b>134 070</b>		← 40
							0 986 <b>135 070</b>		→ 40
<b>2.8 V6 Turbo</b>		09.05-09.08	169/184	Fg.-Nr. →41085480	INB		0 986 <b>473 172</b>		← 37,93
							0 986 <b>474 172</b>		→ 37,93
				Fg.-Nr. 41085481→	INB		0 986 <b>134 070</b>		← 40
							0 986 <b>135 070</b>		→ 40
<b>3.0 CDTI</b>		05.03-09.08	130-135	Fg.-Nr. →41085480	INB		0 986 <b>473 172</b>		← 37,93
							0 986 <b>474 172</b>		→ 37,93
				Fg.-Nr. 41085481→	INB		0 986 <b>134 070</b>		← 40
							0 986 <b>135 070</b>		→ 40
<b>3.2 V6</b>		05.03-09.05	155	Fg.-Nr. →41085480	INB		0 986 <b>473 172</b>		← 37,93
							0 986 <b>474 172</b>		→ 37,93
				Fg.-Nr. 41085481→	INB		0 986 <b>134 070</b>		← 40
							0 986 <b>135 070</b>		→ 40
	<b>1.8 i</b>	05.03-02.05	90				1 987 <b>477 907</b>		↔ 1805
							09.05-09.08	103	1 987 <b>477 907</b>
	<b>1.9 CDTI</b>	04.04-09.08	74/88/110				1 987 <b>477 907</b>		↔ 1805
	<b>2.0 DTI</b>	05.03-09.05	74/129				1 987 <b>477 907</b>		↔ 1805
	<b>2.0 Turbo</b>	05.03-09.08	74/129				1 987 <b>477 907</b>		↔ 1805
	<b>2.2 Direct</b>	05.03-09.08	86-92/114				1 987 <b>477 907</b>		↔ 1805
	<b>2.2 DTI</b>	05.03-09.05	86-92/114				1 987 <b>477 907</b>		↔ 1805
	<b>2.8 V6 Turbo</b>	09.05-09.08	169/184				1 987 <b>477 907</b>		↔ 1805
	<b>3.0 CDTI</b>	05.03-09.08	130-135				1 987 <b>477 907</b>		↔ 1805
	<b>3.2 V6</b>	05.03-09.05	155				1 987 <b>477 907</b>		↔ 1805
<b>Sintra</b>									
	<b>2.2 i 16V</b>	09.96-09.99	85/104				1 987 <b>477 762</b>		↔ 2583
							09.96-09.99	85/104	1 987 <b>477 761</b>
	<b>2.2 TD</b>	09.97-09.99	85/104				1 987 <b>477 762</b>		↔ 2583
	<b>3.0 i 24V</b>	09.96-09.99	148				1 987 <b>477 761</b>		← 799
							1 987 <b>477 762</b>		↔ 2583
<b>Tigra [A]</b>									
	<b>1.4 i</b>	09.94-08.99	63-66				0 986 <b>471 901</b>		← 48
							0 986 <b>473 901</b>		
							0 986 <b>471 902</b>		→ 48
							0 986 <b>473 902</b>		
	<b>1.6 i</b>	09.94-08.99	74/78				0 986 <b>471 901</b>		← 48
	<b>1.6 i 16V</b>						0 986 <b>473 901</b>		
							0 986 <b>471 902</b>		→ 48
							0 986 <b>473 902</b>		
	<b>1.4 i</b>	09.94-08.99	63-66				0 986 <b>475 143</b>		↔ 19,05
							09.94-08.99	74/78	0 986 <b>475 143</b>
	<b>1.4 i</b>	09.94-08.99	63-66				1 987 <b>477 309</b>		← 1373
							1 987 <b>477 310</b>		→ 1078

		S							
	<b>◀ OPEL Tigua [A]</b>								
	1.6 i	09.94-08.99	74/78				1987 477 309	← 1373	
	1.6 i 16V						1987 477 310	→ 1078	
	1.4 i	09.94-08.99	63-66				0986 594 025 <sup>4</sup>		
	1.6 i	09.94-08.99	74/78				0986 594 028 <sup>3</sup>		
	1.6 i 16V						0986 594 025 <sup>4</sup>		
							0986 594 028 <sup>3</sup>		
<b>Tigra TwinTop [B]</b>									
	1.3 CDTI	06.04-03.09	51				0986 473 991	← 54	
							0986 474 991	→ 54	
	1.4 i	06.04-12.09	66				0986 473 991	← 54	
							0986 474 991	→ 54	
	1.8 i	06.04-12.09	92				0986 473 991	← 54	
							0986 474 991	→ 54	
	1.3 CDTI	06.04-03.09	51				0986 475 143	↔ 19,05	
	1.4 i	06.04-12.09	66				0986 475 143	↔ 19,05	
	1.8 i	06.04-12.09	92				0986 475 143	↔ 19,05	
	1.3 CDTI	06.04-03.09	51				0986 473 256	←	
							0986 474 256	→	
	1.4 i	06.04-12.09	66				0986 473 256	←	
							0986 474 256	→	
	1.8 i	06.04-12.09	92				0986 473 256	←	
							0986 474 256	→	
	1.3 CDTI	ABO 06.04-03.09	51				1987 482 139	→ 1143	
							1987 482 140	← 1426	
		ABS 06.04-03.09	51				1987 477 660	← 1095	
							1987 477 661	→ 832	
	1.4 i	ABO 06.04-12.09	66				1987 482 139	→ 1143	
							1987 482 140	← 1426	
		ABS 06.04-12.09	66				1987 477 660	← 1095	
							1987 477 661	→ 832	
	1.8 i	ABO 06.04-12.09	92				1987 482 139	→ 1143	
							1987 482 140	← 1426	
		ABS 06.04-12.09	92				1987 477 660	← 1095	
							1987 477 661	→ 832	
	1.3 CDTI	06.04-03.09	51				0986 594 027 <sup>3</sup>		
	1.4 i	06.04-12.09	66				0986 594 027 <sup>3</sup>		
	1.8 i	06.04-12.09	92				0986 594 027 <sup>3</sup>		
<b>Vectra [A]</b>									
	1.6 i	09.92-08.95	55			Fg.-Nr. →R7999999, →R1999999, →R5999999	ATE 0986 471 901	← 48	
							0986 473 901		
							0986 471 902	→ 48	
							0986 473 902		
						Fg.-Nr. S1000001→, S5000001→, S7500001→	ATE 0986 473 905	← 52	
							0986 473 906	→ 52	
		09.93-08.95	52			Fg.-Nr. →N1038529, →M5999999	ATE 0986 473 889	← 48	
							0986 473 890	→ 48	

		S							
1.6i	09.93-08.95	52	Fg.-Nr. N1038530→, N5000001→	ATE	0 986 471 899	← 48			
					0 986 473 899				
					0 986 473 901				
					0 986 471 900	→ 48			
					0 986 473 900				
					0 986 473 902				
1.6i KAT	09.88-08.95	55-60	Fg.-Nr. →N1038529, →M5999999	ATE	0 986 473 889	← 48			
1.6S					0 986 473 890	→ 48			
			Fg.-Nr. N1038530→, N5000001→	ATE	0 986 471 899	← 48			
					0 986 473 899				
					0 986 473 901				
					0 986 471 900	→ 48			
					0 986 473 900				
					0 986 473 902				
1.7D	10.88-08.95	42/60	Fg.-Nr. →R7999999, →R1999999,	ATE	0 986 471 901	← 48			
1.7TD			→R5999999		0 986 473 901				
					0 986 471 902	→ 48			
					0 986 473 902				
			Fg.-Nr. S1000001→, S5000001→,	ATE	0 986 473 905	← 52			
			S7500001→		0 986 473 906	→ 52			
1.8	09.88-08.95	65/66	Fg.-Nr. →R7999999, →R1999999,	ATE	0 986 471 901	← 48			
1.8i			→R5999999		0 986 473 901				
1.8S					0 986 471 902	→ 48			
					0 986 473 902				
			Fg.-Nr. S1000001→, S5000001→,	ATE	0 986 473 905	← 52			
			S7500001→		0 986 473 906	→ 52			
1.8S 4x4	01.89-08.95	65/66		AA	ATE	0 986 473 913	← 54		
1.8 4x4						0 986 473 914	→ 54		
2.0i	09.88-08.95	74-85		ATE	0 986 473 905	← 52			
					0 986 473 906	→ 52			
		95		ATE	0 986 473 905	← 52			
					0 986 473 906	→ 52			
2.0i 4x4	01.89-08.95	85		AA	ATE	0 986 473 913	← 54		
						0 986 473 914	→ 54		
		95		AA	ATE	0 986 473 913	← 54		
						0 986 473 914	→ 54		
2.0i 16V	09.92-08.95	100/110		ATE	0 986 473 905	← 52			
					0 986 473 906	→ 52			
	1.6i, i KAT, S	09.88-08.95	52/55-60		0 986 475 143	↔ 19,05			
	1.7D, TD	10.88-08.95	42/60		0 986 475 143	↔ 19,05			
	1.8, i, S, S 4x4, 4x4	09.88-08.95	65/66		0 986 475 143	↔ 19,05			
	2.0i	09.88-08.95	74-85		0 986 473 947	← 35			
					0 986 473 948	→ 35			
		95			0 986 473 947	← 35			
					0 986 473 948	→ 35			
	2.0i 4x4	01.89-08.95	85	AA	0 986 473 943	← 33			
					0 986 473 944	→ 33			
		95		AA	0 986 473 943	← 33			
					0 986 473 944	→ 33			
	2.0i 4x4 Turbo	09.92-08.95	150	AA	0 986 473 943	← 33			
					0 986 473 944	→ 33			
	2.0i 16V	09.92-08.95	100/110		0 986 473 947	← 35			
					0 986 473 948	→ 35			
	2.5i	02.93-08.95	125		0 986 473 947	← 35			
					0 986 473 948	→ 35			





									
◀ OPEL Vectra [A]									
									
	1.6 i, i KAT	09.88-08.95	52/55-60			1987 477 140	← 750		
	1.6 S					1987 477 141	→ 2079		
	1.7 D	10.88-08.95	42/60			1987 477 140	← 750		
	1.7 TD					1987 477 141	→ 2079		
	1.8	09.88-08.95	65/66			1987 477 140	← 750		
	1.8 i, S, S 4x4, 4x4					1987 477 141	→ 2079		
	2.0 i, i 4x4, i 16V	09.88-08.95	74-85/95/ 100			1987 477 142	← 665		
						1987 477 143	→ 2022		
	2.0 i 4x4 Turbo	09.92-08.95	150			1987 477 130	↔ 1498		
	2.0 i 16V	09.92-08.95	110	Fg.-Nr. →N1999999, →N5999999, →NV999999		1987 477 130	↔ 1498		
				Fg.-Nr. P1000001→, P5000001→, P7500001→		1987 477 142	← 665		
						1987 477 143	→ 2022		
	2.5 i	02.93-08.95	125			1987 477 142	← 665		
						1987 477 143	→ 2022		
	1.6 i	09.88-08.95	52/55-60	Fg.-Nr. →M1999999, →N5000039, →MV999999		0 265 001 206 <sup>3</sup>			
	1.6 i KAT								
	1.6 S			Fg.-Nr. →NV999999, L10,RAB →N1999999, →N5999999 L13,LAB		0 265 001 207 <sup>4</sup>			
	1.7 D	10.88-08.95	42/60	Fg.-Nr. →M1999999, →N5000039, →MV999999		0 265 001 206 <sup>3</sup>			
	1.7 TD								
					Fg.-Nr. →NV999999, L10,RAB →N1999999, →N5999999 L13,LAB	0 265 001 207 <sup>4</sup>			
	1.8, i, S	09.88-08.95	65/66	Fg.-Nr. →NV999999, L10,RAB →N1999999, →N5999999 L13,LAB		0 265 001 207 <sup>4</sup>			
	1.8, i, S, S 4x4, 4x4	09.88-08.95	65/66	Fg.-Nr. →M1999999, →N5000039, →MV999999		0 265 001 206 <sup>3</sup>			
	1.8 S 4x4	01.89-08.95	65/66	Fg.-Nr. →M1999999	AA,LAB	0 265 001 226 <sup>4</sup>			
	1.8 4x4			Fg.-Nr. N1000001→	AA,LAB AA,RAB	0 265 006 487 <sup>4</sup> 0 265 006 486 <sup>4</sup>			
	2.0 i	09.88-08.95	74-85	Fg.-Nr. →M1999999, →N5000039, →MV999999		0 265 001 206 <sup>3</sup>			
					Fg.-Nr. →NV999999, L10,RAB →N1999999, →N5999999 L13,LAB	0 265 001 207 <sup>4</sup> 0 265 001 208 <sup>4</sup>			
			95	Fg.-Nr. →NV999999, L10,RAB →N1999999, →N5999999 L13,LAB		0 265 001 207 <sup>4</sup> 0 265 001 208 <sup>4</sup>			
	2.0 i	09.88-08.95	95	Fg.-Nr. →M1999999, →N5000039, →MV999999		0 265 001 206 <sup>3</sup>			
	2.0 i 4x4								
	2.0 i 4x4	01.89-08.95	85	Fg.-Nr. →M1999999	AA,LAB	0 265 001 226 <sup>4</sup>			
				Fg.-Nr. →M1999999, →N5000039, →MV999999		0 265 001 206 <sup>3</sup>			
				Fg.-Nr. N1000001→	AA,LAB AA,RAB	0 265 006 487 <sup>4</sup> 0 265 006 486 <sup>4</sup>			
			95	Fg.-Nr. →M1999999	AA,LAB	0 265 001 226 <sup>4</sup>			
				Fg.-Nr. N1000001→	AA,LAB AA,RAB	0 265 006 487 <sup>4</sup> 0 265 006 486 <sup>4</sup>			
	2.0 i 4x4 Turbo	09.92-08.95	150	Fg.-Nr. →M1999999	AA,LAB	0 265 001 226 <sup>4</sup>			
				Fg.-Nr. →M1999999, →N5000039, →MV999999		0 265 001 206 <sup>3</sup>			
				Fg.-Nr. N1000001→	AA,LAB AA,RAB	0 265 006 487 <sup>4</sup> 0 265 006 486 <sup>4</sup>			
	2.0 i 16V	09.92-08.95	110	Fg.-Nr. →MV999999, LAB →M1999999, →M5999999 RAB		0 265 001 233 <sup>4</sup> 0 265 001 232 <sup>4</sup>			
				Fg.-Nr. →M1999999, →N5000039, →MV999999		0 265 001 206 <sup>3</sup>			
				Fg.-Nr. NV100001→	LAB	0 265 003 094 <sup>4</sup>			
				NV999999, N1000001→	RAB	0 265 003 093 <sup>4</sup>			
				N1999999, N5000001→					
				N5999999					

		<b>S</b>							
2.0i 16V		11.93-08.95	100	Fg.-Nr. →M1999999, →N5000039, →MV999999			0 265 001 206 <sup>3</sup>		
				Fg.-Nr. →NV999999, →N1999999, →N5999999	L10,RAB L13,LAB		0 265 001 207 <sup>4</sup>		
2.5i		02.93-08.95	125	Fg.-Nr. →M1999999, →N5000039, →MV999999			0 265 001 206 <sup>3</sup>		

**Vectra [B]**

	<b>1.6i</b>	09.95-07.03	55/74	Fg.-Nr. →W7999999			0 986 473 905	← 52	
	<b>1.6i 16V</b>						0 986 473 906	→ 52	
				Fg.-Nr. X1000001→			0 986 473 056	← 57	1 987 470 005 <sup>7</sup>
							0 986 474 056	→ 57	1 987 470 005 <sup>7</sup>
	<b>1.7TD</b>	09.95-09.98	60	Fg.-Nr. →W7999999			0 986 473 905	← 52	
							0 986 473 906	→ 52	
				Fg.-Nr. X1000001→			0 986 473 056	← 57	1 987 470 005 <sup>7</sup>
							0 986 474 056	→ 57	1 987 470 005 <sup>7</sup>
	<b>1.8i 16V</b>	09.95-09.00	85	Fg.-Nr. →W7999999			0 986 473 905	← 52	
							0 986 473 906	→ 52	
				Fg.-Nr. X1000001→			0 986 473 056	← 57	1 987 470 005 <sup>7</sup>
							0 986 474 056	→ 57	1 987 470 005 <sup>7</sup>
		09.98-08.00	85				0 986 473 056	← 57	1 987 470 005 <sup>7</sup>
							0 986 474 056	→ 57	1 987 470 005 <sup>7</sup>
		09.00-09.03	92	Fg.-Nr. X1000001→			0 986 473 056	← 57	1 987 470 005 <sup>7</sup>
							0 986 474 056	→ 57	1 987 470 005 <sup>7</sup>
	<b>2.0DI</b>	09.95-08.03	60/74/82	Fg.-Nr. →W7999999			0 986 473 905	← 52	
	<b>2.0DTI</b>						0 986 473 906	→ 52	
	<b>2.0i</b>	09.95-09.03	60/74/82	Fg.-Nr. X1000001→			0 986 473 056	← 57	1 987 470 005 <sup>7</sup>
							0 986 474 056	→ 57	1 987 470 005 <sup>7</sup>
	<b>2.0i</b>	09.95-09.02	100				0 986 473 056	← 57	1 987 470 005 <sup>7</sup>
	<b>2.0i 16V</b>						0 986 474 056	→ 57	1 987 470 005 <sup>7</sup>
	<b>2.2DTI</b>	06.00-09.03	92/106/				0 986 473 056	← 57	1 987 470 005 <sup>7</sup>
	<b>2.2i, i 16V</b>		108				0 986 474 056	→ 57	1 987 470 005 <sup>7</sup>
	<b>2.5iV6</b>	09.95-09.00	125-143				0 986 473 056	← 57	1 987 470 005 <sup>7</sup>
							0 986 474 056	→ 57	1 987 470 005 <sup>7</sup>
	<b>2.6V6</b>	09.00-09.02	130				0 986 473 056	← 57	1 987 470 005 <sup>7</sup>
							0 986 474 056	→ 57	1 987 470 005 <sup>7</sup>

	<b>1.6i</b>	09.95-08.98	55	Fg.-Nr. →W7999999	SCR,STU		0 986 475 143	↔ 19,05	
		09.95-04.02	55				0 986 475 143	↔ 19,05	
		09.95-07.03	55	Fg.-Nr. XL000001→	SCR,STU		0 986 475 143	↔ 19,05	
				Fg.-Nr. X1000001→	SCR,STU		0 986 475 869	↔ 20,64	
	<b>1.8i 16V</b>	09.95-09.00	85	Fg.-Nr. →W1999999, →W5276825, →W7999999			0 986 475 143	↔ 19,05	
				Fg.-Nr. X1000001→, X7000001→			0 986 475 869	↔ 20,64	
	<b>2.0DI</b>	09.96-08.98	60	Fg.-Nr. →W7999999	SCR,STU		0 986 475 143	↔ 19,05	
		09.96-08.00	60	Fg.-Nr. XL000001→	SCR,STU		0 986 475 143	↔ 19,05	
				Fg.-Nr. X1000001→	SCR,STU		0 986 475 869	↔ 20,64	
	<b>1.6i 16V</b>	09.95-08.97	74	Fg.-Nr. →V7999999			0 986 473 379	← 34,94	
							0 986 474 379	→ 34,94	
		09.97-09.02	74	Fg.-Nr. W1000001→			0 986 134 058	← 35	1 987 470 086 <sup>7</sup>
							0 986 135 058	→ 35	1 987 470 086 <sup>7</sup>
		09.00-09.02	74				0 986 134 058	← 35	1 987 470 086 <sup>7</sup>
							0 986 135 058	→ 35	1 987 470 086 <sup>7</sup>
	<b>1.7TD</b>	09.95-08.97	60	Fg.-Nr. →V7999999			0 986 473 379	← 34,94	
							0 986 474 379	→ 34,94	
		09.97-09.98	60	Fg.-Nr. W1000001→			0 986 134 058	← 35	1 987 470 086 <sup>7</sup>
							0 986 135 058	→ 35	1 987 470 086 <sup>7</sup>



		S						
◀ OPEL Vectra [B]								
1.8 i 16V		09.95-08.97	85	Fg.-Nr. →V7999999		0986 <b>473 379</b>		← 34,94
						0986 <b>474 379</b>		→ 34,94
		09.97-09.00	85	Fg.-Nr. W1000001→		0986 <b>134 058</b>		← 35 1987 <b>470 086</b> <sup>7</sup>
						0986 <b>135 058</b>		→ 35 1987 <b>470 086</b> <sup>7</sup>
		09.98-08.00	85			0986 <b>134 058</b>		← 35 1987 <b>470 086</b> <sup>7</sup>
						0986 <b>135 058</b>		→ 35 1987 <b>470 086</b> <sup>7</sup>
		09.00-09.03	92			0986 <b>134 058</b>		← 35 1987 <b>470 086</b> <sup>7</sup>
						0986 <b>135 058</b>		→ 35 1987 <b>470 086</b> <sup>7</sup>
2.0 DTI		09.97-09.03	74			0986 <b>134 058</b>		← 35 1987 <b>470 086</b> <sup>7</sup>
						0986 <b>135 058</b>		→ 35 1987 <b>470 086</b> <sup>7</sup>
2.0 i 2.0 i 16V		09.95-08.97	82/100	Fg.-Nr. →V7999999		0986 <b>473 379</b>		← 34,94
						0986 <b>474 379</b>		→ 34,94
		09.97-09.02	82/100	Fg.-Nr. W1000001→		0986 <b>134 058</b>		← 35 1987 <b>470 086</b> <sup>7</sup>
						0986 <b>135 058</b>		→ 35 1987 <b>470 086</b> <sup>7</sup>
2.2 DTI, i, i 16V		06.00-09.03	92/106/ 108			0986 <b>134 058</b>		← 35 1987 <b>470 086</b> <sup>7</sup>
						0986 <b>135 058</b>		→ 35 1987 <b>470 086</b> <sup>7</sup>
2.5 i V6		09.95-08.97	125-143	Fg.-Nr. →V7999999		0986 <b>473 379</b>		← 34,94
						0986 <b>474 379</b>		→ 34,94
		09.97-09.00	125-143	Fg.-Nr. W1000001→		0986 <b>134 058</b>		← 35 1987 <b>470 086</b> <sup>7</sup>
						0986 <b>135 058</b>		→ 35 1987 <b>470 086</b> <sup>7</sup>
2.6 V6		09.00-09.02	130			0986 <b>134 058</b>		← 35 1987 <b>470 086</b> <sup>7</sup>
						0986 <b>135 058</b>		→ 35 1987 <b>470 086</b> <sup>7</sup>
	1.6 i, i 16V	09.95-07.03	55/74			1987 <b>477 391</b>		1455
	1.7 TD	09.95-09.98	60			1987 <b>477 391</b>		1455
	1.8 i 16V	09.95-09.03	85/92			1987 <b>477 391</b>		1455
	2.0 DI, DTI, i, i 16V	09.95-09.03	60/74/82/100			1987 <b>477 391</b>		1455
	2.2 DTI, i, i 16V	06.00-09.03	92/106/108			1987 <b>477 391</b>		1455
	2.5 i V6	09.95-09.00	125-143			1987 <b>477 391</b>		1455
	2.6 V6	09.00-09.02	130			1987 <b>477 391</b>		1455
<b>Vectra [C]</b>								
	1.6 i	09.01-09.05	74	Fg.-Nr. →51064146		0986 <b>134 018</b>		← 57
	1.6 i GTS					0986 <b>135 018</b>		→ 57
		08.05-10.08	74-77			0986 <b>134 018</b>		← 57
						0986 <b>135 018</b>		→ 57
		09.01-12.05	81/90		BHO	0986 <b>134 018</b>		← 57
						0986 <b>135 018</b>		→ 57
				Fg.-Nr. →51066206	BHO	0986 <b>473 308</b>		← 60
						0986 <b>474 308</b>		→ 60
				Fg.-Nr. 51066207→	BHO	0986 <b>134 081</b>		← 57
						0986 <b>135 081</b>		→ 57
		01.06-10.08	103		BHO	0986 <b>134 081</b>		← 57
						0986 <b>135 081</b>		→ 57
					BHO	0986 <b>134 018</b>		← 57
						0986 <b>135 018</b>		→ 57
1.9 CDTI 1.9 CDTI GTS		04.04-10.08	88/110	Fg.-Nr. →51064146, →48999999		0986 <b>134 018</b>		← 57
						0986 <b>135 018</b>		→ 57
				Fg.-Nr. 51064147→		0986 <b>134 018</b>		← 57
						0986 <b>135 018</b>		→ 57
		09.05-10.08	74			0986 <b>134 018</b>		← 57
						0986 <b>135 018</b>		→ 57
2.0 DTI 2.0 DTI GTS		04.02-09.05	74	Fg.-Nr. →51064146		0986 <b>134 018</b>		← 57
						0986 <b>135 018</b>		→ 57
				Fg.-Nr. 51064147→		0986 <b>134 018</b>		← 57
						0986 <b>135 018</b>		→ 57

	S								
2.0 Turbo 2.0 Turbo GTS	03.03-10.08	129	Fg.-Nr. →51066206 Fg.-Nr. 51066207→			0 986 473 308 0 986 474 308	← 60 → 60		
2.2 Direct 2.2 Direct GTS	09.03-10.08	110-114	Fg.-Nr. →51064146 Fg.-Nr. 51064147→			0 986 134 018 0 986 135 018	← 57 → 57		
2.2 DTI 2.2 DTI GTS	04.02-09.05	86-92	Fg.-Nr. →51064146 Fg.-Nr. 51064147→			0 986 134 018 0 986 135 018	← 57 → 57		
2.2 i 2.2 i GTS	09.01-09.05	108	Fg.-Nr. →51066206 Fg.-Nr. 51066207→	BHO BHO		0 986 135 018 0 986 473 308 0 986 474 308	→ 57 ← 60 → 60		
2.2 i GTS	09.01-09.05	108		BHO		0 986 135 018	→ 57		
2.2 i, i GTS	09.01-09.05	108		BHO		0 986 134 018	← 57		
2.8 GTS Turbo 2.8 Turbo	08.05-10.08	169/184- 188/206	Fg.-Nr. 61000001→	TW		0 986 135 056 0 986 134 056	← 60 → 60		
3.0 CDTI 3.0 CDTI GTS	03.03-10.08	130/135	Fg.-Nr. →31070293, →38047797 Fg.-Nr. 31070294→, 38047798→			0 986 473 308 0 986 474 308 0 986 135 056 0 986 134 056	← 60 → 60 ← 60 → 60		
3.2 i 3.2 i GTS	08.02-09.05	155	Fg.-Nr. →31070293, →38047797 Fg.-Nr. 31070294→, 38047798→			0 986 473 308 0 986 474 308 0 986 135 056 0 986 134 056	← 60 → 60 ← 60 → 60		
1.6 i 1.6 i GTS	09.01-10.08	74-77		INB		0 986 473 992 0 986 474 992	← 38 → 38		
1.8 i 1.8 i GTS	09.01-10.08	81/90/103		INB		0 986 473 992 0 986 474 992	← 38 → 38		
1.9 CDTI 1.9 CDTI GTS	04.04-10.08	74/88/110		INB		0 986 473 992 0 986 474 992	← 38 → 38		
2.0 DTI, DTI GTS, Turbo, Turbo GTS	04.02-10.08	74/129		INB		0 986 473 992 0 986 474 992	← 38 → 38		
2.2 Direct, Direct GTS, DTI, DTI GTS, i, i GTS	09.01-10.08	86-92/108/ 110-114		INB		0 986 473 992 0 986 474 992	← 38 → 38		
2.8 GTS Turbo 2.8 Turbo	08.05-10.08	169/184-188/ 206		INB		0 986 473 992 0 986 474 992	← 38 → 38		
3.0 CDTI 3.0 CDTI GTS	03.03-10.08	130/135		INB		0 986 473 992 0 986 474 992	← 38 → 38		
3.2 i 3.2 i GTS	08.02-09.05	155		INB		0 986 473 992 0 986 474 992	← 38 → 38		
1.6 i 1.6 i GTS	09.01-10.08	74-77				1 987 477 763 1 987 477 763	↔ 1630 ↔ 1630		
1.8 i 1.8 i GTS	09.01-10.08	81/90/103				1 987 477 763 1 987 477 763	↔ 1630 ↔ 1630		
1.9 CDTI 1.9 CDTI GTS	04.04-10.08	74/88/110				1 987 477 763 1 987 477 763	↔ 1630 ↔ 1630		
2.0 DTI 2.0 DTI GTS	04.02-09.05	74/129				1 987 477 763 1 987 477 763	↔ 1630 ↔ 1630		
2.0 Turbo 2.0 Turbo GTS	03.03-10.08	74/129				1 987 477 763 1 987 477 763	↔ 1630 ↔ 1630		
2.2 Direct	09.03-10.08	86-92/108/110-114				1 987 477 763	↔ 1630		





◀ OPEL Vectra [C]

<b>2.2</b> Direct GTS	09.03-10.08	86-92/108/110-114		1987 477 763	↔ 1630
<b>2.2</b> DTI	04.02-09.05	86-92/108/110-114		1987 477 763	↔ 1630
<b>2.2</b> DTI GTS	04.02-09.05	86-92/108/110-114		1987 477 763	↔ 1630
<b>2.2</b> i	09.01-09.05	86-92/108/110-114		1987 477 763	↔ 1630
<b>2.2</b> i GTS	09.01-09.05	86-92/108/110-114		1987 477 763	↔ 1630
<b>2.8</b> GTS Turbo	09.05-09.07	169		1987 477 907	↔ 1805
	09.05-10.08	184-188/206		1987 477 763	↔ 1630
<b>2.8</b> Turbo	08.05-09.07	169		1987 477 763	↔ 1630
	08.05-10.08	184-188/206		1987 477 763	↔ 1630
<b>3.0</b> CDTI	03.03-10.08	130/135		1987 477 763	↔ 1630
<b>3.0</b> CDTI GTS	03.03-10.08	130/135		1987 477 763	↔ 1630
<b>3.2</b> i	08.02-09.05	155		1987 477 763	↔ 1630
<b>3.2</b> i GTS	08.02-09.05	155		1987 477 763	↔ 1630

Vectra Caravan [B]



	<b>1.6</b> i	09.95-07.02	55/74	Fg.-Nr. →W7999999	0986 473 905	↔ ← 52
					0986 473 906	↔ → 52
	<b>1.6</b> i 16V	09.95-09.02	55/74	Fg.-Nr. X1000001→	0986 473 056	↔ ← 57
					0986 474 056	↔ → 57
	<b>1.7</b> TD	09.95-09.98	60	Fg.-Nr. →W7999999	0986 473 905	↔ ← 52
					0986 473 906	↔ → 52
	<b>1.8</b> i 16V	09.95-09.00	85	Fg.-Nr. →W7999999	0986 473 905	↔ ← 52
					0986 473 906	↔ → 52
		09.98-08.00	85	Fg.-Nr. X1000001→	0986 473 056	↔ ← 57
					0986 474 056	↔ → 57
		09.00-09.03	92	Fg.-Nr. X1000001→	0986 473 056	↔ ← 57
					0986 474 056	↔ → 57
	<b>2.0</b> DI	09.95-08.03	60/74/82	Fg.-Nr. →W7999999	0986 473 905	↔ ← 52
	<b>2.0</b> DTI				0986 473 906	↔ → 52
	<b>2.0</b> i	09.95-09.03	60/74/82	Fg.-Nr. X1000001→	0986 473 056	↔ ← 57
					0986 474 056	↔ → 57
	<b>2.0</b> i	09.95-09.02	100		0986 473 056	↔ ← 57
					0986 474 056	↔ → 57
	<b>2.2</b> DTI	09.00-09.03	92/108		0986 473 056	↔ ← 57
					0986 474 056	↔ → 57
	<b>2.5</b> i V6	09.96-06.00	125-143		0986 473 056	↔ ← 57
					0986 474 056	↔ → 57
	<b>2.6</b> V6	09.00-09.02	130		0986 473 056	↔ ← 57
					0986 474 056	↔ → 57



	<b>1.6</b> i 16V	09.96-08.97	74	Fg.-Nr. →V7999999	0986 473 379	↔ ← 34,94
					0986 474 379	↔ → 34,94
			09.97-07.02	74	Fg.-Nr. W1000001→	0986 134 058
		09.00-09.02	74		0986 135 058	↔ → 35
					0986 134 058	↔ ← 35
	<b>1.7</b> TD	09.95-08.97	60	Fg.-Nr. →V7999999	0986 135 058	↔ → 35
					0986 473 379	↔ ← 34,94
		09.97-09.98	60	Fg.-Nr. W1000001→	0986 474 379	↔ → 34,94
					0986 134 058	↔ ← 35
	<b>1.8</b> i 16V	09.95-08.97	85	Fg.-Nr. →V7999999	0986 135 058	↔ → 35
					0986 473 379	↔ ← 34,94
		09.97-09.00	85	Fg.-Nr. W1000001→	0986 474 379	↔ → 34,94
					0986 134 058	↔ ← 35
					0986 135 058	↔ → 35

		<b>S</b>													
<b>1.8i 16V</b>		09.98-08.00	85				0986 <b>134 058</b>	← 35	1987 <b>470 086</b> <sup>7</sup>						
							0986 <b>135 058</b>	→ 35	1987 <b>470 086</b> <sup>7</sup>						
		09.00-09.03	92				0986 <b>134 058</b>	← 35	1987 <b>470 086</b> <sup>7</sup>						
							0986 <b>135 058</b>	→ 35	1987 <b>470 086</b> <sup>7</sup>						
<b>2.0DI</b>		09.96-08.97	60		Fg.-Nr. →V7999999		0986 <b>473 379</b>	← 34,94							
							0986 <b>474 379</b>	→ 34,94							
		09.97-08.00	60		Fg.-Nr. W1000001→		0986 <b>134 058</b>	← 35	1987 <b>470 086</b> <sup>7</sup>						
							0986 <b>135 058</b>	→ 35	1987 <b>470 086</b> <sup>7</sup>						
<b>2.0DTI</b>		09.97-09.03	74				0986 <b>134 058</b>	← 35	1987 <b>470 086</b> <sup>7</sup>						
							0986 <b>135 058</b>	→ 35	1987 <b>470 086</b> <sup>7</sup>						
<b>2.0i</b>		09.95-08.97	82/100		Fg.-Nr. →V7999999		0986 <b>473 379</b>	← 34,94							
							0986 <b>474 379</b>	→ 34,94							
<b>2.0i 16V</b>		09.97-09.02	82/100		Fg.-Nr. W1000001→		0986 <b>134 058</b>	← 35	1987 <b>470 086</b> <sup>7</sup>						
							0986 <b>135 058</b>	→ 35	1987 <b>470 086</b> <sup>7</sup>						
<b>2.2DTI</b>		09.00-09.03	92/108				0986 <b>134 058</b>	← 35	1987 <b>470 086</b> <sup>7</sup>						
<b>2.2i 16V</b>							0986 <b>135 058</b>	→ 35	1987 <b>470 086</b> <sup>7</sup>						
<b>2.5i V6</b>		09.96-08.97	125-143		Fg.-Nr. →V7999999		0986 <b>473 379</b>	← 34,94							
							0986 <b>474 379</b>	→ 34,94							
		09.97-06.00	125-143		Fg.-Nr. W1000001→		0986 <b>134 058</b>	← 35	1987 <b>470 086</b> <sup>7</sup>						
							0986 <b>135 058</b>	→ 35	1987 <b>470 086</b> <sup>7</sup>						
<b>2.6 V6</b>		09.00-09.02	130				0986 <b>134 058</b>	← 35	1987 <b>470 086</b> <sup>7</sup>						
							0986 <b>135 058</b>	→ 35	1987 <b>470 086</b> <sup>7</sup>						
	<b>1.6i, i 16V</b>	09.95-09.02	55/74				1987 <b>477 391</b>	1455							
	<b>1.7TD</b>	09.95-09.98	60				1987 <b>477 391</b>	1455							
	<b>1.8i 16V</b>	09.95-09.03	85/92				1987 <b>477 391</b>	1455							
	<b>2.0Di, DTI, i, i 16V</b>	09.95-09.03	60/74/82/100				1987 <b>477 391</b>	1455							
	<b>2.2DTI, i 16V</b>	09.00-09.03	92/108				1987 <b>477 391</b>	1455							
	<b>2.5i V6</b>	09.96-06.00	125-143				1987 <b>477 391</b>	1455							
	<b>2.6 V6</b>	09.00-09.02	130				1987 <b>477 391</b>	1455							
	<b>Vectra Caravan [C]</b>														
	<b>1.6i</b>	09.03-05.04	74		Fg.-Nr. →51064146		0986 <b>134 018</b>	← 57							
							0986 <b>135 018</b>	→ 57							
							0986 <b>134 018</b>	← 57							
								0986 <b>135 018</b>	→ 57						
		06.04-10.08	74-77					0986 <b>134 018</b>	← 57						
								0986 <b>135 018</b>	→ 57						
	<b>1.8i</b>	09.03-12.05	81/90				BHO	0986 <b>134 018</b>	← 57						
								0986 <b>135 018</b>	→ 57						
							Fg.-Nr. →51066206	BHO	0986 <b>473 308</b>	← 60					
								0986 <b>474 308</b>	→ 60						
								0986 <b>134 081</b>	← 57						
								0986 <b>135 081</b>	→ 57						
	01.06-10.08	103					BHO	0986 <b>134 081</b>	← 57						
								0986 <b>135 081</b>	→ 57						
							BHO	0986 <b>134 018</b>	← 57						
						0986 <b>135 018</b>	→ 57								
<b>1.9CDTI</b>	04.04-10.08	88/110			Fg.-Nr. →51064146, →48999999		0986 <b>134 018</b>	← 57							
							0986 <b>135 018</b>	→ 57							
							0986 <b>134 018</b>	← 57							
							0986 <b>135 018</b>	→ 57							
09.05-10.08	74						0986 <b>134 018</b>	← 57							
							0986 <b>135 018</b>	→ 57							
													0986 <b>134 018</b>	← 57	
													0986 <b>135 018</b>	→ 57	
<b>2.0DTI</b>	09.03-09.05	74			Fg.-Nr. →51064146		0986 <b>134 018</b>	← 57							
							0986 <b>135 018</b>	→ 57							
													0986 <b>134 018</b>	← 57	
						0986 <b>135 018</b>	→ 57								

		S							
<b>◀ OPEL Vectra Caravan [C]</b>									
2.0 Turbo	09.03-10.08	129	Fg.-Nr. →51066206				0986 473 308		60
							0986 474 308		60
			Fg.-Nr. 51066207→				0986 134 081		57
							0986 135 081		57
2.2 Direct	09.03-10.08	110-114	Fg.-Nr. →51064146				0986 134 018		57
							0986 135 018		57
			Fg.-Nr. 51064147→				0986 134 018		57
							0986 135 018		57
2.2 DTI	09.03-09.05	86-92	Fg.-Nr. →51064146				0986 134 018		57
							0986 135 018		57
			Fg.-Nr. 51064147→				0986 134 018		57
							0986 135 018		57
2.2 i	09.03-09.05	108			BHO		0986 473 308		60
							0986 474 308		60
					BHO		0986 134 018		57
							0986 135 018		57
2.8 Turbo	08.05-10.08	169/ 184-188/ 206	Fg.-Nr. 61000001→			TW	0986 135 056		60
							0986 134 056		60
3.0 CDTI	09.03-10.08	130/135	Fg.-Nr. →31070293, →38047797				0986 473 308		60
							0986 474 308		60
			Fg.-Nr. 31070294→, 38047798→				0986 135 056		60
							0986 134 056		60
3.2 i	09.03-09.05	155	Fg.-Nr. →31070293, →38047797				0986 473 308		60
							0986 474 308		60
			Fg.-Nr. 31070294→, 38047798→				0986 135 056		60
							0986 134 056		60
<hr/>									
1.6 i	09.03-10.08	74-77	Fg.-Nr. →41085480			INB	0986 473 172		37,93
							0986 474 172		37,93
			Fg.-Nr. 41085481→			INB	0986 134 070		40
							0986 135 070		40
1.8 i	09.03-10.08	81/90/103	Fg.-Nr. →41085480			INB	0986 473 172		37,93
							0986 474 172		37,93
			Fg.-Nr. 41085481→			INB	0986 134 070		40
							0986 135 070		40
1.9 CDTI	04.04-10.08	74/88/110	Fg.-Nr. →41085480			INB	0986 473 172		37,93
							0986 474 172		37,93
			Fg.-Nr. 41085481→			INB	0986 134 070		40
							0986 135 070		40
2.0 DTI	09.03-10.08	74/129	Fg.-Nr. →41085480			INB	0986 473 172		37,93
							0986 474 172		37,93
2.0 Turbo			Fg.-Nr. 41085481→			INB	0986 134 070		40
							0986 135 070		40
2.2 Direct	09.03-10.08	86-92/108/ 110-114	Fg.-Nr. →41085480			INB	0986 473 172		37,93
							0986 474 172		37,93
2.2 DTI			Fg.-Nr. 41085481→			INB	0986 134 070		40
							0986 135 070		40
2.8 Turbo	08.05-10.08	169/ 184-188/ 206	Fg.-Nr. →41085480			INB	0986 473 172		37,93
							0986 474 172		37,93
			Fg.-Nr. 41085481→			INB	0986 134 070		40
							0986 135 070		40
3.0 CDTI	09.03-10.08	130/135	Fg.-Nr. →41085480			INB	0986 473 172		37,93
							0986 474 172		37,93
			Fg.-Nr. 41085481→			INB	0986 134 070		40
							0986 135 070		40
3.2 i	09.03-09.05	155	Fg.-Nr. →41085480			INB	0986 473 172		37,93
							0986 474 172		37,93
			Fg.-Nr. 41085481→			INB	0986 134 070		40
							0986 135 070		40



	<b>1.6i</b>	09.03-10.08	74-77	1 987 <b>477 907</b>	↔ 1805
	<b>1.8i</b>	09.03-10.08	81/90/103	1 987 <b>477 907</b>	↔ 1805
	<b>1.9 CDTI</b>	04.04-10.08	74/88/110	1 987 <b>477 907</b>	↔ 1805
	<b>2.0 DTI</b>	09.03-09.05	74/129	1 987 <b>477 907</b>	↔ 1805
	<b>2.0 Turbo</b>	09.03-10.08	74/129	1 987 <b>477 907</b>	↔ 1805
	<b>2.2 Direct</b>	09.03-10.08	86-92/108/110-114	1 987 <b>477 907</b>	↔ 1805
	<b>2.2 DTI</b>	09.03-09.05	86-92/108/110-114	1 987 <b>477 907</b>	↔ 1805
	<b>2.2i</b>	09.03-09.05	86-92/108/110-114	1 987 <b>477 907</b>	↔ 1805
	<b>2.8 Turbo</b>	08.05-10.08	169/184-188/206	1 987 <b>477 907</b>	↔ 1805
	<b>3.0 CDTI</b>	09.03-10.08	130/135	1 987 <b>477 907</b>	↔ 1805
	<b>3.2i</b>	09.03-09.05	155	1 987 <b>477 907</b>	↔ 1805

**Vivaro**



	<b>1.9 CDTI</b>	03.01-08.06	60/74	Fg.-Nr. →6V699999, →6Y999999	0 986 <b>473 424</b>	↔ ← 45
	<b>1.9 DTI</b>				0 986 <b>474 424</b>	↔ → 45
	<b>2.0 CDTI</b>	03.01→	66/84/	Fg.-Nr. →6V699999, →6Y999999	0 986 <b>473 424</b>	↔ ← 45
	<b>2.0 16V</b>		86-88		0 986 <b>474 424</b>	↔ → 45
	<b>2.5 CDTI</b>	09.02→	84/99/107	Fg.-Nr. →6V699999, →6Y999999	0 986 <b>473 424</b>	↔ ← 45
					0 986 <b>474 424</b>	↔ → 45



	<b>1.9 CDTI</b>	03.01-08.06	60/74	Fg.-Nr. →2V607598	0 986 <b>473 480</b>	↔ ← 41
	<b>1.9 DTI</b>				0 986 <b>474 480</b>	↔ → 41
	<b>2.0 CDTI</b>	03.01→	66/84/	Fg.-Nr. →2V607598	0 986 <b>473 480</b>	↔ ← 41
	<b>2.0 16V</b>		86-88		0 986 <b>474 480</b>	↔ → 41
	<b>2.5 CDTI</b>	09.02→	84/99/107	Fg.-Nr. →2V607598	0 986 <b>473 480</b>	↔ ← 41
					0 986 <b>474 480</b>	↔ → 41



	<b>1.9 CDTI</b>	03.01-08.06	60/74		1 987 <b>477 116</b>	→ 1603	
	<b>1.9 DTI</b>				1 987 <b>477 137</b>	← 1503	
				FKR,MI	1 987 <b>482 043</b>	1190	
				FLR,TW	1 987 <b>482 292</b>	1887	
				LLE	1 987 <b>482 042</b>	508	
				RLE	1 987 <b>482 146</b>	600	
				Fg.-Nr. →AV606709	FLR,MI	1 987 <b>482 145</b>	1585
	<b>2.0 CDTI</b>	03.01→	66/84/		1 987 <b>477 116</b>	→ 1603	
	<b>2.0 16V</b>		86-88		1 987 <b>477 137</b>	← 1503	
				Fg.-Nr. →AV606709	FKR,LLE	1 987 <b>482 524</b>	1245
					FLR,MI,TW	1 987 <b>482 145</b>	1585
					FLR,TW	1 987 <b>482 525</b>	1643
	<b>2.5 CDTI</b>	09.02-06.08	84/99		1 987 <b>477 116</b>	→ 1603	
					1 987 <b>477 137</b>	← 1503	
					FKR,MI	1 987 <b>482 043</b>	1190
					FLR,TW	1 987 <b>482 292</b>	1887
					LLE	1 987 <b>482 042</b>	508
					RLE	1 987 <b>482 146</b>	600
				Fg.-Nr. →AV606709	FLR,MI	1 987 <b>482 145</b>	1585
		08.06→	107		1 987 <b>477 116</b>	→ 1603	
					1 987 <b>477 137</b>	← 1503	
				Fg.-Nr. →AV606709	FKR,LLE	1 987 <b>482 524</b>	1245
					FLR,MI,TW	1 987 <b>482 145</b>	1585
					FLR,TW	1 987 <b>482 525</b>	1643

	<b>1.9 CDTI</b>	03.01-08.06	60/74	Fg.-Nr. 7V600001→, 7Y000001→	0 265 <b>008 077</b> <sup>3</sup>	
	<b>1.9 DTI</b>				0 265 <b>008 078</b> <sup>4</sup>	





		S								
<b>OPEL Vivaro</b>										
2.0 CDTI		08.06→	66/84	Fg.-Nr. →9V620473, →9Y708998	TW		0 265 <b>008 077</b> <sup>3</sup>			
							0 265 <b>008 078</b> <sup>4</sup>			
				Fg.-Nr. 7V655888→8V699999, 7Y000001→8Y799999	TW		0 265 <b>008 916</b> <sup>4</sup>			
							0 265 <b>008 041</b> <sup>3</sup>			
		12.10→	66/84		TW		0 265 <b>008 041</b> <sup>3</sup>			
							0 265 <b>008 916</b> <sup>4</sup>			
2.0 16V		03.01→	86-88	Fg.-Nr. →9V620473, →9Y708998	TW		0 265 <b>008 077</b> <sup>3</sup>			
							0 265 <b>008 078</b> <sup>4</sup>			
				Fg.-Nr. 7V655888→8V699999, 7Y000001→8Y799999	TW		0 265 <b>008 916</b> <sup>4</sup>			
							0 265 <b>008 041</b> <sup>3</sup>			
		09.02-06.08	84/99	Fg.-Nr. →9V620474→, 9Y798999→	TW		0 265 <b>008 041</b> <sup>3</sup>			
							0 265 <b>008 077</b> <sup>3</sup>			
2.5 CDTI		08.06→	107	Fg.-Nr. →9V620473, →9Y708998	TW		0 265 <b>008 077</b> <sup>3</sup>			
							0 265 <b>008 078</b> <sup>4</sup>			
				Fg.-Nr. 7V600001→, 7Y000001→	TW		0 265 <b>008 916</b> <sup>4</sup>			
							0 265 <b>008 041</b> <sup>3</sup>			
				Fg.-Nr. 7V655888→8V699999, 7Y000001→8Y799999	TW		0 265 <b>008 078</b> <sup>4</sup>			
							0 265 <b>008 916</b> <sup>4</sup>			
				Fg.-Nr. 9V600001→, 9Y000001→	TW		0 265 <b>008 916</b> <sup>4</sup>			
							0 265 <b>008 041</b> <sup>3</sup>			
				Fg.-Nr. 9V620474→, 9Y798999→	TW		0 265 <b>008 041</b> <sup>3</sup>			
							0 265 <b>008 077</b> <sup>3</sup>			
<b>Zafira [A]</b>										
	1.6 i	03.99-07.05	69-73/74				0 986 <b>473 062</b>		← 57	1 987 <b>470 005</b> <sup>7</sup>
							0 986 <b>474 062</b>		→ 57	1 987 <b>470 005</b> <sup>7</sup>
	1.6 i CNG	03.99-07.05	85/92				0 986 <b>473 062</b>		← 57	1 987 <b>470 005</b> <sup>7</sup>
							0 986 <b>474 062</b>		→ 57	1 987 <b>470 005</b> <sup>7</sup>
	1.8 i	03.99-07.05	85/92				0 986 <b>473 062</b>		← 57	1 987 <b>470 005</b> <sup>7</sup>
							0 986 <b>474 062</b>		→ 57	1 987 <b>470 005</b> <sup>7</sup>
	2.0 DI, DTI, Turbo	03.99-07.05	60/74/ 141-147				0 986 <b>473 062</b>		← 57	1 987 <b>470 005</b> <sup>7</sup>
							0 986 <b>474 062</b>		→ 57	1 987 <b>470 005</b> <sup>7</sup>
	2.2	09.00-07.05	92/108				0 986 <b>473 062</b>		← 57	1 987 <b>470 005</b> <sup>7</sup>
							0 986 <b>474 062</b>		→ 57	1 987 <b>470 005</b> <sup>7</sup>
	2.2 DTI	09.00-07.05	92/108				0 986 <b>473 062</b>		← 57	1 987 <b>470 005</b> <sup>7</sup>
							0 986 <b>474 062</b>		→ 57	1 987 <b>470 005</b> <sup>7</sup>
	1.6 i, i CNG	03.99-07.05	69-73/74				0 986 <b>475 869</b>		↔ 20,64	
							0 986 <b>475 869</b>		↔ 20,64	
	1.8 i	03.99-07.05	85/92				0 986 <b>475 869</b>		↔ 20,64	
							0 986 <b>475 869</b>		↔ 20,64	
	2.0 DI, DTI	03.99-07.05	60/74				0 986 <b>475 869</b>		↔ 20,64	
							0 986 <b>475 143</b>		↔ 19,05	
	2.2 DTI	03.02-07.05	92				0 986 <b>475 143</b>		↔ 19,05	
							0 986 <b>475 869</b>		↔ 20,64	
	1.6 i	03.99-07.05	69-73/74			BSY	0 986 <b>473 326</b>		← 38	
							0 986 <b>474 326</b>		→ 38	
	1.6 i CNG	03.99-07.05	85/92			LUC	0 986 <b>473 223</b>		← 38,1	
							0 986 <b>474 223</b>		→ 38,1	
						LUC	0 986 <b>473 258</b>		← 38	
							0 986 <b>474 258</b>		→ 38	
	1.8 i	03.99-07.05	85/92			BSY	0 986 <b>473 326</b>		← 38	
							0 986 <b>474 326</b>		→ 38	
						LUC	0 986 <b>473 223</b>		← 38,1	
							0 986 <b>474 223</b>		→ 38,1	
						LUC	0 986 <b>473 258</b>		← 38	
							0 986 <b>474 258</b>		→ 38	
	2.0 DI, DTI, Turbo	03.99-07.05	60/74/ 141-147			BSY	0 986 <b>473 326</b>		← 38	
							0 986 <b>474 326</b>		→ 38	

		S							
2.0 DI, DTI, Turbo	03.99-07.05	60/74/ 141-147	Fg.-Nr. →32999999, →3H999999	LUC	0 986 473 223		← 38,1		
				LUC	0 986 474 223		→ 38,1		
				LUC	0 986 473 258		← 38		
				LUC	0 986 474 258		→ 38		
2.2 2.2 DTI	09.00-07.05	92/108	Fg.-Nr. →32999999, →3H999999	BSY	0 986 473 326		← 38		
				BSY	0 986 474 326		→ 38		
				LUC	0 986 473 223		← 38,1		
				LUC	0 986 474 223		→ 38,1		
			Fg.-Nr. 42000001→, 4H000001→	LUC	0 986 473 258		← 38		
				LUC	0 986 474 258		→ 38		
	03.99-07.05	74		MI,STB	1 987 477 868		1355		
				STB	1 987 482 449		↔ 182		
				4SB	1 987 477 528		1680		
1.6 i CNG	09.01-07.05	69-73	Fg.-Nr. →22006460, →1H999999	MI,STB	1 987 477 868		1355		
				STB	1 987 482 449		↔ 182		
				4SB	1 987 477 528		1680		
			Fg.-Nr. 22006461→ 32999999, 2H000001→3H999999	4SB	1 987 482 107		1680		
				4SB	1 987 482 141		1677		
1.8 i	03.99-08.00	85	Fg.-Nr. →22006460, →1H999999	MI,STB	1 987 477 868		1355		
				STB	1 987 482 449		↔ 182		
				4SB	1 987 477 528		1680		
	09.00-07.05	92	Fg.-Nr. 22006461→ 32999999, 2H000001→3H999999	MI,STB	1 987 477 868		1355		
				STB	1 987 482 449		↔ 182		
				4SB	1 987 477 528		1680		
			Fg.-Nr. 42000001→, 4H000001→	4SB	1 987 482 141		1677		
2.0 DI	03.99-08.00	60/74/ 141-147		STB	1 987 482 449		↔ 182		
2.0 DI 2.0 DTI 2.0 Turbo	03.99-07.05	60/74/ 141-147	Fg.-Nr. →22006460, →1H999999	MI,STB	1 987 477 868		1355		
				4SB	1 987 477 528		1680		
				4SB	1 987 482 107		1680		
				4SB	1 987 482 141		1677		
			Fg.-Nr. 22006461→ 32999999, 2H000001→3H999999						
2.0 DTI	04.99-07.05	60/74/ 141-147		STB	1 987 482 449		↔ 182		
2.0 Turbo	09.01-07.05	60/74/ 141-147		STB	1 987 482 449		↔ 182		
2.2	09.00-07.05	92/108		STB	1 987 482 449		↔ 182		
2.2 2.2 DTI	09.00-07.05	92/108	Fg.-Nr. →22006460, →1H999999	MI,STB	1 987 477 868		1355		
				4SB	1 987 477 528		1680		
				4SB	1 987 482 107		1680		
				4SB	1 987 482 141		1677		
			Fg.-Nr. 22006461→ 32999999, 2H000001→3H999999						
2.2 DTI	03.02-07.05	92/108		STB	1 987 482 449		↔ 182		



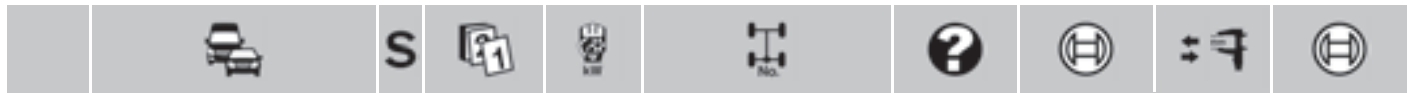

◀ OPEL

Zafira [B]



	1.6 CNG, CNG Turbo, i	07.05→	69-71/77/ 85/110	SBJ	0986 473 062	← 57	1987 470 0057
					0986 474 062	→ 57	1987 470 0057
	1.7 CDTI	03.08→	81/92	SBJ	0986 473 062	← 57	1987 470 0057
					0986 474 062	→ 57	1987 470 0057
	1.8 i	07.05→	103	SBJ	0986 473 062	← 57	1987 470 0057
					0986 474 062	→ 57	1987 470 0057
		06.13→	88	SBJ	0986 473 062	← 57	1987 470 0057
					0986 474 062	→ 57	1987 470 0057
	1.8 LPG	03.10-12.10	101-103		0986 473 062	← 57	1987 470 0057
					0986 474 062	→ 57	1987 470 0057
	1.9 CDTI	07.05-12.10	74/88/110	SBJ	0986 473 062	← 57	1987 470 0057
					0986 474 062	→ 57	1987 470 0057
	2.0 i Turbo	07.05-12.10	147/177	SBJ	0986 473 062	← 57	1987 470 0057
					0986 474 062	→ 57	1987 470 0057
	2.2 i Direct	07.05-12.10	110	SBJ	0986 473 062	← 57	1987 470 0057
					0986 474 062	→ 57	1987 470 0057



	1.6 CNG, CNG Turbo, i	07.05→	69-71/77/ 85/110	SBJ	0986 134 050	← 41	
					0986 135 050	→ 41	
	1.7 CDTI	03.08→	81/92	SBJ	0986 134 050	← 41	
					0986 135 050	→ 41	
	1.8 i	07.05→	103	SBJ	0986 134 050	← 41	
					0986 135 050	→ 41	
		06.13→	88	SBJ	0986 134 050	← 41	
					0986 135 050	→ 41	
	1.8 LPG	03.10-12.10	101-103		0986 134 050	← 41	
					0986 135 050	→ 41	
	1.9 CDTI	07.05-12.10	74/88/110	SBJ	0986 134 050	← 41	
					0986 135 050	→ 41	
	2.0 i Turbo	07.05-12.10	147/177	SBJ	0986 134 050	← 41	
					0986 135 050	→ 41	
	2.2 i Direct	07.05-12.10	110	SBJ	0986 134 050	← 41	
					0986 135 050	→ 41	



	1.6 CNG	09.05-03.10	69-71	Fg.-Nr. →52999999		1987 477 163	1774
	1.6 i	07.05→	77/85			1987 477 163	1774
	1.7 CDTI	03.08→	81/92			1987 477 163	1774
	1.8 i, LPG	07.05→	88/101-103			1987 477 163	1774
	1.9 CDTI	07.05-12.10	74/88/110			1987 477 163	1774
	2.0 i Turbo	07.05-12.10	147/177			1987 477 163	1774
	2.2 i Direct	07.05-12.10	110			1987 477 163	1774
						TW	1987 477 163

Zafira [C]



	1.4 Turbo	01.12→	88/103	D32	0986 134 319	← 60	
					0986 135 319	→ 60	
	1.6 CDTI, CNG, Turbo	01.12→	88/100/110/ 125/147	D32	0986 134 319	← 60	
					0986 135 319	→ 60	
	1.8	01.12→	85-88/103	D32	0986 134 319	← 60	
					0986 135 319	→ 60	
	2.0 CDTI	01.12→	81/96/121/ 125/143	D32	0986 134 319	← 60	
					0986 135 319	→ 60	



**PEUGEOT**

**Bipper [A9]**

	1.3 HDi	08.10→	55			0 986 475 936	↔ 20,64	
	1.4, HDi	02.08→	50/54			0 986 475 936	↔ 20,64	
	1.3 HDi	08.10→	55			1 987 482 207	→ 1710	
						1 987 482 208	← 1677	
	1.4	02.08→	54			1 987 482 205	→ 1695	
						1 987 482 206	← 1662	
	1.4 HDi	02.08→	50			1 987 482 207	→ 1710	
						1 987 482 208	← 1677	

**Boxer**

	2.8 D	01.02-09.09	66/77/93		L03	BRB	0 986 473 995	↔ 44
	2.8 D Turbo						0 986 135 016	↔
	2.8 HDI						0 986 474 995	↔
		ABO	01.02-09.09	66/77/93		INB	0 986 473 161	↔ 40,4
							0 986 474 161	↔ 40,4
						L02	0 986 473 163	↔ 48
							0 986 474 163	↔ 48
						L03	0 986 473 162	↔ 40,4
		ABS	01.02-09.09	66/77/93		L03	0 986 473 985	↔ 48
							0 986 474 985	↔ 48
	2.8 D	01.02-09.09	66/77/93			LOC	0 986 475 906	↔ 26,99
	2.8 D Turbo					L07	0 986 475 802	↔ 27
	2.8 HDI					254,L06	0 986 475 801	↔ 25,4
	2.8 D, D Turbo	01.02-09.09	66/77/93				0 986 473 996	↔ 46
	2.8 HDI						0 986 474 996	↔ 46
	2.8 D, D Turbo	01.02-09.09	66/77/93	Fg.-Nr. 15445358→		LAB	0 265 006 405 <sup>4</sup>	
	2.8 HDI					RAB	0 265 006 406 <sup>4</sup>	

**Boxer [U3]**

	1.9 D	ABO	02.94-02.02	50/51/66/68		INB	0 986 473 161	↔ 40,4
	1.9 D Turbo						0 986 474 161	↔ 40,4
						L02	0 986 473 163	↔ 48
							0 986 474 163	↔ 48
						L03	0 986 473 162	↔ 40,4
		ABS	02.94-02.02	50/51/66/68		INB	0 986 473 987	↔ 40
							0 986 474 987	↔ 40
						L02	0 986 473 984	↔ 45
							0 986 474 984	↔ 45
						L03	0 986 473 985	↔ 48
							0 986 474 985	↔ 48
	2.0, HDi, i	ABO	02.94-02.02	62/79/80-81		INB	0 986 473 161	↔ 40,4
							0 986 474 161	↔ 40,4
						L02	0 986 473 163	↔ 48
							0 986 474 163	↔ 48





**PEUGEOT Boxer [U3]**

2.0, HDi, i	ABO 02.94-02.02	62/79/80-81	L03	0986 473 162	↔ 40,4
	ABS 02.94-02.02	62/79/80-81	INB	0986 473 987	↔ 40
2.5 D	ABO 02.94-02.02	62/63/76-77/79-81	INB	0986 474 987	↔ 40
				0986 473 984	↔ 45
			L02	0986 474 984	↔ 45
				0986 473 985	↔ 48
2.5 D Turbo	ABO 02.94-02.02	62/63/76-77/79-81	INB	0986 473 161	↔ 40,4
				0986 474 161	↔ 40,4
			L02	0986 473 163	↔ 48
				0986 474 163	↔ 48
2.5 TDi	ABS 02.94-02.02	62/63/76-77/79-81	INB	0986 473 987	↔ 40
				0986 474 987	↔ 40
			L02	0986 473 984	↔ 45
				0986 474 984	↔ 45
2.8 D	ABO 01.99-02.02	64/90/94	INB	0986 473 161	↔ 40,4
				0986 474 161	↔ 40,4
			L02	0986 473 163	↔ 48
				0986 474 163	↔ 48
2.8 HDi	ABS 01.99-02.02	64/90/94	INB	0986 473 987	↔ 40
				0986 474 987	↔ 40
			L02	0986 473 984	↔ 45
				0986 474 984	↔ 45
2.8 D Turbo	ABO 01.99-02.02	64/90/94	INB	0986 473 985	↔ 48
				0986 474 985	↔ 48
			L03	0986 473 162	↔ 40,4
				0986 474 162	↔ 40,4

**Peugeot 508**

1.9 D	02.94-02.02	50/51/66/68	L02	0986 475 803	↔ 28,6
			L07	0986 475 802	↔ 27
1.9 D Turbo	02.94-02.02	62/79/80-81	254,L06	0986 475 801	↔ 25,4
2.0			L02	0986 475 803	↔ 28,6
2.0 HDi	02.94-02.02	62/79/80-81	L07	0986 475 802	↔ 27
2.0 i			254,L06	0986 475 801	↔ 25,4
2.5 D	02.94-02.02	62/63/76-77/79-81	L02	0986 475 803	↔ 28,6
2.5 D Turbo			L07	0986 475 802	↔ 27
2.5 TDi	01.99-02.02	64/90/94	254,L06	0986 475 801	↔ 25,4
2.8 D			L02	0986 475 803	↔ 28,6
2.8 D Turbo	01.99-02.02	64/90/94	L07	0986 475 802	↔ 27
2.8 HDi			254,L06	0986 475 801	↔ 25,4

**Peugeot 508**

2.5 D	02.94-02.02	63/79-81		0986 473 996	↔ 46
				0986 474 996	↔ 46

**Peugeot 508**

1.9 D	02.94-02.02	50/51/66/68	AA,FEV	1987 482 005	4095	
			LLE	1987 477 114	1059	
1.9 D Turbo	02.94-02.02	50/51/66/68	RLE	1987 482 046	1137	
			Fg.-Nr. →16158427	NAA,NNC	1987 477 113	3025
				NAA,VFC	1987 477 115	3045
			Fg.-Nr. 16158428→	NAA,NNC	1987 477 262	2806
				NAA,VFC	1987 482 006	2827
			2.0	LLE	1987 477 114	1059
2.0 i	02.94-02.02	79/80-81	RLE	1987 482 046	1137	
			Fg.-Nr. →16158427	NNC	1987 477 113	3025
				VFC	1987 477 115	3045
			Fg.-Nr. 16158428→	NNC	1987 477 262	2806
				VFC	1987 482 006	2827

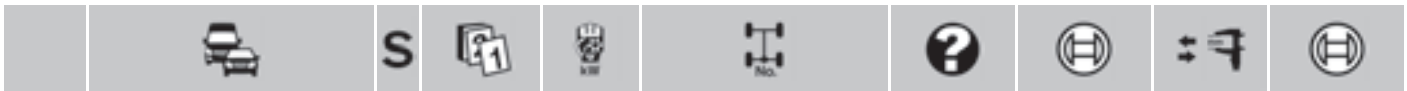

		<b>S</b>							
<b>2.0 HDi</b>		09.01-02.02	62			AA,FEV	1 987 <b>482 005</b>	4095	
						LLE	1 987 <b>477 114</b>	1059	
						RLE	1 987 <b>482 046</b>	1137	
				Fg.-Nr. →16158427		NAA,NNC	1 987 <b>477 113</b>	3025	
						NAA,VFC	1 987 <b>477 115</b>	3045	
				Fg.-Nr. 16158428→		NAA,NNC	1 987 <b>477 262</b>	2806	
						NAA,VFC	1 987 <b>482 006</b>	2827	
<b>2.5 D</b>		02.94-02.02	62/63/			AA,FEV	1 987 <b>482 005</b>	4095	
<b>2.5 D Turbo</b>			76-77/			LLE	1 987 <b>477 114</b>	1059	
<b>2.5 TDi</b>			79-81			RLE	1 987 <b>482 046</b>	1137	
				Fg.-Nr. →16158427		NAA,NNC	1 987 <b>477 113</b>	3025	
						NAA,VFC	1 987 <b>477 115</b>	3045	
				Fg.-Nr. 16158428→		NAA,NNC	1 987 <b>477 262</b>	2806	
						NAA,VFC	1 987 <b>482 006</b>	2827	
<b>2.8 D</b>		01.99-02.02	64/90/94			AA,FEV	1 987 <b>482 005</b>	4095	
<b>2.8 D Turbo</b>						LLE	1 987 <b>477 114</b>	1059	
<b>2.8 HDi</b>						RLE	1 987 <b>482 046</b>	1137	
				Fg.-Nr. →16158427		NAA,NNC	1 987 <b>477 113</b>	3025	
						NAA,VFC	1 987 <b>477 115</b>	3045	
				Fg.-Nr. 16158428→		NAA,NNC	1 987 <b>477 262</b>	2806	
						NAA,VFC	1 987 <b>482 006</b>	2827	
	<b>1.9 D</b>	02.94-04.00	50/51/66/	Fg.-Nr. 15445358→			0 265 <b>006 427</b> <sup>3</sup>		
	<b>1.9 D Turbo</b>		68						
		02.94-02.02	50/51/66/	Fg.-Nr. 15445358→		LAB	0 265 <b>006 405</b> <sup>4</sup>		
			68			RAB	0 265 <b>006 406</b> <sup>4</sup>		
	<b>2.0</b>	02.94-04.00	79/80-81	Fg.-Nr. 15445358→			0 265 <b>006 427</b> <sup>3</sup>		
	<b>2.0 i</b>	02.94-02.02	79/80-81	Fg.-Nr. 15445358→		LAB	0 265 <b>006 405</b> <sup>4</sup>		
						RAB	0 265 <b>006 406</b> <sup>4</sup>		
	<b>2.0 HDi</b>	09.01-02.02	62	Fg.-Nr. 15445358→		LAB	0 265 <b>006 405</b> <sup>4</sup>		
						RAB	0 265 <b>006 406</b> <sup>4</sup>		
	<b>2.5 D</b>	02.94-04.00	62/63/	Fg.-Nr. 15445358→			0 265 <b>006 427</b> <sup>3</sup>		
	<b>2.5 D Turbo</b>		76-77/79-81						
	<b>2.5 TDi</b>	02.94-02.02	62/63/	Fg.-Nr. 15445358→		LAB	0 265 <b>006 405</b> <sup>4</sup>		
			76-77/79-81			RAB	0 265 <b>006 406</b> <sup>4</sup>		
	<b>2.8 D</b>	01.99-04.00	64/90	Fg.-Nr. 15445358→			0 265 <b>006 427</b> <sup>3</sup>		
	<b>2.8 D Turbo</b>	01.99-02.02	64/90	Fg.-Nr. 15445358→		LAB	0 265 <b>006 405</b> <sup>4</sup>		
						RAB	0 265 <b>006 406</b> <sup>4</sup>		
	<b>2.8 HDi</b>	09.00-02.02	94	Fg.-Nr. 15445358→		LAB	0 265 <b>006 405</b> <sup>4</sup>		
						RAB	0 265 <b>006 406</b> <sup>4</sup>		

**Boxer [U5]**

	<b>2.0 HDi</b>	ABO	02.02-05.06	62/80-81		L03	0 986 <b>473 995</b>		← 44
	<b>2.0 i</b>						0 986 <b>474 995</b>		→ 44
		ABS	02.02-05.06	62/80-81		L02	0 986 <b>134 042</b>		← 46
							0 986 <b>135 042</b>		→ 46
						L03	0 986 <b>134 016</b>		← 44
							0 986 <b>135 016</b>		→ 44
	<b>2.2 HDi</b>	ABO	02.02-05.06	74		L03	0 986 <b>473 995</b>		← 44
							0 986 <b>474 995</b>		→ 44
		ABS	02.02-05.06	74		L02	0 986 <b>134 042</b>		← 46
							0 986 <b>135 042</b>		→ 46
						L03	0 986 <b>134 016</b>		← 44
							0 986 <b>135 016</b>		→ 44
	<b>2.3 HDi</b>	ABO	02.02-05.06	81		L03	0 986 <b>473 995</b>		← 44
							0 986 <b>135 016</b>		→
							0 986 <b>474 995</b>		→
		ABS	02.02-05.06	81		L03	0 986 <b>134 016</b>		← 44
	<b>2.8 D Turbo</b>	ABO	02.02-05.06	90/94/107		L03	0 986 <b>473 995</b>		← 44
	<b>2.8 HDi</b>						0 986 <b>474 995</b>		→ 44





	◀ PEUGEOT Boxer [U5]							
	2.8 D Turbo	ABS	02.02-05.06	90/94/107	L02	0986 134 042	46	
	2.8 HDi					0986 135 042	46	
					L03	0986 134 016	44	
						0986 135 016	44	



























































	2.0 HDi, i		02.02-05.06	62/80-81	LOC	0986 475 906	↔ 26,99
	2.2 HDi		02.02-05.06	74	LOC	0986 475 906	↔ 26,99
	2.3 HDi		02.02-05.06	81	LOC	0986 475 906	↔ 26,99
	2.8 D Turbo, HDi		02.02-05.06	90/94/107	LOC	0986 475 906	↔ 26,99

	2.0 HDi		02.02-05.06	62/80-81		0986 473 996	46
	2.0 i					0986 474 996	46
	2.2 HDi		02.02-05.06	74		0986 473 996	46
						0986 474 996	46
	2.3 HDi		02.02-05.06	81		0986 473 996	46
						0986 474 996	46
	2.8 D Turbo		02.02-05.06	90/94/107		0986 473 996	46
	2.8 HDi					0986 474 996	46

	2.0 HDi		02.02-05.06	62/80-81	LLE	1987 482 002	1078
	2.0 i				RLE	1987 482 004	1170
					SBR	1987 482 003	2715
					TBR	1987 477 263	2827
	2.2 HDi		02.02-05.06	74	LLE	1987 482 002	1078
					RLE	1987 482 004	1170
					SBR	1987 482 003	2715
					TBR	1987 477 263	2827
	2.3 HDi		02.02-05.06	81	LLE	1987 482 002	1078
					RLE	1987 482 004	1170
					SBR	1987 482 003	2715
					TBR	1987 477 263	2827
	2.8 D Turbo		02.02-05.06	90/94/107	LLE	1987 482 002	1078
	2.8 HDi				RLE	1987 482 004	1170
					SBR	1987 482 003	2715
					TBR	1987 477 263	2827

**Boxer [U9]**

	2.2 HDi		06.06-03.11	74	1K2	0986 135 304	
					1K4	0986 135 302	
					1K8	0986 135 303	
					284	0986 135 301	
		88			1K2	0986 135 304	
					1K4	0986 135 302	
					1K8	0986 135 303	
					284	0986 135 301	
		06.06-12.11	74		1K2	0986 134 304	
					1K4	0986 134 302	
					1K8	0986 134 303	
					284	0986 134 301	
		88			1K2	0986 134 304	
					1K4	0986 134 302	
					1K8	0986 134 303	
					284	0986 134 301	
		07.10-03.11	95		1K2	0986 135 304	
					1K4	0986 135 302	
					1K8	0986 135 303	
					284	0986 135 301	

		S														
2.2 HDi	07.10-12.11	95					1K2	0 986 134 304	 ←							
							1K4	0 986 134 302	 ←							
							1K8	0 986 134 303	 ←							
							284	0 986 134 301	 ←							
	06.11→	81					1K2	0 986 134 304	 ←							
							1K4	0 986 134 302	 ←							
							1K8	0 986 134 303	 ←							
							284	0 986 134 301	 ←							
		96/110					1K2	0 986 134 304	 ←							
							1K4	0 986 134 302	 ←							
							1K8	0 986 134 303	 ←							
							284	0 986 134 301	 ←							
	3.0 HDi	06.06-03.11	116					1K2	0 986 135 304	 →						
								1K4	0 986 135 302	 →						
								1K8	0 986 135 303	 →						
								284	0 986 135 301	 →						
06.06-12.11		116						1K2	0 986 134 304	 ←						
								1K4	0 986 134 302	 ←						
								1K8	0 986 134 303	 ←						
								284	0 986 134 301	 ←						
01.10-03.11		107						1K2	0 986 135 304	 →						
								1K4	0 986 135 302	 →						
								1K8	0 986 135 303	 →						
								284	0 986 135 301	 →						
01.10→		107						1K2	0 986 134 304	 ←						
								1K4	0 986 134 302	 ←						
								1K8	0 986 134 303	 ←						
								284	0 986 134 301	 ←						
04.10-03.11		115						1K2	0 986 135 304	 →						
								1K4	0 986 135 302	 →						
								1K8	0 986 135 303	 →						
								284	0 986 135 301	 →						
04.10→		115						1K2	0 986 134 304	 ←						
								1K4	0 986 134 302	 ←						
								1K8	0 986 134 303	 ←						
								284	0 986 134 301	 ←						
03.11-03.11		130						1K2	0 986 135 304	 →						
								1K4	0 986 135 302	 →						
								1K8	0 986 135 303	 →						
								284	0 986 135 301	 →						
03.11→	130						1K2	0 986 134 304	 ←							
							1K4	0 986 134 302	 ←							
							1K8	0 986 134 303	 ←							
							284	0 986 134 301	 ←							
	2.2 HDi	06.06→	74/81/88/ 95/96/110				0 986 134 052	 ← 48								
							0 986 135 052	 → 48								
							3.0 HDi	06.06→	107/115/ 116/130					0 986 134 052	 ← 48	
														0 986 135 052	 → 48	
	2.2 HDi	06.06→	74/81/88/ 95				SVN	1 987 482 214	↔ 1485							
							SVN	1 987 482 213	↔ 1390							
							TW	1 987 482 447	2910							
								1 987 482 450	1908							
							06.11→	96						MPR,TW	1 987 482 447	2910
															1 987 482 450	1908
										MPP,TW	1 987 482 447	2910				
											1 987 482 450	1908				
										SVN	1 987 482 214	↔ 1485				
										SVN	1 987 482 213	↔ 1390				







◀ PEUGEOT Boxer [U9]											
2.2 HDi	06.11→	110		SVN	1987 482 214	↔	1485				
				SVN	1987 482 213	↔	1390				
				TW	1987 482 447		2910				
					1987 482 450		1908				
3.0 HDi	06.06-12.11	116		MPR,TW	1987 482 447		2910				
					1987 482 450		1908				
				MPR,TW	1987 482 447		2910				
					1987 482 450		1908				
				SVN	1987 482 214	↔	1485				
				SVN	1987 482 213	↔	1390				
				01.10→ 107/115				SVN	1987 482 214	↔	1485
								SVN	1987 482 213	↔	1390
								TW	1987 482 447		2910
									1987 482 450		1908
03.11→ 130				SVN	1987 482 214	↔	1485				
				SVN	1987 482 213	↔	1390				
				TW	1987 482 447		2910				
					1987 482 450		1908				

**Expert [G9]**

	1.6 HDi	02.07-04.11	66	Org.-Nr. →12571	4SB	0986 134 345	↔	48
						0986 135 345	↔	48
	2.0 HDi	02.07-04.11	88/100/	Org.-Nr. →12571		0986 134 345	↔	48
						2.0 16V	103/120	0986 135 345

	1.6 HDi	02.07→	66			0986 475 950	↔	22
	1.6 HDi	02.07→	66			0986 134 346	↔	41
								0986 135 346
	2.0 HDi	02.07→	72/88/94/			0986 134 346	↔	41
						2.0 16V	100/103/120	0986 135 346

	1.6 HDi	02.07-09.09	66	Org.-Nr. →11986		STB	1987 482 118	↔	1495			
							02.07→	66	4SB,FKR	1987 482 007	↔	1614
									4SB,FLR	1987 482 008	↔	1737
	2.0 HDi	02.07→	72/88/94/			FKR	1987 482 007	↔	1614			
									FLR	1987 482 008	↔	1737
	2.0 16V	02.07→	72/88/94/			FKR	1987 482 007	↔	1614			
									FLR	1987 482 008	↔	1737

	1.6 HDi	02.07→	66			0 265 007 790 <sup>3</sup>		
								0 265 007 791 <sup>4</sup>
	2.0 HDi	02.07→	72/88/94/			0 265 007 790 <sup>3</sup>		
						2.0 16V	100/103/120	0 265 007 791 <sup>4</sup>

**Expert [U64]**

	1.6 i	09.95-05.00	58			BSY	0 204 102 521	↔	57	0 204 100 316 <sup>8</sup>
							0 204 103 521	↔		0 204 104 177 <sup>7</sup>
							0 204 102 523	↔	57	0 204 100 316 <sup>8</sup>
							0 204 103 523	↔		
							GIR	0 986 473 115	↔	57,11
		0 986 474 115	↔	57,11						

		S								
1.8i	09.96-01.07	70	BSY	0 204 102 521	← 57	0 204 100 316 <sup>B</sup>				
				0 204 103 521		0 204 104 177 <sup>7</sup>				
				0 204 102 523	→ 57	0 204 100 316 <sup>B</sup>				
				0 204 103 523						
				GIR	0 986 473 115	← 57,11				
1.9D 1.9D Turbo	09.95-01.07	51-52/ 66-68	BSY	0 204 102 521	← 57	0 204 100 316 <sup>B</sup>				
				0 204 103 521		0 204 104 177 <sup>7</sup>				
				0 204 102 523	→ 57	0 204 100 316 <sup>B</sup>				
				0 204 103 523						
				GIR	0 986 473 115	← 57,11				
2.0HDi 2.0i 16V	10.99-01.07	70/80/81/ 100	BSY	0 204 102 521	← 57	0 204 100 316 <sup>B</sup>				
				0 204 103 521		0 204 104 177 <sup>7</sup>				
				0 204 102 523	→ 57	0 204 100 316 <sup>B</sup>				
				0 204 103 523						
				GIR	0 986 473 115	← 57,11				
	1.6i	09.95-05.00	58	F 026 002 181	↔ 19,05					
	1.8i	09.96-01.07	70	F 026 002 181	↔ 19,05					
	1.9D, D Turbo	09.95-01.07	51-52/66-68	F 026 002 181	↔ 19,05					
	2.0HDi, i 16V	10.99-01.07	70/80/81/100	F 026 002 181	↔ 19,05					
	1.6i	09.95-05.00	58	FKR	1 987 477 565	500				
				FLR	1 987 477 774	903				
				LLE	1 987 477 568	← 1063				
					1 987 477 569	→ 2286				
				RLE	1 987 477 568	← 1063				
		1 987 477 773	→ 2368							
	1.8i	09.96-01.07	70	FKR	1 987 477 565	500				
				FLR	1 987 477 774	903				
				LLE	1 987 477 568	← 1063				
					1 987 477 569	→ 2286				
				RLE	1 987 477 568	← 1063				
		1 987 477 773	→ 2368							
	1.9D 1.9D Turbo	09.95-01.07	51-52/ 66-68	FKR	1 987 477 565	500				
				FLR	1 987 477 774	903				
				LLE	1 987 477 568	← 1063				
				1 987 477 569	→ 2286					
RLE				1 987 477 568	← 1063					
	1 987 477 773	→ 2368								
2.0HDi 2.0i 16V	10.99-01.07	70/80/81/ 100	FKR	1 987 477 565	500					
			FLR	1 987 477 774	903					
			LLE	1 987 477 568	← 1063					
				1 987 477 569	→ 2286					
			RLE	1 987 477 568	← 1063					
	1 987 477 773	→ 2368								
1.6i	06.97-09.97	58	Org.-Nr. 7481→7601	0 265 006 426 <sup>4</sup>						
				06.97-05.00	58	Org.-Nr. 7481→	0 265 006 388 <sup>3</sup>			
				10.97-05.00	58	Org.-Nr. 7602→	0 265 006 504 <sup>4</sup>			
	1.8i	06.97-09.97	70	Org.-Nr. 7481→7601	0 265 006 426 <sup>4</sup>					
					06.97-08.01	70	Org.-Nr. 7481→9050	0 265 006 388 <sup>3</sup>		
					10.97-08.01	70	Org.-Nr. 7602→9050	0 265 006 504 <sup>4</sup>		
	1.9D	06.97-09.97	51-52	Org.-Nr. 7481→7601	0 265 006 426 <sup>4</sup>					
					06.97-05.00	51-52	Org.-Nr. 7481→	0 265 006 388 <sup>3</sup>		
					10.97-05.00	51-52	Org.-Nr. 7602→	0 265 006 504 <sup>4</sup>		



		S							
	◀ PEUGEOT Expert [U64]								
1.9 D		06.98-08.01	51				0 265 006 388 <sup>3</sup>		
							0 265 006 504 <sup>4</sup>		
		09.01-01.07	52				0 265 006 730 <sup>3</sup>		
							0 265 006 731 <sup>4</sup>		
1.9 D Turbo		06.97-09.97	66-68	Org.-Nr. 7481→7601			0 265 006 426 <sup>4</sup>		
		06.97-05.00	66-68	Org.-Nr. 7481→			0 265 006 388 <sup>3</sup>		
		10.97-05.00	66-68	Org.-Nr. 7602→			0 265 006 504 <sup>4</sup>		
2.0 HDi		10.99-08.01	70/80/81/	Org.-Nr. →9050			0 265 006 388 <sup>3</sup>		
2.0 i 16V			100				0 265 006 504 <sup>4</sup>		
		09.01-01.07	70/80/81/	Org.-Nr. 9051→			0 265 006 730 <sup>3</sup>		
			100				0 265 006 731 <sup>4</sup>		
<b>Partner</b>									
	1.8 i	10.99-12.03	66		INB	BO	0 204 102 971	← 54	
							0 204 103 971		
							0 204 102 972	→ 54	
							0 204 103 972		
						GIR	0 986 473 026	← 54	
							0 986 474 026	→ 54	
					INB		0 986 473 025	← 54	
							0 986 474 025	→ 54	
	1.8 i	10.99-12.03	66			TRW	0 986 475 836	↔ 22,2	
	1.9 D	10.99→	51			TRW	0 986 475 836	↔ 22,2	
	1.8 i	10.99-12.03	66				0 265 006 200 <sup>3</sup>		
							0 265 006 659 <sup>4</sup>		
	2.0 HDi	05.02-08.06	66		LAB	BO	0 265 006 201 <sup>3</sup>		
					LIM,SBR		0 265 006 202 <sup>4</sup>		
					RAB	BO	0 265 006 200 <sup>3</sup>		
<b>Partner [B9]</b>									
	Electric	09.12→	42-49				0 986 134 332	← 38	
							0 986 135 332	→ 38	
	1.6 BlueHDi, HDi, VTi, 16V	05.08→	55/66/68/72/73/ 80-81/82/84/88				0 986 134 332	← 38	
							0 986 135 332	→ 38	
	Electric	09.12→	42-49				1 987 482 276	↔ 2402	
	1.6 BlueHDi	12.14→	55/66/68/72/73/80-81/82/84/88				1 987 482 276	↔ 2402	
	1.6 HDi	05.08→	55/66/68/72/73/80-81/82/84/88				1 987 482 276	↔ 2402	
	1.6 VTi	09.09→	55/66/68/72/73/80-81/82/84/88				1 987 482 276	↔ 2402	
	1.6 16V	05.08-02.12	55/66/68/72/73/80-81/82/84/88				1 987 482 276	↔ 2402	
		Electric	09.12→	42-49			0 265 007 788 <sup>3</sup>		
	1.6 BlueHDi	12.14-11.15	73	Org.-Nr. →14237			0 265 007 788 <sup>3</sup>		
							0 265 007 789 <sup>4</sup>		
			88	Org.-Nr. →14237			0 265 007 788 <sup>3</sup>		
							0 265 007 789 <sup>4</sup>		
		03.15-11.15	55	Org.-Nr. →14237			0 265 007 788 <sup>3</sup>		
							0 265 007 789 <sup>4</sup>		
	1.6 HDi	05.08→	55				0 265 007 788 <sup>3</sup>		
							0 265 007 789 <sup>4</sup>		
	1.6 HDi, VTi, 16V	05.08→	66/68/72				0 265 007 788 <sup>3</sup>		
							0 265 007 789 <sup>4</sup>		



		S							
1.6 HDi		05.08→	80-81/82/				0 265 007 788 <sup>3</sup>		
1.6 16V			84				0 265 007 789 <sup>4</sup>		
1.6 VTi		09.09→	88				0 265 007 788 <sup>3</sup>		
							0 265 007 789 <sup>4</sup>		
<b>Partner [M4]</b>									
	<b>Electrique</b>	01.98-08.02	24			INB BO	0 204 102 971	← 54	
							0 204 103 971		
							0 204 102 972	→ 54	
							0 204 103 972		
						GIR	0 986 473 026	← 54	
							0 986 474 026	→ 54	
						INB	0 986 473 025	← 54	
							0 986 474 025	→ 54	
1.1 i		07.96-08.02	44			INB BO	0 204 102 971	← 54	
							0 204 103 971		
							0 204 102 972	→ 54	
							0 204 103 972		
						GIR	0 986 473 026	← 54	
							0 986 474 026	→ 54	
						INB	0 986 473 025	← 54	
							0 986 474 025	→ 54	
1.4		07.96-08.02	51-52/55			INB BO	0 204 102 971	← 54	
1.4 i							0 204 103 971		
							0 204 102 972	→ 54	
							0 204 103 972		
						GIR	0 986 473 026	← 54	
							0 986 474 026	→ 54	
						INB	0 986 473 025	← 54	
							0 986 474 025	→ 54	
1.6 i 16V		09.00-08.02	80			INB BO	0 204 102 971	← 54	
							0 204 103 971		
							0 204 102 972	→ 54	
							0 204 103 972		
						GIR	0 986 473 026	← 54	
							0 986 474 026	→ 54	
1.8 D		07.96-08.02	43-44			INB BO	0 204 102 971	← 54	
							0 204 103 971		
							0 204 102 972	→ 54	
							0 204 103 972		
						GIR	0 986 473 026	← 54	
							0 986 474 026	→ 54	
						INB	0 986 473 025	← 54	
							0 986 474 025	→ 54	
1.8 i		03.97-08.02	66			INB BO	0 204 102 971	← 54	
							0 204 103 971		
							0 204 102 972	→ 54	
							0 204 103 972		
						GIR	0 986 473 026	← 54	
							0 986 474 026	→ 54	
1.9 D		07.96-08.02	50/51			INB BO	0 204 102 971	← 54	
							0 204 103 971		
							0 204 102 972	→ 54	
							0 204 103 972		
						GIR	0 986 473 026	← 54	
							0 986 474 026	→ 54	
						INB	0 986 473 025	← 54	
							0 986 474 025	→ 54	





	◀ PEUGEOT Partner [M4]									
1.9D	09.00-08.02	52	INB	BO	0 204 102 971	← 54				
					0 204 103 971					
					0 204 102 972	→ 54				
					0 204 103 972					
					GIR	0 986 473 026	← 54			
					GIR	0 986 474 026	→ 54			
2.0 HDi	12.99-08.02	66	INB	BO	0 204 102 971	← 54				
					0 204 103 971					
					0 204 102 972	→ 54				
					0 204 103 972					
					GIR	0 986 473 026	← 54			
					GIR	0 986 474 026	→ 54			
					INB	0 986 473 025	← 54			
						0 986 474 025	→ 54			

	Electrique									
1.1 i	07.96-08.02	44			0 986 475 836	↔ 22,2				
					0 986 475 836	↔ 22,2				
					0 986 475 836	↔ 22,2				
					0 986 475 836	↔ 22,2				
					0 986 475 836	↔ 22,2				
					0 986 475 836	↔ 22,2				
					0 986 475 836	↔ 22,2				
1.4, i	07.96-08.02	51-52/55			0 986 475 836	↔ 22,2				
1.6 i 16V	09.00-08.02	80			0 986 475 836	↔ 22,2				
1.8 D, i	07.96-08.02	43-44/66			0 986 475 836	↔ 22,2				
1.9 D	07.96-08.02	50/51/52			0 986 475 836	↔ 22,2				
2.0 HDi	12.99-08.02	66			0 986 475 836	↔ 22,2				

1.1 i	07.96-11.99	44	Org.-Nr. →8393	1 987 477 576	← 1745					
				1 987 477 577	→ 1818					
1.4	11.96-11.99	51-52	Org.-Nr. →8393	1 987 477 576	← 1745					
				1 987 477 577	→ 1818					
1.4 i	07.96-11.99	55	Org.-Nr. →8393	1 987 477 576	← 1745					
				1 987 477 577	→ 1818					
1.6 i 16V	09.00-08.02	80		1 987 477 576	← 1745					
				1 987 477 595	→ 1850					
1.8 D	07.96-11.99	43-44/66	Org.-Nr. →8393	1 987 477 576	← 1745					
				1 987 477 577	→ 1818					
1.8 i	12.99-08.02	43-44/66	Org.-Nr. 8394→	1 987 477 576	← 1745					
				1 987 477 595	→ 1850					
1.9 D	07.96-11.99	50/51	Org.-Nr. →8393	1 987 477 576	← 1745					
				1 987 477 577	→ 1818					
2.0 HDi	12.99-08.02	66		1 987 477 576	← 1745					
				1 987 477 595	→ 1850					

	Electrique									
1.1 i	07.96-05.01	44	Org.-Nr. →8938	0 265 006 209 <sup>4</sup>						
				0 265 006 200 <sup>3</sup>						
				0 265 006 659 <sup>4</sup>						
				0 265 006 209 <sup>4</sup>						
				0 265 006 200 <sup>3</sup>						
				0 265 006 659 <sup>4</sup>						
1.4	06.01-08.02	24	Org.-Nr. 8939→	0 265 006 659 <sup>4</sup>						
				0 265 006 209 <sup>4</sup>						
				0 265 006 200 <sup>3</sup>						
1.8 i	07.96-08.02	44	Org.-Nr. →8938	0 265 006 209 <sup>4</sup>						
				0 265 006 200 <sup>3</sup>						
				0 265 006 659 <sup>4</sup>						

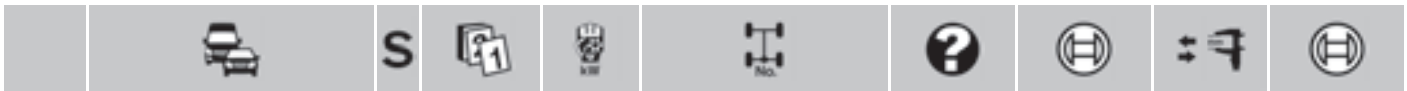

<b>1.4</b>	07.96-05.01	51-52/55	Org.-Nr. →8938	0 265 <b>006 209</b> <sup>4</sup>
<b>1.4i</b>	07.96-08.02	51-52/55		0 265 <b>006 200</b> <sup>3</sup>
	06.01-08.02	51-52/55	Org.-Nr. 8939→	0 265 <b>006 659</b> <sup>4</sup>
<b>1.6 i 16V</b>	09.00-05.01	80	Org.-Nr. →8938	0 265 <b>006 209</b> <sup>4</sup>
	09.00-08.02	80		0 265 <b>006 200</b> <sup>3</sup>
	06.01-08.02	80	Org.-Nr. 8939→	0 265 <b>006 659</b> <sup>4</sup>
<b>1.8 D</b>	07.96-05.01	43-44/66	Org.-Nr. →8938	0 265 <b>006 209</b> <sup>4</sup>
<b>1.8 i</b>	07.96-08.02	43-44/66		0 265 <b>006 200</b> <sup>3</sup>
	06.01-08.02	43-44/66	Org.-Nr. 8939→	0 265 <b>006 659</b> <sup>4</sup>
<b>1.9 D</b>	07.96-05.01	50/51/52	Org.-Nr. →8938	0 265 <b>006 209</b> <sup>4</sup>
	07.96-08.02	50/51/52		0 265 <b>006 200</b> <sup>3</sup>
	06.01-08.02	50/51/52	Org.-Nr. 8939→	0 265 <b>006 659</b> <sup>4</sup>
<b>2.0 HDi</b>	12.99-05.01	66	Org.-Nr. →8938	0 265 <b>006 209</b> <sup>4</sup>
	12.99-08.02	66		0 265 <b>006 200</b> <sup>3</sup>
	06.01-08.02	66	Org.-Nr. 8939→	0 265 <b>006 659</b> <sup>4</sup>

**Partner [M5]**



	<b>Electric</b>	09.02-04.08	28	0 204 <b>004 451</b>	← 54
				0 204 <b>103 971</b>	
				0 204 <b>004 452</b>	→ 54
	<b>1.1 i</b>	09.02-10.05	44	0 204 <b>102 971</b>	← 54
				0 204 <b>103 971</b>	
				0 204 <b>102 972</b>	→ 54
				0 204 <b>103 972</b>	
	<b>1.4 i</b>	09.02-04.08	55	0 204 <b>004 451</b>	← 54
				0 204 <b>103 971</b>	
				0 204 <b>004 452</b>	→ 54
				0 204 <b>102 971</b>	← 54
				0 204 <b>103 971</b>	
				0 204 <b>102 972</b>	→ 54
				0 204 <b>103 972</b>	
	<b>1.6 HDi</b>	07.05-10.11	55	0 204 <b>102 971</b>	← 54
				0 204 <b>103 971</b>	
				0 204 <b>102 972</b>	→ 54
				0 204 <b>103 972</b>	
		09.05-04.08	66	0 204 <b>004 451</b>	← 54
				0 204 <b>103 971</b>	
				0 204 <b>004 452</b>	→ 54
	<b>1.6 i 16V</b>	MFD 09.02-04.08	80	0 204 <b>102 974</b>	→ 54
		OFD 09.02-04.08	80	0 204 <b>004 451</b>	← 54
				0 204 <b>103 971</b>	
				0 204 <b>004 452</b>	→ 54
	<b>1.9 D</b>	09.02-03.07	52	0 204 <b>102 971</b>	← 54
				0 204 <b>103 971</b>	
				0 204 <b>102 972</b>	→ 54
				0 204 <b>103 972</b>	
	<b>2.0 HDi</b>	09.02-07.06	66	0 204 <b>004 451</b>	← 54
				0 204 <b>103 971</b>	
				0 204 <b>004 452</b>	→ 54





























	<b>1.1 i</b>	09.02-10.05	44	0 986 <b>475 836</b>	↔ 22,2
	<b>1.4 i</b>	09.02-04.08	55	0 986 <b>475 836</b>	↔ 22,2
	<b>1.6 HDi, i 16V</b>	09.02-10.11	55/66/80	0 986 <b>475 836</b>	↔ 22,2
	<b>1.9 D</b>	09.02-03.07	52	0 986 <b>475 836</b>	↔ 22,2
	<b>2.0 HDi</b>	09.02-07.06	66	0 986 <b>475 836</b>	↔ 22,2

	<b>Electric</b>	09.02-04.08	28	0 986 <b>134 038</b>	← 38
				0 986 <b>135 038</b>	→ 38



		S										
◀ PEUGEOT Partner [M5]												
1.1 i	09.02-10.05	44					0986 134 038		← 38			
							0986 135 038		→ 38			
1.4 i	09.02-04.08	55					0986 134 038		← 38			
							0986 135 038		→ 38			
1.6 HDi	09.02-10.11	55/66/80					0986 134 038		← 38			
1.6 i 16V							0986 135 038		→ 38			
1.9 D	09.02-03.07	52					0986 134 038		← 38			
							0986 135 038		→ 38			
2.0 HDi	09.02-07.06	66					0986 134 038		← 38			
							0986 135 038		→ 38			
1.1 i	09.02-10.05	44					1987 477 576		← 1745			
							1987 477 595		→ 1850			
1.4 i	09.02-04.08	55					1987 477 576		← 1745			
							1987 477 595		→ 1850			
1.6 HDi	09.02-04.08	66/80				SBR	1987 482 116		← 1820			
1.6 i 16V							1987 482 117		→ 1922			
						TBR	1987 477 576		← 1745			
							1987 477 595		→ 1850			
1.9 D	09.02-03.07	52					1987 477 576		← 1745			
							1987 477 595		→ 1850			
2.0 HDi	09.02-07.06	66				SBR	1987 482 116		← 1820			
							1987 482 117		→ 1922			
						TBR	1987 477 576		← 1745			
							1987 477 595		→ 1850			
Electric	09.02-02.03	28	Org.-Nr. →9582				0265 006 659 <sup>4</sup>					
							09.02-11.04	28	Org.-Nr. →10220	0265 006 200 <sup>3</sup>		
							03.03-11.04	28	Org.-Nr. 9583→10220	0265 006 793 <sup>4</sup>		
							12.04-07.05	28	Org.-Nr. 10221→10478	RAB	0265 007 667 <sup>4</sup>	
							12.04-04.08	28	Org.-Nr. 10221→		0265 007 666 <sup>3</sup>	
										LAB	0265 007 668 <sup>4</sup>	
1.1 i	09.02-02.03	44	Org.-Nr. →9582				0265 006 659 <sup>4</sup>					
							09.02-11.04	44	Org.-Nr. →10220	0265 006 200 <sup>3</sup>		
							03.03-11.04	44	Org.-Nr. 9583→10220	0265 006 793 <sup>4</sup>		
							12.04-07.05	44	Org.-Nr. 10221→10478	RAB	0265 007 667 <sup>4</sup>	
							12.04-10.05	44	Org.-Nr. 10221→		0265 007 666 <sup>3</sup>	
										LAB	0265 007 668 <sup>4</sup>	
1.4 i	09.02-02.03	55	Org.-Nr. →9582				0265 006 659 <sup>4</sup>					
							09.02-11.04	55	Org.-Nr. →10220	0265 006 200 <sup>3</sup>		
							03.03-11.04	55	Org.-Nr. 9583→10220	0265 006 793 <sup>4</sup>		
							12.04-07.05	55	Org.-Nr. 10221→10478	RAB	0265 007 667 <sup>4</sup>	
							12.04-04.08	55	Org.-Nr. 10221→		0265 007 666 <sup>3</sup>	
										LAB	0265 007 668 <sup>4</sup>	
1.6 HDi	07.05-10.11	55	Org.-Nr. 10479→			RAB	0265 007 883 <sup>4</sup>					
							09.05-04.08	66		0265 007 666 <sup>3</sup>		
										LAB	0265 007 668 <sup>4</sup>	
										RAB	0265 007 883 <sup>4</sup>	
											0265 007 666 <sup>3</sup>	
											0265 007 668 <sup>4</sup>	
1.6 i 16V	09.02-02.03	80	Org.-Nr. →9582			HTB	0265 006 659 <sup>4</sup>					
							09.02-11.04	80	Org.-Nr. →10220	0265 006 200 <sup>3</sup>		
										SBR	0265 006 732 <sup>4</sup>	
							03.03-11.04	80	Org.-Nr. 9583→10220	HTB	0265 006 793 <sup>4</sup>	
							12.04-07.05	80	Org.-Nr. 10221→10478	RAB	0265 007 667 <sup>4</sup>	
							12.04-04.08	80	Org.-Nr. 10221→		0265 007 666 <sup>3</sup>	
1.9 D	09.02-02.03	52	Org.-Nr. →9582				0265 006 659 <sup>4</sup>					
							09.02-11.04	52	Org.-Nr. →10220	0265 006 200 <sup>3</sup>		
											0265 007 666 <sup>3</sup>	
											0265 007 668 <sup>4</sup>	
											0265 007 883 <sup>4</sup>	
											0265 007 666 <sup>3</sup>	

		S								
1.9D		03.03-11.04	52	Org.-Nr. 9583→10220			0 265 006 793 <sup>4</sup>			
		12.04-07.05	52	Org.-Nr. 10221→10478	RAB		0 265 007 667 <sup>4</sup>			
		12.04-03.07	52	Org.-Nr. 10221→			0 265 007 666 <sup>3</sup>			
					LAB		0 265 007 668 <sup>4</sup>			
2.0 HDi		08.05-03.07	52	Org.-Nr. 10479→	RAB		0 265 007 883 <sup>4</sup>			
		09.02-02.03	66	Org.-Nr. →9582	HTB		0 265 006 659 <sup>4</sup>			
		09.02-11.04	66	Org.-Nr. →10220			0 265 006 200 <sup>3</sup>			
					SBR		0 265 006 732 <sup>4</sup>			
		03.03-11.04	66	Org.-Nr. 9583→10220	HTB		0 265 006 793 <sup>4</sup>			
		12.04-07.05	66	Org.-Nr. 10221→10478	RAB		0 265 007 667 <sup>4</sup>			
		12.04-07.06	66	Org.-Nr. 10221→			0 265 007 666 <sup>3</sup>			
					LAB		0 265 007 668 <sup>4</sup>			
	08.05-07.06	66	Org.-Nr. 10479→	RAB		0 265 007 883 <sup>4</sup>				
<b>Ranch [M4]</b>										
										
	1.4i	07.97-08.02	55		INB	BO	0 204 102 971	← 54		
							0 204 103 971			
							0 204 102 972	→ 54		
							0 204 103 972			
							GIR	0 986 473 026	 ← 54	
								0 986 474 026	 → 54	
							INB	0 986 473 025	 ← 54	
								0 986 474 025	 → 54	
1.9D	07.97-08.02	51		INB	BO	0 204 102 971	← 54			
						0 204 103 971				
						0 204 102 972	→ 54			
						0 204 103 972				
						GIR	0 986 473 026	 ← 54		
							0 986 474 026	 → 54		
						INB	0 986 473 025	 ← 54		
							0 986 474 025	 → 54		
										
	1.4i	07.97-08.02	55				0 986 475 836	↔ 22,2		
	1.9D	07.97-08.02	51				0 986 475 836	↔ 22,2		
										
	1.4i	07.97-11.99	55	Org.-Nr. →8393			1 987 477 576	← 1745		
							1 987 477 577	→ 1818		
		12.99-08.02	55	Org.-Nr. 8394→				1 987 477 576	← 1745	
								1 987 477 595	→ 1850	
	1.9D	07.97-10.98	51				1 987 477 576	← 1745		
							1 987 477 577	→ 1818		
		11.98-11.99	51	Org.-Nr. →8393				1 987 477 576	← 1745	
								1 987 477 577	→ 1818	
12.99-08.02	51	Org.-Nr. 8394→				1 987 477 576	← 1745			
						1 987 477 595	→ 1850			
	1.4i	07.97-05.01	55	Org.-Nr. →8938			0 265 006 209 <sup>4</sup>			
		07.97-08.02	55				0 265 006 200 <sup>3</sup>			
		06.01-08.02	55	Org.-Nr. 8939→			0 265 006 659 <sup>4</sup>			
	1.9D	07.97-10.98	51				0 265 006 209 <sup>4</sup>			
		07.97-08.02	51				0 265 006 200 <sup>3</sup>			
		11.98-05.01	51	Org.-Nr. →8938			0 265 006 209 <sup>4</sup>			
	06.01-08.02	51	Org.-Nr. 8939→			0 265 006 659 <sup>4</sup>				





		S							
◀ PEUGEOT									
<b>RCZ R [T75]</b>									
	1.6 THP	09.13→	199		FBJ		0986 134 230		←
							0986 135 230		→
<b>RCZ [T75]</b>									
	1.6 THP	01.10→	110/115/ 120/147		FBJ		0986 134 230		←
							0986 135 230		→
	2.0 HDi	01.10→	120		FBJ		0986 134 230		←
							0986 135 230		→
<b>106 [S1]</b>									
	1.0	09.91-04.96	33/37		LWG	BSY	0204 102 289	← 48	0204 100 098 <sup>8</sup>
	1.0i						0986 473 103		0204 104 039 <sup>7</sup>
							0204 102 290	→ 48	0204 100 098 <sup>8</sup>
							0986 474 103		
				Fg.-Nr. 50821832→	VFG	BSY	0204 102 289	← 48	0204 100 098 <sup>8</sup>
							0986 473 103		0204 104 039 <sup>7</sup>
							0204 102 290	→ 48	0204 100 098 <sup>8</sup>
							0986 474 103		
		ABO 09.91-04.96	33/37		3LO		0986 471 885	← 45	
							0986 473 885		
							0986 471 886	→ 45	
							0986 473 886		
	1.0i	ABS 07.92-04.96	33/37			BSY	0204 102 228	← 48	
							0986 473 286		
							0204 102 229	→ 48	
							0986 474 286		
	1.1	07.92-04.96	40		LWG	BSY	0204 102 289	← 48	0204 100 098 <sup>8</sup>
							0986 473 103		0204 104 039 <sup>7</sup>
							0204 102 290	→ 48	0204 100 098 <sup>8</sup>
							0986 474 103		
					4LO,INB		0204 102 289	← 48	0204 100 098 <sup>8</sup>
							0986 473 103		0204 104 039 <sup>7</sup>
							0204 102 290	→ 48	0204 100 098 <sup>8</sup>
							0986 474 103		
				Fg.-Nr. 50821832→	VFG	BSY	0204 102 289	← 48	0204 100 098 <sup>8</sup>
							0986 473 103		0204 104 039 <sup>7</sup>
							0204 102 290	→ 48	0204 100 098 <sup>8</sup>
							0986 474 103		
	1.1	09.91-04.96	40-44		LWG	BSY	0204 102 289	← 48	0204 100 098 <sup>8</sup>
	1.1i						0986 473 103		0204 104 039 <sup>7</sup>
							0204 102 290	→ 48	0204 100 098 <sup>8</sup>
							0986 474 103		
				Fg.-Nr. 50821832→	VFG	BSY	0204 102 289	← 48	0204 100 098 <sup>8</sup>
							0986 473 103		0204 104 039 <sup>7</sup>
							0204 102 290	→ 48	0204 100 098 <sup>8</sup>
							0986 474 103		
		ABO 09.91-04.96	40-44		3LO		0986 471 885	← 45	
							0986 473 885		
							0986 471 886	→ 45	
							0986 473 886		
	1.1i	ABS 08.92-04.96	40-44			BSY	0204 102 228	← 48	
							0986 473 286		
							0204 102 229	→ 48	
							0986 474 286		



		S												
1.3i		10.93-04.96	72-74	Fg.-Nr. →51132346	INB	BSY	0 204 <b>102 224</b>	← 48	0 204 <b>100 098</b> <sup>B</sup>					
							0 204 <b>103 224</b>		0 204 <b>104 039</b> <sup>7</sup>					
							0 204 <b>102 225</b>	→ 48	0 204 <b>100 098</b> <sup>B</sup>					
							0 204 <b>103 225</b>							
				Fg.-Nr. 51132347→	INB	ATE	0 986 <b>473 887</b>	← 48						
							0 986 <b>473 888</b>	→ 48						
1.4 1.4D 1.4i		09.91-04.96	37/55-56	Fg.-Nr. 50821832→	4LO	BSY	0 204 <b>102 289</b>	← 48	0 204 <b>100 098</b> <sup>B</sup>					
							0 986 <b>473 103</b>		0 204 <b>104 039</b> <sup>7</sup>					
							0 204 <b>102 290</b>	→ 48	0 204 <b>100 098</b> <sup>B</sup>					
							0 986 <b>474 103</b>							
1.4 1.4i	ABS	09.91-04.96	55-56	Fg.-Nr. →51132346	INB	BSY	0 204 <b>102 228</b>	← 48	0 204 <b>100 098</b> <sup>B</sup>					
							0 986 <b>473 286</b>		0 204 <b>104 039</b> <sup>7</sup>					
							0 204 <b>102 229</b>	→ 48	0 204 <b>100 098</b> <sup>B</sup>					
							0 986 <b>474 286</b>							
				Fg.-Nr. 51132347→	INB	ATE	0 986 <b>473 887</b>	← 48						
							0 986 <b>473 888</b>	→ 48						
1.4D	ABS	09.92-04.96	37	Fg.-Nr. →51132346	INB	BSY	0 204 <b>102 228</b>	← 48	0 204 <b>100 098</b> <sup>B</sup>					
							0 986 <b>473 286</b>		0 204 <b>104 039</b> <sup>7</sup>					
							0 204 <b>102 229</b>	→ 48	0 204 <b>100 098</b> <sup>B</sup>					
							0 986 <b>474 286</b>							
1.4i		09.91-04.96	69/72		INB	BSY	0 204 <b>102 224</b>	← 48	0 204 <b>100 098</b> <sup>B</sup>					
							0 204 <b>103 224</b>		0 204 <b>104 039</b> <sup>7</sup>					
							0 204 <b>102 225</b>	→ 48	0 204 <b>100 098</b> <sup>B</sup>					
							0 204 <b>103 225</b>							
1.5D		07.94-04.96	40-42	Fg.-Nr. 50821832→	4LO	BSY	0 204 <b>102 289</b>	← 48	0 204 <b>100 098</b> <sup>B</sup>					
							0 986 <b>473 103</b>		0 204 <b>104 039</b> <sup>7</sup>					
							0 204 <b>102 290</b>	→ 48	0 204 <b>100 098</b> <sup>B</sup>					
							0 986 <b>474 103</b>							
	ABS	07.94-04.96	40-42	Fg.-Nr. →51132346	INB	BSY	0 204 <b>102 228</b>	← 48	0 204 <b>100 098</b> <sup>B</sup>					
							0 986 <b>473 286</b>		0 204 <b>104 039</b> <sup>7</sup>					
							0 204 <b>102 229</b>	→ 48	0 204 <b>100 098</b> <sup>B</sup>					
							0 986 <b>474 286</b>							
				Fg.-Nr. 51132347→	INB	ATE	0 986 <b>473 887</b>	← 48						
							0 986 <b>473 888</b>	→ 48						
1.6i		06.93-04.96	65-66	Fg.-Nr. 50821832→	4LO	BSY	0 204 <b>102 289</b>	← 48	0 204 <b>100 098</b> <sup>B</sup>					
							0 986 <b>473 103</b>		0 204 <b>104 039</b> <sup>7</sup>					
							0 204 <b>102 290</b>	→ 48	0 204 <b>100 098</b> <sup>B</sup>					
							0 986 <b>474 103</b>							
			76-77	Fg.-Nr. →51132346	INB	BSY	0 204 <b>102 224</b>	← 48	0 204 <b>100 098</b> <sup>B</sup>					
							0 204 <b>103 224</b>		0 204 <b>104 039</b> <sup>7</sup>					
							0 204 <b>102 225</b>	→ 48	0 204 <b>100 098</b> <sup>B</sup>					
							0 204 <b>103 225</b>							
				Fg.-Nr. 51132347→	INB	ATE	0 986 <b>473 887</b>	← 48						
							0 986 <b>473 888</b>	→ 48						
	ABS	06.93-04.96	65-66	Fg.-Nr. →51132346	INB	BSY	0 204 <b>102 228</b>	← 48	0 204 <b>100 098</b> <sup>B</sup>					
							0 986 <b>473 286</b>		0 204 <b>104 039</b> <sup>7</sup>					
							0 204 <b>102 229</b>	→ 48	0 204 <b>100 098</b> <sup>B</sup>					
							0 986 <b>474 286</b>							
				Fg.-Nr. 51132347→	INB	ATE	0 986 <b>473 887</b>	← 48						
							0 986 <b>473 888</b>	→ 48						
	1.0	09.91-04.96	33		LWG,VFG		F 026 <b>002 222</b>	← 19						
							F 026 <b>002 223</b>	→ 19						
		ABO	09.91-04.96	33		4LO	BSY	F 026 <b>002 222</b>	← 19					
								F 026 <b>002 223</b>	→ 19					
		1.0	ABO	09.91-04.96	33		3LO	BSY	F 026 <b>002 228</b>	← 19				
									F 026 <b>002 229</b>	→ 19				
		1.0i		07.92-04.96	33		LWG,VFG		F 026 <b>002 222</b>	← 19				
									F 026 <b>002 223</b>	→ 19				
									37		LWG,VFG	F 026 <b>002 222</b>	← 19	
												F 026 <b>002 223</b>	→ 19	





◀ PEUGEOT 106 [S1]										
1.0 i	ABO	07.92-04.96	33	4LO	BSY	F 026 <b>002 222</b>	← 19			
			37			3LO	BSY	F 026 <b>002 223</b>	→ 19	
1.1	ABS	07.92-04.96	33/37	4LO		F 026 <b>002 228</b>	← 19			
			09.91-04.96			44	LWG,VFG	F 026 <b>002 229</b>	→ 19	
	ABO	09.91-04.96	44	3LO	BSY	F 026 <b>002 222</b>	← 19			
						4LO	BSY	F 026 <b>002 228</b>	← 19	
				3LO	BSY	F 026 <b>002 222</b>	← 19			
						4LO	BSY	F 026 <b>002 228</b>	← 19	
	1.1 i	ABS	08.92-04.96	40-44	4LO		F 026 <b>002 222</b>	← 19		
				09.91-04.96			44	LWG,VFG	F 026 <b>002 223</b>	→ 19
		ABO	08.92-04.96	40-44	3LO	BSY	F 026 <b>002 228</b>	← 19		
							4LO	BSY	F 026 <b>002 229</b>	→ 19
	ABS	08.92-04.96	40-44	4LO		F 026 <b>002 222</b>	← 19			
						09.91-04.96	44	LWG,VFG	F 026 <b>002 223</b>	→ 19
1.3 i	ABO	10.93-04.96	72-74	4LO	BSY	F 026 <b>002 222</b>	← 19			
			10.93-04.96			72-74	4LO		F 026 <b>002 223</b>	→ 19
1.4	ABO	07.92-04.96	44	3LO	BSY	F 026 <b>002 228</b>	← 19			
						4LO	BSY	F 026 <b>002 229</b>	→ 19	
1.4, D, i	ABS	09.91-04.96	37/44/55-56/69/72	4LO		F 026 <b>002 175</b>	↔ 19			
1.4	ABO	09.91-04.96	55-56/69/	4LO	BSY	F 026 <b>002 222</b>	← 19			
1.4 i			72			F 026 <b>002 223</b>	→ 19			
1.4 D	ABO	09.92-04.96	37	4LO	BSY	F 026 <b>002 222</b>	← 19			
						4LO	BSY	F 026 <b>002 223</b>	→ 19	
1.5 D	ABO	07.94-04.96	40-42	4LO	BSY	F 026 <b>002 222</b>	← 19			
						4LO	BSY	F 026 <b>002 223</b>	→ 19	
	ABS	07.94-04.96	40-42	4LO		F 026 <b>002 175</b>	↔ 19			
						06.93-04.96	65-66/	4LO	BSY	F 026 <b>002 222</b>
1.6 i	ABO	06.93-04.96	76-77	4LO	BSY	F 026 <b>002 223</b>	→ 19			
			06.93-04.96			65-66/76-77	4LO		F 026 <b>002 175</b>	↔ 19



	1.0	09.91-04.96	33/37	Fg.-Nr. →51224674	1987 <b>477 427</b>	1292
	1.0 i			Fg.-Nr. 51224675→	1987 <b>477 442</b>	1442
	1.1	07.92-04.96	40	Fg.-Nr. →51224674	1987 <b>477 427</b>	1292
	1.1	09.91-04.96	40-44	Fg.-Nr. →51224674	1987 <b>477 427</b>	1292
	1.1 i			Fg.-Nr. 51224675→	1987 <b>477 442</b>	1442
	1.3 i	10.93-04.96	72-74	Fg.-Nr. →51224674	1987 <b>477 427</b>	1292
					Fg.-Nr. 51224675→	1987 <b>477 442</b>
	1.4	09.91-04.96	37/44/	Fg.-Nr. →51224674	1987 <b>477 427</b>	1292
	1.4 D, i		55-56/	Fg.-Nr. 51224675→	1987 <b>477 442</b>	1442
					69/72	
	1.5 D	07.94-04.96	40-42	Fg.-Nr. →51224674	1987 <b>477 427</b>	1292
					Fg.-Nr. 51224675→	1987 <b>477 442</b>
	1.6 i	06.93-04.96	65-66/	Fg.-Nr. →51224674	1987 <b>477 427</b>	1292
					76-77	Fg.-Nr. 51224675→

		S								
<b>106 [S2]</b>										
	<b>Electric</b>	07.95-05.05	11-20		4LO,INB	0 204 102 289	← 48	0 204 100 098 <sup>B</sup>		
						0 986 473 103		0 204 104 039 <sup>7</sup>		
						0 204 102 290	→ 48	0 204 100 098 <sup>B</sup>		
						0 986 474 103				
	<b>1.0i</b>	05.96-05.05	33/37		4LO,INB	0 204 102 289	← 48	0 204 100 098 <sup>B</sup>		
						0 986 473 103		0 204 104 039 <sup>7</sup>		
						0 204 102 290	→ 48	0 204 100 098 <sup>B</sup>		
						0 986 474 103				
		ABO 05.96-05.05	33/37		3LO	0 986 471 885	← 45			
						0 986 473 885				
						0 986 471 886	→ 45			
						0 986 473 886				
	<b>1.1i</b>	05.96-05.05	40-44		4LO,INB	0 204 102 289	← 48	0 204 100 098 <sup>B</sup>		
						0 986 473 103		0 204 104 039 <sup>7</sup>		
						0 204 102 290	→ 48	0 204 100 098 <sup>B</sup>		
						0 986 474 103				
			44		4LO,INB	0 204 102 289	← 48	0 204 100 098 <sup>B</sup>		
						0 986 473 103		0 204 104 039 <sup>7</sup>		
						0 204 102 290	→ 48	0 204 100 098 <sup>B</sup>		
						0 986 474 103				
		03.00-05.05	44		4LO,INB	0 204 102 290	→ 48	0 204 104 039 <sup>7</sup>		
						0 986 474 103				
		ABO 05.96-05.05	40-44		3LO	0 986 471 885	← 45			
						0 986 473 885				
						0 986 471 886	→ 45			
						0 986 473 886				
	<b>1.4</b>	05.96-05.05	55		4LO,INB	0 204 102 290	→ 48	0 204 100 098 <sup>B</sup>		
						0 986 474 103				
	<b>1.4</b>	05.96-05.05	55		4LO,INB	0 204 102 289	← 48	0 204 100 098 <sup>B</sup>		
	<b>1.4i</b>					0 986 473 103		0 204 104 039 <sup>7</sup>		
	<b>1.4i</b>	05.96-05.05	55		4LO,INB	0 204 102 290	→ 48	0 204 100 098 <sup>B</sup>		
						0 986 474 103		0 204 104 039 <sup>7</sup>		
	<b>1.5D</b>	05.96-05.05	40		4LO,INB	0 204 102 289	← 48	0 204 100 098 <sup>B</sup>		
						0 986 473 103		0 204 104 039 <sup>7</sup>		
						0 204 102 290	→ 48	0 204 100 098 <sup>B</sup>		
						0 986 474 103				
			40-42		INB ATE	0 986 473 887	← 48			
						0 986 473 888	→ 48			
					4LO,INB	0 204 102 289	← 48	0 204 100 098 <sup>B</sup>		
						0 986 473 103		0 204 104 039 <sup>7</sup>		
						0 204 102 290	→ 48	0 204 100 098 <sup>B</sup>		
						0 986 474 103				
		07.00-05.05	42		4LO,INB	0 204 102 289	← 48	0 204 104 039 <sup>7</sup>		
						0 986 473 103				
						0 204 102 290	→ 48	0 204 104 039 <sup>7</sup>		
						0 986 474 103				
	<b>1.6i</b>	05.96-05.05	65-66		4LO,INB	0 204 102 289	← 48	0 204 100 098 <sup>B</sup>		
						0 986 473 103		0 204 104 039 <sup>7</sup>		
						0 204 102 290	→ 48	0 204 100 098 <sup>B</sup>		
						0 986 474 103				
	<b>1.6i</b>	05.96-05.05	74-77/		INB ATE	0 986 473 887	← 48			
	<b>1.6i 16S</b>		87-88			0 986 473 888	→ 48			
	<b>Electric</b>	ABO 07.95-05.05	11-20		4LO BSY	F 026 002 175	↔ 19			



<b>PEUGEOT 106 [S2]</b>									
<b>1.0 i</b>	ABO	05.96-05.05	33/37			3LO	BSY	F 026 <b>002 228</b>	← 19
								F 026 <b>002 229</b>	→ 19
						4LO	BSY	F 026 <b>002 222</b>	← 19
								F 026 <b>002 223</b>	→ 19
	ABS	05.96-11.98	33/37	Org.-Nr. →8056		GIR	0986 <b>475 797</b>	↔ 20,6	
		12.98-05.05	33/37	Org.-Nr. 8057→		GIR	0986 <b>475 833</b>	↔ 20,6	
<b>1.1 i</b>	ABO	05.96-05.05	40-44			3LO	BSY	F 026 <b>002 228</b>	← 19
								F 026 <b>002 229</b>	→ 19
						4LO	BSY	F 026 <b>002 222</b>	← 19
								F 026 <b>002 223</b>	→ 19
	ABS	05.96-11.98	40-44	Org.-Nr. →8056		GIR	0986 <b>475 797</b>	↔ 20,6	
			44	Org.-Nr. →8056		GIR	0986 <b>475 797</b>	↔ 20,6	
		12.98-05.05	40-44	Org.-Nr. 8057→		GIR	0986 <b>475 833</b>	↔ 20,6	
			44	Org.-Nr. 8057→		GIR	0986 <b>475 833</b>	↔ 20,6	
		03.00-05.05	44			GIR	0986 <b>475 833</b>	↔ 20,6	
						GIR	0986 <b>475 833</b>	↔ 20,6	
<b>1.4</b>	ABS	12.98-05.05	55	Org.-Nr. 8057→		GIR	0986 <b>475 833</b>	↔ 20,6	
<b>1.4</b>	ABO	05.96-05.05	55			4LO	BSY	F 026 <b>002 222</b>	← 19
<b>1.4 i</b>								F 026 <b>002 223</b>	→ 19
	ABS	05.96-11.98	55	Org.-Nr. →8056		GIR	0986 <b>475 797</b>	↔ 20,6	
		12.98-05.05	55	Org.-Nr. 8057→		GIR	0986 <b>475 833</b>	↔ 20,6	
		03.00-05.05	55			GIR	0986 <b>475 833</b>	↔ 20,6	
						GIR	0986 <b>475 833</b>	↔ 20,6	
<b>1.5 D</b>	ABO	05.96-05.05	40-42			4LO	BSY	F 026 <b>002 222</b>	← 19
								F 026 <b>002 223</b>	→ 19
	ABS	05.96-11.98	40-42	Org.-Nr. →8056		GIR	0986 <b>475 797</b>	↔ 20,6	
		12.98-05.05	40-42	Org.-Nr. 8057→		GIR	0986 <b>475 833</b>	↔ 20,6	
		07.00-05.05	42			GIR	0986 <b>475 833</b>	↔ 20,6	
						GIR	0986 <b>475 833</b>	↔ 20,6	
<b>1.6 i</b>	ABO	05.96-05.05	65-66			4LO	BSY	F 026 <b>002 222</b>	← 19
								F 026 <b>002 223</b>	→ 19
	ABS	05.96-11.98	65-66	Org.-Nr. →8056		GIR	0986 <b>475 797</b>	↔ 20,6	
		12.98-05.05	65-66	Org.-Nr. 8057→		GIR	0986 <b>475 833</b>	↔ 20,6	
<b>1.1 i</b>		05.96-05.05	44					0 204 <b>102 075</b>	← 30
								0 204 <b>102 077</b>	→ 30
								0 204 <b>103 077</b>	↔ 30
								0 204 <b>104 068</b> <sup>9</sup>	
<b>1.6 i</b>		05.96-05.05	74-77/					0 204 <b>102 075</b>	← 30
								0 204 <b>103 077</b>	→ 30
<b>1.6 i 16S</b>			87-88					0 204 <b>102 075</b>	← 30
								0 204 <b>104 068</b> <sup>9</sup>	
								0 204 <b>102 077</b>	→ 30
								0 204 <b>103 077</b>	↔ 30
								0 204 <b>104 068</b> <sup>9</sup>	
								0 204 <b>100 098</b> <sup>8</sup>	
<b>1.0 i</b>		05.96-05.05	33/37			TBR		1 987 <b>477 442</b>	1442
<b>1.1 i</b>		05.96-05.05	40-44			TBR		1 987 <b>477 442</b>	1442
<b>1.4, i</b>		05.96-05.05	55			TBR		1 987 <b>477 442</b>	1442
<b>1.5 D</b>		05.96-05.05	40-42			TBR		1 987 <b>477 442</b>	1442
<b>1.6 i</b>		05.96-05.05	65-66			TBR		1 987 <b>477 442</b>	1442
<b>1.0 i</b>		05.96-05.05	33/37			ATE		0 986 <b>594 020</b> <sup>3</sup>	
<b>1.1 i</b>		05.96-05.05	40-44			ATE		0 986 <b>594 020</b> <sup>3</sup>	
<b>1.4, i</b>		05.96-05.05	55			ATE		0 986 <b>594 020</b> <sup>3</sup>	
<b>1.5 D</b>		05.96-05.05	40-42			ATE		0 986 <b>594 020</b> <sup>3</sup>	
<b>1.6 i, i 16S</b>		05.96-05.05	65-66/74-77/87-88			ATE		0 986 <b>594 020</b> <sup>3</sup>	
<b>107 [B0]</b>									
<b>1.0</b>		06.05→	50					0 204 <b>004 330</b>	← 48
								0 204 <b>004 331</b>	→ 48
								0 986 <b>134 093</b>	↔ 48
								0 986 <b>135 093</b>	↔ 48

		S									
	1.4 HDi	06.05→	40						0 204 004 330	← 48	
									0 986 134 093		
									0 204 004 331	→ 48	
									0 986 135 093		
	1.0	06.05→	50						F 026 002 607	↔ 17,46	
	1.4 HDi	06.05→	40						F 026 002 607	↔ 17,46	
	1.0	06.05→	50						1 987 477 951	→ 1478	
									1 987 477 952	← 1487	
	1.4 HDi	06.05→	40						1 987 477 951	→ 1478	
									1 987 477 952	← 1487	
	1.0	06.05-08.10	50						0 265 007 687 <sup>3</sup>		
		09.10-02.12	50	Org.-Nr. →12872					0 265 007 687 <sup>3</sup>		
									0 265 007 688 <sup>4</sup>		
		03.12→	50	Org.-Nr. 12873→					0 265 008 633 <sup>4</sup>		
	1.4 HDi	06.05-02.12	40	Org.-Nr. →12872					0 265 007 687 <sup>3</sup>		
									0 265 007 688 <sup>4</sup>		
		03.12→	40	Org.-Nr. 12873→					0 265 008 633 <sup>4</sup>		
<b>108 [B3]</b>											
	1.0	02.14→	50						0 204 004 330	← 48	
									0 986 134 093		
									0 204 004 331	→ 48	
									0 986 135 093		
	1.2 VTi	02.14→	60						0 204 004 330	← 48	
									0 986 134 093		
									0 204 004 331	→ 48	
									0 986 135 093		
	1.0	02.14→	50						0 265 008 633 <sup>4</sup>		
	1.2 VTi	02.14→	60						0 265 008 633 <sup>4</sup>		
<b>205</b>											
	1.0	10.87-09.98	33-37					GIR	0 986 471 672	← 48	
	1.0i								0 986 473 672		
									0 986 472 672	→ 48	
									0 986 474 672		
								TW	BSY	0 204 102 226	← 48
										0 986 473 100	
										0 204 104 039 <sup>7</sup>	
										0 204 102 227	→ 48
										0 204 100 098 <sup>8</sup>	
										0 986 474 100	
										0 204 102 289	← 48
										0 204 100 098 <sup>8</sup>	
										0 986 473 103	
										0 204 104 039 <sup>7</sup>	
										0 204 102 290	→ 48
										0 204 100 098 <sup>8</sup>	
										0 986 474 103	
		10.90-09.98	33-37					ATE	0 986 473 995	← 44	
									0 986 474 995		
									0 986 473 887	→ 44	
	1.1i	07.89-09.98	44					ATE	0 986 473 887	← 48	
									0 986 473 888		
										→ 48	



		S							
◀ PEUGEOT 205									
1.1 i	07.89-09.98	44	BSY	0 204 102 224	← 48	0 204 100 098 <sup>8</sup>			
				0 204 103 224		0 204 104 039 <sup>7</sup>			
				0 204 102 225	→ 48	0 204 100 098 <sup>8</sup>			
				0 204 103 225					
				GIR	0 986 471 672	← 48			
					0 986 473 672				
					0 986 472 672	→ 48			
					0 986 474 672				
1.4	10.87-12.94	44	GIR	0 986 471 672	← 48				
				0 986 473 672					
				0 986 472 672	→ 48				
				0 986 474 672					
			TW	BSY	0 204 102 226	← 48	0 204 100 098 <sup>8</sup>		
					0 986 473 100		0 204 104 039 <sup>7</sup>		
					0 204 102 227	→ 48	0 204 100 098 <sup>8</sup>		
					0 986 474 100				
					0 204 102 289	← 48	0 204 100 098 <sup>8</sup>		
					0 986 473 103		0 204 104 039 <sup>7</sup>		
					0 204 102 290	→ 48	0 204 100 098 <sup>8</sup>		
					0 986 474 103				
			GIR	ATE	0 986 471 672	← 48			
					0 986 473 672				
					0 986 472 672	→ 48			
					0 986 474 672				
TW	BSY	0 204 102 226	← 48	0 204 100 098 <sup>8</sup>					
		0 986 473 100		0 204 104 039 <sup>7</sup>					
		0 204 102 227	→ 48	0 204 100 098 <sup>8</sup>					
		0 986 474 100							
		0 204 102 289	← 48	0 204 100 098 <sup>8</sup>					
		0 986 473 103		0 204 104 039 <sup>7</sup>					
		0 204 102 290	→ 48	0 204 100 098 <sup>8</sup>					
		0 986 474 103							
ATE	ATE	0 986 473 995	← 44						
		0 986 474 995	→ 44						
		1.4	07.88-09.98	55-58	GIR	0 986 471 672	← 48		
						0 986 473 672			
0 986 472 672	→ 48								
0 986 474 672									
TW	BSY				0 204 102 226	← 48	0 204 100 098 <sup>8</sup>		
					0 986 473 100		0 204 104 039 <sup>7</sup>		
					0 204 102 227	→ 48	0 204 100 098 <sup>8</sup>		
					0 986 474 100				
ATE	ATE	0 986 473 995	← 44						
		0 986 474 995	→ 44						
		1.6	11.90-09.98	53-58/65	ATE	0 986 473 995	← 44		
						0 986 474 995	→ 44		
GIR	0 986 471 672				← 48				
	0 986 473 672								
	0 986 472 672				→ 48				
	0 986 474 672								
TW	BSY				0 204 102 226	← 48	0 204 100 098 <sup>8</sup>		
					0 986 473 100		0 204 104 039 <sup>7</sup>		
		0 204 102 227	→ 48	0 204 100 098 <sup>8</sup>					
		0 986 474 100							
		0 204 102 289	← 48	0 204 100 098 <sup>8</sup>					
		0 986 473 103		0 204 104 039 <sup>7</sup>					
		0 204 102 290	→ 48	0 204 100 098 <sup>8</sup>					
		0 986 474 103							



		S										
1.6i	11.90-09.98	83	ATE	0 986 473 995		44						
				0 986 474 995		44						
			BSY	0 204 102 224		48	0 204 100 098 <sup>B</sup>					
				0 204 103 224		48	0 204 104 039 <sup>7</sup>					
				0 204 102 225		48	0 204 100 098 <sup>B</sup>					
				0 204 103 225		48						
			GIR	0 986 471 672		48						
				0 986 473 672		48						
				0 986 472 672		48						
				0 986 474 672		48						
1.8D	07.87-12.98	44	GIR	0 986 471 672		48						
				0 986 473 672		48						
				0 986 472 672		48						
				0 986 474 672		48						
			TW	BSY	0 204 102 226		48	0 204 100 098 <sup>B</sup>				
					0 986 473 100		48	0 204 104 039 <sup>7</sup>				
					0 204 102 227		48	0 204 100 098 <sup>B</sup>				
					0 986 474 100		48					
					0 204 102 289		48	0 204 100 098 <sup>B</sup>				
					0 986 473 103		48	0 204 104 039 <sup>7</sup>				
					0 204 102 290		48	0 204 100 098 <sup>B</sup>				
					0 986 474 103		48					
					1.8D Turbo	01.90-09.98	58	GIR	0 986 471 672		48	
									0 986 473 672		48	
0 986 472 672		48										
0 986 474 672		48										
TW	BSY	0 204 102 226		48				0 204 100 098 <sup>B</sup>				
		0 986 473 100		48				0 204 104 039 <sup>7</sup>				
		0 204 102 227		48				0 204 100 098 <sup>B</sup>				
		0 986 474 100		48								
		0 204 102 228		48				0 204 100 098 <sup>B</sup>				
		0 986 473 286		48				0 204 104 039 <sup>7</sup>				
		0 204 102 229		48	0 204 100 098 <sup>B</sup>							
		0 986 474 286		48								
		0 204 102 289		48	0 204 100 098 <sup>B</sup>							
		0 986 473 103		48	0 204 104 039 <sup>7</sup>							
0 204 102 290		48	0 204 100 098 <sup>B</sup>									
0 986 474 103		48										
	10.90-09.98	58	ATE	0 986 473 995		44						
				0 986 474 995		44						
			1.9D	10.87-09.98	47	GIR	0 986 471 672		48			
							0 986 473 672		48			
0 986 472 672		48										
0 986 474 672		48										
TW	BSY	0 204 102 226		48	0 204 100 098 <sup>B</sup>							
		0 986 473 100		48	0 204 104 039 <sup>7</sup>							
		0 204 102 227		48	0 204 100 098 <sup>B</sup>							
		0 986 474 100		48								
		0 204 102 289		48	0 204 100 098 <sup>B</sup>							
		0 986 473 103		48	0 204 104 039 <sup>7</sup>							
0 204 102 290		48	0 204 100 098 <sup>B</sup>									
0 986 474 103		48										
	10.90-09.98	47	ATE	0 986 473 995		44						
				0 986 474 995		44						
1.9i	10.87-10.94	75	BSY	0 204 102 224		48	0 204 100 098 <sup>B</sup>					
				0 204 103 224		48	0 204 104 039 <sup>7</sup>					
				0 204 102 225		48	0 204 100 098 <sup>B</sup>					
				0 204 103 225		48						
			GIR	0 986 471 672		48						
				0 986 473 672		48						
				0 986 472 672		48						
0 986 474 672		48										





		S								
◀ PEUGEOT 205										
1.9 i	10.87-09.98	88/90-94	GIR	0986 473 677		↻ ← 48				
				0986 474 677		↻ → 48				
	10.90-10.94	75	ATE	0986 473 995		↻ ← 44				
				0986 474 995		↻ → 44				
	10.90-09.98	88/90-94	ATE	0986 473 995		↻ ← 44				
				0986 474 995		↻ → 44				
<hr/>										
1.0	10.87-09.98	33-37	GIR	F 026 002 520		← 19,05				
				F 026 002 521		→ 19,05				
1.0 i			BKV	BSY	F 026 002 204		← 19			
					F 026 002 205		→ 19			
			<del>BKV</del>	BSY	F 026 002 216		← 20,6			
					F 026 002 217		→ 20,6			
1.1 i	07.89-09.98	44	GIR	F 026 002 520		← 19,05				
				F 026 002 521		→ 19,05				
			BKV	BSY	F 026 002 204		← 19			
					F 026 002 205		→ 19			
1.4	10.87-09.98	44-50/ 55-58	GIR	F 026 002 520		← 19,05				
				F 026 002 521		→ 19,05				
			BKV	BSY	F 026 002 204		← 19			
					F 026 002 205		→ 19			
1.4 i			<del>BKV</del>	BSY	F 026 002 216		← 20,6			
					F 026 002 217		→ 20,6			
			GIR	F 026 002 520		← 19,05				
				F 026 002 521		→ 19,05				
1.6	11.90-09.98	53-58	GIR	F 026 002 520		← 19,05				
				F 026 002 521		→ 19,05				
			BKV	BSY	F 026 002 204		← 19			
					F 026 002 205		→ 19			
1.6 i	11.90-09.98	65	GIR	F 026 002 520		← 19,05				
				F 026 002 521		→ 19,05				
			BKV	BSY	F 026 002 204		← 19			
					F 026 002 205		→ 19			
1.6 i		83	GIR	0986 475 513		↔ 19,05				
				F 026 002 204		← 19				
			BKV	BSY	F 026 002 205		→ 19			
					F 026 002 204		← 19			
1.8 D	07.87-12.98	44	GIR	F 026 002 520		← 19,05				
				F 026 002 521		→ 19,05				
			BKV	BSY	F 026 002 204		← 19			
					F 026 002 205		→ 19			
1.8 D Turbo	01.90-09.98	58	GIR	0986 475 428		↔ 20,6				
				F 026 002 216		← 20,6				
			<del>BKV</del>	BSY	F 026 002 217		→ 20,6			
					F 026 002 520		← 19,05			
1.8 D Turbo			BKV	BSY	F 026 002 204		← 19			
					F 026 002 205		→ 19			
			LWG	GIR	0986 475 428		↔ 20,6			
					ABS 01.90-09.98 58		0986 475 513		↔ 19,05	
1.9 D	10.87-09.98	47	GIR	F 026 002 520		← 19,05				
				F 026 002 521		→ 19,05				
			BKV	BSY	F 026 002 204		← 19			
					F 026 002 205		→ 19			
1.9 i	10.87-10.94	75	GIR	0986 475 428		↔ 20,6				
				F 026 002 216		← 20,6				
			<del>BKV</del>	BSY	F 026 002 217		→ 20,6			
					F 026 002 521		← 19,05			
BKV	BSY	F 026 002 204		← 19						
		F 026 002 205		→ 19						



		S							
	1.9i	10.87-09.98	88/90-94			BSY	0 204 102 075 0 986 134 098 0 204 102 077 0 204 103 077 0 986 135 098	← 30 → 30	0 204 100 098 <sup>B</sup> 0 204 104 068 <sup>9</sup> 0 204 100 098 <sup>B</sup>
	1.0 1.0i 1.1i 1.4 1.4i 1.6 1.6i 1.8D 1.8D Turbo 1.9D 1.9i	10.87-09.98 07.89-09.98 10.87-09.98 11.90-09.98 10.87-09.98 10.87-10.94 10.87-09.98	33-37 44 44-50/ 55-58 53-58/65/ 83 44/58 47 75 88/90-94		TBR TBR TBR TBR TBR SBR TBR SBR		1 987 477 144 1 987 477 145 1 987 477 144 1 987 477 144 1 987 477 145 1 987 477 145 1 987 477 144 1 987 477 145 1 987 477 144 1 987 477 145 1 987 477 272 1 987 477 273 1 987 477 144 1 987 477 145 1 987 477 272 1 987 477 273	← 1372 → 1386 ← 1372 → 1386 ← 1372 → 1386 ← 1372 → 1386 ← 1372 → 1386 → 1432 ← 1417 ← 1372 → 1386 → 1432 ← 1417	
<b>205 Pickup</b>									
	1.8D	05.85-09.98	44			GIR TW BSY ATE	0 986 471 672 0 986 473 672 0 986 472 672 0 986 474 672 0 204 102 226 0 986 473 100 0 204 102 227 0 986 474 100 0 204 102 289 0 986 473 103 0 204 102 290 0 986 474 103 0 986 473 995 0 986 474 995	← 48 → 48 → 48 ← 48 ← 48 → 48 ← 48 → 48 ← 44 → 44	0 204 100 098 <sup>B</sup> 0 204 104 039 <sup>7</sup> 0 204 100 098 <sup>B</sup> 0 204 100 098 <sup>B</sup> 0 204 104 039 <sup>7</sup> 0 204 100 098 <sup>B</sup>
	1.8D	05.85-09.98	44			GIR BKV BSY LWG GIR BKV BSY	F 026 002 520 F 026 002 521 F 026 002 204 F 026 002 205 0 986 475 428 F 026 002 216 F 026 002 217	← 19,05 → 19,05 ← 19 → 19 ↔ 20,6 ← 20,6 → 20,6	
	1.8D	05.85-09.98	44			TBR	1 987 477 144 1 987 477 145	← 1372 → 1386	





◀ PEUGEOT

206



	1.0 i 16V	06.01-12.05	52		INB	0 204 102 989	← 48	0 204 104 269 <sup>7</sup>				
						0 204 103 989						
						0 204 102 990	→ 48	0 204 104 269 <sup>7</sup>				
						0 204 103 990						
	1.4 i	02.04-12.05	55		INB	0 204 102 991	← 48	0 204 104 269 <sup>7</sup>				
						0 204 103 991						
						0 204 102 992	→ 48	0 204 104 269 <sup>7</sup>				
									INB	0 204 102 989	← 48	0 204 104 269 <sup>7</sup>
								0 204 103 989				
								0 204 102 990		→ 48	0 204 104 269 <sup>7</sup>	
						0 204 103 990						
	1.6 i	10.99-10.00	65	Org.-Nr. →8749		0 204 102 759	← 48	0 204 104 215 <sup>7</sup>				
						0 986 473 138						
						0 204 102 760	→ 48	0 204 104 215 <sup>7</sup>				
							0 986 474 138					
					0 204 102 991		← 48	0 204 104 269 <sup>7</sup>				
					0 204 103 991							
		11.00-10.03	65	Org.-Nr. 8750→		0 204 102 992	→ 48	0 204 104 269 <sup>7</sup>				
						0 204 103 992						



	1.0 i 16V	06.01-12.05	52			F 026 002 234	← 20,6							
						F 026 002 235	→ 20,6							
						0 986 AB8 039	→ 20,64							
						0 986 AB8 040	← 20,64							
	1.4 i	02.04-12.05	55			F 026 002 234	← 20,6							
						F 026 002 235	→ 20,6							
						0 204 116 226	▲ ↔ 20,6							
						0 986 AB8 039	→ 20,64							
						0 986 AB8 040	← 20,64							
						ABO 02.04-12.05	55	BKR	F 026 002 175	↔ 19				
						ABS 02.04-12.05	55		0 986 475 833	↔ 20,6				
	1.6 i	10.99-10.03	65			F 026 002 234	← 20,6							
						F 026 002 235	→ 20,6							
								19D	F 026 002 535	← 19,05				
									F 026 002 536	→ 19,05				
									ABO 10.99-10.03	65	BKR	F 026 002 175	↔ 19	
									ABS 10.99-10.03	65		0 986 475 833	↔ 20,6	







































	1.4 i	02.04-12.05	55			1 987 477 586	↔ 1638	
	1.0 i 16V	06.01-09.02	52	Org.-Nr. →9456		0 986 594 022 <sup>3</sup>		
		10.02-12.05	52	Org.-Nr. 9457→		0 986 594 553 <sup>4</sup>		
						0 986 594 558 <sup>3</sup>		
	1.4 i	02.04-12.05	55	Org.-Nr. 9457→		0 986 594 553 <sup>4</sup>		
						0 986 594 558 <sup>3</sup>		
	1.6 i	10.02-10.03	65	Org.-Nr. 9457→		0 986 594 553 <sup>4</sup>		
						0 986 594 558 <sup>3</sup>		

		S							
<b>206 CC [T1]</b>									
	<b>1.6 HDi</b>	06.05-03.07	80				0 204 <b>102 971</b>	← 54	
							0 204 <b>103 971</b>		
							0 204 <b>102 972</b>	→ 54	
							0 204 <b>103 972</b>		
	<b>1.6 i 16V</b>	09.00-11.00	80	Org.-Nr. →8777		BO	0 204 <b>102 763</b>	← 54	
							0 986 <b>473 410</b>		
							0 204 <b>102 764</b>	→ 54	
							0 986 <b>474 410</b>		
		12.00-09.01	80	Org.-Nr. 8778→9078		BO	0 204 <b>102 993</b>	← 54	0 204 <b>104 270</b> <sup>7</sup>
							0 204 <b>103 993</b>		
							0 204 <b>102 994</b>	→ 54	0 204 <b>104 270</b> <sup>7</sup>
							0 204 <b>103 994</b>		
		10.01-03.07	80	Org.-Nr. 9079→		BO	0 204 <b>004 451</b>	← 54	
							0 204 <b>103 971</b>		
							0 204 <b>004 452</b>	→ 54	
	<b>2.0 i S16</b>	09.00-11.00	100	Org.-Nr. →8777			0 204 <b>102 763</b>	← 54	
							0 986 <b>473 410</b>		
							0 204 <b>102 764</b>	→ 54	
							0 986 <b>474 410</b>		
		12.00-10.01	100	Org.-Nr. 8778→9078			0 204 <b>102 993</b>	← 54	0 204 <b>104 270</b> <sup>7</sup>
							0 204 <b>103 993</b>		
							0 204 <b>102 994</b>	→ 54	0 204 <b>104 270</b> <sup>7</sup>
							0 204 <b>103 994</b>		
		11.01-03.07	100	Org.-Nr. 9079→			0 204 <b>102 971</b>	← 54	
							0 204 <b>103 971</b>		
							0 204 <b>102 972</b>	→ 54	
							0 204 <b>103 972</b>		
	<b>1.6 HDi</b>	09.00-03.07	80				0 204 <b>102 075</b>	← 30	0 204 <b>100 098</b> <sup>8</sup>
	<b>1.6 i 16V</b>						0 986 <b>134 098</b>		0 204 <b>104 068</b> <sup>9</sup>
							0 204 <b>102 077</b>	→ 30	0 204 <b>100 098</b> <sup>8</sup>
							0 204 <b>103 077</b>		
							0 986 <b>135 098</b>		
	<b>2.0 i S16</b>	09.00-03.07	100				0 204 <b>102 075</b>	← 30	0 204 <b>100 098</b> <sup>8</sup>
							0 986 <b>134 098</b>		0 204 <b>104 068</b> <sup>9</sup>
							0 204 <b>102 077</b>	→ 30	0 204 <b>100 098</b> <sup>8</sup>
							0 204 <b>103 077</b>		
							0 986 <b>135 098</b>		
	<b>1.6 HDi</b>	06.05-03.07	80				1 987 <b>477 587</b>	↔ 1707	
	<b>1.6 i 16V</b>	09.00-03.07	80			STB	1 987 <b>477 586</b>	↔ 1638	
						4SB	1 987 <b>477 587</b>	↔ 1707	
	<b>2.0 i S16</b>	09.00-03.07	100			4SB	1 987 <b>477 587</b>	↔ 1707	
	<b>1.6 HDi</b>	06.05-03.07	80				0 986 <b>594 558</b> <sup>3</sup>		
							0 986 <b>594 564</b> <sup>4</sup>		
	<b>1.6 i 16V</b>	09.00-09.02	80	Org.-Nr. →9456			0 986 <b>594 022</b> <sup>3</sup>		
		10.02-03.07	80	Org.-Nr. 9457→			0 986 <b>594 558</b> <sup>3</sup>		
						STB	0 986 <b>594 553</b> <sup>4</sup>		
						4SB	0 986 <b>594 564</b> <sup>4</sup>		
	<b>2.0 i S16</b>	09.00-09.02	100	Org.-Nr. →9456			0 986 <b>594 022</b> <sup>3</sup>		
		10.02-03.07	100	Org.-Nr. 9457→			0 986 <b>594 558</b> <sup>3</sup>		
							0 986 <b>594 564</b> <sup>4</sup>		

























		S							
◀ PEUGEOT									
<b>206 Sedan [T1]</b>									
	1.4	02.06-03.09	55	Org.-Nr. 8750→	INB	0 204 102 991	← 48	0 204 104 269 <sup>7</sup>	
						0 204 103 991			
						0 204 102 992	→ 48	0 204 104 269 <sup>7</sup>	
						0 204 103 992			
				Org.-Nr. 8883→	INB	0 204 102 989	← 48	0 204 104 269 <sup>7</sup>	
						0 204 103 989			
						0 204 102 990	→ 48	0 204 104 269 <sup>7</sup>	
						0 204 103 990			
	1.4 HDi 16V	09.08-12.10	50		INB	0 204 102 991	← 48	0 204 104 269 <sup>7</sup>	
						0 204 103 991			
						0 204 102 992	→ 48	0 204 104 269 <sup>7</sup>	
						0 204 103 992			
					INB	0 204 102 989	← 48	0 204 104 269 <sup>7</sup>	
						0 204 103 989			
						0 204 102 990	→ 48	0 204 104 269 <sup>7</sup>	
						0 204 103 990			
	1.6 16V	03.07-12.10	80		BO	0 204 004 451	← 54		
						0 204 103 971			
						0 204 004 452	→ 54		
	1.4	ABO	02.06-03.09	55		F 026 002 234	← 20,6		
						F 026 002 235	→ 20,6		
					BKR	F 026 002 175	↔ 19		
	1.4, HDi 16V	ABS	02.06-12.10	50/55		0 986 475 833	↔ 20,6		
	1.4 HDi 16V	ABO	09.08-12.10	50		F 026 002 175	↔ 19		
	1.6 16V		03.07-12.10	80		0 986 475 833	↔ 20,6		
	1.6 16V	03.07-12.10	80			0 204 102 075	← 30	0 204 100 098 <sup>8</sup>	
						0 986 134 098		0 204 104 068 <sup>9</sup>	
						0 204 102 077	→ 30	0 204 100 098 <sup>8</sup>	
						0 204 103 077			
						0 986 135 098			
	1.4	02.06-03.09	55		STB	1 987 477 586	↔ 1638		
	1.4 HDi 16V	09.08-12.10	50			1 987 477 586	↔ 1638		
	1.6 16V	03.07-12.10	80			1 987 477 586	↔ 1638		
	1.4	02.06-03.09	55	Org.-Nr. 9457→		0 986 594 553 <sup>4</sup>			
						0 986 594 558 <sup>3</sup>			
	1.4 HDi 16V	09.08-12.10	50			0 986 594 553 <sup>4</sup>			
						0 986 594 558 <sup>3</sup>			
	1.6 16V	03.07-12.10	80			0 986 594 558 <sup>3</sup>			
					HTB	0 986 594 553 <sup>4</sup>			
					4SB	0 986 594 564 <sup>4</sup>			
<b>206 SW</b>									
	1.4 i	03.05-12.05	55		INB	0 204 102 989	← 48	0 204 104 269 <sup>7</sup>	
						0 204 103 989			
						0 204 102 990	→ 48	0 204 104 269 <sup>7</sup>	
						0 204 103 990			
	1.6 i 16V	03.04-04.05	79	Org.-Nr. 9079→		0 204 102 971	← 54		
						0 204 103 971			
						0 204 102 972	→ 54		
						0 204 103 972			



		S							
									
	1.4i	03.05-12.05	55				F 026 <b>002 234</b>	← 20,6	
							F 026 <b>002 235</b>	→ 20,6	
							0 986 <b>AB8 039</b>	→ 20,64	
							0 986 <b>AB8 040</b>	← 20,64	
	1.6i 16V	03.04-04.05	79		LUC		0 986 <b>475 833</b>	↔ 20,6	
	1.6i 16V	03.04-04.05	79				0 204 <b>102 075</b>	← 30	0 204 <b>100 098</b> <sup>8</sup>
							0 986 <b>134 098</b>		0 204 <b>104 068</b> <sup>9</sup>
							0 204 <b>102 077</b>	→ 30	0 204 <b>100 098</b> <sup>8</sup>
							0 204 <b>103 077</b>		
							0 986 <b>135 098</b>		
									
	1.4i	03.05-12.05	55	Org.-Nr. 9457→			0 986 <b>594 553</b> <sup>4</sup>		
							0 986 <b>594 558</b> <sup>3</sup>		
	1.6i 16V	03.04-04.05	79	Org.-Nr. 9457→			0 986 <b>594 553</b> <sup>4</sup>		
							0 986 <b>594 558</b> <sup>3</sup>		
<b>206 SW [T1]</b>									
									
	1.1i	03.02-10.05	44		INB		0 204 <b>102 991</b>	← 48	0 204 <b>104 269</b> <sup>7</sup>
							0 204 <b>103 991</b>		
							0 204 <b>102 992</b>	→ 48	0 204 <b>104 269</b> <sup>7</sup>
							0 204 <b>103 992</b>		
					INB		0 204 <b>102 989</b>	← 48	0 204 <b>104 269</b> <sup>7</sup>
							0 204 <b>103 989</b>		
							0 204 <b>102 990</b>	→ 48	0 204 <b>104 269</b> <sup>7</sup>
							0 204 <b>103 990</b>		
	1.4 HDi	03.02-12.06	50				0 204 <b>102 991</b>	← 48	0 204 <b>104 269</b> <sup>7</sup>
							0 204 <b>103 991</b>		
							0 204 <b>102 992</b>	→ 48	0 204 <b>104 269</b> <sup>7</sup>
							0 204 <b>103 992</b>		
	1.4i	03.02-12.06	55		INB		0 204 <b>102 991</b>	← 48	0 204 <b>104 269</b> <sup>7</sup>
							0 204 <b>103 991</b>		
							0 204 <b>102 992</b>	→ 48	0 204 <b>104 269</b> <sup>7</sup>
							0 204 <b>103 992</b>		
					INB		0 204 <b>102 989</b>	← 48	0 204 <b>104 269</b> <sup>7</sup>
							0 204 <b>103 989</b>		
							0 204 <b>102 990</b>	→ 48	0 204 <b>104 269</b> <sup>7</sup>
							0 204 <b>103 990</b>		
	1.4i 16V	10.03-05.06	65				0 204 <b>102 971</b>	← 54	
							0 204 <b>103 971</b>		
							0 204 <b>102 972</b>	→ 54	
							0 204 <b>103 972</b>		
	1.6 HDi	03.02-12.06	80				0 204 <b>102 971</b>	← 54	
	1.6i 16V						0 204 <b>103 971</b>		
							0 204 <b>102 972</b>	→ 54	
							0 204 <b>103 972</b>		
	2.0 HDi	03.02-10.05	66/100				0 204 <b>102 971</b>	← 54	
	2.0i S16						0 204 <b>103 971</b>		
							0 204 <b>102 972</b>	→ 54	
							0 204 <b>103 972</b>		
									
	1.1i	03.02-10.05	44				0 986 <b>475 833</b>	↔ 20,6	
	1.4 HDi, i	03.02-12.06	50/55				0 986 <b>475 833</b>	↔ 20,6	
	2.0 HDi	03.02-10.05	66				0 986 <b>475 833</b>	↔ 20,6	















		S				?							
◀ PEUGEOT 206 SW [T1]													
	1.4 i 16V	10.03-05.06	65				0 204 102 075	← 30	0 204 100 098 <sup>8</sup>				
							0986 134 098		0 204 104 068 <sup>9</sup>				
							0 204 102 077	→ 30	0 204 100 098 <sup>8</sup>				
							0 204 103 077						
<hr/>													
	1.6 HDi 1.6 i 16V	03.02-12.06	80				0 204 102 075	← 30	0 204 100 098 <sup>8</sup>				
							0986 134 098		0 204 104 068 <sup>9</sup>				
							0 204 102 077	→ 30	0 204 100 098 <sup>8</sup>				
							0 204 103 077						
<hr/>													
	2.0 i S16	03.02-10.05	100				0 204 102 075	← 30	0 204 100 098 <sup>8</sup>				
							0986 134 098		0 204 104 068 <sup>9</sup>				
							0 204 102 077	→ 30	0 204 100 098 <sup>8</sup>				
							0 204 103 077						
<hr/>													
	1.1 i 1.4 HDi 1.4 i 1.4 i 16V 1.6 HDi 1.6 i 16V 2.0 HDi 2.0 i S16	03.02-10.05	44 50/55 50/55 65 80 80 66 100						1987 477 586	↔ 1638			
									1987 477 586	↔ 1638			
									1987 477 586	↔ 1638			
									1987 477 587	↔ 1707			
									1987 477 587	↔ 1707			
									1987 477 587	↔ 1707			
									1987 477 586	↔ 1638			
									1987 477 587	↔ 1707			
									1987 477 587	↔ 1707			
<hr/>													
	1.1 i 1.4 HDi 1.4 i 1.4 i 16V 1.6 HDi 1.6 i 16V 2.0 HDi 2.0 i S16	03.02-09.02	44						0986 594 022 <sup>3</sup>				
									10.02-10.05	44	Org.-Nr. 9457→	0986 594 553 <sup>4</sup>	
		<hr/>											
			1.4 HDi	03.02-09.02	50/55						0986 594 022 <sup>3</sup>		
											10.02-12.06	50/55	Org.-Nr. 9457→
		<hr/>											
			1.4 i	10.02-12.06	50/55						0986 594 553 <sup>3</sup>		
		<hr/>											
			1.4 i 16V	10.03-05.06	65						0986 594 558 <sup>3</sup>		
		<hr/>											
			1.6 HDi	05.04-12.06	80						0986 594 558 <sup>3</sup>		
		<hr/>											
			1.6 i 16V	03.02-09.02	80						0986 594 022 <sup>3</sup>		
											10.02-12.06	80	Org.-Nr. 9457→
		<hr/>											
			2.0 HDi	03.02-09.02	66						0986 594 022 <sup>3</sup>		
											10.02-10.05	66	Org.-Nr. 9457→
<hr/>													
	2.0 i S16	03.02-09.02	100						0986 594 022 <sup>3</sup>				
									10.02-10.05	100	Org.-Nr. 9457→	0986 594 558 <sup>3</sup>	
<hr/>													
<b>206 [T1]</b>													
<hr/>													
	1.1 i	06.98-03.01	40/44						0 204 102 609	← 48	0 204 100 377 <sup>8</sup>		
									0 204 103 609		0 204 104 215 <sup>7</sup>		
									0 204 102 610	→ 48	0 204 100 377 <sup>8</sup>		
									0 204 103 610				
									0 204 102 751	← 48			
									0986 473 288				
		<hr/>											
				06.98-10.05	40/44						0 204 102 991	← 48	0 204 104 269 <sup>7</sup>
											0 204 103 991		
											0 204 102 992	→ 48	0 204 104 269 <sup>7</sup>
											0 204 103 992		

		S							
1.1i	04.01-10.05	40/44	Org.-Nr. 8883→	INB,TW	0 204 102 989	← 48	0 204 104 269 <sup>7</sup>		
					0 204 103 989				
					0 204 102 990	→ 48	0 204 104 269 <sup>7</sup>		
					0 204 103 990				
							0 204 104 269 <sup>7</sup>		
1.4	03.00-02.09	55		INB	0 204 102 991	← 48	0 204 104 269 <sup>7</sup>		
					0 204 103 991				
					0 204 102 992	→ 48	0 204 104 269 <sup>7</sup>		
					0 204 103 992				
				INB	0 204 102 989	← 48	0 204 104 269 <sup>7</sup>		
					0 204 103 989				
					0 204 102 990	→ 48	0 204 104 269 <sup>7</sup>		
					0 204 103 990				
1.4 HDi	09.01-02.09	50		INB	0 204 102 991	← 48	0 204 104 269 <sup>7</sup>		
					0 204 103 991				
					0 204 102 992	→ 48	0 204 104 269 <sup>7</sup>		
					0 204 103 992				
				INB	0 204 102 989	← 48	0 204 104 269 <sup>7</sup>		
					0 204 103 989				
					0 204 102 990	→ 48	0 204 104 269 <sup>7</sup>		
					0 204 103 990				
1.4i	06.98-10.00	55	Org.-Nr. →8749	INB	0 204 102 759	← 48	0 204 104 215 <sup>7</sup>		
					0 986 473 138				
					0 204 102 760	→ 48	0 204 104 215 <sup>7</sup>		
					0 986 474 138				
	06.98-03.01	55	Org.-Nr. →8882	INB	0 204 102 609	← 48	0 204 100 377 <sup>8</sup>		
					0 204 103 609		0 204 104 215 <sup>7</sup>		
					0 204 102 610	→ 48	0 204 100 377 <sup>8</sup>		
					0 204 103 610				
	11.00-02.09	55	Org.-Nr. 8750→	INB	0 204 102 991	← 48	0 204 104 269 <sup>7</sup>		
					0 204 103 991				
					0 204 102 992	→ 48	0 204 104 269 <sup>7</sup>		
					0 204 103 992				
	04.01-02.09	55	Org.-Nr. 8883→	INB	0 204 102 989	← 48	0 204 104 269 <sup>7</sup>		
					0 204 103 989				
					0 204 102 990	→ 48	0 204 104 269 <sup>7</sup>		
					0 204 103 990				
1.4i 16V	10.03-05.06	65			0 204 102 971	← 54			
					0 204 103 971				
					0 204 102 972	→ 54			
					0 204 103 972				
1.6 HDi	05.04-03.07	80			0 204 102 971	← 54			
					0 204 103 971				
					0 204 102 972	→ 54			
					0 204 103 972				
1.6i	06.98-10.00	66	Org.-Nr. →8749		0 204 102 759	← 48	0 204 104 215 <sup>7</sup>		
					0 986 473 138				
					0 204 102 760	→ 48	0 204 104 215 <sup>7</sup>		
					0 986 474 138				
	11.00-08.07	66	Org.-Nr. 8750→			0 204 102 991	← 48	0 204 104 269 <sup>7</sup>	
						0 204 103 991			
						0 204 102 992	→ 48	0 204 104 269 <sup>7</sup>	
						0 204 103 992			
1.6i 16V	03.00-11.00	80	Org.-Nr. →8777	BO	0 204 102 763	← 54			
					0 986 473 410				
					0 204 102 764	→ 54			
					0 986 474 410				
	12.00-09.01	80	Org.-Nr. 8778→9078		BO	0 204 102 993	← 54	0 204 104 270 <sup>7</sup>	
						0 204 103 993			
						0 204 102 994	→ 54	0 204 104 270 <sup>7</sup>	
						0 204 103 994			





		S							
	◀ PEUGEOT 206 [T1]								
1.6 i 16V	10.01-08.07	80	Org.-Nr. 9079→		BO	0 204 004 451	← 54		
						0 204 103 971			
						0 204 004 452	→ 54		
1.9 D	06.98-10.00	51/52	Org.-Nr. →8749			0 204 102 759	← 48	0 204 104 215 <sup>7</sup>	
						0 986 473 138			
						0 204 102 760	→ 48	0 204 104 215 <sup>7</sup>	
						0 986 474 138			
	11.00-03.06	51/52	Org.-Nr. 8750→			0 204 102 991	← 48	0 204 104 269 <sup>7</sup>	
						0 204 103 991			
						0 204 102 992	→ 48	0 204 104 269 <sup>7</sup>	
						0 204 103 992			
2.0 HDi	04.99-11.00	66	Org.-Nr. →8777			0 204 102 763	← 54		
						0 986 473 410			
						0 204 102 764	→ 54		
						0 986 474 410			
	12.00-10.01	66	Org.-Nr. 8778→9078			0 204 102 993	← 54	0 204 104 270 <sup>7</sup>	
						0 204 103 993			
						0 204 102 994	→ 54	0 204 104 270 <sup>7</sup>	
						0 204 103 994			
	11.01-10.05	66	Org.-Nr. 9079→			0 204 102 971	← 54		
						0 204 103 971			
						0 204 102 972	→ 54		
						0 204 103 972			
2.0 i S16	01.99-09.00	99				0 204 102 763	← 54		
						0 986 473 410			
						0 204 102 764	→ 54		
						0 986 474 410			
	10.00-11.00	100	Org.-Nr. →8777			0 204 102 763	← 54		
						0 986 473 410			
						0 204 102 764	→ 54		
						0 986 474 410			
	12.00-10.01	100	Org.-Nr. 8778→9078			0 204 102 993	← 54	0 204 104 270 <sup>7</sup>	
						0 204 103 993			
						0 204 102 994	→ 54	0 204 104 270 <sup>7</sup>	
						0 204 103 994			
	11.01-11.04	100	Org.-Nr. 9079→			0 204 102 971	← 54		
						0 204 103 971			
						0 204 102 972	→ 54		
						0 204 103 972			
	1.1 i	ABO	06.98-10.05	40/44			F 026 002 234	← 20,6	
							F 026 002 235	→ 20,6	
					BKR		F 026 002 175	↔ 19	
		ABS	06.98-10.05	40/44			0 986 475 833	↔ 20,6	
	1.4		03.00-02.09	55		TR6	F 026 002 175	↔ 19	
						T06	0 986 475 833	↔ 20,6	
	1.4 HDi	ABO	09.01-02.09	50			F 026 002 175	↔ 19	
		ABS	09.01-02.09	50			0 986 475 833	↔ 20,6	
	1.4 i	ABO	06.98-02.09	55			F 026 002 234	← 20,6	
							F 026 002 235	→ 20,6	
					BKR		F 026 002 175	↔ 19	
		ABS	06.98-02.09	55			0 986 475 833	↔ 20,6	
	1.6 i	ABO	06.98-08.07	66		BKR,GS	F 026 002 175	↔ 19	
						GS	F 026 002 234	← 20,6	
							F 026 002 235	→ 20,6	
		ABS	06.98-08.07	66		AOA	0 986 475 833	↔ 20,6	
	1.6 i 16V		03.00-08.07	80			0 986 475 833	↔ 20,6	
	1.9 D	ABO	06.98-10.01	51			F 026 002 535	← 19,05	
							F 026 002 536	→ 19,05	
					BKR		F 026 002 175	↔ 19	
			02.99-03.06	52			F 026 002 175	↔ 19	

		S							
	<b>1.9 D</b>	ABS	06.98-03.06	51/52			0 986 475 833	↔ 20,6	
	<b>2.0 HDi</b>		04.99-10.05	66			0 986 475 833	↔ 20,6	
	<b>1.4 i 16V</b>		10.03-05.06	65			0 204 102 075 0 986 134 098	← 30 ↻	0 204 100 098 <sup>B</sup> 0 204 104 068 <sup>9</sup>
							0 204 102 077 0 204 103 077 0 986 135 098	→ 30 ↻ ↻	0 204 100 098 <sup>B</sup>
	<b>1.6 HDi</b>		05.04-03.07	80			0 204 102 075 0 986 134 098	← 30 ↻	0 204 104 068 <sup>9</sup>
							0 204 102 077 0 204 103 077 0 986 135 098	→ 30 ↻ ↻	0 204 104 045 <sup>7</sup>
	<b>1.6 HDi</b>		03.00-08.07	80			0 204 102 075 0 986 134 098	← 30 ↻	0 204 100 098 <sup>B</sup> 0 204 104 045 <sup>7</sup>
	<b>1.6 i 16V</b>		06.98-08.07	66			0 204 102 075 0 986 134 098	← 30 ↻	0 204 100 098 <sup>B</sup> 0 204 104 068 <sup>9</sup>
	<b>1.6 i</b>		06.98-08.07	66			0 204 102 077 0 204 103 077 0 986 135 098	→ 30 ↻ ↻	0 204 100 098 <sup>B</sup>
	<b>1.6 i 16V</b>		03.00-08.07	80			0 204 102 075 0 986 134 098	← 30 ↻	0 204 104 068 <sup>9</sup>
							0 204 102 077 0 204 103 077 0 986 135 098	→ 30 ↻ ↻	0 204 100 098 <sup>B</sup>
	<b>2.0 i RC</b>		03.03-08.06	130			0 204 102 277 0 204 103 277 0 986 473 983	← 32 ↻ ↻	0 204 100 098 <sup>B</sup> 0 204 104 068 <sup>9</sup>
							0 204 102 278 0 204 103 278 0 986 474 983	→ 32 ↻ ↻	0 204 100 098 <sup>B</sup>
	<b>2.0 i S16</b>		01.99-11.04	99/100			0 204 102 075 0 986 134 098	← 30 ↻	0 204 100 098 <sup>B</sup> 0 204 104 068 <sup>9</sup>
							0 204 102 077 0 204 103 077 0 986 135 098	→ 30 ↻ ↻	0 204 100 098 <sup>B</sup>
									
	<b>1.1 i</b>		06.98-10.05	40/44		STB	1 987 477 586	↔ 1638	
	<b>1.4</b>		03.00-02.09	55			1 987 477 586	↔ 1638	
	<b>1.4 HDi</b>		09.01-02.09	50		STB	1 987 477 586	↔ 1638	
	<b>1.4 i</b>		06.98-02.09	55		STB	1 987 477 586	↔ 1638	
	<b>1.4 i 16V</b>		10.03-05.06	65			1 987 477 587	↔ 1707	
	<b>1.6 HDi</b>		05.04-03.07	80			1 987 477 587	↔ 1707	
	<b>1.6 i</b>		06.98-08.07	66		STB	1 987 477 586	↔ 1638	
						4SB	1 987 477 587	↔ 1707	
	<b>1.6 i 16V</b>		03.00-08.07	80		STB	1 987 477 586	↔ 1638	
						4SB	1 987 477 587	↔ 1707	
	<b>1.9 D</b>		06.98-03.06	51/52		STB	1 987 477 586	↔ 1638	
	<b>2.0 HDi</b>		04.99-10.05	66		STB	1 987 477 586	↔ 1638	
	<b>2.0 i RC</b>		03.03-08.06	130			1 987 477 587	↔ 1707	
	<b>2.0 i S16</b>		01.99-11.04	99/100		4SB	1 987 477 587	↔ 1707	
	<b>1.1 i</b>		06.98-09.02	40/44		Org.-Nr. →9456	0 986 594 022 <sup>3</sup>		
			10.02-10.05	40/44		Org.-Nr. 9457→	0 986 594 553 <sup>4</sup>		
							0 986 594 558 <sup>3</sup>		
	<b>1.4</b>		06.98-09.02	50/55		Org.-Nr. →9456	0 986 594 022 <sup>3</sup>		
	<b>1.4 HDi</b>		10.02-02.09	50/55		Org.-Nr. 9457→	0 986 594 553 <sup>4</sup>		
	<b>1.4 i</b>						0 986 594 558 <sup>3</sup>		
	<b>1.4 i 16V</b>		10.03-05.06	65			0 986 594 558 <sup>3</sup> 0 986 594 564 <sup>4</sup>		



		S							
<b>PEUGEOT 206 [T1]</b>									
1.6 HDi		05.04-03.07	80				0 986 594 558 <sup>3</sup>		
							0 986 594 564 <sup>4</sup>		
1.6 i		06.98-09.02	66	Org.-Nr. →9456			0 986 594 022 <sup>3</sup>		
		10.02-08.07	66	Org.-Nr. 9457→			0 986 594 558 <sup>3</sup>		
						HTB	0 986 594 553 <sup>4</sup>		
						4SB	0 986 594 564 <sup>4</sup>		
1.6 i 16V		03.00-09.02	80	Org.-Nr. →9456			0 986 594 022 <sup>3</sup>		
		10.02-08.07	80	Org.-Nr. 9457→			0 986 594 558 <sup>3</sup>		
						STB	0 986 594 553 <sup>4</sup>		
						4SB	0 986 594 564 <sup>4</sup>		
1.9 D		06.98-10.01	51				0 986 594 022 <sup>3</sup>		
		02.99-09.02	52	Org.-Nr. →9456			0 986 594 022 <sup>3</sup>		
		10.02-03.06	52	Org.-Nr. 9457→			0 986 594 553 <sup>4</sup>		
							0 986 594 558 <sup>3</sup>		
2.0 HDi		04.99-09.02	66	Org.-Nr. →9456			0 986 594 022 <sup>3</sup>		
		10.02-10.05	66	Org.-Nr. 9457→			0 986 594 553 <sup>4</sup>		
							0 986 594 558 <sup>3</sup>		
2.0 iRC		03.03-08.06	130				0 986 594 558 <sup>3</sup>		
							0 986 594 564 <sup>4</sup>		
2.0 iS16		01.99-09.00	99				0 986 594 022 <sup>3</sup>		
		10.00-09.02	100	Org.-Nr. →9456			0 986 594 022 <sup>3</sup>		
		10.02-11.04	100	Org.-Nr. 9457→			0 986 594 558 <sup>3</sup>		
							0 986 594 564 <sup>4</sup>		

**206+ [T3E]**

1.1		03.09-05.13	44		INB		0 204 102 991	← 48	0 204 104 269 <sup>7</sup>
							0 204 103 991		
							0 204 102 992	→ 48	0 204 104 269 <sup>7</sup>
							0 204 103 992		
							0 204 102 989	← 48	0 204 104 269 <sup>7</sup>
							0 204 103 989		
					INB		0 204 102 990	→ 48	0 204 104 269 <sup>7</sup>
							0 204 103 990		
1.4		03.09-05.13	50/54/55		INB		0 204 102 991	← 48	0 204 104 269 <sup>7</sup>
							0 204 103 991		
							0 204 102 992	→ 48	0 204 104 269 <sup>7</sup>
							0 204 103 992		
							0 204 102 989	← 48	0 204 104 269 <sup>7</sup>
							0 204 103 989		
					INB		0 204 102 990	→ 48	0 204 104 269 <sup>7</sup>
							0 204 103 990		
1.6		02.11-05.13	80				0 204 004 451	← 54	
							0 204 103 971		
							0 204 004 452	→ 54	

1.1		ABO 03.09→	44				F 026 002 234	← 20,6	
							F 026 002 235	→ 20,6	
							F 026 002 175	↔ 19	
							0 986 475 833	↔ 20,6	
							F 026 002 234	← 20,6	
							F 026 002 235	→ 20,6	
1.4		ABO 03.09→	50/54/55				F 026 002 234	← 20,6	
							F 026 002 235	→ 20,6	
							F 026 002 175	↔ 19	
							0 986 475 833	↔ 20,6	
							F 026 002 234	← 20,6	
							F 026 002 235	→ 20,6	
1.4 HDi		ABS 03.09→	50/54/55				F 026 002 175	↔ 19	
							0 986 475 833	↔ 20,6	

		03.09-05.13	44				1 987 477 586	↔ 1638	
							1 987 477 586	↔ 1638	
							1 987 477 586	↔ 1638	
							1 987 477 586	↔ 1638	
1.6		02.11-05.13	80				1 987 477 586	↔ 1638	

		S							
	1.1	03.09→	44				0 986 594 553 <sup>4</sup>		
							0 986 594 558 <sup>3</sup>		
	1.4	03.09→	50/54/55				0 986 594 553 <sup>4</sup>		
	1.4 HDi						0 986 594 558 <sup>3</sup>		
	1.6	02.11→	80				0 986 594 553 <sup>4</sup>		
							0 986 594 558 <sup>3</sup>		
<b>207+</b>									
	1.4	11.12→	50/54				0 204 004 451	← 54	
	1.4 HDi						0 204 103 971		
							0 204 004 452	→ 54	
	1.4	11.12→	50/54				F 026 002 282	↔ 20,64	
	1.4 HDi								
	1.4	11.12→	50/54				1 987 477 235	↔ 1796	
	1.4 HDi	11.12→	50/54				1 987 477 235	↔ 1796	
	1.4	11.12-03.13	54	Org.-Nr. →13264			0 265 008 485 <sup>4</sup>		
	1.4 HDi	11.12→	50				0 265 008 485 <sup>4</sup>		
<b>207 [A7]</b>									
	1.4	06.07-06.09	70				0 204 004 449	← 54	
							0 204 004 450	→ 54	
	1.4	05.06-04.12	50/54/65				0 204 004 451	← 54	
	1.4 HDi						0 204 103 971		
	1.4 16V						0 204 004 452	→ 54	
	1.4 VTi	07.09-04.12	70-72				0 204 004 449	← 54	
							0 204 004 450	→ 54	
							0 204 004 451	← 54	
							0 204 103 971		
							0 204 004 452	→ 54	
	1.6, HDi, i, THP, VTi	05.06-12.11	80-81/82/ 88/110/115				0 204 004 449	← 54	
							0 204 004 450	→ 54	
	1.6 HDi	05.06-04.11	66				0 204 004 449	← 54	
							0 204 004 450	→ 54	
							0 204 004 451	← 54	
							0 204 103 971		
							0 204 004 452	→ 54	
1.6 RC	04.07-02.11	128				0 986 473 451	← 57		
						0 986 474 451	→ 57		
	1.4	07.09-04.12	54				F 026 002 282	↔ 20,64	
		ABS 05.06-06.09	54				F 026 002 282	↔ 20,64	
	1.4	ABO 05.06-04.10	50/54				F 026 002 208	← 20,6	
	1.4 HDi						F 026 002 209	→ 20,6	
	1.4, VTi, 16V	05.06-04.12	65/70-72				F 026 002 282	↔ 20,64	
	1.4 HDi	05.10-12.11	50				F 026 002 282	↔ 20,64	
		ABS 05.06-04.10	50				F 026 002 282	↔ 20,64	
	1.6 HDi	05.06-04.12	66/68				F 026 002 282	↔ 20,64	



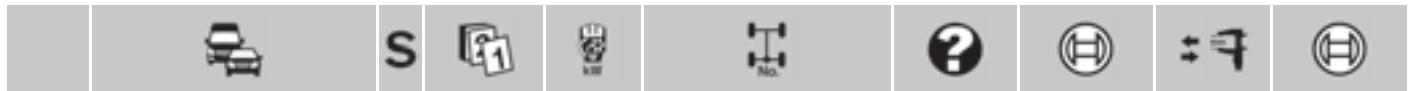

◀ PEUGEOT 207 [A7]

	1.6	03.07-06.09	88		BO	0 204 205 740	← 38
						0 986 134 010	↻
						0 204 205 741	→ 38
						0 986 135 010	↻
					TRW	0 986 473 421	↻ ← 38
						0 986 474 421	↻ → 38
	1.6 HDi	05.06-10.08	66	Org.-Nr. →11630 76, →11627 81, →11634 82		0 204 205 740	← 38
						0 986 134 010	↻
						0 204 205 741	→ 38
						0 986 135 010	↻
		05.06-04.10	80		BO	0 204 205 740	← 38
						0 986 134 010	↻
						0 204 205 741	→ 38
						0 986 135 010	↻
					TRW	0 986 473 421	↻ ← 38
						0 986 474 421	↻ → 38
		11.08-04.11	66	Org.-Nr. 11631 76→, 11628 81→, 11635 82→		0 986 473 421	↻ ← 38
						0 986 474 421	↻ → 38
		04.10-12.11	82			0 986 473 421	↻ ← 38
						0 986 474 421	↻ → 38
	1.6 i	05.06-08.07	80-81			0 204 205 740	← 38
						0 986 134 010	↻
						0 204 205 741	→ 38
						0 986 135 010	↻
	1.6 RC	07.06-12.11	110/115/		BO	0 204 205 740	← 38
	1.6 THP		128			0 986 134 010	↻
						0 204 205 741	→ 38
						0 986 135 010	↻
					TRW	0 986 473 421	↻ ← 38
						0 986 474 421	↻ → 38
	1.6 VTi	07.09-12.11	88			0 986 473 421	↻ ← 38
						0 986 474 421	↻ → 38



	1.4	05.06-04.12	50/54/65/70-72			1 987 477 235	↔ 1796	
	1.4 HDi	05.06-12.11	50/54/65/70-72			1 987 477 235	↔ 1796	
	1.4 VTi	07.09-04.12	50/54/65/70-72			1 987 477 235	↔ 1796	
	1.4 16V	05.06-06.08	50/54/65/70-72			1 987 477 235	↔ 1796	
	1.6	03.07-10.08	88	Org.-Nr. →11630 76, →11627 81, →11634 82		1 987 477 237	↔ 1905	
		11.08-06.09	88	Org.-Nr. 11631 76→, 11628 81→, 11635 82→		1 987 482 323	↔ 1907	
	1.6 HDi	05.06-10.08	66	Org.-Nr. →11630 76, 4SB →11627 81, →11634 82		1 987 477 237	↔ 1905	
				80	Org.-Nr. →11630 76, →11627 81, →11634 82		1 987 477 237	↔ 1905
		05.06-04.11	66	STB		1 987 477 235	↔ 1796	
		11.08-04.10	80	Org.-Nr. 11631 76→, 11628 81→, 11635 82→		1 987 482 323	↔ 1907	
		11.08-04.11	66	Org.-Nr. 11631 76→, 4SB 11628 81→, 11635 82→		1 987 482 323	↔ 1907	
		04.10-12.11	82			1 987 482 323	↔ 1907	
		04.10-04.12	68			1 987 477 235	↔ 1796	
	1.6 i	05.06-08.07	80-81			1 987 477 237	↔ 1905	
	1.6 RC	04.07-10.08	128	Org.-Nr. →11630 76, →11627 81, →11634 82		1 987 477 237	↔ 1905	
			11.08-02.11	128	Org.-Nr. 11631 76→, 11628 81→, 11635 82→		1 987 482 323	↔ 1907
	1.6 THP	07.06-10.08	110	Org.-Nr. →11630 76, →11627 81, →11634 82		1 987 477 237	↔ 1905	
			11.08-04.10	110	Org.-Nr. 11631 76→, 11628 81→, 11635 82→		1 987 482 323	↔ 1907
			04.10-12.11	115			1 987 482 323	↔ 1907
	1.6 VTi	07.09-12.11	88			1 987 482 323	↔ 1907	

	1.4	05.06-06.09	54			0 265 007 707 <sup>4</sup>	
		07.09-07.09	54	Org.-Nr. →11920		0 265 007 707 <sup>4</sup>	
		08.09-04.12	54	Org.-Nr. 11921→		0 265 008 485 <sup>4</sup>	
	1.4, 16V	05.06-06.09	65/70			0 265 007 707 <sup>4</sup>	

		S							
1.4 HDi		05.06-07.09	50		Org.-Nr. →11920		0 265 007 707 <sup>4</sup>		
		08.09-04.10	50		Org.-Nr. 11921→		0 265 008 485 <sup>4</sup>		
		05.10-12.11	50				0 265 008 485 <sup>4</sup>		
1.4 VTi		07.09-07.09	70-72		Org.-Nr. →11920		0 265 007 707 <sup>4</sup>		
		08.09-04.12	70-72		Org.-Nr. 11921→		0 265 008 485 <sup>4</sup>		
1.6		03.07-06.09	88				0 265 007 707 <sup>4</sup>		
1.6 HDi		05.06-07.09	66		Org.-Nr. →11920		0 265 007 707 <sup>4</sup>		
			80		Org.-Nr. →11920		0 265 007 707 <sup>4</sup>		
		08.09-04.10	80		Org.-Nr. 11921→		0 265 008 485 <sup>4</sup>		
		08.09-04.11	66		Org.-Nr. 11921→		0 265 008 485 <sup>4</sup>		
		04.10-12.11	82				0 265 008 485 <sup>4</sup>		
	04.10-04.12	68				0 265 008 485 <sup>4</sup>			
1.6 i		05.06-08.07	80-81				0 265 007 707 <sup>4</sup>		
1.6 RC		04.07-07.09	128		Org.-Nr. →11920		0 265 007 707 <sup>4</sup>		
		08.09-02.11	128		Org.-Nr. 11921→		0 265 008 485 <sup>4</sup>		
1.6 THP		07.06-07.09	110		Org.-Nr. →11920		0 265 007 707 <sup>4</sup>		
		08.09-04.10	110		Org.-Nr. 11921→		0 265 008 485 <sup>4</sup>		
		04.10-12.11	115				0 265 008 485 <sup>4</sup>		
1.6 VTi		07.09-07.09	88		Org.-Nr. →11920		0 265 007 707 <sup>4</sup>		
		08.09-12.11	88		Org.-Nr. 11921→		0 265 008 485 <sup>4</sup>		
<b>207 CC [A7]</b>									
	1.6, HDi, THP, VTi	03.07→	80/82/88/ 110/115				0 204 004 449	← 54	
							0 204 004 450	→ 54	
	1.6	03.07-06.09	88			BO	0 204 205 740	← 38	
							0 986 134 010		
							0 204 205 741	→ 38	
							0 986 135 010		
							TRW 0 986 473 421	← 38	
							0 986 474 421	→ 38	
	1.6 HDi	03.07-02.11	80			BO	0 204 205 740	← 38	
							0 986 134 010		
							0 204 205 741	→ 38	
							0 986 135 010		
							TRW 0 986 473 421	← 38	
							0 986 474 421	→ 38	
1.6 THP	03.07-12.13	110/115			BO	0 204 205 740	← 38		
						0 986 134 010			
						0 204 205 741	→ 38		
						0 986 135 010			
						TRW 0 986 473 421	← 38		
						0 986 474 421	→ 38		
1.6 VTi	07.09-07.13	88				0 986 473 421	← 38		
						0 986 474 421	→ 38		
	1.6	03.07-10.08	88		Org.-Nr. →11630 76, →11627 81, →11634 82		1 987 477 237	↔ 1905	
		11.08-06.09	88		Org.-Nr. 11631 76→, 11628 81→, 11635 82→		1 987 482 323	↔ 1907	
	1.6 HDi	03.07-10.08	80		Org.-Nr. →11630 76, →11627 81, →11634 82		1 987 477 237	↔ 1905	
		11.08-02.11	80		Org.-Nr. 11631 76→, 11628 81→, 11635 82→		1 987 482 323	↔ 1907	
		02.10→	82				1 987 482 323	↔ 1907	
	1.6 THP	03.07-10.08	110		Org.-Nr. →11630 76, →11627 81, →11634 82		1 987 477 237	↔ 1905	
		11.08-09.13	110		Org.-Nr. 11631 76→, 11628 81→, 11635 82→		1 987 482 323	↔ 1907	
		07.10-12.13	115				1 987 482 323	↔ 1907	
	1.6 VTi	07.09-07.13	88				1 987 482 323	↔ 1907	



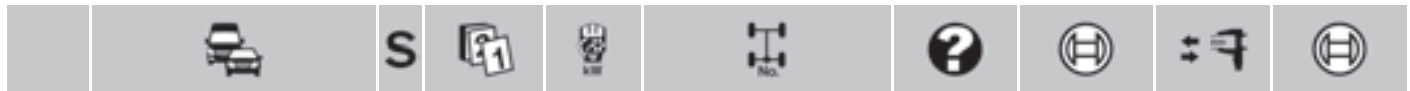

◀ PEUGEOT 207 CC [A7]

	<b>1.6</b>	03.07-06.09	88		0 265 <b>007 707</b> <sup>4</sup>	
	<b>1.6 HDi</b>	03.07-07.09	80	Org.-Nr. →11920	0 265 <b>007 707</b> <sup>4</sup>	
		08.09-02.11	80	Org.-Nr. 11921→	0 265 <b>008 485</b> <sup>4</sup>	
		02.10-03.13	82	Org.-Nr. →13264	0 265 <b>008 485</b> <sup>4</sup>	
	<b>1.6 THP</b>	03.07-07.09	110	Org.-Nr. →11920	0 265 <b>007 707</b> <sup>4</sup>	
		08.09-03.13	110	Org.-Nr. 11921→13264	0 265 <b>008 485</b> <sup>4</sup>	
		07.10-03.13	115	Org.-Nr. →13264	0 265 <b>008 485</b> <sup>4</sup>	
	<b>1.6 VTi</b>	07.09-07.09	88	Org.-Nr. →11920	0 265 <b>007 707</b> <sup>4</sup>	
		08.09-03.13	88	Org.-Nr. 11921→13264	0 265 <b>008 485</b> <sup>4</sup>	

**207 SW [A7]**

	<b>1.4</b>	06.07-12.13	54		0 204 <b>004 451</b>	← 54
					0 204 <b>103 971</b>	
					0 204 <b>004 452</b>	→ 54
	<b>1.4</b>	06.07-12.13	70-72		0 204 <b>004 449</b>	← 54
	<b>1.4 VTi</b>				0 204 <b>004 450</b>	→ 54
	<b>1.6, HDi, VTi</b>	06.07-12.13	66/68/80/ 82/88		0 204 <b>004 449</b>	← 54
					0 204 <b>004 450</b>	→ 54
	<b>1.6 THP RC</b>	11.07-06.09	128		0 986 <b>473 451</b>	← 57
					0 986 <b>474 451</b>	→ 57

	<b>1.4</b>	07.09-12.13	54		F 026 <b>002 282</b>	↔ 20,64
		A BO 06.07-06.09	54		F 026 <b>002 208</b>	← 20,6
					F 026 <b>002 209</b>	→ 20,6
		ABS 06.07-06.09	54		F 026 <b>002 282</b>	↔ 20,64
	<b>1.4, VTi</b>	06.07-12.13	70-72		F 026 <b>002 282</b>	↔ 20,64
	<b>1.6 HDi</b>	04.10-07.13	68		F 026 <b>002 282</b>	↔ 20,64
		A BO 06.07-04.11	66		F 026 <b>002 208</b>	← 20,6
					F 026 <b>002 209</b>	→ 20,6
		ABS 06.07-04.11	66		F 026 <b>002 282</b>	↔ 20,64

	<b>1.6</b>	06.07-06.09	88		BO 0 204 <b>205 740</b>	← 38
					0 986 <b>134 010</b>	
					0 204 <b>205 741</b>	→ 38
					0 986 <b>135 010</b>	
				TRW	0 986 <b>473 421</b>	← 38
					0 986 <b>474 421</b>	→ 38
	<b>1.6 HDi</b>	06.07-10.08	66	Org.-Nr. →11630 76, →11627 81, →11634 82	0 204 <b>205 740</b>	← 38
					0 986 <b>134 010</b>	
					0 204 <b>205 741</b>	→ 38
					0 986 <b>135 010</b>	
		06.07-04.10	80		BO 0 204 <b>205 740</b>	← 38
					0 986 <b>134 010</b>	
					0 204 <b>205 741</b>	→ 38
					0 986 <b>135 010</b>	
				TRW	0 986 <b>473 421</b>	← 38
					0 986 <b>474 421</b>	→ 38
		11.08-04.11	66	Org.-Nr. 11631 76→, 11628 81→, 11635 82→	0 986 <b>473 421</b>	← 38
					0 986 <b>474 421</b>	→ 38
		04.10-07.13	68		0 986 <b>473 421</b>	← 38
					0 986 <b>474 421</b>	→ 38
			82		0 986 <b>473 421</b>	← 38
					0 986 <b>474 421</b>	→ 38
	<b>1.6 THP RC</b>	11.07-06.09	128		BO 0 204 <b>205 740</b>	← 38
					0 986 <b>134 010</b>	
					0 204 <b>205 741</b>	→ 38
					0 986 <b>135 010</b>	
				TRW	0 986 <b>473 421</b>	← 38
					0 986 <b>474 421</b>	→ 38

		S								
1.6 VTi		07.09-12.13	88						0 986 473 421	38
									0 986 474 421	38
	1.4	06.07-12.13	54/70-72						1 987 477 235	1796
	1.4 VTi	07.09-12.13	54/70-72						1 987 477 235	1796
	1.6	06.07-10.08	88	Org.-Nr. →11630 76, →11627 81, →11634 82					1 987 477 237	1905
		11.08-06.09	88	Org.-Nr. 11631 76→, 11628 81→, 11635 82→					1 987 482 323	1907
	1.6 HDi	06.07-10.08	66	Org.-Nr. →11630 76, 4SB					1 987 477 237	1905
			80	→11627 81, →11634 82						
			80	Org.-Nr. →11630 76, →11627 81, →11634 82					1 987 477 237	1905
		06.07-04.11	66	STB					1 987 477 235	1796
		11.08-04.10	80	Org.-Nr. 11631 76→, 11628 81→, 11635 82→					1 987 482 323	1907
		11.08-04.11	66	Org.-Nr. 11631 76→, 4SB					1 987 482 323	1907
			66	11628 81→, 11635 82→						
		04.10-07.13	68	STB					1 987 477 235	1796
				4SB					1 987 482 323	1907
			82						1 987 482 323	1907
	1.6 THP RC	11.07-10.08	128	Org.-Nr. →11630 76, →11627 81, →11634 82					1 987 477 237	1905
		11.08-06.09	128	Org.-Nr. 11631 76→, 11628 81→, 11635 82→					1 987 482 323	1907
	1.6 VTi	07.09-12.13	88						1 987 482 323	1907
	1.4	06.07-06.09	54						0 265 007 707 <sup>4</sup>	
			70						0 265 007 707 <sup>4</sup>	
		07.09-07.09	54	Org.-Nr. →11920					0 265 007 707 <sup>4</sup>	
		08.09-03.13	54	Org.-Nr. 11921→13264					0 265 008 485 <sup>4</sup>	
	1.4 VTi	07.09-07.09	70-72	Org.-Nr. →11920					0 265 007 707 <sup>4</sup>	
		08.09-03.13	70-72	Org.-Nr. 11921→13264					0 265 008 485 <sup>4</sup>	
	1.6	06.07-06.09	88						0 265 007 707 <sup>4</sup>	
	1.6 HDi	06.07-07.09	66	Org.-Nr. →11920					0 265 007 707 <sup>4</sup>	
			80	Org.-Nr. →11920					0 265 007 707 <sup>4</sup>	
		08.09-04.10	80	Org.-Nr. 11921→					0 265 008 485 <sup>4</sup>	
		08.09-04.11	66	Org.-Nr. 11921→					0 265 008 485 <sup>4</sup>	
		04.10-03.13	68	Org.-Nr. →13264					0 265 008 485 <sup>4</sup>	
			82	Org.-Nr. →13264					0 265 008 485 <sup>4</sup>	
	1.6 THP RC	11.07-06.09	128						0 265 007 707 <sup>4</sup>	
	1.6 VTi	07.09-07.09	88	Org.-Nr. →11920					0 265 007 707 <sup>4</sup>	
		08.09-03.13	88	Org.-Nr. 11921→13264					0 265 008 485 <sup>4</sup>	
<b>208</b>										
	1.0 VTi	01.12→	50						0 204 004 451	54
									0 204 103 971	
									0 204 004 452	54
	1.2 THP	01.12→	60/81						0 204 004 451	54
	1.2 VTi								0 204 103 971	
									0 204 004 452	54
	1.4 HDi	01.12→	50/70						0 204 004 451	54
	1.4 VTi								0 204 103 971	
	1.4 VTi LPG								0 204 004 452	54
	1.6 BlueHDi, HDi, HTP, THP, THP GTi, VTi	01.12→	55/68/73/82/ 84/85/88/115/ 121/147/153						0 204 004 451	54
									0 204 103 971	
									0 204 004 452	54
	1.0 VTi	01.12→	50						F 026 002 028	20,6
	1.2 THP, VTi	01.12→	60/81						F 026 002 028	20,6
	1.4 HDi	01.12→	50						F 026 002 028	20,6
	1.6 BlueHDi, HDi, THP, THP GTi	01.12→	55/73/85/88/121/153						F 026 002 028	20,6







◀ PEUGEOT 208

	1.0 VTi	09.14→	50			0 986 473 421		← 38
						0 986 474 421		→ 38
	1.2 THP	01.14→	81			0 986 473 421		← 38
						0 986 474 421		→ 38
	1.4 VTi	01.12→	70			0 986 473 421		← 38
						0 986 474 421		→ 38
	1.4 VTi LPG					0 986 473 421		← 38
	1.6 BlueHdi, HDi, HTP, THP, THP GTi, VTi	01.12→	55/68/73/82/84/85/ 88/115/121/153			0 986 473 421		← 38
						0 986 474 421		→ 38



	1.0 VTi	01.12→	50			1 987 482 495		↔ 1790		
		09.14→	50		STB	1 987 482 495		↔ 1790		
					4SB	1 987 482 323		↔ 1907		
	1.2 THP	01.14→	81		STB	1 987 482 495		↔ 1790		
					4SB	1 987 482 323		↔ 1907		
	1.2 VTi	01.12→	60			1 987 482 495		↔ 1790		
	1.4 HDi	01.12→	50			1 987 482 495		↔ 1790		
	1.4 VTi	01.12→	70			1 987 482 323		↔ 1907		
	1.4 VTi LPG	04.13→	70			1 987 482 323		↔ 1907		
	1.6 BlueHdi	02.15→	73		STB	1 987 482 495		↔ 1790		
					4SB	1 987 482 323		↔ 1907		
		04.15→	55		STB	1 987 482 495		↔ 1790		
					4SB	1 987 482 323		↔ 1907		
1.6 HDi	01.12→	55			STB	1 987 482 495		↔ 1790		
					4SB	1 987 482 323		↔ 1907		
					68			1 987 482 323		↔ 1907
					82/84			1 987 482 323		↔ 1907
		03.14→	85		STB	1 987 482 495		↔ 1790		
					4SB	1 987 482 323		↔ 1907		
					88			1 987 482 495		↔ 1790
					4SB	1 987 482 323		↔ 1907		
	1.6 HTP	01.12→	115			1 987 482 323		↔ 1907		
	1.6 THP	03.15→	121		STB	1 987 482 495		↔ 1790		
					4SB	1 987 482 323		↔ 1907		
	1.6 THP GTi	09.12→	147			1 987 482 323		↔ 1907		
					10.14→	153		STB	1 987 482 495	
							4SB	1 987 482 323		↔ 1907
	1.6 VTi	01.12→	88			1 987 482 323		↔ 1907		

	1.0 VTi	01.12-03.13	50	Org.-Nr. →13264	FPA	0 265 008 485 <sup>4</sup>	
	1.2 VTi	01.12-03.13	60	Org.-Nr. →13264	FPA	0 265 008 485 <sup>4</sup>	
	1.4 HDi, VTi	01.12-03.13	50/70	Org.-Nr. →13264	FPA	0 265 008 485 <sup>4</sup>	
	1.6 HDi, HTP, THP GTi, VTi	01.12-03.13	55/68/82/ 84/88/115/ 147	Org.-Nr. →13264	FPA	0 265 008 485 <sup>4</sup>	

301 [M3]



	1.2 E-VTi	12.14→	60		INB	0 204 004 451		← 54
						0 204 103 971		
						0 204 004 452		→ 54
	1.6 BlueHdi	04.15→	73		INB	0 204 004 451		← 54
						0 204 103 971		
						0 204 004 452		→ 54
	1.6 HDi	09.12→	68			0 204 004 451		← 54
						0 204 103 971		
						0 204 004 452		→ 54
	1.6 VTi	09.12→	85			0 204 004 451		← 54
						0 204 103 971		
						0 204 004 452		→ 54

		S								
	1.2 E-VTi	ABO	09.12→	52/60			F 026	<b>002 234</b>	← 20,6	
	1.2 VTi						F 026	<b>002 235</b>	→ 20,6	
		ABS	09.12→	52/60			F 026	<b>002 028</b>	↔ 20,6	
	1.6 BlueHDi	ABO	09.12→	68/73/85			F 026	<b>002 234</b>	← 20,6	
	1.6 HDi						F 026	<b>002 235</b>	→ 20,6	
1.6 VTi	ABS	09.12→	68/73/85			F 026	<b>002 028</b>	↔ 20,6		
	1.2 VTi		09.12-04.13	52	Org.-Nr. →13292		0 265	<b>008 485<sup>4</sup></b>		
	1.6 HDi		09.12-04.13	68/85	Org.-Nr. →13292		0 265	<b>008 485<sup>4</sup></b>		
	1.6 VTi									
<b>306</b>										
	1.8 i		03.97-03.07	74		INB BO	0 204	<b>102 763</b>	← 54	
							0 986	<b>473 410</b>	↻	
							0 204	<b>102 764</b>	→ 54	
						GIR	0 986	<b>473 026</b>	↻ ← 54	
							0 986	<b>474 026</b>	↻ → 54	
		ABO	03.97-03.07	74		INB ATE	0 986	<b>473 887</b>	↻ ← 48	
							0 986	<b>473 888</b>	↻ → 48	
	1.8 i		05.97-03.07	74		GIM	0 986	<b>475 797</b>	↔ 20,6	
						GIM	0 986	<b>475 635</b>	▲ → 20,6	
							0 986	<b>475 636</b>	▲ ← 20,6	
		ABO	03.97-03.07	74		BSY	F 026	<b>002 234</b>	← 20,6	
		ABS	03.97-03.07	74			F 026	<b>002 235</b>	→ 20,6	
						0 986	<b>475 833</b>	↔ 20,6		
	1.8 i		05.97-03.07	74		LAB	0 265	<b>006 201<sup>3</sup></b>		
						RAB	0 265	<b>006 200<sup>3</sup></b>		
						STB	0 265	<b>006 203<sup>4</sup></b>		
<b>306 Break [N5]</b>										
	1.4		05.97-03.02	55		GIM,INB	0 986	<b>473 026</b>	↻ ← 54	
							0 986	<b>474 026</b>	↻ → 54	
						INB RBA	0 204	<b>102 763</b>	← 54	
							0 986	<b>473 410</b>	↻	
							0 204	<b>102 764</b>	→ 54	
							0 986	<b>474 410</b>	↻	
		ABO	05.97-03.02	55		INB ATE	0 986	<b>473 887</b>	↻ ← 48	
							0 986	<b>473 888</b>	↻ → 48	
	1.6 i		05.97-03.02	65-66/74			GIM,INB	0 986	<b>473 026</b>	↻ ← 54
								0 986	<b>474 026</b>	↻ → 54
						INB RBA	0 204	<b>102 763</b>	← 54	
							0 986	<b>473 410</b>	↻	
							0 204	<b>102 764</b>	→ 54	
							0 986	<b>474 410</b>	↻	
		ABO	05.97-03.02	65-66/74		INB ATE	0 986	<b>473 887</b>	↻ ← 48	
						0 986	<b>473 888</b>	↻ → 48		



		S							
	◀ PEUGEOT 306 Break [N5]								
1.8 i	05.97-03.02	74-76/81				INB BO	0 204 <b>102 763</b>	← 54	
1.8 i 16V							0 986 <b>473 410</b>		
							0 204 <b>102 764</b>	→ 54	
							0 986 <b>474 410</b>		
						GIR	0 986 <b>473 026</b>	← 54	
							0 986 <b>474 026</b>	→ 54	
1.9 D	05.97-03.02	50				GIM,INB	0 986 <b>473 026</b>	← 54	
							0 986 <b>474 026</b>	→ 54	
						INB RBA	0 204 <b>102 763</b>	← 54	
							0 986 <b>473 410</b>		
							0 204 <b>102 764</b>	→ 54	
							0 986 <b>474 410</b>		
		51				GIM,INB	0 986 <b>473 026</b>	← 54	
							0 986 <b>474 026</b>	→ 54	
						INB RBA	0 204 <b>102 763</b>	← 54	
							0 986 <b>473 410</b>		
							0 204 <b>102 764</b>	→ 54	
							0 986 <b>474 410</b>		
		09.98-03.02	51			INB BO	0 204 <b>102 763</b>	← 54	
							0 986 <b>473 410</b>		
							0 204 <b>102 764</b>	→ 54	
							0 986 <b>474 410</b>		
						GIR	0 986 <b>473 026</b>	← 54	
							0 986 <b>474 026</b>	→ 54	
	ABO	05.97-03.02	50/51			INB ATE	0 986 <b>473 887</b>	← 48	
							0 986 <b>473 888</b>	→ 48	
1.9 D	05.97-03.02	52/55/66				INB BO	0 204 <b>102 763</b>	← 54	
1.9 D Turbo							0 986 <b>473 410</b>		
							0 204 <b>102 764</b>	→ 54	
							0 986 <b>474 410</b>		
						GIR	0 986 <b>473 026</b>	← 54	
							0 986 <b>474 026</b>	→ 54	
2.0 HDi	05.97-03.02	66/97-99				INB BO	0 204 <b>102 763</b>	← 54	
2.0 i 16V							0 986 <b>473 410</b>		
							0 204 <b>102 764</b>	→ 54	
							0 986 <b>474 410</b>		
						GIR	0 986 <b>473 026</b>	← 54	
							0 986 <b>474 026</b>	→ 54	
	1.4	ABO	05.97-03.02	55			BO	0 204 <b>116 179</b>	↔ 20,6
	1.4 i	ABS	05.97-03.02	55			BO	F 026 <b>002 471</b>	↔ 22
	1.6 i	ABO	05.97-03.02	65-66/74			BO	0 204 <b>116 179</b>	↔ 20,6
		ABS	05.97-03.02	65-66/74			BO	F 026 <b>002 471</b>	↔ 22
	1.8 i		05.97-03.02	74-76			BO	F 026 <b>002 471</b>	↔ 22
	1.9 D	ABO	05.97-03.02	50/51/52			BO	0 204 <b>116 179</b>	↔ 20,6
		ABS	05.97-03.02	50/51/52			BO	F 026 <b>002 471</b>	↔ 22
	1.9 D Turbo		05.97-03.02	55/66			BO	F 026 <b>002 471</b>	↔ 22
	1.8 i 16V		05.97-03.02	81				0 204 <b>102 277</b>	← 32
								0 204 <b>103 277</b>	
								0 986 <b>473 983</b>	
								0 204 <b>102 278</b>	→ 32
								0 204 <b>103 278</b>	
								0 986 <b>474 983</b>	
	2.0 HDi		05.97-03.02	66/97-99				0 204 <b>102 277</b>	← 32
	2.0 i 16V							0 204 <b>103 277</b>	
								0 986 <b>473 983</b>	
								0 204 <b>102 278</b>	→ 32
								0 204 <b>103 278</b>	
								0 986 <b>474 983</b>	

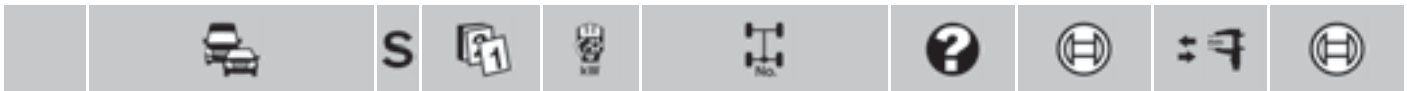

	1.4	05.97-03.02	55			1 987 477 434	← 1692	
	1.4i					1 987 477 435	→ 1604	
	1.6i	05.97-03.02	65-66/74			1 987 477 434	← 1692	
						1 987 477 435	→ 1604	
	1.8i	05.97-03.02	74-76			1 987 477 434	← 1692	
						1 987 477 435	→ 1604	
	1.8i 16V	05.97-03.02	81			1 987 477 431	← 1696	
						1 987 477 432	→ 1614	
	1.9D	05.97-03.02	50/51/52/			1 987 477 434	← 1692	
	1.9D Turbo		55/66			1 987 477 435	→ 1604	
2.0 HDi	05.97-03.02	66/97-99			1 987 477 431	← 1696		
2.0i 16V					1 987 477 432	→ 1614		

	1.4	05.97-03.02	55	LAB	0 265 006 201 <sup>3</sup>		
	1.4i			RAB	0 265 006 200 <sup>3</sup>		
				STB	0 265 006 441 <sup>4</sup>		
	1.6i	05.97-03.02	65-66/74	LAB	0 265 006 201 <sup>3</sup>		
				RAB	0 265 006 200 <sup>3</sup>		
				STB	0 265 006 441 <sup>4</sup>		
	1.8i	05.97-03.02	74-76	LAB	0 265 006 201 <sup>3</sup>		
				RAB	0 265 006 200 <sup>3</sup>		
				STB	0 265 006 441 <sup>4</sup>		
	1.8i 16V	05.97-03.02	81	LAB	0 265 006 201 <sup>3</sup>		
				RAB	0 265 006 200 <sup>3</sup>		
				4SB	0 265 006 202 <sup>4</sup>		
	1.9D	05.97-03.02	50/51/52/	LAB	0 265 006 201 <sup>3</sup>		
	1.9D Turbo		55/66	RAB	0 265 006 200 <sup>3</sup>		
				STB	0 265 006 441 <sup>4</sup>		
	2.0 HDi	05.97-03.02	66/97-99	LAB	0 265 006 201 <sup>3</sup>		
	2.0i 16V			RAB	0 265 006 200 <sup>3</sup>		
				4SB	0 265 006 202 <sup>4</sup>		

**306 Cabriolet [N3]**

	1.6i	01.93-04.97	65-66	INB	0 986 473 887	← 48	
					0 986 473 888	→ 48	
				INB	0 204 102 281	← 48	0 204 104 039 <sup>7</sup>
					0 204 103 281		
					0 204 102 282	→ 48	0 204 104 039 <sup>7</sup>
					0 204 103 282		
	1.8i	01.93-04.97	74-76	INB	0 986 473 887	← 48	
					0 986 473 888	→ 48	
				INB	0 204 102 281	← 48	0 204 104 039 <sup>7</sup>
					0 204 103 281		
				0 204 102 282	→ 48	0 204 104 039 <sup>7</sup>	
				0 204 103 282			

	1.6i	01.93-04.97	65-66	BSY, RBA	0 204 116 179	↔ 20,6	
		10.95-04.97	65-66	GIR, RBA	0 986 475 797	↔ 20,6	
		ABO 01.93-04.97	65-66	GIR	0 986 475 635	▲ → 20,6	
					0 986 475 636	▲ ← 20,6	
		ABS 01.93-09.95	65-66	BSY, GIR	0 986 475 428	↔ 20,6	
	1.8i	01.93-04.97	74-76	BSY, RBA	0 204 116 179	↔ 20,6	





PEUGEOT 306 Cabriolet [N3]

	1.8 i	10.95-04.97	74-76			GIR, RBA	0986 475 797	↔ 20,6	
		01.93-04.97	74-76			GIR	0986 475 635	▲ → 20,6	
		01.93-09.95	74-76			BSY, GIR	0986 475 428	↔ 20,6	

	1.8 i	01.93-04.97	74-76			BSY	0204 102 075	← 30	0204 100 098 <sup>8</sup>
							0986 134 098	↻	0204 104 068 <sup>9</sup>
							0204 102 077	→ 30	0204 100 098 <sup>8</sup>
							0204 103 077	↻	
	2.0 i	08.93-04.97	89-90			BSY	0204 102 075	← 30	0204 100 098 <sup>8</sup>
							0986 134 098	↻	0204 104 068 <sup>9</sup>
							0204 102 077	→ 30	0204 100 098 <sup>8</sup>
							0204 103 077	↻	
							0986 135 098	↻	



	1.6 i	ABO	01.93-04.97	65-66			1987 477 079	← 1585			
							1987 477 323	→ 1493			
		ABS	01.93-09.95	65-66				1987 477 437	← 1621		
								1987 477 438	→ 1531		
				10.95-04.97	65-66				1987 477 079	← 1585	
									1987 477 323	→ 1493	
	1.8 i	ABO	01.93-04.97	74-76				1987 477 079	← 1585		
								1987 477 323	→ 1493		
		ABS	01.93-09.95	74-76					1987 477 437	← 1621	
									1987 477 438	→ 1531	
				10.95-04.97	74-76				1987 477 079	← 1585	
									1987 477 323	→ 1493	

	1.6 i	01.93-09.95	65-66			HTB	BO	0265 006 204 <sup>4</sup>		
								0265 006 201 <sup>3</sup>		
								0265 006 200 <sup>3</sup>		
	1.8 i	01.93-09.95	74-76				HTB	BO	0265 006 204 <sup>4</sup>	
									0265 006 201 <sup>3</sup>	
									0265 006 200 <sup>3</sup>	
	2.0 i	08.93-04.97	89-90						0265 006 202 <sup>4</sup>	
									0265 006 201 <sup>3</sup>	
									0265 006 200 <sup>3</sup>	

306 Cabriolet [N5]



	1.6 i	05.97-10.03	65-66			INB	ATE	0986 473 887	↻ ← 48								
								0986 473 888	↻ → 48								
								BO	0204 102 763	← 54							
									0986 473 410	↻							
									0204 102 764	→ 54							
								GIR	0986 473 026	↻ ← 54							
									0986 474 026	↻ → 54							
									10.00-10.03	74				INB	BO	0204 102 763	← 54
								0986 473 410								↻	
								0204 102 764								→ 54	
								GIR	0986 473 026	↻ ← 54							
									0986 474 026	↻ → 54							
									ABO	10.00-10.03	74				INB	ATE	0986 473 887
								0986 473 888									↻ → 48

		S								
1.8i		05.97-10.03	74-76			INB ATE	0 986 473 887	← 48		
							0 986 473 888	→ 48		
1.8i 16V		05.97-10.03	81			INB BO	0 204 102 763	← 54		
							0 986 473 410			
							0 204 102 764	→ 54		
							0 986 474 410			
						GIR	0 986 473 026	← 54		
							0 986 474 026	→ 54		
2.0i 16V		05.97-10.03	97-99			INB BO	0 204 102 763	← 54		
							0 986 473 410			
							0 204 102 764	→ 54		
							0 986 474 410			
						GIR	0 986 473 026	← 54		
							0 986 474 026	→ 54		
	1.6i	05.97-10.03	65-66/74			GIM	0 986 475 797	↔ 20,6		
						GIM	0 986 475 635	▲ → 20,6		
							0 986 475 636	▲ ← 20,6		
		ABO	05.97-10.03	65-66/74			BSY	F 026 002 234	← 20,6	
								F 026 002 235	→ 20,6	
1.8i		05.97-10.03	74-76			GIM	0 986 475 797	↔ 20,6		
						GIM	0 986 475 635	▲ → 20,6		
							0 986 475 636	▲ ← 20,6		
		ABO	05.97-10.03	74-76			BSY	F 026 002 234	← 20,6	
								F 026 002 235	→ 20,6	
	1.8i 16V	05.97-10.03	81				0 204 102 277	← 32	0 204 100 098 <sup>8</sup>	
							0 204 103 277		0 204 104 068 <sup>9</sup>	
							0 986 473 983			
							0 204 102 278	→ 32	0 204 100 098 <sup>8</sup>	
							0 204 103 278			
							0 986 474 983			
2.0i 16V		05.97-10.03	97-99				0 204 102 277	← 32	0 204 100 098 <sup>8</sup>	
							0 204 103 277		0 204 104 068 <sup>9</sup>	
							0 986 473 983			
							0 204 102 278	→ 32	0 204 100 098 <sup>8</sup>	
							0 204 103 278			
							0 986 474 983			
	1.6i	05.97-10.03	65-66/74				1 987 477 079	← 1585		
							1 987 477 323	→ 1493		
1.8i		05.97-10.03	74-76				1 987 477 079	← 1585		
							1 987 477 323	→ 1493		
1.8i 16V		05.97-10.03	81				1 987 477 323	→ 1493		
2.0i 16V		05.97-10.03	97-99				1 987 477 323	→ 1493		
	1.6i	05.97-10.03	65-66/74			LAB	0 265 006 201 <sup>3</sup>			
						RAB	0 265 006 200 <sup>3</sup>			
						STB	0 265 006 203 <sup>4</sup>			
	1.8i	05.97-10.03	74-76				LAB	0 265 006 201 <sup>3</sup>		
							RAB	0 265 006 200 <sup>3</sup>		
							STB	0 265 006 203 <sup>4</sup>		
	1.8i 16V	05.97-10.03	81				LAB	0 265 006 201 <sup>3</sup>		
							RAB	0 265 006 200 <sup>3</sup>		
							4SB	0 265 006 202 <sup>4</sup>		
	2.0i 16V	05.97-10.03	97-99				LAB	0 265 006 201 <sup>3</sup>		
							RAB	0 265 006 200 <sup>3</sup>		
							4SB	0 265 006 202 <sup>4</sup>		





◀ PEUGEOT

306 [N3]



	1.1 i	01.93-04.97	40/44	INB	0986 473 887	← 48			
					0986 473 888	→ 48			
				INB	0204 102 281	← 48	0204 104 039 <sup>7</sup>		
					0204 103 281				
					0204 102 282	→ 48	0204 104 039 <sup>7</sup>		
					0204 103 282				
	1.4	01.93-04.97	44/55	INB	0986 473 887	← 48			
	1.4 i				0986 473 888	→ 48			
				INB	0204 102 281	← 48	0204 104 039 <sup>7</sup>		
						0204 103 281			
						0204 102 282	→ 48	0204 104 039 <sup>7</sup>	
					0204 103 282				
	1.6 i	01.93-04.97	65-66	INB	0986 473 887	← 48			
							0986 473 888	→ 48	
						INB	0204 102 281	← 48	0204 104 039 <sup>7</sup>
								0204 103 281	
				0204 102 282	→ 48		0204 104 039 <sup>7</sup>		
				0204 103 282					
	1.8 D	01.93-04.97	44/74-76	INB	0986 473 887	← 48			
							0986 473 888	→ 48	
	1.8 i			INB	0204 102 281	← 48	0204 104 039 <sup>7</sup>		
						0204 103 281			
						0204 102 282	→ 48	0204 104 039 <sup>7</sup>	
						0204 103 282			
	1.9 D	05.93-04.97	47-48/50/ 51/66-67/ 68	INB	0986 473 887	← 48			
							0986 473 888	→ 48	
	1.9 D Turbo			INB	0204 102 281	← 48	0204 104 039 <sup>7</sup>		
						0204 103 281			
						0204 102 282	→ 48	0204 104 039 <sup>7</sup>	
						0204 103 282			
	2.0 i 16V	07.96-04.97	120		0986 473 505	← 57			
							0986 474 505	→ 57	











	1.1 i	01.93-04.97	40	BSY, RBA	0204 116 179	↔ 20,6	
			44	BSY, RBA	0204 116 179	↔ 20,6	
		10.95-04.97	40	GIR, RBA	0986 475 797	↔ 20,6	
						GIR, RBA	0986 475 797
		ABO	01.93-12.95	40	LWG	BSY	0204 116 179 ↔ 20,6
						GIR	0986 475 635 ▲ → 20,6
			01.93-04.97	40		0986 475 636 ▲ ← 20,6	
						LWG	BSY
						F 026 002 235 → 20,6	
			44	GIR	0986 475 635 ▲ → 20,6		
						0986 475 636 ▲ ← 20,6	
				LWG	BSY	0204 116 179 ↔ 20,6	
				LWG	BSY	F 026 002 234 ← 20,6	
						F 026 002 235 → 20,6	
		ABS	01.93-09.95	40/44	BSY, GIR	0986 475 428	↔ 20,6
	1.4	01.93-04.97	44	BSY, RBA	0204 116 179	↔ 20,6	
							BSY, RBA

		S								
1.4		10.95-04.97	44			GIR, RBA	0 986 475 797	↔	20,6	
	ABO	01.93-05.96	55		LWG	BSY	0 204 116 179	↔	20,6	
		01.93-04.97	44			GIR	0 986 475 635	▲ →	20,6	
							0 986 475 636	▲ ←	20,6	
					LWG	BSY	F 026 002 234	←	20,6	
							F 026 002 235	→	20,6	
1.4 1.4i		10.95-04.97	55			GIR, RBA	0 986 475 797	↔	20,6	
	ABO	01.93-04.97	55			GIR	0 986 475 635	▲ →	20,6	
							0 986 475 636	▲ ←	20,6	
					LWG	BSY	F 026 002 234	←	20,6	
								F 026 002 235	→	20,6
	ABS	01.93-09.95	44/55			BSY, GIR	0 986 475 428	↔	20,6	
1.4i		01.93-04.97	55			BSY, RBA	0 204 116 179	↔	20,6	
	ABO	01.93-04.97	55		LWG	BSY	0 204 116 179	↔	20,6	
1.6i		01.93-04.97	65-66			BSY, RBA	0 204 116 179	↔	20,6	
		10.95-04.97	65-66			GIR, RBA	0 986 475 797	↔	20,6	
	ABO	01.93-04.97	65-66			GIR	0 986 475 635	▲ →	20,6	
							0 986 475 636	▲ ←	20,6	
					LWG	BSY	F 026 002 234	←	20,6	
							F 026 002 235	→	20,6	
	ABS	01.93-09.95	65-66			BSY, GIR	0 986 475 428	↔	20,6	
1.8D		05.93-04.97	44			BSY, RBA	0 204 116 179	↔	20,6	
		10.95-04.97	44			GIR, RBA	0 986 475 797	↔	20,6	
	ABO	05.93-04.97	44			GIR	0 986 475 635	▲ →	20,6	
							0 986 475 636	▲ ←	20,6	
					LWG	BSY	0 204 116 179	↔	20,6	
				LWG	BSY	F 026 002 234	←	20,6		
							F 026 002 235	→	20,6	
1.8D	ABS	01.93-09.95	44/74-76			BSY, GIR	0 986 475 428	↔	20,6	
1.8i		01.93-04.97	74-76			BSY, RBA	0 204 116 179	↔	20,6	
		10.95-04.97	74-76			GIR, RBA	0 986 475 797	↔	20,6	
1.8i	ABO	01.93-04.97	74-76			GIR	0 986 475 635	▲ →	20,6	
							0 986 475 636	▲ ←	20,6	
					LWG	BSY	F 026 002 234	←	20,6	
								F 026 002 235	→	20,6
								0 204 116 179	↔	20,6
1.9D		05.93-04.97	47-48			BSY, RBA	0 204 116 179	↔	20,6	
			51			BSY, RBA	0 204 116 179	↔	20,6	
		07.94-04.97	50			BSY, RBA	0 204 116 179	↔	20,6	
		10.95-04.97	50			GIR, RBA	0 986 475 797	↔	20,6	
			51			GIR, RBA	0 986 475 797	↔	20,6	
	ABO	05.93-04.97	47-48/50			GIR	0 986 475 635	▲ →	20,6	
							0 986 475 636	▲ ←	20,6	
					LWG	BSY	F 026 002 234	←	20,6	
								F 026 002 235	→	20,6
				51			GIR	0 986 475 635	▲ →	20,6
							0 986 475 636	▲ ←	20,6	





		S													
◀ PEUGEOT 306 [N3]															
1.9 D	ABO	05.93-04.97	51				LWG	BSY	0 204 116 179	↔ 20,6					
							LWG	BSY	F 026 002 234	← 20,6					
1.9 D Turbo	ABO	05.93-04.97	66-67/68					BSY, RBA	0 204 116 179	↔ 20,6					
								GIR, RBA	0 986 475 797	↔ 20,6					
		05.93-04.97	66-67/68						GIR	0 986 475 635	▲ → 20,6				
										0 986 475 636	▲ ← 20,6				
								LWG	BSY	F 026 002 234	← 20,6				
								F 026 002 235	→ 20,6						
1.9 D	ABS	05.93-09.95	47-48/50/51/					BSY, GIR	0 986 475 428	↔ 20,6					
1.9 D Turbo			66-67/68												
	1.8 i	01.93-04.97	74-76					BSY	0 204 102 075	← 30	0 204 100 098 <sup>8</sup>				
									0 986 134 098		0 204 104 068 <sup>9</sup>				
									0 204 102 077	→ 30	0 204 100 098 <sup>8</sup>				
									0 204 103 077						
	1.9 D Turbo	ABO	05.93-04.97	66-67/68					BSY	0 204 102 075	← 30	0 204 100 098 <sup>8</sup>			
										0 986 134 098		0 204 104 068 <sup>9</sup>			
										0 204 102 077	→ 30	0 204 100 098 <sup>8</sup>			
										0 204 103 077					
									0 986 135 098						
	2.0 i	ABO	08.93-04.97	89-90/					BSY	0 204 102 075	← 30	0 204 100 098 <sup>8</sup>			
									0 986 134 098		0 204 104 068 <sup>9</sup>				
									0 204 102 077	→ 30	0 204 100 098 <sup>8</sup>				
									0 204 103 077						
								0 986 135 098							
2.0 i 16V	ABS	07.96-04.97	120					BSY	0 204 102 277	← 32	0 204 100 098 <sup>8</sup>				
									0 204 103 277		0 204 104 068 <sup>9</sup>				
									0 986 473 983						
									0 204 102 278	→ 32	0 204 100 098 <sup>8</sup>				
									0 204 103 278						
															0 986 474 983
	1.1 i	01.93-12.95	40				LWG,STB		1 987 477 434	← 1692					
									1 987 477 435	→ 1604					
		01.93-04.97	44					LWG,STB		1 987 477 434	← 1692				
										1 987 477 435	→ 1604				
		ABO	01.93-04.97	40					STB	1 987 477 429	← 1656				
										1 987 477 430	→ 1561				
										44	STB	1 987 477 429	← 1656		
										44		1 987 477 430	→ 1561		
		ABS	01.93-09.95	40					STB	1 987 477 434	← 1692				
										1 987 477 435	→ 1604				
										44	STB	1 987 477 434	← 1692		
										44		1 987 477 435	→ 1604		
			10.95-04.97	40					STB	1 987 477 429	← 1656				
										1 987 477 430	→ 1561				
										44	STB	1 987 477 429	← 1656		
										44		1 987 477 430	→ 1561		
		1.4	ABO	01.93-05.96	55					LWG,STB	1 987 477 434	← 1692			
											1 987 477 435	→ 1604			
											44	STB	1 987 477 429	← 1656	
											44		1 987 477 430	→ 1561	
	01.93-04.97		44					STB	1 987 477 429	← 1656					
									1 987 477 430	→ 1561					
									55	STB	1 987 477 429	← 1656			
									55		1 987 477 430	→ 1561			
	ABS	01.93-09.95	44				STB	1 987 477 434	← 1692						
								1 987 477 435	→ 1604						

		S							
<b>1.4</b>	ABS	01.93-09.95	55			STB	1 987 477 434	← 1692	
							1 987 477 435	→ 1604	
		10.95-04.97	44			STB	1 987 477 429	← 1656	
				55		STB	1 987 477 429	← 1656	
							1 987 477 430	→ 1561	
<b>1.4i</b>		01.93-04.97	55			LWG,STB	1 987 477 434	← 1692	
							1 987 477 435	→ 1604	
	ABO	01.93-04.97	55			STB	1 987 477 429	← 1656	
							1 987 477 430	→ 1561	
	ABS	01.93-09.95	55			STB	1 987 477 434	← 1692	
							1 987 477 435	→ 1604	
		10.95-04.97	55			STB	1 987 477 429	← 1656	
							1 987 477 430	→ 1561	
<b>1.6i</b>	ABO	01.93-04.97	65-66			STB	1 987 477 429	← 1656	
							1 987 477 430	→ 1561	
	ABS	01.93-09.95	65-66			STB	1 987 477 434	← 1692	
							1 987 477 435	→ 1604	
		10.95-04.97	65-66			STB	1 987 477 429	← 1656	
							1 987 477 430	→ 1561	
<b>1.8D</b>		05.93-04.97	44			LWG,STB	1 987 477 434	← 1692	
							1 987 477 435	→ 1604	
	ABO	05.93-04.97	44			STB	1 987 477 429	← 1656	
							1 987 477 430	→ 1561	
	ABS	05.93-09.95	44			STB	1 987 477 434	← 1692	
							1 987 477 435	→ 1604	
		10.95-04.97	44			STB	1 987 477 429	← 1656	
							1 987 477 430	→ 1561	
<b>1.8i</b>		01.93-04.97	74-76			4SB	1 987 477 431	← 1696	
							1 987 477 432	→ 1614	
<b>1.9D</b>		05.93-04.97	51			LWG,STB	1 987 477 434	← 1692	
							1 987 477 435	→ 1604	
	ABO	05.93-04.97	47-48			STB	1 987 477 429	← 1656	
				51		STB	1 987 477 429	← 1656	
							1 987 477 430	→ 1561	
			07.94-04.97	50		STB	1 987 477 429	← 1656	
							1 987 477 430	→ 1561	
	ABS	05.93-09.95	47-48			STB	1 987 477 434	← 1692	
				51		STB	1 987 477 434	← 1692	
							1 987 477 435	→ 1604	
			07.94-09.95	50		STB	1 987 477 434	← 1692	
							1 987 477 435	→ 1604	
			10.95-04.97	50		STB	1 987 477 429	← 1656	
						1 987 477 430	→ 1561		
			51		STB	1 987 477 429	← 1656		
						1 987 477 430	→ 1561		
<b>1.9D Turbo</b>		05.93-04.97	66-67/68			4SB	1 987 477 431	← 1696	
							1 987 477 432	→ 1614	
	ABO	05.93-04.97	66-67			STB	1 987 477 429	← 1656	
				68		STB	1 987 477 429	← 1656	
							1 987 477 430	→ 1561	
	ABS	05.93-09.95	66-67			STB	1 987 477 434	← 1692	
				68		STB	1 987 477 434	← 1692	
							1 987 477 435	→ 1604	
			10.95-04.97	66-67		STB	1 987 477 429	← 1656	
							1 987 477 430	→ 1561	
			68		STB	1 987 477 429	← 1656		
						1 987 477 430	→ 1561		





PEUGEOT 306 [N3]									
2.0 i	08.93-04.97	89-90/110-114/	4SB			1987 477 431	← 1696		
2.0 i 16V		120				1987 477 432	→ 1614		
1.1 i	01.93-09.95	40/44	HTB	BO		0 265 006 204 <sup>4</sup>			
	01.93-04.97	40/44	LAB	BO		0 265 006 201 <sup>3</sup>			
			RAB	BO		0 265 006 200 <sup>3</sup>			
1.4	10.95-04.97	40/44	LWG	BO		0 265 006 204 <sup>4</sup>			
			<del>LWG</del>	BO		0 265 006 203 <sup>4</sup>			
	01.93-09.95	44	HTB	BO		0 265 006 204 <sup>4</sup>			
1.4	01.93-04.97	44	LAB	BO		0 265 006 201 <sup>3</sup>			
			RAB	BO		0 265 006 200 <sup>3</sup>			
	10.95-04.97	44	<del>LWG</del>	BO		0 265 006 203 <sup>4</sup>			
1.4 i	01.93-09.95	55	HTB	BO		0 265 006 204 <sup>4</sup>			
	01.93-04.97	55	LAB	BO		0 265 006 201 <sup>3</sup>			
			RAB	BO		0 265 006 200 <sup>3</sup>			
1.6 i	10.95-04.97	55	LWG	BO		0 265 006 204 <sup>4</sup>			
			<del>LWG</del>	BO		0 265 006 203 <sup>4</sup>			
	01.93-09.95	65-66	HTB	BO		0 265 006 204 <sup>4</sup>			
1.8 D	01.93-04.97	65-66	LAB	BO		0 265 006 201 <sup>3</sup>			
			RAB	BO		0 265 006 200 <sup>3</sup>			
	10.95-04.97	65-66	<del>LWG</del>	BO		0 265 006 203 <sup>4</sup>			
1.8 i	05.93-09.95	44	HTB	BO		0 265 006 204 <sup>4</sup>			
	05.93-04.97	44	LAB	BO		0 265 006 201 <sup>3</sup>			
			RAB	BO		0 265 006 200 <sup>3</sup>			
1.9 D	10.95-04.97	44	LWG	BO		0 265 006 204 <sup>4</sup>			
			<del>LWG</del>	BO		0 265 006 203 <sup>4</sup>			
	01.93-09.95	74-76	HTB	BO		0 265 006 204 <sup>4</sup>			
1.9 D Turbo	01.93-04.97	74-76	LAB	BO		0 265 006 201 <sup>3</sup>			
			RAB	BO		0 265 006 200 <sup>3</sup>			
	10.95-04.97	74-76	<del>LWG</del>	BO		0 265 006 203 <sup>4</sup>			
2.0 i	05.93-09.95	47-48	HTB	BO		0 265 006 204 <sup>4</sup>			
	05.93-04.97	47-48	LAB	BO		0 265 006 201 <sup>3</sup>			
			RAB	BO		0 265 006 200 <sup>3</sup>			
2.0 i 16V	50/51		LAB	BO		0 265 006 201 <sup>3</sup>			
			RAB	BO		0 265 006 200 <sup>3</sup>			
	10.95-04.97	50/51	LWG	BO		0 265 006 204 <sup>4</sup>			
2.0 i	05.93-09.95	66-67/68	HTB	BO		0 265 006 204 <sup>4</sup>			
	05.93-04.97	66-67/68	LAB	BO		0 265 006 201 <sup>3</sup>			
			RAB	BO		0 265 006 200 <sup>3</sup>			
2.0 i 16V	10.95-04.97	66-67/68	<del>LWG</del>	BO		0 265 006 203 <sup>4</sup>			
	08.93-04.97	89-90/				0 265 006 202 <sup>4</sup>			
		110-114/	LAB	BO		0 265 006 201 <sup>3</sup>			
		120	RAB	BO		0 265 006 200 <sup>3</sup>			













**306 [N5]**

1.4	05.97-10.03	55	INB	ATE		0 986 473 888	→ 48		
	ABO	05.97-10.03	55	<del>INB</del>	BSY	0 204 102 609	← 48	0 204 104 215 <sup>7</sup>	
						0 204 103 609			
1.4 i	05.97-10.03	55	INB	ATE		0 986 473 887	← 48		
	ABO	05.97-10.03	55	<del>INB</del>	BSY	0 204 102 609	← 48	0 204 100 377 <sup>8</sup>	
						0 204 103 609			
1.4 i						0 204 102 610	→ 48	0 204 104 215 <sup>7</sup>	
						0 204 103 610			
1.4 i	05.97-10.03	55	INB	ATE		0 986 473 888	→ 48		
				BO		0 204 102 763	← 54		
						0 986 473 410			
						0 204 102 764	→ 54		
						0 986 474 410			

		S									
1.4i		05.97-10.03	55		INB	GIR	0 986 473 026		← 54		
							0 986 474 026		→ 54		
	ABO	05.97-10.03	55		<del>INB</del>	BSY	0 204 102 610		→ 48	0 204 100 377 <sup>B</sup>	
							0 204 103 610				
1.6i		05.97-10.03	65-66		INB	ATE	0 986 473 887		← 48		
							0 986 473 888		→ 48		
						BO	0 204 102 763		← 54		
							0 986 473 410				
							0 204 102 764		→ 54		
							0 986 474 410				
						GIR	0 986 473 026		← 54		
							0 986 474 026		→ 54		
			10.00-10.03	74		INB	BO	0 204 102 763		← 54	
								0 986 473 410			
							0 204 102 764		→ 54		
							0 986 474 410				
					GIR	0 986 473 026		← 54			
							0 986 474 026		→ 54		
	ABO	10.00-10.03	74		INB	ATE	0 986 473 887		← 48		
							0 986 473 888		→ 48		
1.8D		05.97-10.03	44		INB	ATE	0 986 473 887		← 48		
							0 986 473 888		→ 48		
1.8i		05.97-10.03	74-76		INB	ATE	0 986 473 887		← 48		
							0 986 473 888		→ 48		
						BO	0 204 102 763		← 54		
							0 986 473 410				
						0 204 102 764		→ 54			
						0 986 474 410					
					GIR	0 986 473 026		← 54			
						0 986 474 026		→ 54			
1.8i16V		05.97-10.03	81		INB	BO	0 204 102 763		← 54		
							0 986 473 410				
							0 204 102 764		→ 54		
							0 986 474 410				
					GIR	0 986 473 026		← 54			
							0 986 474 026		→ 54		
1.9D		05.97-10.03	50		INB	ATE	0 986 473 887		← 48		
							0 986 473 888		→ 48		
			51		INB	ATE	0 986 473 887		← 48		
							0 986 473 888		→ 48		
			09.98-10.03	51		INB	BO	0 204 102 763		← 54	
							0 986 473 410				
							0 204 102 764		→ 54		
							0 986 474 410				
						GIR	0 986 473 026		← 54		
							0 986 474 026		→ 54		
		09.99-10.03	52		INB	BO	0 204 102 763		← 54		
							0 986 473 410				
							0 204 102 764		→ 54		
							0 986 474 410				
					GIR	0 986 473 026		← 54			
							0 986 474 026		→ 54		
1.9D Turbo		05.97-10.03	55/66		INB	ATE	0 986 473 887		← 48		
							0 986 473 888		→ 48		
2.0 HDi		05.97-10.03	66/97-99		INB	BO	0 204 102 763		← 54		
							0 986 473 410				
							0 204 102 764		→ 54		
2.0i16V						0 986 474 410					
					GIR	0 986 473 026		← 54			
							0 986 474 026		→ 54		
2.0i16V		05.97-10.03	120		INB	GIR	0 986 473 505		← 57		
							0 986 474 505		→ 57		



			S								
◀ PEUGEOT 306 [N5]											
	1.4	05.97-10.03	55		GIM	0986	<b>475 797</b>		↔	20,6	
	1.4 i				GIM	0986	<b>475 635</b>	▲	→	20,6	
							0986	<b>475 636</b>	▲	←	20,6
		ABO	05.97-10.03	55		BSY	F 026	<b>002 234</b>	←	20,6	
							F 026	<b>002 235</b>	→	20,6	
	1.4 i	05.97-10.03	55		LWG	0204	<b>116 179</b>		↔	20,6	
	1.6 i	05.97-10.03	65-66/74		GIM	0986	<b>475 797</b>		↔	20,6	
					GIM	0986	<b>475 635</b>	▲	→	20,6	
							0986	<b>475 636</b>	▲	←	20,6
		ABO	05.97-10.03	65-66/74		BSY	F 026	<b>002 234</b>	←	20,6	
							F 026	<b>002 235</b>	→	20,6	
	1.8 D	05.97-10.03	44		GIM	0986	<b>475 797</b>		↔	20,6	
					GIM	0986	<b>475 635</b>	▲	→	20,6	
							0986	<b>475 636</b>	▲	←	20,6
					LWG	0204	<b>116 179</b>		↔	20,6	
	1.8 D	ABO	05.97-10.03	44/74-76		BSY	F 026	<b>002 234</b>	←	20,6	
	1.8 i						F 026	<b>002 235</b>	→	20,6	
	1.8 i	05.97-10.03	74-76		GIM	0986	<b>475 797</b>		↔	20,6	
					GIM	0986	<b>475 635</b>	▲	→	20,6	
							0986	<b>475 636</b>	▲	←	20,6
	1.9 D	05.97-10.03	50/51/52		GIM	0986	<b>475 797</b>		↔	20,6	
					GIM	0986	<b>475 635</b>	▲	→	20,6	
							0986	<b>475 636</b>	▲	←	20,6
					LWG	0204	<b>116 179</b>		↔	20,6	
		ABO	05.97-10.03	50/51/52		BSY	F 026	<b>002 234</b>	←	20,6	
							F 026	<b>002 235</b>	→	20,6	
	1.9 D Turbo	05.97-10.03	55/66		GIR	0986	<b>475 797</b>		↔	20,6	
	1.8 i 16V	05.97-10.03	81			0204	<b>102 277</b>	←	32	0204 <b>100 098</b> <sup>8</sup>	
						0204	<b>103 277</b>			0204 <b>104 068</b> <sup>9</sup>	
						0986	<b>473 983</b>				
						0204	<b>102 278</b>	→	32	0204 <b>100 098</b> <sup>8</sup>	
						0204	<b>103 278</b>				
						0986	<b>474 983</b>				
	2.0 HDi	05.97-10.03	66/97-99/			0204	<b>102 277</b>	←	32	0204 <b>100 098</b> <sup>8</sup>	
	2.0 i 16V		120			0204	<b>103 277</b>			0204 <b>104 068</b> <sup>9</sup>	
							0986	<b>473 983</b>			
						0204	<b>102 278</b>	→	32	0204 <b>100 098</b> <sup>8</sup>	
						0204	<b>103 278</b>				
						0986	<b>474 983</b>				
	1.4	05.97-10.03	55			1987	<b>477 429</b>	←	1656		
						1987	<b>477 430</b>	→	1561		
	1.4 i	05.97-10.03	55		LIM	1987	<b>477 429</b>	←	1656		
						1987	<b>477 430</b>	→	1561		
					LWG	1987	<b>477 434</b>	←	1692		
						1987	<b>477 435</b>	→	1604		
	1.6 i	05.97-10.03	65-66/74			1987	<b>477 429</b>	←	1656		
						1987	<b>477 430</b>	→	1561		
	1.8 D	05.97-10.03	44		LIM	1987	<b>477 429</b>	←	1656		
						1987	<b>477 430</b>	→	1561		
					LWG	1987	<b>477 434</b>	←	1692		
						1987	<b>477 435</b>	→	1604		
	1.8 i	05.97-10.03	74-76			1987	<b>477 429</b>	←	1656		
						1987	<b>477 430</b>	→	1561		
	1.8 i 16V	05.97-10.03	81			1987	<b>477 431</b>	←	1696		
						1987	<b>477 432</b>	→	1614		
	1.9 D	05.97-10.03	50		LIM	1987	<b>477 429</b>	←	1656		
						1987	<b>477 430</b>	→	1561		

		S											
1.9D		05.97-10.03	50		LWG		1 987 477 434	← 1692					
							1 987 477 435	→ 1604					
							51			1 987 477 429	← 1656		
										1 987 477 430	→ 1561		
							09.98-10.03	51		LIM	1 987 477 429	← 1656	
											1 987 477 430	→ 1561	
										LWG	1 987 477 434	← 1692	
											1 987 477 435	→ 1604	
							09.99-10.03	52		LIM	1 987 477 429	← 1656	
											1 987 477 430	→ 1561	
			LWG	1 987 477 434	← 1692								
				1 987 477 435	→ 1604								
1.9D Turbo		05.97-10.03	55/66				1 987 477 429	← 1656					
							1 987 477 430	→ 1561					
2.0HDi		05.97-10.03	66/97-99/				1 987 477 431	← 1696					
2.0i 16V			120				1 987 477 432	→ 1614					
	1.4	05.97-10.03	55		STB		0 265 006 203 <sup>4</sup>						
	1.4	05.97-10.03	55		LAB		0 265 006 201 <sup>3</sup>						
	1.4 i				RAB		0 265 006 200 <sup>3</sup>						
	1.4 i	05.97-10.03	55		LIM,STB	0 265 006 203 <sup>4</sup>							
					LWG,STB	0 265 006 441 <sup>4</sup>							
	1.6 i	05.97-10.03	65-66/74		LAB	0 265 006 201 <sup>3</sup>							
					RAB	0 265 006 200 <sup>3</sup>							
					STB	0 265 006 203 <sup>4</sup>							
	1.8D	05.97-10.03	44		LAB	0 265 006 201 <sup>3</sup>							
					LIM,STB	0 265 006 203 <sup>4</sup>							
LWG,STB					0 265 006 441 <sup>4</sup>								
RAB					0 265 006 200 <sup>3</sup>								
1.8 i	05.97-10.03	74-76		LAB	0 265 006 201 <sup>3</sup>								
				RAB	0 265 006 200 <sup>3</sup>								
				STB	0 265 006 203 <sup>4</sup>								
1.8 i 16V	05.97-10.03	81		LAB	0 265 006 201 <sup>3</sup>								
				RAB	0 265 006 200 <sup>3</sup>								
				4SB	0 265 006 202 <sup>4</sup>								
1.9D		05.97-10.03	50		LAB	0 265 006 201 <sup>3</sup>							
					LIM,STB	0 265 006 203 <sup>4</sup>							
					LWG,STB	0 265 006 441 <sup>4</sup>							
					RAB	0 265 006 200 <sup>3</sup>							
					51		LAB	0 265 006 201 <sup>3</sup>					
							RAB	0 265 006 200 <sup>3</sup>					
							STB	0 265 006 203 <sup>4</sup>					
					09.98-10.03	51		LIM,STB	0 265 006 203 <sup>4</sup>				
								LWG,STB	0 265 006 441 <sup>4</sup>				
					09.99-10.03	52		LAB	0 265 006 201 <sup>3</sup>				
								LIM,STB	0 265 006 203 <sup>4</sup>				
								LWG,STB	0 265 006 441 <sup>4</sup>				
1.9D Turbo	05.97-10.03	55/66		LAB	0 265 006 201 <sup>3</sup>								
				RAB	0 265 006 200 <sup>3</sup>								
				STB	0 265 006 203 <sup>4</sup>								
2.0HDi		05.97-10.03	66/97-99/		LAB	0 265 006 201 <sup>3</sup>							
2.0i 16V			120		RAB	0 265 006 200 <sup>3</sup>							
					4SB	0 265 006 202 <sup>4</sup>							
<b>307 Break/SW [T5]</b>													
													
	1.4 HDi	03.02-05.05	50/55				0 204 102 971	← 54					
	1.4 i						0 204 103 971						
							0 204 102 972	→ 54					
							0 204 103 972						





	◀ PEUGEOT 307 Break/SW [T5]						
1.4 i 16V	MFD	11.03-05.05	65		0 204 102 974	→ 54	
	OFD	11.03-05.05	65		0 204 102 971	← 54	
					0 204 103 971	↻	
					0 204 102 972	→ 54	
					0 204 103 972	↻	
1.6 HDi, i		03.02-05.05	66/80		0 204 102 974	→ 54	
2.0 HDi		03.02-05.05	66/79		0 204 102 974	→ 54	
		10.03-05.05	100		0 986 474 451	↻ → 57	
2.0 i		03.02-05.05	100		0 204 102 974	→ 54	



	1.4 HDi		03.02-05.05	50	BO	0 204 205 113	← 38
						0 986 473 254	↻
						0 204 205 114	→ 38
						0 986 474 254	↻
					LUC	0 986 473 228	↻ ← 38,1
						0 986 474 228	↻ →
	1.4 i		03.02-05.05	55		0 986 473 228	↻ ← 38,1
						0 986 474 228	↻ →
					BO	0 204 205 113	← 38
						0 986 473 254	↻
						0 204 205 114	→ 38
						0 986 474 254	↻
					LUC	0 986 473 228	↻ ← 38,1
						0 986 474 228	↻ →
	1.4 i 16V		11.03-05.05	65	BO	0 204 205 113	← 38
						0 986 473 254	↻
						0 204 205 114	→ 38
						0 986 474 254	↻
					LUC	0 986 473 228	↻ ← 38,1
						0 986 474 228	↻ →
	1.6 HDi		03.02-05.05	66/80	BO	0 204 205 113	← 38
						0 986 473 254	↻
	1.6 i					0 204 205 114	→ 38
						0 986 474 254	↻
					LUC	0 986 473 228	↻ ← 38,1
						0 986 474 228	↻ →
	2.0 HDi		03.02-05.05	66/79/100	BO	0 204 205 113	← 38
						0 986 473 254	↻
	2.0 i					0 204 205 114	→ 38
						0 986 474 254	↻
					LUC	0 986 473 228	↻ ← 38,1
						0 986 474 228	↻ →



	1.4 HDi		03.02-05.05	50/55/65		1 987 477 775	↔ 2115
	1.4 i		03.02-05.05	50/55/65		1 987 477 775	↔ 2115
	1.4 i 16V		11.03-05.05	50/55/65		1 987 477 775	↔ 2115
	1.6 HDi		02.04-05.05	66/80		1 987 477 775	↔ 2115
	1.6 i		03.02-05.05	66/80		1 987 477 775	↔ 2115
	2.0 HDi		03.02-05.05	66/79/100		1 987 477 775	↔ 2115
	2.0 i		03.02-05.05	66/79/100		1 987 477 775	↔ 2115

	1.4 HDi		03.02-05.05	50/55/65	TW	0 265 007 423 <sup>3</sup>		
	1.4 i					0 265 007 424 <sup>4</sup>		
	1.4 i 16V						0 265 007 664 <sup>4</sup>	
							0 265 007 779 <sup>4</sup>	
							0 265 007 780 <sup>4</sup>	
							0 265 008 017 <sup>4</sup>	
							0 986 594 559 <sup>3</sup>	

	S							
1.6 HDi 1.6 i	03.02-05.05	66/80			TW	0 265 007 423 <sup>3</sup> 0 265 007 424 <sup>4</sup> 0 265 007 664 <sup>4</sup> 0 265 007 779 <sup>4</sup> 0 265 007 780 <sup>4</sup> 0 265 008 017 <sup>4</sup> 0 986 594 559 <sup>3</sup>		
2.0 HDi 2.0 i	03.02-05.05	66/79/100			TW	0 265 007 423 <sup>3</sup> 0 265 007 424 <sup>4</sup> 0 265 007 664 <sup>4</sup> 0 265 007 779 <sup>4</sup> 0 265 007 780 <sup>4</sup> 0 265 008 017 <sup>4</sup> 0 986 594 559 <sup>3</sup>		
<b>307 Break/SW [T6]</b>								
1.4 i	MFD 06.05-05.08 OFD 06.05-05.08	65				0 204 102 974 0 204 102 971 0 204 103 971 0 204 102 972 0 204 103 972	→ 54 ← 54  → 54 	
1.6 HDi, i 16V, i 16V BioFlex	06.05-12.09	66/80				0 204 102 974	→ 54	
2.0 HDi	06.05-07.05 08.05-05.08	100	Org.-Nr. →10485 Org.-Nr. 10486→			0 986 474 451 0 986 473 451 0 986 474 451	→ 57 → 57 → 57	
2.0 i	06.05-05.08	103				0 204 102 974	→ 54	
1.4 i	06.05-05.08	65			BO	0 204 205 113 0 986 473 254 0 204 205 114 0 986 474 254	← 38  → 38 	
					LUC	0 986 473 228 0 986 474 228	← 38,1 →	
1.6 HDi 1.6 i 16V 1.6 i 16V BioFlex	06.05-12.09	66/80			BO	0 204 205 113 0 986 473 254 0 204 205 114 0 986 474 254	← 38  → 38 	
					LUC	0 986 473 228 0 986 474 228	← 38,1 →	
2.0 HDi 2.0 i	06.05-05.08	100/103			BO	0 204 205 113 0 986 473 254 0 204 205 114 0 986 474 254	← 38  → 38 	
					LUC	0 986 473 228 0 986 474 228	← 38,1 →	
1.4 i	06.05-05.08	65				1 987 477 775	↔ 2115	
1.6 HDi	06.05-05.08	66/80				1 987 477 775	↔ 2115	
1.6 i 16V	06.05-05.08	66/80				1 987 477 775	↔ 2115	
1.6 i 16V BioFlex	09.07-12.09	66/80				1 987 477 775	↔ 2115	
2.0 HDi	06.05-05.08	100/103				1 987 477 775	↔ 2115	
2.0 i	06.05-05.08	100/103				1 987 477 775	↔ 2115	
1.4 i	06.05-05.08	65				0 265 007 779 <sup>4</sup> 0 986 594 559 <sup>3</sup>		
1.6 HDi 1.6 i 16V, i 16V BioFlex	06.05-12.09	66/80				0 265 007 779 <sup>4</sup> 0 986 594 559 <sup>3</sup>		





		S							
	◀ PEUGEOT 307 Break/SW [T6]								
	2.0 HDi	06.05-05.08	100/103				0 265 007 779 <sup>4</sup>		
	2.0i						0 986 594 559 <sup>3</sup>		
	<b>307 CC [T5]</b>								
	2.0i	10.03-05.05	100				0 204 102 974	→ 54	
	2.0i Sport	10.03-05.05	130				0 986 474 451	→ 57	
	2.0i	10.03-05.05	100/130			BO	0 204 205 113	← 38	
	2.0i Sport						0 986 473 254		
							0 204 205 114	→ 38	
							0 986 474 254		
						LUC	0 986 473 228	← 38,1	
							0 986 474 228	→	
	2.0i	10.03-05.05	100/130				1 987 477 598	↔ 2035	
	2.0i Sport	10.03-05.05	100/130				1 987 477 598	↔ 2035	
	2.0i	10.03-05.05	100/130			TW	0 265 007 423 <sup>3</sup>		
	2.0i Sport						0 265 007 424 <sup>4</sup>		
							0 265 007 664 <sup>4</sup>		
							0 265 007 779 <sup>4</sup>		
							0 265 007 780 <sup>4</sup>		
							0 265 008 017 <sup>4</sup>		
							0 986 594 559 <sup>3</sup>		
	<b>307 CC [T6]</b>								
	1.6i	06.05-03.09	80				0 204 102 974	→ 54	
	2.0 HDi	06.05-03.09	100				0 986 473 451	← 57	
							0 986 474 451	→ 57	
	2.0i	06.05-03.09	103				0 204 102 974	→ 54	
	2.0i Sport	06.05-03.09	130				0 986 473 451	← 57	
							0 986 474 451	→ 57	
	1.6i	06.05-03.09	80			LUC	0 986 473 228	← 38,1	
							0 986 474 228	→	
						TW BO	0 204 204 871	←	0 204 0K2 014 <sup>8</sup>
									0 204 0K2 019 <sup>7</sup>
							0 204 204 872	→	0 204 0K2 014 <sup>8</sup>
							0 204 205 113	← 38	
							0 986 473 254		
							0 204 205 114	→ 38	
							0 986 474 254		
	2.0 HDi	06.05-03.09	100			LUC	0 986 473 228	← 38,1	
							0 986 474 228	→	
						TW BO	0 204 204 871	←	0 204 0K2 014 <sup>8</sup>
									0 204 0K2 019 <sup>7</sup>
							0 204 204 872	→	0 204 0K2 014 <sup>8</sup>
							0 204 205 113	← 38	
							0 986 473 254		
							0 204 205 114	→ 38	
							0 986 474 254		



		S							
2.0i		06.05-03.09	103				BO	0 204 205 113	← 38
								0 986 473 254	
								0 204 205 114	→ 38
								0 986 474 254	
							LUC	0 986 473 228	← 38,1
								0 986 474 228	→
2.0i Sport		06.05-03.09	130				LUC	0 986 473 228	← 38,1
								0 986 474 228	→
							TW BO	0 204 204 871	←
									0 204 0K2 014 <sup>B</sup>
									0 204 0K2 019 <sup>7</sup>
								0 204 204 872	→
								0 204 205 113	← 38
								0 986 473 254	
								0 204 205 114	→ 38
								0 986 474 254	
<hr/>									
	1.6i	06.05-03.09	80					1 987 477 598	↔ 2035
	2.0 HDi	06.05-03.09	100/103/130					1 987 477 598	↔ 2035
	2.0i	06.05-03.09	100/103/130					1 987 477 598	↔ 2035
	2.0i Sport	06.05-03.09	100/103/130					1 987 477 598	↔ 2035
	1.6i	06.05-03.09	80				TW	0 265 007 424 <sup>4</sup>	
								0 265 007 779 <sup>4</sup>	
								0 265 008 017 <sup>4</sup>	
								0 265 008 018 <sup>4</sup>	
								0 986 594 559 <sup>3</sup>	
	2.0 HDi	06.05-03.09	100				TW	0 265 007 424 <sup>4</sup>	
								0 265 007 779 <sup>4</sup>	
								0 265 008 017 <sup>4</sup>	
								0 265 008 018 <sup>4</sup>	
								0 986 594 559 <sup>3</sup>	
	2.0i	06.05-03.09	103				TW	0 265 007 424 <sup>4</sup>	
								0 265 007 779 <sup>4</sup>	
								0 265 008 017 <sup>4</sup>	
								0 986 594 559 <sup>3</sup>	
	2.0i Sport	06.05-03.09	130				TW	0 265 007 424 <sup>4</sup>	
								0 265 007 664 <sup>4</sup>	
								0 265 008 017 <sup>4</sup>	
								0 265 008 018 <sup>4</sup>	
								0 986 594 559 <sup>3</sup>	
<hr/>									
<b>307 Sedan [T6]</b>									
	2.0i 16V	08.06-01.12	105					0 204 102 974	→ 54
	2.0i 16V	08.06-01.12	105				BO	0 204 205 113	← 38
								0 986 473 254	
								0 204 205 114	→ 38
								0 986 474 254	
							LUC	0 986 473 228	← 38,1
								0 986 474 228	→





◀ PEUGEOT 307 Sedan [T6]



	2.0 i 16V	08.06-01.12	105	TW	0 265 007 424 <sup>4</sup>	
					0 265 007 664 <sup>4</sup>	
					0 265 007 779 <sup>4</sup>	
					0 265 008 017 <sup>4</sup>	
					0 986 594 559 <sup>3</sup>	

307 [T5]



	1.4 HDi	08.00-05.05	50/55		0 204 102 971	← 54
	1.4 i				0 204 103 971	→ 54
	1.4 i 16V	MFD 11.03-05.05	65		0 204 102 972	→ 54
		OFD 11.03-05.05	65		0 204 102 971	← 54
					0 204 103 971	→ 54
					0 204 102 972	→ 54
					0 204 103 972	→ 54
	1.6 HDi	OFD 02.04-05.05	66		0 204 004 451	← 54
					0 204 103 971	→ 54
					0 204 004 452	→ 54
	1.6 HDi, i	08.00-05.05	80		0 204 102 974	→ 54
	1.6 HDi, i 16V	MFD 02.04-04.06	66/81		0 204 102 974	→ 54
	1.6 i	08.00-05.05	80		0 204 004 451	← 54
					0 204 103 971	→ 54
					0 204 004 452	→ 54
	1.6 i 16V	OFD 06.04-04.06	81		0 204 102 971	← 54
					0 204 103 971	→ 54
					0 204 102 972	→ 54
					0 204 103 972	→ 54
	2.0 HDi	08.00-05.05	66		0 204 102 971	← 54
					0 204 103 971	→ 54
					0 204 102 972	→ 54
					0 204 103 972	→ 54
					0 204 102 974	→ 54
		03.02-05.05	79		0 204 102 974	→ 54
		10.03-05.05	100		0 986 474 451	→ 57
	2.0 i	08.00-05.05	100		0 204 102 974	→ 54
	2.0 i 16V	06.04-04.06	105		0 204 102 974	→ 54



	1.4 HDi	08.00-05.05	50/55/65	BO	0 204 205 113	← 38
	1.4 i				0 986 473 254	→ 38
	1.4 i 16V				0 204 205 114	→ 38
					0 986 474 254	→ 38
				LUC	0 986 473 228	← 38,1
					0 986 474 228	→ 38,1
	1.6 HDi	08.00-04.06	66/80/81	BO	0 204 205 113	← 38
	1.6 i				0 986 473 254	→ 38
	1.6 i 16V				0 204 205 114	→ 38
					0 986 474 254	→ 38
				LUC	0 986 473 228	← 38,1
					0 986 474 228	→ 38,1
	2.0 HDi	08.00-04.06	66/79/100/	BO	0 204 205 113	← 38
	2.0 i		105		0 986 473 254	→ 38
	2.0 i 16V				0 204 205 114	→ 38
					0 986 474 254	→ 38
				LUC	0 986 473 228	← 38,1
					0 986 474 228	→ 38,1

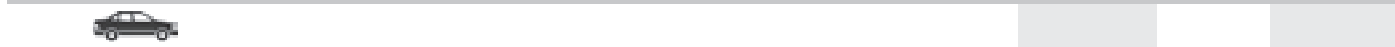

	1.4 HDi	10.01-05.05	50/55/65		1 987 477 598	↔ 2035
	1.4 i	08.00-05.05	50/55/65		1 987 477 598	↔ 2035
	1.4 i 16V	11.03-05.05	50/55/65		1 987 477 598	↔ 2035
	1.6 HDi	02.04-05.05	66/80		1 987 477 598	↔ 2035
	1.6 i	08.00-05.05	66/80		1 987 477 598	↔ 2035
	2.0 HDi	08.00-05.05	66/79/100		1 987 477 598	↔ 2035
	2.0 i	08.00-05.05	66/79/100		1 987 477 598	↔ 2035

	1.4 HDi	08.00-05.05	50/55/65	TW	0 265 007 423 <sup>3</sup>	
	1.4 i				0 265 007 424 <sup>4</sup>	
	1.4 i 16V				0 265 007 664 <sup>4</sup>	
					0 265 007 779 <sup>4</sup>	
					0 265 007 780 <sup>4</sup>	
					0 265 008 017 <sup>4</sup>	
					0 986 594 559 <sup>3</sup>	
	1.6 HDi	08.00-05.05	66/80	TW	0 265 007 423 <sup>3</sup>	
	1.6 i				0 265 007 424 <sup>4</sup>	
					0 265 007 664 <sup>4</sup>	
					0 265 007 779 <sup>4</sup>	
					0 265 007 780 <sup>4</sup>	
					0 265 008 017 <sup>4</sup>	
					0 986 594 559 <sup>3</sup>	
	1.6 i 16V	06.04-04.06	81	TW	0 265 008 017 <sup>4</sup>	
				0 265 007 423 <sup>3</sup>		
				0 265 007 424 <sup>4</sup>		
				0 265 007 664 <sup>4</sup>		
				0 265 007 779 <sup>4</sup>		
				0 265 007 780 <sup>4</sup>		
				0 986 594 559 <sup>3</sup>		
2.0 HDi	08.00-05.05	66/79/100	TW	0 265 007 423 <sup>3</sup>		
2.0 i				0 265 007 424 <sup>4</sup>		
				0 265 007 664 <sup>4</sup>		
				0 265 007 779 <sup>4</sup>		
				0 265 007 780 <sup>4</sup>		
				0 265 008 017 <sup>4</sup>		
				0 986 594 559 <sup>3</sup>		
2.0 i 16V	06.04-04.06	105	TW	0 265 008 017 <sup>4</sup>		
				0 265 007 423 <sup>3</sup>		
				0 265 007 424 <sup>4</sup>		
				0 265 007 664 <sup>4</sup>		
				0 265 007 779 <sup>4</sup>		
				0 265 007 780 <sup>4</sup>		
				0 986 594 559 <sup>3</sup>		

**307 [T6]**



	1.4 i	MFD	06.05-08.07	65		0 204 102 974	→ 54	
		OFD	06.05-08.07	65		0 204 102 971	← 54	
						0 204 103 971		
						0 204 102 972	→ 54	
						0 204 103 972		
	1.6 HDi			05.06-08.07	66		0 204 102 974	→ 54
		MFD	06.05-08.07	66		0 204 102 974	→ 54	
		OFD	06.05-08.07	66		0 204 102 971	← 54	
						0 204 103 971		
						0 204 102 972	→ 54	
	1.6 HDi, i			06.05-08.07	80		0 204 103 972	
						0 204 102 974	→ 54	
						0 204 102 974	→ 54	



		S							
	◀ PEUGEOT 307 [T6]								
1.6 i	06.05-08.07	80					0 204 004 451	← 54	
							0 204 103 971		
							0 204 004 452	→ 54	
2.0 HDi	06.05-07.05	100	Org.-Nr. →10485				0 986 474 451		→ 57
	08.05-08.07	100	Org.-Nr. 10486→				0 986 473 451		← 57
							0 986 474 451		→ 57
2.0 i	06.05-07.05	130	Org.-Nr. →10485				0 986 474 451		→ 57
	06.05-08.07	103					0 204 102 974	→ 54	
	08.05-12.06	130	Org.-Nr. 10486→				0 986 473 451		← 57
							0 986 474 451		→ 57
	1.4 i	06.05-08.07	65			BO	0 204 205 113	← 38	
							0 986 473 254		
							0 204 205 114	→ 38	
							0 986 474 254		
						LUC	0 986 473 228		← 38,1
							0 986 474 228		→
1.6 HDi	06.05-08.07	66/80				BO	0 204 205 113	← 38	
1.6 i							0 986 473 254		
							0 204 205 114	→ 38	
							0 986 474 254		
						LUC	0 986 473 228		← 38,1
							0 986 474 228		→
2.0 HDi	06.05-08.07	100/103/				BO	0 204 205 113	← 38	
2.0 i		130					0 986 473 254		
							0 204 205 114	→ 38	
							0 986 474 254		
						LUC	0 986 473 228		← 38,1
							0 986 474 228		→
	1.4 i	06.05-08.07	65				1 987 477 598	↔ 2035	
	1.6 HDi	06.05-08.07	66/80				1 987 477 598	↔ 2035	
	1.6 i	06.05-08.07	66/80				1 987 477 598	↔ 2035	
	2.0 HDi	06.05-08.07	100/103/130				1 987 477 598	↔ 2035	
	2.0 i	06.05-08.07	100/103/130				1 987 477 598	↔ 2035	
	1.4 i	06.05-08.07	65				0 265 007 779 <sup>4</sup>		
							0 986 594 559 <sup>3</sup>		
1.6 HDi	06.05-08.07	66					0 265 007 779 <sup>4</sup>		
							0 986 594 559 <sup>3</sup>		
		80					0 265 007 779 <sup>4</sup>		
							0 986 594 559 <sup>3</sup>		
1.6 i	06.05-08.07	80				TW	0 265 007 424 <sup>4</sup>		
							0 265 007 779 <sup>4</sup>		
							0 265 008 017 <sup>4</sup>		
							0 986 594 559 <sup>3</sup>		
2.0 HDi	06.05-08.07	100					0 265 007 779 <sup>4</sup>		
							0 986 594 559 <sup>3</sup>		
2.0 i	06.05-12.06	130					0 265 007 664 <sup>4</sup>		
							0 986 594 559 <sup>3</sup>		
	06.05-08.07	103				TW	0 265 007 424 <sup>4</sup>		
							0 265 007 779 <sup>4</sup>		
							0 265 008 017 <sup>4</sup>		
							0 986 594 559 <sup>3</sup>		



		S							
<b>308 CC [T7]</b>									
	1.6 HDi	03.09→	82/84/88				0 204 902 044	← 57	0 204 104 359 <sup>B</sup>
	1.6 VTi						0 986 134 318		
							0 204 902 045	→ 57	0 204 104 359 <sup>B</sup>
							0 986 135 318		
	1.6 HDi	03.09→	82/84/88/103/				0 986 473 228	← 38,1	
	1.6 THP, VTi		110/115/120				0 986 474 228	→	
	1.6 THP GTi	05.10→	147				0 986 134 230	←	
							0 986 135 230	→	
	2.0 HDi	03.09→	100/103/				0 986 473 228	← 38,1	
			110/120				0 986 474 228	→	
	1.6 HDi	03.09→	82/84/88/103/110/115/120				1 987 482 190	↔ 2033	
	1.6 THP	03.09→	82/84/88/103/110/115/120				1 987 482 190	↔ 2033	
	1.6 VTi	03.09→	82/84/88/103/110/115/120				1 987 482 190	↔ 2033	
	2.0 HDi	03.09→	100/103/110/120				1 987 482 190	↔ 2033	
<b>308 SW [T7]</b>									
	1.4	05.08-01.14	70/72				0 204 902 044	← 57	0 204 104 359 <sup>B</sup>
	1.4 VTi						0 986 134 318		
							0 204 902 045	→ 57	0 204 104 359 <sup>B</sup>
							0 986 135 318		
	1.6	05.08-01.14	66/68/80/				0 204 902 044	← 57	0 204 104 359 <sup>B</sup>
	1.6 BioFlex		82/84/88				0 986 134 318		
	1.6 HDi						0 204 902 045	→ 57	0 204 104 359 <sup>B</sup>
	1.6 VTi						0 986 135 318		
	1.6 THP	05.08-07.08	103/110/	Org.-Nr. →11577			0 986 473 451	← 57	
			128				0 986 474 451	→ 57	
	2.0	05.08-07.08	103	Org.-Nr. →11577			0 986 473 451	← 57	
							0 986 474 451	→ 57	
		01.09-04.12	103	Org.-Nr. 11679→			0 204 902 044	← 57	0 204 104 359 <sup>B</sup>
							0 986 134 318		
							0 204 902 045	→ 57	0 204 104 359 <sup>B</sup>
							0 986 135 318		
	2.0 HDi	05.08-07.08	100-103	Org.-Nr. →11577			0 986 473 451	← 57	
							0 986 474 451	→ 57	
	1.4	05.08-01.14	70/72		249		0 986 473 228	← 38,1	
	1.4 VTi						0 986 474 228	→	
					268		0 986 134 083	← 38	
							0 986 135 083	→ 38	
	1.6, BioFlex, HDi, THP, VTi	05.08-01.14	66/68/80/		249		0 986 473 228	← 38,1	
			82/84/88/				0 986 474 228	→	
			103/110/		268		0 986 134 083	← 38	
			115/120/128				0 986 135 083	→ 38	
	2.0	05.08-01.14	100-103/		249		0 986 473 228	← 38,1	
	2.0 HDi		110/120				0 986 474 228	→	
					268		0 986 134 083	← 38	
							0 986 135 083	→ 38	





◀ PEUGEOT 308 SW [T7]



	<b>1.4</b>	05.08-03.10	70/72		1987 <b>482 324</b>	↔ 2128	
	<b>1.4 VTi</b>	04.10-01.14	70/72		1987 <b>482 324</b>	↔ 2128	
	<b>1.6</b>	05.08-01.14	66/68/80/82/84/88/103/110/115/120/128		1987 <b>482 324</b>	↔ 2128	
	<b>1.6 BioFlex</b>	03.09-04.12	66/68/80/82/84/88/103/110/115/120/128		1987 <b>482 324</b>	↔ 2128	
	<b>1.6 HDi</b>	05.08-01.14	66/68/80/82/84/88/103/110/115/120/128		1987 <b>482 324</b>	↔ 2128	
	<b>1.6 THP</b>	05.08-01.14	66/68/80/82/84/88/103/110/115/120/128		1987 <b>482 324</b>	↔ 2128	
	<b>1.6 VTi</b>	12.09-01.14	66/68/80/82/84/88/103/110/115/120/128		1987 <b>482 324</b>	↔ 2128	
	<b>2.0</b>	05.08-04.12	100-103/110/120		1987 <b>482 324</b>	↔ 2128	
	<b>2.0 HDi</b>	05.08-01.14	100-103/110/120		1987 <b>482 324</b>	↔ 2128	

**308 [T7]**



	<b>1.4</b>	09.07-06.13	70/72		0204 <b>902 044</b>	← 57	0204 <b>104 359</b> <sup>8</sup>
	<b>1.4 VTi</b>				0986 <b>134 318</b>		
					0204 <b>902 045</b>	→ 57	0204 <b>104 359</b> <sup>8</sup>
					0986 <b>135 318</b>		
	<b>1.6, HDi, i Flex, THP, VTi</b>	09.07→	66/68/80/ 82/84/ 85-90/ 103/110		0204 <b>902 044</b>	← 57	0204 <b>104 359</b> <sup>8</sup>
					0986 <b>134 318</b>		
					0204 <b>902 045</b>	→ 57	0204 <b>104 359</b> <sup>8</sup>
					0986 <b>135 318</b>		
	<b>1.6 THP</b>	03.08-07.08	128	Org.-Nr. →11577	0986 <b>473 451</b>	← 57	
					0986 <b>474 451</b>	→ 57	
	<b>2.0</b>	07.08-04.12	103		0204 <b>902 044</b>	← 57	0204 <b>104 359</b> <sup>8</sup>
					0986 <b>134 318</b>		
					0204 <b>902 045</b>	→ 57	0204 <b>104 359</b> <sup>8</sup>
					0986 <b>135 318</b>		
	<b>2.0 HDi</b>	09.07-07.08	100-103	Org.-Nr. →11577	0986 <b>473 451</b>	← 57	
				0986 <b>474 451</b>	→ 57		
	01.09-06.13	100-103	Org.-Nr. 11679→	0204 <b>902 044</b>	← 57	0204 <b>104 359</b> <sup>8</sup>	
				0986 <b>134 318</b>			
				0204 <b>902 045</b>	→ 57	0204 <b>104 359</b> <sup>8</sup>	
				0986 <b>135 318</b>			



	<b>1.4</b>	09.07-06.13	70/72		0986 <b>473 228</b>	← 38,1	
	<b>1.4 VTi</b>				0986 <b>474 228</b>	→	
	<b>1.6</b>	09.07-06.13	66/68/80/ 82/84		0986 <b>473 228</b>	← 38,1	
	<b>1.6 HDi</b>				0986 <b>474 228</b>	→	
	<b>1.6, THP, VTi</b>	09.07-06.13	88/103/110/ 115/120/128		0986 <b>473 228</b>	← 38,1	
					0986 <b>474 228</b>	→	
	<b>1.6 GTi THP</b>	05.10-06.13	147		0986 <b>134 230</b>	←	
					0986 <b>135 230</b>	→	
	<b>1.6 i Flex</b>	02.12→	85-90		0204 <b>204 871</b>	←	0204 <b>OK2 014</b> <sup>8</sup>
							0204 <b>OK2 019</b> <sup>7</sup>
					0204 <b>204 872</b>	→	0204 <b>OK2 014</b> <sup>8</sup>
	<b>2.0</b>	09.07-06.13	100-103/ 110/120		0986 <b>473 228</b>	← 38,1	
<b>2.0 HDi</b>				0986 <b>474 228</b>	→		



	<b>1.4</b>	09.07-03.10	70/72		1987 <b>482 190</b>	↔ 2033	
	<b>1.4 VTi</b>	04.10-06.13	70/72		1987 <b>482 190</b>	↔ 2033	
	<b>1.6</b>	09.07-06.13	66/68/80/82/84/88/103/110/115/120/128		1987 <b>482 190</b>	↔ 2033	
	<b>1.6 HDi</b>	09.07-06.13	66/68/80/82/84/88/103/110/115/120/128		1987 <b>482 190</b>	↔ 2033	
	<b>1.6 THP</b>	09.07-06.13	66/68/80/82/84/88/103/110/115/120/128		1987 <b>482 190</b>	↔ 2033	
	<b>1.6 VTi</b>	12.09-06.13	66/68/80/82/84/88/103/110/115/120/128		1987 <b>482 190</b>	↔ 2033	
	<b>2.0</b>	07.08-04.12	100-103/110/120		1987 <b>482 190</b>	↔ 2033	
	<b>2.0 HDi</b>	09.07-06.13	100-103/110/120		1987 <b>482 190</b>	↔ 2033	

		S								
<b>405 Break [4]</b>										
	1.4 1.4i	06.92-04.97	55			INB	BSY	0 204 102 281 0 204 103 281	← 48 → 48	0 204 104 039 <sup>7</sup>
								0 204 102 282 0 204 103 282	→ 48 → 48	0 204 104 039 <sup>7</sup>
	1.4i	ABS 06.92-04.97	55			INB		0 986 473 691 0 986 474 691	→ 54 → 54	
	1.6 1.6i	06.92-04.97	65-66/68			INB	BSY	0 204 102 281 0 204 103 281	← 48 → 48	0 204 104 039 <sup>7</sup>
		ABS 06.92-04.97	65-66/68			INB		0 986 473 691 0 986 474 691	→ 54 → 54	
	1.8i	ABO 06.92-04.97	74-76			INB		0 986 473 266 0 986 474 266	→ 48 → 48	
		ABS 06.92-04.97	74-76			INB		0 986 473 691 0 986 474 691	→ 54 → 54	
	1.9	06.92-04.97	71/80			INB	BSY	0 204 102 281 0 204 103 281	← 48 → 48	0 204 104 039 <sup>7</sup>
								0 204 102 282 0 204 103 282	→ 48 → 48	0 204 104 039 <sup>7</sup>
	1.9 1.9D 1.9D Turbo	ABO 06.92-04.97	47/50/51-52/ 66-68/71/80			INB		0 986 473 266 0 986 474 266	→ 48 → 48	
		ABS 06.92-04.97	47/50/51-52/ 66-68/71/80			INB		0 986 473 691 0 986 474 691	→ 54 → 54	
	1.9i	06.92-04.97	89			INB	GIR	0 986 473 691 0 986 474 691	→ 54 → 54	
	2.0i	06.92-04.97	89-91			INB	GIR	0 986 473 691 0 986 474 691	→ 54 → 54	
	1.4 1.4i	06.92-04.97	55				GIR, RBA	0 986 475 796	↔ 20,6	
								Fg.-Nr. S 71211990→ GIM	0 986 475 796	↔ 20,6
	1.6 1.6i	06.92-04.97	65-66/68				GIR, RBA	0 986 475 796	↔ 20,6	
								Fg.-Nr. S 71211990→ GIM	0 986 475 796	↔ 20,6
	1.8i	06.92-04.97	74-76				GIR, RBA	0 986 475 796	↔ 20,6	
								Fg.-Nr. S 71211990→ GIM	0 986 475 796	↔ 20,6
	1.9 1.9D 1.9D Turbo	06.92-04.97	47/50/ 51-52/ 66-68/ 71/80				GIR, RBA	0 986 475 796	↔ 20,6	
								Fg.-Nr. S 71211990→ GIM	0 986 475 796	↔ 20,6
	1.9i	06.92-04.97	89					0 986 473 666 0 986 474 666	→ 38 → 38	1 987 470 504 <sup>B</sup>
	2.0i	06.92-04.97	89-91					0 986 473 666 0 986 474 666	→ 38 → 38	1 987 470 504 <sup>B</sup>
	2.0i 4x4	06.92-04.97	89-91					0 986 473 673 0 986 474 673	→ 38 → 38	1 987 470 504 <sup>B</sup>
	1.4 1.4i	06.92-04.97	55					1 987 477 422 1 987 477 147	1842 → 550	
						TBR		1 987 477 148	← 855	
	1.6 1.6i	06.92-04.97	65-66/68					1 987 477 422 1 987 477 147	1842 → 550	
						TBR		1 987 477 148	← 855	



















	◀ PEUGEOT 405 Break [4]									
1.8 i	06.92-04.97	74-76							1987 477 422	1842
							TBR		1987 477 147	→ 550
									1987 477 148	← 855
1.9	06.92-04.97	47/50/51-52/							1987 477 422	1842
1.9 D		66-68/71/80					TBR		1987 477 147	→ 550
1.9 D Turbo									1987 477 148	← 855
1.9 i	06.92-04.97	89							1987 477 422	1842
							SBR		1987 477 149	← 872
									1987 477 150	→ 558
2.0 i	06.92-04.97	89-91							1987 477 422	1842
							SBR		1987 477 149	← 872
									1987 477 150	→ 558
	1.4	06.92-04.97	55				BO		0 265 006 314 <sup>3</sup>	
	1.4 i								0 265 006 315 <sup>4</sup>	
	1.6	06.92-04.97	65-66/68				BO		0 265 006 314 <sup>3</sup>	
	1.6 i								0 265 006 315 <sup>4</sup>	
	1.8 i	06.92-04.97	74-76				BO		0 265 006 314 <sup>3</sup>	
									0 265 006 315 <sup>4</sup>	
	1.9, D, D Turbo, i	06.92-04.97	47/50/51-52/				BO		0 265 006 314 <sup>3</sup>	
			66-68/71/80/89						0 265 006 315 <sup>4</sup>	
	2.0 i	06.92-04.97	89-91				BO		0 265 006 315 <sup>4</sup>	
	2.0 i, i 4x4	06.92-04.97	89-91				BO		0 265 006 314 <sup>3</sup>	
	2.0 i 4x4	06.92-04.97	89-91				BO		0 265 003 081 <sup>4</sup>	

405 [4]

	405 [4]										
	1.4	06.92-04.97	55				INB	BSY	0 204 102 281	← 48	0 204 104 039 <sup>7</sup>
	1.4 i								0 204 103 281		
									0 204 102 282	→ 48	0 204 104 039 <sup>7</sup>
									0 204 103 282		
	1.4 i	ABS	06.92-04.97	55			INB		0 986 473 691	← 54	
									0 986 474 691	→ 54	
	1.6	06.92-04.97	65-66/68				INB	BSY	0 204 102 281	← 48	0 204 104 039 <sup>7</sup>
	1.6 i								0 204 103 281		
									0 204 102 282	→ 48	0 204 104 039 <sup>7</sup>
		ABS	06.92-04.97	65-66/68			INB		0 986 473 691	← 54	
									0 986 474 691	→ 54	
	1.8 i	ABO	06.92-04.97	74-76			INB		0 986 473 266	← 48	
									0 986 474 266	→ 48	
		ABS	06.92-04.97	74-76			INB		0 986 473 691	← 54	
									0 986 474 691	→ 54	
	1.9	06.92-04.97	71/80				INB	BSY	0 204 102 281	← 48	0 204 104 039 <sup>7</sup>
									0 204 103 281		
									0 204 102 282	→ 48	0 204 104 039 <sup>7</sup>
									0 204 103 282		
	1.9	ABO	06.92-04.97	47/50/51-52/			INB		0 986 473 266	← 48	
	1.9 D			66-68/71/80					0 986 474 266	→ 48	
	1.9 D Turbo	ABS	06.92-04.97	47/50/51-52/			INB		0 986 473 691	← 54	
				66-68/71/80					0 986 474 691	→ 54	
	1.9 i	06.92-04.97	89				INB	GIR	0 986 473 691	← 54	
									0 986 474 691	→ 54	
	2.0 i, i Mi16, i 4x4	06.92-04.97	89-91/				INB	GIR	0 986 473 691	← 54	
			110-118						0 986 474 691	→ 54	

	1.4	06.92-04.97	55				GIR,		0 986 475 796	↔ 20,6	
	1.4 i						RBA				
		ABO	06.92-04.97	55			BSY		F 026 002 208	← 20,6	
									F 026 002 209	→ 20,6	

		S							
<b>1.6</b>		06.92-04.97	65-66/68			GIR, RBA	0 986 475 796	↔ 20,6	
<b>1.6 i</b>		ABO 06.92-04.97	65-66/68			BSY	F 026 002 208	← 20,6	
							F 026 002 209	→ 20,6	
<b>1.8 i</b>		06.92-04.97	74-76			GIR, RBA	0 986 475 796	↔ 20,6	
		ABO 06.92-04.97	74-76			BSY	F 026 002 208	← 20,6	
							F 026 002 209	→ 20,6	
<b>1.9</b>		06.92-04.97	47/50/51-52/			GIR, RBA	0 986 475 796	↔ 20,6	
<b>1.9 D</b>			66-68/71/80						
<b>1.9 D Turbo</b>		ABO 06.92-04.97	47/50/51-52/			BSY	F 026 002 208	← 20,6	
			66-68/71/80				F 026 002 209	→ 20,6	
	<b>1.9 i</b>	06.92-04.97	89				0 986 473 666	↔ 38	1 987 470 504 <sup>B</sup>
							0 986 474 666	↔ 38	1 987 470 504 <sup>B</sup>
	<b>2.0 i</b>	06.92-04.97	89-91				0 986 473 666	↔ 38	1 987 470 504 <sup>B</sup>
							0 986 474 666	↔ 38	1 987 470 504 <sup>B</sup>
	<b>2.0 i Mi16</b>	01.93-04.97	110-118				0 986 473 666	↔ 38	1 987 470 504 <sup>B</sup>
							0 986 474 666	↔ 38	1 987 470 504 <sup>B</sup>
	<b>2.0 i T16 4x4</b>	09.92-04.97	144-159				0 986 473 673	↔ 38	
							0 986 474 673	↔ 38	
	<b>2.0 i 4x4</b>	06.92-04.97	89-91				0 986 473 673	↔ 38	1 987 470 504 <sup>B</sup>
							0 986 474 673	↔ 38	1 987 470 504 <sup>B</sup>
									
	<b>1.4</b>	06.92-04.97	55				1 987 477 422	1842	
	<b>1.4 i</b>					TBR	1 987 477 147	→ 550	
							1 987 477 148	← 855	
	<b>1.6</b>	06.92-04.97	65-66/68				1 987 477 422	1842	
	<b>1.6 i</b>					TBR	1 987 477 147	→ 550	
							1 987 477 148	← 855	
	<b>1.8 i</b>	06.92-04.97	74-76				1 987 477 422	1842	
						TBR	1 987 477 147	→ 550	
							1 987 477 148	← 855	
	<b>1.9, D, D Turbo</b>	06.92-04.97	47/50/51-52/				1 987 477 422	1842	
			66-68/71/80			TBR	1 987 477 147	→ 550	
							1 987 477 148	← 855	
	<b>1.9 i</b>	06.92-04.97	89				1 987 477 422	1842	
						SBR	1 987 477 149	← 872	
							1 987 477 150	→ 558	
	<b>2.0 i</b>	06.92-04.97	89-91/				1 987 477 422	1842	
	<b>2.0 i Mi16</b>		110-118			SBR	1 987 477 149	← 872	
							1 987 477 150	→ 558	
	<b>1.4</b>	06.92-04.97	55			BO	0 265 006 314 <sup>3</sup>		
	<b>1.4 i</b>						0 265 006 315 <sup>4</sup>		
	<b>1.6</b>	06.92-04.97	65-66/68			BO	0 265 006 314 <sup>3</sup>		
	<b>1.6 i</b>						0 265 006 315 <sup>4</sup>		
	<b>1.8 i</b>	06.92-04.97	74-76			BO	0 265 006 314 <sup>3</sup>		
							0 265 006 315 <sup>4</sup>		
	<b>1.9, D, D Turbo, i</b>	06.92-04.97	47/50/51-52/			BO	0 265 006 314 <sup>3</sup>		
			66-68/71/80/89				0 265 006 315 <sup>4</sup>		
	<b>2.0 i</b>	06.92-04.97	89-91			BO	0 265 006 315 <sup>4</sup>		
	<b>2.0 i Mi16</b>	01.93-04.97	110-118			BO	0 265 006 314 <sup>3</sup>		
							0 265 006 315 <sup>4</sup>		
	<b>2.0 i T16 4x4</b>	09.92-04.97	144-159			BO	0 265 003 081 <sup>4</sup>		
							0 265 006 314 <sup>3</sup>		
	<b>2.0 i 4x4</b>	06.92-04.97	89-91			BO	0 265 003 081 <sup>4</sup>		
	<b>2.0 i, i 4x4</b>	06.92-04.97	89-91			BO	0 265 006 314 <sup>3</sup>		



		S				?			
◀ PEUGEOT									
<b>405 [15]</b>									
	1.6	ABO	08.92-05.97	80			0986 473 266		← 48
							0986 474 266		→ 48
		ABS	08.92-05.97	80			0986 473 691		← 54
							0986 474 691		→ 54
	1.6		08.92-05.97	80		TW	0986 475 796		↔ 20,6
	1.6		08.92-05.97	80			1987 477 147		→ 550
							1987 477 148		← 855
							1987 477 422		1842
	1.6		08.92-05.97	80		BO	0265 006 314 <sup>3</sup>		
							0265 006 315 <sup>4</sup>		
<b>406 Break [D8]</b>									
	1.8 i		10.96-03.99	66/74-76/			0986 473 085		← 57,11
	1.8 i 16V			81-82			0986 474 085		→ 57,11
	1.9 D Turbo		10.96-03.99	55			0986 473 085		← 57,11
				66-68			0986 474 085		→ 57,11
							0986 473 086		← 57,11
							0986 474 086		→ 57,11
	2.0 HDi, i Turbo, i 16V		10.96-03.99	80/97-99/			0986 473 086		← 57,11
				104-110			0986 474 086		→ 57,11
	2.1 D Turbo		10.96-03.99	80-81			0986 473 086		← 57,11
							0986 474 086		→ 57,11
	3.0 i		10.96-03.99	140-143			0986 473 086		← 57,11
							0986 474 086		→ 57,11
	1.8 i		10.96-03.99	66/74-76/		BKR,STB	F 026 002 183		← 20,6
	1.8 i 16V			81-82			F 026 002 184		→ 20,6
	1.9 D Turbo		10.96-03.99	55		BKR,STB	F 026 002 183		← 20,6
				66-68			F 026 002 184		→ 20,6
						BKR	F 026 002 183		← 20,6
							F 026 002 184		→ 20,6
						BKR,STB	F 026 002 183		← 20,6
							F 026 002 184		→ 20,6
	1.8 i		10.96-03.99	66/74-76/		4SB	0986 473 108		← 32,94 1987 470 059 <sup>7</sup>
	1.8 i 16V			81-82			0986 473 108		← 32,94 1987 470 505 <sup>8</sup>
							0986 474 108		→ 32,94 1987 470 059 <sup>7</sup>
	1.9 D Turbo		10.96-03.99	55/66-68		4SB	0986 473 108		← 32,94 1987 470 059 <sup>7</sup>
							0986 473 108		← 32,94 1987 470 505 <sup>8</sup>
							0986 474 108		→ 32,94 1987 470 059 <sup>7</sup>
	2.0 HDi		10.96-03.99	80/97-99/			0986 473 108		← 32,94 1987 470 059 <sup>7</sup>
	2.0 i Turbo			104-110			0986 473 108		← 32,94 1987 470 505 <sup>8</sup>
	2.0 i 16V						0986 474 108		→ 32,94 1987 470 059 <sup>7</sup>
	2.1 D Turbo		10.96-03.99	80-81			0986 473 108		← 32,94 1987 470 059 <sup>7</sup>
							0986 473 108		← 32,94 1987 470 505 <sup>8</sup>
							0986 474 108		→ 32,94 1987 470 059 <sup>7</sup>



		S									
<b>3.0i</b>		10.96-03.99	140-143						0 986 473 108	32,94	1 987 470 059 <sup>7</sup>
									0 986 473 108	32,94	1 987 470 505 <sup>8</sup>
									0 986 474 108	32,94	1 987 470 059 <sup>7</sup>
<b>1.8i</b>		09.97-03.99	66				SBR		1 987 477 572	695	
									1 987 477 573	642	
									1 987 477 575	1700	
							TBR		1 987 477 571	750	
									1 987 477 575	1700	
<b>1.8i</b>		10.96-03.99	74-76/						1 987 477 575	1700	
<b>1.8i 16V</b>			81-82				SBR		1 987 477 572	695	
									1 987 477 573	642	
							TBR		1 987 477 571	750	
<b>1.9D Turbo</b>		10.96-03.99	55						1 987 477 575	1700	
							SBR		1 987 477 572	695	
									1 987 477 573	642	
							TBR		1 987 477 571	750	
			66-68						1 987 477 575	1700	
							SBR		1 987 477 572	695	
									1 987 477 573	642	
							TBR		1 987 477 571	750	
									1 987 477 575	1700	
<b>2.0 HDi</b>		10.96-03.99	80/97-99/				SBR		1 987 477 572	695	
<b>2.0i Turbo</b>			104-110						1 987 477 573	642	
<b>2.0i 16V</b>									1 987 477 575	1700	
<b>2.1D Turbo</b>		10.96-03.99	80-81				SBR		1 987 477 572	695	
									1 987 477 573	642	
									1 987 477 575	1700	
<b>3.0i</b>		10.96-03.99	140-143				SBR		1 987 477 572	695	
									1 987 477 573	642	
									1 987 477 575	1700	
<b>1.8i</b>		10.96-03.99	66/74-76/						0 265 006 205 <sup>3</sup>		
<b>1.8i 16V</b>			81-82						0 265 006 206 <sup>4</sup>		
<b>1.9D Turbo</b>		10.96-03.99	55/66-68						0 265 006 205 <sup>3</sup>		
									0 265 006 206 <sup>4</sup>		
<b>2.0 HDi, i Turbo, 16V</b>		10.96-03.99	80/97-99/						0 265 006 205 <sup>3</sup>		
			104-110						0 265 006 206 <sup>4</sup>		
<b>2.1D Turbo</b>		10.96-03.99	80-81						0 265 006 205 <sup>3</sup>		
									0 265 006 206 <sup>4</sup>		
<b>3.0i</b>		10.96-03.99	140-143						0 265 006 205 <sup>3</sup>		
									0 265 006 206 <sup>4</sup>		
<b>406 Break [D9]</b>											
<b>1.8i</b>		04.99-06.04	66/74-76/						0 986 473 085	57,11	
<b>1.8i 16V</b>			81/85						0 986 474 085	57,11	
<b>2.0 HDi, HPI, i 16V</b>		04.99-06.04	66/79/80/97/						0 986 473 086	57,11	
			99/100/103						0 986 474 086	57,11	
<b>2.2 HDi</b>		04.99-06.04	98/116						0 986 473 086	57,11	
<b>2.2i 16V</b>									0 986 474 086	57,11	
<b>3.0i</b>		04.99-06.04	140/150						0 986 473 086	57,11	
									0 986 474 086	57,11	
<b>1.8i</b>		04.99-06.04	66/74-76/				BKR,STB		F 026 002 183	20,6	
<b>1.8i 16V</b>			81						F 026 002 184	20,6	
		ABO 04.99-06.04	66/74-76/						F 026 002 244	20,6	
			81						F 026 002 245	20,6	





◀ PEUGEOT 406 Break [D9]

	1.8 i	04.99-06.04	66/74-76/			0986 473 108	← 32,94	1987 470 059 <sup>7</sup>
	1.8 i 16V		81/85			0986 473 108	← 32,94	1987 470 505 <sup>8</sup>
						0986 474 108	→ 32,94	1987 470 059 <sup>7</sup>
	2.0 HDi	04.99-06.04	66/79/80/			0986 473 108	← 32,94	1987 470 059 <sup>7</sup>
	2.0 HPi		97/99/100/			0986 473 108	← 32,94	1987 470 505 <sup>8</sup>
	2.0 i 16V		103			0986 474 108	→ 32,94	1987 470 059 <sup>7</sup>
	2.2 HDi	04.99-06.04	98/116			0986 473 108	← 32,94	1987 470 059 <sup>7</sup>
	2.2 i 16V					0986 473 108	← 32,94	1987 470 505 <sup>8</sup>
						0986 474 108	→ 32,94	1987 470 059 <sup>7</sup>
	3.0 i	04.99-06.04	140/150			0986 473 108	← 32,94	1987 470 059 <sup>7</sup>
						0986 473 108	← 32,94	1987 470 505 <sup>8</sup>
						0986 474 108	→ 32,94	1987 470 059 <sup>7</sup>























































	1.8 i	04.99-05.99	66/74-76/	Org.-Nr. →8210	SBR	1987 477 575		1700
	1.8 i 16V		81		TBR	1987 477 575		1700
		04.99-06.04	66/74-76/		SBR	1987 477 572	← 695	
			81		TBR	1987 477 573	→ 642	
					TBR	1987 477 571	→ 750	
		06.99-05.00	66/74-76/	Org.-Nr. 8211→8574	SBR	1987 477 870		1756
			81		TBR	1987 477 870		1756
		06.00-06.04	66/74-76/	Org.-Nr. 8575→	SBR	1987 477 871		1656
			81		TBR	1987 477 871		1656
	1.8 i 16V	10.00-06.04	85			1987 477 572	← 695	
						1987 477 573	→ 642	
						1987 477 871		1656
	2.0 HDi	04.99-05.99	66	Org.-Nr. →8210	SBR	1987 477 575		1700
		04.99-06.04	66		SBR	1987 477 572	← 695	
						1987 477 573	→ 642	
		06.99-05.00	66	Org.-Nr. 8211→8574	SBR	1987 477 870		1756
		06.00-06.04	66	Org.-Nr. 8575→	SBR	1987 477 871		1656
		08.01-06.04	79		SBR	1987 477 572	← 695	
						1987 477 573	→ 642	
						1987 477 871		1656
	2.0 HDi	04.99-05.99	80/97/99	Org.-Nr. →8210	SBR	1987 477 575		1700
	2.0 i 16V	04.99-06.04	80/97/99		SBR	1987 477 572	← 695	
						1987 477 573	→ 642	
		06.99-05.00	80/97/99	Org.-Nr. 8211→8574	SBR	1987 477 870		1756
		06.00-06.04	80/97/99	Org.-Nr. 8575→	SBR	1987 477 871		1656
	2.0 HPi	10.00-06.04	100/103			1987 477 572	← 695	
	2.0 i 16V					1987 477 573	→ 642	
						1987 477 871		1656
	2.2 HDi	03.00-05.00	98	Org.-Nr. →8574		1987 477 870		1756
		03.00-06.04	98			1987 477 572	← 695	
						1987 477 573	→ 642	
		06.00-06.04	98	Org.-Nr. 8575→		1987 477 871		1656
	2.2 i 16V	04.99-05.99	116	Org.-Nr. →8210	SBR	1987 477 575		1700
		04.99-06.04	116		SBR	1987 477 572	← 695	
						1987 477 573	→ 642	
		06.99-05.00	116	Org.-Nr. 8211→8574	SBR	1987 477 870		1756
		06.00-06.04	116	Org.-Nr. 8575→	SBR	1987 477 871		1656
	3.0 i	04.99-05.99	140	Org.-Nr. →8210	SBR	1987 477 575		1700
		04.99-06.04	140		SBR	1987 477 572	← 695	
						1987 477 573	→ 642	
		06.99-05.00	140	Org.-Nr. 8211→8574	SBR	1987 477 870		1756
		12.99-05.00	150	Org.-Nr. 8211→8574	SBR	1987 477 870		1756
		12.99-06.04	150		SBR	1987 477 572	← 695	
						1987 477 573	→ 642	
		06.00-06.04	140	Org.-Nr. 8575→	SBR	1987 477 871		1656
			150	Org.-Nr. 8575→	SBR	1987 477 871		1656



		S								
	1.8 i	04.99-06.04	66/74-76/				0 265 006 205 <sup>3</sup>			
	1.8 i 16V		81/85				0 265 006 206 <sup>4</sup>			
	2.0 HDi, HPi, i 16V	04.99-06.04	66/79/80/97/				0 265 006 205 <sup>3</sup>			
			99/100/103				0 265 006 206 <sup>4</sup>			
	2.2 HDi	04.99-06.04	98/116				0 265 006 205 <sup>3</sup>			
	2.2 i 16V						0 265 006 206 <sup>4</sup>			
3.0 i	04.99-06.04	140/150				0 265 006 205 <sup>3</sup>				
						0 265 006 206 <sup>4</sup>				
<b>406 Coupé [D8]</b>										
	1.8 i 16V	09.97-03.99	81				0 986 473 085		← 57,11	
							0 986 473 086		← 57,11	
							0 986 474 085		→ 57,11	
							0 986 474 086		→ 57,11	
2.0 i 16V	03.97-03.99	97-99				0 986 473 086		← 57,11		
						0 986 474 086		→ 57,11		
	1.8 i 16V	09.97-03.99	81				0 986 473 108		← 32,94	1 987 470 059 <sup>7</sup>
							0 986 473 108		← 32,94	1 987 470 505 <sup>8</sup>
	2.0 i 16V	03.97-03.99	97-99				0 986 474 108		→ 32,94	1 987 470 059 <sup>7</sup>
							0 986 473 108		← 32,94	1 987 470 059 <sup>7</sup>
	3.0 i	03.97-03.99	140-143				0 986 473 108		← 32,94	1 987 470 505 <sup>8</sup>
							0 986 474 108		→ 32,94	1 987 470 059 <sup>7</sup>
						0 986 473 108		← 32,94	1 987 470 505 <sup>8</sup>	
						0 986 474 108		→ 32,94	1 987 470 059 <sup>7</sup>	
	1.8 i 16V	09.97-03.99	81		SBR		1 987 477 575		1700	
							1 987 477 578		← 706	
							1 987 477 579		→ 652	
	2.0 i 16V	03.97-03.99	97-99		SBR		1 987 477 575		1700	
							1 987 477 578		← 706	
							1 987 477 579		→ 652	
3.0 i	03.97-03.99	140-143		SBR		1 987 477 575		1700		
						1 987 477 578		← 706		
						1 987 477 579		→ 652		
	1.8 i 16V	09.97-03.99	81				0 265 006 205 <sup>3</sup>			
							0 265 006 206 <sup>4</sup>			
	2.0 i 16V	03.97-03.99	97-99				0 265 006 205 <sup>3</sup>			
							0 265 006 206 <sup>4</sup>			
3.0 i	03.97-03.99	140-143				0 265 006 205 <sup>3</sup>				
						0 265 006 206 <sup>4</sup>				
<b>406 Coupé [D9]</b>										
	2.0 i 16V	04.99-02.05	97-99/100				0 986 473 086		← 57,11	
							0 986 474 086		→ 57,11	
	2.2 HDi	03.00-02.05	98	Org.-Nr. 9338→				0 986 473 086		← 57,11
								0 986 474 086		→ 57,11
2.2 i 16V	03.02-02.05	116				0 986 473 086		← 57,11		
						0 986 474 086		→ 57,11		



◀ PEUGEOT 406 Coupé [D9]											
	2.0 i 16V	04.99-02.05	97-99/100			0986 473 108	↻ ← 32,94	1987 470 059 <sup>7</sup>			
						0986 473 108	↻ ← 32,94	1987 470 505 <sup>8</sup>			
						0986 474 108	↻ → 32,94	1987 470 059 <sup>7</sup>			
	2.2 HDi	03.00-02.05	98/116			0986 473 108	↻ ← 32,94	1987 470 059 <sup>7</sup>			
						0986 473 108	↻ ← 32,94	1987 470 505 <sup>8</sup>			
						0986 474 108	↻ → 32,94	1987 470 059 <sup>7</sup>			
3.0 i	04.99-02.05	140/150			0986 473 108	↻ ← 32,94	1987 470 059 <sup>7</sup>				
					0986 473 108	↻ ← 32,94	1987 470 505 <sup>8</sup>				
					0986 474 108	↻ → 32,94	1987 470 059 <sup>7</sup>				
	2.0 i 16V	04.99-05.99	97-99	Org.-Nr. →8210	SBR	1987 477 575		1700			
		04.99-02.05	97-99		SBR	1987 477 578	← 706				
						1987 477 579	→ 652				
		06.99-05.00	97-99	Org.-Nr. 8211→8574	SBR	1987 477 870		1756			
		06.00-02.05	97-99	Org.-Nr. 8575→	SBR	1987 477 871		1656			
		10.00-02.05	100			1987 477 578	← 706				
					1987 477 579	→ 652					
					1987 477 871		1656				
	2.2 HDi	03.00-05.00	98	Org.-Nr. →8574			1987 477 870		1756		
					03.00-02.05	98			1987 477 578	← 706	
							1987 477 579	→ 652			
					06.00-02.05	98	Org.-Nr. 8575→		1656		
2.2 i 16V	03.02-02.05	116			1987 477 575		1700				
					1987 477 578	← 706					
					1987 477 579	→ 652					
3.0 i	04.99-05.99	140	Org.-Nr. →8210	SBR	1987 477 575		1700				
					04.99-02.05	140			1987 477 578	← 706	
					1987 477 579	→ 652					
	06.99-05.00	140	Org.-Nr. 8211→8574	SBR	1987 477 870		1756				
	12.99-05.00	150	Org.-Nr. 8211→8574	SBR	1987 477 870		1756				
	12.99-02.05	150			1987 477 578	← 706					
				06.00-02.05	140	Org.-Nr. 8575→		1656			
		150	Org.-Nr. 8575→	SBR	1987 477 871		1656				
	2.0 i 16V	04.99-02.05	97-99/100			0265 006 205 <sup>3</sup>					
						0265 006 206 <sup>4</sup>					
	2.2 HDi	03.00-02.05	98/116			0265 006 205 <sup>3</sup>					
	2.2 i 16V					0265 006 206 <sup>4</sup>					
	3.0 i	04.99-02.05	140/150			0265 006 205 <sup>3</sup>					
					0265 006 206 <sup>4</sup>						
406 [D8]											
	1.6 i	10.95-03.99	65			0986 474 085	↻ → 57,11				
		01.96-03.99	65			0986 473 085	↻ ← 57,11				
	1.8 i	12.95-03.99	74-76			0986 474 085	↻ → 57,11				
				01.96-03.99	74-76			0986 473 085	↻ ← 57,11		
				09.97-03.99	66			0986 473 085	↻ ← 57,11		
						0986 474 085	↻ → 57,11				
	1.8 i 16V	10.95-03.99	81-82			0986 474 085	↻ → 57,11				
				01.96-03.99	81-82			0986 473 085	↻ ← 57,11		
	1.9 D Turbo	12.95-03.99	66-68			0986 473 086	↻ ← 57,11				
						0986 474 086	↻ → 57,11				
				06.96-03.99	55			0986 473 085	↻ ← 57,11		
						0986 474 085	↻ → 57,11				
2.0 HDi, i Turbo, i 16V	10.95-03.99	80/97-99/ 104-110			0986 473 086	↻ ← 57,11					
					0986 474 086	↻ → 57,11					

		S							
2.1 D Turbo		12.95-03.99	80-81				0 986 473 086	 57,11	
							0 986 474 086	 57,11	
3.0 i		08.96-03.99	140-143				0 986 473 086	 57,11	
							0 986 474 086	 57,11	
									
	1.6 i	10.95-01.96	65	Org.-Nr. →7027			F 026 002 244	 20,6	
							F 026 002 245	 20,6	
		10.95-03.99	65		BKR		F 026 002 183	 20,6	
							F 026 002 184	 20,6	
	1.8 i	09.97-03.99	66		BKR		F 026 002 183	 20,6	
							F 026 002 184	 20,6	
	1.8 i	10.95-01.96	74-76/ 81-82	Org.-Nr. →7027			F 026 002 244	 20,6	
	1.8 i 16V						F 026 002 245	 20,6	
		10.95-03.99	74-76/ 81-82		BKR		F 026 002 183	 20,6	
							F 026 002 184	 20,6	
	1.9 D Turbo	12.95-01.96	66-68	Org.-Nr. →7027			F 026 002 244	 20,6	
							F 026 002 245	 20,6	
		12.95-03.99	66-68		BKR		F 026 002 183	 20,6	
							F 026 002 184	 20,6	
		06.96-03.99	55		BKR		F 026 002 183	 20,6	
							F 026 002 184	 20,6	
	2.0 HDi	10.95-03.99	80/97-99/ 104-110				0 986 473 108	 32,94	1 987 470 059 <sup>7</sup>
	2.0 i Turbo						0 986 473 108	 32,94	1 987 470 505 <sup>8</sup>
	2.0 i 16V						0 986 474 108	 32,94	1 987 470 059 <sup>7</sup>
	2.1 D Turbo	12.95-03.99	80-81				0 986 473 108	 32,94	1 987 470 059 <sup>7</sup>
								0 986 473 108	 32,94
							0 986 474 108	 32,94	1 987 470 059 <sup>7</sup>
	3.0 i	08.96-03.99	140-143				0 986 473 108	 32,94	1 987 470 059 <sup>7</sup>
							0 986 473 108	 32,94	1 987 470 505 <sup>8</sup>
							0 986 474 108	 32,94	1 987 470 059 <sup>7</sup>
									
	1.6 i	10.95-03.99	65		TBR		1 987 477 571	 750	
							1 987 477 575	1700	
	1.8 i	10.95-03.99	66/74-76/ 81-82		TBR		1 987 477 571	 750	
	1.8 i 16V						1 987 477 575	1700	
	1.9 D Turbo	12.95-03.99	55/66-68		TBR		1 987 477 571	 750	
							1 987 477 575	1700	
	2.0 HDi	10.95-03.99	80/97-99/ 104-110		SBR		1 987 477 572	 695	
	2.0 i Turbo						1 987 477 573	 642	
	2.0 i 16V						1 987 477 575	1700	
	2.1 D Turbo	12.95-03.99	80-81		SBR		1 987 477 572	 695	
							1 987 477 573	 642	
							1 987 477 575	1700	
	3.0 i	08.96-03.99	140-143		SBR		1 987 477 572	 695	
							1 987 477 573	 642	
							1 987 477 575	1700	
	1.6 i	10.95-03.99	65				0 265 006 205 <sup>3</sup>		
							0 265 006 206 <sup>4</sup>		
	1.8 i	10.95-03.99	66/74-76/ 81-82				0 265 006 205 <sup>3</sup>		
	1.8 i 16V						0 265 006 206 <sup>4</sup>		
	1.9 D Turbo	12.95-03.99	55/66-68				0 265 006 205 <sup>3</sup>		
							0 265 006 206 <sup>4</sup>		
	2.0 HDi, i Turbo, i 16V	10.95-03.99	80/97-99/ 104-110				0 265 006 205 <sup>3</sup>		
							0 265 006 206 <sup>4</sup>		
	2.1 D Turbo	12.95-03.99	80-81				0 265 006 205 <sup>3</sup>		
							0 265 006 206 <sup>4</sup>		
	3.0 i	08.96-03.99	140-143				0 265 006 205 <sup>3</sup>		
							0 265 006 206 <sup>4</sup>		







◀ PEUGEOT

406 [D9]



	1.6 i	04.99-06.04	65		0986 473 085		← 57,11	
					0986 474 085		→ 57,11	
	1.8 i	04.99-06.04	66/74-76/		0986 473 085		← 57,11	
	1.8 i 16V		81-82/85		0986 474 085		→ 57,11	
	2.0 HDi, HPI, i 16V	04.99-06.04	66/79/80/97/		0986 473 086		← 57,11	
			99/100/103		0986 474 086		→ 57,11	
	2.2 HDi	04.99-06.04	98/116		0986 473 086		← 57,11	
	2.2 i 16V				0986 474 086		→ 57,11	
3.0 i	04.99-06.04	140-143/		0986 473 086		← 57,11		
		150		0986 474 086		→ 57,11		



	1.6 i	04.99-06.04	65	BKR	F 026 002 183		← 20,6	
					F 026 002 184		→ 20,6	
		ABO 04.99-06.04	65		F 026 002 244		← 20,6	
					F 026 002 245		→ 20,6	
	1.8 i	04.99-06.04	66/74-76/	BKR	F 026 002 183		← 20,6	
	1.8 i 16V		81-82		F 026 002 184		→ 20,6	
		ABO 04.99-06.04	66/74-76/		F 026 002 244		← 20,6	
			81-82		F 026 002 245		→ 20,6	
	2.0 i 16V	08.00-06.04	100		F 026 002 244		← 20,6	
					F 026 002 245		→ 20,6	
				BKR	F 026 002 183		← 20,6	
					F 026 002 184		→ 20,6	

	1.8 i 16V	10.00-06.04	85		0986 473 108		← 32,94	1987 470 059 <sup>7</sup>
					0986 473 108		← 32,94	1987 470 505 <sup>8</sup>
					0986 474 108		→ 32,94	1987 470 059 <sup>7</sup>
	2.0 HDi	04.99-06.04	66/79/80/		0986 473 108		← 32,94	1987 470 059 <sup>7</sup>
	2.0 HPI		97/99/100/		0986 473 108		← 32,94	1987 470 505 <sup>8</sup>
	2.0 i 16V		103		0986 474 108		→ 32,94	1987 470 059 <sup>7</sup>
	2.2 HDi	04.99-06.04	98/116		0986 473 108		← 32,94	1987 470 059 <sup>7</sup>
	2.2 i 16V				0986 473 108		← 32,94	1987 470 505 <sup>8</sup>
					0986 474 108		→ 32,94	1987 470 059 <sup>7</sup>
	3.0 i	04.99-06.04	140-143/		0986 473 108		← 32,94	1987 470 059 <sup>7</sup>
			150		0986 473 108		← 32,94	1987 470 505 <sup>8</sup>
					0986 474 108		→ 32,94	1987 470 059 <sup>7</sup>



	1.6 i	04.99-05.99	65	Org.-Nr. →8210	TBR	1987 477 575	1700	
		04.99-06.04	65		TBR	1987 477 571	→ 750	
		06.99-05.00	65	Org.-Nr. 8211→8574	TBR	1987 477 870	1756	
		06.00-06.04	65	Org.-Nr. 8575→	TBR	1987 477 871	1656	
	1.8 i	04.99-05.99	66/74-76/	Org.-Nr. →8210	TBR	1987 477 575	1700	
	1.8 i 16V		81-82					
		04.99-06.04	66/74-76/		TBR	1987 477 571	→ 750	
			81-82					
		06.99-05.00	66/74-76/	Org.-Nr. 8211→8574	TBR	1987 477 870	1756	
			81-82					
		06.00-06.04	66/74-76/	Org.-Nr. 8575→	TBR	1987 477 871	1656	
			81-82					
	1.8 i 16V	10.00-06.04	85			1987 477 572	← 695	
						1987 477 573	→ 642	
						1987 477 871	1656	
	2.0 HDi	04.99-05.99	66	Org.-Nr. →8210	SBR	1987 477 575	1700	
		04.99-06.04	66		SBR	1987 477 572	← 695	
						1987 477 573	→ 642	
	06.99-05.00	66	Org.-Nr. 8211→8574	SBR	1987 477 870	1756		

		S											
2.0 HDi		06.00-06.04	66	Org.-Nr. 8575→	SBR	1 987 477 871	1656						
								08.01-06.04	79	SBR	1 987 477 572	← 695	
											1 987 477 573	→ 642	
											1 987 477 871	1656	
2.0 HDi		04.99-05.99	80/97/99	Org.-Nr. →8210	SBR	1 987 477 575	1700						
2.0 i 16V		04.99-06.04	80/97/99		SBR	1 987 477 572	← 695						
											1 987 477 573	→ 642	
								06.99-05.00	80/97/99	Org.-Nr. 8211→8574	SBR	1 987 477 870	1756
								06.00-06.04	80/97/99	Org.-Nr. 8575→	SBR	1 987 477 871	1656
2.0 HPi		08.00-06.04	100/103			1 987 477 572	← 695						
2.0 i 16V						1 987 477 573	→ 642						
											1 987 477 871	1656	
											1 987 477 871	1656	
2.2 HDi		03.00-05.00	98	Org.-Nr. →8574		1 987 477 870	1756						
		03.00-06.04	98			1 987 477 572	← 695						
2.2 i 16V		06.00-06.04	98	Org.-Nr. 8575→		1 987 477 871	1656						
								04.99-05.99	116	Org.-Nr. →8210	SBR	1 987 477 575	1700
								04.99-06.04	116		SBR	1 987 477 572	← 695
											1 987 477 573	→ 642	
		06.99-05.00	116	Org.-Nr. 8211→8574	SBR	1 987 477 870	1756						
								06.00-06.04	116	Org.-Nr. 8575→	SBR	1 987 477 871	1656
								04.99-05.99	140-143	Org.-Nr. →8210	SBR	1 987 477 575	1700
								04.99-06.04	140-143		SBR	1 987 477 572	← 695
3.0 i						1 987 477 573	→ 642						
								06.99-05.00	140-143	Org.-Nr. 8211→8574	SBR	1 987 477 870	1756
								12.99-05.00	150	Org.-Nr. 8211→8574	SBR	1 987 477 870	1756
								12.99-06.04	150		SBR	1 987 477 572	← 695
		06.00-06.04	140-143	Org.-Nr. 8575→	SBR	1 987 477 871	1656						
			150	Org.-Nr. 8575→	SBR	1 987 477 871	1656						
	1.6 i	04.99-06.04	65			0 265 006 205 <sup>3</sup>							
						0 265 006 206 <sup>4</sup>							
						1.8 i	04.99-06.04	66/74-76/	0 265 006 205 <sup>3</sup>				
								81-82/85	0 265 006 206 <sup>4</sup>				
						2.0 HDi, HPi, i 16V	04.99-06.04	66/79/80/97/	0 265 006 205 <sup>3</sup>				
								99/100/103	0 265 006 206 <sup>4</sup>				
						2.2 HDi	04.99-06.04	98/116	0 265 006 205 <sup>3</sup>				
2.2 i 16V			0 265 006 206 <sup>4</sup>										
3.0 i	04.99-06.04	140-143/	0 265 006 205 <sup>3</sup>										
		150	0 265 006 206 <sup>4</sup>										
<b>407 Coupé [D2]</b>													
	2.0 HDi 16V	07.09-12.11	100-110/	120		0 986 134 269		←					
						0 986 135 269		→					
	2.0 HDi	07.07-12.11	100-110/	120		0 986 134 227		←					
						0 986 135 227		→					
	2.2	10.05-06.09	120	0 986 134 227		←							
				0 986 135 227		→							
2.7 HDi	10.05-06.09	150	0 986 134 227		←								
			0 986 135 227		→								
3.0	10.05-12.11	155/177	0 986 134 227		←								
3.0 HDi 24V			0 986 135 227		→								
	2.0 HDi	07.07-06.09	100-110/120			1 987 477 994		↔	2155				
	2.0 HDi 16V	07.09-12.11	100-110/120			1 987 477 994		↔	2155				
	2.2	10.05-06.09	120			1 987 477 994		↔	2155				





	◀ PEUGEOT 407 Coupé [D2]						
	2.7 HDi	10.05-06.09	150			1987 477 994	↔ 2155
	3.0	10.05-06.09	155/177			1987 477 994	↔ 2155
	3.0 HDi 24V	07.09-12.11	155/177			1987 477 994	↔ 2155

	2.0 HDi	07.07-11.08	100-103	Org.-Nr. →11682		0986 594 522 <sup>3</sup>	
		12.08-06.09	100-103	Org.-Nr. 11683→		0986 594 523 <sup>4</sup>	
						0986 594 562 <sup>4</sup>	
						0986 594 567 <sup>3</sup>	
	2.0 HDi 16V	07.09-12.11	100-110/ 120			0986 594 562 <sup>4</sup>	
						0986 594 567 <sup>3</sup>	
	2.2	10.05-10.07	120	Org.-Nr. →11283		0986 594 520 <sup>3</sup>	
		11.07-11.08	120	Org.-Nr. 11284→11682		0986 594 521 <sup>4</sup>	
		12.08-06.09	120	Org.-Nr. 11683→		0986 594 523 <sup>3</sup>	
						0986 594 524 <sup>4</sup>	
						0986 594 562 <sup>4</sup>	
						0986 594 567 <sup>3</sup>	
	2.7 HDi	10.05-10.07	150	Org.-Nr. →11283		0986 594 520 <sup>3</sup>	
		11.07-11.08	150	Org.-Nr. 11284→11682		0986 594 521 <sup>4</sup>	
		12.08-06.09	150	Org.-Nr. 11683→		0986 594 523 <sup>3</sup>	
						0986 594 524 <sup>4</sup>	
						0986 594 562 <sup>4</sup>	
						0986 594 567 <sup>3</sup>	
	3.0	10.05-10.07	155	Org.-Nr. →11283		0986 594 520 <sup>3</sup>	
		11.07-11.08	155	Org.-Nr. 11284→11682		0986 594 521 <sup>4</sup>	
		12.08-06.09	155	Org.-Nr. 11683→		0986 594 523 <sup>3</sup>	
						0986 594 524 <sup>4</sup>	
						0986 594 562 <sup>4</sup>	
						0986 594 567 <sup>3</sup>	
	3.0 HDi 24V	07.09-12.11	177			0986 594 520 <sup>3</sup>	
						0986 594 523 <sup>3</sup>	
						0986 594 524 <sup>4</sup>	
						0986 594 562 <sup>4</sup>	
						0986 594 567 <sup>3</sup>	

**407 [D2]**

	1.6 HDi	05.04-02.11	80			0986 473 472	← 57			
						0986 474 472	→ 57			
	1.8	05.04-02.11	85/92			0986 473 472	← 57			
					0986 474 472	→ 57				
	2.0	05.04-11.05	100			0986 473 472	← 57			
					0986 474 472	→ 57				
				10.05-02.11	103			0986 473 472	← 57	
								0986 474 472	→ 57	
	2.0 HDi	05.04-02.11	100-103			0986 473 472	← 57			
					0986 474 472	→ 57				
							304	0986 134 269	←	
								0986 135 269	→	
					11.09-02.11	110/120			0986 134 269	←
									0986 135 269	→

	1.6 HDi	05.04-02.11	80			0986 134 227	←
						0986 135 227	→
	1.8	05.04-02.11	85/92			0986 134 227	←
					0986 135 227	→	
	2.0	05.04-02.11	100-103/ 110/120			0986 134 227	←
					0986 135 227	→	
	2.0 HDi					0986 135 227	→
	2.2	05.04-07.10	116/ 120-125			0986 134 227	←
					0986 135 227	→	
	2.2 HDi					0986 135 227	→
	2.7 HDi	09.06-06.09	150			0986 134 227	←
					0986 135 227	→	
	3.0	05.04-12.06	155			0986 134 227	←
					0986 135 227	→	

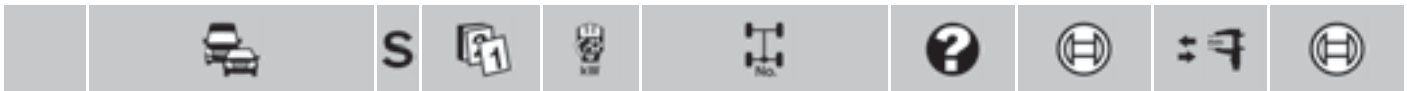

**407 SW [D2]**

	1.6 HDi	05.04-02.11	80		1 987 477 994	↔ 2155
	1.8	05.04-02.11	85/92		1 987 477 994	↔ 2155
	2.0	05.04-02.11	100-103/110/120		1 987 477 994	↔ 2155
	2.0 HDi	05.04-02.11	100-103/110/120		1 987 477 994	↔ 2155
	2.2	05.04-06.09	116/120-125		1 987 477 994	↔ 2155
	2.2 HDi	05.06-07.10	116/120-125		1 987 477 994	↔ 2155
	2.7 HDi	09.06-06.09	150		1 987 477 994	↔ 2155
3.0	05.04-12.06	155		1 987 477 994	↔ 2155	

	1.6 HDi	05.04-04.07	80	Org.-Nr. →11101	0 986 594 520 <sup>3</sup>	
					0 986 594 521 <sup>4</sup>	
		05.07-11.08	80	Org.-Nr. 11102→11682	0 986 594 522 <sup>3</sup>	
				0 986 594 523 <sup>4</sup>		
		12.08-02.11	80	Org.-Nr. 11683→	0 986 594 562 <sup>4</sup>	
					0 986 594 567 <sup>3</sup>	
	1.8	05.04-10.05	85		0 986 594 520 <sup>3</sup>	
					0 986 594 521 <sup>4</sup>	
		10.05-04.07	92	Org.-Nr. →11101	0 986 594 520 <sup>3</sup>	
					0 986 594 521 <sup>4</sup>	
		05.07-11.08	92	Org.-Nr. 11102→11682	0 986 594 522 <sup>3</sup>	
					0 986 594 523 <sup>4</sup>	
		12.08-02.11	92	Org.-Nr. 11683→	0 986 594 562 <sup>4</sup>	
					0 986 594 567 <sup>3</sup>	
	2.0	05.04-11.05	100		0 986 594 520 <sup>3</sup>	
					0 986 594 521 <sup>4</sup>	
	2.0 2.0 HDi	05.04-04.07	100-103	Org.-Nr. →11101	0 986 594 520 <sup>3</sup>	
					0 986 594 521 <sup>4</sup>	
		05.07-11.08	100-103	Org.-Nr. 11102→11682	0 986 594 522 <sup>3</sup>	
					0 986 594 523 <sup>4</sup>	
		12.08-02.11	100-103	Org.-Nr. 11683→	0 986 594 562 <sup>4</sup>	
					0 986 594 567 <sup>3</sup>	
	2.0 HDi	11.09-02.11	110/120		0 986 594 562 <sup>4</sup>	
					0 986 594 567 <sup>3</sup>	
	2.2	05.04-10.05	116		0 986 594 520 <sup>3</sup>	
					0 986 594 521 <sup>4</sup>	
	2.2 2.2 HDi	10.05-04.07	120-125	Org.-Nr. →11101	0 986 594 520 <sup>3</sup>	
					0 986 594 521 <sup>4</sup>	
05.07-11.08		120-125	Org.-Nr. 11102→11682	0 986 594 522 <sup>3</sup>		
				0 986 594 523 <sup>4</sup>		
	12.08-07.10	120-125	Org.-Nr. 11683→	0 986 594 562 <sup>4</sup>		
				0 986 594 567 <sup>3</sup>		
2.7 HDi	09.06-04.07	150	Org.-Nr. →11101	0 986 594 520 <sup>3</sup>		
				0 986 594 521 <sup>4</sup>		
	05.07-11.08	150	Org.-Nr. 11102→11682	0 986 594 522 <sup>3</sup>		
				0 986 594 523 <sup>4</sup>		
	12.08-06.09	150	Org.-Nr. 11683→	0 986 594 562 <sup>4</sup>		
				0 986 594 567 <sup>3</sup>		
3.0	05.04-12.06	155		0 986 594 520 <sup>3</sup>		
				0 986 594 521 <sup>4</sup>		

**407 SW [D2]**

	1.6 HDi	05.04-02.11	80		0 986 473 472	👁️ ← 57
					0 986 474 472	👁️ → 57
	1.8	05.04-02.11	85/92		0 986 473 472	👁️ ← 57
					0 986 474 472	👁️ → 57
	2.0	05.04-11.05	100		0 986 473 472	👁️ ← 57
					0 986 474 472	👁️ → 57
					0 986 473 472	👁️ ← 57
					0 986 474 472	👁️ → 57
		10.05-02.11	103		0 986 473 472	👁️ ← 57
					0 986 474 472	👁️ → 57



		S							
	◀ PEUGEOT 407 SW [D2]								
2.0 HDi	05.04-02.11	100-103					0986 473 472		← 57
							0986 474 472		→ 57
			304				0986 134 269		←
							0986 135 269		→
	11.09-02.11	110/120					0986 134 269		←
							0986 135 269		→
	1.6 HDi	05.04-02.11	80				0986 134 227		←
							0986 135 227		→
	1.8	05.04-02.11	85/92				0986 134 227		←
							0986 135 227		→
	2.0	05.04-02.11	100-103/				0986 134 227		←
	2.0 HDi		110/120				0986 135 227		→
	2.2	05.04-07.10	116/				0986 134 227		←
	2.2 HDi		120-125				0986 135 227		→
	2.7 HDi	09.06-06.09	150				0986 134 227		←
							0986 135 227		→
	3.0	05.04-12.06	155				0986 134 227		←
							0986 135 227		→
	1.6 HDi	05.04-02.11	80				1987 477 994		↔ 2155
	1.8	05.04-02.11	85/92				1987 477 994		↔ 2155
	2.0	05.04-02.11	100-103/110/120				1987 477 994		↔ 2155
	2.0 HDi	05.04-02.11	100-103/110/120				1987 477 994		↔ 2155
	2.2	05.04-06.09	116/120-125				1987 477 994		↔ 2155
	2.2 HDi	09.06-07.10	116/120-125				1987 477 994		↔ 2155
	2.7 HDi	09.06-06.09	150				1987 477 994		↔ 2155
	3.0	05.04-12.06	155				1987 477 994		↔ 2155
	1.6 HDi	05.04-04.07	80	Org.-Nr. →11101			0986 594 520 <sup>3</sup>		
							0986 594 521 <sup>4</sup>		
		05.07-11.08	80	Org.-Nr. 11102→11682			0986 594 522 <sup>3</sup>		
							0986 594 523 <sup>4</sup>		
		12.08-02.11	80	Org.-Nr. 11683→			0986 594 562 <sup>4</sup>		
							0986 594 567 <sup>3</sup>		
	1.8	05.04-10.05	85				0986 594 520 <sup>3</sup>		
							0986 594 521 <sup>4</sup>		
		10.05-04.07	92	Org.-Nr. →11101			0986 594 520 <sup>3</sup>		
							0986 594 521 <sup>4</sup>		
		05.07-11.08	92	Org.-Nr. 11102→11682			0986 594 522 <sup>3</sup>		
							0986 594 523 <sup>4</sup>		
		12.08-02.11	92	Org.-Nr. 11683→			0986 594 562 <sup>4</sup>		
							0986 594 567 <sup>3</sup>		
	2.0	05.04-11.05	100				0986 594 520 <sup>3</sup>		
							0986 594 521 <sup>4</sup>		
	2.0	05.04-04.07	100-103	Org.-Nr. →11101			0986 594 520 <sup>3</sup>		
	2.0 HDi						0986 594 521 <sup>4</sup>		
		05.07-11.08	100-103	Org.-Nr. 11102→11682			0986 594 522 <sup>3</sup>		
							0986 594 523 <sup>4</sup>		
		12.08-02.11	100-103	Org.-Nr. 11683→			0986 594 562 <sup>4</sup>		
							0986 594 567 <sup>3</sup>		
	2.0 HDi	11.09-02.11	110/120				0986 594 562 <sup>4</sup>		
							0986 594 567 <sup>3</sup>		
	2.2	05.04-10.05	116				0986 594 520 <sup>3</sup>		
							0986 594 521 <sup>4</sup>		
	2.2	10.05-04.07	120-125	Org.-Nr. →11101			0986 594 520 <sup>3</sup>		
	2.2 HDi						0986 594 521 <sup>4</sup>		
		05.07-11.08	120-125	Org.-Nr. 11102→11682			0986 594 522 <sup>3</sup>		
							0986 594 523 <sup>4</sup>		

		S							
2.2		12.08-07.10	120-125	Org.-Nr. 11683→			0 986 594 562 <sup>4</sup>		
2.2 HDi							0 986 594 567 <sup>3</sup>		
2.7 HDi		09.06-04.07	150	Org.-Nr. →11101			0 986 594 520 <sup>3</sup>		
		05.07-11.08	150	Org.-Nr. 11102→11682			0 986 594 521 <sup>4</sup>		
		12.08-06.09	150	Org.-Nr. 11683→			0 986 594 523 <sup>3</sup>		
							0 986 594 524 <sup>4</sup>		
3.0		05.04-12.06	155				0 986 594 562 <sup>4</sup>		
							0 986 594 567 <sup>3</sup>		
							0 986 594 520 <sup>3</sup>		
							0 986 594 521 <sup>4</sup>		
<b>508 SW [W2]</b>									
	1.6 HDi	10.10-10.11	82/85/88/ 110/115/120	Org.-Nr. →12760	FEB		1 987 482 373	↔ 2238	
	1.6 THP	11.10-10.11	82/85/88/ 110/115/120	Org.-Nr. →12760	FEB		1 987 482 373	↔ 2238	
	1.6 VTi	10.10-10.11	82/85/88/ 110/115/120	Org.-Nr. →12760	FEB		1 987 482 373	↔ 2238	
	2.0 HDi	10.10-10.11	100-103/ 120	Org.-Nr. →12760	FEB		1 987 482 373	↔ 2238	
	2.2 HDi	10.10-10.11	150	Org.-Nr. →12760	FEB		1 987 482 373	↔ 2238	
<b>508 [W2]</b>									
	1.6 HDi	10.10-10.11	82/85/88/ 110/115/120	Org.-Nr. →12760	FEB		1 987 482 373	↔ 2238	
	1.6 i THP	05.11-10.11	82/85/88/ 110/115/120	Org.-Nr. →12760	FEB		1 987 482 373	↔ 2238	
	1.6 THP	11.10-10.11	82/85/88/ 110/115/120	Org.-Nr. →12760	FEB		1 987 482 373	↔ 2238	
	1.6 VTi	10.10-10.11	82/85/88/ 110/115/120	Org.-Nr. →12760	FEB		1 987 482 373	↔ 2238	
	2.0 HDi	10.10-10.11	100-103/ 120	Org.-Nr. →12760	FEB		1 987 482 373	↔ 2238	
	2.2 HDi	10.10-10.11	150	Org.-Nr. →12760	FEB		1 987 482 373	↔ 2238	
<b>605 [Y30]</b>									
	2.0	06.89-05.99	79-81/84/ 89-90/94	Fg.-Nr. →90807683	BSY				0 204 104 056 <sup>7</sup>
	2.0 i			Fg.-Nr. 90807684→	BSY	0 204 102 267	← 57		0 204 104 056 <sup>7</sup>
						0 204 103 267			
						0 204 102 268	→ 57		0 204 104 056 <sup>7</sup>
						0 204 103 268			
	2.0 i Turbo	07.92-06.94	104	Fg.-Nr. →90807683	BSY				0 204 104 056 <sup>7</sup>
				Fg.-Nr. 90807684→	BSY	0 204 102 267	← 57		0 204 104 056 <sup>7</sup>
						0 204 103 267			
						0 204 102 268	→ 57		0 204 104 056 <sup>7</sup>
						0 204 103 268			
		07.94-05.99	104-110	Fg.-Nr. 90807684→	BSY	0 204 102 267	← 57		0 204 104 056 <sup>7</sup>
						0 204 103 267			
						0 204 102 268	→ 57		0 204 104 056 <sup>7</sup>
						0 204 103 268			
	2.0 i 16V	07.94-05.99	97-99	Fg.-Nr. 90807684→	BSY	0 204 102 267	← 57		0 204 104 056 <sup>7</sup>
						0 204 103 267			
						0 204 102 268	→ 57		0 204 104 056 <sup>7</sup>
						0 204 103 268			
	2.1 D	06.89-10.96	60-61/ 80-81	Fg.-Nr. →90807683	BSY				0 204 104 056 <sup>7</sup>
	2.1 D Turbo								



<b>PEUGEOT 605 [Y30]</b>								
	2.1 D	06.89-05.99	60-61/	Fg.-Nr. 90807684→	BSY	0 204 102 267	← 57	0 204 104 056 <sup>7</sup>
	2.1 D Turbo		80-81			0 204 103 267		
						0 204 102 268	→ 57	0 204 104 056 <sup>7</sup>
						0 204 103 268		
	2.5 D Turbo	07.94-05.99	94-96			0 204 102 287	← 57	0 204 104 056 <sup>7</sup>
						0 986 473 411		
						0 204 102 288	→ 57	0 204 104 056 <sup>7</sup>
						0 986 474 411		
	3.0 i	07.93-05.99	123-125	Fg.-Nr. →90807683	BSY			0 204 104 056 <sup>7</sup>
				Fg.-Nr. 90807684→	BSY	0 204 102 267	← 57	0 204 104 056 <sup>7</sup>
						0 204 103 267		
						0 204 102 268	→ 57	0 204 104 056 <sup>7</sup>
						0 204 103 268		
		03.97-05.99	140-143		BSY	0 204 102 647	← 57	1 987 470 505 <sup>8</sup>
						0 204 103 647		
						0 204 102 648	→ 57	1 987 470 505 <sup>8</sup>
						0 204 103 648		
	3.0 i 24V	07.93-05.99	147	Fg.-Nr. →90807683	BSY			0 204 104 056 <sup>7</sup>
	2.0, i, i Turbo, i 16V	06.89-05.99	79-81/84/89-90/94/ 97-99/104-110			0 986 473 869	← 33	
						0 986 473 870	→ 33	
	2.1 D	06.89-05.99	60-61/			0 986 473 869	← 33	
	2.1 D Turbo		80-81			0 986 473 870	→ 33	
	2.5 D Turbo	07.94-05.99	94-96			0 986 473 869	← 33	
						0 986 473 870	→ 33	
	3.0 i	07.93-05.99	123-125/			0 986 473 869	← 33	
	3.0 i 24V		140-143/147			0 986 473 870	→ 33	
	2.0, i, i Turbo, i 16V	06.89-05.99	79-81/84/89-90/ 94/97-99/ 104-110			1 987 477 566	← 743	
						1 987 477 567	→ 635	
						1 987 477 688	1638	
	2.1 D	06.89-05.99	60-61/			1 987 477 566	← 743	
	2.1 D Turbo		80-81			1 987 477 567	→ 635	
						1 987 477 688	1638	
	2.5 D Turbo	07.94-05.99	94-96			1 987 477 566	← 743	
						1 987 477 567	→ 635	
						1 987 477 688	1638	
	3.0 i	07.93-05.99	123-125/			1 987 477 566	← 743	
	3.0 i 24V		140-143/ 147			1 987 477 567	→ 635	
						1 987 477 688	1638	
	2.0, i, i Turbo, i 16V	06.89-05.99	79-81/84/89-90/ 94/97-99/104-110		BO	0 265 006 207 <sup>3</sup>		
						0 265 006 208 <sup>4</sup>		
	2.1 D	06.89-05.99	60-61/		BO	0 265 006 207 <sup>3</sup>		
	2.1 D Turbo		80-81			0 265 006 208 <sup>4</sup>		
	2.5 D Turbo	07.94-05.99	94-96		BO	0 265 006 207 <sup>3</sup>		
						0 265 006 208 <sup>4</sup>		
	3.0 i	07.93-05.99	123-125/		BO	0 265 006 207 <sup>3</sup>		
	3.0 i 24V		140-143/147			0 265 006 208 <sup>4</sup>		
<b>607 [Z8]</b>								
	2.0 HDi	03.00-11.04	79/80/100					1 987 470 059 <sup>7</sup>
	2.0 i 16V							1 987 470 505 <sup>8</sup>
	2.2 HDi	03.00-11.04	98/116					1 987 470 059 <sup>7</sup>
	2.2 i 16V							1 987 470 505 <sup>8</sup>
	3.0 i	03.00-11.04	152-154					1 987 470 059 <sup>7</sup>
								1 987 470 505 <sup>8</sup>



		S							
	2.0 HDi	03.00-11.04	79/80/100				1 987 477 592	2145	
	2.0 i 16V						1 987 477 593	← 724	
							1 987 477 594	→ 713	
	2.2 HDi	03.00-11.04	98/116				1 987 477 592	2145	
	2.2 i 16V						1 987 477 593	← 724	
							1 987 477 594	→ 713	
	3.0 i	03.00-11.04	152-154				1 987 477 592	2145	
							1 987 477 593	← 724	
							1 987 477 594	→ 713	
	2.0 HDi	03.00-11.04	79/80/100				0 265 006 544 <sup>3</sup>		
	2.0 i 16V						0 265 006 545 <sup>4</sup>		
	2.2 HDi	03.00-11.04	98/116				0 265 006 544 <sup>3</sup>		
	2.2 i 16V						0 265 006 545 <sup>4</sup>		
	3.0 i	03.00-11.04	152-154				0 265 006 544 <sup>3</sup>		
							0 265 006 545 <sup>4</sup>		
<b>607 [Z9]</b>									
	2.0 HDi	12.04-12.09	79/100				1 987 477 592	2145	
	2.2, HDi	12.04-04.09	98/116/120/125				1 987 477 592	2145	
	2.7 HDi	12.04-12.10	150				1 987 477 592	2145	
	3.0	12.04-01.09	155				1 987 477 592	2145	
<b>806 [U60]</b>									
	1.8 i	07.95-08.02	73			BSY	0 204 102 521	← 57	0 204 100 316 <sup>B</sup>
							0 204 103 521		0 204 104 177 <sup>7</sup>
							0 204 102 523	→ 57	0 204 100 316 <sup>B</sup>
							0 204 103 523		
	GIR	0 986 473 115		← 57,11					
		0 986 474 115		→ 57,11					
	1.9 D Turbo	12.94-08.02	66-68			BSY	0 204 102 521	← 57	0 204 100 316 <sup>B</sup>
							0 204 103 521		0 204 104 177 <sup>7</sup>
							0 204 102 523	→ 57	0 204 100 316 <sup>B</sup>
							0 204 103 523		
	GIR	0 986 473 115		← 57,11					
		0 986 474 115		→ 57,11					
2.0 HDi	06.94-08.02	80/81/			BSY	0 204 102 521	← 57	0 204 100 316 <sup>B</sup>	
						0 204 103 521		0 204 104 177 <sup>7</sup>	
						0 204 102 523	→ 57	0 204 100 316 <sup>B</sup>	
						0 204 103 523			
GIR	0 986 473 115		← 57,11						
	0 986 474 115		→ 57,11						
2.0 i		89-90/			BSY	0 204 102 521	← 57	0 204 100 316 <sup>B</sup>	
						0 204 103 521		0 204 104 177 <sup>7</sup>	
						0 204 102 523	→ 57	0 204 100 316 <sup>B</sup>	
						0 204 103 523			
GIR	0 986 473 115		← 57,11						
	0 986 474 115		→ 57,11						
2.0 i Turbo		97-99/100/			BSY	0 204 102 521	← 57	0 204 100 316 <sup>B</sup>	
						0 204 103 521		0 204 104 177 <sup>7</sup>	
						0 204 102 523	→ 57	0 204 100 316 <sup>B</sup>	
						0 204 103 523			
GIR	0 986 473 115		← 57,11						
	0 986 474 115		→ 57,11						
2.0 i 16V		108-110			BSY	0 204 102 521	← 57	0 204 100 316 <sup>B</sup>	
						0 204 103 521		0 204 104 177 <sup>7</sup>	
						0 204 102 523	→ 57	0 204 100 316 <sup>B</sup>	
						0 204 103 523			
GIR	0 986 473 115		← 57,11						
	0 986 474 115		→ 57,11						
2.1 D Turbo	04.96-08.00	80-81			BSY	0 204 102 521	← 57	0 204 100 316 <sup>B</sup>	
						0 204 103 521		0 204 104 177 <sup>7</sup>	
						0 204 102 523	→ 57	0 204 100 316 <sup>B</sup>	
						0 204 103 523			
GIR	0 986 473 115		← 57,11						
	0 986 474 115		→ 57,11						
	1.8 i	07.95-08.02	73				F 026 002 181	↔ 19,05	
	1.9 D Turbo	12.94-08.02	66-68				F 026 002 181	↔ 19,05	
	2.0 HDi, i	06.94-08.02	80/81/89-90				F 026 002 181	↔ 19,05	
	2.1 D Turbo	04.96-08.00	80-81				F 026 002 181	↔ 19,05	







◀ PEUGEOT 806 [U60]



	1.8 i	07.95-08.02	73		LLE	1987 477 568	← 1063
						1987 477 569	→ 2286
					RLE	1987 477 568	← 1063
						1987 477 773	→ 2368
		09.95-08.02	73			1987 477 565	500
	1.9 D Turbo	12.94-08.02	66-68		LLE	1987 477 568	← 1063
						1987 477 569	→ 2286
					RLE	1987 477 568	← 1063
						1987 477 773	→ 2368
		09.95-08.02	66-68			1987 477 565	500
	2.0 HDi	06.94-08.02	80/81/ 89-90		LLE	1987 477 568	← 1063
						1987 477 569	→ 2286
	2.0 i				RLE	1987 477 568	← 1063
							1987 477 773
		09.95-08.02	80/81/89-90			1987 477 565	500
	2.0 i Turbo	06.94-08.02	97-99/100/		LLE	1987 477 524	→ 2205
	2.0 i 16V		108-110			1987 477 525	← 1255
		09.95-08.02	97-99/100/108-110			1987 477 565	500
	2.1 D Turbo	04.96-08.00	80-81		LLE	1987 477 568	← 1063
						1987 477 569	→ 2286
					RLE	1987 477 568	← 1063
						1987 477 773	→ 2368

	1.8 i	06.97-09.97	73	Org.-Nr. 7481→7601	BO	0 265 006 426 <sup>4</sup>	
		06.97-08.02	73	Org.-Nr. 7481→	BO	0 265 006 388 <sup>3</sup>	
		10.97-08.02	73	Org.-Nr. 7602→	BO	0 265 006 504 <sup>4</sup>	
	1.9 D Turbo	06.97-09.97	66-68	Org.-Nr. 7481→7601	BO	0 265 006 426 <sup>4</sup>	
		06.97-08.02	66-68	Org.-Nr. 7481→	BO	0 265 006 388 <sup>3</sup>	
		10.97-08.02	66-68	Org.-Nr. 7602→	BO	0 265 006 504 <sup>4</sup>	
	2.0 HDi	08.99-08.02	80/81			0 265 006 388 <sup>3</sup>	
						0 265 006 504 <sup>4</sup>	
	2.0 i	06.97-09.97	89-90	Org.-Nr. 7481→7601	BO	0 265 006 426 <sup>4</sup>	
		06.97-08.02	89-90	Org.-Nr. 7481→	BO	0 265 006 388 <sup>3</sup>	
		10.97-08.02	89-90	Org.-Nr. 7602→	BO	0 265 006 504 <sup>4</sup>	
	2.0 i Turbo	06.97-09.97	108-110	Org.-Nr. 7481→7601	BO	0 265 006 426 <sup>4</sup>	
		06.97-08.02	108-110	Org.-Nr. 7481→	BO	0 265 006 388 <sup>3</sup>	
		10.97-08.02	108-110	Org.-Nr. 7602→	BO	0 265 006 504 <sup>4</sup>	
	2.0 i 16V	05.98-08.02	97-99/100			0 265 006 388 <sup>3</sup>	
						0 265 006 504 <sup>4</sup>	
	2.1 D Turbo	06.97-09.97	80-81	Org.-Nr. 7481→7601	BO	0 265 006 426 <sup>4</sup>	
		06.97-08.00	80-81	Org.-Nr. 7481→	BO	0 265 006 388 <sup>3</sup>	
		10.97-08.00	80-81	Org.-Nr. 7602→	BO	0 265 006 504 <sup>4</sup>	

807 [V2]



	2.0 HDi	06.02-02.05	81	Org.-Nr. →10284	LLE	1987 477 713	← 1068
						1987 477 714	→ 2360
					RLE	1987 477 713	→ 1068
						1987 477 714	← 2360
		06.02-12.06	81			1987 477 565	500
	2.0 i 16V	03.05-12.06	81	Org.-Nr. 10285→	LLE	1987 477 953	→ 2308
						1987 477 954	← 1041
					RLE	1987 477 953	← 2308
						1987 477 954	→ 1041
		03.06-05.10	88			1987 482 235	↔ 1255
		06.06-12.13	100			1987 482 235	↔ 1255
		06.10-12.13	120			1987 482 235	↔ 1255
	2.0 i 16V	06.02-02.05	100	Org.-Nr. →10284	LLE	1987 477 713	← 1068
						1987 477 714	→ 2360

	S								
2.0i 16V	06.02-02.05	100	Org.-Nr. →10284	RLE	1 987 477 713	→ 1068			
					1 987 477 714	← 2360			
	06.02-05.06	100				1 987 477 565	500		
	03.05-05.06	100	Org.-Nr. 10285→	LLE	1 987 477 953	→ 2308			
				RLE	1 987 477 954	← 1041			
	10.05-05.10	103			1 987 477 953	← 2308			
				LLE,TW	1 987 477 954	→ 1041			
				RLE,TW	1 987 477 953	→ 2308			
				TW	1 987 477 954	← 1041			
	2.2 HDi	06.02-02.05	94/116	Org.-Nr. →10284	LLE	1 987 477 713	← 1068		
RLE					1 987 477 714	→ 2360			
03.05-07.06		94/116	Org.-Nr. 10285→	LLE	1 987 477 713	→ 1068			
				RLE	1 987 477 714	← 2360			
09.07-05.10		120-125		LLE	1 987 477 953	→ 2308			
				RLE	1 987 477 954	← 1041			
06.02-07.06		94/116		LLE	1 987 482 235	↔ 1255			
				RLE	1 987 477 565	500			
2.2 HDi, i 16V		06.02-02.05	94/116	Org.-Nr. →10284	LLE	1 987 477 713	← 1068		
					RLE	1 987 477 714	→ 2360		
	03.05-05.06	94/116	Org.-Nr. 10285→	LLE	1 987 477 713	→ 1068			
				RLE	1 987 477 714	← 2360			
	06.02-02.05	94/116	Org.-Nr. →10284	LLE	1 987 477 953	→ 2308			
				RLE	1 987 477 954	← 1041			
	06.02-02.05	94/116	Org.-Nr. →10284	LLE	1 987 477 953	→ 2308			
				RLE	1 987 477 954	← 1041			
	3.0i	06.02-02.05	152	Org.-Nr. →10284	LLE	1 987 477 713	← 1068		
					RLE	1 987 477 714	→ 2360		
06.02-05.06		152		LLE	1 987 477 713	→ 1068			
				RLE	1 987 477 714	← 2360			
06.02-05.06		152	Org.-Nr. 10285→	LLE	1 987 477 565	500			
				RLE	1 987 477 953	→ 2308			
03.05-05.06		152	Org.-Nr. 10285→	LLE	1 987 477 953	→ 2308			
				RLE	1 987 477 954	← 1041			
06.02-05.06		152	Org.-Nr. 10285→	LLE	1 987 477 953	→ 2308			
				RLE	1 987 477 954	← 1041			
	06.10-12.13	120		LAB	0 986 594 566 <sup>4</sup>				
				RAB	0 265 007 130 <sup>3</sup>				
	06.02-12.13	81/88/100/ 103		LAB	0 265 007 131 <sup>3</sup>				
				RAB	0 265 007 083 <sup>3</sup>				
	09.07-05.10	120-125		LAB	0 265 007 084 <sup>3</sup>				
				RAB	0 986 594 566 <sup>4</sup>				
	06.02-07.06	94/116		LAB	0 265 007 130 <sup>3</sup>				
				RAB	0 265 007 131 <sup>3</sup>				
	06.02-07.06	94/116		LAB	0 986 594 566 <sup>4</sup>				
				RAB	0 265 007 083 <sup>3</sup>				
06.02-05.06	152		LAB	0 265 007 084 <sup>3</sup>					
			RAB	0 265 007 083 <sup>3</sup>					
06.02-05.06	152		LAB	0 986 594 566 <sup>4</sup>					
			RAB	0 265 007 083 <sup>3</sup>					
06.02-05.06	152		LAB	0 265 007 083 <sup>3</sup>					
			RAB	0 265 007 084 <sup>3</sup>					
<b>1007 [A8]</b>									
	04.05-02.11	50/54/65		LAB	0 204 004 451	← 54			
				RAB	0 204 103 971	→ 54			
				RAB	0 204 004 452	→ 54			



		S										
<b>PEUGEOT 1007 [A8]</b>												
	1.6	04.05-02.11	80				0 204 004 451	← 54				
							0 204 103 971					
							0 204 004 452	→ 54				
	1.6 HDi	03.07-02.11	80				0 204 004 449	← 54				
							0 204 004 450	→ 54				
	1.4	04.05-02.11	50/54/65				BO F 026 002 463	↔ 20,6				
							LUC 0 986 475 833	↔ 20,6				
	1.4	04.05-02.11	50/54/65				1 987 477 238	↔ 1610				
							1.4 HDi	04.05-01.09	50/54/65	1 987 477 238	↔ 1610	
							1.6	04.05-02.11	80	1 987 477 239	↔ 1702	
							1.6 HDi	03.07-02.11	80	1 987 477 239	↔ 1702	
<b>2008 [A94]</b>												
	1.2 THP 1.2 VTi	03.13→	60/81/96				0 204 004 451	← 54				
							0 204 103 971					
							0 204 004 452	→ 54				
	1.4 HDi	03.13→	50				0 204 004 451	← 54				
							0 204 103 971					
							0 204 004 452	→ 54				
	1.6 BlueHDi 1.6 HDi 1.6 VTi	03.13→	55/68/73/ 84/85/88				0 204 004 451	← 54				
							0 204 103 971					
							0 204 004 452	→ 54				
	1.2 THP 1.2 VTi 1.4 HDi	03.13→	60/81/96 50				0 986 473 421	← 38				
							0 986 474 421	→ 38				
							0 986 473 421	← 38				
	1.6 BlueHDi, HDi, VTi	03.13→	55/68/73/ 84/85/88				0 986 473 421	← 38				
							0 986 474 421	→ 38				
	1.2 THP 1.2 VTi 1.4 HDi 1.6 BlueHDi 1.6 HDi 1.6 VTi	02.15→ 03.13→ 03.13→ 02.15→ 03.13→ 03.13→	60/81/96 60/81/96 50 55/68/73/84/85/88 55/68/73/84/85/88 55/68/73/84/85/88					1 987 482 323	↔ 1907			
								1 987 482 323	↔ 1907			
								1 987 482 323	↔ 1907			
								1 987 482 323	↔ 1907			
								1 987 482 323	↔ 1907			
								1 987 482 323	↔ 1907			
<b>3008 [T8]</b>												
	1.2 THP	02.15→	96				0 204 902 044	← 57	0 204 104 359 <sup>8</sup>			
							0 986 134 318					
							0 204 902 045	→ 57	0 204 104 359 <sup>8</sup>			
	1.6 1.6 HDi 1.6 VTi	05.09→	80/82/84/ 85/88				0 204 902 044	← 57	0 204 104 359 <sup>8</sup>			
							0 986 134 318					
							0 204 902 045	→ 57	0 204 104 359 <sup>8</sup>			



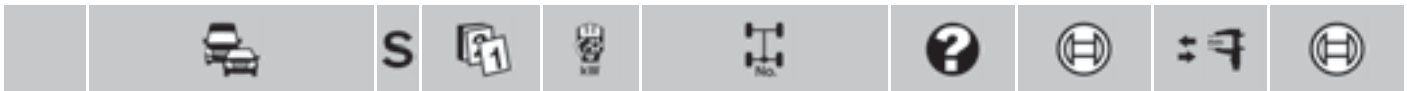

	1.2 THP	02.15→	96			0 986 134 230		
						0 986 135 230		
	1.6, HDi, THP, VTi	05.09→	80/82/84/85/88/ 110/115/120-121			0 986 134 230		
						0 986 135 230		
	2.0 BlueHDi	05.09→	100/110/			0 986 134 230		
	2.0 HDi		120			0 986 135 230		

	1.2 THP	02.15→	96			1 987 482 372		829
	1.6	09.10→	88	Org.-Nr. 12282→		1 987 482 372		829
	1.6 HDi	09.10→	80/82	Org.-Nr. 12282→		1 987 482 372		829
		09.12→	84/85			1 987 482 372		829
		03.14→	88			1 987 482 372		829
	1.6 THP	09.10→	110	Org.-Nr. 12282→		1 987 482 372		829
			115	Org.-Nr. 12282→		1 987 482 372		829
		01.11→	110			1 987 482 372		829
			120-121			1 987 482 372		829
	1.6 VTi	09.10→	88	Org.-Nr. 12282→		1 987 482 372		829
	2.0 BlueHDi	03.15→	100			1 987 482 372		829
	2.0 HDi	09.10→	110	Org.-Nr. 12282→		1 987 482 372		829
			120	Org.-Nr. 12282→		1 987 482 372		829
		05.11→	100			1 987 482 372		829
		03.14→	110			1 987 482 429		970
						1 987 482 430		935

	2.0 HDi	03.14→	110			0 265 007 789 <sup>4</sup>		
--	---------	--------	-----	--	--	----------------------------	--	--

**4007 [I3]**

	2.2 HDi 4x4	09.07-11.12	115			1 987 482 274		1627
						1 987 482 275		1645
	2.4 4x4	11.07-11.12	125			1 987 482 274		1627
						1 987 482 275		1645

**5008 [T8]**

	1.2 e-THP	02.15→	96			1 987 482 429		970
						1 987 482 430		935
	1.6, HDi, HTP, THP	09.09→	80/82/84/85/88/ 110/115/120/121			1 987 482 429		970
						1 987 482 430		935
	2.0 BlueHDi	09.09→	100/110/			1 987 482 429		970
	2.0 HDi		120			1 987 482 430		935

	1.6, HDi, HTP, THP	09.09→	80/82/84/85/88/ 110/115/120/121			0 265 007 789 <sup>4</sup>		
	2.0 BlueHDi, HDi	09.09→	100/110/120			0 265 007 789 <sup>4</sup>		

**PORSCHE**

**Boxster [986]**

	2.5	10.96-08.99	150			0 265 006 344		
	2.7	MFD 09.01-08.04	162/168			0 265 006 344		
		OFD 09.01-08.04	162/168			0 265 007 439		





	◀ PORSCHE Boxster [986]						
	3.2 S	MFD 09.01-08.04	185/191-196			0 265 006 344	
		OFD 09.01-08.04	185/191-196			0 265 007 439	

**Boxster [987]**

	2.7	09.04-01.09	176/180			0 265 007 624	
	2.9	02.09-09.12	188-193			0 265 007 624	
	3.2 S	09.04-08.06	206			0 265 007 624	
	3.4 S, Spyder	09.06-09.12	217-223/228-231/235			0 265 007 624	

**Carrera GT Convertible [980]**

	5.7	09.03-08.05	450		LAB	0 986 594 504	
					RAB	0 986 594 505	

**Carrera GT [980]**

	5.7	10.04-04.06	450		LAB	0 986 594 504	
					RAB	0 986 594 505	

**Cayenne [9PA]**

	3.0	09.08-08.10	176			1 987 482 018	↔ 1750
	3.2	09.02-01.07	184			1 987 482 018	↔ 1750
	3.6	02.07-08.10	213			1 987 482 018	↔ 1750
	4.5 S	09.02-01.07	250/331/368/383			1 987 482 018	↔ 1750
	4.5 Turbo	09.02-01.07	250/331/368/383			1 987 482 018	↔ 1750
	4.5 Turbo S	09.05-01.07	250/331/368/383			1 987 482 018	↔ 1750
	4.8 GTS	08.07-08.10	283/298/368-411			1 987 482 018	↔ 1750
	4.8 S	02.07-08.10	283/298/368-411			1 987 482 018	↔ 1750
	4.8 Turbo	02.07-08.10	283/298/368-411			1 987 482 018	↔ 1750
	4.8 Turbo S	02.07-08.10	283/298/368-411			1 987 482 018	↔ 1750

	3.0	09.08-08.10	176		LAB	0 986 594 524 <sup>3</sup>	
					RAB	0 986 594 524 <sup>4</sup>	
						0 986 594 525 <sup>3</sup>	
						0 986 594 525 <sup>4</sup>	
	3.2	09.02-01.07	184		LAB	0 986 594 524 <sup>3</sup>	
					RAB	0 986 594 524 <sup>4</sup>	
						0 986 594 525 <sup>3</sup>	
						0 986 594 525 <sup>4</sup>	
	3.6	02.07-08.10	213		LAB	0 986 594 524 <sup>3</sup>	
					RAB	0 986 594 524 <sup>4</sup>	
						0 986 594 525 <sup>3</sup>	
						0 986 594 525 <sup>4</sup>	
	4.5 S	09.02-01.07	250/331/368/383		LAB	0 986 594 524 <sup>3</sup>	
					RAB	0 986 594 524 <sup>4</sup>	
						0 986 594 525 <sup>3</sup>	
						0 986 594 525 <sup>4</sup>	
	4.5 Turbo	09.02-01.07	250/331/368/383		LAB	0 986 594 524 <sup>3</sup>	
					RAB	0 986 594 524 <sup>4</sup>	
						0 986 594 525 <sup>3</sup>	
						0 986 594 525 <sup>4</sup>	
	4.5 Turbo S	09.05-01.07	250/331/368/383		LAB	0 986 594 524 <sup>3</sup>	
					RAB	0 986 594 524 <sup>4</sup>	
						0 986 594 525 <sup>3</sup>	
						0 986 594 525 <sup>4</sup>	



		S							
4.8 GTS		08.07-08.10	283/298/ 368-411			LAB	0 986 594 524 <sup>3</sup>		
							0 986 594 524 <sup>4</sup>		
						RAB	0 986 594 525 <sup>3</sup>		
							0 986 594 525 <sup>4</sup>		
4.8 S		02.07-08.10	283/298/ 368-411			LAB	0 986 594 524 <sup>3</sup>		
							0 986 594 524 <sup>4</sup>		
						RAB	0 986 594 525 <sup>3</sup>		
							0 986 594 525 <sup>4</sup>		
4.8 Turbo		02.07-08.10	283/298/ 368-411			LAB	0 986 594 524 <sup>3</sup>		
							0 986 594 524 <sup>4</sup>		
						RAB	0 986 594 525 <sup>3</sup>		
							0 986 594 525 <sup>4</sup>		
4.8 Turbo S		02.07-08.10	283/298/ 368-411			LAB	0 986 594 524 <sup>3</sup>		
							0 986 594 524 <sup>4</sup>		
						RAB	0 986 594 525 <sup>3</sup>		
							0 986 594 525 <sup>4</sup>		
<b>Cayman [987C]</b>									
	2.7	09.06-01.09	180				0 265 007 624		
	2.9	02.09-12.12	195				0 265 007 624		
	3.4 R, S, S Sport	11.05-12.12	217/223/235/243				0 265 007 624		
<b>911 Cabriolet [996]</b>									
	3.4 24V Carrera, 24V Carrera 4	02.98-08.01	220				0 265 006 344		
	3.6 Carrera	09.01-07.04	235				0 265 006 344 <sup>4</sup>		
		06.02-07.04	254				0 265 006 344 <sup>4</sup>		
		MFD 09.01-07.04	235				0 265 006 344 <sup>3</sup>		
		06.02-07.04	254				0 265 006 344 <sup>3</sup>		
	3.6 Carrera, Carrera 4, Carrera 4S	OFD 09.01-07.04	235/254				0 265 007 439 <sup>3</sup>		
	3.6 Carrera 4	09.01-07.04	235				0 265 006 344 <sup>4</sup>		
		06.02-07.04	254				0 265 006 344 <sup>4</sup>		
		MFD 09.01-07.04	235				0 265 006 344 <sup>3</sup>		
		06.02-07.04	254				0 265 006 344 <sup>3</sup>		
	3.6 Carrera 4S	10.03-07.04	235				0 265 006 344 <sup>4</sup>		
			254				0 265 006 344 <sup>4</sup>		
	MFD 10.03-07.04	235				0 265 006 344 <sup>3</sup>			
		254				0 265 006 344 <sup>3</sup>			
3.6 Turbo S4, Turbo 4	10.03-09.05	309/331				0 265 007 439			
<b>911 Cabriolet [997]</b>									
	3.6 Carrera, Carrera 4, Turbo Carrera 4	08.04-09.12	235-239/254/353				1 987 482 431	1304	
	3.8 Carrera GTS, Carrera S, Carrera 4 GTS, Carrera 4S, Turbo S4, Turbo 4	04.05-08.13	261/283/300/ 368/390				1 987 482 431	1304	
	3.6 Carrera, Carrera 4, Turbo Carrera 4	08.04-09.12	235-239/254/353				0 265 007 624		
	3.8 Carrera GTS, Carrera S, Carrera 4 GTS, Carrera 4S, Turbo S4, Turbo 4	04.05-08.13	261/283/300/ 368/390				0 265 007 624		
<b>911 Carrera Cabriolet [996]</b>									
	3.4 4	09.98-08.99	220				0 265 006 344		



		S							
◀ PORSCHE									
<b>911 Speedster [997]</b>									
	3.6	08.04-05.08	235-239				1987 <b>482 431</b>	1304	
	3.8	10.10-09.11	300				1987 <b>482 431</b>	1304	
	3.6	08.04-05.08	235-239				0 265 <b>007 624</b>		
	3.8	10.10-09.11	300				0 265 <b>007 624</b>		
<b>911 Targa [993]</b>									
	3.6	09.95-08.97	210				0 265 <b>006 107</b>		
	3.6 4	09.95-08.97	210				0 265 <b>006 107</b> <sup>3</sup>		
<b>911 Targa [996]</b>									
	3.6 Carrera	12.01-07.04	235				0 265 <b>006 344</b> <sup>4</sup>		
		06.02-07.04	254				0 265 <b>006 344</b> <sup>4</sup>		
		MFD 12.01-07.04	235				0 265 <b>006 344</b> <sup>3</sup>		
		06.02-07.04	254				0 265 <b>006 344</b> <sup>3</sup>		
		OFD 12.01-07.04	235/254				0 265 <b>007 439</b> <sup>3</sup>		
<b>911 Targa [997]</b>									
	3.6 4	08.06-09.12	235-239/254				1987 <b>482 431</b>	1304	
	3.8 4S	08.06-09.12	261/283				1987 <b>482 431</b>	1304	
	3.6 4	08.06-09.12	235-239/254				0 265 <b>007 624</b>		
	3.8 4S	08.06-09.12	261/283				0 265 <b>007 624</b>		
<b>911 [993]</b>									
	3.6 Carrera	09.93-08.95	200				0 265 <b>006 107</b> <sup>3</sup>		
	3.6 Carrera, Carrera S4, Carrera 4	09.95-08.98	210				0 265 <b>006 107</b> <sup>3</sup>		
	3.6 Carrera, Carrera 4	09.93-08.95	200				0 265 <b>006 101</b> <sup>4</sup>		
	3.6 Turbo	01.95-08.95	300/316				0 265 <b>006 101</b> <sup>4</sup>		
	3.6 Turbo Carrera GT2	09.95-08.97	300/316				0 265 <b>006 107</b> <sup>3</sup>		
	3.8 Carrera RS	09.94-08.95	200-221				0 265 <b>006 101</b> <sup>4</sup>		
		09.95-08.97	200-221				0 265 <b>006 107</b> <sup>3</sup>		
<b>911 [996]</b>									
	3.4 24V Carrera, Carrera 4	09.97-08.01	220				0 265 <b>006 344</b>		
	3.6 Carrera	09.01-07.04	235				0 265 <b>006 344</b> <sup>4</sup>		
		06.02-07.04	254-257				0 265 <b>006 344</b> <sup>4</sup>		
		MFD 09.01-07.04	235				0 265 <b>006 344</b> <sup>3</sup>		
		06.02-07.04	254-257				0 265 <b>006 344</b> <sup>3</sup>		
	3.6 Carrera, Carrera 4, Carrera 4S	OFD 09.01-07.04	235/254-257				0 265 <b>007 439</b> <sup>3</sup>		
	3.6 Carrera 4	09.01-07.04	235				0 265 <b>006 344</b> <sup>4</sup>		
		06.02-07.04	254				0 265 <b>006 344</b> <sup>4</sup>		
		MFD 09.01-07.04	235				0 265 <b>006 344</b> <sup>3</sup>		
		06.02-07.04	254				0 265 <b>006 344</b> <sup>3</sup>		
	3.6 Carrera 4S	09.01-07.04	235				0 265 <b>006 344</b> <sup>4</sup>		
		06.02-07.04	254				0 265 <b>006 344</b> <sup>4</sup>		
		MFD 09.01-07.04	235				0 265 <b>006 344</b> <sup>3</sup>		
		06.02-07.04	254				0 265 <b>006 344</b> <sup>3</sup>		



		S				?			
3.6 GT2		10.04-09.05	340-360				0 265 007 439		
3.6 GT2		06.01-08.03	331/340				0 265 006 344		
3.6 Turbo S4		09.03-09.05	331/340				0 265 007 439		
3.6 GT3		03.99-08.01	265				0 265 006 344		
		10.03-09.05	280				0 265 006 344		
3.6 Turbo 4		MFD 06.00-09.05	309				0 265 006 344		
		OFD 09.03-09.05	309				0 265 007 439		
<b>911 [997]</b>									
	3.6 Carrera, Carrera 4, GT2, GT2 RS, GT3, Turbo Carrera 4	08.04-09.12	235-239/254/305/353/390/456				1 987 482 431	1304	
	3.8 Carrera GTS, Carrera S, Carrera 4 GTS, Carrera 4S, GT3, GT3 RS, Sport Classic, Turbo S4, Turbo 4	08.04-08.13	261/283/300/320/331/				1 987 482 431	1304	
	3.6 Carrera, Carrera 4, GT2, GT2 RS, GT3 Turbo Carrera 4	08.04-09.12	235-239/254/305/353/390/456				0 265 007 624		
	3.8 Carrera GTS, Carrera S, Carrera 4 GTS, Carrera 4S, GT3, GT3 RS, Sport Classic, Turbo S4, Turbo 4	08.04-08.13	261/283/300/320/331/368/390				0 265 007 624		
	4.0 GT3 RS	07.11-08.12	368				0 265 007 624		
<b>918 Spyder [918]</b>									
	4	03.14-06.15	447			RAB	0 265 007 928		
<b>928</b>									
	5.4 GTS	08.91-11.95	257				0 265 001 118 <sup>4</sup>		
							0 265 006 141 <sup>3</sup>		
<b>968</b>									
	3.0	08.91-11.95	176/224				0 265 006 141 <sup>3</sup>		
	3.0 Turbo S						0 265 006 142 <sup>4</sup>		
<b>PROTON</b>									
<b>Arena Pickup</b>									
	1.5 i	01.01-01.07	66				0 986 475 668	↔ 19	
	1.5 i	01.01-01.07	66				1 987 482 163	→ 1510	
<b>GEN2</b>									
	1.3 i	02.04→	70				0 204 205 117	← 54	0 204 104 279 <sup>7</sup>
							0 204 205 118	→ 54	0 204 104 279 <sup>7</sup>





		S							
<b>PROTON GEN2</b>									
	1.6 i	02.04→	82				0 204 205 117	← 54	0 204 104 279 <sup>7</sup>
							0 204 205 118	→ 54	0 204 104 279 <sup>7</sup>
	1.6 i	02.04→	82						0 204 104 281 <sup>7</sup>
<b>Persona [C90 CC0]</b>									
	1.3 i	12.95-06.99	55				0 986 475 668	↔ 19	
	1.5 i 12V	11.94-12.97	66				0 986 475 668	↔ 19	
<b>Persona [C90 CC1]</b>									
	1.3 i	12.95-06.99	55				0 986 475 668	↔ 19	
	1.5 i	12.95→	66				0 986 475 668	↔ 19	
	2.0 D, D Turbo	12.95→	50/60				0 986 475 668	↔ 19	
<b>Wira Aeroback</b>									
	1.5	05.93-06.01	63-66				0 986 475 668	↔ 19	
	1.5	05.93-06.01	63-66				1 987 482 163	→ 1510	
<b>RENAULT</b>									
<b>Alpine [D503]</b>									
	A 610 3.0i Turbo	03.91-12.95	184				0 986 473 422	👁️ ← 57	
							0 986 474 422	👁️ → 57	
	A 610 3.0i Turbo	03.91-12.95	184				0 204 102 284	→ 57	
	A 610 3.0i Turbo	03.91-12.95	184		LAB		0 265 001 311 <sup>4</sup>		
<b>Avantime [XEO]</b>									
	2.0 16V Turbo	09.01-12.03	120				0 986 473 495	👁️ ← 38	
							0 986 474 495	👁️ → 38	
	2.2 DCI	12.01-12.03	110				0 986 473 495	👁️ ← 38	
							0 986 474 495	👁️ → 38	
	3.0 V6 24V	09.01-12.03	152				0 986 473 495	👁️ ← 38	
							0 986 474 495	👁️ → 38	



		S							
	2.0 16V Turbo	09.01-12.03	120				0 265 006 284 <sup>4</sup>		
							LAB 0 265 006 283 <sup>3</sup>		
							RAB 0 265 006 282 <sup>3</sup>		
	2.2 DCI	12.01-12.03	110				0 265 006 284 <sup>4</sup>		
							LAB 0 265 006 283 <sup>3</sup>		
							RAB 0 265 006 282 <sup>3</sup>		
	3.0 V6 24V	09.01-12.03	152				0 265 006 284 <sup>4</sup>		
							LAB 0 265 006 283 <sup>3</sup>		
							RAB 0 265 006 282 <sup>3</sup>		
<b>Captur [J5]</b>									
	0.9	01.13→	66				F 026 002 573	↔ 22,2	
	1.2	01.13→	88				F 026 002 573	↔ 22,2	
	1.5 dCi	01.13→	66				F 026 002 573	↔ 22,2	
<b>Clio I</b>									
	1.9 D	01.00→	47/48				0 986 BB3 013	↔	
	1.6 i	01.96-08.99	66				0 265 006 385 <sup>4</sup>		
							LAB 0 265 006 384 <sup>3</sup>		
							RAB 0 265 006 383 <sup>3</sup>		
<b>Clio I [X57]</b>									
	Electrique	06.95-02.98	21			INB BSY	0 204 102 249	← 48	0 204 100 127 <sup>B</sup>
							0 986 473 101		0 204 104 052 <sup>7</sup>
							0 204 102 250	→ 48	0 204 100 127 <sup>B</sup>
							0 986 474 101		
						GIR	0 986 473 671	← 48	
							0 986 474 671	→ 48	
	1.1	06.90-03.96	35-36			INB GIR	0 986 473 671	← 48	
							0 986 474 671	→ 48	
		06.92-03.96	35-36			BSY	0 204 102 249	← 48	0 204 100 127 <sup>B</sup>
							0 986 473 101		0 204 104 052 <sup>7</sup>
							0 204 102 250	→ 48	0 204 100 127 <sup>B</sup>
							0 986 474 101		
	1.2	06.90-02.98	40-44			INB BSY	0 204 102 249	← 48	0 204 100 127 <sup>B</sup>
	1.2i						0 986 473 101		0 204 104 052 <sup>7</sup>
							0 204 102 250	→ 48	0 204 100 127 <sup>B</sup>
							0 986 474 101		
						GIR	0 986 473 671	← 48	
							0 986 474 671	→ 48	
	1.4	04.90-02.98	55-59			INB GIR	0 986 473 677	← 48	
	1.4i						0 986 474 677	→ 48	
						INB BSY	0 204 102 249	← 48	0 204 100 127 <sup>B</sup>
							0 986 473 101		0 204 104 052 <sup>7</sup>
							0 204 102 250	→ 48	0 204 100 127 <sup>B</sup>
							0 986 474 101		
						GIR	0 986 473 671	← 48	
							0 986 474 671	→ 48	
	1.7	06.90-03.96	66-68			INB GIR	0 986 473 677	← 48	
							0 986 474 677	→ 48	



		S								
◀ RENAULT Clio I [X57]										
1.7	06.90-03.96	66-68	INB	GIR			0 986 473 671		← 48	
							0 986 474 671		→ 48	
1.8i	06.90-02.98	65-70/79-81/	INB	GIR			0 986 473 677		← 48	
1.8i 16V		99-103					0 986 474 677		→ 48	
1.9D	06.90-03.96	47-48	INB	GIR			0 986 473 671		← 48	
							0 986 474 671		→ 48	
	06.90-02.98	47	INB	BSY			0 204 102 249		← 48	
							0 986 473 101			
		47-48	INB	BSY			0 204 102 250		→ 48	
							0 986 474 101			
	01.94-02.98	47	INB	GIR			0 986 473 677		← 48	
							0 986 474 677		→ 48	
		47-48	INB	GIR			0 986 473 677		← 48	
							0 986 474 677		→ 48	
2.0 i Williams	07.92-03.96	108-110	INB	GIR			0 986 473 677		← 48	
							0 986 474 677		→ 48	
	Electrique	06.95-02.98	21				0 986 475 677		↔ 22,2	
							1.1	ABO	04.91-03.96	35-36
							F 026 002 237		→ 20,64	
							GIR	0 986 475 643		▲ → 20,6
							0 986 475 644		▲ ← 20,6	
							1.2	ABO	06.90-03.96	40-44
							F 026 002 237		→ 20,64	
									04.91-02.98	40-44
							0 986 475 644		▲ ← 20,6	
									04.96-02.98	40-44
							F 026 002 237		← 20,64	
							1.2i		06.90-03.96	40
							BSY	F 026 002 237		← 20,64
							0 986 475 644		▲ ← 20,6	
									04.96-02.98	40-44
							F 026 002 237		→ 20,64	
							0 986 475 644		▲ ← 20,6	
							0 986 475 644		▲ ← 20,6	
									01.94-03.96	40
							F 026 002 237		→ 20,64	
							0 986 475 644		▲ ← 20,6	
									04.96-02.98	40-41
							F 026 002 237		← 20,64	
							F 026 002 237		← 20,64	
							F 026 002 237		← 20,64	
									01.94-03.96	40
							F 026 002 237		→ 20,64	
							0 986 475 644		▲ ← 20,6	
									04.96-02.98	40-41
							F 026 002 237		← 20,64	
							F 026 002 237		← 20,64	
							F 026 002 237		← 20,64	
									04.96-02.98	55-57
							F 026 002 237		← 20,64	



		S							
<b>1.4</b>		ABO	04.91-02.98	55-57		GIR	0 986 475 643	▲ → 20,6	
<b>1.4i</b>							0 986 475 644	▲ ← 20,6	
<b>1.4i</b>		ABO	04.91-03.96	55-57		BSY	F 026 002 236	← 20,64	
				58-59		BSY	F 026 002 237	→ 20,64	
				58-59		BSY	F 026 002 236	← 20,64	
				58-59		BSY	F 026 002 237	→ 20,64	
			04.91-02.98	58-59		GIR	0 986 475 643	▲ → 20,6	
				58-59		GIR	0 986 475 644	▲ ← 20,6	
			01.94-03.96	55		BSY	F 026 002 236	← 20,64	
				55-58		BSY	F 026 002 237	→ 20,64	
				55-58		BSY	F 026 002 236	← 20,64	
				55-58		BSY	F 026 002 237	→ 20,64	
			01.94-12.96	55		GIR	0 986 475 643	▲ → 20,6	
				55-58		GIR	0 986 475 644	▲ ← 20,6	
				55-58		GIR	0 986 475 643	▲ → 20,6	
				55-58		GIR	0 986 475 644	▲ ← 20,6	
			04.96-02.98	55		BSY	F 026 002 236	→ 20,64	
				55-58		BSY	F 026 002 237	← 20,64	
				55-58		BSY	F 026 002 236	→ 20,64	
				55-58		BSY	F 026 002 237	← 20,64	
			01.97-02.98	55		GIR	0 986 475 834	▲ ← 20,6	
				55-58		GIR	0 986 475 835	▲ → 20,6	
				55-58		GIR	0 986 475 834	▲ ← 20,6	
				55-58		GIR	0 986 475 835	▲ → 20,6	
<b>1.7</b>			06.90-03.96	66-68		GIR	0 986 475 643	▲ → 20,6	
				66-68		GIR	0 986 475 644	▲ ← 20,6	
			04.91-03.96	66-68			F 026 002 236	← 20,64	
				66-68			F 026 002 237	→ 20,64	
<b>1.8i</b>			06.90-02.98	65-70		GIR	0 986 475 643	▲ → 20,6	
				65-70		GIR	0 986 475 644	▲ ← 20,6	
			04.91-02.98	65-70			F 026 002 236	← 20,64	
				65-70			F 026 002 237	→ 20,64	
			01.94-02.98	66			F 026 002 236	← 20,64	
				66			F 026 002 237	→ 20,64	
				66		GIR	0 986 475 643	▲ → 20,6	
				66		GIR	0 986 475 644	▲ ← 20,6	
			09.96-12.96	66	HAK	GIR	0 986 475 643	▲ → 20,6	
				66	HAK	GIR	0 986 475 644	▲ ← 20,6	
			09.96-02.98	66	HAK	BSY	F 026 002 236	→ 20,64	
				66	HAK	BSY	F 026 002 237	← 20,64	
			01.97-02.98	66	HAK	GIR	0 986 475 834	▲ ← 20,6	
				66	HAK	GIR	0 986 475 835	▲ → 20,6	
<b>1.9D</b>			04.96-02.98	47		LWG	BSY	F 026 002 236	→ 20,64
				47-48		LWG	BSY	F 026 002 237	← 20,64
				47-48		LWG	BSY	F 026 002 236	→ 20,64
				47-48		LWG	BSY	F 026 002 237	← 20,64
		ABO	04.91-03.96	47		BSY	F 026 002 236	← 20,64	
				47-48		BSY	F 026 002 237	→ 20,64	
				47-48		BSY	F 026 002 236	← 20,64	
				47-48		BSY	F 026 002 237	→ 20,64	
			04.91-12.96	47		GIR	0 986 475 643	▲ → 20,6	
				47-48		GIR	0 986 475 644	▲ ← 20,6	
				47-48		GIR	0 986 475 643	▲ → 20,6	
				47-48		GIR	0 986 475 644	▲ ← 20,6	
			04.96-02.98	47		BSY	F 026 002 236	→ 20,64	
				47		BSY	F 026 002 237	← 20,64	
			01.97-02.98	47		GIR	0 986 475 834	▲ ← 20,6	
				47		GIR	0 986 475 835	▲ → 20,6	
				47-48		GIR	0 986 475 834	▲ ← 20,6	
				47-48		GIR	0 986 475 835	▲ → 20,6	





◀RENAULT Clio I [X57]

	1.2 i	06.90-02.98	40-44	0 204 102 075	← 30	0 204 100 062 <sup>8</sup>
				0986 134 098		0 204 104 068 <sup>9</sup>
				0 204 102 077	→ 30	0 204 100 062 <sup>8</sup>
				0 204 103 077		
				0986 135 098		
1.4	01.94-03.96	55-57	0 204 102 077	→ 30	0 204 104 045 <sup>7</sup>	
			0 204 103 077			
			0986 135 098		0 204 104 068 <sup>9</sup>	
1.4	06.90-02.98	55-57	0 204 102 075	← 30	0 204 100 062 <sup>8</sup>	
			0986 134 098		0 204 104 068 <sup>9</sup>	
1.4 i			0 204 102 077	→ 30	0 204 100 062 <sup>8</sup>	
			0 204 103 077			
			0986 135 098			
1.4 i	04.90-02.98	55-59	0 204 102 075	← 30	0 204 100 062 <sup>8</sup>	
			0986 134 098		0 204 104 068 <sup>9</sup>	
			0 204 102 077	→ 30	0 204 100 062 <sup>8</sup>	
			0 204 103 077			
			0986 135 098			
	01.94-02.98	55	0 204 102 075	← 30	0 204 100 062 <sup>8</sup>	
			0986 134 098		0 204 104 068 <sup>9</sup>	
			0 204 102 077	→ 30	0 204 100 062 <sup>8</sup>	
			0 204 103 077			
			0986 135 098			
1.7	06.90-03.96	66-68	0 204 102 075	← 30	0 204 100 062 <sup>8</sup>	
			0986 134 098		0 204 104 068 <sup>9</sup>	
			0 204 102 077	→ 30	0 204 100 062 <sup>8</sup>	
			0 204 103 077			
			0986 135 098			
1.8 i	06.90-03.96	65-70	0 204 102 077	→ 30	0 204 104 045 <sup>7</sup>	
			0 204 103 077			
			0986 135 098		0 204 104 068 <sup>9</sup>	
			0 204 102 075	← 30	0 204 100 062 <sup>8</sup>	
			0986 134 098		0 204 104 068 <sup>9</sup>	
			0 204 102 077	→ 30	0 204 100 062 <sup>8</sup>	
			0 204 103 077			
			0986 135 098			
1.8 i	03.91-02.98	66/79-81/	0 204 102 075	← 30	0 204 100 062 <sup>8</sup>	
			0986 134 098		0 204 104 068 <sup>9</sup>	
1.8 i 16V		99-103	0 204 102 077	→ 30	0 204 100 062 <sup>8</sup>	
			0 204 103 077			
			0986 135 098			
1.9D	06.90-02.98	47-48	0 204 102 075	← 30	0 204 100 062 <sup>8</sup>	
			0986 134 098		0 204 104 068 <sup>9</sup>	
			0 204 102 077	→ 30	0 204 100 062 <sup>8</sup>	
			0 204 103 077			
			0986 135 098			
2.0 i Williams	07.92-03.96	108-110	0 204 102 075	← 30	0 204 100 062 <sup>8</sup>	
			0986 134 098		0 204 104 068 <sup>9</sup>	
			0 204 102 077	→ 30	0 204 100 062 <sup>8</sup>	
			0 204 103 077			
			0986 135 098			



	1.1	06.90-03.96	35-36	1987 477 152	1430
	1.2, i	06.90-02.98	40-44	1987 477 152	1430
	1.4, i	04.90-02.98	55-59	1987 477 152	1430
	1.4 i	ABS 06.90-02.98	55-57/58-59	1987 477 153	1480
	1.7	06.90-03.96	66-68	1987 477 152	1430
		ABS 06.90-03.96	66-68	1987 477 153	1480
	1.8 i	06.90-02.98	65-70	1987 477 152	1430
		01.94-02.98	66	1987 477 153	1480
		ABO 09.96-02.98	66	1987 477 152	1430

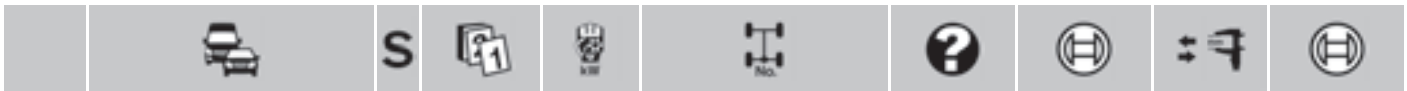

<b>1.8 i</b>	ABS	06.90-02.98	65-70		1 987 477 153	1480
		09.96-02.98	66		1 987 477 153	1480
<b>1.8 i, i 16V</b>		03.91-02.98	79-81/99-103		1 987 477 153	1480
<b>1.9 D</b>		06.90-02.98	47-48		1 987 477 152	1430
<b>2.0 i Williams</b>		07.92-03.96	108-110		1 987 477 153	1480



<b>Electrique</b>		06.95-02.98	21	LAB	0 265 006 443 <sup>4</sup>	
				RAB	0 265 006 444 <sup>4</sup>	
<b>1.1</b>		06.90-03.96	35-36	LAB	0 265 006 443 <sup>4</sup>	
				RAB	0 265 006 444 <sup>4</sup>	
<b>1.2</b>		06.90-02.98	40-44	LAB	0 265 006 443 <sup>4</sup>	
<b>1.2 i</b>				RAB	0 265 006 444 <sup>4</sup>	
<b>1.2 i</b>		06.90-02.98	40-41		0 265 006 442 <sup>3</sup>	
				LAB	0 265 006 443 <sup>4</sup>	
				RAB	0 265 006 444 <sup>4</sup>	
			44		0 265 006 442 <sup>3</sup>	
				LAB	0 265 006 443 <sup>4</sup>	
				RAB	0 265 006 444 <sup>4</sup>	
		04.96-02.98	40-44		0 265 006 442 <sup>3</sup>	
<b>1.4</b>		06.90-02.98	55-57	LAB	0 265 006 443 <sup>4</sup>	
<b>1.4 i</b>				RAB	0 265 006 444 <sup>4</sup>	
<b>1.4 i</b>		04.90-02.98	55-59		0 265 006 442 <sup>3</sup>	
				LAB	0 265 006 443 <sup>4</sup>	
				RAB	0 265 006 444 <sup>4</sup>	
		06.90-03.96	55-57		0 265 006 442 <sup>3</sup>	
		01.94-02.98	55		0 265 006 442 <sup>3</sup>	
				LAB	0 265 006 443 <sup>4</sup>	
				RAB	0 265 006 444 <sup>4</sup>	
<b>1.7</b>		06.90-03.96	66-68		0 265 006 442 <sup>3</sup>	
				LAB	0 265 006 443 <sup>4</sup>	
				RAB	0 265 006 444 <sup>4</sup>	
<b>1.8 i</b>		06.90-02.98	65-70/		0 265 006 442 <sup>3</sup>	
<b>1.8 i 16V</b>			79-81/	LAB	0 265 006 443 <sup>4</sup>	
			99-103	RAB	0 265 006 444 <sup>4</sup>	
<b>1.9 D</b>		06.90-02.98	47-48		0 265 006 442 <sup>3</sup>	
				LAB	0 265 006 443 <sup>4</sup>	
				RAB	0 265 006 444 <sup>4</sup>	
<b>2.0 i Williams</b>		07.92-03.96	108-110		0 265 006 442 <sup>3</sup>	
				LAB	0 265 006 443 <sup>4</sup>	
				RAB	0 265 006 444 <sup>4</sup>	

**Clio II**



<b>1.0 i 16V</b>		01.01-01.05	52		0 986 BB3 013 ↔
				BO	F 026 002 249 ↔ 17,5
				GIR	0 986 475 837 ↔ 17,46
<b>1.2 i 16V</b>		01.02→	55		F 026 002 480 ↔ 19,05
					0 986 BB3 013 ↔
<b>1.6 i 8V</b>		01.00-04.03	66/74		0 986 BB3 013 ↔



<b>1.0 i 16V</b>		01.01-01.05	52		1 987 477 782 → 1415
					1 987 477 783 ← 1335



<b>1.0 i 16V</b>		01.01-11.02	52		0 265 006 383 <sup>3</sup>
		01.01-01.05	52	LAB	0 265 006 384 <sup>4</sup>
				RAB	0 265 006 385 <sup>4</sup>
		12.02-01.05	52		0 265 007 527 <sup>3</sup>
<b>1.6 i 8V</b>		09.99-12.02	66		0 265 006 383 <sup>3</sup>
				LAB	0 265 006 384 <sup>4</sup>
				RAB	0 265 006 385 <sup>4</sup>



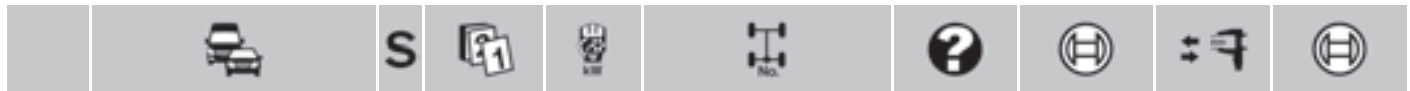

◀ RENAULT

**Clio II [BB/CB/SB]**



	<b>1.0 i</b>		03.99-11.04	43/50		0986 473 677		← 48
	<b>1.0 i 16V</b>					0986 474 677		→ 48
	<b>1.2</b>	ABS	03.98→	43		0986 473 677		← 48
	<b>1.2 i</b>					0986 474 677		→ 48
	<b>1.2, i, i 16V</b>	ABO	03.98→	43/55		0986 473 671		← 48
						0986 474 671		→ 48
	<b>1.2 i 16V</b>		04.04-10.07	55		0986 473 677		← 48
						0986 474 677		→ 48
		ABS	03.00-03.04	55		0986 473 677		← 48
						0986 474 677		→ 48
	<b>1.2 16V</b>		10.03→	55		0986 473 677		← 48
						0986 474 677		→ 48
	<b>1.4 i</b>	ABO	03.98-10.07	55		0986 473 671		← 48
						0986 474 671		→ 48
		ABS	03.98-10.07	55		0986 473 677		← 48
						0986 474 677		→ 48
	<b>1.4 i 16V</b>		10.99-10.07	70-72		0986 473 677		← 48
						0986 474 677		→ 48
	<b>1.5 dCi</b>		06.01→	47/48/50/ 60/62/74		0986 473 677		← 48
						0986 474 677		→ 48
	<b>1.6 i</b>		03.98-10.07	66/81		0986 473 677		← 48
						0986 474 677		→ 48
	<b>1.6 i 16V</b>	ABO	06.98-10.07	79		0986 473 671		← 48
						0986 474 671		→ 48
		ABS	06.98-10.07	79		0986 473 677		← 48
						0986 474 677		→ 48
	<b>1.9 D</b>		03.98-10.07	47-48		0986 473 677		← 48
						0986 474 677		→ 48
		ABO	03.98-10.07	47-48		0986 473 671		← 48
						0986 474 671		→ 48
		ABS	03.98-10.07	47-48		0986 473 677		← 48
						0986 474 677		→ 48
	<b>1.9 D DTI</b>		03.99-10.07	59		0986 473 677		← 48
						0986 474 677		→ 48
	<b>2.0 16V</b>		03.99-10.07	124		0986 134 315		← 54
						0986 135 315		→ 54



	<b>1.0 i</b>	ABO	03.99-11.04	43/50		F 026 002 480		↔ 19,05
	<b>1.0 i 16V</b>	ABS	03.99-11.04	43/50		BSY F 026 002 249		↔ 17,5
						GIR 0986 475 837		↔ 17,46
	<b>1.2</b>		10.99-11.07	43		GIR 0986 475 837		↔ 17,46
			10.99→	43		BO F 026 002 249		↔ 17,5
			12.07→	43		GIR 0986 475 969		↔ 17,46
		ABS	01.01→	43		BSY F 026 002 249		↔ 17,5
						GIR 0986 475 837		↔ 17,46
	<b>1.2, i, i 16V, 16V</b>	ABO	03.98→	43/55		F 026 002 480		↔ 19,05
	<b>1.2 i</b>	ABS	03.98-10.07	43		BSY F 026 002 249		↔ 17,5
						GIR 0986 475 837		↔ 17,46
	<b>1.2 i 16V</b>	ABS	03.00→	55		BSY F 026 002 249		↔ 17,5
	<b>1.2 16V</b>					GIR 0986 475 837		↔ 17,46
	<b>1.4 i</b>	ABO	03.98-10.07	55/70-72		F 026 002 480		↔ 19,05
	<b>1.4 i 16V</b>	ABS	03.98-10.07	55/70-72		BSY F 026 002 249		↔ 17,5
						GIR 0986 475 837		↔ 17,46
	<b>1.5 dCi</b>	ABO	06.01-10.07	48/50/60/74		F 026 002 480		↔ 19,05
			04.07→	47		0986 475 837		↔ 17,46
		ABS	06.01-10.07	48/50/60/ 74		BSY F 026 002 249		↔ 17,5
						GIR 0986 475 837		↔ 17,46
			04.07→	47		0986 475 969		↔ 17,46

		S								
<b>1.6i</b>		ABO	03.98-10.07	66/79/81			F 026 <b>002 480</b>	↔	19,05	
<b>1.6i 16V</b>		ABS	03.98-10.07	66/79/81		BSY	F 026 <b>002 249</b>	↔	17,5	
						GIR	0 986 <b>475 837</b>	↔	17,46	
<b>1.9D</b>		ABO	03.98-10.07	47-48/59			F 026 <b>002 480</b>	↔	19,05	
<b>1.9D DTI</b>		ABS	03.98-10.07	47-48/59		BSY	F 026 <b>002 249</b>	↔	17,5	
						GIR	0 986 <b>475 837</b>	↔	17,46	
	<b>1.2i 16V</b>		03.00→	55			0 204 <b>102 182</b>	←	48	0 204 <b>100 062<sup>B</sup></b>
	<b>1.2 16V</b>						0 986 <b>134 316</b>	↔		0 204 <b>104 068<sup>9</sup></b>
							0 204 <b>102 184</b>	→	48	0 204 <b>100 062<sup>B</sup></b>
							0 204 <b>103 184</b>	↔		
							0 986 <b>135 316</b>	↔		
	<b>1.4i 16V</b>		10.99-10.07	70-72			0 204 <b>102 182</b>	←	48	0 204 <b>100 062<sup>B</sup></b>
							0 986 <b>134 316</b>	↔		0 204 <b>104 068<sup>9</sup></b>
							0 204 <b>102 184</b>	→	48	0 204 <b>100 062<sup>B</sup></b>
							0 204 <b>103 184</b>	↔		
							0 986 <b>135 316</b>	↔		
	<b>1.5 dCi</b>		06.01-10.07	48/50/60/ 74			0 204 <b>102 182</b>	←	48	0 204 <b>100 062<sup>B</sup></b>
							0 986 <b>134 316</b>	↔		0 204 <b>104 068<sup>9</sup></b>
							0 204 <b>102 184</b>	→	48	0 204 <b>100 062<sup>B</sup></b>
							0 204 <b>103 184</b>	↔		
							0 986 <b>135 316</b>	↔		
	<b>1.6i</b>		10.99-10.07	66			0 204 <b>102 182</b>	←	48	0 204 <b>100 062<sup>B</sup></b>
							0 986 <b>134 316</b>	↔		0 204 <b>104 068<sup>9</sup></b>
							0 204 <b>102 184</b>	→	48	0 204 <b>100 062<sup>B</sup></b>
							0 204 <b>103 184</b>	↔		
							0 986 <b>135 316</b>	↔		
	<b>2.0 16V</b>		03.99-10.07	124			0 204 <b>102 182</b>	←	48	0 204 <b>100 062<sup>B</sup></b>
							0 986 <b>134 316</b>	↔		0 204 <b>104 068<sup>9</sup></b>
							0 204 <b>102 184</b>	→	48	0 204 <b>100 062<sup>B</sup></b>
							0 204 <b>103 184</b>	↔		
							0 986 <b>135 316</b>	↔		
	<b>3.0 24V Sport</b>		09.00-06.05	170/188			0 204 <b>102 284</b>	→	57	0 204 <b>104 056<sup>7</sup></b>
	<b>1.0i</b>		03.99-08.03	43/50			1 987 <b>477 782</b>	→	1415	
	<b>1.0i 16V</b>						1 987 <b>477 783</b>	←	1335	
	<b>1.2</b>	ABO	03.98-07.00	43			1 987 <b>477 641</b>	→	1343	
	<b>1.2i</b>		08.00→	43			1 987 <b>477 642</b>	←	1263	
							1 987 <b>477 784</b>	→	1402	
							1 987 <b>477 785</b>	←	1321	
		ABS	03.98-07.00	43			1 987 <b>477 644</b>	→	1355	
			08.00→	43			1 987 <b>477 645</b>	←	1277	
							1 987 <b>477 782</b>	→	1415	
							1 987 <b>477 783</b>	←	1335	
	<b>1.2i 16V</b>		04.04-10.07	55			1 987 <b>477 782</b>	→	1415	
							1 987 <b>477 783</b>	←	1335	
		ABO	03.00-07.00	55			1 987 <b>477 641</b>	→	1343	
			06.00-03.04	55			1 987 <b>477 642</b>	←	1263	
			06.00-03.04	55			1 987 <b>477 644</b>	→	1355	
			08.00-03.04	55			1 987 <b>477 645</b>	←	1277	
			08.00-03.04	55			1 987 <b>477 784</b>	→	1402	
							1 987 <b>477 785</b>	←	1321	
		ABS	03.00-07.00	55			1 987 <b>477 644</b>	→	1355	
			06.00-03.04	55			1 987 <b>477 645</b>	←	1277	
			06.00-03.04	55			1 987 <b>477 782</b>	→	1415	
							1 987 <b>477 783</b>	←	1335	
	<b>1.2 16V</b>		10.03→	55			1 987 <b>477 782</b>	→	1415	
							1 987 <b>477 783</b>	←	1335	
	<b>1.4i</b>	ABO	03.98-07.00	55			1 987 <b>477 641</b>	→	1343	
							1 987 <b>477 642</b>	←	1263	















Model	Version	Year Range	Power	Options	Part Number	Direction	Part Number	Direction	
◀ RENAULT Clio II [BB/CB/SB]									
1.4 i	ABO	08.00-10.07	55		1987 477 784	→	1402		
					1987 477 785	←	1321		
	ABS	03.98-07.00	55		1987 477 644	→	1355		
					1987 477 645	←	1277		
	08.00-10.07	55			1987 477 782	→	1415		
					1987 477 783	←	1335		
1.4 i 16V	TKO	05.00-10.07	70		1987 477 782	→	1415		
					1987 477 783	←	1335		
					TKO	1987 482 040	→	1450	
					1987 482 041	←	1378		
	ABO	10.99-10.07	70-72		1987 477 644	→	1355		
					1987 477 645	←	1277		
	ABS	10.99-10.07	70		1987 477 782	→	1415		
					1987 477 783	←	1335		
		70-72			1987 477 782	→	1415		
					1987 477 783	←	1335		
1.5 dCi	06.01-12.01	60			1987 477 782	→	1415		
					1987 477 783	←	1335		
		06.01-10.07	48/50			1987 477 782	→	1415	
						1987 477 783	←	1335	
			60		TKO	1987 477 782	→	1415	
						1987 477 783	←	1335	
					TKO	1987 482 040	→	1450	
						1987 482 041	←	1378	
		01.02-10.07	60			1987 482 040	→	1450	
						1987 482 041	←	1378	
	03.03-10.07	74			1987 482 040	→	1450		
					1987 482 041	←	1378		
1.6 i	03.98-07.00	66			1987 477 644	→	1355		
					1987 477 645	←	1277		
		10.99-08.03	81			1987 477 782	→	1415	
						1987 477 783	←	1335	
		10.99-10.07	66		TKO	1987 477 782	→	1415	
						1987 477 783	←	1335	
					TKO	1987 482 040	→	1450	
						1987 482 041	←	1378	
		08.00-10.07	66			1987 477 782	→	1415	
						1987 477 783	←	1335	
	02.04-10.07	66		TKO	1987 482 040	→	1450		
					1987 482 041	←	1378		
1.6 i 16V	06.98-07.00	79			1987 477 644	→	1355		
					1987 477 645	←	1277		
					1987 477 782	→	1415		
	08.00-10.07	79			1987 477 783	←	1335		
1.9 D	03.98-07.00	47-48			1987 477 644	→	1355		
					1987 477 645	←	1277		
		08.00-10.07	47-48			1987 477 782	→	1415	
						1987 477 783	←	1335	
	ABO	03.98-07.00	47-48			1987 477 641	→	1343	
						1987 477 642	←	1263	
		08.00-10.07	47-48			1987 477 784	→	1402	
						1987 477 785	←	1321	
	ABS	03.98-07.00	47-48			1987 477 644	→	1355	
						1987 477 645	←	1277	
	08.00-10.07	47-48			1987 477 782	→	1415		
					1987 477 783	←	1335		
1.9 DDTI	03.99-07.00	59			1987 477 644	→	1355		
					1987 477 645	←	1277		
					1987 477 782	→	1415		
	08.00-10.07	59			1987 477 783	←	1335		
					TKO	1987 477 782	→	1415	
					1987 477 783	←	1335		



			<b>S</b>							
<b>1.9 D DTI</b>		08.00-10.07	59				TKO	1 987 482 040	→ 1450	
								1 987 482 041	← 1378	
<b>2.0 16V</b>		03.99-08.00	124				STB	1 987 477 776	→ 1380	
								1 987 477 777	← 1310	
 <b>1.0 i</b>		03.99-11.02	43/50					0 265 006 383 <sup>3</sup>		
<b>1.0 i 16V</b>							LAB,TKO	0 265 006 384 <sup>4</sup>		
							RAB,TKO	0 265 006 385 <sup>4</sup>		
		12.02-11.04	43/50					0 265 007 527 <sup>3</sup>		
							LAB,TKO	0 265 007 529 <sup>4</sup>		
							RAB,TKO	0 265 008 944 <sup>4</sup>		
<b>1.2</b>		03.98-11.02	43/55					0 265 006 383 <sup>3</sup>		
<b>1.2 i</b>							LAB,TKO	0 265 006 384 <sup>4</sup>		
<b>1.2 i 16V</b>							RAB,TKO	0 265 006 385 <sup>4</sup>		
<b>1.2, i, i 16V, 16V</b>		12.02→	43/55					0 265 007 527 <sup>3</sup>		
							LAB,TKO	0 265 007 529 <sup>4</sup>		
							RAB,TKO	0 265 008 944 <sup>4</sup>		
<b>1.4 i</b>		03.98-11.02	55/70-72					0 265 006 383 <sup>3</sup>		
<b>1.4 i 16V</b>							LAB,TKO	0 265 006 384 <sup>4</sup>		
							RAB,TKO	0 265 006 385 <sup>4</sup>		
		12.02-10.07	55/70-72					0 265 007 527 <sup>3</sup>		
							LAB,TKO	0 265 007 529 <sup>4</sup>		
							RAB,TKO	0 265 008 944 <sup>4</sup>		
<b>1.5 dCi</b>		06.01-11.02	48					0 265 006 383 <sup>3</sup>		
							LAB,TKO	0 265 006 384 <sup>4</sup>		
							RAB,TKO	0 265 006 385 <sup>4</sup>		
			60					0 265 006 383 <sup>3</sup>		
							LAB,TKO	0 265 006 384 <sup>4</sup>		
							RAB,TKO	0 265 006 385 <sup>4</sup>		
		12.02-10.07	48					0 265 007 527 <sup>3</sup>		
							LAB,TKO	0 265 007 529 <sup>4</sup>		
							RAB,TKO	0 265 008 944 <sup>4</sup>		
			60					0 265 007 527 <sup>3</sup>		
							LAB,TKO	0 265 007 529 <sup>4</sup>		
							RAB,TKO	0 265 008 944 <sup>4</sup>		
		03.03→	62/74					0 265 007 527 <sup>3</sup>		
							LAB,TKO	0 265 007 529 <sup>4</sup>		
							RAB,TKO	0 265 008 944 <sup>4</sup>		
		10.05-10.07	50					0 265 007 527 <sup>3</sup>		
							LAB,TKO	0 265 007 529 <sup>4</sup>		
							RAB,TKO	0 265 008 944 <sup>4</sup>		
		04.07→	47					0 265 007 527 <sup>3</sup>		
							LAB,TKO	0 265 007 529 <sup>4</sup>		
							RAB,TKO	0 265 008 944 <sup>4</sup>		
<b>1.6 i</b>		03.98-11.02	66/79/81					0 265 006 383 <sup>3</sup>		
<b>1.6 i 16V</b>							LAB,TKO	0 265 006 384 <sup>4</sup>		
							RAB,TKO	0 265 006 385 <sup>4</sup>		
		12.02-10.07	66/79/81					0 265 007 527 <sup>3</sup>		
							LAB,TKO	0 265 007 529 <sup>4</sup>		
							RAB,TKO	0 265 008 944 <sup>4</sup>		
<b>1.9 D</b>		03.98-11.02	47-48/59					0 265 006 383 <sup>3</sup>		
<b>1.9 D DTI</b>							LAB,TKO	0 265 006 384 <sup>4</sup>		
							RAB,TKO	0 265 006 385 <sup>4</sup>		
		12.02-10.07	47-48/59					0 265 007 527 <sup>3</sup>		
							LAB,TKO	0 265 007 529 <sup>4</sup>		
							RAB,TKO	0 265 008 944 <sup>4</sup>		
<b>2.0 16V</b>		03.99-11.02	124					0 265 006 383 <sup>3</sup>		
							LAB,TKO	0 265 006 384 <sup>4</sup>		
							RAB,TKO	0 265 006 385 <sup>4</sup>		
		12.02-10.07	124					0 265 007 527 <sup>3</sup>		
							LAB,TKO	0 265 007 529 <sup>4</sup>		
							RAB,TKO	0 265 008 944 <sup>4</sup>		
		03.03-10.07	124					0 265 008 945 <sup>3</sup>		



		S							
	◀ RENAULT Clio II [BB/CB/SB]								
	3.0 24V Sport	09.00-06.05	170/188				LAB	0 265 006 384 <sup>3</sup>	
								0 265 006 384 <sup>4</sup>	
							RAB	0 265 006 383 <sup>4</sup>	
								0 265 006 385 <sup>3</sup>	
<b>Clio II [BB07]</b>									
	1.5 dCi	06.03→	48					0 986 BB3 013	↔
		ABO 06.03→	48					F 026 002 480	↔ 19,05
<b>Clio II [CB01]</b>									
	1.6 i 16V	05.00-12.06	81					0 986 BB3 013	↔
	1.6 i 16V	05.00-12.06	81					0 265 006 383 <sup>3</sup>	
								0 265 006 385 <sup>4</sup>	
							LAB	0 265 006 384 <sup>3</sup>	
							RAB	0 265 006 385 <sup>3</sup>	
<b>Clio II [LB02]</b>									
	1.9 D	03.00→	48					0 986 BB3 013	↔
<b>Clio II Sedan</b>									
	1.2 i 16V	01.00-11.02	55					0 986 BB3 013	↔
	1.6 i 16V	01.01-10.04	81					0 986 BB3 013	↔
	1.6 i 16V	01.01-10.04	81					0 265 006 385 <sup>4</sup>	
								0 265 007 527 <sup>3</sup>	
							LAB	0 265 006 384 <sup>4</sup>	
							RAB	0 265 006 385 <sup>3</sup>	
<b>Clio III [BR/CR]</b>									
	1.2	06.05→	48/55/					0 986 134 329	← 54
	1.2 TCe		57,5/74					0 986 135 329	→ 54
	1.4	06.05→	72					0 986 134 329	← 54
								0 986 135 329	→ 54
	1.5 dCi	06.05→	50/55/63/					0 986 134 329	← 54
			65/78					0 986 135 329	→ 54
	1.6	06.05→	65/82/94					0 986 134 329	← 54
								0 986 135 329	→ 54
	2.0	06.05→	102					0 986 473 335	← 54
								0 986 474 335	→ 54
	1.2, TCe	06.05→	48/55/57,5/74					0 986 475 934	↔ 19,05
	1.4	06.05→	72					0 986 475 934	↔ 19,05
	1.5 dCi	06.05→	50/55/63/65/78					0 986 475 934	↔ 19,05
	1.6	06.05→	65/82/94					0 986 475 934	↔ 19,05



		S									
	2.0, R.S., Sport	06.05→	102/145/147,5				0 986 475 934	↔ 19,05			
	1.2	06.05→	48/55/				0 986 134 011	↔ 34			
	1.2 TCe		57,5/74				0 986 135 011	↔ 34			
	1.4	06.05→	72				0 986 134 011	↔ 34			
							0 986 135 011	↔ 34			
	1.5 dCi	06.05→	50/55/63/ 65/78				0 986 134 011	↔ 34			
							0 986 135 011	↔ 34			
	1.6	06.05→	65/82/94				0 986 134 011	↔ 34			
							0 986 135 011	↔ 34			
	2.0	06.05→	102				0 986 134 011	↔ 34			
							0 986 135 011	↔ 34			
2.0 R.S. 2.0 Sport	12.05→	145/147,5			KZU	0 986 473 412	↔ 38				
						0 986 474 412	↔ 38				
	1.2	06.05-12.08	48			HTB	1 987 477 965	→ 1587			
							1 987 477 966	← 1451			
							4SB	1 987 482 385	← 1322		
								1 987 482 386	→ 1448		
	1.2 1.2 TCe	06.05→	55/57,5/ 74				15Z,HTB	1 987 477 965	→ 1587		
								1 987 477 966	← 1451		
								16Z,HTB	1 987 482 383	← 1440	
									1 987 482 384	→ 1572	
	1.4	06.05→	72				4SB	1 987 482 385	← 1322		
									1 987 482 386	→ 1448	
15Z,HTB								1 987 477 965	→ 1587		
									1 987 477 966	← 1451	
16Z,HTB	1 987 482 383	← 1440									
		1 987 482 384	→ 1572								
1.5 dCi	06.05-10.09	50				HTB	1 987 477 965	→ 1587			
							1 987 477 966	← 1451			
								1 987 477 965	→ 1587		
								1 987 477 966	← 1451		
	06.05→	50					15Z,HTB	1 987 477 965	→ 1587		
								1 987 477 966	← 1451		
								16Z,HTB	1 987 482 383	← 1440	
									1 987 482 384	→ 1572	
		4SB	1 987 482 385	← 1322							
				1 987 482 386	→ 1448						
			63	15Z,HTB	1 987 477 965	→ 1587					
						1 987 477 966	← 1451				
16Z,HTB	1 987 482 383	← 1440									
		1 987 482 384	→ 1572								
65/78	15Z,HTB	1 987 477 965	→ 1587								
			1 987 477 966	← 1451							
		16Z,HTB	1 987 482 383	← 1440							
			1 987 482 384	→ 1572							
	4SB	1 987 482 385	← 1322								
			1 987 482 386	→ 1448							
		11.10→	55				15Z,HTB	1 987 477 965	→ 1587		
									1 987 477 966	← 1451	
16Z,HTB	1 987 482 383	← 1440									
		1 987 482 384	→ 1572								
4SB	1 987 482 385	← 1322									
		1 987 482 386	→ 1448								
1.6	06.05→	65/82/94				15Z,HTB	1 987 477 965	→ 1587			
							1 987 477 966	← 1451			





◀ RENAULT Clio III [BR/CR]						
1.6	06.05→	65/82/94	16Z,HTB	1987 482 383	← 1440	
				1987 482 384	→ 1572	
4SB				1987 482 385	← 1322	
				1987 482 386	→ 1448	
2.0	06.05→	102	15Z,HTB	1987 477 965	→ 1587	
				1987 477 966	← 1451	
16Z,HTB				1987 482 383	← 1440	
				1987 482 384	→ 1572	
4SB				1987 482 385	← 1322	
				1987 482 386	→ 1448	
2.0 R.S.	12.05→	145/147,5		1987 482 334	→ 1596	
2.0 Sport				1987 482 335	← 1458	

1.2	06.05→	48/55/57,5/74		0 265 008 922 <sup>3</sup>		
				0 265 008 923 <sup>4</sup>		
1.2 TCe	MFD 06.05→	48/55/57,5/74		0 265 008 923 <sup>4</sup>		
	OFD 06.05→	48/55/57,5/74	LAB	0 265 007 606 <sup>4</sup>		
1.4	06.05→	72		0 265 008 922 <sup>3</sup>		
				0 265 008 923 <sup>4</sup>		
MFD 06.05→				0 265 008 923 <sup>4</sup>		
				0 265 007 606 <sup>4</sup>		
OFD 06.05→				0 265 008 925 <sup>4</sup>		
				0 265 008 925 <sup>4</sup>		
1.5 dCi	06.05→	50/55/63/65/78		0 265 008 922 <sup>3</sup>		
				0 265 008 923 <sup>4</sup>		
MFD 06.05→				0 265 008 923 <sup>4</sup>		
				0 265 007 606 <sup>4</sup>		
OFD 06.05→				0 265 008 925 <sup>4</sup>		
				0 265 008 925 <sup>4</sup>		
1.6	06.05→	65/82/94		0 265 008 922 <sup>3</sup>		
				0 265 008 923 <sup>4</sup>		
MFD 06.05→				0 265 008 923 <sup>4</sup>		
				0 265 007 606 <sup>4</sup>		
OFD 06.05→				0 265 008 925 <sup>4</sup>		
				0 265 008 925 <sup>4</sup>		
2.0	06.05→	102		0 265 008 922 <sup>3</sup>		
				0 265 008 923 <sup>4</sup>		
MFD 06.05→				0 265 008 923 <sup>4</sup>		
				0 265 007 606 <sup>4</sup>		
OFD 06.05→				0 265 008 925 <sup>4</sup>		
				0 265 008 925 <sup>4</sup>		
2.0 R.S.	12.05→	145/147,5		0 265 008 928 <sup>4</sup>		
2.0 Sport				0 265 007 809 <sup>3</sup>		

**Clio III Grandtour [KR]**

1.2	08.07→	55/57,5/74		0 986 134 329	↔ 54	
				0 986 135 329	↔ 54	
1.2 TCe				0 986 134 329	↔ 54	
1.4	08.07→	72		0 986 134 329	↔ 54	
				0 986 135 329	↔ 54	
1.5 dCi	08.07→	50/55/63/65/78		0 986 134 329	↔ 54	
				0 986 135 329	↔ 54	
1.6	08.07→	65/82/94		0 986 134 329	↔ 54	
				0 986 135 329	↔ 54	

1.2, TCe	08.07→	55/57,5/74		0 986 475 934	↔ 19,05	
1.4	08.07→	72		0 986 475 934	↔ 19,05	
1.5 dCi	08.07→	50/55/63/65/78		0 986 475 934	↔ 19,05	
1.6	08.07→	65/82/94		0 986 475 934	↔ 19,05	

1.2	08.07→	55/57,5/74		0 986 134 011	↔ 34	
				0 986 135 011	↔ 34	
1.2 TCe				0 986 134 011	↔ 34	
1.4	08.07→	72		0 986 134 011	↔ 34	
				0 986 135 011	↔ 34	
1.5 dCi	08.07→	50/55/63/65/78		0 986 134 011	↔ 34	
				0 986 135 011	↔ 34	
1.6	08.07→	65/82/94		0 986 134 011	↔ 34	
				0 986 135 011	↔ 34	

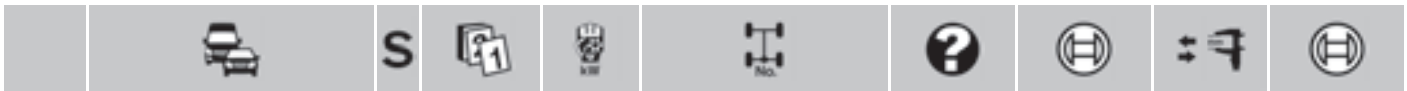

	1.2	08.07→	55/57,5/	HTB	1 987 477 965	→ 1587
	1.2 TCe		74	4SB	1 987 477 966	← 1451
					1 987 482 385	← 1322
					1 987 482 386	→ 1448
	1.4	08.07→	72	HTB	1 987 477 965	→ 1587
					1 987 477 966	← 1451
				4SB	1 987 482 385	← 1322
					1 987 482 386	→ 1448
	1.5 dCi	08.07→	50	HTB	1 987 477 965	→ 1587
					1 987 477 966	← 1451
				4SB	1 987 482 385	← 1322
					1 987 482 386	→ 1448
			63	HTB	1 987 477 965	→ 1587
					1 987 477 966	← 1451
				4SB	1 987 482 385	← 1322
					1 987 482 386	→ 1448
			78	HTB	1 987 477 965	→ 1587
					1 987 477 966	← 1451
				4SB	1 987 482 385	← 1322
					1 987 482 386	→ 1448
		11.10→	55	15Z,HTB	1 987 477 965	→ 1587
					1 987 477 966	← 1451
				16Z,HTB	1 987 482 383	← 1440
					1 987 482 384	→ 1572
				4SB	1 987 482 385	← 1322
					1 987 482 386	→ 1448
			65	15Z,HTB	1 987 477 965	→ 1587
					1 987 477 966	← 1451
				16Z,HTB	1 987 482 383	← 1440
					1 987 482 384	→ 1572
				4SB	1 987 482 385	← 1322
					1 987 482 386	→ 1448
	1.6	08.07→	65/82	HTB	1 987 477 965	→ 1587
					1 987 477 966	← 1451
				4SB	1 987 482 385	← 1322
					1 987 482 386	→ 1448

	1.2	08.07→	55/57,5/74		0 265 008 922 <sup>3</sup>	
	1.2 TCe	MFD 08.07→	55/57,5/74		0 265 008 923 <sup>4</sup>	
		OFD 08.07→	55/57,5/	LAB	0 265 007 606 <sup>4</sup>	
			74	RAB	0 265 008 925 <sup>4</sup>	
	1.4	08.07→	72		0 265 008 922 <sup>3</sup>	
		MFD 08.07→	72		0 265 008 923 <sup>4</sup>	
		OFD 08.07→	72	LAB	0 265 007 606 <sup>4</sup>	
				RAB	0 265 008 925 <sup>4</sup>	
	1.5 dCi	08.07→	50/55/63/65/78		0 265 008 922 <sup>3</sup>	
		MFD 08.07→	50/55/63/65/78		0 265 008 923 <sup>4</sup>	
		OFD 08.07→	50/55/63/	LAB	0 265 007 606 <sup>4</sup>	
			65/78	RAB	0 265 008 925 <sup>4</sup>	
	1.6	08.07→	65/82/94		0 265 008 922 <sup>3</sup>	
		MFD 08.07→	65/82/94		0 265 008 923 <sup>4</sup>	
		OFD 08.07→	65/82/94	LAB	0 265 007 606 <sup>4</sup>	
				RAB	0 265 008 925 <sup>4</sup>	

**Clio IV [BH]**



	0.9	05.12→	66	B17	0 986 134 329	← 54
					0 986 135 329	→ 54
	1.2	05.12→	55	B17	0 986 134 329	← 54
					0 986 135 329	→ 54



		S							
	<b>RENAULT Clio IV [BH]</b>								
	1.2 TCe	01.13→	88				0986 134 329		← 54
							0986 135 329		→ 54
	1.5 dCi	05.12→	55/66		B17		0986 134 329		← 54
							0986 135 329		→ 54
	0.9	05.12→	66		TW		F 026 002 249		↔ 17,5
							F 026 002 572		↔ 19
	1.2	05.12→	55				F 026 002 249		↔ 17,5
	1.2 TCe	01.13→	88				F 026 002 572		↔ 19
	1.5 dCi	05.12→	55/66				F 026 002 249		↔ 17,5
	<b>Clio IV Grandtour [KH]</b>								
	0.9	11.12→	66		B17		0986 134 329		← 54
							0986 135 329		→ 54
	1.2	11.12→	54		B17		0986 134 329		← 54
							0986 135 329		→ 54
	1.2 TCe	01.13→	88				0986 134 329		← 54
							0986 135 329		→ 54
	1.5 dCi	11.12→	55/66		B17		0986 134 329		← 54
							0986 135 329		→ 54
	0.9	11.12→	66				F 026 002 572		↔ 19
	1.2	11.12→	54				F 026 002 249		↔ 17,5
	1.2 TCe	01.13→	88				F 026 002 572		↔ 19
	1.5 dCi	11.12→	55/66				F 026 002 249		↔ 17,5
	<b>Duster [HS]</b>								
	1.2	09.13→	92		TW		0986 134 329		← 54
							0986 135 329		→ 54
	1.5 dCi	09.13→	66		TW		0986 134 329		← 54
							0986 135 329		→ 54
	1.5 dCi	09.13→	80		TW		0986 134 329		← 54
	1.5 dCi 4x4						0986 135 329		→ 54
	1.5 dCi 4x4	ABO 03.12→	66				0986 134 329		← 54
							0986 135 329		→ 54
	1.6	09.13→	77		TW		0986 134 329		← 54
							0986 135 329		→ 54
	1.6	ABO 03.12→	75				0986 134 329		← 54
	1.6 4x4						0986 135 329		→ 54
	2.0	ABO 03.12→	99				0986 134 329		← 54
	2.0 4x4						0986 135 329		→ 54
	1.2	09.13→	92				F 026 002 572		↔ 19
	1.5 dCi	09.13→	66				F 026 002 572		↔ 19
	1.5 dCi	09.13→	80				0986 475 987		← 19,05
	1.5 dCi 4x4						0986 475 988		→ 19,05
	1.5 dCi 4x4	03.12→	66				0986 475 987		← 19,05
							0986 475 988		→ 19,05
	1.6	03.12→	75				F 026 002 572		↔ 19
		09.13→	77				0986 475 987		← 19,05
							0986 475 988		→ 19,05
	1.6 4x4	03.12→	75				0986 475 987		← 19,05
							0986 475 988		→ 19,05
	2.0	03.12→	99				F 026 002 572		↔ 19

R

		S							
2.0 4x4		03.12→	99				0 986 475 987	← 19,05	
							0 986 475 988	→ 19,05	
	1.2	09.13→	92				1 987 482 410	↔ 1787	
	1.5 dCi	09.13→	66				1 987 482 410	↔ 1787	
			80				1 987 482 411	↔ 1720	
	1.5 dCi 4x4	03.12→	66				1 987 482 411	↔ 1720	
		09.13→	80				1 987 482 411	↔ 1720	
	1.6	03.12→	75				1 987 482 410	↔ 1787	
		09.13→	77				1 987 482 411	↔ 1720	
	1.6 4x4	03.12→	75				1 987 482 411	↔ 1720	
	2.0	03.12→	99				1 987 482 410	↔ 1787	
	2.0 4x4	03.12→	99				1 987 482 411	↔ 1720	
	1.2	09.13→	92				0 265 008 941 <sup>3</sup>		
				LAB			0 265 008 937 <sup>4</sup>		
				RAB			0 265 008 936 <sup>4</sup>		
	1.5 dCi	09.13→	66				0 265 008 941 <sup>3</sup>		
				LAB			0 265 008 937 <sup>4</sup>		
				RAB			0 265 008 936 <sup>4</sup>		
	1.5 dCi	09.13→	80				0 265 008 941 <sup>3</sup>		
	1.5 dCi 4x4						0 265 008 942 <sup>4</sup>		
	1.5 dCi 4x4	03.12→	66				0 265 008 941 <sup>3</sup>		
							0 265 008 942 <sup>4</sup>		
	1.6	03.12→	75				0 265 008 941 <sup>3</sup>		
				LAB			0 265 008 937 <sup>4</sup>		
				RAB			0 265 008 936 <sup>4</sup>		
		09.13→	77				0 265 008 941 <sup>3</sup>		
							0 265 008 942 <sup>4</sup>		
	1.6 4x4	03.12→	75				0 265 008 941 <sup>3</sup>		
							0 265 008 942 <sup>4</sup>		
2.0	03.12→	99				0 265 008 941 <sup>3</sup>			
						0 265 008 937 <sup>4</sup>			
						0 265 008 936 <sup>4</sup>			
2.0 4x4	03.12→	99				0 265 008 941 <sup>3</sup>			
						0 265 008 942 <sup>4</sup>			
<b>Espace II [J63]</b>									
	2.0 i	01.91-09.96	77				0 986 473 665	↔ 54	
							0 986 474 665	↔ 54	
	2.1 D Turbo	01.91-09.96	65/66				0 986 473 665	↔ 54	
							0 986 474 665	↔ 54	
	2.2 i	01.91-09.96	79-81				0 986 473 665	↔ 54	
	2.2 i 4x4						0 986 474 665	↔ 54	
	2.9 i	01.91-09.96	110-113				0 986 473 784	↔ 60	
						0 986 473 785	↔ 60		
	2.0 i	01.93-09.96	77	Fg.-Nr. K1013→, T11209→	NW	GIR	0 986 475 677	↔ 22,2	
	2.1 D Turbo	06.92-09.96	65		NW	GIR	0 986 475 677	↔ 22,2	
		01.93-09.96	65	Fg.-Nr. K2543→, T9787→, T0215→		GIR	0 986 475 677	↔ 22,2	
	2.2 i	01.93-09.96	79-81	Fg.-Nr. K3955→, T31217→, T0090→		GIR	0 986 475 677	↔ 22,2	
	2.2 i 4x4	01.93-09.96	79-81	Fg.-Nr. K3955→, T31217→, T0090→		GIR	0 986 475 677	↔ 22,2	
		05.93-09.96	79-81		NW	GIR	0 986 475 677	↔ 22,2	
	2.0 i	01.91-09.96	77				0 204 102 039	← 36	0 204 104 066 <sup>9</sup>
							0 204 103 039	↔	0 204 104 219 <sup>7</sup>
							0 204 102 041	→ 36	0 204 104 066 <sup>9</sup>
							0 204 103 041	↔	





		S												
<b>RENAULT Espace II [J63]</b>														
	2.1 D Turbo	01.91-09.96	65/66				0 204 102 039	← 36	0 204 104 066 <sup>9</sup>					
							0 204 103 039		0 204 104 219 <sup>7</sup>					
							0 204 102 041	→ 36	0 204 104 066 <sup>9</sup>					
							0 204 103 041							
	2.2 i	01.91-09.96	79-81				0 204 102 039	← 36	0 204 104 066 <sup>9</sup>					
							0 204 103 039		0 204 104 219 <sup>7</sup>					
							0 204 102 041	→ 36	0 204 104 066 <sup>9</sup>					
							0 204 103 041							
	2.2 i 4x4	01.91-09.96	79-81				0 204 102 247	← 36	0 204 104 219 <sup>7</sup>					
							0 204 103 247							
							0 204 102 248	→ 36	0 204 104 219 <sup>7</sup>					
							0 204 103 248							
	2.9 i	01.91-09.96	110-113		SBR		0 204 102 039	← 36	0 204 104 066 <sup>9</sup>					
							0 204 103 039		0 204 104 219 <sup>7</sup>					
							0 204 102 041	→ 36	0 204 104 066 <sup>9</sup>					
							0 204 103 041							
	2.0 i	01.91-09.96	77		SBR		1 987 477 154	→ 1891						
							1 987 477 155	← 1285						
	2.1 D Turbo	01.91-09.96	65/66		TBR		1 987 477 334	← 1045						
							1 987 477 335	→ 1984						
	2.2 i	01.91-09.96	79-81		SBR		1 987 477 154	→ 1891						
							1 987 477 155	← 1285						
	2.9 i	01.91-09.96	110-113		TBR		1 987 477 334	← 1045						
							1 987 477 335	→ 1984						
	2.0 i	01.91-09.96	77		SBR		1 987 477 154	→ 1891						
							1 987 477 155	← 1285						
	2.1 D Turbo	01.91-09.96	65/66		TBR		1 987 477 334	← 1045						
							1 987 477 335	→ 1984						
	2.2 i	01.91-09.96	79-81		SBR		1 987 477 154	→ 1891						
							1 987 477 155	← 1285						
	2.9 i	01.91-09.96	110-113		TBR		1 987 477 334	← 1045						
							1 987 477 335	→ 1984						
	2.0 i	01.91-09.96	77		SBR		1 987 477 154	→ 1891						
							1 987 477 155	← 1285						
	2.1 D Turbo	01.91-09.96	65/66		TBR		1 987 477 334	← 1045						
							1 987 477 335	→ 1984						
	2.2 i	01.91-09.96	79-81		SBR		1 987 477 154	→ 1891						
							1 987 477 155	← 1285						
	2.9 i	01.91-09.96	110-113		TBR		1 987 477 334	← 1045						
							1 987 477 335	→ 1984						
	2.0 i	01.91-09.96	77		SBR		1 987 477 154	→ 1891						
							1 987 477 155	← 1285						
	2.1 D Turbo	01.91-09.96	65/66		TBR		1 987 477 334	← 1045						
							1 987 477 335	→ 1984						
	2.2 i	01.91-09.96	79-81		SBR		1 987 477 154	→ 1891						
							1 987 477 155	← 1285						
	2.9 i	01.91-09.96	110-113		TBR		1 987 477 334	← 1045						
							1 987 477 335	→ 1984						
	2.0 i	01.91-09.96	77		SBR		1 987 477 154	→ 1891						
							1 987 477 155	← 1285						
	2.1 D Turbo	01.91-09.96	65/66		TBR		1 987 477 334	← 1045						
							1 987 477 335	→ 1984						
	2.2 i	01.91-09.96	79-81		SBR		1 987 477 154	→ 1891						
							1 987 477 155	← 1285						
	2.9 i	01.91-09.96	110-113		TBR		1 987 477 334	← 1045						
							1 987 477 335	→ 1984						
	2.0 i	01.91-09.96	77		SBR		1 987 477 154	→ 1891						
							1 987 477 155	← 1285						
	2.1 D Turbo	01.91-09.96	65/66		TBR		1 987 477 334	← 1045						
							1 987 477 335	→ 1984						
	2.2 i	01.91-09.96	79-81		SBR		1 987 477 154	→ 1891						
							1 987 477 155	← 1285						
	2.9 i	01.91-09.96	110-113		TBR		1 987 477 334	← 1045						
							1 987 477 335	→ 1984						
<b>Espace III [JE0]</b>														
	1.9 dTi	02.99-10.02	72				0 986 473 786	← 54						
							0 986 473 787	→ 54						
	2.0 i, i GPL, i 16V	10.96-10.02	83,5/ 102-103				0 986 473 786	← 54						
							0 986 473 787	→ 54						
	2.2 D Turbo	10.96-10.02	83				0 986 473 788	← 60						
							0 986 473 789	→ 60						
	3.0 i V6	10.96-10.02	123				0 986 473 788	← 60						
							0 986 473 789	→ 60						
	1.9 dTi	02.99-10.02	72				0 986 475 677	↔ 22,2						
							2.0 i, i GPL	10.96-10.02	83,5				0 986 475 677	↔ 22,2
													2.2 D Turbo	10.96-10.02











R

	<b>2.0i 16V</b>	10.98-07.00	102-103			0 986 473 175	← 35,92
						0 986 474 175	→ 35,92
		07.00-10.02	102-103			0 986 473 495	← 38
						0 986 474 495	→ 38
	<b>2.2 dCi</b>	07.00-10.02	85-95			0 986 473 495	← 38
						0 986 474 495	→ 38
	<b>3.0i V6</b>	10.96-10.02	123			0 986 473 175	← 35,92
						0 986 474 175	→ 35,92
	<b>3.0i V6 24V</b>	10.98-07.00	140			0 986 473 175	← 35,92
						0 986 474 175	→ 35,92
		08.00-10.02	140			0 986 473 495	← 38
						0 986 474 495	→ 38
	<b>1.9 dTi</b>	02.99-10.02	72		FKR	1 987 477 616	1583
					FLR,SAZ	1 987 482 144	1740
	<b>2.0i</b>	10.96-10.02	83,5		FKR	1 987 477 616	1583
	<b>2.0i GPL</b>				FLR,SAZ	1 987 482 144	1740
	<b>2.0i 16V</b>	10.98-07.00	102-103		FKR	1 987 477 615	1635
	<b>2.2 D Turbo</b>	10.96-10.02	83		FKR	1 987 477 616	1583
					FLR,SAZ	1 987 482 144	1740
	<b>3.0i V6</b>	10.96-10.02	123			1 987 477 615	1635
	<b>3.0i V6 24V</b>	10.98-07.00	140		FKR	1 987 477 615	1635
	<b>1.9 dTi</b>	02.99-10.02	72			0 265 006 284 <sup>4</sup>	
					LAB	0 265 006 283 <sup>3</sup>	
					RAB	0 265 006 282 <sup>3</sup>	
	<b>2.0i</b>	10.96-10.02	83,5/ 102-103			0 265 006 284 <sup>4</sup>	
	<b>2.0i GPL</b>				LAB	0 265 006 283 <sup>3</sup>	
	<b>2.0i 16V</b>				RAB	0 265 006 282 <sup>3</sup>	
	<b>2.2 D Turbo</b>	10.96-10.02	83/85-95			0 265 006 284 <sup>4</sup>	
	<b>2.2 dCi</b>				LAB	0 265 006 283 <sup>3</sup>	
					RAB	0 265 006 282 <sup>3</sup>	
	<b>3.0i V6</b>	10.96-10.02	123/140			0 265 006 284 <sup>4</sup>	
	<b>3.0i V6 24V</b>				LAB	0 265 006 283 <sup>3</sup>	
					RAB	0 265 006 282 <sup>3</sup>	
<b>Espace IV [JK]</b>							
	<b>1.9 dCi</b>	11.02-12.06	88			0 986 134 328	← 60
						0 986 135 328	→ 60
	<b>2.0, dCi, TCe, Turbo, 16V</b>	11.02→	96/100-103/110/120/ 123-125/127			0 986 134 328	← 60
						0 986 135 328	→ 60
	<b>2.2 dCi</b>	11.02→	102/110			0 986 134 328	← 60
						0 986 135 328	→ 60
	<b>3.0 dCi</b>	11.02→	130/133			0 986 134 328	← 60
						0 986 135 328	→ 60
	<b>3.5</b>	11.02→	177			0 986 134 328	← 60
						0 986 135 328	→ 60
	<b>1.9 dCi</b>	11.02-12.06	88			0 986 473 226	← 37,93
						0 986 474 226	→ 37,93
	<b>2.0, dCi, TCe, Turbo, 16V</b>	11.02→	96/100-103/110/120/ 123-125/127			0 986 473 226	← 37,93
						0 986 474 226	→ 37,93
	<b>2.2 dCi</b>	11.02→	102/110			0 986 473 226	← 37,93
						0 986 474 226	→ 37,93
	<b>3.0 dCi</b>	11.02→	130/133			0 986 473 226	← 37,93
						0 986 474 226	→ 37,93



	◀ RENAULT Espace IV [JK]								
	3.5	11.02→	177				0986 473 226	← 37,93	
							0986 474 226	→ 37,93	
<b>Express</b>									
	1.9 D	07.95-09.02	40				0986 475 677	↔ 22,2	
<b>Express, Extra, Rapid [F40]</b>									
	Electrique	09.94-10.97	21			BSY	0 204 102 249	← 48	0 204 100 127 <sup>8</sup>
							0986 473 101		0 204 104 052 <sup>7</sup>
							0 204 102 250	→ 48	0 204 100 127 <sup>8</sup>
							0986 474 101		
	1.1	09.91-10.97	36			BSY	0 204 102 249	← 48	0 204 100 127 <sup>8</sup>
							0986 473 101		0 204 104 052 <sup>7</sup>
							0 204 102 250	→ 48	0 204 100 127 <sup>8</sup>
							0986 474 101		
						GIR	0986 473 671	← 48	
							0986 474 671	→ 48	
	1.2	09.91-10.97	40			BSY	0 204 102 249	← 48	0 204 100 127 <sup>8</sup>
	1.2 i						0986 473 101		0 204 104 052 <sup>7</sup>
							0 204 102 250	→ 48	0 204 100 127 <sup>8</sup>
							0986 474 101		
						GIR	0986 473 671	← 48	
							0986 474 671	→ 48	
	1.4	06.87-10.97	43/44/			BSY	0 204 102 249	← 48	0 204 100 127 <sup>8</sup>
	1.4 i		55-59				0986 473 101		0 204 104 052 <sup>7</sup>
							0 204 102 250	→ 48	0 204 100 127 <sup>8</sup>
							0986 474 101		
						GIR	0986 473 671	← 48	
							0986 474 671	→ 48	
	1.6 D	03.86-03.97	40			BSY	0 204 102 249	← 48	0 204 100 127 <sup>8</sup>
							0986 473 101		0 204 104 052 <sup>7</sup>
							0 204 102 250	→ 48	0 204 100 127 <sup>8</sup>
							0986 474 101		
		06.86-03.97	40	Fg.-Nr. E008445→, J020151→		GIR	0986 473 671	← 48	
							0986 474 671	→ 48	
		09.91-03.97	40			GIR	0986 473 671	← 48	
							0986 474 671	→ 48	
	1.9 D	09.91-09.97	47-48			BSY	0 204 102 250	→ 48	0 204 104 052 <sup>7</sup>
							0986 474 101		
		09.91-10.97	47-48			BSY	0 204 102 249	← 48	0 204 100 127 <sup>8</sup>
							0986 473 101		0 204 104 052 <sup>7</sup>
							0 204 102 250	→ 48	0 204 100 127 <sup>8</sup>
							0986 474 101		
						GIR	0986 473 671	← 48	
							0986 474 671	→ 48	
		09.94-09.97	40			BSY	0 204 102 249	← 48	0 204 100 127 <sup>8</sup>
							0986 473 101		0 204 104 052 <sup>7</sup>
							0 204 102 250	→ 48	0 204 100 127 <sup>8</sup>
							0986 474 101		
<b>Electrique</b>									
	Electrique	06.96-10.97	21			GIR	0986 475 677	↔ 22,2	
	1.1	09.91-09.96	36			BSY	F 026 002 139	← 22	
							F 026 002 140	→ 22	
							F 026 002 176	← 22,2	
							F 026 002 177	→ 22,2	































	<b>S</b>								
<b>1.1</b>	09.91-10.97	36				GIR	0 986 <b>475 233</b>	← 22,2 → 22,2	
	10.96-10.97	36				BSY	F 026 <b>002 133</b> F 026 <b>002 134</b>	← 20,6 → 20,6	
<b>1.2</b>	09.91-09.96	40				BSY	F 026 <b>002 134</b>	→ 20,6	
<b>1.2,i</b>	09.91-10.97	40				BSY	F 026 <b>002 133</b>	← 20,6	
<b>1.2i</b>	09.91-10.97	40				BSY	F 026 <b>002 134</b>	→ 20,6	
	10.96-10.97	40			ERH	GIR	0 986 <b>475 677</b>	↔ 22,2	
<b>1.4</b>	06.87-09.97	44				ERH	GIR	0 986 <b>475 677</b>	↔ 22,2
	09.91-09.96	43				BSY	F 026 <b>002 133</b> F 026 <b>002 134</b>	← 20,6 → 20,6	
					ERH	GIR	0 986 <b>475 677</b>	↔ 22,2	
	09.91-09.97	43				GIR	0 986 <b>475 677</b>	↔ 22,2	
<b>1.4</b>	06.87-09.97	44				BSY	F 026 <b>002 133</b>	← 20,6	
<b>1.4i</b>							F 026 <b>002 134</b> F 026 <b>002 139</b> F 026 <b>002 140</b>	→ 20,6 ← 22 → 22	
<b>1.4i</b>	09.91-10.97	55-59				BSY	F 026 <b>002 133</b> F 026 <b>002 134</b>	← 20,6 → 20,6	
					ERH	GIR	0 986 <b>475 677</b>	↔ 22,2	
<b>1.6D</b>	03.86-03.97	40				BSY	F 026 <b>002 133</b> F 026 <b>002 134</b>	← 20,6 → 20,6	
	07.86-03.97	40				BSY	F 026 <b>002 139</b> F 026 <b>002 140</b>	← 22 → 22	
					ERH	GIR	0 986 <b>475 677</b>	↔ 22,2	
<b>1.9D</b>	09.91-10.97	40/47-48				BSY	F 026 <b>002 133</b> F 026 <b>002 134</b>	← 20,6 → 20,6	
					ERH	GIR	0 986 <b>475 677</b>	↔ 22,2	
									
<b>1.1</b>	09.91-10.97	36					1 987 <b>477 461</b>	↔ 1469	
<b>1.2</b>	09.91-09.96	40					1 987 <b>477 461</b>	↔ 1469	
<b>1.2i</b>	09.91-10.97	40					1 987 <b>477 461</b>	↔ 1469	
<b>1.4</b>	06.87-09.97	44					1 987 <b>477 156</b>	↔ 1330	
	09.91-09.96	43				2TO,ERH 4TO,NON	1 987 <b>477 462</b> 1 987 <b>477 461</b>	↔ 1465 ↔ 1469	
	09.91-09.97	43					1 987 <b>477 462</b>	↔ 1465	
<b>1.4i</b>	09.91-03.97	44					1 987 <b>477 461</b>	↔ 1469	
	09.91-10.97	55-59				2TO,ERH 4TO,NON	1 987 <b>477 462</b> 1 987 <b>477 461</b>	↔ 1465 ↔ 1469	
<b>1.6D</b>	09.91-03.97	40					1 987 <b>477 156</b>	↔ 1330	
						2TO,ERH 4TO,NON	1 987 <b>477 462</b> 1 987 <b>477 461</b>	↔ 1465 ↔ 1469	
<b>1.9D</b>	09.91-10.97	40/47-48				2TO,ERH 4TO,NON	1 987 <b>477 462</b> 1 987 <b>477 461</b>	↔ 1465 ↔ 1469	
<b>Fluence [L3]</b>									
									
<b>1.5 dCi</b>	11.09→	63/66/70/78/81					0 986 <b>475 934</b>	↔ 19,05	
<b>1.6, dCi</b>	11.09→	81-85/96					0 986 <b>475 934</b>	↔ 19,05	
<b>2.0</b>	02.10→	103					0 986 <b>475 934</b>	↔ 19,05	
									
<b>1.5 dCi</b>	11.09→	63/66/70/78/81					0 265 <b>008 173</b> <sup>4</sup> 0 265 <b>008 941</b> <sup>3</sup>		
<b>1.6</b>	11.09→	81-85/96					0 265 <b>008 173</b> <sup>4</sup>		
<b>1.6 dCi</b>							0 265 <b>008 941</b> <sup>3</sup>		
<b>2.0</b>	02.10→	103					0 265 <b>008 173</b> <sup>4</sup> 0 265 <b>008 941</b> <sup>3</sup>		



		S									
◀ RENAULT											
<b>Grand Scenic II [JM]</b>											
	1.4 16V	05.03-10.05	72				0 204 004 342	←	54		
							0 204 004 343	→	54		
		0 986 473 334	↔								
		11.05-04.09	72				0 986 473 335	↔	←	54	
		0 986 474 334	↔								
		0 986 474 335	↔				→	54			
	1.5 dCi	05.03-10.05	60/63/ 74-78					0 204 004 342	←	54	
								0 204 004 343	→	54	
		0 986 473 334	↔								
		11.05-04.09	60/63/ 74-78					0 986 134 282	↔	←	54
		0 986 135 282	↔					→	54		
		0 986 474 334	↔								
1.6 16V	05.03-10.05	83					0 204 004 342	←	54		
							0 204 004 343	→	54		
	0 986 473 334	↔									
	11.05-04.09	83					0 986 134 282	↔	←	54	
	0 986 135 282	↔					→	54			
	0 986 474 334	↔									
1.9 dCi	05.03-10.05	81/88/96					0 204 004 342	←	54		
							0 204 004 343	→	54		
	0 986 473 334	↔									
	11.05-04.09	81/88/96					0 986 134 282	↔	←	54	
	0 986 135 282	↔					→	54			
	0 986 474 334	↔									
2.0 dCi 2.0 16V 2.0 16V Turbo	05.03-10.05	98-99/110/ 120					0 204 004 342	←	54		
							0 204 004 343	→	54		
	0 986 473 334	↔									
	11.05-04.09	98-99/110/ 120					0 986 134 282	↔	←	54	
	0 986 135 282	↔					→	54			
	0 986 474 334	↔									
	1.4 16V	05.03-04.09	72				FEB 0 986 473 413	↔	←	38	
							FEB 0 986 474 413	↔	→	38	
		FEB 0 986 473 412	↔				←	38			
		FEB 0 986 474 412	↔				→	38			
		1.5 dCi	05.03-04.09				60/63/ 74-78	FEB 0 986 473 413	↔	←	38
								FEB 0 986 474 413	↔	→	38
	FEB 0 986 473 412	↔	←	38							
	FEB 0 986 474 412	↔	→	38							
	1.6 16V	05.03-04.09	83	FEB 0 986 473 413	↔	←	38				
				FEB 0 986 474 413	↔	→	38				
	FEB 0 986 473 412	↔	←	38							
	FEB 0 986 474 412	↔	→	38							
1.9 dCi	05.03-04.09	81/88/96	FEB 0 986 473 413	↔	←	38					
			FEB 0 986 474 413	↔	→	38					
FEB 0 986 473 412	↔	←	38								
FEB 0 986 474 412	↔	→	38								
2.0 dCi 2.0 16V 2.0 16V Turbo	05.03-04.09	98-99/110/ 120	FEB 0 986 473 413	↔	←	38					
			FEB 0 986 474 413	↔	→	38					
FEB 0 986 473 412	↔	←	38								
FEB 0 986 474 412	↔	→	38								
	1.4 16V	05.03-04.09	72		FEB	1 987 477 787	↔	↔	2080		
	1.5 dCi	05.03-04.09	60/63/74-78		FEB	1 987 477 787	↔	↔	2080		
	1.6 16V	05.03-04.09	83		FEB	1 987 477 787	↔	↔	2080		
	1.9 dCi	05.03-04.09	81/88/96		FEB	1 987 477 787	↔	↔	2080		

R



									
 ◀ <b>RENAULT Kangoo I</b> [FC./KC.]									
	<b>1.6 i</b>	09.99-12.07	66			0 204 001 935	← 54		
		06.00-12.07	70			0 986 473 357			
							0 204 001 936	→ 54	
							0 986 474 357		
							0 204 001 935	← 54	
							0 986 473 357		
	<b>1.6 i 4x4</b>	06.00-12.07	70			0 204 102 995	← 54	0 204 104 272 <sup>7</sup>	
									0 204 104 285 <sup>8</sup>
							0 204 102 996	→ 54	0 204 104 272 <sup>7</sup>
							0 204 001 935	← 54	
	<b>1.9 D</b>	10.97-12.07	40/47-48			0 986 473 357			
						0 204 001 936	→ 54		
						0 986 474 357			
	<b>1.9 DCI</b>	09.98-12.07	59-62			0 204 001 935	← 54		
				<b>1.9 DTI</b>			0 986 473 357		
							0 204 001 936	→ 54	
	<b>1.9 DCI 4x4</b>	02.00-12.07	59-62			0 986 474 357			
								0 204 102 995	← 54
	<b>1.9 DTI</b>								0 204 104 285 <sup>8</sup>
		<b>1.9 DTI 4x4</b>					0 204 102 996	→ 54	0 204 104 272 <sup>7</sup>
<hr/>									
	<b>1.0 i, i 16V</b>	09.98-12.07	43/50			F 026 002 483	↔ 22,2		
		<b>1.2 GPL, i, i 16V</b>	10.97-12.07	44/55			F 026 002 482	↔ 22	
						F 026 002 483	↔ 22,2		
	<b>1.4 i</b>		10.97-12.07	55			F 026 002 482	↔ 22	
						F 026 002 483	↔ 22,2		
	<b>1.5 DCI</b>	05.00-12.07	45/48/50/ 60/62			F 026 002 482	↔ 22		
						F 026 002 483	↔ 22,2		
	<b>1.6 i</b>	09.99-12.07	66			F 026 002 483	↔ 22,2		
				06.00-12.07	70			F 026 002 482	↔ 22
								F 026 002 483	↔ 22,2
	<b>1.9 D, DCI, DTI</b>	10.97-12.07	40/47-48/ 59-62			F 026 002 482	↔ 22		
						F 026 002 483	↔ 22,2		
	<b>1.6 i 4x4</b>	06.00-12.07	70			0 204 004 175	← 38	0 204 104 284 <sup>7</sup>	
								0 986 134 051	
						0 204 004 176	→ 38	0 204 104 284 <sup>7</sup>	
						0 986 135 051			
	<b>1.9 DCI 4x4</b>	02.00-12.07	59-62			0 204 004 175	← 38	0 204 104 284 <sup>7</sup>	
								0 986 134 051	
<b>1.9 DTI 4x4</b>					0 204 004 176	→ 38	0 204 104 284 <sup>7</sup>		
					0 986 135 051				
<hr/>									
	<b>1.0 i</b>	09.98-12.07	43/50	ERH		1 987 477 634	← 1438		
							1 987 477 635	→ 1442	
	<b>1.0 i 16V</b>				NON		1 987 477 632	← 1423	
							1 987 477 633	→ 1421	
	<b>1.2 GPL</b>	10.97-12.07	44/55	ERH			1 987 477 634	← 1438	
							1 987 477 635	→ 1442	
	<b>1.2 i</b>				NON		1 987 477 632	← 1423	
							1 987 477 633	→ 1421	
	<b>1.2 i 16V</b>				ERH		1 987 477 634	← 1438	
							1 987 477 635	→ 1442	
	<b>1.4 i</b>	10.97-12.07	55	ERH			1 987 477 632	← 1423	
							1 987 477 633	→ 1421	
	<b>1.4 i</b>				NON		1 987 477 634	← 1438	
							1 987 477 635	→ 1442	
	<b>1.5 DCI</b>	05.00-12.07	45/48/50/ 60/62	ERH			1 987 477 632	← 1423	
							1 987 477 633	→ 1421	
	<b>1.5 DCI</b>				ERH		1 987 477 634	← 1438	
							1 987 477 635	→ 1442	



	S				?			
1.5 DCI	05.00-12.07	45/48/50/60/62		NON	1 987 477 632	← 1423		
					1 987 477 633	→ 1421		
1.6i	09.99-12.07	66		ERH	1 987 477 634	← 1438		
					1 987 477 635	→ 1442		
				NON	1 987 477 632	← 1423		
					1 987 477 633	→ 1421		
	06.00-12.07	70		ERH	1 987 477 634	← 1438		
					1 987 477 635	→ 1442		
				NON	1 987 477 632	← 1423		
					1 987 477 633	→ 1421		
1.6i 4x4	06.00-12.07	70		TW	1 987 477 634	← 1438		
					1 987 477 635	→ 1442		
					1 987 482 142	↔ 1525		
1.9 D	10.97-12.07	40/47-48		ERH	1 987 477 634	← 1438		
					1 987 477 635	→ 1442		
				NON	1 987 477 632	← 1423		
					1 987 477 633	→ 1421		
1.9 DCI	05.00-12.07	59-62		ERH	1 987 477 634	← 1438		
					1 987 477 635	→ 1442		
				NON	1 987 477 632	← 1423		
					1 987 477 633	→ 1421		
1.9 DCI 4x4	05.00-12.07	59-62		TW	1 987 477 634	← 1438		
					1 987 477 635	→ 1442		
					1 987 482 142	↔ 1525		
1.9 DTI	09.98-12.07	59		ERH	1 987 477 634	← 1438		
					1 987 477 635	→ 1442		
				NON	1 987 477 632	← 1423		
					1 987 477 633	→ 1421		
	02.00-12.07	59			1 987 482 142	↔ 1525		
1.9 DTI 4x4	05.00-12.07	59		TW	1 987 477 634	← 1438		
					1 987 477 635	→ 1442		
					1 987 482 142	↔ 1525		
1.0i	09.98-03.03	43/50			0 265 006 528 <sup>3</sup>			
1.0i 16V				ERH,LAB	0 265 006 400 <sup>4</sup>			
				ERH,RAB	0 265 006 401 <sup>4</sup>			
				LAB,NON	0 265 006 386 <sup>4</sup>			
				NON,RAB	0 265 006 387 <sup>4</sup>			
	04.03-12.07	43/50			0 265 007 527 <sup>3</sup>			
				ERH,LAB	0 265 007 532 <sup>4</sup>			
				ERH,RAB	0 265 007 531 <sup>4</sup>			
				LAB,NON	0 265 007 534 <sup>4</sup>			
				NON,RAB	0 265 007 533 <sup>4</sup>			
1.2 GPL	10.97-03.03	44/55			0 265 006 528 <sup>3</sup>			
1.2i				ERH,LAB	0 265 006 400 <sup>4</sup>			
1.2i 16V				ERH,RAB	0 265 006 401 <sup>4</sup>			
				LAB,NON	0 265 006 386 <sup>4</sup>			
				NON,RAB	0 265 006 387 <sup>4</sup>			
	04.03-12.07	44/55			0 265 007 527 <sup>3</sup>			
				ERH,LAB	0 265 007 532 <sup>4</sup>			
				ERH,RAB	0 265 007 531 <sup>4</sup>			
				LAB,NON	0 265 007 534 <sup>4</sup>			
				NON,RAB	0 265 007 533 <sup>4</sup>			
1.4i	10.97-03.03	55			0 265 006 528 <sup>3</sup>			
				ERH,LAB	0 265 006 400 <sup>4</sup>			
				ERH,RAB	0 265 006 401 <sup>4</sup>			
				LAB,NON	0 265 006 386 <sup>4</sup>			
				NON,RAB	0 265 006 387 <sup>4</sup>			
	04.03-12.07	55			0 265 007 527 <sup>3</sup>			
				ERH,LAB	0 265 007 532 <sup>4</sup>			
				ERH,RAB	0 265 007 531 <sup>4</sup>			
				LAB,NON	0 265 007 534 <sup>4</sup>			
				NON,RAB	0 265 007 533 <sup>4</sup>			







Model	Year Range	Power	Part Code	Part Code	Part Code
RENAULT Kangoo I [FC./KC.]	1.5 DCI	05.00-03.03	48		0 265 006 528 <sup>3</sup>
				ERH,LAB	0 265 006 400 <sup>4</sup>
				ERH,RAB	0 265 006 401 <sup>4</sup>
				LAB,NON	0 265 006 386 <sup>4</sup>
				NON,RAB	0 265 006 387 <sup>4</sup>
	02.01-03.03	60		0 265 006 528 <sup>3</sup>	
			ERH,LAB	0 265 006 400 <sup>4</sup>	
			ERH,RAB	0 265 006 401 <sup>4</sup>	
			LAB,NON	0 265 006 386 <sup>4</sup>	
			NON,RAB	0 265 006 387 <sup>4</sup>	
	04.03-12.07	48		0 265 007 527 <sup>3</sup>	
			ERH,LAB	0 265 007 532 <sup>4</sup>	
			ERH,RAB	0 265 007 531 <sup>4</sup>	
			LAB,NON	0 265 007 534 <sup>4</sup>	
			NON,RAB	0 265 007 533 <sup>4</sup>	
		60		0 265 007 527 <sup>3</sup>	
			ERH,LAB	0 265 007 532 <sup>4</sup>	
			ERH,RAB	0 265 007 531 <sup>4</sup>	
			LAB,NON	0 265 007 534 <sup>4</sup>	
			NON,RAB	0 265 007 533 <sup>4</sup>	
	04.05-12.07	45		0 265 007 527 <sup>3</sup>	
			ERH,LAB	0 265 007 532 <sup>4</sup>	
			ERH,RAB	0 265 007 531 <sup>4</sup>	
			LAB,NON	0 265 007 534 <sup>4</sup>	
NON,RAB			0 265 007 533 <sup>4</sup>		
50			0 265 007 527 <sup>3</sup>		
		ERH,LAB	0 265 007 532 <sup>4</sup>		
		ERH,RAB	0 265 007 531 <sup>4</sup>		
		LAB,NON	0 265 007 534 <sup>4</sup>		
		NON,RAB	0 265 007 533 <sup>4</sup>		
62		0 265 007 527 <sup>3</sup>			
	ERH,LAB	0 265 007 532 <sup>4</sup>			
	ERH,RAB	0 265 007 531 <sup>4</sup>			
	LAB,NON	0 265 007 534 <sup>4</sup>			
	NON,RAB	0 265 007 533 <sup>4</sup>			
1.6 i	09.99-03.03	66		0 265 006 528 <sup>3</sup>	
			ERH,LAB	0 265 006 400 <sup>4</sup>	
			ERH,RAB	0 265 006 401 <sup>4</sup>	
			LAB,NON	0 265 006 386 <sup>4</sup>	
			NON,RAB	0 265 006 387 <sup>4</sup>	
	06.00-03.03	70		0 265 006 528 <sup>3</sup>	
			ERH,LAB	0 265 006 400 <sup>4</sup>	
			ERH,RAB	0 265 006 401 <sup>4</sup>	
			LAB,NON	0 265 006 386 <sup>4</sup>	
			NON,RAB	0 265 006 387 <sup>4</sup>	
	04.03-12.07	66		0 265 007 527 <sup>3</sup>	
			ERH,LAB	0 265 007 532 <sup>4</sup>	
			ERH,RAB	0 265 007 531 <sup>4</sup>	
			LAB,NON	0 265 007 534 <sup>4</sup>	
			NON,RAB	0 265 007 533 <sup>4</sup>	
70			0 265 007 527 <sup>3</sup>		
		ERH,LAB	0 265 007 532 <sup>4</sup>		
		ERH,RAB	0 265 007 531 <sup>4</sup>		
		LAB,NON	0 265 007 534 <sup>4</sup>		
		NON,RAB	0 265 007 533 <sup>4</sup>		
1.6 i 4x4	06.00-12.07	70		0 265 006 710 <sup>3</sup>	
				0 265 006 711 <sup>4</sup>	
1.9 D	10.97-03.03	40/47-48		0 265 006 528 <sup>3</sup>	
			ERH,LAB	0 265 006 400 <sup>4</sup>	
			ERH,RAB	0 265 006 401 <sup>4</sup>	
			LAB,NON	0 265 006 386 <sup>4</sup>	
			NON,RAB	0 265 006 387 <sup>4</sup>	



		S								
<b>1.9 D</b>		04.03-12.07	40/47-48							0 265 <b>007 527</b> <sup>3</sup>
							ERH,LAB			0 265 <b>007 532</b> <sup>4</sup>
							ERH,RAB			0 265 <b>007 531</b> <sup>4</sup>
							LAB,NON			0 265 <b>007 534</b> <sup>4</sup>
							NON,RAB			0 265 <b>007 533</b> <sup>4</sup>
<b>1.9 DCI</b>		05.00-03.03	59-62							0 265 <b>006 528</b> <sup>3</sup>
							ERH,LAB			0 265 <b>006 400</b> <sup>4</sup>
							ERH,RAB			0 265 <b>006 401</b> <sup>4</sup>
							LAB,NON			0 265 <b>006 386</b> <sup>4</sup>
							NON,RAB			0 265 <b>006 387</b> <sup>4</sup>
		04.03-12.07	59-62							0 265 <b>007 527</b> <sup>3</sup>
							ERH,LAB			0 265 <b>007 532</b> <sup>4</sup>
							ERH,RAB			0 265 <b>007 531</b> <sup>4</sup>
							LAB,NON			0 265 <b>007 534</b> <sup>4</sup>
							NON,RAB			0 265 <b>007 533</b> <sup>4</sup>
<b>1.9 DCI 4x4</b>		05.00-12.07	59-62							0 265 <b>006 710</b> <sup>3</sup>
										0 265 <b>006 711</b> <sup>4</sup>
<b>1.9 DTI</b>		09.98-03.03	59							0 265 <b>006 528</b> <sup>3</sup>
							ERH,LAB			0 265 <b>006 400</b> <sup>4</sup>
							ERH,RAB			0 265 <b>006 401</b> <sup>4</sup>
							LAB,NON			0 265 <b>006 386</b> <sup>4</sup>
							NON,RAB			0 265 <b>006 387</b> <sup>4</sup>
		02.00-12.07	59							0 265 <b>006 710</b> <sup>3</sup>
		04.03-12.07	59							0 265 <b>007 527</b> <sup>3</sup>
							ERH,LAB			0 265 <b>007 532</b> <sup>4</sup>
							ERH,RAB			0 265 <b>007 531</b> <sup>4</sup>
							LAB,NON			0 265 <b>007 534</b> <sup>4</sup>
							NON,RAB			0 265 <b>007 533</b> <sup>4</sup>
<b>1.9 DTI, DTI 4x4</b>		02.00-12.07	59							0 265 <b>006 711</b> <sup>4</sup>
<b>1.9 DTI 4x4</b>		05.00-12.07	59							0 265 <b>006 710</b> <sup>3</sup>
<b>Kangoo II [Fase II]</b>										
	<b>1.6 i16V</b>	01.02-12.12	81							F 026 <b>002 483</b> ↔ 22,2
<b>Kangoo II [FW/KW]</b>										
	<b>1.2</b>	09.13→	84			FKR				0 986 <b>134 329</b> ↻ ← 54
						NOR				0 986 <b>134 256</b> ↻ ← 54
										0 986 <b>135 256</b> ↻ → 54
	<b>1.5 dCi</b>	01.08→	50/55/63/			FKR				0 986 <b>134 329</b> ↻ ← 54
	<b>1.5 DCI</b>		66/76/78/			NOR				0 986 <b>134 256</b> ↻ ← 54
			80/81							0 986 <b>135 256</b> ↻ → 54
	<b>1.6</b>	01.08→	64/72/78			FKR				0 986 <b>134 329</b> ↻ ← 54
	<b>1.6 16V</b>					NOR				0 986 <b>134 256</b> ↻ ← 54
										0 986 <b>135 256</b> ↻ → 54
	<b>1.2</b>	09.13→	84							F 026 <b>002 573</b> ↔ 22,2
	<b>1.5 dCi, DCI</b>	01.08→	50/55/63/66/76/78/80/81							F 026 <b>002 573</b> ↔ 22,2
	<b>1.6, 16V</b>	01.08→	64/72/78							F 026 <b>002 573</b> ↔ 22,2
	<b>1.2</b>	09.13→	84							0 986 <b>134 082</b> ↻ ← 38
										0 986 <b>135 082</b> ↻ → 38
	<b>1.5 dCi</b>	01.08→	50/55/63/66/							0 986 <b>134 082</b> ↻ ← 38
	<b>1.5 DCI</b>		76/78/80/81							0 986 <b>135 082</b> ↻ → 38
	<b>1.6</b>	01.08→	64/72/78							0 986 <b>134 082</b> ↻ ← 38
	<b>1.6 16V</b>									0 986 <b>135 082</b> ↻ → 38



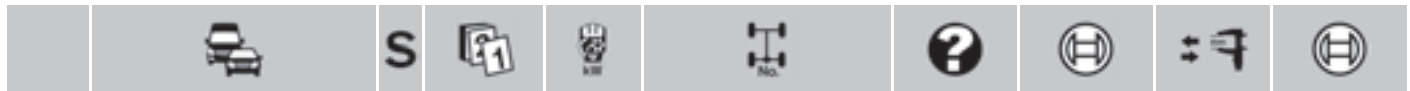

◀ RENAULT Kangoo II [FW/KW]



	<b>1.2</b>	09.13→	84		1 987 <b>482 253</b>	↔ 1970	
	<b>1.5 dCi</b>	03.11→	50/55/63/66/76/78/80/81		1 987 <b>482 253</b>	↔ 1970	
	<b>1.5 DCI</b>	01.08→	50/55/63/66/76/78/80/81		1 987 <b>482 253</b>	↔ 1970	
	<b>1.6</b>	01.08→	64/72/78		1 987 <b>482 253</b>	↔ 1970	
	<b>1.6 16V</b>	01.08→	64/72/78		1 987 <b>482 253</b>	↔ 1970	
	<b>1.2</b>	09.13→	84		0 265 <b>008 917</b> <sup>3</sup>		
				FKR,LAB	0 265 <b>008 918</b> <sup>4</sup>		
				FKR,RAB	0 265 <b>008 919</b> <sup>4</sup>		
				LAB,NOR	0 265 <b>008 920</b> <sup>4</sup>		
				NOR,RAB	0 265 <b>008 921</b> <sup>4</sup>		
	<b>1.5 dCi</b>	02.13→	81		0 265 <b>008 917</b> <sup>3</sup>		
				14Z,LAB	0 265 <b>008 918</b> <sup>4</sup>		
				14Z,RAB	0 265 <b>008 919</b> <sup>4</sup>		
				15Z,16Z,LAB	0 265 <b>008 920</b> <sup>4</sup>		
				15Z,16Z,RAB	0 265 <b>008 921</b> <sup>4</sup>		
	<b>1.5 DCI</b>	01.08→	80		0 265 <b>008 917</b> <sup>3</sup>		
				FKR,LAB	0 265 <b>008 918</b> <sup>4</sup>		
				FKR,RAB	0 265 <b>008 919</b> <sup>4</sup>		
				LAB,NOR	0 265 <b>008 920</b> <sup>4</sup>		
				NOR,RAB	0 265 <b>008 921</b> <sup>4</sup>		
		03.11→	80		14Z,LAB	0 265 <b>008 918</b> <sup>4</sup>	
					14Z,RAB	0 265 <b>008 919</b> <sup>4</sup>	
					15Z,16Z,LAB	0 265 <b>008 920</b> <sup>4</sup>	
					15Z,16Z,RAB	0 265 <b>008 921</b> <sup>4</sup>	
<b>1.5 dCi</b>		01.08→	50/55/63/		0 265 <b>008 917</b> <sup>3</sup>		
	<b>1.5 DCI</b>			66/76/78	FKR,LAB	0 265 <b>008 918</b> <sup>4</sup>	
				FKR,RAB	0 265 <b>008 919</b> <sup>4</sup>		
				LAB,NOR	0 265 <b>008 920</b> <sup>4</sup>		
				NOR,RAB	0 265 <b>008 921</b> <sup>4</sup>		
<b>1.6</b>	01.08→	64/72/78		0 265 <b>008 917</b> <sup>3</sup>			
				FKR,LAB	0 265 <b>008 918</b> <sup>4</sup>		
				FKR,RAB	0 265 <b>008 919</b> <sup>4</sup>		
				LAB,NOR	0 265 <b>008 920</b> <sup>4</sup>		
				NOR,RAB	0 265 <b>008 921</b> <sup>4</sup>		

Laguna I [B56]



	<b>1.6 i 16V</b>	05.98-02.01	79		0 986 <b>134 315</b>	↔ 54			
					0 986 <b>135 315</b>	↔ 54			
	<b>1.8 GPL</b>	09.95-05.98	66-70		0 986 <b>473 786</b>	↔ 54			
					0 986 <b>473 787</b>	↔ 54			
	<b>1.8 GPL</b>	06.98-02.01	66-70		0 986 <b>134 315</b>	↔ 54			
	<b>1.8 i</b>				0 986 <b>135 315</b>	↔ 54			
	<b>1.8 i</b>	01.94-03.01	66-70		0 986 <b>473 786</b>	↔ 54			
					0 986 <b>473 787</b>	↔ 54			
				ABO	01.94-09.94	66-70		0 986 <b>473 790</b>	↔ 48
								0 986 <b>473 791</b>	↔ 48
					10.94-03.01	66-70		0 986 <b>473 786</b>	↔ 54
					0 986 <b>473 787</b>	↔ 54			
		ABS	01.94-03.01	66-70		0 986 <b>473 786</b>	↔ 54		
					0 986 <b>473 787</b>	↔ 54			
	<b>1.8 i 16V</b>	05.98-02.01	88		0 986 <b>134 315</b>	↔ 54			
					0 986 <b>135 315</b>	↔ 54			
	<b>1.9 DCI</b>	10.97-02.01	72/80		0 986 <b>134 315</b>	↔ 54			
	<b>1.9 DTI</b>				0 986 <b>135 315</b>	↔ 54			
	<b>2.0 i</b>	01.94-02.01	83-85		0 986 <b>473 786</b>	↔ 54			
					0 986 <b>473 787</b>	↔ 54			
					06.98-02.01	83-85		0 986 <b>134 315</b>	↔ 54
					0 986 <b>135 315</b>	↔ 54			

2.0i 16V						0 986 473 788	↔	← 60
						0 986 473 789	↔	→ 60
2.2D						0 986 473 786	↔	← 54
						0 986 473 787	↔	→ 54
	ABO	01.94-02.94	61-63	Fg.-Nr. →E00108, →S00237		0 986 473 790	↔	← 48
						0 986 473 791	↔	→ 48
		03.94-10.95	61-63	Fg.-Nr. E00109→, S00238→		0 986 473 786	↔	← 54
						0 986 473 787	↔	→ 54
	ABS	01.94-10.95	61-63			0 986 473 786	↔	← 54
						0 986 473 787	↔	→ 54
2.2D Turbo		02.96-02.01	83-85			0 986 473 788	↔	← 60
						0 986 473 789	↔	→ 60
3.0i		01.94-02.01	123-125/			0 986 473 788	↔	← 60
3.0i 24V			143			0 986 473 789	↔	→ 60
	1.6i 16V		05.98-02.01	79		0 986 475 797	↔	20,6
	1.8 GPL		01.94-03.01	66-70		0 986 475 765	↔	19
	1.8i		05.98-02.01	66-70		0 986 475 797	↔	20,6
	1.8i 16V		05.98-02.01	88		0 986 475 797	↔	20,6
	1.9 DTI		10.97-02.01	72		0 986 475 797	↔	20,6
	2.0i		01.94-02.01	83-85		0 986 475 765	↔	19
			01.99-02.01	83-85		0 986 475 797	↔	20,6
	2.2D		01.94-02.01	61-63		0 986 475 765	↔	19
	1.8i	ABS	01.94-02.01	66-70		0 986 473 175	↔	← 35,92
						0 986 474 175	↔	→ 35,92
	1.8i 16V		05.98-02.01	88		0 986 473 267	↔	← 36
						0 986 474 267	↔	→ 36
					SBR	0 986 473 267	↔	← 36
						0 986 474 267	↔	→ 36
			03.99-02.01	88	NFS,SBR	0 986 473 267	↔	← 36
						0 986 474 267	↔	→ 36
	1.9 DCI		09.99-02.01	80		0 986 473 267	↔	← 36
						0 986 474 267	↔	→ 36
	1.9 DTI		10.97-02.01	72	SBR	0 986 473 267	↔	← 36
						0 986 474 267	↔	→ 36
	2.0i		01.94-02.01	83-85	NFS	0 986 473 175	↔	← 35,92
						0 986 474 175	↔	→ 35,92
			09.95-02.01	83-85	SBR,TW	0 986 473 175	↔	← 35,92
						0 986 473 267	↔	→ 36
						0 986 474 175	↔	→ 35,92
			01.99-02.01	83-85		0 986 473 267	↔	← 36
						0 986 474 267	↔	→ 36
		ABS	01.94-04.95	83-85		0 986 473 175	↔	← 35,92
						0 986 474 175	↔	→ 35,92
					NFS	0 986 473 175	↔	← 35,92
						0 986 474 175	↔	→ 35,92
	2.0i 16V		09.95-02.01	102		0 986 473 175	↔	← 35,92
						0 986 474 175	↔	→ 35,92
			02.97-02.01	102		0 986 473 267	↔	← 36
						0 986 474 267	↔	→ 36
	2.2D	ABS	01.94-04.95	61-63		0 986 473 175	↔	← 35,92
						0 986 474 175	↔	→ 35,92
	2.2D Turbo		02.96-01.97	83-85		0 986 473 175	↔	← 35,92
						0 986 474 175	↔	→ 35,92
			02.97-02.01	83-85		0 986 473 267	↔	← 36
						0 986 474 267	↔	→ 36
	3.0i		01.94-02.01	123-125		0 986 473 175	↔	← 35,92
						0 986 474 175	↔	→ 35,92





	◀RENAULT Laguna I [B56]				
	3.0 i	02.97-02.01	123-125	0986 473 267	← 36
				0986 474 267	→ 36
	3.0 i 24V	03.97-02.01	143	0986 473 267	← 36
				0986 474 267	→ 36

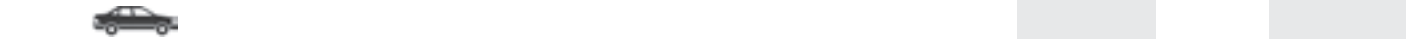

	1.6 i 16V	05.98-02.01	79	1987 477 472	↔ 1187
	1.8 GPL	09.95-02.01	66-70	1987 477 472	↔ 1187
	1.8 i	01.94-03.01	66-70	1987 477 472	↔ 1187
		ABS 01.94-04.95	66-70	1987 477 473	↔ 1247
	1.8 i 16V	05.98-02.01	88	1987 477 472	↔ 1187
				NFS	↔ 1183
				NFS	↔ 1187
	1.9 DCI	09.99-02.01	80	1987 477 638	↔ 1183
	1.9 DTI	10.97-02.01	72	1987 477 472	↔ 1187
	2.0 i	01.94-01.97	83-85	NFS	↔ 1247
		01.94-02.01	83-85	1987 477 472	↔ 1187
		09.95-02.01	83-85	NFS	↔ 1187
		02.97-02.01	83-85	NFS	↔ 1183
		ABO 01.94-02.01	83-85	NFS	↔ 1187
		ABS 01.94-04.95	83-85	1987 477 473	↔ 1247
				NFS	↔ 1247
		05.95-02.01	83-85	NFS	↔ 1187
	2.0 i 16V	09.95-02.01	102	1987 477 473	↔ 1247
		ABO 09.95-02.01	102	1987 477 473	↔ 1247
		ABS 09.95-01.97	102	1987 477 473	↔ 1247
		02.97-02.01	102	1987 477 638	↔ 1183
	2.2 D	01.94-02.01	61-63	1987 477 472	↔ 1187
		ABS 01.94-04.95	61-63	1987 477 473	↔ 1247
	2.2 D Turbo	ABO 02.96-02.01	83-85	1987 477 473	↔ 1247
		ABS 02.96-01.97	83-85	1987 477 473	↔ 1247
		02.97-02.01	83-85	1987 477 638	↔ 1183
	3.0 i	01.94-02.01	123-125	1987 477 473	↔ 1247
		02.97-02.01	123-125	1987 477 638	↔ 1183
	3.0 i 24V	03.97-02.01	143	1987 477 638	↔ 1183

**Laguna I Grandtour [A56]**

	2.0 i 16V	09.99-02.01	100	0986 473 788	← 60
				0986 473 789	→ 60

	2.0 i 16V	09.99-02.01	100	0986 473 267	← 36
				0986 474 267	→ 36

	2.0 i 16V	09.99-02.01	100	1987 477 638	↔ 1183
--	-----------	-------------	-----	--------------	--------

**Laguna I Grandtour [K56]**

	1.6 i 16V	05.98-02.01	79	0986 134 315	← 54
				0986 135 315	→ 54
	1.8 GPL	09.95-05.98	66-70	0986 473 786	← 54
				0986 473 787	→ 54
		06.98-02.01	66-70	0986 134 315	← 54
				0986 135 315	→ 54
	1.8 i	09.95-02.01	66-70	0986 473 786	← 54
				0986 473 787	→ 54

		S							
1.8i 16V							0 986 134 315		← 54
							0 986 135 315		→ 54
1.9 DCI							0 986 134 315		← 54
1.9 DTI							0 986 135 315		→ 54
2.0i							0 986 473 786		← 54
							0 986 473 787		→ 54
							0 986 134 315		← 54
							0 986 135 315		→ 54
2.0i 16V							0 986 473 788		← 60
							0 986 473 789		→ 60
2.2 D							0 986 473 786		← 54
							0 986 473 787		→ 54
2.2 D Turbo							0 986 473 788		← 60
							0 986 473 789		→ 60
3.0i							0 986 473 788		← 60
3.0i 24V							0 986 473 789		→ 60
	1.6i 16V						0 986 475 868		↔ 22,2
	1.8 GPL	ABS					0 986 475 868		↔ 22,2
	1.8 GPL, i						0 986 475 797		↔ 20,6
	1.8i 16V						0 986 475 868		↔ 22,2
	1.9 DCI						0 986 475 868		↔ 22,2
	1.9 DTI				TBR		0 986 475 868		↔ 22,2
	2.0i						0 986 475 797		↔ 20,6
		ABS					0 986 475 868		↔ 22,2
	2.2 D						0 986 475 797		↔ 20,6
	1.8 GPL	ABS					0 986 473 175		← 35,92
	1.8i						0 986 474 175		→ 35,92
	1.8i 16V						0 986 473 267		← 36
							0 986 474 267		→ 36
	1.9 DCI						0 986 473 267		← 36
							0 986 474 267		→ 36
	1.9 DTI				SBR		0 986 473 267		← 36
							0 986 474 267		→ 36
	2.0i	ABS					0 986 473 175		← 35,92
							0 986 474 175		→ 35,92
	2.0i 16V						0 986 473 175		← 35,92
							0 986 474 175		→ 35,92
							0 986 473 267		← 36
							0 986 474 267		→ 36
	2.2 D	ABS					0 986 473 175		← 35,92
							0 986 474 175		→ 35,92
	2.2 D Turbo						0 986 473 175		← 35,92
							0 986 474 175		→ 35,92
							0 986 473 267		← 36
							0 986 474 267		→ 36
	3.0i						0 986 473 175		← 35,92
							0 986 474 175		→ 35,92
							0 986 473 267		← 36
							0 986 474 267		→ 36
	3.0i 24V						0 986 473 267		← 36
							0 986 474 267		→ 36
	1.6i 16V						1 987 477 650		↔ 1190
	1.8 GPL						1 987 477 650		↔ 1190
		ABO					1 987 477 650		↔ 1190
		ABS					1 987 477 473		↔ 1247
							1 987 477 650		↔ 1190





◀ **RENAULT** Laguna I Grandtour [K56]

1.8 i	ABO	09.95-02.01	66-70		1987 477 650	↔ 1190
	ABS	09.95-06.96	66-70		1987 477 473	↔ 1247
		07.96-02.01	66-70		1987 477 650	↔ 1190
1.8 i 16V		05.98-02.01	88		1987 477 650	↔ 1190
1.9 DCI		09.99-02.01	80		1987 477 638	↔ 1183
1.9 DTI		10.97-02.01	72		1987 477 650	↔ 1190
2.0 i		09.95-02.01	83-85		1987 477 650	↔ 1190
	ABO	09.95-02.01	83-85		1987 477 650	↔ 1190
	ABS	09.95-06.96	83-85		1987 477 473	↔ 1247
		07.96-02.01	83-85		1987 477 650	↔ 1190
2.0 i 16V		09.95-02.01	102		1987 477 473	↔ 1247
		02.97-02.01	102		1987 477 638	↔ 1183
2.2 D	ABO	02.95-02.01	61-63		1987 477 650	↔ 1190
	ABS	02.95-06.96	61-63		1987 477 473	↔ 1247
		07.96-02.01	61-63		1987 477 650	↔ 1190
2.2 D Turbo		02.96-01.97	83-85		1987 477 473	↔ 1247
		02.97-02.01	83-85		1987 477 638	↔ 1183
3.0 i		03.96-02.01	123-125		1987 477 473	↔ 1247
		02.97-02.01	123-125		1987 477 638	↔ 1183
3.0 i 24V		03.97-02.01	143		1987 477 638	↔ 1183

**Laguna I Grandtour [S56]**



	1.9 DTI		03.98-02.01	72		0986 134 315	← 54	
						0986 135 315	→ 54	
	2.2 D		02.95-02.01	61-63/	83-85		0986 473 786	← 54
							0986 473 787	→ 54



	1.9 DTI		03.98-02.01	72		TBR	0986 475 868	↔ 22,2
							0986 475 797	↔ 20,6

	2.2 D	ABS	02.95-05.96	61-63/	83-85		0986 473 175	← 35,92
							0986 474 175	→ 35,92



	1.9 DTI		03.98-02.01	72			1987 477 650	↔ 1190	
							1987 477 650	↔ 1190	
	2.2 D	ABS	02.95-06.96	61-63				1987 477 473	↔ 1247
								1987 477 650	↔ 1190
	2.2 D Turbo	ABS	02.96-02.01	83-85				1987 477 650	↔ 1190
								1987 477 473	↔ 1247
		07.96-02.01	83-85				1987 477 650	↔ 1190	

**Laguna I [556]**



	2.0 i 16V		09.99-02.01	100			0986 134 315	← 54
							0986 135 315	→ 54



	2.0 i 16V		09.99-02.01	100			0986 473 267	← 36
							0986 474 267	→ 36



	2.0 i 16V		09.99-02.01	100			1987 477 638	↔ 1183
--	-----------	--	-------------	-----	--	--	--------------	--------



**Laguna II [BG.]**

Icon	Engine	Period	Power	Price	Part No.	Direction	Price
	<b>1.6 16V</b>	03.01-09.07	79/82	284	0 986 473 422	← 57	
					0 986 474 422	→ 57	
				326	0 986 473 341	← 57	
					0 986 474 341	→ 57	
	<b>1.8 16V</b>	03.01-09.07	85/88	284	0 986 473 422	← 57	
					0 986 474 422	→ 57	
				326	0 986 473 341	← 57	
					0 986 474 341	→ 57	
	<b>1.9 DCI</b>	03.01-09.07	68/74	284	0 986 473 422	← 57	
					0 986 474 422	→ 57	
				326	0 986 473 341	← 57	
					0 986 474 341	→ 57	
			88		0 986 473 341	← 57	
					0 986 474 341	→ 57	
		05.02-09.07	88	284	0 986 473 422	← 57	
					0 986 474 422	→ 57	
				326	0 986 473 341	← 57	
					0 986 474 341	→ 57	
		09.04-09.07	81		0 986 473 341	← 57	
					0 986 474 341	→ 57	
		01.05-09.07	96		0 986 473 341	← 57	
					0 986 474 341	→ 57	
	<b>2.0 DCI</b>	09.04-09.07	110		0 986 473 341	← 57	
					0 986 474 341	→ 57	
	<b>2.0 DCI</b>	07.02-09.07	120-125/		0 986 134 328	← 60	
	<b>2.0 T</b>		127/150		0 986 135 328	→ 60	
	<b>2.0 16V</b>	03.01-09.07	99/103	284	0 986 473 422	← 57	
	<b>2.0 16V IDE</b>				0 986 474 422	→ 57	
				326	0 986 473 341	← 57	
					0 986 474 341	→ 57	
	<b>2.2 DCI</b>	03.01-04.05	110		0 986 134 328	← 60	
					0 986 135 328	→ 60	
		05.05-09.07	110		0 986 473 341	← 57	
					0 986 474 341	→ 57	
		07.05-09.07	102		0 986 473 341	← 57	
					0 986 474 341	→ 57	
	<b>3.0 V6 24V</b>	03.01-04.05	152		0 986 134 328	← 60	
					0 986 135 328	→ 60	
		05.05-09.07	152		0 986 473 341	← 57	
					0 986 474 341	→ 57	
	<b>1.6 16V</b>	03.01-09.07	79/82		0 986 473 226	← 37,93	
					0 986 474 226	→ 37,93	
	<b>1.8 16V</b>	03.01-09.07	85/88		0 986 473 226	← 37,93	
					0 986 474 226	→ 37,93	
	<b>1.9 DCI</b>	03.01-09.07	68/74/81/ 88/96		0 986 473 226	← 37,93	
					0 986 474 226	→ 37,93	
	<b>2.0 DCI, T, 16V, 16V IDE</b>	03.01-09.07	99/103/110/ 120-125/127/150		0 986 473 226	← 37,93	
					0 986 474 226	→ 37,93	
	<b>2.2 DCI</b>	03.01-09.07	102/110		0 986 473 226	← 37,93	
					0 986 474 226	→ 37,93	
	<b>3.0 V6 24V</b>	03.01-09.07	152		0 986 473 226	← 37,93	
					0 986 474 226	→ 37,93	
	<b>1.6 16V</b>	03.01-09.07	79/82	MB	1 987 477 652	↔ 2220	
	<b>1.8 16V</b>	03.01-09.07	85/88	MB	1 987 477 652	↔ 2220	







	◀ RENAULT Laguna II [BG.]						
	1.9 DCI	03.01-09.07	68/74/81/88/96	MB	1987 477 652	↔ 2220	
	2.0 DCI	09.04-09.07	99/103/110/120-125/127/150	MB	1987 477 652	↔ 2220	
	2.0 T	07.02-09.07	99/103/110/120-125/127/150	MB	1987 477 652	↔ 2220	
	2.0 16V	03.01-09.07	99/103/110/120-125/127/150	MB	1987 477 652	↔ 2220	
	2.0 16V IDE	03.01-09.07	99/103/110/120-125/127/150	MB	1987 477 652	↔ 2220	
	2.2 DCI	03.01-09.07	102/110	MB	1987 477 652	↔ 2220	
	3.0 V6 24V	03.01-09.07	152	MB	1987 477 652	↔ 2220	

**Laguna II Grandtour [KG.]**

	1.6 16V	03.01-09.07	79/82	284	0986 473 422	↔ 57	
				326	0986 474 422	↔ 57	
					0986 473 341	↔ 57	
					0986 474 341	↔ 57	
	1.8 16V	03.01-09.07	85/88/89	284	0986 473 422	↔ 57	
				326	0986 474 422	↔ 57	
					0986 473 341	↔ 57	
					0986 474 341	↔ 57	
	1.9 DCI	03.01-12.05	74-79		0986 473 341	↔ 57	
					0986 474 341	↔ 57	
				284	0986 473 422	↔ 57	
				326	0986 474 422	↔ 57	
					0986 473 341	↔ 57	
			88		0986 473 341	↔ 57	
					0986 474 341	↔ 57	
		05.02-09.07	88	284	0986 473 422	↔ 57	
				326	0986 474 422	↔ 57	
					0986 473 341	↔ 57	
					0986 474 341	↔ 57	
		04.04-09.07	96		0986 473 341	↔ 57	
					0986 474 341	↔ 57	
		01.05-12.06	68	284	0986 473 422	↔ 57	
				326	0986 474 422	↔ 57	
					0986 473 341	↔ 57	
					0986 474 341	↔ 57	
		01.05-09.07	81		0986 473 341	↔ 57	
					0986 474 341	↔ 57	
	2.0 DCI	09.04-09.07	110		0986 473 341	↔ 57	
					0986 474 341	↔ 57	
	2.0 DCI	07.02-09.07	120/127/		0986 134 328	↔ 60	
	2.0 T		150		0986 135 328	↔ 60	
	2.0 16V	03.01-09.07	99/103	284	0986 473 422	↔ 57	
	2.0 16V IDE			326	0986 474 422	↔ 57	
					0986 473 341	↔ 57	
					0986 474 341	↔ 57	
	2.2 DCI	11.01-04.05	110		0986 134 328	↔ 60	
					0986 135 328	↔ 60	
		05.05-09.07	110		0986 473 341	↔ 57	
					0986 474 341	↔ 57	
		07.05-09.07	102		0986 473 341	↔ 57	
					0986 474 341	↔ 57	
	3.0 V6 24V	11.01-04.05	152		0986 134 328	↔ 60	
					0986 135 328	↔ 60	
		05.05-09.07	152		0986 473 341	↔ 57	
					0986 474 341	↔ 57	

	1.6 16V	03.01-09.07	79/82		0986 473 226	↔ 37,93	
					0986 474 226	↔ 37,93	

		S									
<b>1.8 16V</b>		03.01-09.07	85/88/89						0 986 473 226		← 37,93
									0 986 474 226		→ 37,93
<b>1.9 DCI</b>		03.01-09.07	68/74-79/ 81/88/96						0 986 473 226		← 37,93
									0 986 474 226		→ 37,93
<b>2.0 DCI, T, 16V, 16V IDE</b>		03.01-09.07	99/103/110/ 120/127/150						0 986 473 226		← 37,93
									0 986 474 226		→ 37,93
<b>2.2 DCI</b>		03.01-09.07	102/110						0 986 473 226		← 37,93
									0 986 474 226		→ 37,93
<b>3.0 V6 24V</b>		03.01-09.07	152						0 986 473 226		← 37,93
									0 986 474 226		→ 37,93
	<b>1.6 16V</b>	03.01-09.07	79/82				MB		1 987 477 652		↔ 2220
	<b>1.8 16V</b>	03.01-09.07	85/88/89				MB		1 987 477 652		↔ 2220
	<b>1.9 DCI</b>	03.01-09.07	68/74-79/81/88/96				MB		1 987 477 652		↔ 2220
	<b>2.0 DCI</b>	09.04-09.07	99/103/				MB		1 987 477 652		↔ 2220
	<b>2.0 T</b>	07.02-09.07	99/103/110/120/127/150				MB		1 987 477 652		↔ 2220
	<b>2.0 16V</b>	03.01-09.07	99/103/110/120/127/150				MB		1 987 477 652		↔ 2220
	<b>2.0 16V IDE</b>	03.01-09.07	99/103/110/120/127/150				MB		1 987 477 652		↔ 2220
	<b>2.2 DCI</b>	03.01-09.07	102/110				MB		1 987 477 652		↔ 2220
	<b>3.0 V6 24V</b>	03.01-09.07	152				MB		1 987 477 652		↔ 2220
<b>Laguna III [BT]</b>											
	<b>1.5 dCi</b>	07.07→	47-81				FEB		1 987 482 303		↔ 2224
	<b>1.6</b>	10.07→	83				FEB		1 987 482 303		↔ 2224
	<b>2.0</b>	10.07→	96/103/110/125/127/131/150				FEB		1 987 482 303		↔ 2224
	<b>2.0 dCi</b>	10.07→	96/103/110/125/127/131/150				FEB		1 987 482 303		↔ 2224
	<b>2.0 TCe</b>	10.07→	96/103/110/125/127/131/150				FEB		1 987 482 303		↔ 2224
	<b>3.0 dCi</b>	02.08→	173				FEB		1 987 482 303		↔ 2224
	<b>3.5</b>	02.08→	175				FEB		1 987 482 303		↔ 2224
<b>Laguna III Coupé [DT]</b>											
	<b>1.5 dCi</b>	01.13→	81				FEB		1 987 482 303		↔ 2224
	<b>2.0 dCi</b>	02.08→	110/125/127/131/150				FEB		1 987 482 303		↔ 2224
	<b>2.0 TCe</b>	02.08→	110/125/127/131/150				FEB		1 987 482 303		↔ 2224
	<b>3.0 dCi</b>	02.08→	173				FEB		1 987 482 303		↔ 2224
	<b>3.5</b>	02.08→	175				FEB		1 987 482 303		↔ 2224
<b>Laguna III Grandtour [KT]</b>											
	<b>1.5 dCi</b>	07.07→	81				FEB		1 987 482 303		↔ 2224
	<b>1.6</b>	10.07→	83				FEB		1 987 482 303		↔ 2224
	<b>2.0</b>	10.07→	96/103/110/125/127/131/150				FEB		1 987 482 303		↔ 2224
	<b>2.0 dCi</b>	10.07→	96/103/110/125/127/131/150				FEB		1 987 482 303		↔ 2224
	<b>2.0 TCe</b>	10.07→	96/103/110/125/127/131/150				FEB		1 987 482 303		↔ 2224
	<b>3.0 dCi</b>	02.08→	173				FEB		1 987 482 303		↔ 2224
	<b>3.5</b>	02.08→	175				FEB		1 987 482 303		↔ 2224
<b>Logan [LS]</b>											
	<b>1.2</b>	09.11→	55				B59		0 986 473 677		← 48
									0 986 474 677		→ 48
							238,B25		0 986 473 671		← 48
									0 986 474 671		→ 48
	<b>1.4</b>	07.04→	55				B59		0 986 473 677		← 48
									0 986 474 677		→ 48



		S							
◀ RENAULT Logan [LS]									
1.4		07.04→	55		238,B25		0986 473 671		← 48
							0986 474 671		→ 48
1.5 dCi		06.05→	48/50/63		B59		0986 473 677		← 48
							0986 474 677		→ 48
					238,B25		0986 473 671		← 48
							0986 474 671		→ 48
1.6		07.04→	64/77/80		B59		0986 473 677		← 48
1.6 16V							0986 474 677		→ 48
					238,B25		0986 473 671		← 48
							0986 474 671		→ 48
1.2		09.11→	55				F 026 002 480		↔ 19,05
						BSY	F 026 002 249		↔ 17,5
						TRW	0986 475 837		↔ 17,46
1.4		07.04→	55				F 026 002 480		↔ 19,05
						BSY	F 026 002 249		↔ 17,5
						TRW	0986 475 837		↔ 17,46
1.5 dCi		06.05→	48/50/63				F 026 002 480		↔ 19,05
						BSY	F 026 002 249		↔ 17,5
						TRW	0986 475 837		↔ 17,46
1.6		07.04→	64/77				F 026 002 480		↔ 19,05
1.6 16V						BSY	F 026 002 249		↔ 17,5
						TRW	0986 475 837		↔ 17,46
1.6 16V		04.07-12.12	80				F 026 002 480		↔ 19,05
						BSY	F 026 002 249		↔ 17,5
						TRW	0986 475 837		↔ 17,46
1.6 16V Hi-Flex		07.07-11.13	79-82				F 026 002 480		↔ 19,05
						BSY	F 026 002 249		↔ 17,5
							F 026 002 480		↔ 19,05
1.2		09.11→	55				1 987 477 955		↔ 1680
							1 987 477 956		↔ 1667
1.4		07.04→	55				1 987 482 234		↔ 1658
1.5 dCi		06.05→	48		ABM		1 987 477 955		↔ 1680
							1 987 477 956		↔ 1667
		10.05→	50/63				1 987 482 234		↔ 1658
1.6		07.04→	64/77/80				1 987 482 234		↔ 1658
1.6 16V		12.05→	64/77/80				1 987 482 234		↔ 1658
1.2		09.11→	55				0 265 008 297 <sup>4</sup>		
							0 265 008 922 <sup>3</sup>		
1.4		07.04-01.08	55		LAB		0 265 007 583 <sup>4</sup>		
					RAB		0 265 007 582 <sup>4</sup>		
		07.04→	55				0 265 008 922 <sup>3</sup>		
		02.08→	55				0 265 008 297 <sup>4</sup>		
1.5 dCi		06.05-01.08	48/50		LAB		0 265 007 583 <sup>4</sup>		
					RAB		0 265 007 582 <sup>4</sup>		
		06.05→	48/50				0 265 008 922 <sup>3</sup>		
		10.05-01.08	63		LAB		0 265 007 583 <sup>4</sup>		
					RAB		0 265 007 582 <sup>4</sup>		
		10.05→	63				0 265 007 742 <sup>3</sup>		
		02.08→	48/50				0 265 008 297 <sup>4</sup>		
			63				0 265 008 297 <sup>4</sup>		
1.6		07.04-01.08	64/77		LAB		0 265 007 583 <sup>4</sup>		
1.6 16V					RAB		0 265 007 582 <sup>4</sup>		
		07.04→	64/77				0 265 008 922 <sup>3</sup>		
		02.08→	64/77				0 265 008 297 <sup>4</sup>		
1.6 16V		04.07-12.12	80				0 265 008 922 <sup>3</sup>		
					LAB		0 265 008 946 <sup>4</sup>		
					RAB		0 265 008 947 <sup>4</sup>		

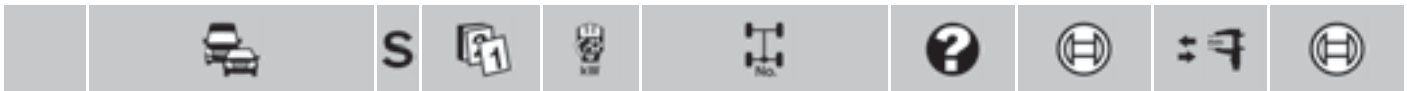

1.6 16V Hi-Flex	07.07-11.13	79-82		0 265 007 742 <sup>3</sup>
			LAB	0 265 007 583 <sup>4</sup>
			RAB	0 265 007 582 <sup>4</sup>

**Logan MCV [KS/FS]**



	1.4	01.07→	55	B59	0 986 473 677		← 48
						0 986 474 677	
	1.5 dCi	01.07→	50/63	B59	0 986 473 677		← 48
					0 986 474 677		→ 48
	1.6	01.07→	64/77	B59	0 986 473 677		← 48
	1.6 16V				0 986 474 677		→ 48



	1.4	ABO 01.07→	55		F 026 002 572		↔ 19
		ABS 01.07→	55		F 026 002 573		↔ 22,2
	1.5 dCi	ABO 01.07→	50/63		F 026 002 572		↔ 19
		ABS 01.07→	50/63		F 026 002 573		↔ 22,2
	1.6	ABO 01.07→	64/77		F 026 002 572		↔ 19
	1.6 16V	ABS 01.07→	64/77		F 026 002 573		↔ 22,2



	1.4	01.07→	55		1 987 482 234		↔ 1658
	1.5 dCi	01.07→	50/63		1 987 482 234		↔ 1658
	1.6	01.07→	64/77		1 987 482 234		↔ 1658
	1.6 16V	01.07→	64/77		1 987 482 234		↔ 1658



	1.4	01.07→	55		0 265 007 742 <sup>3</sup>		
				LAB	0 265 007 583 <sup>4</sup>		
				RAB	0 265 007 582 <sup>4</sup>		
	1.5 dCi	01.07→	50/63		0 265 007 742 <sup>3</sup>		
				LAB	0 265 007 583 <sup>4</sup>		
				RAB	0 265 007 582 <sup>4</sup>		
	1.6	01.07→	64/77		0 265 007 742 <sup>3</sup>		
	1.6 16V			LAB	0 265 007 583 <sup>4</sup>		
				RAB	0 265 007 582 <sup>4</sup>		

**Master [ADCU]**

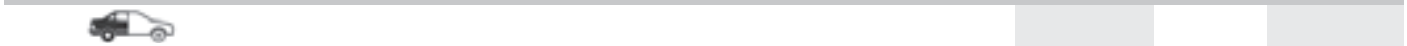

	2.5 dCi 16V	10.04-02.12	85		F 026 002 532		← 23,8
					F 026 002 533		→ 23,8

**Master I**



	P28 -35	10.86-09.97	63		0 986 475 420		↔ 25,4
	T28 -35, -35D	09.80-09.97	44/52-55/57-59/67/69/72		0 986 475 420		↔ 25,4



	P28 -35	10.86-09.97	63		1 987 482 045		1778
	T28 -35, -35D	09.80-09.97	44/52-55/57-59/67/69/72		1 987 482 044		1752

**Master II**



	1.9 dCi 80	05.00-07.00	60		0 204 102 730		← 45
					0 204 103 730		
					0 204 102 731		→ 45
					0 204 103 731		



		S														
◀ RENAULT Master II																
1.9 dCi 80	08.00-09.03	60					0 204 102 969	← 45								
							0 204 103 969									
							0 986 473 328									
							0 204 102 970	→ 45								
							0 204 103 970									
							0 986 474 328									
							ABO 10.03-10.06	60					0 204 102 969	← 45		
													0 204 103 969			
													0 986 473 328			
													0 204 102 970	→ 45		
						0 204 103 970										
						0 986 474 328										
1.9 dTi 80	01.00-07.00	58					0 204 102 730	← 45								
							0 204 103 730									
							0 204 102 731	→ 45								
							0 204 103 731									
							0 204 102 969	← 45								
	08.00-09.03	58						0 204 103 969								
								0 986 473 328								
								0 204 102 970	→ 45							
								0 204 103 970								
								0 986 474 328								
2.2 dCi 90	01.00-07.00	66					0 204 102 730	← 45								
							0 204 103 730									
							0 204 102 731	→ 45								
							0 204 103 731									
							0 204 102 969	← 45								
	08.00-09.03	66						0 204 103 969								
								0 986 473 328								
								0 204 102 970	→ 45							
								0 204 103 970								
								0 986 474 328								
ABO 10.03-10.06	66						0 204 102 969	← 45								
							0 204 103 969									
							0 986 473 328									
							0 204 102 970	→ 45								
							0 204 103 970									
							0 986 474 328									
							ABS 10.03-10.06	66						0 204 004 237	→ 45	
														0 204 004 238	← 45	
														0 204 102 730	← 45	
														0 204 103 730		
0 204 102 731	→ 45															
2.5 D	10.97-07.00	60					0 204 102 730	← 45								
							0 204 103 730									
							0 204 102 731	→ 45								
							0 204 103 731									
							0 204 102 969	← 45								
	08.00-09.03	60						0 204 103 969								
								0 986 473 328								
								0 204 102 970	→ 45							
								0 204 103 970								
								0 986 474 328								
2.5 dCi 100	ABS 10.03-10.06	73					0 204 004 237	→ 45								
							0 204 004 238	← 45								
							0 204 004 237	← 45								
							0 204 004 238	→ 45								
							0 204 102 969	← 45								
	11.06-04.10	74						0 204 103 969								
								0 986 473 328								
								0 204 102 970	→ 45							
								0 204 103 970								
								0 986 474 328								
2.5 dCi 100 2.5 dCi 110	ABO 10.03-04.10	73/74/81					0 204 102 969	← 45								
							0 204 103 969									
							0 986 473 328									
							0 204 102 970	→ 45								
							0 204 103 970									
							0 986 474 328									



		S							
2.5 dCi 110		ABS	10.03-01.10	81/84			0 204 004 237	→ 45	
2.5 dCi 120							0 204 004 238	← 45	
2.5 dCi 120			05.00-07.00	84			0 204 102 730	← 45	
							0 204 103 730		
							0 204 102 731	→ 45	
							0 204 103 731		
			08.00-09.03	84			0 204 102 969	← 45	
							0 204 103 969		
							0 986 473 328		
							0 204 102 970	→ 45	
							0 204 103 970		
							0 986 474 328		
		ABO	10.03-01.10	84			0 204 102 969	← 45	
							0 204 103 969		
							0 986 473 328		
							0 204 102 970	→ 45	
							0 204 103 970		
							0 986 474 328		
2.5 dCi 120		ABO	11.06-04.10	88/107			0 204 102 969	← 45	
2.5 dCi 120 FAP							0 204 103 969		
2.5 dCi 150 FAP							0 986 473 328		
							0 204 102 970	→ 45	
							0 204 103 970		
							0 986 474 328		
		ABS	11.06-04.10	88/107			0 204 004 237	← 45	
							0 204 004 238	→ 45	
2.8 D			05.01-10.04	86			0 204 102 969	← 45	
							0 204 103 969		
							0 986 473 328		
							0 204 102 970	→ 45	
							0 204 103 970		
							0 986 474 328		
2.8 dTi 110			10.97-07.00	81/84			0 204 102 730	← 45	
2.8 dTi 120							0 204 103 730		
							0 204 102 731	→ 45	
							0 204 103 731		
			08.00-09.03	81/84			0 204 102 969	← 45	
							0 204 103 969		
							0 986 473 328		
							0 204 102 970	→ 45	
							0 204 103 970		
							0 986 474 328		
3.0 dCi 140		ABO	10.03-10.06	100			0 204 102 969	← 45	
							0 204 103 969		
							0 986 473 328		
							0 204 102 970	→ 45	
							0 204 103 970		
							0 986 474 328		
		ABS	10.03-10.06	100			0 204 004 237	→ 45	
							0 204 004 238	← 45	
	1.9 dCi 80		01.00-07.00	58/60			F 026 002 532	← 23,8	
	1.9 dTi 80						F 026 002 533	→ 23,8	
	2.2 dCi 90		01.00-07.00	66			F 026 002 532	← 23,8	
							F 026 002 533	→ 23,8	
	2.5 D		10.97-07.00	60/84			F 026 002 532	← 23,8	
	2.5 dCi 120						F 026 002 533	→ 23,8	
	2.8 dTi 110		10.97-07.00	81/84			F 026 002 532	← 23,8	
	2.8 dTi 120						F 026 002 533	→ 23,8	













◀ RENAULT Master II





	1.9 dCi 80	08.00-09.03	60	0 204 004 320	← 42	
				0 986 473 260		
				0 204 004 321	→ 42	
				0 986 474 260		
		07.01-09.03	60			0 204 104 261 <sup>8</sup>
		10.03-10.06	60	0 204 004 320	← 42	0 204 104 261 <sup>8</sup>
				0 986 473 260		
				0 204 004 321	→ 42	0 204 104 261 <sup>8</sup>
				0 986 474 260		
	1.9 dTi 80	08.00-09.03	58	0 204 004 320	← 42	
				0 986 473 260		
				0 204 004 321	→ 42	
				0 986 474 260		
		07.01-09.03	58			0 204 104 261 <sup>8</sup>
	2.2 dCi 90	05.00-09.03	66	0 204 004 320	← 42	
				0 986 473 260		
				0 204 004 321	→ 42	
				0 986 474 260		
		07.01-09.03	66			0 204 104 261 <sup>8</sup>
		10.03-10.06	66	0 204 004 320	← 42	0 204 104 261 <sup>8</sup>
				0 986 473 260		
				0 204 004 321	→ 42	0 204 104 261 <sup>8</sup>
				0 986 474 260		
	2.5 D	08.00-09.03	60	0 204 004 320	← 42	
				0 986 473 260		
				0 204 004 321	→ 42	
				0 986 474 260		
	2.5 dCi 100	10.03-04.10	73/74/81	0 204 004 320	← 42	0 204 104 261 <sup>8</sup>
	2.5 dCi 110			0 986 473 260		
				0 204 004 321	→ 42	0 204 104 261 <sup>8</sup>
				0 986 474 260		
	2.5 dCi 120	08.00-09.03	84	0 204 004 320	← 42	
				0 986 473 260		
				0 204 004 321	→ 42	
				0 986 474 260		
		07.01-09.03	84			0 204 104 261 <sup>8</sup>
		10.03-01.10	84	0 204 004 320	← 42	0 204 104 261 <sup>8</sup>
				0 986 473 260		
				0 204 004 321	→ 42	0 204 104 261 <sup>8</sup>
				0 986 474 260		
	2.5 dCi 120	11.06-04.10	88/107	0 204 004 320	← 42	0 204 104 261 <sup>8</sup>
	2.5 dCi 120 FAP			0 986 473 260		
	2.5 dCi 150 FAP			0 204 004 321	→ 42	0 204 104 261 <sup>8</sup>
				0 986 474 260		
	2.8 D	08.00-10.04	84/86	0 204 004 320	← 42	
	2.8 dTi 120			0 986 473 260		
				0 204 004 321	→ 42	
				0 986 474 260		
	2.8 dTi 110	08.00-09.03	81	0 204 004 320	← 42	
				0 986 473 260		
				0 204 004 321	→ 42	
				0 986 474 260		
		07.01-09.03	81			0 204 104 261 <sup>8</sup>
	3.0 dCi 140	10.03-10.06	100	0 204 004 320	← 42	0 204 104 261 <sup>8</sup>
				0 986 473 260		
				0 204 004 321	→ 42	0 204 104 261 <sup>8</sup>
				0 986 474 260		



	1.9 dCi 80	05.00-10.06	58/60	HTB	1987 482 013	↔ 1420
				4SB	1987 477 261	↔ 1737

	S							
1.9 dTi 80	01.00-09.03	58/60			HTB	1 987 482 013	↔ 1420	
					4SB	1 987 477 261	↔ 1737	
2.2 dCi 90	01.00-10.06	66			HTB	1 987 482 013	↔ 1420	
					4SB	1 987 477 261	↔ 1737	
2.5 D	10.97-09.03	60/73/74/81/ 84/88/107			HTB	1 987 482 013	↔ 1420	
					4SB	1 987 477 261	↔ 1737	
2.5 dCi 100	10.03-04.10	60/73/74/81/ 84/88/107			HTB	1 987 482 013	↔ 1420	
					4SB	1 987 477 261	↔ 1737	
2.5 dCi 110	10.03-10.06	60/73/74/81/ 84/88/107			HTB	1 987 482 013	↔ 1420	
					4SB	1 987 477 261	↔ 1737	
2.5 dCi 120	05.00-04.10	60/73/74/81/ 84/88/107			HTB	1 987 482 013	↔ 1420	
					4SB	1 987 477 261	↔ 1737	
2.5 dCi 120 FAP	11.06-04.10	60/73/74/81/ 84/88/107			HTB	1 987 482 013	↔ 1420	
					4SB	1 987 477 261	↔ 1737	
2.5 dCi 150 FAP	11.06-04.10	60/73/74/81/ 84/88/107			HTB	1 987 482 013	↔ 1420	
					4SB	1 987 477 261	↔ 1737	
2.8 D	05.01-10.04	81/84/86			HTB	1 987 482 013	↔ 1420	
					4SB	1 987 477 261	↔ 1737	
2.8 dTi 110	10.97-09.03	81/84/86			HTB	1 987 482 013	↔ 1420	
					4SB	1 987 477 261	↔ 1737	
2.8 dTi 120	10.97-09.03	81/84/86			HTB	1 987 482 013	↔ 1420	
					4SB	1 987 477 261	↔ 1737	
3.0 dCi 140	10.03-10.06	100			HTB	1 987 482 013	↔ 1420	
					4SB	1 987 477 261	↔ 1737	



Megane

								
	1.9 D	06.99-11.09	68			0 986 475 797	↔ 20,6	
		ABO 06.99-11.09	68			F 026 002 182	↔ 17,46	
	1.9 TD	08.98-12.99	77			F 026 002 182	↔ 17,46	
	2.0 i	05.98-05.01	85			F 026 002 182	↔ 17,46	
	2.0 i 16V	07.01-07.11	103			F 026 002 182	↔ 17,46	
								
	2.0 i	05.98-05.01	85			0 986 594 030 <sup>3</sup>		

Megane [BA10]

								
	1.6 i	09.97-09.07	54			F 026 002 182	↔ 17,46	
								
	1.6 i	09.97-09.07	54			0 986 594 030 <sup>3</sup>		

Megane I Cabrio [X64]

								
	1.4 i 16V	03.99-09.03	70			0 986 473 677	↔ 48	
						0 986 474 677	↔ 48	
		10.00-09.03	70			0 986 134 315	↔ 54	
						0 986 135 315	↔ 54	
	1.6 i	09.96-09.03	66			0 986 473 677	↔ 48	
						0 986 474 677	↔ 48	
	1.6 i 16V	03.99-09.03	79			0 986 134 315	↔ 54	
						0 986 135 315	↔ 54	
	2.0 i	09.96-09.03	83			0 986 473 677	↔ 48	
						0 986 474 677	↔ 48	





		S									
	◀ RENAULT Megane I Cabrio [X64]										
	2.0 i 16V	09.96-09.98	108			LLE	0986 473 786		← 54		
							0986 473 787		→ 54		
	10.98-09.03	108				RLE	0986 473 788		← 60		
							0986 473 789		→ 60		
							0986 134 315		← 54		
							0986 135 315		→ 54		
2.0 i 16V	03.99-09.03	102/103				0986 134 315		← 54			
2.0 i 16V IDE						0986 135 315		→ 54			
	1.4 i 16V	ABO	03.99-09.03	70			F 026 002 182		↔ 17,46		
		ABS	03.99-09.03	70			F 026 002 564		↔ 19		
			10.00-09.03	70		TKO	F 026 002 564		↔ 19		
	1.6 i		09.96-09.03	66			F 026 002 182		↔ 17,46		
	1.6 i 16V	ABO	03.99-09.03	79				F 026 002 182		↔ 17,46	
		ABS	03.99-09.03	79				F 026 002 564		↔ 19	
			05.00-09.03	79		TKO	F 026 002 564		↔ 19		
	2.0 i		09.96-09.03	83			F 026 002 182		↔ 17,46		
	2.0 i 16V IDE	ABO	01.01-09.03	103				F 026 002 182		↔ 17,46	
		ABS	01.01-09.03	103				F 026 002 564		↔ 19	
	1.4 i 16V	10.00-09.03	70			TKO	0204 102 182		← 48	0204 100 062 <sup>8</sup>	
							0986 134 316			0204 104 068 <sup>9</sup>	
							0204 102 184		→ 48	0204 100 062 <sup>8</sup>	
							0204 103 184				
							0986 135 316				
	1.6 i 16V	05.00-09.03	79			TKO	0204 102 182		← 48	0204 100 062 <sup>8</sup>	
							0986 134 316			0204 104 068 <sup>9</sup>	
							0204 102 184		→ 48	0204 100 062 <sup>8</sup>	
							0204 103 184				
							0986 135 316				
	2.0 i 16V	09.96-09.03	108				0204 102 182		← 48	0204 100 062 <sup>8</sup>	
							0986 134 316			0204 104 068 <sup>9</sup>	
							0204 102 184		→ 48	0204 100 062 <sup>8</sup>	
							0204 103 184				
							0986 135 316				
		01.01-09.03	102					0204 102 182		← 48	0204 100 062 <sup>8</sup>
								0986 134 316			0204 104 068 <sup>9</sup>
								0204 102 184		→ 48	0204 100 062 <sup>8</sup>
								0204 103 184			
								0986 135 316			
2.0 i 16V IDE	03.99-09.03	103				0204 102 182		← 48	0204 100 062 <sup>8</sup>		
						0986 134 316			0204 104 068 <sup>9</sup>		
						0204 102 184		→ 48	0204 100 062 <sup>8</sup>		
						0204 103 184					
						0986 135 316					
10.00-09.03	103				TKO	0204 102 182		← 48	0204 100 062 <sup>8</sup>		
						0986 134 316			0204 104 068 <sup>9</sup>		
						0204 102 184		→ 48	0204 100 062 <sup>8</sup>		
						0204 103 184					
						0986 135 316					
	1.4 i 16V	03.99-09.03	70				1987 477 640		1367		
	1.6 i, i 16V	09.96-09.03	66/79				1987 477 640		1367		
	2.0 i	09.96-09.03	83				1987 477 640		1367		
	1.4 i 16V	03.99-09.03	70				0986 594 030 <sup>3</sup>				
	1.6 i, i 16V	09.96-09.03	66/79				0986 594 030 <sup>3</sup>				
	2.0 i, i 16V, i 16V IDE	09.96-09.03	83/102/103				0986 594 030 <sup>3</sup>				
	2.0 i 16V	10.98-09.03	108				0986 594 030 <sup>3</sup>				



**Megane I Classic [X64]**



	1.4i	ABO 09.96-04.98	55		0 986 473 671		← 48	
					0 986 474 671		→ 48	
		05.98-09.03	55		0 986 473 677		← 48	
					0 986 474 677		→ 48	
		ABS 09.96-10.97	55		0 986 473 671		← 48	
					0 986 474 671		→ 48	
		11.97-09.03	55		0 986 473 677		← 48	
					0 986 474 677		→ 48	
	1.4i	02.99-09.03	51/70		0 986 473 677		← 48	
	1.4i 16V				0 986 474 677		→ 48	
	1.6i	09.96-09.03	66		0 986 473 677		← 48	
					0 986 474 677		→ 48	
		05.00-09.03	79		0 986 134 315		← 54	
					0 986 135 315		→ 54	
		ABO 09.96-04.98	55		0 986 473 671		← 48	
					0 986 474 671		→ 48	
		05.98-09.03	55		0 986 473 677		← 48	
					0 986 474 677		→ 48	
		ABS 09.96-10.97	55		0 986 473 671		← 48	
					0 986 474 671		→ 48	
		11.97-09.03	55		0 986 473 677		← 48	
					0 986 474 677		→ 48	
	1.6i	08.98-09.03	79		0 986 473 677		← 48	
	1.6i 16V				0 986 474 677		→ 48	
	1.6i 16V	08.98-09.03	79	4T0	0 986 134 315		← 54	
						0 986 135 315		→ 54
		08.99-09.03	79	2T0,TW	0 986 134 315		← 54	
					0 986 135 315		→ 54	
	1.8i	05.00-09.03	85/88		0 986 134 315		← 54	
					0 986 135 315		→ 54	
	1.9D	09.96-10.97	47-48		0 986 473 671		← 48	
					0 986 474 671		→ 48	
		11.97-09.03	47-48		0 986 473 677		← 48	
					0 986 474 677		→ 48	
	1.9D Turbo	09.96-09.03	59/66-69		0 986 473 677		← 48	
	1.9DTI				0 986 474 677		→ 48	
	1.9DCI	04.99-09.03	72-75		0 986 134 315		← 54	
						0 986 135 315		→ 54
		05.00-09.03	75		0 986 134 315		← 54	
					0 986 473 677		← 48	
					0 986 135 315		→ 54	
					0 986 474 677		→ 48	
	1.9DTI	08.97-09.03	72		0 986 473 677		← 48	
						0 986 474 677		→ 48
		04.99-09.03	72		0 986 134 315		← 54	
					0 986 135 315		→ 54	
	2.0i	09.96-04.97	83-84		0 986 473 677		← 48	
					0 986 474 677		→ 48	
			09.96-09.03	84		0 986 473 677		← 48
						0 986 474 677		→ 48
			04.99-09.03	84		0 986 134 315		← 54
					0 986 135 315		→ 54	
		11.00-09.03	101,5/102		0 986 134 315		← 54	
					0 986 135 315		→ 54	



	1.4i	09.96-09.03	55		F 026 002 182		↔ 17,46
					F 026 002 564		↔ 19
		ABS 04.99-09.03	51		F 026 002 564		↔ 19





	◀ RENAULT Megane I Classic [X64]								
1.4 i, i 16V	ABO	02.99-09.03	51/70			F 026 002 182	↔	17,46	
1.4 i 16V	ABS	04.99-09.03	70			F 026 002 564	↔	19	
1.6 i		09.96-09.03	55			F 026 002 182	↔	17,46	
			66			F 026 002 182	↔	17,46	
		10.99-09.03	79			F 026 002 182	↔	17,46	
		05.00-09.03	79			F 026 002 564	↔	19	
	ABO	09.96-09.03	66			F 026 002 182	↔	17,46	
1.6 i 16V	ABS	09.96-03.99	66			F 026 002 182	↔	17,46	
		04.99-09.03	66			F 026 002 564	↔	19	
1.9 D	ABO	08.98-09.03	79			F 026 002 182	↔	17,46	
	ABS	08.98-09.03	79			F 026 002 564	↔	19	
1.9 D		09.96-09.03	47			F 026 002 182	↔	17,46	
			47-48			F 026 002 182	↔	17,46	
	ABO	06.98-09.03	47-48			F 026 002 182	↔	17,46	
1.9 D Turbo		09.96-09.03	66-69			F 026 002 182	↔	17,46	
1.9 D, DTI	ABS	06.98-09.03	47-48/59/72			F 026 002 564	↔	19	
1.9 DCI		05.00-09.03	75			F 026 002 564	↔	19	
	ABO	04.99-09.03	72-75		TKO	F 026 002 182	↔	17,46	
		05.00-09.03	75			F 026 002 182	↔	17,46	
	ABS	04.99-09.03	72-75		TKO	F 026 002 564	↔	19	
		05.00-09.03	75			F 026 002 564	↔	19	
1.9 DTI		08.97-09.03	72			F 026 002 182	↔	17,46	
	ABO	04.99-09.03	72			F 026 002 182	↔	17,46	
		11.00-09.03	59			F 026 002 182	↔	17,46	
2.0 i		09.96-04.97	83-84			F 026 002 182	↔	17,46	
		09.96-09.03	84			F 026 002 182	↔	17,46	
	ABO	09.96-09.03	84			F 026 002 182	↔	17,46	
	ABS	09.96-03.99	84			F 026 002 182	↔	17,46	
		04.99-09.03	84			F 026 002 564	↔	19	



	1.4 i	05.00-09.03	70		TKO	0 204 102 182	←	48	0 204 100 062 <sup>8</sup>
						0 986 134 316	↻		0 204 104 068 <sup>9</sup>
						0 204 102 184	→	48	0 204 100 062 <sup>8</sup>
						0 204 103 184	↻		
						0 986 135 316	↻		
	1.6 i	05.00-09.03	79		TKO	0 204 102 182	←	48	0 204 100 062 <sup>8</sup>
						0 986 134 316	↻		0 204 104 068 <sup>9</sup>
						0 204 102 184	→	48	0 204 100 062 <sup>8</sup>
						0 204 103 184	↻		
						0 986 135 316	↻		
	1.8 i	05.00-09.03	85/88			0 204 102 182	←	48	0 204 100 062 <sup>8</sup>
						0 986 134 316	↻		0 204 104 068 <sup>9</sup>
						0 204 102 184	→	48	0 204 100 062 <sup>8</sup>
						0 204 103 184	↻		
						0 986 135 316	↻		
	1.9 DCI	04.99-09.03	72-75		TKO	0 204 102 182	←	48	0 204 100 062 <sup>8</sup>
						0 986 134 316	↻		0 204 104 068 <sup>9</sup>
						0 204 102 184	→	48	0 204 100 062 <sup>8</sup>
						0 204 103 184	↻		
						0 986 135 316	↻		
	2.0 i	03.01-09.03	101,5/102			0 204 102 182	←	48	0 204 100 062 <sup>8</sup>
						0 986 134 316	↻		0 204 104 068 <sup>9</sup>
						0 204 102 184	→	48	0 204 100 062 <sup>8</sup>
						0 204 103 184	↻		
						0 986 135 316	↻		

	1.4 i	09.96-09.03	55		FEN	1987 477 636	↔	1473
					FEV	1987 477 475	↔	1440
		02.99-09.03	51			1987 477 636	↔	1473
		05.00-09.03	70		FEN,TKO	1987 477 636	↔	1473
					FEV,TKO	1987 477 475		1440

		S							
<b>1.4i</b>		07.01-09.03	70				1 987 477 636	↔	1473
<b>1.4i 16V</b>		03.99-09.03	70			2TO	1 987 477 475		1440
						4TO	1 987 477 636	↔	1473
<b>1.6i</b>		09.96-09.03	55				1 987 477 636	↔	1473
			66				1 987 477 475		1440
						FEN	1 987 477 636	↔	1473
						FEV	1 987 477 475	↔	1440
		10.99-09.03	79				1 987 477 475		1440
		05.00-09.03	79			FEN,TKO	1 987 477 636	↔	1473
						FEV,TKO	1 987 477 475		1440
<b>1.6i 16V</b>		08.98-09.03	79			2TO	1 987 477 475		1440
						4TO	1 987 477 636	↔	1473
<b>1.8i</b>		05.00-09.03	85			FEN	1 987 477 636	↔	1473
			88				1 987 477 475		1440
						FEN	1 987 477 636	↔	1473
<b>1.9D</b>		09.96-09.03	47				1 987 477 475		1440
			47-48			FEN	1 987 477 636	↔	1473
						FEV	1 987 477 475	↔	1440
		06.98-09.03	47-48			2TO	1 987 477 475		1440
						4TO	1 987 477 636	↔	1473
<b>1.9D Turbo</b>		09.96-09.03	66-69				1 987 477 636	↔	1473
<b>1.9DCI</b>		04.99-09.03	72-75			TKO	1 987 477 636	↔	1473
		05.00-09.03	75				1 987 477 636	↔	1473
						FEN,TKO	1 987 477 636	↔	1473
						FEV,TKO	1 987 477 475		1440
<b>1.9DTI</b>		08.97-02.99	72			FEN	1 987 477 636	↔	1473
						FEV	1 987 477 475	↔	1440
		08.97-09.03	72				1 987 477 636	↔	1473
		04.99-09.03	72			FEN	1 987 477 636	↔	1473
						FEV	1 987 477 475	↔	1440
		11.00-09.03	59			FEN	1 987 477 636	↔	1473
						FEV	1 987 477 475	↔	1440
<b>2.0i</b>		09.96-09.03	84/101,5/102				1 987 477 475		1440
<b>1.4i, i 16V</b>		09.96-09.03	51/55/70				0 986 594 030 <sup>3</sup>		
<b>1.6i, i 16V</b>		09.96-09.03	55/66/79				0 986 594 030 <sup>3</sup>		
<b>1.8i</b>		05.00-09.03	85/88				0 986 594 030 <sup>3</sup>		
<b>1.9D, D Turbo, DCI, DTI</b>		09.96-09.03	47-48/59/66-69/72-75				0 986 594 030 <sup>3</sup>		
<b>2.0i</b>		09.96-09.03	83-84/101,5/102				0 986 594 030 <sup>3</sup>		
<b>Megane I Coupé [X64]</b>									
<b>1.4i 16V</b>		03.99-10.02	70				0 986 473 677		← 48
							0 986 474 677		→ 48
		05.00-10.02	70				0 986 134 315		← 54
							0 986 135 315		→ 54
<b>1.6i</b>		01.96-10.02	66				0 986 473 677		← 48
							0 986 474 677		→ 48
<b>1.6i 16V</b>		03.99-10.02	79				0 986 134 315		← 54
							0 986 135 315		→ 54
<b>1.9DCI</b>		03.99-10.02	72-75				0 986 134 315		← 54
							0 986 135 315		→ 54
<b>1.9DTI</b>		06.97-02.99	72				0 986 473 677		← 48
							0 986 474 677		→ 48
		03.99-10.02	72				0 986 134 315		← 54
							0 986 135 315		→ 54
<b>2.0i</b>		01.96-10.02	83/84				0 986 473 677		← 48
							0 986 474 677		→ 48
<b>2.0i 16V</b>		01.96-10.02	108			LLE	0 986 473 786		← 54
							0 986 473 787		→ 54
						RLE	0 986 473 788		← 60
							0 986 473 789		→ 60



		S								
	◀ RENAULT Megane I Coupé [X64]									
2.0 i 16V		03.99-10.02	102/103				0986 134 315		← 54	
2.0 i 16V IDE							0986 135 315		→ 54	
	1.4 i 16V	05.00-10.02	70				F 026 002 564		↔ 19	
		ABO 03.99-10.02	70				F 026 002 182		↔ 17,46	
		ABS 03.99-10.02	70				F 026 002 564		↔ 19	
	1.6 i	01.96-10.02	66				F 026 002 182		↔ 17,46	
	1.6 i 16V	03.99-10.02	79				F 026 002 564		↔ 19	
	1.9 DCI	05.00-10.02	75				F 026 002 564		↔ 19	
		ABO 03.99-10.02	72-75		TKO		F 026 002 182		↔ 17,46	
		ABS 03.99-10.02	72-75		TKO		F 026 002 564		↔ 19	
		05.00-10.02	75		TKO		F 026 002 564		↔ 19	
	1.9 DTI	06.97-02.99	72				F 026 002 182		↔ 17,46	
		03.99-10.02	72				F 026 002 564		↔ 19	
	2.0 i	01.96-10.02	83/84				F 026 002 182		↔ 17,46	
	1.4 i 16V	03.01-10.02	70		TKO		0 204 102 182		← 48	0 204 100 062 <sup>8</sup>
							0986 134 316			0 204 104 068 <sup>9</sup>
							0 204 102 184		→ 48	0 204 100 062 <sup>8</sup>
							0 204 103 184			
							0986 135 316			
	1.6 i 16V	05.00-10.02	79		TKO		0 204 102 182		← 48	0 204 100 062 <sup>8</sup>
							0986 134 316			0 204 104 068 <sup>9</sup>
							0 204 102 184		→ 48	0 204 100 062 <sup>8</sup>
							0 204 103 184			
							0986 135 316			
	1.9 DCI	03.99-10.02	72-75		TKO		0 204 102 182		← 48	0 204 100 062 <sup>8</sup>
							0986 134 316			0 204 104 068 <sup>9</sup>
							0 204 102 184		→ 48	0 204 100 062 <sup>8</sup>
							0 204 103 184			
							0986 135 316			
	2.0 i 16V	01.96-04.97	108				0 204 102 184		→ 48	0 204 104 045 <sup>7</sup>
							0 204 103 184			0 204 104 068 <sup>9</sup>
							0986 135 316			
		01.96-10.02	108				0 204 102 182		← 48	0 204 100 062 <sup>8</sup>
							0986 134 316			
							0 204 102 184		→ 48	0 204 100 062 <sup>8</sup>
							0 204 103 184			
							0986 135 316			
		05.97-10.02	108				0 204 102 182		← 48	0 204 104 045 <sup>7</sup>
							0986 134 316			0 204 104 068 <sup>9</sup>
	2.0 i 16V	03.99-10.02	102/103				0 204 102 182		← 48	0 204 100 062 <sup>8</sup>
	2.0 i 16V IDE						0986 134 316			0 204 104 068 <sup>9</sup>
							0 204 102 184		→ 48	0 204 100 062 <sup>8</sup>
							0 204 103 184			
							0986 135 316			
	1.4 i 16V	03.99-10.02	70				1 987 477 781			1332
		03.01-10.02	70				1 987 477 640			1367
	1.6 i	01.96-10.02	66				1 987 477 781			1332
	1.6 i 16V	03.99-10.02	79				1 987 477 640			1367
		05.00-10.02	79		TKO		1 987 477 640			1367
	1.9 DCI, DTI	06.97-10.02	72-75				1 987 477 640			1367
	2.0 i	01.96-10.02	83/84				1 987 477 640			1367
	1.4 i 16V	03.99-10.02	70				0986 594 030 <sup>3</sup>			
	1.6 i, i 16V	01.96-10.02	66/79				0986 594 030 <sup>3</sup>			
	1.9 DCI, DTI	06.97-10.02	72-75				0986 594 030 <sup>3</sup>			
	2.0 i, i 16V, i 16V IDE	01.96-10.02	83/84/102/103				0986 594 030 <sup>3</sup>			
	2.0 i 16V	10.98-10.02	108				0986 594 030 <sup>3</sup>			



**Megane I Grandtour [X64]**

	<b>1.4i</b>	03.99-09.03	51/70	0 986 473 677		← 48	
	<b>1.4i 16V</b>			0 986 474 677		→ 48	
	<b>1.6i</b>	07.98-09.03	66	0 986 473 677		← 48	
				0 986 474 677		→ 48	
	<b>1.6i 16V</b>	03.99-09.03	79	0 986 134 315		← 54	
				0 986 135 315		→ 54	
	<b>1.8i 16V</b>	10.00-09.03	85/88	0 986 134 315		← 54	
				0 986 135 315		→ 54	
	<b>1.9D</b>	03.99-09.03	47	0 986 473 677		← 48	
				0 986 474 677		→ 48	
		01.01-09.03	47	0 986 134 315		← 54	
				0 986 135 315		→ 54	
	<b>1.9D, DCI, DTI</b>	07.98-09.03	59/72-75	0 986 134 315		← 54	
	<b>1.9DCI</b>	05.00-09.03	75	0 986 473 677		← 48	
				0 986 474 677		→ 48	
		05.01-09.03	75	0 986 134 315		← 54	
				0 986 135 315		→ 54	

	<b>1.4i</b>	03.99-09.03	51	0 986 475 797		↔ 20,6	
	<b>1.4i 16V</b>	03.99-09.03	70	0 986 475 797		↔ 20,6	
		05.00-09.03	70	F 026 002 564		↔ 19	
	<b>1.6i</b>	07.98-09.03	66	0 986 475 797		↔ 20,6	
	<b>1.6i 16V</b>	03.99-05.99	79	0 986 475 797		↔ 20,6	
	<b>1.9DCI, DTI</b>	07.98-05.99	72-75	0 986 475 797		↔ 20,6	

	<b>1.4i 16V</b>	05.00-09.03	70	0 986 473 471		← 33,9	
				0 986 474 471		→ 33,9	
	<b>1.6i 16V</b>	03.99-09.03	79	0 986 473 471		← 33,9	
				0 986 474 471		→ 33,9	
	<b>1.8i 16V</b>	10.00-09.03	85/88	0 986 473 471		← 33,9	
				0 986 474 471		→ 33,9	
	<b>1.9D</b>	06.99-09.03	59/72-75	0 986 473 471		← 33,9	
	<b>1.9DCI,DTI</b>			0 986 474 471		→ 33,9	

	<b>1.4i, i 16V</b>	03.99-09.03	51/70	1 987 477 637		1456	
	<b>1.6i</b>	07.98-09.03	66	1 987 477 637		1456	
	<b>1.6i 16V</b>	03.99-09.03	79	1 987 477 653		→ 1480	
				1 987 477 654		← 1519	
	<b>1.8i 16V</b>	10.00-09.03	85/88	1 987 477 653		→ 1480	
				1 987 477 654		← 1519	
	<b>1.9D</b>	03.99-09.03	47	1 987 477 637		1456	
	<b>1.9DCI</b>	07.98-09.03	72-75	1 987 477 653		→ 1480	
	<b>1.9DTI</b>			1 987 477 654		← 1519	

	<b>1.4i, i 16V</b>	03.99-09.03	51/70	0 986 594 030 <sup>3</sup>			
	<b>1.6i, i 16V</b>	07.98-09.03	66/79	0 986 594 030 <sup>3</sup>			
	<b>1.8i 16V</b>	10.00-09.03	85/88	0 986 594 030 <sup>3</sup>			
	<b>1.9D, DCI, DTI</b>	07.98-09.03	47/59/72-75	0 986 594 030 <sup>3</sup>			

**Megane I [X64]**

	<b>1.4i</b>	01.96-02.99	51-52	0 986 473 671		← 48	
				0 986 474 671		→ 48	
			55	0 986 473 671		← 48	
				0 986 474 671		→ 48	





◀RENAULT Megane I [X64]				
1.4 i	03.99-10.02	51-55		0986 473 677 ↻ ← 48
				0986 474 677 ↻ → 48
1.4 i 16V	06.98-10.02	70		0986 473 677 ↻ ← 48
				0986 474 677 ↻ → 48
1.6 i	01.96-02.99	55		0986 473 671 ↻ ← 48
				0986 474 671 ↻ → 48
		66		0986 473 677 ↻ ← 48
				0986 474 677 ↻ → 48
1.6 i 16V	01.01-10.02	66		0986 473 677 ↻ ← 48
				0986 474 677 ↻ → 48
	06.98-10.02	79	2TO	0986 473 677 ↻ ← 48
				0986 474 677 ↻ → 48
1.6 i 16V			4TO	0986 134 315 ↻ ← 54
				0986 135 315 ↻ → 54
	10.99-10.02	79		0986 473 677 ↻ ← 48
				0986 474 677 ↻ → 48
1.6 i 16V	05.00-10.02	79		0986 134 315 ↻ ← 54
				0986 135 315 ↻ → 54
1.8 i 16V	03.99-10.02	85/88		0986 134 315 ↻ ← 54
				0986 135 315 ↻ → 54
1.9 D	01.96-02.99	47		0986 473 671 ↻ ← 48
				0986 474 671 ↻ → 48
		47-48		0986 473 671 ↻ ← 48
				0986 474 671 ↻ → 48
1.9 D	06.98-10.02	47-48		0986 473 677 ↻ ← 48
				0986 474 677 ↻ → 48
1.9 D Turbo	01.96-02.99	66-70		0986 473 677 ↻ ← 48
1.9 DTI				0986 474 677 ↻ → 48
1.9 DCI	03.99-10.02	72-75		0986 134 315 ↻ ← 54
				0986 135 315 ↻ → 54
		75		0986 473 677 ↻ ← 48
				0986 474 677 ↻ → 48
1.9 DCI	05.00-10.02	75		0986 134 315 ↻ ← 54
				0986 135 315 ↻ → 54
1.9 DTI	06.97-02.99	72		0986 473 677 ↻ ← 48
				0986 474 677 ↻ → 48
	03.99-10.02	72		0986 134 315 ↻ ← 54
				0986 135 315 ↻ → 54
1.9 DTI	01.01-10.02	59		0986 134 315 ↻ ← 54
				0986 473 677 ↻ ← 48
				0986 135 315 ↻ → 54
				0986 474 677 ↻ → 48
2.0 i	01.96-10.02	83/84		0986 473 677 ↻ ← 48
2.0 i 16V				0986 474 677 ↻ → 48
	01.96-09.98	108-110		0986 473 786 ↻ ← 54
2.0 i 16V				0986 473 787 ↻ → 54
	10.98-10.02	108-110		0986 134 315 ↻ ← 54
				0986 135 315 ↻ → 54
	05.00-10.02	101,5/103		0986 134 315 ↻ ← 54
				0986 135 315 ↻ → 54

◀RENAULT Megane I [X64]				
1.4 i	01.96-02.99	51-52/55		F 026 002 182 ↔ 17,46
	ABO 03.99-10.02	51-55		F 026 002 182 ↔ 17,46
1.4 i 16V	ABS 03.99-03.99	51-55		F 026 002 182 ↔ 17,46
		04.99-10.02	51-55	F 026 002 564 ↔ 19
1.4 i 16V	01.01-10.02	70		F 026 002 182 ↔ 17,46
	ABO 06.98-10.02	70		F 026 002 182 ↔ 17,46
	ABS 06.98-10.02	70		F 026 002 564 ↔ 19
		05.00-10.02	70	TKO
1.6 i	01.96-02.99	55		F 026 002 182 ↔ 17,46
		66		F 026 002 182 ↔ 17,46

	S								
<b>1.6i</b>	01.01-10.02	66				F 026 <b>002 182</b>		↔ 17,46	
<b>1.6i 16V</b>	10.99-10.02	79				F 026 <b>002 182</b>		↔ 17,46	
	ABO 06.98-10.02	79				F 026 <b>002 182</b>		↔ 17,46	
	ABS 06.98-10.02	79				F 026 <b>002 564</b>		↔ 19	
	05.00-10.02	79		TKO		F 026 <b>002 564</b>		↔ 19	
<b>1.9D</b>	01.96-02.99	47				F 026 <b>002 182</b>		↔ 17,46	
		47-48				F 026 <b>002 182</b>		↔ 17,46	
	ABO 06.98-10.02	47-48				F 026 <b>002 182</b>		↔ 17,46	
	ABS 06.98-10.02	47-48				F 026 <b>002 564</b>		↔ 19	
<b>1.9D Turbo, DTI</b>	01.96-02.99	66-70				F 026 <b>002 182</b>		↔ 17,46	
<b>1.9DCI</b>	01.01-10.02	75				F 026 <b>002 182</b>		↔ 17,46	
	ABO 03.99-10.02	72-75				F 026 <b>002 182</b>		↔ 17,46	
	01.01-10.02	75				F 026 <b>002 182</b>		↔ 17,46	
	ABS 03.99-10.02	72-75				F 026 <b>002 564</b>		↔ 19	
				TKO		F 026 <b>002 564</b>		↔ 19	
<b>1.9DTI</b>	01.01-10.02	59				F 026 <b>002 182</b>		↔ 17,46	
	ABO 03.99-10.02	72				F 026 <b>002 182</b>		↔ 17,46	
	ABS 06.97-03.99	72				F 026 <b>002 182</b>		↔ 17,46	
	04.99-10.02	72				F 026 <b>002 564</b>		↔ 19	
	01.01-10.02	59			TKO	F 026 <b>002 564</b>		↔ 19	
<b>2.0i</b>	01.96-10.02	83/84				F 026 <b>002 182</b>		↔ 17,46	
<b>1.4i 16V</b>	05.00-10.02	70			TKO	0 204 <b>102 182</b>	← 48	0 204 <b>100 062<sup>B</sup></b>	
						0 986 <b>134 316</b>		0 204 <b>104 068<sup>9</sup></b>	
						0 204 <b>102 184</b>	→ 48	0 204 <b>100 062<sup>B</sup></b>	
						0 204 <b>103 184</b>			
						0 986 <b>135 316</b>			
<b>1.6i 16V</b>	05.00-10.02	79			TKO	0 204 <b>102 182</b>	← 48	0 204 <b>100 062<sup>B</sup></b>	
						0 986 <b>134 316</b>		0 204 <b>104 068<sup>9</sup></b>	
						0 204 <b>102 184</b>	→ 48	0 204 <b>100 062<sup>B</sup></b>	
						0 204 <b>103 184</b>			
						0 986 <b>135 316</b>			
<b>1.8i 16V</b>	03.99-10.02	85/88				0 204 <b>102 182</b>	← 48	0 204 <b>100 062<sup>B</sup></b>	
						0 986 <b>134 316</b>		0 204 <b>104 068<sup>9</sup></b>	
						0 204 <b>102 184</b>	→ 48	0 204 <b>100 062<sup>B</sup></b>	
						0 204 <b>103 184</b>			
						0 986 <b>135 316</b>			
<b>1.9DCI</b> <b>1.9DTI</b>	03.99-10.02	59/72-75			TKO	0 204 <b>102 182</b>	← 48	0 204 <b>100 062<sup>B</sup></b>	
						0 986 <b>134 316</b>		0 204 <b>104 068<sup>9</sup></b>	
						0 204 <b>102 184</b>	→ 48	0 204 <b>100 062<sup>B</sup></b>	
						0 204 <b>103 184</b>			
						0 986 <b>135 316</b>			
<b>2.0i 16V</b>	01.96-10.02	103/ 108-110				0 204 <b>102 182</b>	← 48	0 204 <b>100 062<sup>B</sup></b>	
						0 986 <b>134 316</b>		0 204 <b>104 068<sup>9</sup></b>	
						0 204 <b>102 184</b>	→ 48	0 204 <b>100 062<sup>B</sup></b>	
						0 204 <b>103 184</b>			
						0 986 <b>135 316</b>			
<b>1.4i</b> <b>1.4i 16V</b>	01.96-10.02	51-55				1 987 <b>477 475</b>		↔ 1440	
	06.98-10.02	70				1 987 <b>477 475</b>		↔ 1440	
		05.00-10.02	70			1 987 <b>477 636</b>		↔ 1473	
		01.01-10.02	70			FEN,FKØ FEV,FKØ	1 987 <b>477 636</b>	↔ 1473	
	01.96-02.99	55				1 987 <b>477 475</b>		↔ 1440	
		66				1 987 <b>477 475</b>		↔ 1440	
		01.01-10.02	66			1 987 <b>477 475</b>		↔ 1440	
	<b>1.6i 16V</b>	06.98-10.02	79			2TO 4TO	1 987 <b>477 475</b>		↔ 1440
							1 987 <b>477 636</b>		↔ 1473
		10.99-10.02	79				1 987 <b>477 475</b>		↔ 1440
05.00-10.02		79				1 987 <b>477 636</b>		↔ 1473	







**RENAULT Megane I [X64]**

1.6 i 16V	01.01-10.02	79	FEN,TKO	1987 477 636	↔ 1473
			FEV,TKO	1987 477 475	↔ 1440
1.9 D	01.96-10.02	47-48		1987 477 475	↔ 1440
1.9 D Turbo	01.96-02.99	59/66-70/72-75		1987 477 636	↔ 1473
1.9 DCI	03.99-10.02	59/66-70/72-75		1987 477 636	↔ 1473
		75	FEN,TKO	1987 477 636	↔ 1473
			FEV,TKO	1987 477 475	↔ 1440
	05.00-10.02	75		1987 477 636	↔ 1473
1.9 DTI	06.97-10.02	59/66-70/72-75		1987 477 636	↔ 1473
2.0 i	01.96-10.02	83/84		1987 477 636	↔ 1473
2.0 i 16V	05.00-10.02	103		1987 477 475	↔ 1440

1.4 i, i 16V	01.96-10.02	51-55/70		0986 594 030 <sup>3</sup>	
1.6 i, i 16V	01.96-10.02	55/66/79		0986 594 030 <sup>3</sup>	
1.8 i 16V	03.99-10.02	85/88		0986 594 030 <sup>3</sup>	
1.9 D, D Turbo, DCI, DTI	01.96-10.02	47-48/59/66-70/72-75		0986 594 030 <sup>3</sup>	
2.0 i, i 16V	01.96-10.02	83/84/101,5/103		0986 594 030 <sup>3</sup>	
2.0 i 16V	10.98-10.02	108-110		0986 594 030 <sup>3</sup>	

**Megane II Cabrio [EM]**

1.5 DCI	12.05-03.10	76/78		0986 473 335	↔ 54
				0986 474 335	↔ 54
1.6 16V	10.03-10.05	83		0204 004 342	↔ 54
				0986 473 334	↔ 54
				0204 004 343	↔ 54
				0986 474 334	↔ 54
	11.05-03.10	83		0986 473 335	↔ 54
				0986 474 335	↔ 54
1.9 DCI	10.03-10.05	88/96		0204 004 342	↔ 54
				0986 473 334	↔ 54
				0204 004 343	↔ 54
				0986 474 334	↔ 54
	11.05-03.10	88/96		0986 473 335	↔ 54
				0986 474 335	↔ 54
2.0 DCI	10.03-10.05	99/110/		0204 004 342	↔ 54
2.0 T		120		0986 473 334	↔ 54
2.0 16V				0204 004 343	↔ 54
				0986 474 334	↔ 54
	11.05-03.10	99/110/		0986 473 335	↔ 54
		120		0986 474 335	↔ 54

1.5 DCI	12.05-03.10	76/78		0986 473 280	↔ 34
				0986 474 280	↔ 34
1.6 16V	10.03-03.10	83		0986 473 280	↔ 34
				0986 474 280	↔ 34
1.9 DCI	10.03-03.10	88/96		0986 473 280	↔ 34
				0986 474 280	↔ 34
2.0 DCI, T, 16V	10.03-03.10	99/110/		0986 473 280	↔ 34
		120		0986 474 280	↔ 34

1.5 DCI	12.05-03.10	76/78		1987 482 011	↔ 1940
1.6 16V	10.03-03.10	83		1987 482 011	↔ 1940
1.9 DCI	10.03-03.10	88/96		1987 482 011	↔ 1940
2.0 DCI	09.04-03.10	99/110/120		1987 482 011	↔ 1940
2.0 T	10.03-03.10	99/110/120		1987 482 011	↔ 1940
2.0 16V	10.03-03.10	99/110/120		1987 482 011	↔ 1940



	1.5 DCI	12.05-12.05	76/78	0 265 007 468 <sup>4</sup>	
	1.6 16V	10.03-01.05	83	0 265 007 467 <sup>3</sup>	
		10.03-12.05	83	0 265 007 468 <sup>4</sup>	
	1.9 DCI	10.03-01.05	88/96	0 265 007 467 <sup>3</sup>	
		10.03-12.05	88/96	0 265 007 468 <sup>4</sup>	
	2.0 DCI, T, 16V	10.03-01.05	99/110/120	0 265 007 467 <sup>3</sup>	
10.03-12.05		99/110/120	0 265 007 468 <sup>4</sup>		

**Megane II Grandtour [KM.]**



	1.4 16V	10.03-10.05	72	0 204 004 342	← 54
				0 986 473 334	↻
				0 204 004 343	→ 54
				0 986 474 334	↻
		11.05-05.09	72	0 986 473 335	↻ ← 54
				0 986 474 335	↻ → 54
1.5 DCI	10.03-10.05	60/63/76/ 78	0 204 004 342	← 54	
			0 986 473 334	↻	
			0 204 004 343	→ 54	
			0 986 474 334	↻	
		11.05-05.09	60/63/76/ 78	0 986 473 335	↻ ← 54
				0 986 474 335	↻ → 54
1.6 1.6 16V	10.03-10.05	83	0 204 004 342	← 54	
			0 986 473 334	↻	
			0 204 004 343	→ 54	
			0 986 474 334	↻	
		11.05-05.09	83	0 986 473 335	↻ ← 54
				0 986 474 335	↻ → 54
1.6 Flex-Fuel	02.08-05.09	77	0 986 473 335	↻ ← 54	
			0 986 474 335	↻ → 54	
1.9 DCI	10.03-10.05	68/88/96	0 204 004 342	← 54	
			0 986 473 334	↻	
			0 204 004 343	→ 54	
			0 986 474 334	↻	
		11.05-05.09	68/88/96	0 986 473 335	↻ ← 54
				0 986 474 335	↻ → 54
2.0 DCI 2.0 16V	10.03-10.05	99/110	0 204 004 342	← 54	
			0 986 473 334	↻	
			0 204 004 343	→ 54	
			0 986 474 334	↻	
		11.05-05.09	99/110	0 986 473 335	↻ ← 54
				0 986 474 335	↻ → 54



	1.4 16V	10.03-05.09	72	0 986 473 280	↻ ← 34
				0 986 474 280	↻ → 34
1.5 DCI	10.03-05.09	60/63/76/ 78	0 986 473 280	↻ ← 34	
			0 986 474 280	↻ → 34	
1.6, Flex-Fuel, 16V	10.03-05.09	77/83	0 986 473 280	↻ ← 34	
			0 986 474 280	↻ → 34	
1.9 DCI	10.03-05.09	68/88/96	0 986 473 280	↻ ← 34	
			0 986 474 280	↻ → 34	
2.0 DCI 2.0 16V	10.03-05.09	99/110	0 986 473 280	↻ ← 34	
			0 986 474 280	↻ → 34	



	1.4 16V	10.03-05.09	72	1 987 477 787	↔ 2080
	1.5 DCI	10.03-05.09	60/63/76/78	1 987 477 787	↔ 2080
	1.6	05.05-05.09	77/83	1 987 477 787	↔ 2080
	1.6 Flex-Fuel	02.08-05.09	77/83	1 987 477 787	↔ 2080





	◀ RENAULT Megane II Grandtour [KM.]			
	1.6 16V	10.03-05.09	77/83	1987 477 787 ↔ 2080
	1.9 DCI	10.03-05.09	68/88/96	1987 477 787 ↔ 2080
	2.0 DCI	09.04-05.09	99/110	1987 477 787 ↔ 2080
	2.0 16V	10.03-05.09	99/110	1987 477 787 ↔ 2080

	1.4 16V	10.03-01.05	72	0 265 007 467 <sup>3</sup>
		10.03-12.05	72	0 265 007 468 <sup>4</sup>
	1.5 DCI	10.03-01.05	60/63/76/78	0 265 007 467 <sup>3</sup>
		10.03-12.05	60/63/76/78	0 265 007 468 <sup>4</sup>
	1.6, 16V	10.03-12.05	83	0 265 007 468 <sup>4</sup>
	1.6 16V	10.03-01.05	83	0 265 007 467 <sup>3</sup>
	1.9 DCI	10.03-01.05	68/88/96	0 265 007 467 <sup>3</sup>
		10.03-12.05	68/88/96	0 265 007 468 <sup>4</sup>
	2.0 DCI	10.03-01.05	99/110	0 265 007 467 <sup>3</sup>
	2.0 16V	10.03-12.05	99/110	0 265 007 468 <sup>4</sup>

**Megane II Hatchback [BM./CM./GM./SM.]**

	1.4 16V	11.02-05.04	72	0 204 004 346 ← 54
				0 204 004 347 → 54
		11.05-10.08	72	0 986 473 335 ↻ ← 54
				0 986 474 335 ↻ → 54
	1.5 DCI	11.02-10.05	60/63/76/78	0 204 004 342 ← 54
				0 986 473 334 ↻
				0 204 004 343 → 54
				0 986 474 334 ↻
		11.05-10.08	60/63/76/78	0 986 473 335 ↻ ← 54
				0 986 474 335 ↻ → 54
	1.6	11.02-10.05	83	0 204 004 342 ← 54
	1.6 16V			0 986 473 334 ↻
				0 204 004 343 → 54
				0 986 474 334 ↻
		11.05-10.08	83	0 986 473 335 ↻ ← 54
				0 986 474 335 ↻ → 54
	1.6 16V Flex-Fuel	01.07-10.08	77	0 986 473 335 ↻ ← 54
				0 986 474 335 ↻ → 54
	1.9 dCi	11.02-10.05	68/88/96	0 204 004 342 ← 54
	1.9 DCI			0 986 473 334 ↻
				0 204 004 343 → 54
				0 986 474 334 ↻
		11.05-10.08	68/88/96	0 986 473 335 ↻ ← 54
				0 986 474 335 ↻ → 54
	2.0	11.02-10.05	99/110/120	0 204 004 342 ← 54
	2.0 dCi			0 986 473 334 ↻
	2.0 DCI			0 204 004 343 → 54
	2.0 T			0 986 474 334 ↻
	2.0 16V	11.05-10.08	99/110/120	0 986 473 335 ↻ ← 54
				0 986 474 335 ↻ → 54

	1.4 16V	11.02-10.08	72	0 986 473 280 ↻ ← 34
				0 986 474 280 ↻ → 34
	1.5 DCI	11.02-10.08	60/63/76/78	0 986 473 280 ↻ ← 34
				0 986 474 280 ↻ → 34
	1.6, 16V, 16V Flex-Fuel	11.02-10.08	77/83	0 986 473 280 ↻ ← 34
	1.6			0 986 474 280 ↻ → 34
	1.9 dCi	11.02-10.08	68/88/96	0 986 473 280 ↻ ← 34
	1.9 DCI			0 986 474 280 ↻ → 34
	2.0, dCi, DCI, T, 16V	11.02-10.08	99/110/120	0 986 473 280 ↻ ← 34
				0 986 474 280 ↻ → 34

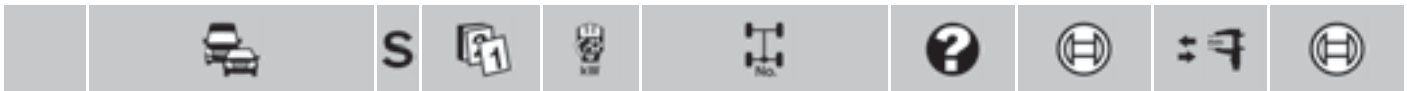

	2.0 16V Sport	03.03-02.06	165	0 986 473 226		37,93
				0 986 474 226		37,93
	03.06-10.08	165	0 986 473 412		38	
			0 986 474 412		38	



1.4 16V	11.02-10.08	72	1 987 477 786		2023
1.5 DCI	11.02-10.08	60/63/76/78	1 987 477 786		2023
1.6	05.05-10.08	77/83	1 987 477 786		2023
1.6 16V	11.02-10.08	77/83	1 987 477 786		2023
1.6 16V Flex-Fuel	01.07-10.08	77/83	1 987 477 786		2023
1.9 dCi	05.05-10.08	68/88/96	1 987 477 786		2023
1.9 DCI	11.02-10.08	68/88/96	1 987 477 786		2023
2.0	11.02-10.08	99/110/120/127/165	1 987 477 786		2023
2.0 dCi	09.04-10.08	99/110/120/127/165	1 987 477 786		2023
2.0 DCI	09.04-10.08	99/110/120/127/165	1 987 477 786		2023
2.0 DCI Sport	04.07-10.08	99/110/120/127/165	1 987 477 786		2023
2.0 T	05.04-10.08	99/110/120/127/165	1 987 477 786		2023
2.0 16V	11.02-10.08	99/110/120/127/165	1 987 477 786		2023
2.0 16V Sport	03.03-10.08	99/110/120/127/165	1 987 477 786		2023



1.4 16V	11.02-01.05	72	0 265 007 467 <sup>3</sup>		
	11.02-12.05	72	0 265 007 468 <sup>4</sup>		
1.5 DCI	11.02-01.05	60/63/76/78	0 265 007 467 <sup>3</sup>		
	11.02-12.05	60/63/76/78	0 265 007 468 <sup>4</sup>		
1.6, 16V	11.02-12.05	83	0 265 007 468 <sup>4</sup>		
1.6 16V	11.02-01.05	83	0 265 007 467 <sup>3</sup>		
1.9 DCI	11.02-01.05	68/88	0 265 007 467 <sup>3</sup>		
	11.02-12.05	68/88	0 265 007 468 <sup>4</sup>		
	09.04-01.05	96	0 265 007 467 <sup>3</sup>		
1.9 dCi, DCI	09.04-12.05	96	0 265 007 468 <sup>4</sup>		
2.0, dCi, DCI, T, 16V	11.02-01.05	99/110/120	0 265 007 467 <sup>3</sup>		
	11.02-12.05	99/110/120	0 265 007 468 <sup>4</sup>		
2.0 16V Sport	03.03-12.05	165	0 265 007 468 <sup>4</sup>		

Megane II [LM]



1.4	10.03-05.04	72	0 204 004 346		54
			0 204 004 347		54
1.5 dCi	11.05-10.09	72	0 986 473 335		54
			0 986 474 335		54
			0 204 004 342		54
			0 986 473 334		54
1.5 dCi	11.02-10.05	60/63/76/78	0 204 004 342		54
			0 986 473 334		54
			0 204 004 343		54
			0 986 474 334		54
1.5 dCi	11.05-10.09	60/63/76/78	0 986 473 335		54
			0 986 474 335		54
			0 204 004 342		54
			0 986 473 334		54
1.6	10.03-10.05	83	0 204 004 342		54
			0 986 473 334		54
			0 204 004 343		54
			0 986 474 334		54
1.6	11.05-10.09	83	0 986 473 335		54
			0 986 474 335		54
			0 204 004 342		54
			0 986 473 334		54
1.9 dCi	10.03-10.05	68/88/96	0 204 004 342		54
			0 986 473 334		54
			0 204 004 343		54
			0 986 474 334		54
1.9 dCi	11.05-10.09	68/88/96	0 986 473 335		54
			0 986 474 335		54





	◀RENAULT Megane II [LM]							
	2.0	09.02-10.05	99/110			0 204 004 342	← 54	
	2.0 dCi					0 986 473 334	↻	
						0 204 004 343	→ 54	
						0 986 474 334	↻	
		11.05-10.09	99/110			0 986 473 335	↻ ← 54	
						0 986 474 335	↻ → 54	



	1.4	10.03-10.09	72			0 986 473 280	↻ ← 34	
						0 986 474 280	↻ → 34	
	1.5 dCi	11.02-10.09	60/63/76/78			0 986 473 280	↻ ← 34	
						0 986 474 280	↻ → 34	
	1.6	10.03-10.09	83			0 986 473 280	↻ ← 34	
						0 986 474 280	↻ → 34	
	1.9 dCi	10.03-10.09	68/88/96			0 986 473 280	↻ ← 34	
						0 986 474 280	↻ → 34	
	2.0	09.02-10.09	99/110			0 986 473 280	↻ ← 34	
	2.0 dCi					0 986 474 280	↻ → 34	



	1.4	10.03-10.09	72			1 987 477 787	↔ 2080	
	1.5 dCi	11.02-10.09	60/63/76/78			1 987 477 787	↔ 2080	
	1.6	10.03-10.09	83			1 987 477 787	↔ 2080	
	1.9 dCi	10.03-10.09	68/88/96			1 987 477 787	↔ 2080	
	2.0	09.02-10.09	99/110			1 987 477 787	↔ 2080	
	2.0 dCi	09.04-10.09	99/110			1 987 477 787	↔ 2080	

	1.4	10.03-01.05	72			0 265 007 467 <sup>3</sup>		
		10.03-12.05	72			0 265 007 468 <sup>4</sup>		
	1.5 dCi	11.02-01.05	60/63/76/78			0 265 007 467 <sup>3</sup>		
		11.02-12.05	60/63/76/78			0 265 007 468 <sup>4</sup>		
	1.6	10.03-01.05	83			0 265 007 467 <sup>3</sup>		
		10.03-12.05	83			0 265 007 468 <sup>4</sup>		
	1.9 dCi	10.03-01.05	68/88/96			0 265 007 467 <sup>3</sup>		
		10.03-12.05	68/88/96			0 265 007 468 <sup>4</sup>		
	2.0	09.02-01.05	99/110			0 265 007 467 <sup>3</sup>		
	2.0 dCi	09.02-12.05	99/110			0 265 007 468 <sup>4</sup>		

**Megane III CC [EZ]**



	1.2	01.12→	85/97			0 265 008 173 <sup>4</sup>		
						0 265 008 941 <sup>3</sup>		
	1.4	10.10→	96			0 265 008 173 <sup>4</sup>		
						0 265 008 941 <sup>3</sup>		
	1.5 dCi	10.10→	81			0 265 008 173 <sup>4</sup>		
						0 265 008 941 <sup>3</sup>		
	1.6	10.10→	81/96			0 265 008 173 <sup>4</sup>		
	1.6 dCi					0 265 008 941 <sup>3</sup>		
	1.9 dCi	10.10→	96			0 265 008 173 <sup>4</sup>		
						0 265 008 941 <sup>3</sup>		
	2.0	10.10→	102-103/			0 265 008 173 <sup>4</sup>		
	2.0 dCi		118/132			0 265 008 941 <sup>3</sup>		
	2.0 TCe							

**Megane III Coupé [DZ]**



	1.2	01.12→	85/97			1 987 482 302	↔ 1883	
	1.4	01.09→	96			1 987 482 302	↔ 1883	
	1.5 dCi	01.09→	66/70/78/81			1 987 482 302	↔ 1883	
	1.6	01.09→	74/81			1 987 482 302	↔ 1883	

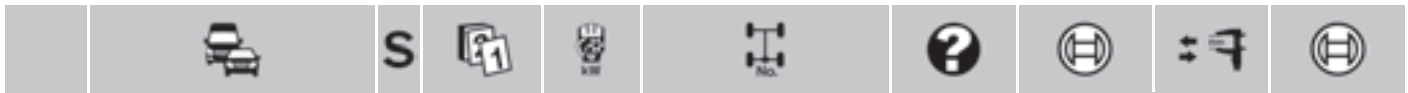

		S							
1.9 dCi	01.09→	96					1 987 482 302	↔ 1883	
2.0	01.09→	103/110/118/120/132/140/162/184/195					1 987 482 302	↔ 1883	
2.0 dCi	01.09→	103/110/118/120/132/140/162/184/195					1 987 482 302	↔ 1883	
2.0 R.S.	11.09→	103/110/118/120/132/140/162/184/195					1 987 482 302	↔ 1883	
2.0 TCe	01.09→	103/110/118/120/132/140/162/184/195					1 987 482 302	↔ 1883	
	1.2	01.12→	85/97				0 265 008 173 <sup>4</sup>		
							0 265 008 941 <sup>3</sup>		
	1.4	01.09→	96				0 265 008 173 <sup>4</sup>		
							0 265 008 941 <sup>3</sup>		
	1.5 dCi	01.09→	66/70/78/ 81				0 265 008 173 <sup>4</sup>		
							0 265 008 941 <sup>3</sup>		
	1.6	01.09→	74/81/96				0 265 008 173 <sup>4</sup>		
	1.6 dCi						0 265 008 941 <sup>3</sup>		
	1.9 dCi	01.09→	96				0 265 008 173 <sup>4</sup>		
							0 265 008 941 <sup>3</sup>		
	2.0, dCi, TCe	01.09→	103/110/118/120/132/140/162				0 265 008 173 <sup>4</sup>		
							0 265 008 941 <sup>3</sup>		
	2.0 R.S.	11.09→	184/195				0 265 008 173 <sup>4</sup>		
						LAB	0 265 008 939 <sup>3</sup>		
						RAB	0 265 008 940 <sup>3</sup>		

**Megane III Grandtour [KZ]**

	1.2	01.12→	85/97		FEB		1 987 482 325	↔ 1940	
	1.4	06.09→	96		FEB		1 987 482 325	↔ 1940	
	1.5 dCi	06.09→	66/70/78/81		FEB		1 987 482 325	↔ 1940	
	1.6	06.09→	74/79/81/96		FEB		1 987 482 325	↔ 1940	
	1.6 dCi	01.12→	74/79/81/96		FEB		1 987 482 325	↔ 1940	
	1.9 dCi	06.09→	96		FEB		1 987 482 325	↔ 1940	
	2.0	06.09→	103/110/118/120/132/140/162		FEB		1 987 482 325	↔ 1940	
	2.0 dCi	06.09→	103/110/118/120/132/140/162		FEB		1 987 482 325	↔ 1940	
	2.0 TCe	06.09→	103/110/118/120/132/140/162		FEB		1 987 482 325	↔ 1940	

	1.2	01.12→	85/97				0 265 008 173 <sup>4</sup>		
							0 265 008 941 <sup>3</sup>		
	1.4	06.09→	96				0 265 008 173 <sup>4</sup>		
							0 265 008 941 <sup>3</sup>		
	1.5 dCi	06.09→	66/70/78/ 81				0 265 008 173 <sup>4</sup>		
							0 265 008 941 <sup>3</sup>		
	1.6	06.09→	74/79/81/				0 265 008 173 <sup>4</sup>		
	1.6 dCi		96				0 265 008 941 <sup>3</sup>		
	1.9 dCi	06.09→	96				0 265 008 173 <sup>4</sup>		
							0 265 008 941 <sup>3</sup>		
	2.0, dCi, TCe	06.09→	103/110/118/120/132/140/162				0 265 008 173 <sup>4</sup>		
							0 265 008 941 <sup>3</sup>		

**Megane III Hatchback [BZ]**

	1.2	01.12→	85/97				1 987 482 302	↔ 1883	
	1.4	11.08→	96				1 987 482 302	↔ 1883	
	1.5 dCi	11.08→	66/70/78/81				1 987 482 302	↔ 1883	
	1.6	11.08→	74/79/81/96				1 987 482 302	↔ 1883	
	1.6 dCi	01.12→	74/79/81/96				1 987 482 302	↔ 1883	
	1.9 dCi	11.08→	96				1 987 482 302	↔ 1883	
	2.0	11.08→	103/110/118/120/132/140/162				1 987 482 302	↔ 1883	
	2.0 dCi	11.08→	103/110/118/120/132/140/162				1 987 482 302	↔ 1883	
	2.0 TCe	11.08→	103/110/118/120/132/140/162				1 987 482 302	↔ 1883	



		S				?			
<b>◀RENAULT Megane III Hatchback [BZ]</b>									
	1.2	01.12→	85/97				0 265 008 173 <sup>4</sup>		
							0 265 008 941 <sup>3</sup>		
	1.4	11.08→	96				0 265 008 173 <sup>4</sup>		
							0 265 008 941 <sup>3</sup>		
	1.5 dCi	11.08→	66/70/78/ 81				0 265 008 173 <sup>4</sup>		
							0 265 008 941 <sup>3</sup>		
	1.6	11.08→	74/79/				0 265 008 173 <sup>4</sup>		
	1.6 dCi		81-85/96				0 265 008 941 <sup>3</sup>		
1.9 dCi	11.08→	96				0 265 008 173 <sup>4</sup>			
							0 265 008 941 <sup>3</sup>		
2.0	11.08→	103/110/118/120/132/140/162				0 265 008 173 <sup>4</sup>			
2.0 dCi,TCe							0 265 008 941 <sup>3</sup>		
<b>Megane [L/BA00]</b>									
	1.6 i 16V GNC	06.03→	69				F 026 002 182	↔ 17,46	
							0 986 475 797	↔ 20,6	
<b>MeganeIII Hatchback [BZ]</b>									
	1.5 dCi	09.13→	81				1 987 482 302	↔ 1883	
	1.5 dCi	09.13→	81				0 265 008 173 <sup>4</sup>		
							0 265 008 941 <sup>3</sup>		
<b>Modus [FP/JP]</b>									
	1.2	09.04→	55/57,5/				0 986 134 329	↔ 54	
	1.2 TCe		74				0 986 135 329	↔ 54	
	1.4	06.04-12.06	72				0 986 134 329	↔ 54	
							0 986 135 329	↔ 54	
	1.5 dCi	09.04→	50/55/63/ 65/78				0 986 134 329	↔ 54	
							0 986 135 329	↔ 54	
	1.6	09.04→	65/82/83				0 986 134 329	↔ 54	
							0 986 135 329	↔ 54	
	1.2, TCe	09.04→	55/57,5/74				0 986 475 934	↔ 19,05	
	1.4	06.04-12.06	72				0 986 475 934	↔ 19,05	
	1.5 dCi	09.04→	50/55/63/65/78				0 986 475 934	↔ 19,05	
	1.6	09.04→	82/83				0 986 475 934	↔ 19,05	
	1.2	09.04→	55/57,5/				0 986 134 011	↔ 34	
	1.2 TCe		74				0 986 135 011	↔ 34	
	1.4	06.04-12.06	72				0 986 134 011	↔ 34	
							0 986 135 011	↔ 34	
	1.5 dCi	09.04→	50/55/63/ 65/78				0 986 134 011	↔ 34	
							0 986 135 011	↔ 34	
	1.6	09.04→	65/82/83				0 986 134 011	↔ 34	
							0 986 135 011	↔ 34	
	1.2	09.04→	55/57,5/			FKR,HTB	1 987 477 939	→ 1497	
	1.2 TCe		74				1 987 477 940	← 1387	
						FLR,HTB	1 987 482 383	← 1440	
							1 987 482 384	→ 1572	

R

		S							
1.2 1.2 TCe	09.04→	55/57,5/ 74		4SB,FKR	1 987 477 938	← 1276			
					1 987 477 967	→ 1375			
					4SB,FLR	1 987 482 385	← 1322		
1.4	06.04-12.06	72		FKR,HTB	1 987 477 939	→ 1497			
					1 987 477 940	← 1387			
				FLR,HTB	1 987 482 383	← 1440			
					1 987 482 384	→ 1572			
				4SB,FKR	1 987 477 938	← 1276			
					1 987 477 967	→ 1375			
				4SB,FLR	1 987 482 385	← 1322			
1.5 dCi	09.04→	50/55/63/ 65/78		FKR,HTB	1 987 477 939	→ 1497			
					1 987 477 940	← 1387			
				FLR,HTB	1 987 482 383	← 1440			
					1 987 482 384	→ 1572			
				4SB,FKR	1 987 477 938	← 1276			
					1 987 477 967	→ 1375			
				4SB,FLR	1 987 482 385	← 1322			
1.6	09.04→	65/82/83		FKR,HTB	1 987 477 939	→ 1497			
					1 987 477 940	← 1387			
				FLR,HTB	1 987 482 383	← 1440			
					1 987 482 384	→ 1572			
				4SB,FKR	1 987 477 938	← 1276			
					1 987 477 967	→ 1375			
				4SB,FLR	1 987 482 385	← 1322			
1.2 1.2 TCe	09.04→	55/57,5/74			0 265 008 922 <sup>3</sup>				
	MFD 09.04→	55/57,5/74			0 265 008 923 <sup>4</sup>				
1.4	06.04-12.06	72		LAB	0 265 007 606 <sup>4</sup>				
					RAB	0 265 008 925 <sup>4</sup>			
1.5 dCi	09.04-12.06	65		LAB,TKO	0 265 007 606 <sup>4</sup>				
					RAB,TKO	0 265 008 925 <sup>4</sup>			
				TKO	0 265 008 923 <sup>4</sup>				
					0 265 008 922 <sup>3</sup>				
				09.04→	50/55/63	0 265 008 922 <sup>3</sup>			
					78	0 265 008 922 <sup>3</sup>			
				MFD 09.04→	50/55/63	0 265 008 923 <sup>4</sup>			
78	0 265 008 923 <sup>4</sup>								
OFD 09.04→	50/55/63	0 265 007 606 <sup>4</sup>							
	78	0 265 007 606 <sup>4</sup>							
1.6	09.04-12.06	65		LAB	0 265 007 606 <sup>4</sup>				
					RAB	0 265 008 925 <sup>4</sup>			
					0 265 008 922 <sup>3</sup>				
					0 265 007 606 <sup>4</sup>				
					0 265 008 925 <sup>4</sup>				
					0 265 008 923 <sup>4</sup>				
					0 265 008 922 <sup>3</sup>				
					0 265 007 606 <sup>4</sup>				
					0 265 008 925 <sup>4</sup>				
					0 265 008 923 <sup>4</sup>				
					0 265 007 606 <sup>4</sup>				
					0 265 008 925 <sup>4</sup>				
					0 265 008 923 <sup>4</sup>				
					0 265 007 606 <sup>4</sup>				
					0 265 008 925 <sup>4</sup>				
					0 265 008 923 <sup>4</sup>				
					0 265 007 606 <sup>4</sup>				
					0 265 008 925 <sup>4</sup>				







◀ RENAULT

**Safrane [B54]**



	2.0 i	04.92-09.96	77/97-99		GIR	0986 473 786		← 54	
						0986 473 787		→ 54	
	2.0 i 16V	10.96-01.98	100			0986 473 786		← 54	
			02.98-12.00	100			0986 473 787		→ 54
							0986 134 315		← 54
						0986 135 315		→ 54	
	2.1 D Turbo	04.92-09.96	65-66		GIR	0986 473 786		← 54	
							0986 473 787		→ 54
	2.2 i	04.92-09.96	79-81		GIR	0986 473 786		← 54	
								0986 473 787	
			101-104		GIR	0986 473 786		← 54	
							0986 473 787		→ 54
	2.2 12VD Turbo	10.96-12.00	83		GIR	0986 473 788		← 60	
								0986 473 789	
	2.5 D Turbo	04.92-05.94	83-85		GS GIR	0986 473 786		← 54	
							0986 473 787		→ 54
			07.93-09.96	83-85		AG GIR	0986 473 788		← 60
							0986 473 789		→ 60
		06.94-09.96	83-85		GS GIR	0986 473 788		← 60	
						0986 473 789		→ 60	
	2.5 i 20V	10.96-12.00	121		GIR	0986 473 788		← 60	
									0986 473 789
	3.0 i	04.92-12.00	123-125/		GIR	0986 473 788		← 60	
				140				0986 473 789	



	2.0 i	ABO	04.92-02.95	77		0986 475 677		↔ 22,2	
	2.1 D Turbo	ABO	04.92-02.95	65-66		0986 475 677		↔ 22,2	
	2.2 i	ABO	04.92-02.95	79-81		0986 475 677		↔ 22,2	

	2.0 i	04.92-09.96	77		BES	0986 473 279		← 36					
						0986 474 279		→					
	2.0 i	04.92-12.00	97-99/100			0986 473 279		← 36					
	2.0 i 16V					0986 474 279		→					
	2.1 D Turbo	04.92-09.96	65-66		BES	0986 473 279		← 36					
										0986 474 279		→	
	2.2 i	04.92-09.96	79-81		BES	0986 473 279		← 36					
										0986 474 279		→	
	2.2 i	04.92-12.00	83/101-104			0986 473 279		← 36					
										0986 474 279		→	
	2.2 12VD Turbo					0986 473 279		← 36					
										0986 474 279		→	
	2.5 D Turbo	04.92-12.00	83-85/121			0986 473 279		← 36					
	2.5 i 20V					0986 474 279		→					
	3.0 i	04.92-09.96	123-125		AA BSY	0204 102 261		← 36	0 204 100 062 <sup>8</sup>				
										0204 102 262		→ 36	0 204 100 062 <sup>8</sup>
										0986 473 279		← 36	
						0986 474 279		→					
	3.0 i Biturbo	02.93-09.96	190-197		AA BSY	0204 102 261		← 36	0 204 100 062 <sup>8</sup>				
										0204 102 262		→ 36	0 204 100 062 <sup>8</sup>
	3.0 i 24V	03.99-12.00	140			0986 473 279		← 36					
										0986 474 279		→	



	2.0 i	04.92-12.00	77/97-99/			1987 477 648		← 850				
			100				1987 477 649		→ 1091			
			2.1 D Turbo	04.92-09.96	65-66				1987 477 648		← 850	
										1987 477 649		→ 1091
			2.2 i	04.92-12.00	79-81/83/				1987 477 648		← 850	
2.2 12VD Turbo		101-104				1987 477 649		→ 1091				

		S							
2.5 D Turbo		04.92-12.00	83-85/121				1 987 477 648	← 850	
2.5 i 20V							1 987 477 649	→ 1091	
3.0i		04.92-09.96	123-125		AA		1 987 477 648	← 850	
							1 987 477 649	→ 1091	
		08.92-12.00	123-125				1 987 477 648	← 850	
							1 987 477 649	→ 1091	
3.0i 24V		03.99-12.00	140				1 987 477 648	← 850	
							1 987 477 649	→ 1091	
2.0i		04.92-12.00	77/97-99/				0 265 006 363 <sup>4</sup>		
2.0i 16V			100		LAB		0 265 006 361 <sup>3</sup>		
					RAB		0 265 006 362 <sup>3</sup>		
2.1 D Turbo		04.92-09.96	65-66				0 265 006 363 <sup>4</sup>		
					LAB		0 265 006 361 <sup>3</sup>		
					RAB		0 265 006 362 <sup>3</sup>		
2.2i		04.92-12.00	79-81/83/				0 265 006 363 <sup>4</sup>		
2.2 12V D Turbo			101-104		LAB		0 265 006 361 <sup>3</sup>		
					RAB		0 265 006 362 <sup>3</sup>		
2.5 D Turbo		04.92-12.00	83-85/121				0 265 006 363 <sup>4</sup>		
2.5 i 20V					LAB		0 265 006 361 <sup>3</sup>		
					RAB		0 265 006 362 <sup>3</sup>		
3.0i		04.92-12.00	123-125/				0 265 006 363 <sup>4</sup>		
3.0i Biturbo			140/		LAB		0 265 006 361 <sup>3</sup>		
3.0i 24V			190-197		RAB		0 265 006 362 <sup>3</sup>		
<b>Sandero [BS]</b>									
1.2		09.11→	55		B59		0 986 473 677	↔ 48	
							0 986 474 677	↔ 48	
					238,B25		0 986 473 671	↔ 48	
							0 986 474 671	↔ 48	
1.4		12.09→	55		B59		0 986 473 677	↔ 48	
							0 986 474 677	↔ 48	
					238,B25		0 986 473 671	↔ 48	
							0 986 474 671	↔ 48	
1.6		12.09→	62/64/77		B59		0 986 473 677	↔ 48	
1.6 16V							0 986 474 677	↔ 48	
					238,B25		0 986 473 671	↔ 48	
							0 986 474 671	↔ 48	
1.2		09.11→	55				F 026 002 480	↔ 19,05	
					BSY		F 026 002 249	↔ 17,5	
					TRW		0 986 475 837	↔ 17,46	
1.4		12.09→	55				F 026 002 480	↔ 19,05	
					BSY		F 026 002 249	↔ 17,5	
					TRW		0 986 475 837	↔ 17,46	
1.6		12.09→	62/64				F 026 002 480	↔ 19,05	
					BSY		F 026 002 249	↔ 17,5	
					TRW		0 986 475 837	↔ 17,46	
1.6 16V		11.10→	77				F 026 002 249	↔ 17,5	
1.2		09.11→	55				1 987 482 234	↔ 1658	
1.4		12.09→	55				1 987 482 234	↔ 1658	
1.6		12.09→	62/64/77				1 987 482 234	↔ 1658	
1.6 16V		11.10→	62/64/77				1 987 482 234	↔ 1658	
1.2		09.11→	55				0 265 008 922 <sup>3</sup>		
					LAB		0 265 008 946 <sup>4</sup>		
					RAB		0 265 008 947 <sup>4</sup>		



		S							
	◀RENAULT Sandero [BS]								
1.4		12.09→	55				0 265 007 742 <sup>3</sup>		
						LAB	0 265 008 297 <sup>4</sup>		
						RAB	0 265 008 297 <sup>4</sup>		
1.6		12.09→	62/64/77				0 265 007 742 <sup>3</sup>		
1.6 16V						LAB	0 265 008 297 <sup>4</sup>		
						RAB	0 265 008 297 <sup>4</sup>		
<b>Scenic</b>									
	2.0 i 16V	05.99-10.03	102				0 986 AB8 461	↔	
<b>Scenic [Fase I]</b>									
	1.6 i 16V	08.99-05.01	79				0 986 AB8 461	↔	
		06.01-07.10	81				0 986 475 797	↔ 20,6	
		ABO 06.01-07.10	81				0 986 AB8 461	↔	
		06.01-07.10	81				0 986 475 797	↔ 20,6	
	2.0 i, i 16V	01.99-07.10	85/103				0 986 AB8 461	↔	
	1.6 i 16V	06.01-07.10	81				0 986 594 030 <sup>3</sup>		
	2.0 i, i 16V	01.99-07.10	85/103				0 986 594 030 <sup>3</sup>		
<b>Scenic I [JA]</b>									
	1.4 i	11.96-09.98	55				0 986 473 677	↔ ← 48	
							0 986 474 677	↔ → 48	
		08.98-04.03	70				0 986 134 315	↔ ← 54	
							0 986 135 315	↔ → 54	
		10.98-04.03	55				0 986 134 315	↔ ← 54	
							0 986 135 315	↔ → 54	
	1.6 i	01.96-09.98	66				0 986 473 677	↔ ← 48	
							0 986 473 786	↔ ← 54	
							0 986 473 787	↔ → 54	
							0 986 474 677	↔ → 48	
		11.96-09.98	55				0 986 473 677	↔ ← 48	
							0 986 474 677	↔ → 48	
		08.98-09.98	79				0 986 473 786	↔ ← 54	
							0 986 473 787	↔ → 54	
		10.98-04.03	55				0 986 134 315	↔ ← 54	
							0 986 135 315	↔ → 54	
			66				0 986 134 315	↔ ← 54	
							0 986 135 315	↔ → 54	
			79				0 986 134 315	↔ ← 54	
							0 986 135 315	↔ → 54	
	1.8 i	09.00-04.03	85/88				0 986 134 315	↔ ← 54	
							0 986 135 315	↔ → 54	
	1.9 D	11.96-09.98	47-48				0 986 473 786	↔ ← 54	
							0 986 473 787	↔ → 54	
		10.98-04.03	47-48				0 986 134 315	↔ ← 54	
							0 986 135 315	↔ → 54	
		03.99-04.03	47				0 986 134 315	↔ ← 54	
							0 986 135 315	↔ → 54	
	1.9 D Turbo	11.96-04.03	66-69				0 986 473 786	↔ ← 54	
							0 986 473 787	↔ → 54	
	1.9 DCI	06.97-04.03	75				0 986 134 315	↔ ← 54	
							0 986 135 315	↔ → 54	



	S								
<b>1.9 DCI RX4</b>	06.97-03.02	75				0 986 134 315		54	
						0 986 135 315		54	
	04.02-04.03	75				0 986 473 341		57	
						0 986 474 341		57	
<b>1.9 DTI</b>	06.97-09.98	72				0 986 473 786		54	
						0 986 473 787		54	
	10.98-04.03	72				0 986 134 315		54	
						0 986 135 315		54	
	11.00-04.03	59				0 986 134 315		54	
					0 986 135 315		54		
<b>2.0 i</b>	11.96-03.97	83-84				0 986 473 786		54	
						0 986 473 787		54	
	11.96-09.98	84				0 986 473 786		54	
						0 986 473 787		54	
	10.98-04.03	84				0 986 134 315		54	
						0 986 135 315		54	
	03.99-04.03	101,5				0 986 134 315		54	
					0 986 135 315		54		
06.00-04.03	102				0 986 134 315		54		
					0 986 135 315		54		
<b>2.0 i RX4</b>	06.99-03.02	101,5				0 986 134 315		54	
						0 986 135 315		54	
	02.01-03.02	102				0 986 134 315		54	
						0 986 135 315		54	
	04.02-04.03	101,5				0 986 473 341		57	
					0 986 473 341		57		
		102			0 986 473 341		57		
					0 986 474 341		57		
	<b>1.4 i</b>	11.96-04.03	55			0 986 475 797		20,6	
		08.98-09.99	70			0 986 475 797		20,6	
	<b>1.6 i</b>	01.96-04.03	55/66			0 986 475 797		20,6	
		08.98-04.03	79			0 986 475 797		20,6	
	<b>1.9 D</b>	11.96-09.99	47-48			0 986 475 797		20,6	
	<b>1.9 D Turbo, DTI</b>	11.96-04.03	66-69/72			0 986 475 797		20,6	
<b>2.0 i</b>	11.96-04.03	83-84			0 986 475 797		20,6		
	<b>1.4 i</b>	08.98-04.03	70			0 986 473 471		33,9	
						0 986 474 471		33,9	
	<b>1.6 i</b>	08.98-04.03	79			0 986 473 471		33,9	
						0 986 474 471		33,9	
	<b>1.8 i</b>	09.00-04.03	85/88				0 986 473 471		33,9
							0 986 474 471		33,9
	<b>1.9 D</b>	10.99-04.03	47-48/59			0 986 473 471		33,9	
	<b>1.9 DTI</b>					0 986 474 471		33,9	
	<b>1.9 DCI</b>	06.97-04.03	72/75				0 986 473 471		33,9
							0 986 474 471		33,9
	<b>2.0 i</b>	03.99-04.03	101,5/102				0 986 473 471		33,9
							0 986 474 471		33,9
	<b>1.4 i</b>	11.96-04.03	55			1 987 477 639		1476	
		08.98-09.99	70			1 987 477 639		1476	
		10.99-04.03	70			1 987 477 647		1479	
						1 987 477 890		1508	
	<b>1.6 i</b>	01.96-04.03	55/66			1 987 477 639		1476	
		08.98-09.99	79			1 987 477 639		1476	
		10.99-04.03	79			1 987 477 647		1479	
						1 987 477 890		1508	
	<b>1.8 i</b>	09.00-04.03	85/88				1 987 477 647		1479
							1 987 477 890		1508





◀ RENAULT Scenic I [JA]				
1.9 D	11.96-09.99	47-48	1987 477 639	↔ 1476
	10.99-04.03	47-48	1987 477 647	→ 1479
			1987 477 890	← 1508
1.9 D Turbo	11.96-04.03	66-69/72	1987 477 639	↔ 1476
1.9 DCI	06.97-04.03	75	1987 477 647	→ 1479
			1987 477 890	← 1508
1.9 DCI RX4	06.97-04.03	75	1987 477 937	↔ 1467
1.9 DTI	06.97-04.03	66-69/72	1987 477 639	↔ 1476
	11.00-04.03	59	1987 477 647	→ 1479
			1987 477 890	← 1508
2.0 i	11.96-04.03	83-84	1987 477 639	↔ 1476
	03.99-04.03	101,5/102	1987 477 647	→ 1479
			1987 477 890	← 1508
2.0 i RX4	06.99-04.03	101,5/102	1987 477 937	↔ 1467
1.4 i	11.96-04.03	55/70	0986 594 030 <sup>3</sup>	
1.6 i	01.96-04.03	66	0986 594 030 <sup>3</sup>	
	11.96-04.03	55	0986 594 030 <sup>3</sup>	
	08.98-04.03	79	0986 594 030 <sup>3</sup>	
1.8 i	09.00-04.03	85/88	0986 594 030 <sup>3</sup>	
1.9 D, DTI	07.98-04.03	47-48/59/72	0986 594 030 <sup>3</sup>	
1.9 DCI, DCI RX4	06.97-04.03	75	0986 594 030 <sup>3</sup>	
2.0 i, i RX4	07.98-04.03	84/101,5/102	0986 594 030 <sup>3</sup>	

**Scenic II [JM]**

1.4 16V	05.03-10.05	72	0 204 004 342	← 54
			0986 473 334	↻
			0 204 004 343	→ 54
			0986 474 334	↻
	11.05-04.09	72	0986 473 335	↻ ← 54
			0986 474 335	↻ → 54
1.5 dCi	05.03-10.05	60-63/ 74-78	0 204 004 342	← 54
			0986 473 334	↻
			0 204 004 343	→ 54
			0986 474 334	↻
	11.05-04.09	60-63/ 74-78	0986 473 335	↻ ← 54
			0986 474 335	↻ → 54
1.6 16V	05.03-10.05	83	0 204 004 342	← 54
			0986 473 334	↻
			0 204 004 343	→ 54
			0986 474 334	↻
	11.05-04.09	83	0986 473 335	↻ ← 54
			0986 474 335	↻ → 54
1.9 dCi	05.03-10.05	81/88/96	0 204 004 342	← 54
			0986 473 334	↻
			0 204 004 343	→ 54
			0986 474 334	↻
	11.05-04.09	81/88/96	0986 134 282	↻ ← 54
			0986 135 282	↻ → 54
2.0 dCi	05.03-10.05	99/110/ 120	0 204 004 342	← 54
2.0 16V			0986 473 334	↻
2.0 16V Turbo			0 204 004 343	→ 54
			0986 474 334	↻
	11.05-04.09	99/110/ 120	0986 134 282	↻ ← 54
			0986 135 282	↻ → 54

1.4 16V	05.03-04.09	72	0986 134 044	↻ ← 34
			0986 135 044	↻ → 34

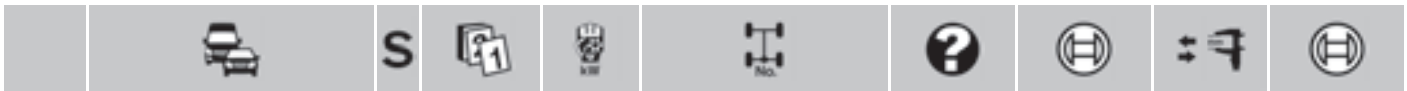

1.4 16V	05.03-04.09	72	FEB	0 986 473 280	↔ 34
				0 986 474 280	↔ 34
1.5 dCi	05.03-04.09	60-63/ 74-78	FEB	0 986 134 044	↔ 34
				0 986 135 044	↔ 34
			FEB	0 986 473 280	↔ 34
				0 986 474 280	↔ 34
1.6 16V	05.03-04.09	83	FEB	0 986 134 044	↔ 34
				0 986 135 044	↔ 34
			FEB	0 986 473 280	↔ 34
				0 986 474 280	↔ 34
1.9 dCi	05.03-04.09	81/88/96	FEB	0 986 134 044	↔ 34
				0 986 135 044	↔ 34
			FEB	0 986 473 280	↔ 34
				0 986 474 280	↔ 34
2.0 dCi	05.03-04.09	99/110/	FEB	0 986 134 044	↔ 34
2.0 16V		120		0 986 135 044	↔ 34
2.0 16V Turbo			FEB	0 986 473 280	↔ 34
				0 986 474 280	↔ 34



1.4 16V	05.03-04.09	72	FEB	1 987 477 787	↔ 2080
1.5 dCi	05.03-04.09	60-63/74-78	FEB	1 987 477 787	↔ 2080
1.6 16V	05.03-04.09	83	FEB	1 987 477 787	↔ 2080
1.9 dCi	05.03-04.09	81/88/96	FEB	1 987 477 787	↔ 2080
2.0 dCi	09.04-04.09	99/110/120	FEB	1 987 477 787	↔ 2080
2.0 16V	05.03-04.09	99/110/120	FEB	1 987 477 787	↔ 2080
2.0 16V Turbo	06.03-04.09	99/110/120	FEB	1 987 477 787	↔ 2080

1.4 16V	05.03-01.05	72		0 265 007 467 <sup>3</sup>	
1.5 dCi	05.03-01.05	60-63/74-78		0 265 007 467 <sup>3</sup>	
1.6 16V	05.03-01.05	83		0 265 007 467 <sup>3</sup>	
1.9 dCi	05.03-01.05	88/96		0 265 007 467 <sup>3</sup>	
2.0 dCi, 16V, 16V Turbo	05.03-01.05	99/110/120		0 265 007 467 <sup>3</sup>	

**Scenic III [JZ]**



1.2	05.12→	85/97		1 987 482 433	↔ 1897
1.4	05.09→	96		1 987 482 433	↔ 1897
1.5 dCi	05.09→	63/70/77/81		1 987 482 433	↔ 1897
1.6	05.09→	79/81/96		1 987 482 433	↔ 1897
1.6 dCi	03.11→	79/81/96		1 987 482 433	↔ 1897
1.9 dCi	05.09→	96		1 987 482 433	↔ 1897
2.0	05.09→	103/110/118		1 987 482 433	↔ 1897
2.0 dCi	05.09→	103/110/118		1 987 482 433	↔ 1897

1.2	05.12→	85/97		0 265 008 173 <sup>4</sup>	
				0 265 008 941 <sup>3</sup>	
1.4	05.09→	96		0 265 008 173 <sup>4</sup>	
				0 265 008 941 <sup>3</sup>	
1.5 dCi	05.09→	63/70/77/ 81		0 265 008 173 <sup>4</sup>	
				0 265 008 941 <sup>3</sup>	
1.6	05.09→	79/81/96		0 265 008 173 <sup>4</sup>	
1.6 dCi				0 265 008 941 <sup>3</sup>	
1.9 dCi	05.09→	96		0 265 008 173 <sup>4</sup>	
				0 265 008 941 <sup>3</sup>	
2.0	05.09→	103/110/		0 265 008 173 <sup>4</sup>	
2.0 dCi		118		0 265 008 941 <sup>3</sup>	



		S							
◀ RENAULT									
<b>Sport Spider</b>									
	2.0		05.96-10.99	108-110			0 204 102 284	→ 57	0 204 104 0567
<b>Symbol [L8]</b>									
	0.9		03.13→	66			F 026 002 249	↔ 17,5	
	1.2		03.13→	53/55			F 026 002 249	↔ 17,5	
	1.5 dCi		03.13→	55/66			F 026 002 249	↔ 17,5	
	0.9		03.13→	66			1 987 477 955	↔ 1680	
	1.2		03.13→	53/55			1 987 477 955	↔ 1680	
	1.5 dCi		03.13→	55/66			1 987 477 955	↔ 1680	
<b>Thalia [LB]</b>									
	1.0 i 16V		06.01-11.04	50			0 986 473 677	← 48	
							0 986 474 677	→ 48	
	1.2 i	ABS	06.01-10.07	43			0 986 473 677	← 48	
							0 986 474 677	→ 48	
	1.2 i	ABO	06.01-10.07	43/55			0 986 473 671	← 48	
	1.2 i 16V						0 986 474 671	→ 48	
	1.2 i 16V		09.01-10.07	55			0 986 473 677	← 48	
							0 986 474 677	→ 48	
		ABS	04.04-10.07	55			0 986 473 677	← 48	
							0 986 474 677	→ 48	
	1.4 i	ABO	10.99-10.07	55			0 986 473 671	← 48	
							0 986 474 671	→ 48	
		ABS	10.99-10.07	55			0 986 473 677	← 48	
							0 986 474 677	→ 48	
	1.4 i 16V		06.01-10.07	70-72			0 986 473 677	← 48	
							0 986 474 677	→ 48	
	1.5 dCi		06.01-10.07	48/50/59/ 60			0 986 473 677	← 48	
							0 986 474 677	→ 48	
	1.6 i		10.99-10.07	66/81			0 986 473 677	← 48	
							0 986 474 677	→ 48	
	1.9 D		10.99-10.07	47-48			0 986 473 677	← 48	
							0 986 474 677	→ 48	
	1.0 i 16V	ABO	06.01-11.04	50			F 026 002 480	↔ 19,05	
		ABS	06.01-11.04	50		BSY	F 026 002 249	↔ 17,5	
						GIR	0 986 475 837	↔ 17,46	
	1.2 i	ABO	06.01-10.07	43/55			F 026 002 480	↔ 19,05	
	1.2 i 16V	ABS	06.01-10.07	43/55		BSY	F 026 002 249	↔ 17,5	
						GIR	0 986 475 837	↔ 17,46	
	1.4 i	ABO	10.99-10.07	55/70-72			F 026 002 480	↔ 19,05	
	1.4 i 16V	ABS	10.99-10.07	55/70-72		BSY	F 026 002 249	↔ 17,5	
						GIR	0 986 475 837	↔ 17,46	
	1.5 dCi		06.01-10.07	59		BSY	F 026 002 480	↔ 19,05	
						GIR	0 986 475 837	↔ 17,46	
		ABO	09.01-10.07	48/50/60			F 026 002 480	↔ 19,05	
		ABS	09.01-10.07	48/50/60		BSY	F 026 002 249	↔ 17,5	
						GIR	0 986 475 837	↔ 17,46	
	1.6 i	ABO	10.99-10.07	66/81			F 026 002 480	↔ 19,05	



		S								
1.6i		ABS	10.99-10.07	66/81			BSY GIR	F 026 <b>002 249</b> 0 986 <b>475 837</b>	↔ 17,5 ↔ 17,46	
1.9D		ABO	10.99-10.07	47-48				F 026 <b>002 480</b>	↔ 19,05	
		ABS	10.99-10.07	47-48			BSY GIR	F 026 <b>002 249</b> 0 986 <b>475 837</b>	↔ 17,5 ↔ 17,46	
1.5 dCi			10.05-10.07	50				0 204 <b>102 182</b> 0 986 <b>134 316</b> 0 204 <b>102 184</b> 0 204 <b>103 184</b> 0 986 <b>135 316</b>	← 48 → 48	0 204 <b>100 062<sup>B</sup></b> 0 204 <b>104 068<sup>9</sup></b> 0 204 <b>100 062<sup>B</sup></b>
1.0i 16V			06.01-08.03	50				1 987 <b>477 782</b> 1 987 <b>477 783</b>	→ 1415 ← 1335	
1.2i		ABO	06.01-10.07	43				1 987 <b>477 784</b> 1 987 <b>477 785</b>	→ 1402 ← 1321	
		ABS	06.01-10.07	43				1 987 <b>477 782</b> 1 987 <b>477 783</b>	→ 1415 ← 1335	
1.2i 16V			04.04-10.07	55				1 987 <b>477 782</b> 1 987 <b>477 783</b>	→ 1415 ← 1335	
		ABS	09.01-10.07	55				1 987 <b>477 782</b> 1 987 <b>477 783</b>	→ 1415 ← 1335	
1.4i		ABS	10.99-10.07	55				1 987 <b>477 782</b> 1 987 <b>477 783</b>	→ 1415 ← 1335	
1.4i 16V			06.01-10.07	70-72				1 987 <b>477 782</b> 1 987 <b>477 783</b>	→ 1415 ← 1335	
1.5 dCi			09.01-10.07	48/50/60				1 987 <b>477 782</b> 1 987 <b>477 783</b>	→ 1415 ← 1335	
1.6i			10.99-10.07	66				1 987 <b>477 782</b> 1 987 <b>477 783</b>	→ 1415 ← 1335	
			06.01-08.03	81				1 987 <b>477 782</b> 1 987 <b>477 783</b>	→ 1415 ← 1335	
1.9D			10.99-10.07	47-48				1 987 <b>477 782</b> 1 987 <b>477 783</b>	→ 1415 ← 1335	
1.0i 16V			06.01-11.02	50				0 265 <b>006 383<sup>3</sup></b>		
			06.01-11.04	50		LAB RAB		0 265 <b>006 384<sup>4</sup></b> 0 265 <b>006 385<sup>4</sup></b>		
			12.02-11.04	50				0 265 <b>007 527<sup>3</sup></b>		
1.2i			06.01-11.02	43				0 265 <b>006 383<sup>3</sup></b>		
			06.01-10.07	43		LAB RAB		0 265 <b>006 384<sup>4</sup></b> 0 265 <b>006 385<sup>4</sup></b>		
			12.02-10.07	43				0 265 <b>007 527<sup>3</sup></b>		
1.2i 16V			09.01-11.02	55				0 265 <b>006 383<sup>3</sup></b>		
						LAB,FKØ RAB,FKØ		0 265 <b>006 384<sup>4</sup></b> 0 265 <b>006 385<sup>4</sup></b>		
			09.01-03.04	55		LAB RAB		0 265 <b>006 384<sup>4</sup></b> 0 265 <b>006 385<sup>4</sup></b>		
			12.02-10.07	55				0 265 <b>007 527<sup>3</sup></b>		
						LAB,FKØ RAB,FKØ		0 265 <b>007 529<sup>4</sup></b> 0 265 <b>008 944<sup>4</sup></b>		
1.4i			10.99-11.02	55/70-72				0 265 <b>006 383<sup>3</sup></b>		
1.4i 16V			10.99-10.07	55/70-72		LAB RAB		0 265 <b>006 384<sup>4</sup></b> 0 265 <b>006 385<sup>4</sup></b>		
			12.02-10.07	55/70-72				0 265 <b>007 527<sup>3</sup></b>		
1.5 dCi			06.01-10.07	59				0 265 <b>006 383<sup>3</sup></b>		
			09.01-11.02	48				0 265 <b>006 383<sup>3</sup></b>		
			09.01-10.07	48		LAB RAB		0 265 <b>006 384<sup>4</sup></b> 0 265 <b>006 385<sup>4</sup></b>		
			12.02-10.07	48				0 265 <b>007 527<sup>3</sup></b>		
			05.04-10.07	60				0 265 <b>007 527<sup>3</sup></b>		







	◀RENAULT Thalia [LB]							
	1.5 dCi	10.05-10.07	50				0 265 007 527 <sup>3</sup>	
					LAB,TKO		0 265 007 529 <sup>4</sup>	
					RAB,TKO		0 265 008 944 <sup>4</sup>	
	1.6 i	10.99-11.02	66				0 265 006 383 <sup>3</sup>	
		10.99-10.07	66		LAB		0 265 006 384 <sup>4</sup>	
					RAB		0 265 006 385 <sup>4</sup>	
		06.01-11.02	81				0 265 006 383 <sup>3</sup>	
		06.01-10.07	81		LAB		0 265 006 384 <sup>4</sup>	
					RAB		0 265 006 385 <sup>4</sup>	
		12.02-10.07	66				0 265 007 527 <sup>3</sup>	
			81				0 265 007 527 <sup>3</sup>	
		01.04-10.07	66		LAB,TKO		0 265 007 529 <sup>4</sup>	
					RAB,TKO		0 265 008 944 <sup>4</sup>	
	1.9 D	10.99-11.02	47-48				0 265 006 383 <sup>3</sup>	
		10.99-10.07	47-48		LAB		0 265 006 384 <sup>4</sup>	
					RAB		0 265 006 385 <sup>4</sup>	
		12.02-10.07	47-48				0 265 007 527 <sup>3</sup>	

**Thalia [LU]**

	1.2	10.08→	55				0 986 473 671	← 48
							0 986 474 671	→ 48
	1.4	10.08→	72				0 986 473 677	← 48
							0 986 474 677	→ 48
	1.5 dCi	10.08→	47/62				0 986 473 677	← 48
							0 986 474 677	→ 48
	1.6	10.08→	77				0 986 473 677	← 48
							0 986 474 677	→ 48

	1.2	10.08→	55		BSY	F 026 002 480		↔ 19,05
					GIR	0 986 475 837		↔ 17,46
	1.4	10.08-05.09	72		BSY	F 026 002 480		↔ 19,05
		10.08→	72		GIR	0 986 475 837		↔ 17,46
		06.09→	72		BSY	F 026 002 249		↔ 17,5
	1.5 dCi	10.08-05.09	47/62		BSY	F 026 002 480		↔ 19,05
		10.08→	47/62		GIR	0 986 475 837		↔ 17,46
		06.09→	47/62		BSY	F 026 002 249		↔ 17,5
	1.6	10.08-05.09	77		BSY	F 026 002 480		↔ 19,05
		10.08→	77		GIR	0 986 475 837		↔ 17,46
		06.09→	77		BSY	F 026 002 249		↔ 17,5

	1.2	10.08→	55				0 265 008 945 <sup>3</sup>	
					LAB		0 265 007 529 <sup>4</sup>	
					RAB		0 265 008 944 <sup>4</sup>	
	1.4	10.08→	72				0 265 008 945 <sup>3</sup>	
					LAB		0 265 007 529 <sup>4</sup>	
					RAB		0 265 008 944 <sup>4</sup>	
	1.5 dCi	10.08→	47/62				0 265 008 945 <sup>3</sup>	
					LAB		0 265 007 529 <sup>4</sup>	
					RAB		0 265 008 944 <sup>4</sup>	
	1.6	10.08→	77				0 265 008 945 <sup>3</sup>	
					LAB		0 265 007 529 <sup>4</sup>	
					RAB		0 265 008 944 <sup>4</sup>	



**Traffic**



	<b>1.4</b>	09.80-10.97	36	EIZ	0 204 <b>102 087</b>	← 54	0 204 <b>104 030</b> <sup>7</sup>
					0 204 <b>103 087</b>		
					0 204 <b>102 089</b>	→ 54	0 204 <b>104 030</b> <sup>7</sup>
					0 204 <b>103 089</b>		
		10.84-10.97	36	ZWZ	0 204 <b>102 052</b>	← 45	0 204 <b>104 042</b> <sup>7</sup>
					0 204 <b>103 052</b>		
					0 204 <b>102 054</b>	→ 45	0 204 <b>104 042</b> <sup>7</sup>
					0 204 <b>103 054</b>		
	<b>1.7</b>	10.84-10.97	50/58	EIZ	0 204 <b>102 087</b>	← 54	0 204 <b>104 030</b> <sup>7</sup>
					0 204 <b>103 087</b>		
					0 204 <b>102 089</b>	→ 54	0 204 <b>104 030</b> <sup>7</sup>
					0 204 <b>103 089</b>		
				ZWZ	0 204 <b>102 052</b>	← 45	0 204 <b>104 042</b> <sup>7</sup>
					0 204 <b>103 052</b>		
					0 204 <b>102 054</b>	→ 45	0 204 <b>104 042</b> <sup>7</sup>
					0 204 <b>103 054</b>		
	<b>1.9D</b>	11.97-05.01	47-48		0 204 <b>102 052</b>	← 45	0 204 <b>104 042</b> <sup>7</sup>
					0 204 <b>103 052</b>		
					0 204 <b>102 054</b>	→ 45	0 204 <b>104 042</b> <sup>7</sup>
					0 204 <b>103 054</b>		
	<b>2.0</b>	09.80-10.97	59	EIZ	0 204 <b>102 087</b>	← 54	0 204 <b>104 030</b> <sup>7</sup>
					0 204 <b>103 087</b>		
					0 204 <b>102 089</b>	→ 54	0 204 <b>104 030</b> <sup>7</sup>
					0 204 <b>103 089</b>		
		10.84-10.97	59	ZWZ	0 204 <b>102 052</b>	← 45	0 204 <b>104 042</b> <sup>7</sup>
					0 204 <b>103 052</b>		
					0 204 <b>102 054</b>	→ 45	0 204 <b>104 042</b> <sup>7</sup>
					0 204 <b>103 054</b>		
	<b>2.1D</b>	09.80-10.97	43-44/47	EIZ	0 204 <b>102 087</b>	← 54	0 204 <b>104 030</b> <sup>7</sup>
					0 204 <b>103 087</b>		
					0 204 <b>102 089</b>	→ 54	0 204 <b>104 030</b> <sup>7</sup>
					0 204 <b>103 089</b>		
		10.84-10.97	43-44/47	ZWZ	0 204 <b>102 052</b>	← 45	0 204 <b>104 042</b> <sup>7</sup>
					0 204 <b>103 052</b>		
					0 204 <b>102 054</b>	→ 45	0 204 <b>104 042</b> <sup>7</sup>
					0 204 <b>103 054</b>		
	<b>2.2i</b>	03.89-10.97	69-71/74	EIZ	0 204 <b>102 087</b>	← 54	0 204 <b>104 030</b> <sup>7</sup>
					0 204 <b>103 087</b>		
					0 204 <b>102 089</b>	→ 54	0 204 <b>104 030</b> <sup>7</sup>
					0 204 <b>103 089</b>		
				ZWZ	0 204 <b>102 052</b>	← 45	0 204 <b>104 042</b> <sup>7</sup>
					0 204 <b>103 052</b>		
					0 204 <b>102 054</b>	→ 45	0 204 <b>104 042</b> <sup>7</sup>
					0 204 <b>103 054</b>		
	<b>2.5D</b>	03.89-10.97	55	EIZ	0 204 <b>102 087</b>	← 54	0 204 <b>104 030</b> <sup>7</sup>
					0 204 <b>103 087</b>		
					0 204 <b>102 089</b>	→ 54	0 204 <b>104 030</b> <sup>7</sup>
					0 204 <b>103 089</b>		
				ZWZ	0 204 <b>102 052</b>	← 45	0 204 <b>104 042</b> <sup>7</sup>
					0 204 <b>103 052</b>		
					0 204 <b>102 054</b>	→ 45	0 204 <b>104 042</b> <sup>7</sup>
					0 204 <b>103 054</b>		
		11.97-05.01	55		0 204 <b>102 052</b>	← 45	0 204 <b>104 042</b> <sup>7</sup>
					0 204 <b>103 052</b>		
					0 204 <b>102 054</b>	→ 45	0 204 <b>104 042</b> <sup>7</sup>
					0 204 <b>103 054</b>		



		S							
◀ RENAULT Traffic									
2.5 D 4x4		11.97-05.01	55				0 204 102 052	← 45	0 204 104 0427
							0 204 103 052		
							0 204 102 054	→ 45	0 204 104 0427
							0 204 103 054		
	1.4	09.80-10.97	36			BSY	F 026 002 163	↔ 22	
							F 026 002 164	↔ 23,8	
					254	GIR	0 986 475 051	↔ 25,4	
	1.7	10.84-10.97	58			254	GIR	0 986 475 051	↔ 25,4
		03.89-10.97	50			BSY	F 026 002 163	↔ 22	
							F 026 002 164	↔ 23,8	
					254	GIR	0 986 475 051	↔ 25,4	
	1.9 D	02.88-11.03	45				F 026 002 164	↔ 23,8	
		ABO 11.97-05.01	47-48				F 026 002 164	↔ 23,8	
		ABS 11.97-05.01	47-48			254		0 986 475 051	↔ 25,4
	2.0	09.80-10.97	59			BSY	F 026 002 163	↔ 22	
							F 026 002 164	↔ 23,8	
					254	GIR	0 986 475 051	↔ 25,4	
		06.99-12.02	81				F 026 002 164	↔ 23,8	
	2.1 D	09.80-10.97	43-44			BSY	F 026 002 163	↔ 22	
							F 026 002 164	↔ 23,8	
					254	GIR	0 986 475 051	↔ 25,4	
		07.86-10.99	44				F 026 002 164	↔ 23,8	
		09.94-10.97	47			BSY	F 026 002 163	↔ 22	
							F 026 002 164	↔ 23,8	
					254	GIR	0 986 475 051	↔ 25,4	
	2.2	01.95-05.99	59				F 026 002 164	↔ 23,8	
	2.2 i	03.89-10.97	69-71/74			BSY	F 026 002 163	↔ 22	
							F 026 002 164	↔ 23,8	
					254	GIR	0 986 475 051	↔ 25,4	
	2.5 D	03.89-10.97	55			BSY	F 026 002 163	↔ 22	
							F 026 002 164	↔ 23,8	
					254	GIR	0 986 475 051	↔ 25,4	
		11.97-05.01	55			254	0 986 475 051	↔ 25,4	
	2.5 D 4x4	11.97-05.01	55			254	0 986 475 051	↔ 25,4	
	1.4	09.80-10.97	36				1 987 477 662	747	
							1 987 477 663	← 1330	
							1 987 477 665	→ 1424	
	1.7	03.89-10.97	50				1 987 477 662	747	
							1 987 477 663	← 1330	
							1 987 477 664	← 1295	
							1 987 477 665	→ 1424	
							1 987 477 666	→ 1390	
			58				1 987 477 664	← 1295	
							1 987 477 666	→ 1390	
	1.9 D	11.97-05.01	47-48				1 987 477 662	747	
							1 987 477 663	← 1330	
							1 987 477 665	→ 1424	
	2.0	09.80-10.97	59				1 987 477 662	747	
							1 987 477 663	← 1330	
							1 987 477 665	→ 1424	
		03.89-10.97	59				1 987 477 664	← 1295	
							1 987 477 666	→ 1390	
	2.1 D	09.80-10.97	43-44				1 987 477 662	747	
							1 987 477 663	← 1330	
							1 987 477 665	→ 1424	
		03.89-10.97	43-44				1 987 477 664	← 1295	
							1 987 477 666	→ 1390	

	S							
2.1D	09.94-10.97	47				1 987 477 662	747	
						1 987 477 663	← 1330	
						1 987 477 665	→ 1424	
2.2i	03.89-10.97	69-71/74	Fg.-Nr. T...			1 987 477 662	747	
						1 987 477 663	← 1330	
						1 987 477 665	→ 1424	
			Fg.-Nr. V...			1 987 477 664	← 1295	
						1 987 477 666	→ 1390	
2.5D	03.89-10.97	55	Fg.-Nr. T...			1 987 477 662	747	
						1 987 477 663	← 1330	
						1 987 477 665	→ 1424	
			Fg.-Nr. V...			1 987 477 664	← 1295	
						1 987 477 666	→ 1390	
	11.97-05.01	55				1 987 477 662	747	
						1 987 477 663	← 1330	
						1 987 477 664	← 1295	
						1 987 477 665	→ 1424	
						1 987 477 666	→ 1390	
2.5D 4x4	11.97-05.01	55				1 987 477 664	← 1295	
						1 987 477 666	→ 1390	
1.4	09.80-10.97	36		LAB		0 265 006 154 <sup>4</sup>		
				RAB		0 265 006 156 <sup>3</sup>		
						0 265 006 155 <sup>4</sup>		
						0 265 006 157 <sup>3</sup>		
1.7	03.89-10.97	50		LAB		0 265 006 154 <sup>4</sup>		
				RAB		0 265 006 156 <sup>3</sup>		
						0 265 006 155 <sup>4</sup>		
						0 265 006 157 <sup>3</sup>		
1.9D	11.97-05.01	47-48		LAB		0 265 006 154 <sup>4</sup>		
				RAB		0 265 006 156 <sup>3</sup>		
						0 265 006 155 <sup>4</sup>		
						0 265 006 157 <sup>3</sup>		
2.0	09.80-10.97	59		LAB		0 265 006 154 <sup>4</sup>		
				RAB		0 265 006 156 <sup>3</sup>		
						0 265 006 155 <sup>4</sup>		
						0 265 006 157 <sup>3</sup>		
2.1D	09.80-10.97	43-44/47		LAB		0 265 006 154 <sup>4</sup>		
				RAB		0 265 006 156 <sup>3</sup>		
						0 265 006 155 <sup>4</sup>		
						0 265 006 157 <sup>3</sup>		
2.2i	03.89-10.97	69-71/74		LAB		0 265 006 154 <sup>4</sup>		
				RAB		0 265 006 156 <sup>3</sup>		
						0 265 006 155 <sup>4</sup>		
						0 265 006 157 <sup>3</sup>		
2.5D	03.89-05.01	55		LAB		0 265 006 154 <sup>4</sup>		
2.5D 4x4				RAB		0 265 006 156 <sup>3</sup>		
						0 265 006 155 <sup>4</sup>		
						0 265 006 157 <sup>3</sup>		
<b>Traffic II [EL/FL/JL]</b>								
1.9 dCi	05.01-11.01	60/74				0 986 473 480	← 41	
						0 986 474 480	→ 41	
2.0	06.01-11.01	88				0 986 473 480	← 41	
						0 986 474 480	→ 41	
1.9 dCi	05.01-12.06	60/74				1 987 477 116	→ 1603	
						1 987 477 137	← 1503	
				FKR,MI		1 987 482 043	1190	



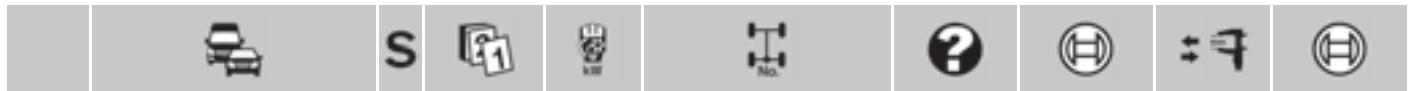

◀ RENAULT Traffic II [EL/FL/JL]									
1.9 dCi	05.01-12.06	60/74	FLR,MI,TW	1987 <b>482 145</b>	1585				
				LLE	1987 <b>482 042</b>	508			
				RLE	1987 <b>482 146</b>	600			
		06.01-12.06	60/74	MI,TW	1987 <b>482 145</b>	1585			
	2.0	06.01-12.06	88		1987 <b>477 116</b>	→ 1603			
					1987 <b>477 137</b>	← 1503			
					FKR,MI	1987 <b>482 043</b>	1190		
					FLR,MI,TW	1987 <b>482 145</b>	1585		
					LLE	1987 <b>482 042</b>	508		
					MI,TW	1987 <b>482 145</b>	1585		
				RLE	1987 <b>482 146</b>	600			
		01.06→	66/84/85/		1987 <b>477 116</b>	→ 1603			
2.0 dCi			86		1987 <b>477 137</b>	← 1503			
				FKR,MI	1987 <b>482 043</b>	1190			
			FLR,MI,TW	1987 <b>482 145</b>	1585				
			LLE	1987 <b>482 042</b>	508				
			RLE	1987 <b>482 146</b>	600				
2.5 dCi	06.02-12.06	98		1987 <b>477 116</b>	→ 1603				
				1987 <b>477 137</b>	← 1503				
				FKR,MI	1987 <b>482 043</b>	1190			
				FLR,MI,TW	1987 <b>482 145</b>	1585			
				LLE	1987 <b>482 042</b>	508			
				MI,TW	1987 <b>482 145</b>	1585			
				RLE	1987 <b>482 146</b>	600			
		01.06→	107		1987 <b>477 116</b>	→ 1603			
					1987 <b>477 137</b>	← 1503			
				FKR,MI	1987 <b>482 043</b>	1190			
			FLR,MI,TW	1987 <b>482 145</b>	1585				
			LLE	1987 <b>482 042</b>	508				
			RLE	1987 <b>482 146</b>	600				



1.9 dCi	11.01-12.06	60/74		0 265 <b>008 077</b> <sup>3</sup>			
				0 265 <b>008 078</b> <sup>4</sup>			
	2.0	11.01-12.06	88		0 265 <b>008 077</b> <sup>3</sup>		
					0 265 <b>008 078</b> <sup>4</sup>		
	2.0	01.06→	66/84/85/	BO	0 265 <b>008 041</b> <sup>3</sup>		
					0 265 <b>008 916</b> <sup>4</sup>		
	2.0 dCi		86	TRW	0 265 <b>008 077</b> <sup>3</sup>		
					0 265 <b>008 078</b> <sup>4</sup>		
	2.5 dCi	06.02-12.06	98		0 265 <b>008 077</b> <sup>3</sup>		
					0 265 <b>008 078</b> <sup>4</sup>		
01.06→		107	BO	0 265 <b>008 041</b> <sup>3</sup>			
				0 265 <b>008 916</b> <sup>4</sup>			
			TRW	0 265 <b>008 077</b> <sup>3</sup>			
				0 265 <b>008 078</b> <sup>4</sup>			

**Twingo I [C0./S0.]**

1.0 i	01.00-05.07	43/50		0 986 <b>473 671</b>	← 48		
				0 986 <b>474 671</b>	→ 48		
	1.0 i 16V	03.93-08.97	40		0 204 <b>102 285</b>	← 45	0 204 <b>100 083</b> <sup>8</sup>
					0 204 <b>103 285</b>		0 204 <b>104 044</b> <sup>7</sup>
					0 204 <b>102 286</b>	→ 45	0 204 <b>100 083</b> <sup>8</sup>
					0 204 <b>103 286</b>		
	1.2 i	01.96-09.98	43		0 204 <b>102 285</b>	← 45	0 204 <b>100 083</b> <sup>8</sup>
					0 204 <b>103 285</b>		0 204 <b>104 044</b> <sup>7</sup>
		09.96-09.98	40-44		0 204 <b>102 286</b>	→ 45	0 204 <b>100 083</b> <sup>8</sup>
					0 204 <b>103 286</b>		
				0 204 <b>102 285</b>	← 45	0 204 <b>100 083</b> <sup>8</sup>	
				0 204 <b>103 285</b>		0 204 <b>104 044</b> <sup>7</sup>	
				0 204 <b>102 286</b>	→ 45	0 204 <b>100 083</b> <sup>8</sup>	
				0 204 <b>103 286</b>			

		S																	
1.2i		05.98-05.07	43				0 986 473 671		← 48										
							0 986 474 671		→ 48										
							10.98-05.07	40-44	0 986 473 671		← 48								
									0 986 474 671		→ 48								
							02.01-10.03	43	0 986 473 677		← 48								
									0 986 474 677		→ 48								
1.2i 16V		09.00-10.03	55				0 986 473 677		← 48										
							0 986 474 677		→ 48										
									FEN	0 986 473 677		← 48							
										0 986 474 677		→ 48							
									FEV	0 986 473 671		← 48							
										0 986 474 671		→ 48							
		10.03-05.07	55				0 986 473 671		← 48										
							0 986 474 671		→ 48										
<hr/>																			
1.0i		01.00-05.07	43				F 026 002 238		← 20,6										
							F 026 002 239		→ 20,6										
							1.0i 16V	03.01-05.07	50				F 026 002 180		↔ 20,6				
							1.2i	02.01-05.07	43				0 986 475 837		↔ 17,46				
								ABO	03.93-08.97	40			KL	F 026 002 180		↔ 20,6			
													KL	F 026 002 238		← 20,6			
														F 026 002 239		→ 20,6			
									01.96-05.07	43				F 026 002 238		← 20,6			
														F 026 002 239		→ 20,6			
									09.96-05.07	40-44				F 026 002 238		← 20,6			
														F 026 002 239		→ 20,6			
									05.98-05.07	43				KL	F 026 002 180		↔ 20,6		
														KL	F 026 002 238		← 20,6		
															F 026 002 239		→ 20,6		
									ABS	03.93-08.97	40				F 026 002 180		↔ 20,6		
										01.96-06.98	43	Fg.-Nr. →F333238			F 026 002 180		↔ 20,6		
										09.96-06.98	40-44	Fg.-Nr. →F333238			F 026 002 180		↔ 20,6		
										05.98-05.07	43				0 986 475 837		↔ 17,46		
										07.98-05.07	40-44	Fg.-Nr. F333239→			0 986 475 837		↔ 17,46		
							1.2i 16V		09.00-05.07	55					0 986 475 837		↔ 17,46		
														FEN	0 986 475 837		↔ 17,46		
														FEV	F 026 002 180		↔ 20,6		
							<hr/>												
1.0i		01.00-05.07	43/50						1 987 477 643		↔ 1442								
									ABS	01.00-05.07	43/50					1 987 477 646		↔ 1460	
									1.0i 16V	03.01-05.07	43/50					1 987 477 643		↔ 1442	
										ABS	03.01-05.07	43/50					1 987 477 646		↔ 1460
									1.2i	03.93-05.07	40-44/55					1 987 477 643		↔ 1442	
										ABS	03.93-05.07	40-44/55					1 987 477 646		↔ 1460
									1.2i 16V	09.00-05.07	40-44/55					1 987 477 643		↔ 1442	
										ABS	09.00-05.07	40-44/55					1 987 477 646		↔ 1460
									<hr/>										
									1.2i		03.93-08.97	40						0 986 594 031	
09.96-02.01	40-44				0 986 594 031 <sup>3</sup>														
12.02-05.07	40-44			LAB	0 265 007 583 <sup>4</sup>														
				RAB	0 265 007 582 <sup>4</sup>														
1.2i	01.96-02.01	43/55				0 986 594 031 <sup>3</sup>													
1.2i 16V	12.02-05.07	43/55				0 265 007 527 <sup>3</sup>													
						LAB	0 265 007 583 <sup>4</sup>												
							RAB	0 265 007 582 <sup>4</sup>											



		S				?			
◀ RENAULT									
<b>Twingo II [CN/GN]</b>									
	1.2	04.07→	43/56/				0986 473 677		← 48
	1.2 TCe, 16V		74-75				0986 474 677		→ 48
	1.5 dCi	04.07→	47/55/62/63				0986 473 677		← 48
							0986 474 677		→ 48
	1.2, TCe, 16V	04.07-09.12	43/56/74-75				0986 475 969		↔ 17,46
	1.5 dCi	04.07-09.12	47/55/62/63				0986 475 969		↔ 17,46
	1.6 R.S.	07.07→	98				0986 473 280		← 34
							0986 474 280		→ 34
	1.2, TCe, 16V	04.07→	43/56/74-75				1987 482 308		← 1273
							1987 482 309		→ 1355
	1.5 dCi	04.07→	47/55/62/63				1987 482 308		← 1273
							1987 482 309		→ 1355
	1.2	04.07→	43/56/				0265 007 890 <sup>3</sup>		
	1.2 TCe		74-75			LAB	0265 007 891 <sup>4</sup>		
	1.2 16V					RAB	0265 007 892 <sup>4</sup>		
	1.5 dCi	04.07→	47/55/62/63				0265 007 890 <sup>3</sup>		
						LAB	0265 007 891 <sup>4</sup>		
						RAB	0265 007 892 <sup>4</sup>		
1.6 R.S.	07.07→	98					0265 007 890 <sup>3</sup>		
						LAB	0265 008 145 <sup>4</sup>		
						RAB	0265 008 146 <sup>4</sup>		
<b>Vel Satis [BJ]</b>									
	2.0, DCI, T	04.02-12.09	110/120/125/127				0986 134 328		← 60
							0986 135 328		→ 60
	2.2 DCI	04.02-12.09	102/110				0986 134 328		← 60
							0986 135 328		→ 60
	3.0 DCI V6	04.02-12.09	130/133				0986 134 328		← 60
							0986 135 328		→ 60
3.5 V6	04.02-12.09	177				0986 134 328		← 60	
							0986 135 328		→ 60
	2.0, DCI, T	04.02-12.09	110/120/125/127				0986 473 226		← 37,93
							0986 474 226		→ 37,93
	2.2 DCI	04.02-12.09	102/110				0986 473 226		← 37,93
							0986 474 226		→ 37,93
	3.0 DCI V6	04.02-12.09	130/133				0986 473 226		← 37,93
							0986 474 226		→ 37,93
3.5 V6	04.02-12.09	177				0986 473 226		← 37,93	
							0986 474 226		→ 37,93
<b>Wind [E4]</b>									
	1.2	04.10→	74-75				0986 473 280		← 34
							0986 474 280		→ 34
	1.6	04.10→	98				0986 473 280		← 34
							0986 474 280		→ 34



		S								
<hr/>										
	1.2	04.10→	74-75					0 265 007 890 <sup>3</sup>		
								LAB 0 265 008 145 <sup>4</sup>		
								RAB 0 265 008 146 <sup>4</sup>		
	1.6	04.10→	98					0 265 007 890 <sup>3</sup>		
								LAB 0 265 008 145 <sup>4</sup>		
								RAB 0 265 008 146 <sup>4</sup>		
<b>Zoe [BF]</b>										
<hr/>										
		01.13→	65					0 986 134 329	← 54	
								0 986 135 329	→ 54	
		01.13→	65					F 026 002 573	↔ 22,2	
<b>5</b>										
<hr/>										
	1.0	10.84-12.96	30			BSY		0 204 102 083	← 45	0 204 100 083 <sup>B</sup>
								0 204 103 083		0 204 104 044 <sup>7</sup>
								0 204 102 085	→ 45	0 204 100 083 <sup>B</sup>
								0 204 103 085		
	1.1	10.84-12.96	33			BSY		0 204 102 083	← 45	0 204 100 083 <sup>B</sup>
								0 204 103 083		0 204 104 044 <sup>7</sup>
								0 204 102 085	→ 45	0 204 100 083 <sup>B</sup>
								0 204 103 085		
	1.2	10.84-12.96	40			GIR		0 986 473 671	← 48	
								0 986 474 671	→ 48	
						ETG	BSY	0 204 102 249	← 48	0 204 100 062 <sup>B</sup>
								0 986 473 101		0 204 104 052 <sup>7</sup>
								0 204 102 250	→ 48	0 204 100 062 <sup>B</sup>
								0 986 474 101		
						ZTG	BSY	0 204 102 065	← 48	0 204 100 062 <sup>B</sup>
								0 204 103 065		0 204 104 033 <sup>7</sup>
								0 204 102 067	→ 48	0 204 100 062 <sup>B</sup>
								0 204 103 067		
	1.4	10.84-12.96	43			GIR		0 986 473 671	← 48	
								0 986 474 671	→ 48	
						ETG	BSY	0 204 102 249	← 48	0 204 100 062 <sup>B</sup>
								0 986 473 101		0 204 104 052 <sup>7</sup>
								0 204 102 250	→ 48	0 204 100 062 <sup>B</sup>
								0 986 474 101		
						ZTG	BSY	0 204 102 065	← 48	0 204 100 062 <sup>B</sup>
								0 204 103 065		0 204 104 033 <sup>7</sup>
								0 204 102 067	→ 48	0 204 100 062 <sup>B</sup>
								0 204 103 067		
			49			GIR		0 986 473 671	← 48	
								0 986 474 671	→ 48	
						ETG	BSY	0 204 102 249	← 48	0 204 100 062 <sup>B</sup>
								0 986 473 101		0 204 104 052 <sup>7</sup>
								0 204 102 250	→ 48	0 204 100 062 <sup>B</sup>
								0 986 474 101		
						ZTG	BSY	0 204 102 065	← 48	0 204 100 062 <sup>B</sup>
								0 204 103 065		0 204 104 033 <sup>7</sup>
								0 204 102 067	→ 48	0 204 100 062 <sup>B</sup>
								0 204 103 067		
		06.87-12.96	50			GIR		0 986 473 671	← 48	
								0 986 474 671	→ 48	





		S								
	◀ RENAULT 5									
1.4	06.87-12.96	50	ETG	BSY	0 204 102 249	← 48	0 204 100 062 <sup>8</sup>			
					0 986 473 101		0 204 104 052 <sup>7</sup>			
					0 204 102 250	→ 48	0 204 100 062 <sup>8</sup>			
					0 986 474 101					
					ZTG	BSY	0 204 102 065	← 48	0 204 100 062 <sup>8</sup>	
					0 204 103 065		0 204 104 033 <sup>7</sup>			
	11.88-12.96	44	ETG	BSY	0 204 102 249	← 48	0 204 104 052 <sup>7</sup>			
					0 986 473 101		0 204 104 052 <sup>7</sup>			
					0 204 102 250	→ 48	0 204 100 062 <sup>8</sup>			
					0 986 474 101					
					49	ETG	BSY	0 204 102 249	← 48	0 204 100 127 <sup>8</sup>
								0 986 473 101		
0 204 102 250	→ 48	0 204 104 052 <sup>7</sup>								
1.4	10.85-12.96	44	GIR	0 986 473 671	← 48					
				0 986 474 671	→ 48					
1.4 i	11.88-12.96	44	ETG	BSY	0 204 102 249	← 48	0 204 100 127 <sup>8</sup>			
					0 986 473 101					
1.4 i	11.88-12.96	44	ETG	BSY	0 204 102 249	← 48	0 204 104 052 <sup>7</sup>			
					0 986 473 101					
					0 204 102 250	→ 48	0 204 100 127 <sup>8</sup>			
1.4 Turbo	10.84-12.96	77/88	GIR	0 986 473 677	← 48					
				0 986 474 677	→ 48					
1.6 D	10.87-12.96	40	GIR	0 986 473 671	← 48					
				0 986 474 671	→ 48					
				ETG	BSY	0 204 102 249	← 48	0 204 100 062 <sup>8</sup>		
						0 986 473 101		0 204 104 052 <sup>7</sup>		
						0 204 102 250	→ 48	0 204 100 062 <sup>8</sup>		
				0 986 474 101		ZTG	BSY	0 204 102 065	← 48	0 204 100 062 <sup>8</sup>
	0 204 103 065		0 204 104 033 <sup>7</sup>							
	0 204 102 067	→ 48	0 204 100 062 <sup>8</sup>							
	0 204 103 067									
	1.7	10.86-12.96	66/69	GIR	0 986 473 677	← 48				
					0 986 474 677	→ 48				
	1.7 i	10.86-12.96	55	GIR	0 986 473 671	← 48				
0 986 474 671					→ 48					
11.88-12.96					55	ETG	BSY	0 204 102 249	← 48	0 204 100 127 <sup>8</sup>
	0 986 473 101		0 204 104 052 <sup>7</sup>							
0 204 102 250	→ 48	0 204 100 127 <sup>8</sup>								
0 986 474 101										
	1.0	06.87-12.96	30	BSY	F 026 002 176	← 22,2				
					F 026 002 177	→ 22,2				
					F 026 002 236	→ 20,64				
					F 026 002 237	← 20,64				
					02.88-12.96	30	GIR	0 986 475 643	▲ ← 20,6	
								0 986 475 644	▲ → 20,6	
	1.1	06.87-12.96	33	BSY	F 026 002 176	← 22,2				
					F 026 002 177	→ 22,2				
					F 026 002 236	→ 20,64				
					F 026 002 237	← 20,64				
					02.88-12.96	33	GIR	0 986 475 643	▲ ← 20,6	
								0 986 475 644	▲ → 20,6	
1.2	06.87-12.96	40	BSY	F 026 002 176	← 22,2					
				F 026 002 177	→ 22,2					
				F 026 002 236	→ 20,64					
				F 026 002 237	← 20,64					



		S								
1.2		02.88-12.96	40					GIR	0 986 475 643 ▲ ← 20,6	
									0 986 475 644 ▲ → 20,6	
1.4		06.87-12.96	43					BSY	F 026 002 176 ← 22,2	
									F 026 002 177 → 22,2	
									F 026 002 236 → 20,64	
									F 026 002 237 ← 20,64	
			49/50					BSY	F 026 002 176 ← 22,2	
									F 026 002 177 → 22,2	
									F 026 002 236 → 20,64	
									F 026 002 237 ← 20,64	
		02.88-12.96	49/50					GIR	0 986 475 643 ▲ ← 20,6	
									0 986 475 644 ▲ → 20,6	
1.4		06.87-12.96	44					BSY	F 026 002 236 → 20,64	
1.4i		02.88-12.96	44					GIR	0 986 475 643 ▲ ← 20,6	
									0 986 475 644 ▲ → 20,6	
1.4i		06.87-12.96	44					BSY	F 026 002 176 ← 22,2	
									F 026 002 177 → 22,2	
1.6D		10.87-12.96	40					BSY	F 026 002 176 ← 22,2	
									F 026 002 177 → 22,2	
									F 026 002 236 → 20,64	
									F 026 002 237 ← 20,64	
		02.88-12.96	40					GIR	0 986 475 643 ▲ ← 20,6	
									0 986 475 644 ▲ → 20,6	
1.7		06.87-12.96	55/66					BSY	F 026 002 236 → 20,64	
1.7i		02.88-12.96	55/66					GIR	F 026 002 237 ← 20,64	
									0 986 475 643 ▲ ← 20,6	
									0 986 475 644 ▲ → 20,6	
1.4 Turbo		10.84-12.96	77/88					BSY	0 204 102 075 ← 30	0 204 100 062 <sup>B</sup>
									0 986 134 098 ⚙	0 204 104 068 <sup>9</sup>
									0 204 102 077 → 30	0 204 100 062 <sup>B</sup>
									0 204 103 077 ⚙	
									0 986 135 098 ⚙	
1.7i		10.86-12.96	69					BSY	0 204 102 075 ← 30	0 204 100 062 <sup>B</sup>
									0 986 134 098 ⚙	0 204 104 068 <sup>9</sup>
									0 204 102 077 → 30	0 204 100 062 <sup>B</sup>
									0 204 103 077 ⚙	
									0 986 135 098 ⚙	
1.0		10.84-12.96	30						1 987 477 156 ↔ 1330	
1.1		10.84-12.96	33						1 987 477 156 ↔ 1330	
1.2		10.84-12.96	40						1 987 477 156 ↔ 1330	
1.4		10.84-12.96	43/44/49/50						1 987 477 156 ↔ 1330	
1.4i		10.85-12.96	43/44/49/50						1 987 477 156 ↔ 1330	
1.6D		10.87-12.96	40						1 987 477 156 ↔ 1330	
1.7		06.87-12.96	55/66						1 987 477 156 ↔ 1330	
1.7i		10.86-12.96	55/66						1 987 477 156 ↔ 1330	
<b>9 [L42]</b>										
1.4		01.85-12.95	50-53					GIR	0 986 473 671 ⚙ ← 48	
									0 986 474 671 ⚙ → 48	
						ZTG	BSY	0 204 102 065 ← 48	0 204 104 033 <sup>7</sup>	
									0 204 103 065 ⚙	
									0 204 102 067 → 48	0 204 104 033 <sup>7</sup>
									0 204 103 067 ⚙	
			53							F 02D 030 031
								GIR	0 986 473 671 ⚙ ← 48	
									0 986 474 671 ⚙ → 48	



		S							
<b>RENAULT 9 [L42]</b>									
	1.4	01.85-12.95	53		ZTG	BSY	0 204 102 065	← 48	0 204 104 033 <sup>7</sup>
							0 204 103 065		
							0 204 102 067	→ 48	0 204 104 033 <sup>7</sup>
							0 204 103 067		
		04.91-12.95	44/49-50						F 02D 030 031
						GIR	0 986 473 671	← 48	
							0 986 474 671	→ 48	
					ZTG	BSY	0 204 102 065	← 48	0 204 104 033 <sup>7</sup>
							0 204 103 065		
							0 204 102 067	→ 48	0 204 104 033 <sup>7</sup>
							0 204 103 067		
	1.4	01.85-12.95	44/49-53				F 026 002 176	← 22,2	
							F 026 002 177	→ 22,2	
	1.4	01.85-12.95	44/49-53				1987 477 280	↔ 1487	
<b>11 [B37]</b>									
	1.4	01.85-03.95	49-53			GIR	0 986 473 671	← 48	
							0 986 474 671	→ 48	
					ZTG	BSY	0 204 102 065	← 48	0 204 104 033 <sup>7</sup>
							0 204 103 065		
							0 204 102 067	→ 48	0 204 104 033 <sup>7</sup>
							0 204 103 067		
	1.7	01.85-03.95	65			GIR	0 986 473 671	← 48	
							0 986 474 671	→ 48	
					ZTG	BSY	0 204 102 065	← 48	0 204 104 033 <sup>7</sup>
							0 204 103 065		
							0 204 102 067	→ 48	0 204 104 033 <sup>7</sup>
							0 204 103 067		
	1.4	01.85-03.95	49-53				F 026 002 176	← 22,2	
							F 026 002 177	→ 22,2	
	1.7	01.85-03.95	65				F 026 002 176	← 22,2	
							F 026 002 177	→ 22,2	
	1.4	01.85-03.95	49-53				1987 477 280	↔ 1487	
	1.7	01.85-03.95	65				1987 477 280	↔ 1487	
<b>19 Cabrio [X53]</b>									
	1.7i	09.88-12.95	66-70			GIR	0 986 473 677	← 48	
							0 986 474 677	→ 48	
	1.8i	06.89-12.95	65-66/79-83/			GIR	0 986 473 677	← 48	
	1.8i 16V		99-101				0 986 474 677	→ 48	
	1.7i	05.91-12.95	66-70			BSY	F 026 002 234	← 20,6	
							F 026 002 235	→ 20,6	
						GIR	0 986 475 641	▲ → 20,6	
							0 986 475 642	▲ ← 20,6	



1.8i			05.92-12.95	65-66/79	BSY	F 026 <b>002 234</b>	← 20,6	
						F 026 <b>002 235</b>	→ 20,6	
					GIR	0 986 <b>475 641</b>	▲ → 20,6	
						0 986 <b>475 642</b>	▲ ← 20,6	
			09.94-12.95	79-83	BSY	F 026 <b>002 131</b>	← 19	
						F 026 <b>002 132</b>	→ 19	
					GIR	0 986 <b>475 641</b>	▲ → 20,6	
						0 986 <b>475 642</b>	▲ ← 20,6	
	1.7i	ABS	09.88-12.95	66-70		0 204 <b>102 075</b>	← 30	0 204 <b>100 062<sup>B</sup></b>
						0 986 <b>134 098</b>		0 204 <b>104 068<sup>9</sup></b>
						0 204 <b>102 077</b>	→ 30	0 204 <b>100 062<sup>B</sup></b>
						0 204 <b>103 077</b>		
						0 986 <b>135 098</b>		
	1.8i	ABS	05.92-12.95	65-66/ 79-83		0 204 <b>102 075</b>	← 30	0 204 <b>100 062<sup>B</sup></b>
						0 986 <b>134 098</b>		0 204 <b>104 068<sup>9</sup></b>
						0 204 <b>102 077</b>	→ 30	0 204 <b>100 062<sup>B</sup></b>
						0 204 <b>103 077</b>		
						0 986 <b>135 098</b>		
	1.8i 16V		06.89-12.95	99-101		0 204 <b>102 075</b>	← 30	0 204 <b>100 062<sup>B</sup></b>
						0 986 <b>134 098</b>		0 204 <b>104 068<sup>9</sup></b>
						0 204 <b>102 077</b>	→ 30	0 204 <b>100 062<sup>B</sup></b>
						0 204 <b>103 077</b>		
						0 986 <b>135 098</b>		
	1.7i	ABO	09.88-12.95	66-70		1 987 <b>477 311</b>	1564	
		ABS	09.88-12.95	66-70		1 987 <b>477 471</b>	1564	
	1.8i	ABO	05.92-12.95	65-66/79-83		1 987 <b>477 311</b>	1564	
		ABS	05.92-12.95	65-66/79-83		1 987 <b>477 471</b>	1564	
	1.8i 16V		06.89-12.95	99-101		1 987 <b>477 471</b>	1564	
	1.7i		04.93-12.95	66-70	BO	0 265 <b>006 735<sup>3</sup></b>		
					LAB	BO 0 265 <b>006 737<sup>4</sup></b>		
					RAB	BO 0 265 <b>006 736<sup>4</sup></b>		
	1.8i		04.93-12.95	65-66/	BO	0 265 <b>006 735<sup>3</sup></b>		
	1.8i 16V			79-83/ 99-101	LAB	BO 0 265 <b>006 737<sup>4</sup></b>		
					RAB	BO 0 265 <b>006 736<sup>4</sup></b>		
<b>19 Sedan</b>								
	1.6		01.93-05.00	61		0 986 <b>475 641</b>	▲ → 20,6	
	1.6i					0 986 <b>475 642</b>	▲ ← 20,6	
<b>19 [X53]</b>								
	1.2		09.88-12.01	40/46	BSY	0 204 <b>102 249</b>	← 48	0 204 <b>100 127<sup>B</sup></b>
	1.2i					0 986 <b>473 101</b>		0 204 <b>104 052<sup>7</sup></b>
						0 204 <b>102 250</b>	→ 48	0 204 <b>100 127<sup>B</sup></b>
						0 986 <b>474 101</b>		
					GIR	0 986 <b>473 671</b>	← 48	
						0 986 <b>474 671</b>	→ 48	
	1.4		09.88-12.01	58-59	BSY	0 204 <b>102 249</b>	← 48	0 204 <b>100 127<sup>B</sup></b>
						0 986 <b>473 101</b>		0 204 <b>104 052<sup>7</sup></b>
						0 204 <b>102 250</b>	→ 48	0 204 <b>100 127<sup>B</sup></b>
						0 986 <b>474 101</b>		
					GIR	0 986 <b>473 671</b>	← 48	
						0 986 <b>474 671</b>	→ 48	





	◀ RENAULT 19 [X53]									
1.4	09.88-12.01	40-44	BSY	0 204 102 249	← 48	0 204 100 127 <sup>8</sup>				
1.4i				0 986 473 101		0 204 104 052 <sup>7</sup>				
				0 204 102 250	→ 48	0 204 100 127 <sup>8</sup>				
				0 986 474 101						
			GIR	0 986 473 671	← 48					
				0 986 474 671	→ 48					
1.4i	05.90-12.01	55-59	BSY	0 204 102 249	← 48	0 204 100 127 <sup>8</sup>				
				0 986 473 101		0 204 104 052 <sup>7</sup>				
				0 204 102 250	→ 48	0 204 100 127 <sup>8</sup>				
				0 986 474 101						
			GIR	0 986 473 671	← 48					
				0 986 474 671	→ 48					
	ABO 01.95-12.01	55-59	GIR	0 986 473 671	← 48					
				0 986 474 671	→ 48					
	ABS 01.95-12.01	55-59	GIR	0 986 473 677	← 48					
				0 986 474 677	→ 48					
1.7	09.88-12.95	55-56	BSY	0 204 102 249	← 48	0 204 100 127 <sup>8</sup>				
				0 986 473 101		0 204 104 052 <sup>7</sup>				
				0 204 102 250	→ 48	0 204 100 127 <sup>8</sup>				
				0 986 474 101						
1.7	09.88-12.95	66-70	GIR	0 986 473 677	← 48					
1.7i				0 986 474 677	→ 48					
1.7i	09.88-12.95	54	BSY	0 204 102 249	← 48	0 204 100 127 <sup>8</sup>				
				0 986 473 101		0 204 104 052 <sup>7</sup>				
				0 204 102 250	→ 48	0 204 100 127 <sup>8</sup>				
				0 986 474 101						
			GIR	0 986 473 671	← 48					
				0 986 474 671	→ 48					
	ABO 01.95-12.95	54	GIR	0 986 473 671	← 48					
				0 986 474 671	→ 48					
	ABS 01.95-12.95	54	GIR	0 986 473 677	← 48					
				0 986 474 677	→ 48					
1.8i	06.89-12.95	65-66/79-83/	GIR	0 986 473 677	← 48					
1.8i 16V		99-101		0 986 474 677	→ 48					
1.9D	09.88-12.01	47	BSY	0 204 102 249	← 48	0 204 100 127 <sup>8</sup>				
				0 986 473 101		0 204 104 052 <sup>7</sup>				
				0 204 102 250	→ 48	0 204 100 127 <sup>8</sup>				
				0 986 474 101						
	06.90-12.01	47	GIR	0 986 473 671	← 48					
				0 986 474 671	→ 48					
	ABO 09.88-12.01	47	GIR	0 986 473 671	← 48					
				0 986 474 671	→ 48					
	ABS 10.91-12.01	47	GIR	0 986 473 671	← 48					
				0 986 474 671	→ 48					
1.9D Turbo	09.90-12.01	66-68	GIR	0 986 473 677	← 48					
				0 986 474 677	→ 48					

1.2	09.88-12.01	40	GIR	0 986 475 641	▲ → 20,6					
				0 986 475 642	▲ ← 20,6					
	05.91-12.01	40	BRB,	F 026 002 234	← 20,6					
			BSY	F 026 002 235	→ 20,6					
			BSY	F 026 002 234	← 20,6					
				F 026 002 235	→ 20,6					
1.2i	05.92-12.01	46	BSY	F 026 002 234	← 20,6					
				F 026 002 235	→ 20,6					
			GIR	0 986 475 641	▲ → 20,6					
				0 986 475 642	▲ ← 20,6					
1.4	05.91-12.01	40-44/	BSY	F 026 002 234	← 20,6					
1.4i		55-59		F 026 002 235	→ 20,6					
			GIR	0 986 475 641	▲ → 20,6					
				0 986 475 642	▲ ← 20,6					

			S								
1.7			05.91-12.95	68				BSY	F 026 <b>002 234</b>	← 20,6	
									F 026 <b>002 235</b>	→ 20,6	
								GIR	0 986 <b>475 641</b>	▲ → 20,6	
									0 986 <b>475 642</b>	▲ ← 20,6	
1.7			05.91-12.95	54/55-56				BSY	F 026 <b>002 234</b>	← 20,6	
1.7i									F 026 <b>002 235</b>	→ 20,6	
								GIR	0 986 <b>475 641</b>	▲ → 20,6	
									0 986 <b>475 642</b>	▲ ← 20,6	
1.7i			05.91-12.95	66-70				BSY	F 026 <b>002 234</b>	← 20,6	
									F 026 <b>002 235</b>	→ 20,6	
								GIR	0 986 <b>475 641</b>	▲ → 20,6	
									0 986 <b>475 642</b>	▲ ← 20,6	
			05.92-12.95	66-70				BSY	F 026 <b>002 131</b>	← 19	
									F 026 <b>002 132</b>	→ 19	
1.8i			05.92-12.95	65-66				BSY	F 026 <b>002 234</b>	← 20,6	
									F 026 <b>002 235</b>	→ 20,6	
								GIR	0 986 <b>475 641</b>	▲ → 20,6	
									0 986 <b>475 642</b>	▲ ← 20,6	
				79-83				BSY	F 026 <b>002 131</b>	← 19	
									F 026 <b>002 132</b>	→ 19	
								GIR	0 986 <b>475 641</b>	▲ → 20,6	
									0 986 <b>475 642</b>	▲ ← 20,6	
			09.94-12.95	79				BSY	F 026 <b>002 131</b>	← 19	
									F 026 <b>002 132</b>	→ 19	
									F 026 <b>002 234</b>	← 20,6	
									F 026 <b>002 235</b>	→ 20,6	
								GIR	0 986 <b>475 641</b>	▲ → 20,6	
									0 986 <b>475 642</b>	▲ ← 20,6	
1.9D			05.91-12.01	47				BSY	F 026 <b>002 234</b>	← 20,6	
									F 026 <b>002 235</b>	→ 20,6	
								GIR	0 986 <b>475 641</b>	▲ → 20,6	
									0 986 <b>475 642</b>	▲ ← 20,6	
1.9D Turbo			05.91-12.01	66-68				GIR	0 986 <b>475 641</b>	▲ → 20,6	
									0 986 <b>475 642</b>	▲ ← 20,6	
			05.92-12.01	66-68				BSY	F 026 <b>002 131</b>	← 19	
									F 026 <b>002 132</b>	→ 19	
	1.4i	ABS	05.90-12.01	55-59					0 204 <b>102 075</b>	← 30	0 204 <b>100 062</b> <sup>B</sup>
									0 986 <b>134 098</b>		0 204 <b>104 068</b> <sup>9</sup>
									0 204 <b>102 077</b>	→ 30	0 204 <b>100 062</b> <sup>B</sup>
									0 204 <b>103 077</b>		
									0 986 <b>135 098</b>		
1.7		ABS	09.88-12.95	54/55-56/					0 204 <b>102 075</b>	← 30	0 204 <b>100 062</b> <sup>B</sup>
1.7i				66-70					0 986 <b>134 098</b>		0 204 <b>104 068</b> <sup>9</sup>
									0 204 <b>102 077</b>	→ 30	0 204 <b>100 062</b> <sup>B</sup>
									0 204 <b>103 077</b>		
									0 986 <b>135 098</b>		
1.8i		ABS	05.92-12.95	65-66/					0 204 <b>102 075</b>	← 30	0 204 <b>100 062</b> <sup>B</sup>
				79-83					0 986 <b>134 098</b>		0 204 <b>104 068</b> <sup>9</sup>
									0 204 <b>102 077</b>	→ 30	0 204 <b>100 062</b> <sup>B</sup>
									0 204 <b>103 077</b>		
									0 986 <b>135 098</b>		
1.8i 16V			06.89-12.95	99-101					0 204 <b>102 075</b>	← 30	0 204 <b>100 062</b> <sup>B</sup>
									0 986 <b>134 098</b>		0 204 <b>104 068</b> <sup>9</sup>
									0 204 <b>102 077</b>	→ 30	0 204 <b>100 062</b> <sup>B</sup>
									0 204 <b>103 077</b>		
									0 986 <b>135 098</b>		
1.9D		ABS	09.88-12.01	47/66-68					0 204 <b>102 075</b>	← 30	0 204 <b>100 062</b> <sup>B</sup>
1.9D Turbo									0 986 <b>134 098</b>		0 204 <b>104 068</b> <sup>9</sup>
									0 204 <b>102 077</b>	→ 30	0 204 <b>100 062</b> <sup>B</sup>
									0 204 <b>103 077</b>		
									0 986 <b>135 098</b>		





◀ RENAULT 19 [X53]



	1.2	ABO	09.88-12.01	40/46			1987 477 311	1564
	1.2 i	ABS	09.88-12.01	40/46			1987 477 471	1564
	1.4	ABO	09.88-12.01	40-44/55-59			1987 477 311	1564
	1.4 i	ABS	09.88-12.01	40-44/55-59			1987 477 471	1564
	1.7	ABO	09.88-12.95	54/55-56/66-70			1987 477 311	1564
	1.7 i	ABS	09.88-12.95	54/55-56/66-70			1987 477 471	1564
	1.8 i	ABO	05.92-12.95	65-66/79-83			1987 477 311	1564
		ABS	05.92-12.95	65-66/79-83			1987 477 471	1564
	1.8 i 16V		06.89-12.95	99-101			1987 477 471	1564
	1.9 D	ABO	09.88-12.01	47/66-68			1987 477 311	1564
	1.9 D Turbo	ABS	09.88-12.01	47/66-68			1987 477 471	1564

	1.2 i		04.93-12.01	46		BO	0 265 006 735 <sup>3</sup>		
						LAB	BO	0 265 006 737 <sup>4</sup>	
						RAB	BO	0 265 006 736 <sup>4</sup>	
	1.4 i		04.93-12.01	55-59			BO	0 265 006 735 <sup>3</sup>	
						LAB	BO	0 265 006 737 <sup>4</sup>	
						RAB	BO	0 265 006 736 <sup>4</sup>	
	1.7		04.93-12.95	54/55-56/			BO	0 265 006 735 <sup>3</sup>	
		1.7 i			66-70		LAB	BO	0 265 006 737 <sup>4</sup>
						RAB	BO	0 265 006 736 <sup>4</sup>	
	1.8 i		04.93-12.95	65-66/			BO	0 265 006 735 <sup>3</sup>	
		1.8 i 16V			79-83/		LAB	BO	0 265 006 737 <sup>4</sup>
					99-101		RAB	BO	0 265 006 736 <sup>4</sup>
	1.9 D		04.93-12.01	47/66-68			BO	0 265 006 735 <sup>3</sup>	
		1.9 D Turbo					LAB	BO	0 265 006 737 <sup>4</sup>
						RAB	BO	0 265 006 736 <sup>4</sup>	

21 [L48]



	1.4		06.88-12.94	49-50		GIR	0 986 473 677		← 48			
								0 986 474 677		→ 48		
	1.7		03.86-12.94	64			GIR	0 986 473 677		← 48		
								0 986 474 677		→ 48		
			06.90-12.94	65			GIR	0 986 473 677		← 48		
								0 986 474 677		→ 48		
						VEA	GIR	0 986 473 665		← 54		
								0 986 474 665		→ 54		
	1.7		03.86-12.94	54			BSY	0 204 102 065		← 48	0 204 100 062 <sup>8</sup>	
		1.7 i							0 204 103 065			0 204 104 033 <sup>7</sup>
									0 204 102 067		→ 48	0 204 100 062 <sup>8</sup>
									0 204 103 067			
						GIR	0 986 473 677		← 48			
								0 986 474 677		→ 48		
	1.7 i		03.86-12.94	66-70		GIR	0 986 473 677		← 48			
								0 986 474 677		→ 48		
	1.9 D		04.92-12.94	48			GIR	0 986 473 677		← 48		
								0 986 474 677		→ 48		
	2.0 i		05.89-12.94	88/100			BSY	0 204 102 251		← 54	0 204 100 096 <sup>8</sup>	
								0 204 103 251			0 204 104 048 <sup>7</sup>	
								0 204 102 252		→ 54	0 204 100 096 <sup>8</sup>	
								0 204 103 252				
	2.1 D		06.91-12.94	46-56/			BSY	0 204 102 251		← 54	0 204 100 096 <sup>8</sup>	
		2.1 D Turbo			65-68			0 204 103 251			0 204 104 048 <sup>7</sup>	
							0 204 102 252		→ 54	0 204 100 096 <sup>8</sup>		
							0 204 103 252					
2.2		03.86-12.94	79-81/85			BSY	0 204 102 251		← 54	0 204 100 096 <sup>8</sup>		
	2.2 i						0 204 103 251			0 204 104 048 <sup>7</sup>		
								0 204 102 252		→ 54	0 204 100 096 <sup>8</sup>	
								0 204 103 252				

		S							
	1.4	06.88-12.94	49-50			BSY	F 026 <b>002 232</b>	← 22	
							F 026 <b>002 233</b>	→ 22	
						GIR	0 986 <b>475 053</b>	← 22,2	
							0 986 <b>475 054</b>	→ 22,2	
	1.7	03.86-12.94	54			BSY	F 026 <b>002 232</b>	→ 22	
			64			BSY	F 026 <b>002 232</b>	→ 22	
							F 026 <b>002 233</b>	← 22	
						GIR	0 986 <b>475 053</b>	← 22,2	
							0 986 <b>475 054</b>	→ 22,2	
		06.90-12.94	65			GIR	0 986 <b>475 053</b>	← 22,2	
							0 986 <b>475 054</b>	→ 22,2	
					Fg.-Nr. S1→S19	BSY	F 026 <b>002 232</b>	→ 22	
							F 026 <b>002 233</b>	← 22	
					Fg.-Nr. S20→	BSY	F 026 <b>002 232</b>	← 22	
							F 026 <b>002 233</b>	→ 22	
	1.7	03.86-12.94	54			GIR	0 986 <b>475 053</b>	← 22,2	
	1.7i						0 986 <b>475 054</b>	→ 22,2	
	1.7i	03.86-12.94	54		Fg.-Nr. H1→H708	BSY	F 026 <b>002 176</b>	← 22,2	
							F 026 <b>002 177</b>	→ 22,2	
					Fg.-Nr. H709→H6589, S1→S1596	BSY	F 026 <b>002 232</b>	→ 22	
							F 026 <b>002 233</b>	← 22	
					Fg.-Nr. H6590→, S1597→	BSY	F 026 <b>002 232</b>	← 22	
							F 026 <b>002 233</b>	→ 22	
			66-70			GIR	0 986 <b>475 053</b>	← 22,2	
							0 986 <b>475 054</b>	→ 22,2	
					Fg.-Nr. H1→H3449	BSY	F 026 <b>002 176</b>	← 22,2	
							F 026 <b>002 177</b>	→ 22,2	
					Fg.-Nr. H3450→H11574, S1→S5972	BSY	F 026 <b>002 232</b>	→ 22	
							F 026 <b>002 233</b>	← 22	
					Fg.-Nr. H11575→, S5973→	BSY	F 026 <b>002 232</b>	← 22	
							F 026 <b>002 233</b>	→ 22	
	1.9D	04.92-12.94	48			GIR	0 986 <b>475 053</b>	← 22,2	
							0 986 <b>475 054</b>	→ 22,2	
	2.0i	06.90-12.94	88			GIR	0 986 <b>475 053</b>	← 22,2	
							0 986 <b>475 054</b>	→ 22,2	
	2.1D	04.92-12.94	46-56			BSY	F 026 <b>002 232</b>	← 22	
							F 026 <b>002 233</b>	→ 22	
	2.1D Turbo	06.91-12.94	65-68			GIR	0 986 <b>475 053</b>	← 22,2	
							0 986 <b>475 054</b>	→ 22,2	
	2.2	03.86-12.94	79-81/85			GIR	0 986 <b>475 053</b>	← 22,2	
	2.2i						0 986 <b>475 054</b>	→ 22,2	
	2.0i	05.89-12.94	100			BSY	0 204 <b>102 243</b>	← 36	0 204 <b>104 066</b> <sup>9</sup>
							0 204 <b>103 243</b>		0 204 <b>104 219</b> <sup>7</sup>
							0 204 <b>102 244</b>	→ 36	0 204 <b>104 066</b> <sup>9</sup>
							0 204 <b>103 244</b>		
		ABS 06.90-12.94	88			BSY	0 204 <b>102 243</b>	← 36	0 204 <b>104 066</b> <sup>9</sup>
							0 204 <b>103 243</b>		0 204 <b>104 219</b> <sup>7</sup>
							0 204 <b>102 244</b>	→ 36	0 204 <b>104 066</b> <sup>9</sup>
							0 204 <b>103 244</b>		
	2.1D	ABS 04.92-12.94	49-54/			BSY	0 204 <b>102 243</b>	← 36	0 204 <b>104 066</b> <sup>9</sup>
	2.1D Turbo		65-68				0 204 <b>103 243</b>		0 204 <b>104 219</b> <sup>7</sup>
							0 204 <b>102 244</b>	→ 36	0 204 <b>104 066</b> <sup>9</sup>
							0 204 <b>103 244</b>		
	2.2	ABS 03.86-12.94	79-81/85			BSY	0 204 <b>102 243</b>	← 36	0 204 <b>104 066</b> <sup>9</sup>
	2.2i						0 204 <b>103 243</b>		0 204 <b>104 219</b> <sup>7</sup>
							0 204 <b>102 244</b>	→ 36	0 204 <b>104 066</b> <sup>9</sup>
							0 204 <b>103 244</b>		







◀ RENAULT 21 [L48]



	1.4	06.88-12.94	49-50	L65	1987 477 332	1467
	1.7	06.90-12.94	65	L65	1987 477 332	1467
	1.7, i	03.86-12.94	54/64		1987 477 332	1467
	1.7 i	03.86-12.94	66-70		1987 477 332	1467
	1.9D	04.92-12.94	48		1987 477 332	1467
	2.1D	04.92-12.94	46-56		1987 477 332	1467





















21 Nevada [K48]



	1.4	06.88-12.95	51	GIR	0986 473 677	← 48					
					0986 474 677	→ 48					
	1.7	06.86-12.95	53-56	BSY	0 204 102 065	← 48	0 204 100 062 <sup>8</sup>				
					0 204 103 065		0 204 104 033 <sup>7</sup>				
	1.7 i				0 204 102 067	→ 48	0 204 100 062 <sup>8</sup>				
					0 204 103 067						
					GIR	0986 473 677	← 48				
						0986 474 677	→ 48				
			54-60/65/ 66-70	GIR	0986 473 677	← 48					
						0986 474 677	→ 48				
					1.9D	05.89-12.95	48	BSY	0 204 102 065	← 48	0 204 100 062 <sup>8</sup>
									0 204 103 065		0 204 104 033 <sup>7</sup>
					→ 48	0 204 100 062 <sup>8</sup>					
				GIR	0986 473 677	← 48					
					0986 474 677	→ 48					
2.0	10.86-12.95	76/85-88/ 99-100		0 204 102 251	← 54	0 204 100 096 <sup>8</sup>					
				0 204 103 251		0 204 104 048 <sup>7</sup>					
2.0 i				0 204 102 252	→ 54	0 204 100 096 <sup>8</sup>					
				0 204 103 252							
2.1D	10.86-12.95	49/51-54/ 65		0 204 102 251	← 54	0 204 100 096 <sup>8</sup>					
				0 204 103 251		0 204 104 048 <sup>7</sup>					
2.1D Turbo				0 204 102 252	→ 54	0 204 100 096 <sup>8</sup>					
				0 204 103 252							
2.2	10.86-12.95	79-81/85		0 204 102 251	← 54	0 204 100 096 <sup>8</sup>					
				0 204 103 251		0 204 104 048 <sup>7</sup>					
2.2 i				0 204 102 252	→ 54	0 204 100 096 <sup>8</sup>					
				0 204 103 252							



	1.4	06.88-12.95	51		0986 475 053	← 22,2		
					0986 475 054	→ 22,2		
	1.7	06.86-12.95	53-60/65/ 66-70		0986 475 053	← 22,2		
					0986 475 054	→ 22,2		
	1.9D	05.89-12.95	48		0986 475 053	← 22,2		
					0986 475 054	→ 22,2		
	2.0	10.86-12.95	76		0986 475 053	← 22,2		
					0986 475 054	→ 22,2		
	2.0 i	10.86-12.95	85-88	AA	0 204 116 159	↔ 22,2		
					AA	0986 475 053	← 22,2	
						0986 475 054	→ 22,2	
						0986 475 053	← 22,2	
		06.90-12.95	88			→ 22,2		
						0986 475 053	← 22,2	
						0986 475 054	→ 22,2	
						0986 475 053	← 22,2	
	2.1D	10.86-12.95	49	AA	0 204 116 159	↔ 22,2		
					AA	0986 475 053	← 22,2	
					0986 475 054	→ 22,2		
					0986 475 053	← 22,2		
					0986 475 054	→ 22,2		
					0986 475 053	← 22,2		
	05.89-12.95	53-54	AA	0 204 116 159	↔ 22,2			
				AA	0986 475 053	← 22,2		
				0986 475 054	→ 22,2			

		S							
2.1D							0 986 475 053	← 22,2	
							0 986 475 054	→ 22,2	
2.1D Turbo							0 986 475 053	← 22,2	
							0 986 475 054	→ 22,2	
2.2							0 986 475 053	← 22,2	
							0 986 475 054	→ 22,2	
2.2i						AA	0 204 116 159	↔ 22,2	
						AA	0 986 475 053	← 22,2	
							0 986 475 054	→ 22,2	
							0 986 475 053	← 22,2	
							0 986 475 054	→ 22,2	
 2.0		ABS	10.86-12.95	76/85-88/		BSY	0 204 102 243	← 36	0 204 104 066 <sup>9</sup>
2.0i				99-100			0 204 103 243		0 204 104 219 <sup>7</sup>
							0 204 102 244	→ 36	0 204 104 066 <sup>9</sup>
							0 204 103 244		
2.1D		ABS	10.86-12.95	49/51-54/		BSY	0 204 102 243	← 36	0 204 104 066 <sup>9</sup>
2.1D Turbo				65			0 204 103 243		0 204 104 219 <sup>7</sup>
							0 204 102 244	→ 36	0 204 104 066 <sup>9</sup>
							0 204 103 244		
2.2		ABS	10.86-12.95	79-81/85		BSY	0 204 102 243	← 36	0 204 104 066 <sup>9</sup>
2.2i							0 204 103 243		0 204 104 219 <sup>7</sup>
							0 204 102 244	→ 36	0 204 104 066 <sup>9</sup>
							0 204 103 244		
									
 1.4			06.88-12.95	51			1 987 477 469	1646	
1.7, i			06.86-12.95	53-60/65/66-70			1 987 477 469	1646	
1.9D			05.89-12.95	48			1 987 477 469	1646	
2.0		ABO	10.86-12.95	76			1 987 477 469	1646	
2.0i		ABO	10.86-12.95	85-88		AA	1 987 477 469	1646	
			06.90-12.95	88			1 987 477 469	1646	
2.1D			05.89-12.95	53-54		AA	1 987 477 469	1646	
2.1D, D Turbo		ABO	10.86-12.95	49/51-54/65			1 987 477 469	1646	
2.2		ABO	10.86-12.95	85			1 987 477 469	1646	
2.2i		ABO	10.86-12.95	79-81		AA	1 987 477 469	1646	
			04.93-12.95	79-81			1 987 477 469	1646	
<b>ROLLS-ROYCE</b>									
<b>Ghost [RR4]</b>									
									
 6.6			12.09-08.11	420			0 265 007 981 <sup>3</sup>		
			12.09→	420			0 265 007 983 <sup>4</sup>		
			09.11→	420			0 265 009 227 <sup>3</sup>		
6.6 V-Specification			01.14-06.14	442			0 265 007 983 <sup>4</sup>		
							0 265 009 227 <sup>3</sup>		
<b>Wraith [RR5]</b>									
									
 6.6			08.13→	465			0 265 007 983 <sup>4</sup>		
							0 265 009 227 <sup>3</sup>		





**ROVER**

**Mini**

	1.3 1.3i	02.90-09.00	39-46	0986 473 370	← 51	1987 470 076 <sup>7</sup>
				0986 474 370	→ 51	1987 470 076 <sup>7</sup>

	1.3 1.3i	02.90-09.00	39-46	0986 475 793	↔ 19,05	

**Mini Cabrio**

	1.3 1.3i	02.90-09.00	39-46	0986 473 370	← 51	1987 470 076 <sup>7</sup>
				0986 474 370	→ 51	1987 470 076 <sup>7</sup>

	1.3 1.3i	02.90-09.00	39-46	0986 475 793	↔ 19,05	

**Mini Cooper**

	1.3 1.3i	02.90-09.00	39-46/59	0986 473 370	← 51	1987 470 076 <sup>7</sup>
				0986 474 370	→ 51	1987 470 076 <sup>7</sup>

	1.3 1.3i	02.90-09.00	39-46/59	0986 475 793	↔ 19,05	

**Mini Cooper Cabrio**

	1.3 1.3i	02.90-09.00	39-46/59	0986 473 370	← 51	1987 470 076 <sup>7</sup>
				0986 474 370	→ 51	1987 470 076 <sup>7</sup>

	1.3 1.3i	02.90-09.00	39-46/59	0986 475 793	↔ 19,05	

**Mini De Ville**

	1.3i	09.94-09.96	59	0986 473 370	← 51	1987 470 076 <sup>7</sup>
				0986 474 370	→ 51	1987 470 076 <sup>7</sup>

	1.3i	09.94-09.96	59	0986 475 793	↔ 19,05	



		S								
<b>Mini De Ville Cabrio</b>										
	1.3i		09.94-09.96	59			0 986 473 370		← 51	1 987 470 076 <sup>7</sup>
							0 986 474 370		→ 51	1 987 470 076 <sup>7</sup>
	1.3i		09.94-09.96	59			0 986 475 793		↔ 19,05	
<b>Mini Margrave</b>										
	1.4i		09.95-09.00	77			0 986 473 370		← 51	1 987 470 076 <sup>7</sup>
							0 986 474 370		→ 51	1 987 470 076 <sup>7</sup>
	1.4i		09.95-09.00	77			0 986 475 793		↔ 19,05	
<b>Mini Retro Rally</b>										
	1.3i		09.94-09.96	60			0 986 473 370		← 51	1 987 470 076 <sup>7</sup>
							0 986 474 370		→ 51	1 987 470 076 <sup>7</sup>
	1.3i		09.94-09.96	60			0 986 475 793		↔ 19,05	
<b>Serie 200</b>										
	211i	ABO	11.95-03.00	44-45			0 986 473 088		← 54	
							0 986 474 088		→ 54	
		ABS	11.95-03.00	44-45			0 986 474 778		← 54	
							0 986 474 779		→ 54	
	214 Cabrio	ABO	10.92-11.99	66-70			0 986 473 088		← 54	
							0 986 474 088		→ 54	
	214 Cabrio, i, Si 16V, Si 16V Cabrio, 16V Coupé	ABS	10.92-03.00	55/66-70/ 76			0 986 474 778		← 54	
							0 986 474 779		→ 54	
	214i	ABO	01.93-02.96	55			0 986 474 776		← 54	
							0 986 474 777		→ 54	
			10.95-03.00	55			0 986 473 088		← 54	
							0 986 474 088		→ 54	
	214 Si 16V	ABO	10.92-02.96	76			0 986 474 776		← 54	
							0 986 474 777		→ 54	
	214 Si 16V Cabrio	ABO	10.92-03.00	76			0 986 473 088		← 54	
	214 16V Coupé						0 986 474 088		→ 54	
	216 GTi 16V Cabrio, i 16V Cabrio, i 16V Coupé	ABO	05.92-03.00	82/90			0 986 473 088		← 54	
							0 986 474 088		→ 54	
	216 GTi 16V, GTi 16V Cabrio, i 16V, i 16V Cabrio, i 16V Coupé, 16V	ABS	10.89-03.00	82-85/ 90-96			0 986 474 778		← 54	
							0 986 474 779		→ 54	
	218 D Turbo, i 16V, i 16V Coupé, 1.9 D	ABS	10.92-03.00	52/65/107			0 986 474 778		← 54	
							0 986 474 779		→ 54	
	218 D Turbo	ABO	10.92-02.96	52/65			0 986 474 776		← 54	
	218 1.9 D						0 986 474 777		→ 54	
	218 i 16V	ABO	09.95-03.00				0 986 473 088		← 54	
							0 986 474 088		→ 54	



		S							
	<b>ROVER Serie 200</b>								
	<b>218 i 16V</b>	ABO	09.95-03.00	107			0986 473 088		← 54
	<b>218 i 16V Coupé</b>						0986 474 088		→ 54
	<b>220 GTi 16V, GTi/GSi, i Turbo, i Turbo Coupé, SD, SDI</b>	ABS	09.91-03.00	63/77/100/ 103/147			0986 474 778		← 54
	<b>220 SD</b>	ABO	09.95-03.00	63/77			0986 473 088		← 54
	<b>220 SDI</b>						0986 474 088		→ 54
	<b>211 i</b>		11.95-02.96	44-45			0986 475 808		→ 19,05
			03.96-03.00	44-45			0986 475 809		← 19,05
							0986 475 854		← 19,05
							0986 475 855		→ 19,05
	<b>214 Cabrio</b>		10.92-02.96	66-70			0986 475 808		→ 19,05
							0986 475 809		← 19,05
	<b>214 i</b>		01.93-02.96	55			0986 475 808		→ 19,05
			03.96-03.00	55			0986 475 809		← 19,05
							0986 475 854		← 19,05
							0986 475 855		→ 19,05
	<b>214 Si 16V, Si 16V Cabrio</b>		10.92-02.96	76			0986 475 809		← 19,05
	<b>214 Si 16V, Si 16V Cabrio, 16V Coupé</b>		10.92-02.96	76			0986 475 808		→ 19,05
	<b>214 16V Coupé</b>		10.95-02.96	76			0986 475 809		← 19,05
			03.96-03.00	76			0986 475 854		← 19,05
							0986 475 855		→ 19,05
	<b>216 GTi 16V, GTi 16V Cabrio, i 16V, i 16V Coupé</b>		10.89-02.96	82-85/ 90-96			0986 475 808		→ 19,05
							0986 475 809		← 19,05
	<b>216 i 16V Cabrio, i 16V Coupé, 16V</b>		03.96-03.00	82			0986 475 854		← 19,05
							0986 475 855		→ 19,05
	<b>216 16V</b>		10.95-02.96	82			0986 475 808		→ 19,05
							0986 475 809		← 19,05
	<b>218 D Turbo</b>		10.92-02.96	52/65			0986 475 808		→ 19,05
	<b>218 1.9 D</b>						0986 475 809		← 19,05
	<b>218 i 16V</b>		09.95-02.96	107			0986 475 808		→ 19,05
							0986 475 809		← 19,05
							0986 475 808		→ 19,05
			03.96-03.00	107			0986 475 809		← 19,05
							0986 475 854		← 19,05
							0986 475 854		← 19,05
							0986 475 855		→ 19,05
	<b>218 i 16V Coupé</b>		03.96-03.00	107			0986 475 854		← 19,05
	<b>218 i 16V, i 16V Coupé</b>		03.96-03.00	107			0986 475 855		→ 19,05
	<b>220 GTi 16V</b>		09.91-02.96	63/77/100/ 103			0986 475 808		→ 19,05
	<b>220 GTi/GSi</b>						0986 475 809		← 19,05
	<b>220 SD</b>		03.96-03.00	63/77/100/ 103			0986 475 854		← 19,05
	<b>220 SDI</b>						0986 475 855		→ 19,05
	<b>211 i</b>		11.95-03.00	44-45			0986 474 780		← 30,2
							0986 474 781		→ 30,2
	<b>214 Cabrio, i, Si 16V, Si 16V Cabrio, 16V Coupé</b>		10.92-03.00	55/66-70/ 76			0986 474 780		← 30,2
							0986 474 781		→ 30,2
	<b>216 GTi 16V, GTi 16V Cabrio, i 16V, i 16V Cabrio, i 16V Coupé, 16V</b>		10.89-03.00	82-85/ 90-96			0986 474 780		← 30,2
							0986 474 781		→ 30,2
	<b>218 D Turbo, i 16V, i 16V Coupé, 1.9 D</b>		10.92-03.00	52/65/107			0986 474 780		← 30,2
							0986 474 781		→ 30,2
	<b>220 GTi 16V, GTi/GSi, i Turbo i Turbo Coupé, SD, SDI</b>		09.91-03.00	63/77/100/ 103/147			0986 474 780		← 30,2
							0986 474 781		→ 30,2
	<b>211 i</b>		11.95-02.96	44-45	STB		1987 477 788		→ 1531
							1987 477 789		← 1506
					4SB		1987 477 736		→ 1678
							1987 477 738		← 1653

		S							
<b>211 i</b>		03.96-03.00	44-45			STB	1 987 477 888	→ 1812	
							1 987 477 889	← 1782	
<b>214 Cabrio</b>		10.92-11.99	66-70			STB	1 987 477 788	→ 1531	
							1 987 477 789	← 1506	
						4SB	1 987 477 736	→ 1678	
							1 987 477 738	← 1653	
<b>214 i</b>		01.93-02.96	55			STB	1 987 477 788	→ 1531	
							1 987 477 789	← 1506	
						4SB	1 987 477 736	→ 1678	
							1 987 477 738	← 1653	
		03.96-03.00	55			STB	1 987 477 886	→ 1713	
							1 987 477 887	← 1743	
<b>214 Si 16V</b>		10.92-03.96	76			STB	1 987 477 788	→ 1531	
<b>214 Si 16V Cabrio</b>							1 987 477 789	← 1506	
						4SB	1 987 477 736	→ 1678	
							1 987 477 738	← 1653	
<b>214 16V Coupé</b>		10.95-02.96	76			STB	1 987 477 788	→ 1531	
							1 987 477 789	← 1506	
						4SB	1 987 477 736	→ 1678	
							1 987 477 738	← 1653	
		03.96-03.00	76			STB	1 987 477 886	→ 1713	
							1 987 477 887	← 1743	
<b>216 GTi 16V</b>		10.89-02.96	82-85/			STB	1 987 477 788	→ 1531	
<b>216 GTi 16V Cabrio</b>			90-96				1 987 477 789	← 1506	
<b>216 i 16V</b>						4SB	1 987 477 736	→ 1678	
<b>216 i 16V Coupé</b>							1 987 477 738	← 1653	
<b>216 i 16V Cabrio</b>		03.96-03.00	82			STB	1 987 477 788	→ 1531	
<b>216 i 16V Coupé</b>							1 987 477 789	← 1506	
						4SB	1 987 477 736	→ 1678	
							1 987 477 738	← 1653	
<b>216 16V</b>		10.95-02.96	82			STB	1 987 477 788	→ 1531	
							1 987 477 789	← 1506	
						4SB	1 987 477 736	→ 1678	
							1 987 477 738	← 1653	
		03.96-03.00	82			STB	1 987 477 888	→ 1812	
							1 987 477 889	← 1782	
<b>218 D Turbo</b>		10.92-02.96	52/65			STB	1 987 477 788	→ 1531	
<b>218 1.9 D</b>							1 987 477 789	← 1506	
						4SB	1 987 477 736	→ 1678	
							1 987 477 738	← 1653	
<b>218 i 16V</b>		09.95-02.96	107			STB	1 987 477 788	→ 1531	
							1 987 477 789	← 1506	
						4SB	1 987 477 736	→ 1678	
							1 987 477 738	← 1653	
						STB	1 987 477 788	→ 1531	
							1 987 477 789	← 1506	
						4SB	1 987 477 736	→ 1678	
							1 987 477 738	← 1653	
		03.96-03.00	107			STB	1 987 477 888	→ 1812	
							1 987 477 889	← 1782	
						STB	1 987 477 888	→ 1812	
							1 987 477 889	← 1782	
<b>218 i 16V Coupé</b>		03.96-03.00	107			STB	1 987 477 788	→ 1531	
							1 987 477 789	← 1506	
						4SB	1 987 477 736	→ 1678	
							1 987 477 738	← 1653	
<b>220 GTi 16V</b>		09.91-02.96	63/77/100/			STB	1 987 477 788	→ 1531	
<b>220 GTi/GSi</b>			103/147				1 987 477 789	← 1506	
<b>220 i Turbo</b>						4SB	1 987 477 736	→ 1678	
<b>220 i Turbo Coupé</b>							1 987 477 738	← 1653	
<b>220 SD</b>		03.96-03.00	63/77/100/			STB	1 987 477 888	→ 1812	
<b>220 SDI</b>			103/147				1 987 477 889	← 1782	



◀ ROVER Serie 200									
	211 i	11.95-02.96	44-45	LAB	0 265 006 474 <sup>3</sup>				
					0 265 006 476 <sup>4</sup>				
				RAB	0 265 006 473 <sup>3</sup>				
					0 265 006 475 <sup>4</sup>				
		11.95-03.00	44-45	Fg.-Nr. WD 267264→	4SB	0 265 006 307 <sup>4</sup>			
		03.96-03.00	44-45		LAB	0 265 006 305 <sup>3</sup>			
					RAB	0 265 006 306 <sup>3</sup>			
214 Cabrio									
		10.92-02.96	66-70		LAB	0 265 006 474 <sup>3</sup>			
						0 265 006 476 <sup>4</sup>			
					RAB	0 265 006 473 <sup>3</sup>			
						0 265 006 475 <sup>4</sup>			
214 i									
		01.93-02.96	55		LAB	0 265 006 474 <sup>3</sup>			
						0 265 006 476 <sup>4</sup>			
					RAB	0 265 006 473 <sup>3</sup>			
						0 265 006 475 <sup>4</sup>			
		10.95-03.00	55	Fg.-Nr. WD 267264→	4SB	0 265 006 307 <sup>4</sup>			
		03.96-03.00	55		LAB	0 265 006 305 <sup>3</sup>			
					RAB	0 265 006 306 <sup>3</sup>			
214 Si 16V Cabrio									
		03.96-03.96	76		LAB	0 265 006 267 <sup>4</sup>			
						0 265 006 305 <sup>3</sup>			
					RAB	0 265 006 268 <sup>4</sup>			
						0 265 006 306 <sup>3</sup>			
214 Si 16V									
		10.92-02.96	76		LAB	0 265 006 474 <sup>3</sup>			
214 Si 16V Cabrio									
						0 265 006 476 <sup>4</sup>			
214 16V Coupé									
					RAB	0 265 006 473 <sup>3</sup>			
						0 265 006 475 <sup>4</sup>			
214 16V Coupé									
		10.95-03.00	76	Fg.-Nr. WD 267264→	4SB	0 265 006 307 <sup>4</sup>			
		03.96-03.00	76		LAB	0 265 006 305 <sup>3</sup>			
					RAB	0 265 006 306 <sup>3</sup>			
216 GTi 16V, GTi 16V Cabrio, i 16V, i 16V Coupé									
		10.89-02.96	82-85/ 90-96		LAB	0 265 006 476 <sup>4</sup>			
					RAB	0 265 006 475 <sup>4</sup>			
216 i 16V Cabrio									
		03.96-03.00	82		LAB	0 265 006 267 <sup>4</sup>			
216 i 16V Coupé									
					RAB	0 265 006 268 <sup>4</sup>			
						0 265 006 306 <sup>3</sup>			
216 i 16V Cabrio, i 16V Coupé, 16V									
		03.96-03.00	82		LAB	0 265 006 305 <sup>3</sup>			
216 16V									
		10.95-02.96	82		LAB	0 265 006 474 <sup>3</sup>			
						0 265 006 476 <sup>4</sup>			
					RAB	0 265 006 473 <sup>3</sup>			
						0 265 006 475 <sup>4</sup>			
		10.95-03.00	82	Fg.-Nr. WD 267264→	4SB	0 265 006 307 <sup>4</sup>			
		03.96-03.00	82			0 265 006 307 <sup>4</sup>			
					RAB	0 265 006 306 <sup>3</sup>			
218 D Turbo									
		10.92-02.96	52/65		LAB	0 265 006 474 <sup>3</sup>			
218 1.9 D									
						0 265 006 476 <sup>4</sup>			
					RAB	0 265 006 473 <sup>3</sup>			
						0 265 006 475 <sup>4</sup>			
218 i 16V									
		09.95-02.96	107		LAB	0 265 006 474 <sup>3</sup>			
						0 265 006 476 <sup>4</sup>			
					RAB	0 265 006 473 <sup>3</sup>			
						0 265 006 475 <sup>4</sup>			
					LAB	0 265 006 474 <sup>3</sup>			
						0 265 006 476 <sup>4</sup>			
					RAB	0 265 006 473 <sup>3</sup>			
						0 265 006 475 <sup>4</sup>			
		09.95-03.00	107	Fg.-Nr. WD 267264→	4SB	0 265 006 307 <sup>4</sup>			
				Fg.-Nr. WD 267264→	4SB	0 265 006 307 <sup>4</sup>			
		03.96-03.00			LAB	0 265 006 305 <sup>3</sup>			
					RAB	0 265 006 306 <sup>3</sup>			
218 i 16V Coupé									
		03.96-03.00	107		LAB	0 265 006 267 <sup>4</sup>			
					RAB	0 265 006 268 <sup>4</sup>			
218 i 16V									
		03.96-03.00	107		LAB	0 265 006 305 <sup>3</sup>			
218 i 16V Coupé									
					RAB	0 265 006 306 <sup>3</sup>			



		S							
220 GTi 16V		09.91-02.96	100/103/147			LAB	0 265 006 474 <sup>3</sup>		
220 GTi/GSi							0 265 006 476 <sup>4</sup>		
220 i Turbo						RAB	0 265 006 473 <sup>3</sup>		
220 i Turbo Coupé							0 265 006 475 <sup>4</sup>		
		03.96-06.96	100/103/147				0 265 006 307 <sup>4</sup>		
						LAB	0 265 006 305 <sup>3</sup>		
						RAB	0 265 006 306 <sup>3</sup>		
220 SD		09.95-02.96	63/77			LAB	0 265 006 474 <sup>3</sup>		
220 SDI							0 265 006 476 <sup>4</sup>		
						RAB	0 265 006 473 <sup>3</sup>		
							0 265 006 475 <sup>4</sup>		
		09.95-03.00	63/77	Fg.-Nr. WD 267264→		4SB	0 265 006 307 <sup>4</sup>		
		03.96-03.00	63/77			LAB	0 265 006 305 <sup>3</sup>		
						RAB	0 265 006 306 <sup>3</sup>		

**Serie 400**









	414 Si 16V		05.95-03.00	76		INB	0 986 474 778		← 54
							0 986 474 779		→ 54
						INB	0 986 473 088		← 54
							0 986 474 088		→ 54
	414 16V	ABO	04.90-04.95	66-70			0 986 474 776		← 54
							0 986 474 777		→ 54
			01.93-04.95	76			0 986 474 776		← 54
							0 986 474 777		→ 54
			05.95-02.96	76			0 986 473 088		← 54
							0 986 474 088		→ 54
		ABS	04.90-04.95	66-70			0 986 474 778		← 54
							0 986 474 779		→ 54
			01.93-02.96	76			0 986 474 778		← 54
							0 986 474 779		→ 54
	416 GSi 16V	ABO	05.95-03.00	82-85/90-96			0 986 473 088		← 54
	416 GTi 16V						0 986 474 088		→ 54
	416 i 16V	ABS	04.90-03.00	82-85/90-96			0 986 474 778		← 54
							0 986 474 779		→ 54
	418 D 1.9	ABO	09.91-04.95	49			0 986 474 776		← 54
							0 986 474 777		→ 54
	418 D 1.9	ABS	09.91-02.96	49/65			0 986 474 778		← 54
	418 TD						0 986 474 779		→ 54
	418 TD	ABO	09.91-04.95	65			0 986 474 776		← 54
							0 986 474 777		→ 54
			05.95-02.96	65			0 986 473 088		← 54
							0 986 474 088		→ 54
	420 i Turbo 16V	ABO	05.95-03.00	63/77/100-103/147			0 986 473 088		← 54
	420 SD						0 986 474 088		→ 54
	420 SDI	ABS	02.92-03.00	63/77/100-103/147			0 986 474 778		← 54
	420 16V						0 986 474 779		→ 54

	414 Si 16V		05.95-03.00	76	Fg.-Nr. →AD 074464		0 986 475 808		→ 19,05
							0 986 475 809		← 19,05
	414 Si 16V		05.95-03.00	76	Fg.-Nr. AD 074465→		0 986 475 854		← 19,05
	414 16V						0 986 475 855		→ 19,05
	414 16V		04.90-04.95	66-70			0 986 475 808		→ 19,05
							0 986 475 809		← 19,05
			01.93-02.96	76			0 986 475 808		→ 19,05
							0 986 475 809		← 19,05
	416 GSi 16V		04.90-02.96	82-85			0 986 475 808		→ 19,05
							0 986 475 809		← 19,05
			05.95-02.96	82-85	Fg.-Nr. AD 074465→		0 986 475 854		← 19,05
							0 986 475 855		→ 19,05







































		S							
◀ ROVER Serie 400									
416 GTi 16V	04.90-02.96	90-96					0986 475 808	→	19,05
	05.95-02.96	90-96	Fg.-Nr. AD 074465→				0986 475 809	←	19,05
416 i 16V	05.95-02.96	82	Fg.-Nr. →AD 074464				0986 475 854	←	19,05
							0986 475 855	→	19,05
		83	Fg.-Nr. →AD 074464				0986 475 808	→	19,05
							0986 475 809	←	19,05
	05.95-10.99	83	Fg.-Nr. AD 074465→				0986 475 808	→	19,05
							0986 475 854	←	19,05
	05.95-03.00	82	Fg.-Nr. AD 074465→				0986 475 855	→	19,05
							0986 475 854	←	19,05
418 D 1.9	09.91-04.95	49					0986 475 808	→	19,05
							0986 475 809	←	19,05
418 TD	09.91-02.96	65					0986 475 808	→	19,05
							0986 475 809	←	19,05
	05.95-02.96	65	Fg.-Nr. AD 074465→				0986 475 854	←	19,05
						0986 475 855	→	19,05	
414 Si 16V	04.90-03.00	66-70/76					0986 474 780	↔	30,2
							0986 474 781	↔	30,2
416 GSi 16V, GTi 16V, i 16V	04.90-03.00	82-85/ 90-96					0986 474 780	↔	30,2
							0986 474 781	↔	30,2
418 D 1.9	09.91-02.96	49/65					0986 474 780	↔	30,2
418 TD							0986 474 781	↔	30,2
420 i Turbo 16V, SD, SDI, 16V	02.92-03.00	63/77/ 100-103/147					0986 474 780	↔	30,2
							0986 474 781	↔	30,2
414 Si 16V	05.95-03.00	76			STB		1987 477 513	→	1510
	05.95-03.00	76			STB		1987 477 512	←	1485
414 16V			Fg.-Nr. WD 250029→				1987 482 119	→	1655
			WD 322148				1987 482 120	←	1636
			Fg.-Nr. WD 322149→				1987 482 120	←	1636
414 16V	04.90-04.95	66-70			STB		1987 477 788	→	1531
					4SB		1987 477 789	←	1506
							1987 477 736	→	1678
							1987 477 738	←	1653
	01.93-04.95	76			STB		1987 477 788	→	1531
					4SB		1987 477 789	←	1506
						1987 477 736	→	1678	
						1987 477 738	←	1653	
416 GSi 16V	05.95-02.96	76			STB		1987 477 513	→	1510
	04.90-04.95	82-85			STB		1987 477 788	→	1531
					4SB		1987 477 789	←	1506
							1987 477 736	→	1678
							1987 477 738	←	1653
	05.95-02.96	82-85			STB		1987 477 512	←	1485
							1987 477 513	→	1510
				Fg.-Nr. WD 250029→WD 322148			1987 482 119	→	1655
			WD 322148			1987 482 120	←	1636	
416 GTi 16V			Fg.-Nr. WD 322149→				1987 482 120	←	1636
	04.90-04.95	90-96			STB		1987 477 788	→	1531
					4SB		1987 477 789	←	1506
							1987 477 736	→	1678
							1987 477 738	←	1653
	05.95-02.96	90-96			STB		1987 477 512	←	1485
						1987 477 513	→	1510	
			Fg.-Nr. WD 250029→WD 322148			1987 482 119	→	1655	
			WD 322148			1987 482 120	←	1636	
			Fg.-Nr. WD 322149→				1987 482 120	←	1636

		S								
416i 16V		05.95-10.99	83			STB	1 987 477 788	→ 1531		
							1 987 477 789	← 1506		
						4SB	1 987 477 736	→ 1678		
							1 987 477 738	← 1653		
		05.95-03.00	82			STB	1 987 477 788	→ 1531		
							1 987 477 789	← 1506		
						4SB	1 987 477 736	→ 1678		
							1 987 477 738	← 1653		
418 D 1.9		09.91-04.95	49			STB	1 987 477 788	→ 1531		
							1 987 477 789	← 1506		
						4SB	1 987 477 736	→ 1678		
							1 987 477 738	← 1653		
418 TD		09.91-04.95	65			STB	1 987 477 788	→ 1531		
							1 987 477 789	← 1506		
						4SB	1 987 477 736	→ 1678		
							1 987 477 738	← 1653		
		05.95-02.96	65			STB	1 987 477 512	← 1485		
							1 987 477 513	→ 1510		
							Fg.-Nr. WD 250029→WD 322148	1 987 482 119	→ 1655	
							1 987 482 120	← 1636		
							Fg.-Nr. WD 322149→	1 987 482 120	← 1636	
420i Turbo 16V		02.92-04.95	100-103/ 147			STB	1 987 477 788	→ 1531		
							1 987 477 789	← 1506		
420 16V						4SB	1 987 477 736	→ 1678		
							1 987 477 738	← 1653		
		05.95-02.96	100-103/ 147			STB	1 987 477 512	← 1485		
							1 987 477 513	→ 1510		
							Fg.-Nr. WD 250029→WD 322148	1 987 482 119	→ 1655	
							1 987 482 120	← 1636		
							Fg.-Nr. WD 322149→	1 987 482 120	← 1636	
420 SD		10.95-03.00	63/77/100			STB	1 987 477 512	← 1485		
							1 987 477 513	→ 1510		
420 SDI							Fg.-Nr. WD 250029→WD 322148	1 987 482 119	→ 1655	
							1 987 482 120	← 1636		
420 16V							Fg.-Nr. WD 322149→	1 987 482 120	← 1636	
 414 Si 16V		05.95-03.00	76			LAB	0 265 006 258 <sup>3</sup>			
							RAB	0 265 006 259 <sup>3</sup>		
							4SB,RAB	0 265 006 268 <sup>4</sup>		
414 Si 16V, 16V		05.95-03.00	76			4SB,LAB	0 265 006 267 <sup>4</sup>			
414 16V		04.90-04.95	66-70			LAB	0 265 006 474 <sup>3</sup>			
								0 265 006 476 <sup>4</sup>		
							RAB	0 265 006 473 <sup>3</sup>		
								0 265 006 475 <sup>4</sup>		
									0 265 006 474 <sup>3</sup>	
									0 265 006 473 <sup>3</sup>	
		01.93-04.95	76			LAB		0 265 006 474 <sup>3</sup>		
									0 265 006 476 <sup>4</sup>	
									0 265 006 473 <sup>3</sup>	
						RAB		0 265 006 475 <sup>4</sup>		
									0 265 006 473 <sup>3</sup>	
									0 265 006 474 <sup>3</sup>	
		05.95-02.96	76			GS,LAB		0 265 006 258 <sup>3</sup>		
									0 265 006 259 <sup>3</sup>	
									0 265 006 268 <sup>4</sup>	
416 GSi 16V		04.90-02.96	82-85			LAB		0 265 006 476 <sup>4</sup>		
									0 265 006 475 <sup>4</sup>	
		05.95-02.96	82-85			GS,LAB		0 265 006 258 <sup>3</sup>		
									0 265 006 259 <sup>3</sup>	
						4SB,LAB		0 265 006 267 <sup>4</sup>		
									0 265 006 268 <sup>4</sup>	
416 GTi 16V		04.90-02.96	90-96			LAB		0 265 006 476 <sup>4</sup>		
									0 265 006 475 <sup>4</sup>	
		05.95-02.96	90-96			GS,LAB		0 265 006 258 <sup>3</sup>		
									0 265 006 259 <sup>3</sup>	
						4SB,LAB		0 265 006 267 <sup>4</sup>		
									0 265 006 268 <sup>4</sup>	
						4SB,RAB		0 265 006 268 <sup>4</sup>		



		S								
<b>ROVER Serie 400</b>										
<b>416 i 16V</b>	05.95-02.96	82	GS,LAB	0 265 006 258 <sup>3</sup>						
			GS,RAB	0 265 006 259 <sup>3</sup>						
		83	GS,LAB	0 265 006 258 <sup>3</sup>						
			GS,RAB	0 265 006 259 <sup>3</sup>						
	05.95-10.99	83	4SB,LAB	0 265 006 267 <sup>4</sup>						
			4SB,RAB	0 265 006 268 <sup>4</sup>						
	05.95-03.00	82	4SB,LAB	0 265 006 267 <sup>4</sup>						
			4SB,RAB	0 265 006 268 <sup>4</sup>						
	03.96-10.99	83	LAB	0 265 006 305 <sup>3</sup>						
			RAB	0 265 006 306 <sup>3</sup>						
	03.96-03.00	82	LAB	0 265 006 305 <sup>3</sup>						
			RAB	0 265 006 306 <sup>3</sup>						
	<b>418 D 1.9</b>	09.91-04.95	49	LAB	0 265 006 474 <sup>3</sup>					
					0 265 006 476 <sup>4</sup>					
RAB				0 265 006 473 <sup>3</sup>						
				0 265 006 475 <sup>4</sup>						
<b>418 TD</b>	09.91-04.95	65	LAB	0 265 006 474 <sup>3</sup>						
				0 265 006 476 <sup>4</sup>						
			RAB	0 265 006 473 <sup>3</sup>						
				0 265 006 475 <sup>4</sup>						
	05.95-02.96	65	GS,LAB	0 265 006 258 <sup>3</sup>						
			GS,RAB	0 265 006 259 <sup>3</sup>						
			4SB,LAB	0 265 006 267 <sup>4</sup>						
			4SB,RAB	0 265 006 268 <sup>4</sup>						
<b>420 i Turbo 16V</b>	02.92-04.95	100-103/ 147	LAB	0 265 006 474 <sup>3</sup>						
				0 265 006 476 <sup>4</sup>						
<b>420 16V</b>	05.95-02.96	100-103/ 147	GS,LAB	0 265 006 258 <sup>3</sup>						
			GS,RAB	0 265 006 259 <sup>3</sup>						
			4SB,LAB	0 265 006 267 <sup>4</sup>						
			4SB,RAB	0 265 006 268 <sup>4</sup>						
	10.95-03.00	63/77/100	GS,LAB	0 265 006 258 <sup>3</sup>						
			GS,RAB	0 265 006 259 <sup>3</sup>						
<b>420 SD</b>			4SB,LAB	0 265 006 267 <sup>4</sup>						
<b>420 SDI</b>			4SB,RAB	0 265 006 268 <sup>4</sup>						
<b>420 16V</b>			4SB,RAB	0 265 006 268 <sup>4</sup>						
<b>Serie 400 Coupé</b>										
	<b>418 GSi 16V</b>	ABO	01.97-12.98	107		0 986 473 088		← 54		
						0 986 474 088		→ 54		
		ABS	01.97-12.98	107		0 986 474 778		← 54		
						0 986 474 779		→ 54		
	<b>418 GSi 16V</b>	01.97-12.98	107		0 986 475 808		→ 19,05			
					0 986 475 809		← 19,05			
					Fg.-Nr. AD 074465→	0 986 475 854		← 19,05		
						0 986 475 855		→ 19,05		
	<b>418 GSi 16V</b>	01.97-12.98	107		0 986 474 780		← 30,2			
					0 986 474 781		→ 30,2			
	<b>418 GSi 16V</b>	01.97-12.98	107		STB	1 987 477 512		← 1485		
						1 987 477 513		→ 1510		
					Fg.-Nr. WD 250029→WD 322148	1 987 482 119		→ 1655		
					Fg.-Nr. WD 322149→	1 987 482 120		← 1636		
					1 987 482 120		← 1636			

		<b>S</b>								
	<b>418</b> GSi 16V	01.97-12.98	107			GS,LAB	0 265 <b>006 258</b> <sup>3</sup>			
						GS,RAB	0 265 <b>006 259</b> <sup>3</sup>			
						4SB,LAB	0 265 <b>006 267</b> <sup>4</sup>			
						4SB,RAB	0 265 <b>006 268</b> <sup>4</sup>			
<b>Serie 400 Tourer</b>										
										
	<b>416</b> GSi 16V	ABO 05.95-03.00	82-85/				0 986 <b>473 088</b>		← 54	
	<b>416</b> GTi 16V		90-96				0 986 <b>474 088</b>		→ 54	
	<b>416</b> i 16V	ABS 04.90-03.00	82-85/				0 986 <b>474 778</b>		← 54	
			90-96				0 986 <b>474 779</b>		→ 54	
	<b>418</b> D 1.9	ABO 09.91-04.95	49				0 986 <b>474 776</b>		← 54	
							0 986 <b>474 777</b>		→ 54	
		ABS 09.91-04.95	49				0 986 <b>474 778</b>		← 54	
							0 986 <b>474 779</b>		→ 54	
	<b>418</b> i 16V	ABO 02.96-03.00	65/107				0 986 <b>473 088</b>		← 54	
	<b>418</b> TD						0 986 <b>474 088</b>		→ 54	
		ABS 02.96-03.00	65/107				0 986 <b>474 778</b>		← 54	
							0 986 <b>474 779</b>		→ 54	
										
	<b>416</b> GSi 16V	04.90-02.96	82-85/				0 986 <b>475 808</b>		→ 19,05	
	<b>416</b> GTi 16V		90-96				0 986 <b>475 809</b>		← 19,05	
		05.95-02.96	82-85/	Fg.-Nr. AD 074465→			0 986 <b>475 854</b>		← 19,05	
			90-96				0 986 <b>475 855</b>		→ 19,05	
	<b>416</b> i 16V	03.96-03.00	82				0 986 <b>475 854</b>		← 19,05	
							0 986 <b>475 855</b>		→ 19,05	
	<b>418</b> D 1.9	09.91-04.95	49				0 986 <b>475 808</b>		→ 19,05	
							0 986 <b>475 809</b>		← 19,05	
	<b>418</b> i 16V	03.96-03.00	65/107				0 986 <b>475 854</b>		← 19,05	
	<b>418</b> TD						0 986 <b>475 855</b>		→ 19,05	
										
	<b>416</b> GSi 16V, GTi 16V, i 16V		04.90-03.00	82-85/				0 986 <b>474 780</b>		← 30,2
			90-96				0 986 <b>474 781</b>		→ 30,2	
<b>418</b> D 1.9		09.91-04.95	49				0 986 <b>474 780</b>		← 30,2	
							0 986 <b>474 781</b>		→ 30,2	
<b>418</b> i 16V		02.96-03.00	65/107				0 986 <b>474 780</b>		← 30,2	
<b>418</b> TD							0 986 <b>474 781</b>		→ 30,2	
										
	<b>416</b> GSi 16V	04.90-04.95	82-85/			STB	1 987 <b>477 788</b>		→ 1531	
	<b>416</b> GTi 16V		90-96				1 987 <b>477 789</b>		← 1506	
						4SB	1 987 <b>477 736</b>		→ 1678	
							1 987 <b>477 738</b>		← 1653	
		05.95-02.96	82-85/			STB	1 987 <b>477 512</b>		← 1485	
			90-96				1 987 <b>477 513</b>		→ 1510	
						Fg.-Nr. WD 250029→WD 322148	1 987 <b>482 119</b>		→ 1655	
							1 987 <b>482 120</b>		← 1636	
						Fg.-Nr. WD 322149→	1 987 <b>482 120</b>		← 1636	
	<b>416</b> i 16V	02.96-03.00	82			STB	1 987 <b>477 788</b>		→ 1531	
							1 987 <b>477 789</b>		← 1506	
						4SB	1 987 <b>477 736</b>		→ 1678	
							1 987 <b>477 738</b>		← 1653	
	<b>418</b> D 1.9	09.91-04.95	49			STB	1 987 <b>477 788</b>		→ 1531	
							1 987 <b>477 789</b>		← 1506	
						4SB	1 987 <b>477 736</b>		→ 1678	
							1 987 <b>477 738</b>		← 1653	
	<b>418</b> i 16V	02.96-03.00	65/107			STB	1 987 <b>477 788</b>		→ 1531	
<b>418</b> TD						1 987 <b>477 789</b>		← 1506		





















































ROVER Serie 400 Tourer

	<b>418 i 16V</b>	02.96-03.00	65/107	4SB	1987 <b>477 736</b>	→ 1678
	<b>418 TD</b>				1987 <b>477 738</b>	← 1653
	<b>416 GSi 16V</b>	04.90-02.96	82-85/ 90-96	LAB	0 265 <b>006 476<sup>4</sup></b>	
	<b>416 GTi 16V</b>	05.95-02.96	82-85/ 90-96	RAB	0 265 <b>006 475<sup>4</sup></b>	
				GS,LAB	0 265 <b>006 258<sup>3</sup></b>	
				GS,RAB	0 265 <b>006 259<sup>3</sup></b>	
				4SB,LAB	0 265 <b>006 267<sup>4</sup></b>	
				4SB,RAB	0 265 <b>006 268<sup>4</sup></b>	
	<b>416 i 16V</b>	02.96-03.00	82	4SB,LAB	0 265 <b>006 267<sup>4</sup></b>	
		03.96-03.00	82	4SB,RAB	0 265 <b>006 268<sup>4</sup></b>	
				LAB	0 265 <b>006 305<sup>3</sup></b>	
				RAB	0 265 <b>006 306<sup>3</sup></b>	
	<b>418 D 1.9</b>	09.91-04.95	49	LAB	0 265 <b>006 474<sup>3</sup></b>	
					0 265 <b>006 476<sup>4</sup></b>	
				RAB	0 265 <b>006 473<sup>3</sup></b>	
					0 265 <b>006 475<sup>4</sup></b>	
	<b>418 i 16V</b>	02.96-03.00	65/107	4SB,LAB	0 265 <b>006 267<sup>4</sup></b>	
	<b>418 TD</b>	03.96-03.00	65/107	4SB,RAB	0 265 <b>006 268<sup>4</sup></b>	
				LAB	0 265 <b>006 305<sup>3</sup></b>	
				RAB	0 265 <b>006 306<sup>3</sup></b>	

Serie 600



	<b>618 i 16V</b>	ABO	03.96-06.99	85	AG	0986 <b>474 784</b>	← 57,15
						0986 <b>474 785</b>	→ 57,15
					GS	0986 <b>473 242</b>	← 57
						0986 <b>474 242</b>	→ 57
		ABS	03.96-06.99	85	AG	0986 <b>474 784</b>	← 57,15
						0986 <b>474 785</b>	→ 57,15
					GS	0986 <b>473 242</b>	← 57
						0986 <b>474 242</b>	→ 57
	<b>620 i 16V</b>	ABO	04.93-06.96	85	AG	0986 <b>474 784</b>	← 57,15
						0986 <b>474 785</b>	→ 57,15
					GS	0986 <b>473 242</b>	← 57
						0986 <b>474 242</b>	→ 57
			04.93-06.99	96	AG	0986 <b>474 784</b>	← 57,15
						0986 <b>474 785</b>	→ 57,15
					GS	0986 <b>473 242</b>	← 57
						0986 <b>474 242</b>	→ 57
			09.95-09.00	100	AG	0986 <b>474 784</b>	← 57,15
						0986 <b>474 785</b>	→ 57,15
					GS	0986 <b>473 242</b>	← 57
						0986 <b>474 242</b>	→ 57
		ABS	04.93-06.96	85	AG	0986 <b>474 784</b>	← 57,15
						0986 <b>474 785</b>	→ 57,15
					GS	0986 <b>473 242</b>	← 57
						0986 <b>474 242</b>	→ 57
			04.93-06.99	96	AG	0986 <b>474 784</b>	← 57,15
						0986 <b>474 785</b>	→ 57,15
					GS	0986 <b>473 242</b>	← 57
						0986 <b>474 242</b>	→ 57
			09.95-09.00	100	AG	0986 <b>474 784</b>	← 57,15
						0986 <b>474 785</b>	→ 57,15
					GS	0986 <b>473 242</b>	← 57
						0986 <b>474 242</b>	→ 57
	<b>620 i 16V Turbo</b>	ABO	04.93-12.98	147	GS	0986 <b>474 784</b>	← 57,15
						0986 <b>474 785</b>	→ 57,15
		ABS	04.93-12.98	147	GS	0986 <b>474 784</b>	← 57,15
						0986 <b>474 785</b>	→ 57,15
	<b>620 SDi</b>	ABO	03.95-12.98	77		0986 <b>473 242</b>	← 57
						0986 <b>474 242</b>	→ 57

		S							
									
620 SDi		ABS	03.95-12.98	77			0 986 473 242	 ← 57	
							0 986 474 242	 → 57	
623 i 16V		ABO	04.93-06.99	116		GS	0 986 474 784	 ← 57,15	
							0 986 474 785	 → 57,15	
		ABS	04.93-06.99	116		GS	0 986 474 784	 ← 57,15	
							0 986 474 785	 → 57,15	
									
 618 i 16V			03.96-06.99	85			0 986 474 787	 ← 34	
							0 986 474 786	 → 34	
620 i 16V, i 16V Turbo, SDi			04.93-09.00	77/85/96/ 100/147			0 986 474 787	 ← 34	
							0 986 474 786	 → 34	
623 i 16V			04.93-06.99	116			0 986 474 787	 ← 34	
							0 986 474 786	 → 34	
									
 618 i 16V			03.96-06.99	85			1 987 477 602	← 1870	
							1 987 477 673	→ 1870	
620 i 16V, i 16V Turbo, SDi			04.93-09.00	77/85/96/ 100/147			1 987 477 602	← 1870	
							1 987 477 673	→ 1870	
623 i 16V			04.93-06.99	116			1 987 477 602	← 1870	
							1 987 477 673	→ 1870	
 620 i 16V Turbo			04.93-12.98	77/147	Fg.-Nr. →AM 246796	LAB	0 265 006 168 <sup>3</sup>		
620 SDi							0 265 006 170 <sup>4</sup>		
						RAB	0 265 006 167 <sup>3</sup>		
							0 265 006 169 <sup>4</sup>		
<b>Serie 800</b>									
									
 820 i 16V			01.92-09.99	100-103/ 132-147	Fg.-Nr. 200605→		0 986 474 788	 ← 57	
							0 986 474 789	 → 57	
825 i, i Coupé, TD			01.96-12.98	92/129			0 986 474 788	 ← 57	
							0 986 474 789	 → 57	
825 TD			10.91-12.98	87/88	Fg.-Nr. 200605→		0 986 474 788	 ← 57	
							0 986 474 789	 → 57	
827 i 24V			01.92-01.96	124-130	Fg.-Nr. 152057→		0 986 474 788	 ← 57	
827 i 24V Coupé							0 986 474 789	 → 57	
					Fg.-Nr. 273333→152056		0 986 474 792	 ← 57	
							0 986 474 793	 → 57	
									
 820 i 16V			01.92-09.99	100-103/ 132-147	Fg.-Nr. RS 100318→		0 986 474 790	 ← 38	
							0 986 474 791	 → 38	
825 i, i Coupé, TD			10.91-12.98	87/88/92/ 129	Fg.-Nr. RS 100318→		0 986 474 790	 ← 38	
							0 986 474 791	 → 38	
827 i 24V			01.92-01.96	124-130	Fg.-Nr. RS 100318→		0 986 474 790	 ← 38	
827 i 24V Coupé							0 986 474 791	 → 38	
									
 820 i 16V			01.92-09.99	100-103/132-147			1 987 477 672	↔ 1815	
							1 987 477 672	↔ 1815	
825 i			01.96-12.98	87/88/92/129			1 987 477 672	↔ 1815	
825 i Coupé			01.96-12.98	87/88/92/129			1 987 477 672	↔ 1815	
825 TD			10.91-12.98	87/88/92/129			1 987 477 672	↔ 1815	
827 i 24V			01.92-01.96	124-130			1 987 477 672	↔ 1815	
827 i 24V Coupé			01.92-01.96	124-130			1 987 477 672	↔ 1815	





◀ ROVER Serie 800

	820 i 16V	01.92-09.99	100-103/	LAB	0 265 006 104 <sup>3</sup>	
	820 i 16V Turbo		132-147	RAB	0 265 006 106 <sup>4</sup>	
					0 265 006 103 <sup>3</sup>	
					0 265 006 105 <sup>4</sup>	
	825 i	10.91-12.98	87/88/92/	LAB	0 265 006 104 <sup>3</sup>	
	825 i Coupé		129		0 265 006 106 <sup>4</sup>	
	825 TD			RAB	0 265 006 103 <sup>3</sup>	
					0 265 006 105 <sup>4</sup>	
	827 i 24V	01.92-01.96	124-130	LAB	0 265 006 104 <sup>3</sup>	
	827 i 24V Coupé			RAB	0 265 006 106 <sup>4</sup>	
					0 265 006 103 <sup>3</sup>	
					0 265 006 105 <sup>4</sup>	

25

































	1.1 i 16V	ABO	02.03-05.05	55	0 986 473 088	← 54
					0 986 474 088	→ 54
		ABS	02.03-05.05	55	0 986 474 778	← 54
					0 986 474 779	→ 54
	1.4 i 16V	ABO	02.00-05.05	62/76	0 986 473 088	← 54
					0 986 474 088	→ 54
		ABS	02.00-05.05	62/76	0 986 474 778	← 54
					0 986 474 779	→ 54
	1.6 i 16V	ABO	02.00-05.05	80	0 986 473 088	← 54
					0 986 474 088	→ 54
		ABS	02.00-05.05	80	0 986 474 778	← 54
					0 986 474 779	→ 54
	1.8 i 16V	ABO	02.00-10.04	86/107	0 986 473 088	← 54
					0 986 474 088	→ 54
		ABS	02.00-10.04	86/107	0 986 474 778	← 54
					0 986 474 779	→ 54
	2.0 iDT	ABO	02.00-05.05	74/83	0 986 473 088	← 54
					0 986 474 088	→ 54
		ABS	02.00-05.05	74/83	0 986 474 778	← 54
					0 986 474 779	→ 54



	1.1 i 16V		02.03-05.05	55	0 986 475 854	← 19,05
					0 986 475 855	→ 19,05
	1.4 i 16V		02.00-05.05	62/76	0 986 475 854	← 19,05
					0 986 475 855	→ 19,05
	1.6 i 16V		02.00-05.05	80	0 986 475 854	← 19,05
					0 986 475 855	→ 19,05
	1.8 i 16V		02.00-10.04	86/107	0 986 475 854	← 19,05
					0 986 475 855	→ 19,05
	2.0 iDT		02.00-05.05	74/83	0 986 475 854	← 19,05
					0 986 475 855	→ 19,05







































	1.1 i 16V		02.03-05.05	55	0 986 474 780	← 30,2
					0 986 474 781	→ 30,2
	1.4 i 16V		02.00-05.05	62/76	0 986 474 780	← 30,2
					0 986 474 781	→ 30,2
	1.6 i 16V		02.00-05.05	80	0 986 474 780	← 30,2
					0 986 474 781	→ 30,2
	1.8 i 16V		02.00-10.04	86/107	0 986 474 780	← 30,2
					0 986 474 781	→ 30,2
	2.0 iDT		02.00-05.05	74/83	0 986 474 780	← 30,2
					0 986 474 781	→ 30,2

		S							
									
	1.1i 16V	02.03-05.05	55		4SB		1 987 477 888	→ 1812	
							1 987 477 889	← 1782	
					Fg.-Nr. →XD 454425	HTB	1 987 477 886	→ 1713	
							1 987 477 887	← 1743	
	1.4i 16V	02.00-05.05	62/76		4SB		1 987 477 888	→ 1812	
							1 987 477 889	← 1782	
					Fg.-Nr. →XD 454425	HTB	1 987 477 886	→ 1713	
							1 987 477 887	← 1743	
	1.6i 16V	02.00-05.05	80		4SB		1 987 477 888	→ 1812	
							1 987 477 889	← 1782	
					Fg.-Nr. →XD 454425	HTB	1 987 477 886	→ 1713	
							1 987 477 887	← 1743	
	1.8i 16V	02.00-10.04	86/107		4SB		1 987 477 888	→ 1812	
							1 987 477 889	← 1782	
					Fg.-Nr. →XD 454425	HTB	1 987 477 886	→ 1713	
							1 987 477 887	← 1743	
	2.0iDT	02.00-05.05	74/83		4SB		1 987 477 888	→ 1812	
							1 987 477 889	← 1782	
					Fg.-Nr. →XD 454425	HTB	1 987 477 886	→ 1713	
							1 987 477 887	← 1743	
	1.1i 16V	02.03-05.05	55		LAB		0 265 006 305 <sup>3</sup>		
					RAB		0 265 006 306 <sup>3</sup>		
					Fg.-Nr. →YD 471564	4SB	0 265 006 307 <sup>4</sup>		
	1.4i 16V	02.00-05.05	62/76		LAB		0 265 006 305 <sup>3</sup>		
					RAB		0 265 006 306 <sup>3</sup>		
					Fg.-Nr. →YD 471564	4SB	0 265 006 307 <sup>4</sup>		
	1.6i 16V	02.00-05.05	80		LAB		0 265 006 305 <sup>3</sup>		
					RAB		0 265 006 306 <sup>3</sup>		
					Fg.-Nr. →YD 471564	4SB	0 265 006 307 <sup>4</sup>		
	1.8i 16V	02.00-10.04	86/107		LAB		0 265 006 305 <sup>3</sup>		
					RAB		0 265 006 306 <sup>3</sup>		
					Fg.-Nr. →YD 471564	4SB	0 265 006 307 <sup>4</sup>		
	2.0iDT	02.00-05.05	74/83		LAB		0 265 006 305 <sup>3</sup>		
					RAB		0 265 006 306 <sup>3</sup>		
					Fg.-Nr. →YD 471564	4SB	0 265 006 307 <sup>4</sup>		
<b>45</b>									
									
	1.4 16V	02.00-05.05	76		INB		0 986 474 778	 ← 54	
							0 986 474 779	 → 54	
					INB		0 986 473 088	 ← 54	
							0 986 474 088	 → 54	
	1.6 16V	02.00-05.05	80		INB		0 986 474 778	 ← 54	
							0 986 474 779	 → 54	
					INB		0 986 473 088	 ← 54	
							0 986 474 088	 → 54	
	1.8 16V	02.00-05.05	86		INB		0 986 474 778	 ← 54	
							0 986 474 779	 → 54	
					INB		0 986 473 088	 ← 54	
							0 986 474 088	 → 54	
	2.0iDT	02.00-05.05	74/83/110		INB		0 986 474 778	 ← 54	
	2.0V6						0 986 474 779	 → 54	
					INB		0 986 473 088	 ← 54	
							0 986 474 088	 → 54	
									
	1.4 16V	02.00-05.05	76		Fg.-Nr. →AD 074464		0 986 475 808	→ 19,05	
							0 986 475 809	← 19,05	





		S							
	◀ ROVER 45								
1.4 16V	02.00-05.05	76	Fg.-Nr. AD 074465→YD 558484	0986 475 854	← 19,05				
				0986 475 855	→ 19,05				
1.6 16V	02.00-05.05	80	Fg.-Nr. →AD 074464	0986 475 808	→ 19,05				
			Fg.-Nr. AD 074465→YD 558484	0986 475 809	← 19,05				
				0986 475 854	← 19,05				
				0986 475 855	→ 19,05				
1.8 16V	02.00-05.05	86	Fg.-Nr. →AD 074464	0986 475 808	→ 19,05				
			Fg.-Nr. AD 074465→YD 558484	0986 475 809	← 19,05				
				0986 475 854	← 19,05				
				0986 475 855	→ 19,05				
2.0 iDT	02.00-05.05	74/83/110	Fg.-Nr. →AD 074464	0986 475 808	→ 19,05				
2.0 V6			Fg.-Nr. AD 074465→YD 558484	0986 475 809	← 19,05				
				0986 475 854	← 19,05				
				0986 475 855	→ 19,05				
	1.4 16V	02.00-05.05	76	0986 474 780	← 30,2				
				0986 474 781	→ 30,2				
	1.6 16V	02.00-05.05	80	0986 474 780	← 30,2				
				0986 474 781	→ 30,2				
	1.8 16V	02.00-05.05	86	0986 474 780	← 30,2				
				0986 474 781	→ 30,2				
	2.0 iDT	02.00-05.05	74/83/110	0986 474 780	← 30,2				
	2.0 V6			0986 474 781	→ 30,2				
	1.4 16V	02.00-05.05	76	STB	1987 477 512	← 1485			
					1987 477 513	→ 1510			
			Fg.-Nr. WD 250029→	1987 482 119	→ 1655				
			WD 322148	1987 482 120	← 1636				
			Fg.-Nr. WD 322149→	1987 482 120	← 1636				
	1.6 16V	02.00-05.05	80	STB	1987 477 512	← 1485			
					1987 477 513	→ 1510			
			Fg.-Nr. WD 250029→	1987 482 119	→ 1655				
			WD 322148	1987 482 120	← 1636				
			Fg.-Nr. WD 322149→	1987 482 120	← 1636				
	1.8 16V	02.00-05.05	86	STB	1987 477 512	← 1485			
					1987 477 513	→ 1510			
			Fg.-Nr. WD 250029→	1987 482 119	→ 1655				
			WD 322148	1987 482 120	← 1636				
			Fg.-Nr. WD 322149→	1987 482 120	← 1636				
	2.0 iDT	02.00-05.05	74/83/110	STB	1987 477 512	← 1485			
	2.0 V6				1987 477 513	→ 1510			
			Fg.-Nr. WD 250029→	1987 482 119	→ 1655				
			WD 322148	1987 482 120	← 1636				
			Fg.-Nr. WD 322149→	1987 482 120	← 1636				
	1.4 16V	02.00-05.05	76	LAB	0265 006 258 <sup>3</sup>				
				RAB	0265 006 259 <sup>3</sup>				
				4SB,LAB	0265 006 267 <sup>4</sup>				
				4SB,RAB	0265 006 268 <sup>4</sup>				
	1.6 16V	02.00-05.05	80	LAB	0265 006 258 <sup>3</sup>				
				RAB	0265 006 259 <sup>3</sup>				
				4SB,LAB	0265 006 267 <sup>4</sup>				
				4SB,RAB	0265 006 268 <sup>4</sup>				
	1.8 16V	02.00-05.05	86	LAB	0265 006 258 <sup>3</sup>				
				RAB	0265 006 259 <sup>3</sup>				
				4SB,LAB	0265 006 267 <sup>4</sup>				
				4SB,RAB	0265 006 268 <sup>4</sup>				
	2.0 iDT	02.00-05.05	74/83/110	LAB	0265 006 258 <sup>3</sup>				
	2.0 V6			RAB	0265 006 259 <sup>3</sup>				
				4SB,LAB	0265 006 267 <sup>4</sup>				
				4SB,RAB	0265 006 268 <sup>4</sup>				

		S							
<b>75</b>									
									
	<b>4.6 i Power</b>	10.03-05.05	191				0 986 473 990	 ← 57	
							0 986 474 990	 → 57	
									
	<b>1.8 i T 16V, i 16V</b>	01.99-05.05	88/110				1 987 477 885		1570
	<b>2.0 CDT, CDTi, i 24V</b>	01.99-05.05	85/96/110				1 987 477 885		1570
	<b>2.5 i 24V</b>	01.99-05.05	130				1 987 477 885		1570
	<b>1.8 i T 16V</b>	01.99-05.05	88/110				0 986 594 538 <sup>3</sup>		
	<b>1.8 i 16V</b>						0 986 594 539 <sup>4</sup>		
	<b>2.0 CDT, CDTi, i 24V</b>	01.99-05.05	85/96/110				0 986 594 538 <sup>3</sup>		
							0 986 594 539 <sup>4</sup>		
	<b>2.5 i 24V</b>	01.99-05.05	130				0 986 594 538 <sup>3</sup>		
							0 986 594 539 <sup>4</sup>		
	<b>4.6 i Power</b>	10.03-05.05	191				0 986 594 538 <sup>3</sup>		
<b>75 Tourer</b>									
									
	<b>4.6 i Power</b>	10.03-05.05	191				0 986 473 990	 ← 57	
							0 986 474 990	 → 57	
									
	<b>1.8 i T 16V, i 16V</b>	01.01-05.05	88/110				1 987 477 885		1570
	<b>2.0 CDT, CDTi, i 24V</b>	01.01-05.05	85/96/110				1 987 477 885		1570
	<b>2.5 i 24V</b>	01.01-05.05	130				1 987 477 885		1570
	<b>1.8 i T 16V</b>	01.01-05.05	88/110				0 986 594 538 <sup>3</sup>		
	<b>1.8 i 16V</b>						0 986 594 539 <sup>4</sup>		
	<b>2.0 CDT, CDTi, i 24V</b>	01.01-05.05	85/96/110				0 986 594 538 <sup>3</sup>		
							0 986 594 539 <sup>4</sup>		
	<b>2.5 i 24V</b>	01.01-05.05	130				0 986 594 538 <sup>3</sup>		
							0 986 594 539 <sup>4</sup>		
	<b>4.6 i Power</b>	10.03-05.05	191				0 986 594 538 <sup>3</sup>		
<b>100 Metro</b>									
									
	<b>1.1</b>	05.90-12.98	44				0 986 474 770	 ← 48	
	<b>1.1 i</b>						0 986 474 771	 → 48	
	<b>1.4 D</b>	09.90-03.98	38/55				0 986 474 770	 ← 48	
	<b>1.4 i</b>						0 986 474 771	 → 48	
	<b>1.4 GTi 16V</b>	09.90-10.95	76				0 986 474 772	 ← 48	
							0 986 474 773	 → 48	
	<b>1.4 i 16V</b>	04.97-10.98	75				0 986 474 772	 ← 48	
							0 986 474 773	 → 48	
	<b>1.5 D</b>	12.94-12.98	42				0 986 474 770	 ← 48	
							0 986 474 771	 → 48	
									
	<b>1.1, i</b>	05.90-12.98	44				0 986 475 790	 ↔ 17,46	
	<b>1.4 D, GTi 16V, i</b>	09.90-03.98	38/55/76				0 986 475 790	 ↔ 17,46	
	<b>1.5 D</b>	12.94-12.98	42				0 986 475 790	 ↔ 17,46	



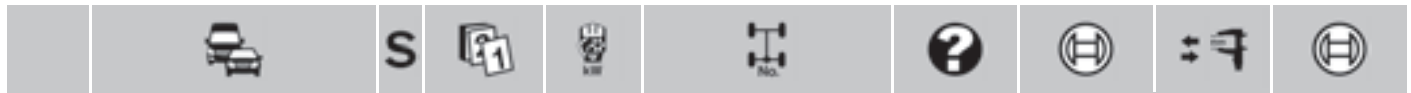

◀ ROVER 100 Metro



	1.1, i	05.90-12.98	44		1987 477 872	2183
	1.4 D, GTi 16V, i, i 16V	09.90-10.98	38/55/75/76		1987 477 872	2183
	1.5 D	12.94-12.98	42		1987 477 872	2183

100 Metro Cabrio



	1.1 i	09.90-12.97	44		0986 474 770	← 48
					0986 474 771	→ 48
	1.4 i	09.90-03.98	55		0986 474 770	← 48
					0986 474 771	→ 48
	1.4 i 16V	04.97-10.98	75		0986 474 772	← 48
					0986 474 773	→ 48



	1.1 i	09.90-12.97	44		0986 475 790	↔ 17,46
	1.4 i	09.90-03.98	55		0986 475 790	↔ 17,46



	1.1 i	09.90-12.97	44		1987 477 872	2183
	1.4 i, i 16V	09.90-10.98	55/75		1987 477 872	2183

SAAB (SAAB AUTOMOBILE AB)

9-3 Cabriolet [9400]



	2.0 i 16V	03.98-08.03	96/110/	Fg.-Nr. →X2020000, →X7020000	0986 473 056	← 57
	2.0 i 16V Turbo		113/136/		0986 474 056	→ 57
	2.0 T		147/151	Fg.-Nr. X2020001→, X7020001→	0986 473 062	← 57
	2.3 i 16V	03.98-08.00	110	Fg.-Nr. →X2020000, →X7020000	0986 473 056	← 57
					0986 474 056	→ 57
				Fg.-Nr. X2020001→, X7020001→	0986 473 062	← 57
	2.3 T	10.99-08.03	165-169		0986 473 062	← 57



	2.0 i 16V, i 16V Turbo, T	03.98-08.03	96/110/113/		0986 473 379	← 34,94
			136/147/151		0986 474 379	→ 34,94
	2.3 i 16V	03.98-08.03	110/		0986 473 379	← 34,94
	2.3 T		165-169		0986 474 379	→ 34,94

























































	2.0 i 16V, i 16V Turbo, T	03.98-08.03	96/110/113/136/147/151		1987 477 895	2180
	2.3 i 16V, T	03.98-08.03	110/165-169		1987 477 895	2180

	2.0 i 16V, i 16V Turbo, T	03.98-08.03	96/110/113/136/147/151		0 265 006 331 <sup>3</sup>	
	2.3 i 16V, T	03.98-08.03	110/165-169		0 265 006 331 <sup>3</sup>	

9-3 Cabriolet [9440]



	1.8 T	08.03-06.12	110/129	D85	0986 134 018	← 57
	1.8 T BioPower				0986 135 018	→ 57
				302	0986 134 081	← 57
					0986 135 081	→ 57
				31D	0986 135 056	← 60
					0986 134 056	→ 60

		S							
<b>1.9 TiD</b>			01.06-06.12	110/118/		D85	0 986 <b>134 018</b>	 ← 57	
<b>1.9 TTiD</b>				132			0 986 <b>135 018</b>	 → 57	
						302	0 986 <b>134 081</b>	 ← 57	
							0 986 <b>135 081</b>	 → 57	
						31D	0 986 <b>135 056</b>	 ← 60	
							0 986 <b>134 056</b>	 → 60	
<b>2.0 T</b>			08.03-06.12	120/		D85	0 986 <b>134 018</b>	 ← 57	
<b>2.0 T BioPower</b>				129-131/			0 986 <b>135 018</b>	 → 57	
<b>2.0 T 4x4</b>				145/147/		302	0 986 <b>134 081</b>	 ← 57	
				154			0 986 <b>135 081</b>	 → 57	
						31D	0 986 <b>135 056</b>	 ← 60	
							0 986 <b>134 056</b>	 → 60	
<b>2.8 T</b>			09.05-06.12	184-188/		D85	0 986 <b>134 018</b>	 ← 57	
				203-206			0 986 <b>135 018</b>	 → 57	
						302	0 986 <b>134 081</b>	 ← 57	
							0 986 <b>135 081</b>	 → 57	
						31D	0 986 <b>135 056</b>	 ← 60	
							0 986 <b>134 056</b>	 → 60	
									
 <b>1.8 T</b>			08.03-06.12	110/129		292	0 986 <b>473 992</b>	 ← 38	
<b>1.8 T BioPower</b>							0 986 <b>474 992</b>	 → 38	
<b>1.9 TiD</b>			01.06-06.12	110/118/		292	0 986 <b>473 992</b>	 ← 38	
<b>1.9 TTiD</b>				132			0 986 <b>474 992</b>	 → 38	
<b>2.0 T, T BioPower, T 4x4</b>			08.03-06.12	120/129-131/		292	0 986 <b>473 992</b>	 ← 38	
				145/147/154			0 986 <b>474 992</b>	 → 38	
<b>2.8 T</b>			09.05-06.12	184-188/		292	0 986 <b>473 992</b>	 ← 38	
				203-206			0 986 <b>474 992</b>	 → 38	
									
 <b>1.8 T, T BioPower</b>			08.03-06.12	110/129			1 987 <b>482 021</b>		1932
<b>1.9 TiD, TTiD</b>			01.06-06.12	110/118/132			1 987 <b>482 021</b>		1932
<b>2.0 T, T BioPower, T 4x4</b>			08.03-06.12	120/129-131/145/147/154			1 987 <b>482 021</b>		1932
<b>2.8 T</b>			09.05-06.12	184-188/203-206			1 987 <b>482 021</b>		1932
<b>9-3 Coupé [9400]</b>									
									
 <b>2.0 i 16V</b>			03.98-08.03	96/136/	Fg.-Nr. →X2020000, →X7020000		0 986 <b>473 056</b>	 ← 57	
<b>2.0 i 16V Turbo</b>				147/151			0 986 <b>474 056</b>	 → 57	
					Fg.-Nr. X2020001→, X7020001→		0 986 <b>473 062</b>	 ← 57	
<b>2.2 16V D Turbo</b>			11.00-09.02	92			0 986 <b>473 062</b>	 ← 57	
<b>2.3 i 16V Turbo</b>			09.99-08.00	165			0 986 <b>473 062</b>	 ← 57	
							0 986 <b>474 062</b>	 → 57	
									
 <b>2.0 i 16V</b>			03.98-08.03	96/136/			0 986 <b>473 379</b>	 ← 34,94	
<b>2.0 i 16V Turbo</b>				147/151			0 986 <b>474 379</b>	 → 34,94	
<b>2.2 16V D Turbo</b>			11.00-09.02	92			0 986 <b>473 379</b>	 ← 34,94	
							0 986 <b>474 379</b>	 → 34,94	
									
 <b>2.0 i 16V, i 16V Turbo</b>			03.98-08.03	96/136/147/151			1 987 <b>477 895</b>		2180
<b>2.2 16V D Turbo</b>			11.00-09.02	92			1 987 <b>477 895</b>		2180
<b>2.3 i 16V Turbo</b>			09.99-08.00	165			1 987 <b>477 895</b>		2180
 <b>2.0 i 16V, i 16V Turbo</b>			03.98-08.03	96/136/147/151			0 265 <b>006 331</b> <sup>3</sup>		
<b>2.2 16V D Turbo</b>			11.00-09.02	92			0 265 <b>006 331</b> <sup>3</sup>		
<b>2.3 i 16V Turbo</b>			09.99-08.00	165			0 265 <b>006 331</b> <sup>3</sup>		

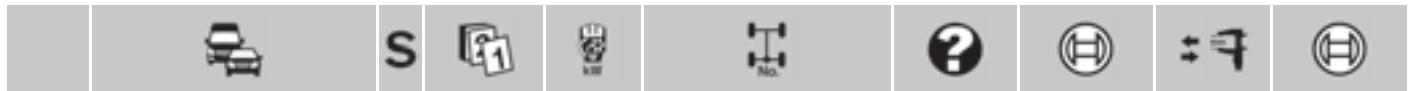

◀ SAAB

9-3 Kombi [9440]



	1.8 i	03.05-06.12	90/110/		D85	0986 134 018		← 57
	1.8 T		129			0986 135 018		→ 57
	1.8 T BioPower				302	0986 134 081		← 57
						0986 135 081		→ 57
					31D	0986 135 056		← 60
						0986 134 056		→ 60
	1.9 TiD	03.05-06.12	88/96/110/		D85	0986 134 018		← 57
						0986 135 018		→ 57
	1.9 TTiD		118/132		302	0986 134 081		← 57
						0986 135 081		→ 57
					31D	0986 135 056		← 60
						0986 134 056		→ 60
	2.0 T	03.05-06.12	110/120/		D85	0986 134 018		← 57
						0986 135 018		→ 57
	2.0 T BioPower		129/		302	0986 134 081		← 57
						0986 135 081		→ 57
					31D	0986 135 056		← 60
						0986 134 056		→ 60
	2.0 T BioPower XWD		145-177		D85	0986 134 018		← 57
						0986 135 018		→ 57
	2.0 T XWD				302	0986 134 081		← 57
						0986 135 081		→ 57
					31D	0986 135 056		← 60
						0986 134 056		→ 60
	2.8 T	03.05-06.12	184-188/		D85	0986 134 018		← 57
						0986 135 018		→ 57
	2.8 T XWD		202/206		302	0986 134 081		← 57
						0986 135 081		→ 57
					31D	0986 135 056		← 60
						0986 134 056		→ 60



	1.8 i, T, T BioPower	03.05-06.12	90/110/		292	0986 473 992		← 38
						0986 474 992		→ 38
	1.9 TiD	03.05-06.12	88/96/110/		292	0986 473 992		← 38
						0986 474 992		→ 38
	1.9 TTiD		118/132		292	0986 473 992		← 38
						0986 474 992		→ 38
	2.0 T, T BioPower, T BioPower XWD, T XWD	03.05-06.12	110/120/129/		292	0986 473 992		← 38
						0986 474 992		→ 38
	2.8 T	03.05-06.12	184-188/		292	0986 473 992		← 38
						0986 474 992		→ 38
	2.8 T XWD		202/206		292	0986 473 992		← 38
						0986 474 992		→ 38































































	1.8 i, T, T BioPower	03.05-06.12	90/110/129			1987 482 021		1932
								1932
	1.9 TiD, TTiD	03.05-06.12	88/96/110/118/132			1987 482 021		1932
								1932
	2.0 T, T BioPower, T BioPower XWD, T XWD	03.05-06.12	110/120/129/145-177			1987 482 021		1932
								1932
	2.8 T	03.05-06.12	184-188/			1987 482 021		1932
								1932
	2.8 T XWD		202/206			1987 482 021		1932
								1932

9-3 [9400]































































	2.0 i 16V	03.98-08.02	96/110/	Fg.-Nr. →X2020000, →X7020000		0986 473 056		← 57				
								0986 474 056		→ 57		
	2.0 i 16V Turbo		113/136/	Fg.-Nr. X2020001→, X7020001→		0986 473 062		← 57				
								0986 474 062		→ 57		
	2.2 16V D Turbo	03.98-08.99	85			0986 473 056		← 57				
								0986 474 056		→ 57		
								09.99-10.00	85	0986 473 062		← 57
								11.00-09.02	92	0986 473 062		← 57
	2.3 i 16V Turbo	09.98-08.02	169			0986 473 062		← 57				
								0986 474 062		→ 57		
	2.3 i 16V	03.98-08.00	110/125	Fg.-Nr. →X2020000, →X7020000		0986 473 056		← 57				
								0986 474 056		→ 57		
	2.3 i 16V Turbo			Fg.-Nr. X2020001→, X7020001→		0986 473 062		← 57				
								0986 474 062		→ 57		

		S							
									
	2.0i 16V	03.98-08.02	96/110/113/				0 986 473 379		← 34,94
	2.0i 16V Turbo		136/147/151				0 986 474 379		→ 34,94
	2.2 16V D Turbo	03.98-09.02	85/92				0 986 473 379		← 34,94
							0 986 474 379		→ 34,94
	2.3i 16V	03.98-08.00	110/125				0 986 473 379		← 34,94
	2.3i 16V Turbo						0 986 474 379		→ 34,94
									
	2.0i 16V, i 16V Turbo	03.98-08.02	96/110/113/136/147/151				1 987 477 895		2180
	2.2 16V D Turbo	03.98-09.02	85/92				1 987 477 895		2180
	2.3i 16V, i 16V Turbo	03.98-08.02	110/125/169				1 987 477 895		2180
	2.0i 16V, i 16V Turbo	03.98-08.02	96/110/113/136/147/151				0 265 006 331 <sup>3</sup>		
	2.2 16V D Turbo	03.98-09.02	85/92				0 265 006 331 <sup>3</sup>		
	2.3i 16V, i 16V Turbo	03.98-08.02	110/125/169				0 265 006 331 <sup>3</sup>		
<b>9-3 [9440]</b>									
									
	1.8 i	09.02-02.11	90/110/			D85	0 986 134 018		← 57
	1.8 T		129				0 986 135 018		→ 57
	1.8 T BioPower					302	0 986 134 081		← 57
							0 986 135 081		→ 57
						31D	0 986 135 056		← 60
							0 986 134 056		→ 60
	1.9 TiD	09.04-06.12	88/96/110/			D85	0 986 134 018		← 57
	1.9 TTiD		118/132				0 986 135 018		→ 57
						302	0 986 134 081		← 57
							0 986 135 081		→ 57
						31D	0 986 135 056		← 60
							0 986 134 056		→ 60
	2.0 T	02.03-02.11	154			302	0 986 134 081		← 57
							0 986 135 081		→ 57
	2.0 T BioPower	09.02-06.12	154	Fg.-Nr. 41022028→ 51046733		302	0 986 473 308		← 60
				Fg.-Nr. 51046734→		302	0 986 474 308		→ 60
							0 986 134 081		← 57
							0 986 135 081		→ 57
	2.0 T BioPower XWD	07.09-06.12	154			302	0 986 134 081		← 57
							0 986 135 081		→ 57
	2.0 T	09.02-06.12	154			D85	0 986 134 018		← 57
	2.0 T BioPower						0 986 135 018		→ 57
	2.0 T BioPower XWD					31D	0 986 135 056		← 60
							0 986 134 056		→ 60
	2.0 T	09.02-06.12	120/129/			D85	0 986 134 018		← 57
	2.0 T BioPower		145-147				0 986 135 018		→ 57
	2.0 T BioPower XWD					302	0 986 134 081		← 57
	2.0 T Sport						0 986 135 081		→ 57
	2.0 T XWD					31D	0 986 135 056		← 60
							0 986 134 056		→ 60
	2.0 T	09.08-06.12	154-177			D85	0 986 134 018		← 57
	2.0 T XWD						0 986 135 018		→ 57
						302	0 986 134 081		← 57
							0 986 135 081		→ 57
						31D	0 986 135 056		← 60
							0 986 134 056		→ 60
	2.2 TiD	10.02-08.04	95				0 986 473 294		← 57
							0 986 474 294		→ 57
	2.8 T	09.05-06.12	184-188/			D85	0 986 134 018		← 57
	2.8 T XWD		203/206				0 986 135 018		→ 57





















































		S							
	◀ SAAB 9-3 [9440]								
2.8 T		09.05-06.12	184-188/		302	0986 134 081		← 57	
2.8 TXWD			203/206			0986 135 081		→ 57	
					31D	0986 135 056		← 60	
						0986 134 056		→ 60	
	1.8 i, T, T BioPower	09.02-02.11	90/110/129		292	0986 473 992		← 38	
						0986 474 992		→ 38	
	1.9 TiD	09.04-06.12	88/96/110/		292	0986 473 992		← 38	
	1.9 TTiD		118/132			0986 474 992		→ 38	
	2.0 T	02.03-02.11	154		292	0986 473 992		← 38	
						0986 474 992		→ 38	
	2.0 T BioPower	09.02-06.12	154	Fg.-Nr. 51049407→	292	0986 473 992		← 38	
						0986 474 992		→ 38	
	2.0 T BioPower XWD	07.09-06.12	154		292	0986 473 992		← 38	
						0986 474 992		→ 38	
	2.0 T, T BioPower, T BioPower XWD T Sport, T XWD	09.02-06.12	120/129/ 145-147		292	0986 473 992		← 38	
						0986 474 992		→ 38	
	2.0 T	09.08-06.12	154-177		292	0986 473 992		← 38	
	2.0 T XWD					0986 474 992		→ 38	
	2.8 T	09.05-06.12	184-188/		292	0986 473 992		← 38	
	2.8 T XWD		203/206			0986 474 992		→ 38	
	1.8 i, T, T BioPower	09.02-02.11	90/110/129			1987 482 021			1932
	1.9 TiD, TTiD	09.04-06.12	88/96/110/118/132			1987 482 021			1932
	2.0 T, T BioPower, T BioPower XWD, T Sport, T XWD	09.02-06.12	120/129/145-147/ 154-177			1987 482 021			1932
	2.2 TiD	10.02-08.04	95			1987 482 021			1932
	2.8 T, T XWD	09.05-06.12	184-188/203/206			1987 482 021			1932
	<b>9-3X [9440]</b>								
	1.9 TTiD	03.10-06.12	132		D85	0986 134 018		← 57	
						0986 135 018		→ 57	
					302	0986 134 081		← 57	
						0986 135 081		→ 57	
					31D	0986 135 056		← 60	
						0986 134 056		→ 60	
	2.0 T BioPower XWD	03.10-06.12	120/154		D85	0986 134 018		← 57	
	2.0 T XWD					0986 135 018		→ 57	
					302	0986 134 081		← 57	
						0986 135 081		→ 57	
					31D	0986 135 056		← 60	
						0986 134 056		→ 60	
	1.9 TTiD	03.10-06.12	132		292	0986 473 992		← 38	
						0986 474 992		→ 38	
	2.0 T BioPower XWD	03.10-06.12	154			0986 473 992		← 38	
	2.0 T XWD					0986 474 992		→ 38	
	2.0 T XWD	09.10-06.12	120		292	0986 473 992		← 38	
						0986 474 992		→ 38	
	1.9 TTiD	03.10-06.12	132			1987 482 021			1932
	2.0 T BioPower XWD, T XWD	03.10-06.12	120/154			1987 482 021			1932

		S							
<b>9-5 Kombi [9600]</b>									
									
	<b>1.9 TiD</b>	01.06-02.10	110		15Z		0 986 473 062	 ← 57	
							0 986 474 062	 → 57	
					16Z		0 986 473 062	 ← 57	
							0 986 474 062	 → 57	
		01.07-02.10	129		288		0 986 473 062	 ← 57	
							0 986 474 062	 → 57	
					308				1 987 470 005 <sup>7</sup>
	<b>2.0 t</b>	09.99-08.00	140		288		0 986 473 062	 ← 57	
							0 986 474 062	 → 57	
					308				1 987 470 005 <sup>7</sup>
	<b>2.0 T</b>	07.00-07.01	136		288		0 986 473 062	 ← 57	
	<b>2.0 t</b>	06.98-02.10	110/132		288		0 986 473 062	 ← 57	
	<b>2.0 T BioPower</b>						0 986 474 062	 → 57	
	<b>2.0 Turbo</b>				308				1 987 470 005 <sup>7</sup>
	<b>2.2 TiD</b>	03.02-08.05	88				0 986 473 062	 ← 57	
							0 986 474 062	 → 57	
	<b>2.3 t</b>	06.99-08.00	125				0 986 473 062	 ← 57	
		09.00-08.05	136				0 986 473 062	 ← 57	
		09.01-08.05	136				0 986 474 062	 → 57	
		09.05-02.10	136		288		0 986 473 062	 ← 57	
							0 986 474 062	 → 57	
	<b>2.3 T BioPower</b>	01.07-02.10	136		288		0 986 473 062	 ← 57	
							0 986 474 062	 → 57	
	<b>2.3 t, T BioPower</b>	09.05-02.10	136		308				1 987 470 005 <sup>7</sup>
	<b>2.3 T</b>	09.01-02.10	184/188/ 191/224		288		0 986 473 062	 ← 57	
	<b>2.3 Turbo</b>						0 986 474 062	 → 57	
		09.03-02.10	152/162		288		0 986 473 062	 ← 57	
							0 986 474 062	 → 57	
					308				1 987 470 005 <sup>7</sup>
		09.05-02.10	184/188/191/224		308				1 987 470 005 <sup>7</sup>
	<b>2.3 Turbo</b>	05.99-09.01	169		288		0 986 473 062	 ← 57	
		09.01-09.01	169		288		0 986 474 062	 → 57	
		06.03-08.05	224		308				1 987 470 005 <sup>7</sup>
	<b>3.0 t</b>	06.97-08.98	147				0 986 473 056	 ← 57	
							0 986 474 056	 → 57	
		09.98-08.01	147				0 986 473 062	 ← 57	
							0 986 474 062	 → 57	
		09.01-08.03	147						1 987 470 005 <sup>7</sup>
	<b>3.0 TiD</b>	09.01-08.05	130				0 986 473 062	 ← 57	
							0 986 474 062	 → 57	
									
	<b>1.9 TiD</b>	01.06-02.10	110		15Z		0 986 473 131	 ← 37,94	
							0 986 474 131	 → 37,94	
		01.07-02.10	129				0 986 473 131	 ← 37,94	
							0 986 474 131	 → 37,94	
	<b>2.0 t</b>	09.99-08.00	140	Fg.-Nr. →X3025751			0 986 473 182	 ← 37,96	
							0 986 474 182	 → 37,96	
				Fg.-Nr. X3025752→			0 986 473 131	 ← 37,94	
							0 986 474 131	 → 37,94	
	<b>2.0 t, T, T BioPower, Turbo</b>	06.98-02.10	110/132/ 136				0 986 473 131	 ← 37,94	
							0 986 474 131	 → 37,94	
	<b>2.2 TiD</b>	03.02-08.05	88				0 986 473 131	 ← 37,94	
							0 986 474 131	 → 37,94	
	<b>2.3 t</b>	06.99-08.00	125	Fg.-Nr. →X3025751			0 986 473 182	 ← 37,96	
							0 986 474 182	 → 37,96	
				Fg.-Nr. X3025752→			0 986 473 131	 ← 37,94	
							0 986 474 131	 → 37,94	











































		S							
<b>SAAB 9-5 Kombi [9600]</b>									
<b>2.3 t, T, T BioPower, Turbo</b>	05.99-02.10	136/152/162/169/ 184/188/191/224				0986 <b>473 131</b>		← 37,94	
						0986 <b>474 131</b>		→ 37,94	
<b>3.0 t</b>	06.97-08.99	147	Fg.-Nr. →X3025751			0986 <b>473 182</b>		← 37,96	
						0986 <b>474 182</b>		→ 37,96	
	09.99-08.01	147	Fg.-Nr. X3025752 →			0986 <b>473 131</b>		← 37,94	
						0986 <b>474 131</b>		→ 37,94	
<b>1.9 TiD</b>	01.06-02.10	110				1987 <b>477 245</b>			1410
	01.07-02.10	129				1987 <b>477 245</b>			1410
						1987 <b>482 020</b>			342
<b>2.0 t, T, T BioPower, Turbo</b>	06.98-02.10	110/132/ 136/140				1987 <b>477 245</b>			1410
						1987 <b>482 020</b>			342
<b>2.2 TiD</b>	03.02-08.05	88				1987 <b>477 245</b>			1410
<b>2.3 t, T, T BioPower, Turbo</b>	05.99-02.10	125/136/152/162/169/ 184/188/191/224				1987 <b>477 245</b>			1410
						1987 <b>482 020</b>			342
<b>3.0 t</b>	06.97-08.05	130/147				1987 <b>477 245</b>			1410
<b>3.0 TiD</b>						1987 <b>482 020</b>			342
<b>2.0 t, T</b>	06.98-08.01	110/136/140				0265 <b>006 337</b> <sup>3</sup>			
	05.99-02.10	125/136/169				0265 <b>006 337</b> <sup>3</sup>			
	06.97-08.01	147				0265 <b>006 337</b> <sup>3</sup>			
<b>9-5 [9600]</b>									
<b>1.9 TiD</b>	09.05-02.10	110			15Z	0986 <b>473 062</b>		← 57	
					16Z	0986 <b>474 062</b>		→ 57	
						0986 <b>473 062</b>		← 57	
						0986 <b>474 062</b>		→ 57	
<b>2.0</b>	07.00-02.10	136			288	0986 <b>473 062</b>		← 57	
	09.01-02.10	136			288	0986 <b>474 062</b>		→ 57	
	09.05-02.10	136			308				1987 <b>470 005</b> <sup>7</sup>
<b>2.0 t</b>	09.99-08.00	140			288	0986 <b>473 062</b>		← 57	
						0986 <b>474 062</b>		→ 57	
					308				1987 <b>470 005</b> <sup>7</sup>
<b>2.0 t</b>	06.97-02.10	110/132			288	0986 <b>473 062</b>		← 57	
<b>2.0 T BioPower</b>						0986 <b>474 062</b>		→ 57	
<b>2.0 Turbo</b>					308				1987 <b>470 005</b> <sup>7</sup>
<b>2.2 TiD</b>	03.02-08.05	88				0986 <b>473 062</b>		← 57	
						0986 <b>474 062</b>		→ 57	
<b>2.3</b>	09.99-08.05	172-187			288	0986 <b>473 062</b>		← 57	
	09.01-08.05	172-187			288	0986 <b>474 062</b>		→ 57	
<b>2.3 t</b>	06.97-08.98	125				0986 <b>473 056</b>		← 57	
						0986 <b>474 056</b>		→ 57	
	09.98-08.00	125				0986 <b>473 062</b>		← 57	
						0986 <b>474 062</b>		→ 57	
	09.00-08.05	136				0986 <b>473 062</b>		← 57	
						0986 <b>474 062</b>		→ 57	
	09.01-08.05	136				0986 <b>473 062</b>		← 57	
						0986 <b>474 062</b>		→ 57	
09.05-02.10	136			288	0986 <b>473 062</b>		← 57		
					0986 <b>474 062</b>		→ 57		
<b>2.3 T BioPower</b>	01.07-02.10	136			288	0986 <b>473 062</b>		← 57	
						0986 <b>474 062</b>		→ 57	
<b>2.3 t, T BioPower</b>	09.05-02.10	136			308				1987 <b>470 005</b> <sup>7</sup>
<b>2.3 T</b>	09.01-02.10	184/188/			288	0986 <b>473 062</b>		← 57	
<b>2.3 Turbo</b>	09.05-02.10	184/188/191				0986 <b>474 062</b>		→ 57	
					308				1987 <b>470 005</b> <sup>7</sup>
<b>2.3 T</b>	09.03-02.10	152/162				0986 <b>473 062</b>		← 57	
						0986 <b>474 062</b>		→ 57	
					308				1987 <b>470 005</b> <sup>7</sup>
<b>2.3 Turbo</b>	05.99-09.01	169				0986 <b>473 062</b>		← 57	
						0986 <b>474 062</b>		→ 57	
	09.01-09.01	169			288	0986 <b>473 062</b>		← 57	
					288	0986 <b>474 062</b>		→ 57	









	<b>S</b>							
<b>2.3 Turbo BioPower</b>	04.08-02.10	134			288	0 986 473 062	 57	
						0 986 474 062	 57	
					308			1 987 470 005 <sup>7</sup>
<b>3.0t</b>	06.97-08.98	147				0 986 473 056	 57	
						0 986 474 056	 57	
	09.98-08.01	147				0 986 473 062	 57	
						0 986 474 062	 57	
	09.01-08.03	147						1 987 470 005 <sup>7</sup>
<b>3.0TiD</b>	09.01-08.05	130				0 986 473 062	 57	
						0 986 474 062	 57	
								
 <b>1.9TiD</b>	09.05-02.10	110			15Z	0 986 473 131	 37,94	
						0 986 474 131	 37,94	
<b>2.0</b>	06.97-02.10	110/132/				0 986 473 131	 37,94	
<b>2.0t, T BioPower, Turbo</b>		136				0 986 474 131	 37,94	
<b>2.0t</b>	09.99-08.00	140		Fg.-Nr. →X3025751		0 986 473 182	 37,96	
						0 986 474 182	 37,96	
				Fg.-Nr. X3025752→		0 986 473 131	 37,94	
						0 986 474 131	 37,94	
<b>2.2TiD</b>	03.02-08.05	88				0 986 473 131	 37,94	
						0 986 474 131	 37,94	
<b>2.3, t, T, T BioPower, Turbo, Turbo BioPower</b>	05.99-02.10	134/136/152/162/169/ 172-187/188/191				0 986 473 131	 37,94	
						0 986 474 131	 37,94	
<b>2.3t</b>	06.97-08.00	125		Fg.-Nr. →X3025751		0 986 473 182	 37,96	
						0 986 474 182	 37,96	
				Fg.-Nr. X3025752→		0 986 473 131	 37,94	
						0 986 474 131	 37,94	
<b>3.0t</b>	06.97-08.99	147		Fg.-Nr. →X3025751		0 986 473 182	 37,96	
						0 986 474 182	 37,96	
	09.99-08.01	147		Fg.-Nr. X3025752→		0 986 473 131	 37,94	
						0 986 474 131	 37,94	
								
 <b>1.9TiD</b>	09.05-02.10	110				1 987 477 245	1410	
<b>2.0, t, T BioPower, Turbo</b>	06.97-02.10	110/132/ 136/140				1 987 477 245	1410	
						1 987 482 020	342	
<b>2.2TiD</b>	03.02-08.05	88				1 987 477 245	1410	
<b>2.3, t, T BioPower, Turbo, Turbo BioPower</b>	06.97-02.10	125/134/136/152/162/ 169/172-187/188/191				1 987 477 245	1410	
						1 987 482 020	342	
<b>3.0t</b>	06.97-08.05	130/147				1 987 477 245	1410	
<b>3.0TiD</b>						1 987 482 020	342	
 <b>2.0t</b>	06.97-08.01	110/136/140				0 265 006 337 <sup>3</sup>		
<b>2.3t, Turbo</b>	06.97-02.10	125/136/169				0 265 006 337 <sup>3</sup>		
<b>3.0t</b>	06.97-08.01	147				0 265 006 337 <sup>3</sup>		
<b>900 I Cabriolet</b>								
								
 <b>2.3i</b>	09.93-08.96	112				0 986 473 330	 54	
						0 986 474 330	 54	
	09.96-08.98	112				0 986 473 056	 57	
						0 986 474 056	 57	
<b>2.5i</b>	09.93-08.96	127				0 986 473 330	 54	
						0 986 474 330	 54	
	09.96-08.97	127				0 986 473 056	 57	
						0 986 474 056	 57	

		S							
◀ SAAB 900 I Cabriolet									
	2.3i	09.93-08.96	112	0986 473 947		← 35			
				0986 473 948		→ 35			
		09.96-08.98	112	0986 473 379		← 34,94			
				0986 474 379		→ 34,94			
	2.5i	09.93-08.96	127	0986 473 947		← 35			
				0986 473 948		→ 35			
		09.96-08.97	127	0986 473 379		← 34,94			
				0986 474 379		→ 34,94			
<b>900 I Hatchback</b>									
	2.1i	09.93-08.94	103	0986 473 330		← 54			
				0986 474 330		→ 54			
	2.3i	09.93-08.96	112	0986 473 330		← 54			
				0986 474 330		→ 54			
		09.96-08.98	112	0986 473 056		← 57			
				0986 474 056		→ 57			
	2.5i	09.93-08.96	127	0986 473 330		← 54			
				0986 474 330		→ 54			
		09.96-08.97	127	0986 473 056		← 57			
				0986 474 056		→ 57			
	2.1i	09.93-08.94	103	0986 473 947		← 35			
				0986 473 948		→ 35			
	2.3i	09.93-08.96	112	0986 473 947		← 35			
				0986 473 948		→ 35			
		09.96-08.98	112	0986 473 379		← 34,94			
				0986 474 379		→ 34,94			
	2.5i	09.93-08.96	127	0986 473 947		← 35			
				0986 473 948		→ 35			
		09.96-08.97	127	0986 473 379		← 34,94			
				0986 474 379		→ 34,94			
<b>900 II</b>									
	2.0i	09.93-08.96	96/98/136	0986 473 330		← 54			
				0986 474 330		→ 54			
	2.0i Turbo	09.96-08.98	96/98/136	0986 474 056		→ 57			
	2.3i	09.93-08.96	110	0986 473 330		← 54			
				0986 474 330		→ 54			
		09.96-08.98	110	0986 474 056		→ 57			
	2.5i	09.93-08.96	125	0986 473 330		← 54			
				0986 474 330		→ 54			
		09.96-10.98	125	0986 474 056		→ 57			
	2.0i	09.93-08.96	96/98/136	0986 473 947		← 35			
				0986 473 948		→ 35			
	2.0i Turbo	09.96-08.98	96/98/136	0986 473 379		← 34,94			
				0986 474 379		→ 34,94			
	2.3i	09.93-08.96	110	0986 473 947		← 35			
				0986 473 948		→ 35			
		09.96-08.98	110	0986 473 379		← 34,94			
				0986 474 379		→ 34,94			
	2.5i	09.93-08.96	125	0986 473 947		← 35			
				0986 473 948		→ 35			



		S							
2.5i		09.96-10.98	125				0 986 473 379	 ← 34,94	
							0 986 474 379	 → 34,94	
									
 2.0i		09.93-08.98	96/98/136	Fg.-Nr. →R2023869			1 987 477 681	← 776	
2.0i Turbo							1 987 477 682	→ 2104	
				Fg.-Nr. V2011537→, V7002550→			1 987 477 895	2180	
2.3i		09.93-08.98	110	Fg.-Nr. →R2023869			1 987 477 681	← 776	
							1 987 477 682	→ 2104	
				Fg.-Nr. V2011537→, V7002550→			1 987 477 895	2180	
2.5i		09.93-10.98	125	Fg.-Nr. →R2023869			1 987 477 681	← 776	
							1 987 477 682	→ 2104	
				Fg.-Nr. V2011537→, V7002550→			1 987 477 895	2180	
 2.0i, i Turbo		09.95-08.98	96/98/136				0 265 006 331 <sup>3</sup>		
2.3i		09.95-08.98	110				0 265 006 331 <sup>3</sup>		
2.5i		09.95-10.98	125				0 265 006 331 <sup>3</sup>		
<b>900 II Cabriolet</b>									
									
 2.0i		03.94-08.96	96/98/136				0 986 473 330	 ← 54	
2.0i Turbo							0 986 474 330	 → 54	
		09.96-08.98	96/98/136				0 986 474 056	 → 57	
2.3i		03.94-08.96	110				0 986 473 330	 ← 54	
							0 986 474 330	 → 54	
		09.96-08.98	110				0 986 474 056	 → 57	
2.5i		03.94-08.96	125				0 986 473 330	 ← 54	
							0 986 474 330	 → 54	
		09.96-10.98	125				0 986 474 056	 → 57	
									
 2.0i		03.94-08.96	96/98/136				0 986 473 947	 ← 35	
2.0i Turbo							0 986 473 948	 → 35	
		09.96-08.98	96/98/136				0 986 473 379	 ← 34,94	
							0 986 474 379	 → 34,94	
2.3i		03.94-08.96	110				0 986 473 947	 ← 35	
							0 986 473 948	 → 35	
		09.96-08.98	110				0 986 473 379	 ← 34,94	
							0 986 474 379	 → 34,94	
2.5i		03.94-08.96	125				0 986 473 947	 ← 35	
							0 986 473 948	 → 35	
		09.96-10.98	125				0 986 473 379	 ← 34,94	
							0 986 474 379	 → 34,94	
									
 2.0i		03.94-08.98	96/98/136	Fg.-Nr. →R2023869			1 987 477 681	← 776	
2.0i Turbo							1 987 477 682	→ 2104	
				Fg.-Nr. V2011537→, V7002550→			1 987 477 895	2180	
2.3i		03.94-08.98	110	Fg.-Nr. →R2023869			1 987 477 681	← 776	
							1 987 477 682	→ 2104	
				Fg.-Nr. V2011537→, V7002550→			1 987 477 895	2180	
2.5i		03.94-10.98	125	Fg.-Nr. →R2023869			1 987 477 681	← 776	
							1 987 477 682	→ 2104	
				Fg.-Nr. V2011537→, V7002550→			1 987 477 895	2180	
 2.0i, i Turbo		09.95-08.98	96/98/136				0 265 006 331 <sup>3</sup>		
2.3i		09.95-08.98	110				0 265 006 331 <sup>3</sup>		
2.5i		09.95-10.98	125				0 265 006 331 <sup>3</sup>		

		S							
◀ SAAB									
<b>900 II Coupé</b>									
	2.0 i	03.94-08.96	96/98/136			0986 473 330		← 54	
	2.0 i Turbo					0986 474 330		→ 54	
		09.96-08.98	96/98/136			0986 474 056		→ 57	
	2.3 i	03.94-08.96	110			0986 473 330		← 54	
						0986 474 330		→ 54	
		09.96-08.98	110			0986 474 056		→ 57	
	2.5 i	03.94-08.96	125			0986 473 330		← 54	
						0986 474 330		→ 54	
		09.96-10.98	125			0986 474 056		→ 57	
	2.0 i	03.94-08.96	96/98/136			0986 473 947		← 35	
	2.0 i Turbo					0986 473 948		→ 35	
		09.96-08.98	96/98/136			0986 473 379		← 34,94	
						0986 474 379		→ 34,94	
	2.3 i	03.94-08.96	110			0986 473 947		← 35	
						0986 473 948		→ 35	
		09.96-08.98	110			0986 473 379		← 34,94	
						0986 474 379		→ 34,94	
	2.5 i	03.94-08.96	125			0986 473 947		← 35	
						0986 473 948		→ 35	
		09.96-10.98	125			0986 473 379		← 34,94	
						0986 474 379		→ 34,94	
	2.0 i	03.94-08.98	96/98/136	Fg.-Nr. →R2023869		1987 477 681		← 776	
	2.0 i Turbo					1987 477 682		→ 2104	
					Fg.-Nr. V2011537→, V7002550→	1987 477 895		2180	
	2.3 i	03.94-08.98	110	Fg.-Nr. →R2023869		1987 477 681		← 776	
						1987 477 682		→ 2104	
					Fg.-Nr. V2011537→, V7002550→	1987 477 895		2180	
	2.5 i	03.94-10.98	125	Fg.-Nr. →R2023869		1987 477 681		← 776	
						1987 477 682		→ 2104	
					Fg.-Nr. V2011537→, V7002550→	1987 477 895		2180	
	2.0 i, i Turbo	09.95-08.98	96/98/136			0 265 006 331 <sup>3</sup>			
	2.3 i	09.95-08.98	110			0 265 006 331 <sup>3</sup>			
	2.5 i	09.95-10.98	125			0 265 006 331 <sup>3</sup>			
<b>9000</b>									
	2.0 CD Turbo 16V	09.92-12.98	96/108			0986 473 873		← 33	
	2.0 CS					0986 473 874		→ 33	
	2.3 CD Turbo Ecopow., CD 16V, CDE Turbo, CDE Turbo Ecopower, CS Aero Turbo, CS Turbo Ecopower, CS 16V, CSE Turbo	09.92-12.98	108/125/147/165			0986 473 873		← 33	
						0986 473 874		→ 33	
	3.0 CD, CS, Griffin	09.94-12.98	155			0986 473 873		← 33	
						0986 473 874		→ 33	
	2.0 CD Turbo 16V	09.92-12.98	108			1987 482 256		← 2025	
	2.0 CS	09.93-08.96	96			1987 482 107		→ 1680	
		09.93-12.98	96			1987 482 256		← 2025	
		09.96-12.98	96			1987 482 106		→ 1892	
	2.0 CS Turbo	09.94-08.96	110			1987 482 107		→ 1680	
		09.94-12.98	110			1987 482 256		← 2025	

	<b>S</b>							
2.0 CS Turbo	09.96-12.98	110				1 987 482 106	→ 1892	
2.3 CD Turbo Ecopow.	09.93-12.98	125				1 987 482 256	← 2025	
2.3 CD Turbo Ecopow., CDE Turbo	09.93-08.96	125				1 987 482 107	→ 1680	
Ecopower, CS Turbo Ecopower	09.96-12.98	125				1 987 482 106	→ 1892	
2.3 CD 16V	09.93-12.98	108				1 987 482 256	← 2025	
2.3 CD 16V	09.93-08.96	108				1 987 482 107	→ 1680	
2.3 CS 16V	09.96-12.98	108				1 987 482 106	→ 1892	
2.3 CDE Turbo	09.93-12.98	147				1 987 482 256	← 2025	
2.3 CDE Turbo Ecopower	09.94-12.98	125				1 987 482 256	← 2025	
2.3 CDE Turbo	09.93-08.96	147				1 987 482 107	→ 1680	
2.3 CSE Turbo	09.96-12.98	147				1 987 482 106	→ 1892	
2.3 CS Aero Turbo	09.92-08.96	165				1 987 482 107	→ 1680	
	09.92-12.98	165				1 987 482 256	← 2025	
	09.96-12.98	165				1 987 482 106	→ 1892	
2.3 CS Turbo Ecopower	09.93-12.98	125				1 987 482 256	← 2025	
2.3 CS 16V	09.93-12.98	108				1 987 482 256	← 2025	
2.3 CSE Turbo	09.93-12.98	147				1 987 482 256	← 2025	
3.0 CD	09.94-12.98	155				1 987 482 256	← 2025	
3.0 CD, CS,Griffin	09.94-08.96	155				1 987 482 107	→ 1680	
	09.96-12.98	155				1 987 482 106	→ 1892	
3.0 CS	09.94-12.98	155				1 987 482 256	← 2025	
3.0 Griffin	09.94-12.98	155				1 987 482 256	← 2025	





## SAIPA

## Saipa 141















							
	1.3i	06.03→	46			0 986 475 840	↔ 15,9

## SEAT

## Alhambra [7V8]















							
	1.8 T	05.98-02.00	110			0 986 473 111	☹ ← 56,93 1 987 470 005 <sup>7</sup>
						0 986 473 111	☹ ← 56,93 1 987 470 506 <sup>8</sup>
	1.9 TDI	03.96-02.00	66/81			0 986 473 111	☹ ← 56,93 1 987 470 005 <sup>7</sup>
						0 986 473 111	☹ ← 56,93 1 987 470 506 <sup>8</sup>
	2.0	03.96-02.00	85			0 986 473 111	☹ ← 56,93 1 987 470 005 <sup>7</sup>
						0 986 473 111	☹ ← 56,93 1 987 470 506 <sup>8</sup>
	1.8 T	05.98-02.00	110			0 986 473 846	☹ ← 38 1 987 470 040
						0 986 473 847	☹ → 38 1 987 470 040
	1.9 TDI	03.96-02.00	66/81			0 986 473 846	☹ ← 38 1 987 470 040
						0 986 473 847	☹ → 38 1 987 470 040
	2.0	03.96-02.00	85			0 986 473 846	☹ ← 38 1 987 470 040
						0 986 473 847	☹ → 38 1 987 470 040
	1.8 T	05.98-02.00	110			1 987 477 630	↔ 1293
						1 987 477 833	654
	1.9 TDI	03.96-02.00	66/81			1 987 477 630	↔ 1293
						1 987 477 833	654
	2.0	03.96-02.00	85			1 987 477 630	↔ 1293
						1 987 477 833	654

◀ SEAT Alhambra [7V8]										
	1.8 T	05.98-02.00	110			0986 594 010 <sup>3</sup>				
						0986 594 011 <sup>4</sup>				
	1.9 TDI	03.96-02.00	66/81			0986 594 010 <sup>3</sup>				
						0986 594 011 <sup>4</sup>				
	2.0	03.96-02.00	85			0986 594 010 <sup>3</sup>				
						0986 594 011 <sup>4</sup>				
Alhambra [7V9]										
	1.8 T	06.00-04.01	110	Fg.-Nr. →7M..1..530756		0986 473 111		← 56,93	1987 470 005 <sup>7</sup>	
							0986 473 111		← 56,93	1987 470 506 <sup>8</sup>
		05.01-03.10	110	Fg.-Nr. 7M..2..500001→		0986 473 184		← 57		
						0986 474 184		→ 57		
	1.9 TDI	06.00-04.01	66	Fg.-Nr. →7M..1..530756		0986 473 111		← 56,93	1987 470 005 <sup>7</sup>	
			85	Fg.-Nr. →7M..1..530756	288	0986 473 111		← 56,93	1987 470 506 <sup>8</sup>	
						0986 473 111		← 56,93	1987 470 506 <sup>8</sup>	
						0986 474 184		→ 57		
		05.01-03.10	66	Fg.-Nr. 7M..2..500001→		0986 473 259		← 57	1987 470 005 <sup>7</sup>	
						0986 474 259		→ 57	1987 470 005 <sup>7</sup>	
			85	Fg.-Nr. 7M..2..500001→	326	0986 473 259		← 57	1987 470 005 <sup>7</sup>	
						0986 474 259		→ 57	1987 470 005 <sup>7</sup>	
		11.05-03.10	85			0986 473 259		← 57	1987 470 005 <sup>7</sup>	
						0986 474 259		→ 57	1987 470 005 <sup>7</sup>	
	1.9 TDI	11.02-11.08	96/110		1KX	0986 473 184		← 57		
	1.9 TDI 4Motion					0986 474 184		→ 57		
						288	0986 473 111		← 56,93	1987 470 005 <sup>7</sup>
						326	0986 473 111		← 56,93	1987 470 506 <sup>8</sup>
						0986 473 259		← 57	1987 470 005 <sup>7</sup>	
						0986 474 259		→ 57	1987 470 005 <sup>7</sup>	
	1.9 TDI 4Motion	06.00-03.10	85			0986 473 184		← 57		
						0986 474 184		→ 57		
	2.0	06.00-04.01	85	Fg.-Nr. →7M..1..530756		0986 473 111		← 56,93	1987 470 005 <sup>7</sup>	
			85	Fg.-Nr. 7M..2..500001→		0986 473 111		← 56,93	1987 470 506 <sup>8</sup>	
						0986 473 259		← 57	1987 470 005 <sup>7</sup>	
						0986 474 259		→ 57	1987 470 005 <sup>7</sup>	
	2.0 TDI	11.05-03.10	103			0986 473 259		← 57	1987 470 005 <sup>7</sup>	
						0986 474 259		→ 57	1987 470 005 <sup>7</sup>	
	2.8	06.00-04.02	150		1KX	0986 473 184		← 57		
			150			0986 474 184		→ 57		
						0986 473 184		← 57		
						0986 474 184		→ 57		
	2.8	06.00-03.10	150		288	0986 473 111		← 56,93	1987 470 005 <sup>7</sup>	
			150			0986 473 111		← 56,93	1987 470 506 <sup>8</sup>	
					326	0986 473 259		← 57	1987 470 005 <sup>7</sup>	
						0986 474 259		→ 57	1987 470 005 <sup>7</sup>	
	2.8 4Motion	06.00-03.10	150		1KX	0986 473 184		← 57		
						0986 474 184		→ 57		
	1.8 T	06.00-03.10	110			0986 472 832		← 38	1987 470 040	
						0986 473 073			1987 474 496 <sup>8</sup>	
						0986 472 833		→ 38	1987 470 040	
						0986 474 073				
	1.9 TDI	06.00-03.10	66			0986 473 846		← 38	1987 470 040	
			85			0986 473 847		→ 38	1987 470 040	
						0986 473 847		→ 38	1987 470 040	
	1.9 TDI	06.00-03.10	85			0986 473 846		← 38	1987 470 040	
	1.9 TDI 4Motion	11.02-11.08	96/110		1LQ	0986 473 846		← 38	1987 470 040	
							0986 473 847		→ 38	1987 470 040

		S							
<b>1.9 TDI</b>		11.02-11.08	96/110		294	0 986 472 832	← 38	1 987 470 040	
<b>1.9 TDI 4Motion</b>						0 986 473 073	↻	1 987 474 496 <sup>B</sup>	
						0 986 472 833	→ 38	1 987 470 040	
						0 986 474 073	↻		
<b>1.9 TDI 4Motion</b>		06.00-03.10	85			0 986 473 847	↻ → 38	1 987 470 040	
		06.05-03.10	85			0 986 472 832	← 38	1 987 470 040	
						0 986 473 073	↻	1 987 474 496 <sup>B</sup>	
						0 986 472 833	→ 38	1 987 470 040	
						0 986 474 073	↻		
<b>2.0</b>		06.00-03.10	85/103			0 986 473 846	↻ ← 38	1 987 470 040	
<b>2.0 TDI</b>						0 986 473 847	↻ → 38	1 987 470 040	
<b>2.8</b>		06.00-04.02	150		294	0 986 472 832	← 38	1 987 470 040	
						0 986 473 073	↻	1 987 474 496 <sup>B</sup>	
						0 986 472 833	→ 38	1 987 470 040	
						0 986 474 073	↻		
		06.00-03.10	150			0 986 472 832	← 38	1 987 470 040	
						0 986 473 073	↻	1 987 474 496 <sup>B</sup>	
						0 986 472 833	→ 38	1 987 470 040	
						0 986 474 073	↻		
<b>2.8</b>		06.00-03.10	150		1LQ	0 986 473 846	↻ ← 38	1 987 470 040	
<b>2.8 4Motion</b>						0 986 473 847	↻ → 38	1 987 470 040	
<b>2.8 4Motion</b>		06.00-03.10	150		294	0 986 472 832	← 38	1 987 470 040	
						0 986 473 073	↻	1 987 474 496 <sup>B</sup>	
						0 986 472 833	→ 38	1 987 470 040	
						0 986 474 073	↻		
									
	<b>1.8 T</b>	06.00-03.10	110			1 987 477 833	654		
	<b>1.9 TDI</b>	06.00-03.10	66/85/96			1 987 477 630	↔ 1293		
						1 987 477 833	654		
		06.05-05.07	110			1 987 477 833	654		
	<b>1.9 TDI 4Motion</b>	06.00-03.10	66/85/96			1 987 477 833	654		
	<b>2.0</b>	06.00-03.10	85/103			1 987 477 630	↔ 1293		
	<b>2.0, TDI</b>	06.00-03.10	85/103			1 987 477 833	654		
	<b>2.0 TDI</b>	11.05-03.10	85/103			1 987 477 630	↔ 1293		
	<b>2.8, 4Motion</b>	06.00-03.10	150			1 987 477 833	654		
<b>Alhambra [710]</b>									
									
	<b>1.4 TSI</b>	05.10→	110	PR-Code 1LJ	312	0 986 134 323	↻ ← 57	1 987 470 506 <sup>B</sup>	
						0 986 135 323	↻ → 57	1 987 470 506 <sup>B</sup>	
	<b>1.8 TSI</b>	11.12→	118	PR-Code 1LJ	312	0 986 134 323	↻ ← 57	1 987 470 506 <sup>B</sup>	
						0 986 135 323	↻ → 57	1 987 470 506 <sup>B</sup>	
	<b>2.0 TDI</b>	05.10→	85/100/	PR-Code 1LJ	312	0 986 134 323	↻ ← 57	1 987 470 506 <sup>B</sup>	
	<b>2.0 TDI 4WD</b>		103/125/			0 986 135 323	↻ → 57	1 987 470 506 <sup>B</sup>	
	<b>2.0 TSI</b>		130/147						
									
	<b>1.4 TSI</b>	05.10-07.11	110	PR-Code 7X5, PR-Code 7X6	LAB	0 986 594 524 <sup>3</sup>			
					RAB	0 986 594 525 <sup>3</sup>			
		05.10→	110	PR-Code 7X0, PR-Code 7X2,	LAB	0 986 594 504 <sup>3</sup>			
				PR-Code 7X8, PR-Code 7X9	RAB	0 986 594 505 <sup>3</sup>			
				PR-Code 7X5, PR-Code 7X6	LAB	0 986 594 561 <sup>4</sup>			
					RAB	0 986 594 560 <sup>4</sup>			
		05.12→	110		FPA,LAB	0 986 594 561 <sup>4</sup>			
					FPA,RAB	0 986 594 560 <sup>4</sup>			
					FPA,LAB	0 986 594 504 <sup>3</sup>			
					FPA,RAB	0 986 594 505 <sup>3</sup>			
	<b>1.8 TSI</b>	11.12→	118		LAB	0 986 594 504 <sup>3</sup>			
					RAB	0 986 594 505 <sup>3</sup>			













		S							
<b>SEAT Alhambra [710]</b>									
2.0 TDI		05.10-07.11	125	PR-Code 7X5, PR-Code 7X6	LAB	0 986 594 524 <sup>3</sup>			
					RAB	0 986 594 525 <sup>3</sup>			
2.0 TDI		05.10→	125	PR-Code 7X0, PR-Code 7X2, PR-Code 7X8, PR-Code 7X9	LAB	0 986 594 561 <sup>4</sup>			
					RAB	0 986 594 560 <sup>4</sup>			
		05.11-07.11	85		LAB	0 986 594 504 <sup>3</sup>			
					RAB	0 986 594 505 <sup>3</sup>			
		05.11→	85		LAB	0 986 594 524 <sup>3</sup>			
					RAB	0 986 594 525 <sup>3</sup>			
11.12→	130	LAB	0 986 594 561 <sup>4</sup>						
		RAB	0 986 594 560 <sup>4</sup>						
2.0 TDI		05.10-07.11	100/103		FPA,LAB	0 986 594 524 <sup>3</sup>			
2.0 TDI 4WD		05.10→	100/103	PR-Code 7X0, PR-Code 7X2, PR-Code 7X8, PR-Code 7X9	FPA,RAB	0 986 594 525 <sup>3</sup>			
					FPA,LAB	0 986 594 561 <sup>4</sup>			
		FPA,RAB	0 986 594 560 <sup>4</sup>						
		FPA,LAB	0 986 594 504 <sup>3</sup>						
		FPA,RAB	0 986 594 505 <sup>3</sup>						
2.0 TSI		12.10-07.11	147	PR-Code 7X5, PR-Code 7X6	LAB	0 986 594 524 <sup>3</sup>			
					RAB	0 986 594 525 <sup>3</sup>			
		12.10→	147		LAB	0 986 594 561 <sup>4</sup>			
					RAB	0 986 594 560 <sup>4</sup>			
					LAB	0 986 594 504 <sup>3</sup>			
					RAB	0 986 594 505 <sup>3</sup>			
<b>Altea Freetrack [5P5, 5P8]</b>									
2.0 TFSI		07.09→	155			0 986 473 384		← 53,94	F 026 A06 106 <sup>7</sup>
						0 986 473 384		← 53,94	1 987 470 506 <sup>8</sup>
						0 986 474 384		→ 53,94	F 026 A06 106 <sup>7</sup>
2.0 TFSI		07.09→	155			0 986 134 203		← 38	
						0 986 135 203		→ 38	
2.0 TFSI		07.09→	155			1 987 477 958		↔ 1447	
2.0 TFSI		07.09-10.09	155		LAB	0 986 594 506 <sup>4</sup>			
					RAB	0 986 594 507 <sup>4</sup>			
		07.09→	155		LAB	0 986 594 504 <sup>3</sup>			
					RAB	0 986 594 505 <sup>3</sup>			
<b>Altea Freetrack [5P5/5P8]</b>									
1.4 TSI		05.10→	92			0 986 473 384		← 53,94	F 026 A06 106 <sup>7</sup>
						0 986 473 384		← 53,94	1 987 470 506 <sup>8</sup>
						0 986 474 384		→ 53,94	F 026 A06 106 <sup>7</sup>
1.6 TDI		05.10-05.13	77			0 986 473 384		← 53,94	F 026 A06 106 <sup>7</sup>
						0 986 473 384		← 53,94	1 987 470 506 <sup>8</sup>
						0 986 474 384		→ 53,94	F 026 A06 106 <sup>7</sup>
2.0 TDI		06.07→	103			0 986 473 384		← 53,94	F 026 A06 106 <sup>7</sup>
2.0 TDI 4WD						0 986 473 384		← 53,94	1 987 470 506 <sup>8</sup>
						0 986 474 384		→ 53,94	1 987 470 506 <sup>8</sup>

		S																
2.0 TDI 4WD		06.07-06.09	125	PR-Code 1ZE, PR-Code 1LJ	288,312		0 986 473 384	↔ 53,94	F 026 A06 106 <sup>7</sup>									
							0 986 473 384	↔ 53,94	1 987 470 506 <sup>8</sup>									
							0 986 474 384	↔ 53,94	F 026 A06 106 <sup>7</sup>									
							PR-Code 1ZF	228	0 986 473 071	↔ 54	1 987 470 506 <sup>8</sup>							
									0 986 474 071	↔ 54	1 987 470 506 <sup>8</sup>							
							03.09-05.13	125			0 986 473 384	↔ 53,94	F 026 A06 106 <sup>7</sup>					
				0 986 473 384	↔ 53,94	1 987 470 506 <sup>8</sup>												
				0 986 474 384	↔ 53,94	F 026 A06 106 <sup>7</sup>												
2.0 TFSI 4WD		06.07-06.09	147	PR-Code 1ZE, PR-Code 1LJ	288,312		0 986 473 384	↔ 53,94	F 026 A06 106 <sup>7</sup>									
							0 986 473 384	↔ 53,94	1 987 470 506 <sup>8</sup>									
							0 986 474 384	↔ 53,94	F 026 A06 106 <sup>7</sup>									
							PR-Code 1ZF	228	0 986 473 071	↔ 54	1 987 470 506 <sup>8</sup>							
									0 986 474 071	↔ 54	1 987 470 506 <sup>8</sup>							
							07.09→	155			0 986 473 384	↔ 53,94	F 026 A06 106 <sup>7</sup>					
				0 986 473 384	↔ 53,94	1 987 470 506 <sup>8</sup>												
				0 986 474 384	↔ 53,94	F 026 A06 106 <sup>7</sup>												
1.4 TSI		05.10→	92				0 986 473 381	↔ 38,1	1 987 470 040									
							0 986 473 381	↔ 38,1	1 987 474 496 <sup>8</sup>									
							0 986 474 381	↔ 38,1	1 987 470 040									
							1.6 TDI	05.10-05.13	77	0 986 473 381	↔ 38,1	1 987 470 040						
										0 986 473 381	↔ 38,1	1 987 474 496 <sup>8</sup>						
										0 986 474 381	↔ 38,1	1 987 470 040						
							2.0 TDI	06.07→	103	0 986 134 203	↔ 38							
										0 986 135 203	↔ 38							
							2.0 TDI 4WD		06.07-06.09	125	PR-Code 1KD			0 986 473 381	↔ 38,1	1 987 470 040		
														0 986 473 381	↔ 38,1	1 987 474 496 <sup>8</sup>		
														0 986 474 381	↔ 38,1	1 987 470 040		
														PR-Code 1KF		0 986 473 448	↔ 41	1 987 470 040
																0 986 474 448	↔ 41	1 987 470 040
														PR-Code 1KJ		0 986 134 048	↔ 38	
																0 986 135 048	↔ 38	
														PR-Code 1KZ		0 986 134 048	↔ 38	
																0 986 135 048	↔ 38	
														03.09-05.13	125			0 986 134 203
				0 986 135 203	↔ 38													
2.0 TFSI 4WD		06.07-06.09	147	PR-Code 1KD										0 986 473 381	↔ 38,1	1 987 470 040		
							0 986 473 381	↔ 38,1	1 987 474 496 <sup>8</sup>									
							0 986 474 381	↔ 38,1	1 987 470 040									
							PR-Code 1KF		0 986 473 448	↔ 41	1 987 470 040							
									0 986 474 448	↔ 41	1 987 470 040							
							PR-Code 1KJ		0 986 134 048	↔ 38								
									0 986 135 048	↔ 38								
							PR-Code 1KZ		0 986 134 048	↔ 38								
									0 986 135 048	↔ 38								
							07.09→	155			0 986 134 203	↔ 38						
											0 986 135 203	↔ 38						
							1.4 TSI		05.10→	92				1 987 477 958	↔ 1447			
1.6 TDI	05.10-05.13	77	1 987 477 958	↔ 1447														
			2.0 TDI	06.07-10.10	103	1 987 477 957								→ 1447				
						1 987 477 958								← 1447				
2.0 TDI 4WD	06.07-06.09	125	1 987 477 958	← 1447														
			06.07-05.13	125	1 987 477 957	→ 1447												
			02.08-10.10	103	1 987 477 957	↔ 1447												
			03.09-05.13	125	1 987 477 957	← 1447												
			10.10→	103	1 987 477 958	↔ 1447												
2.0 TFSI 4WD	06.07-06.09	147	1 987 477 957	→ 1447														
			1 987 477 958	← 1447														
			07.09→	155	1 987 477 958	↔ 1447												

			S											
◀ SEAT Altea Freetrack [5P5/5P8]														
	1.4 TSI	05.10→	92					LAB	0 986 594 504 <sup>3</sup>					
								RAB	0 986 594 505 <sup>3</sup>					
	1.6 TDI	05.10-05.13	77						LAB	0 986 594 504 <sup>3</sup>				
									RAB	0 986 594 505 <sup>3</sup>				
	2.0 TDI	06.07-10.10	103/125/ 147/155						LAB	0 986 594 504 <sup>3</sup>				
									RAB	0 986 594 505 <sup>3</sup>				
	2.0 TDI 4WD	06.07→	103/125/ 147/155						LAB	0 986 594 504 <sup>3</sup>				
									RAB	0 986 594 505 <sup>3</sup>				
	2.0 TFSI 4WD	06.07→	103/125/ 147/155						LAB	0 986 594 504 <sup>3</sup>				
									RAB	0 986 594 505 <sup>3</sup>				
	Altea XL [5P5]													
		1.2 TSI	04.10→	77						0 986 473 384		← 53,94	F 026 A06 106 <sup>7</sup>	
0 986 473 384											← 53,94	1 987 470 506 <sup>8</sup>		
0 986 474 384											→ 53,94	F 026 A06 106 <sup>7</sup>		
1.4		10.06-05.10	63							0 986 473 071		← 54	1 987 470 506 <sup>8</sup>	
										0 986 474 071		→ 54	1 987 470 506 <sup>8</sup>	
		05.10-05.13	63	PR-Code 1ZE	288						0 986 473 384		← 53,94	F 026 A06 106 <sup>7</sup>
											0 986 473 384		← 53,94	1 987 470 506 <sup>8</sup>
				PR-Code 1ZF	228					0 986 474 384		→ 53,94	F 026 A06 106 <sup>7</sup>	
										0 986 473 071		← 54	1 987 470 506 <sup>8</sup>	
										0 986 474 071		→ 54	1 987 470 506 <sup>8</sup>	
										0 986 473 384		← 53,94	F 026 A06 106 <sup>7</sup>	
1.4 TSI		11.07→	92							0 986 473 384		← 53,94	F 026 A06 106 <sup>7</sup>	
										0 986 473 384		← 53,94	1 987 470 506 <sup>8</sup>	
										0 986 474 384		→ 53,94	F 026 A06 106 <sup>7</sup>	
1.6		09.09→	72-75							0 986 473 384		← 53,94	F 026 A06 106 <sup>7</sup>	
										0 986 473 384		← 53,94	1 987 470 506 <sup>8</sup>	
					PR-Code 1ZE	288					0 986 474 384		→ 53,94	F 026 A06 106 <sup>7</sup>
											0 986 473 071		← 54	1 987 470 506 <sup>8</sup>
										0 986 474 071		→ 54	1 987 470 506 <sup>8</sup>	
										0 986 473 071		← 54	1 987 470 506 <sup>8</sup>	
1.6 MultiFuel		10.06-05.13	75							0 986 473 071		← 54	1 987 470 506 <sup>8</sup>	
										0 986 474 071		→ 54	1 987 470 506 <sup>8</sup>	
1.6 TDI		10.09→	77							0 986 473 384		← 53,94	F 026 A06 106 <sup>7</sup>	
										0 986 473 384		← 53,94	1 987 470 506 <sup>8</sup>	
										0 986 474 384		→ 53,94	F 026 A06 106 <sup>7</sup>	
		05.10→	66								0 986 473 384		← 53,94	F 026 A06 106 <sup>7</sup>
											0 986 473 384		← 53,94	1 987 470 506 <sup>8</sup>
											0 986 474 384		→ 53,94	F 026 A06 106 <sup>7</sup>
1.8 TSI		01.07-03.09	118							0 986 473 384		← 53,94	F 026 A06 106 <sup>7</sup>	
										0 986 473 384		← 53,94	1 987 470 506 <sup>8</sup>	
					PR-Code 1ZE, PR-Code 1LJ	288,312					0 986 474 384		→ 53,94	F 026 A06 106 <sup>7</sup>
											0 986 473 071		← 54	1 987 470 506 <sup>8</sup>
03.09→		118								0 986 474 071		→ 54	1 987 470 506 <sup>8</sup>	
										0 986 473 384		← 53,94	F 026 A06 106 <sup>7</sup>	
										0 986 473 384		← 53,94	1 987 470 506 <sup>8</sup>	
										0 986 474 384		→ 53,94	F 026 A06 106 <sup>7</sup>	
1.9 TDI	10.06-12.10	66/77							0 986 473 384		← 53,94	F 026 A06 106 <sup>7</sup>		
									0 986 473 384		← 53,94	1 987 470 506 <sup>8</sup>		
									0 986 474 384		→ 53,94	F 026 A06 106 <sup>7</sup>		
2.0 FSI	10.06-03.09	110							0 986 473 384		← 53,94	F 026 A06 106 <sup>7</sup>		
									0 986 473 384		← 53,94	1 987 470 506 <sup>8</sup>		
				PR-Code 1ZE, PR-Code 1LJ	288,312					0 986 474 384		→ 53,94	F 026 A06 106 <sup>7</sup>	
										0 986 473 071		← 54	1 987 470 506 <sup>8</sup>	
									0 986 474 071		→ 54	1 987 470 506 <sup>8</sup>		
									0 986 473 384		← 53,94	F 026 A06 106 <sup>7</sup>		









































		S								
2.0 TDI		10.06-03.09	100	PR-Code 1ZE, PR-Code 1LJ	288,312		0 986 473 384	← 53,94	F 026 A06 106 <sup>7</sup>	
							0 986 473 384	← 53,94	1 987 470 506 <sup>8</sup>	
							0 986 474 384	→ 53,94	F 026 A06 106 <sup>7</sup>	
			PR-Code 1ZF	228			0 986 473 071	← 54	1 987 470 506 <sup>8</sup>	
							0 986 474 071	→ 54	1 987 470 506 <sup>8</sup>	
							0 986 473 384	← 53,94	F 026 A06 106 <sup>7</sup>	
		10.06-05.09	125	PR-Code 1ZE, PR-Code 1LJ	288,312		0 986 473 384	← 53,94	1 987 470 506 <sup>8</sup>	
							0 986 473 384	← 53,94	1 987 470 506 <sup>8</sup>	
							0 986 474 384	→ 53,94	F 026 A06 106 <sup>7</sup>	
	PR-Code 1ZF	228			0 986 473 071	← 54	1 987 470 506 <sup>8</sup>			
					0 986 474 071	→ 54	1 987 470 506 <sup>8</sup>			
					0 986 473 384	← 53,94	F 026 A06 106 <sup>7</sup>			
03.09-05.10	125				0 986 473 384	← 53,94	1 987 470 506 <sup>8</sup>			
					0 986 473 384	← 53,94	1 987 470 506 <sup>8</sup>			
					0 986 474 384	→ 53,94	F 026 A06 106 <sup>7</sup>			
2.0 TDI 2.0 TDI 4WD	05.06→	103				0 986 473 384	← 53,94	F 026 A06 106 <sup>7</sup>		
						0 986 473 384	← 53,94	1 987 470 506 <sup>8</sup>		
						0 986 474 384	→ 53,94	F 026 A06 106 <sup>7</sup>		
2.0 TFSI	10.06-03.09	147	PR-Code 1ZE, PR-Code 1LJ	288,312		0 986 473 384	← 53,94	F 026 A06 106 <sup>7</sup>		
						0 986 473 384	← 53,94	1 987 470 506 <sup>8</sup>		
						0 986 474 384	→ 53,94	F 026 A06 106 <sup>7</sup>		
						0 986 473 071	← 54	1 987 470 506 <sup>8</sup>		
						0 986 474 071	→ 54	1 987 470 506 <sup>8</sup>		
		04.10→	77			0 986 473 381	← 38,1	1 987 470 040		
						0 986 473 381	← 38,1	1 987 474 496 <sup>8</sup>		
						0 986 474 381	→ 38,1	1 987 470 040		
		1.4	10.06-05.10	63				0 986 474 381	→ 38,1	1 987 474 496 <sup>8</sup>
								0 986 473 381	← 38,1	1 987 470 040
								0 986 474 381	→ 38,1	1 987 470 040
			10.06-05.13	63				0 986 473 381	← 38,1	1 987 474 496 <sup>8</sup>
								0 986 473 381	← 38,1	1 987 470 040
								0 986 474 381	→ 38,1	1 987 474 496 <sup>8</sup>
		05.10-05.13	63					0 986 473 381	← 38,1	1 987 474 496 <sup>8</sup>
								0 986 473 381	← 38,1	1 987 470 040
								0 986 474 381	→ 38,1	1 987 474 496 <sup>8</sup>
		1.4 TSI	11.07→	92				0 986 473 381	← 38,1	1 987 470 040
								0 986 473 381	← 38,1	1 987 474 496 <sup>8</sup>
								0 986 474 381	→ 38,1	1 987 470 040
		1.6	10.06-05.13	75				0 986 473 381	← 38,1	1 987 470 040
								0 986 474 381	→ 38,1	1 987 474 496 <sup>8</sup>
								0 986 473 381	← 38,1	1 987 470 040
		1.6, MultiFuel	10.06-05.13	75				0 986 474 381	→ 38,1	1 987 470 040
								0 986 473 381	← 38,1	1 987 474 496 <sup>8</sup>
								0 986 473 381	← 38,1	1 987 470 040
		1.6 1.6 TDI	09.09→	66/72-75				0 986 473 381	← 38,1	1 987 470 040
								0 986 473 381	← 38,1	1 987 474 496 <sup>8</sup>
								0 986 474 381	→ 38,1	1 987 470 040
1.6 MultiFuel	12.07-11.10	75				0 986 473 381	← 38,1	1 987 470 040		
						0 986 473 381	← 38,1	1 987 474 496 <sup>8</sup>		
						0 986 474 381	→ 38,1	1 987 470 040		
1.6 TDI	10.09→	77				0 986 473 381	← 38,1	1 987 470 040		
						0 986 473 381	← 38,1	1 987 474 496 <sup>8</sup>		
						0 986 474 381	→ 38,1	1 987 470 040		
						0 986 473 381	← 38,1	1 987 470 040		
						0 986 473 381	← 38,1	1 987 474 496 <sup>8</sup>		
						0 986 474 381	→ 38,1	1 987 470 040		
1.8 TSI	01.07-03.09	118	PR-Code 1KD			0 986 473 381	← 38,1	1 987 470 040		
						0 986 473 381	← 38,1	1 987 474 496 <sup>8</sup>		
						0 986 474 381	→ 38,1	1 987 470 040		
						0 986 473 448	← 41	1 987 470 040		
						0 986 474 448	→ 41	1 987 470 040		
						0 986 134 048	← 38			
		PR-Code 1KF					0 986 135 048	← 38		
							0 986 134 048	← 38		
							0 986 135 048	← 38		
							0 986 135 048	← 38		
							0 986 135 048	← 38		
							0 986 135 048	← 38		
03.09→	118					0 986 473 381	← 38,1	1 987 470 040		
						0 986 473 381	← 38,1	1 987 474 496 <sup>8</sup>		
						0 986 474 381	→ 38,1	1 987 470 040		
1.9 TDI	10.06-12.10	66/77				0 986 473 381	← 38,1	1 987 470 040		
						0 986 473 381	← 38,1	1 987 474 496 <sup>8</sup>		
						0 986 474 381	→ 38,1	1 987 470 040		
						0 986 473 381	← 38,1	1 987 470 040		
2.0 FSI	10.06-03.09	110	PR-Code 1KD			0 986 473 381	← 38,1	1 987 470 040		
						0 986 473 381	← 38,1	1 987 474 496 <sup>8</sup>		
						0 986 474 381	→ 38,1	1 987 470 040		











































































SEAT Altea XL [5P5]							
2.0 FSI	10.06-03.09	110	PR-Code 1KF	0986 473 448	↻ ← 41	1987 470 040	
				0986 474 448	↻ → 41	1987 470 040	
2.0 FSI	10.06-03.09	110	PR-Code 1KJ	0986 134 048	↻ ← 38		
				0986 135 048	↻ → 38		
			PR-Code 1KZ	0986 134 048	↻ ← 38		
				0986 135 048	↻ → 38		
2.0 TDI	10.06-03.09	100	PR-Code 1KD	0986 473 381	↻ ← 38,1	1987 470 040	
				0986 473 381	↻ ← 38,1	1987 474 496 <sup>8</sup>	
			PR-Code 1KF	0986 474 381	↻ → 38,1	1987 470 040	
				0986 473 448	↻ ← 41	1987 470 040	
			PR-Code 1KJ	0986 474 448	↻ → 41	1987 470 040	
				0986 134 048	↻ ← 38		
	10.06-05.09	125	PR-Code 1KD	0986 473 381	↻ ← 38,1	1987 470 040	
				0986 473 381	↻ ← 38,1	1987 474 496 <sup>8</sup>	
			PR-Code 1KF	0986 474 381	↻ → 38,1	1987 470 040	
				0986 473 448	↻ ← 41	1987 470 040	
			PR-Code 1KJ	0986 474 448	↻ → 41	1987 470 040	
				0986 134 048	↻ ← 38		
10.06-11.10	103	PR-Code 1KZ	0986 134 048	↻ ← 38			
			0986 135 048	↻ → 38			
		10.06-11.10	103	PR-Code 1KD	0986 474 381	↻ → 38,1	1987 474 496 <sup>8</sup>
					0986 134 203	↻ ← 38	
		03.09-05.10	125	PR-Code 1KF	0986 135 203	↻ → 38	
					0986 134 048	↻ ← 38,1	1987 470 040
2.0 TDI	05.06-→	103	PR-Code 1KJ	0986 473 381	↻ ← 38,1	1987 470 040	
				0986 473 381	↻ ← 38,1	1987 474 496 <sup>8</sup>	
2.0 TDI 4WD	05.06-→	103	PR-Code 1KF	0986 474 381	↻ → 38,1	1987 470 040	
				0986 473 381	↻ ← 38,1	1987 470 040	
2.0 TFSI	10.06-03.09	147	PR-Code 1KD	0986 473 381	↻ ← 38,1	1987 470 040	
				0986 473 381	↻ ← 38,1	1987 474 496 <sup>8</sup>	
			PR-Code 1KF	0986 474 381	↻ → 38,1	1987 470 040	
				0986 473 448	↻ ← 41	1987 470 040	
			PR-Code 1KJ	0986 474 448	↻ → 41	1987 470 040	
				0986 134 048	↻ ← 38		
	10.06-03.09	147	PR-Code 1KZ	0986 135 048	↻ → 38		
				0986 134 048	↻ ← 38		
			PR-Code 1KF	0986 473 448	↻ ← 41	1987 470 040	
				0986 474 448	↻ → 41	1987 470 040	
			PR-Code 1KJ	0986 134 048	↻ ← 38		
				0986 135 048	↻ → 38		

		1.2 TSI	04.10-→	77	1987 477 958	↔ 1447
		1.4	10.06-05.13	63/92	1987 477 958	↔ 1447
		1.4 TSI	11.07-→	63/92	1987 477 958	↔ 1447
		1.6	10.06-05.13	75	1987 477 957	↔ 1447
			09.09-→	66/72-75	1987 477 958	↔ 1447
		1.6 MultiFuel	12.07-11.10	75	1987 477 957	↔ 1447
		1.6 TDI	10.09-→	77	1987 477 958	↔ 1447
			05.10-→	66/72-75	1987 477 958	↔ 1447
		1.8 TSI	01.07-03.09	118	1987 477 957	→ 1447
			01.07-→	118	1987 477 958	← 1447
			03.09-→	118	1987 477 958	→ 1447
		1.9 TDI	10.06-12.10	66/77	1987 477 958	↔ 1447
		2.0 FSI	10.06-03.09	110	1987 477 957	→ 1447
					1987 477 958	← 1447
		2.0 TDI	05.06-09.11	103	1987 477 957	→ 1447
			05.06-→	103	1987 477 958	← 1447
			10.06-03.09	100	1987 477 957	→ 1447
					1987 477 958	← 1447
			10.06-05.09	125	1987 477 957	→ 1447
			10.06-05.10	125	1987 477 958	← 1447
03.09-05.10	125		1987 477 958	→ 1447		

								
2.0 TDI	10.10→	103				1 987 477 958	→ 1447	
2.0 TDI 4WD	10.10→	103				1 987 477 958	↔ 1447	
2.0 TFSI	10.06-03.09	147				1 987 477 957	→ 1447	
						1 987 477 958	← 1447	
 1.2 TSI	04.10→	77			LAB	0 986 594 504 <sup>3</sup>		
					RAB	0 986 594 505 <sup>3</sup>		
1.4	10.06-10.09	63/92			LAB	0 986 594 506 <sup>4</sup>		
1.4 TSI					RAB	0 986 594 507 <sup>4</sup>		
	10.06→	63/92			LAB	0 986 594 504 <sup>3</sup>		
					RAB	0 986 594 505 <sup>3</sup>		
1.6	10.06-10.09	72-75			LAB	0 986 594 506 <sup>4</sup>		
1.6 MultiFuel					RAB	0 986 594 507 <sup>4</sup>		
	10.06→	72-75			LAB	0 986 594 504 <sup>3</sup>		
					RAB	0 986 594 505 <sup>3</sup>		
1.6 TDI	10.09→	77			LAB	0 986 594 504 <sup>3</sup>		
					RAB	0 986 594 505 <sup>3</sup>		
	05.10→	66			LAB	0 986 594 504 <sup>3</sup>		
					RAB	0 986 594 505 <sup>3</sup>		
1.8 TSI	01.07-10.09	118			LAB	0 986 594 506 <sup>4</sup>		
					RAB	0 986 594 507 <sup>4</sup>		
	01.07→	118			LAB	0 986 594 504 <sup>3</sup>		
					RAB	0 986 594 505 <sup>3</sup>		
1.9 TDI	10.06-10.09	66/77			LAB	0 986 594 506 <sup>4</sup>		
					RAB	0 986 594 507 <sup>4</sup>		
	10.06-12.10	66/77			LAB	0 986 594 504 <sup>3</sup>		
					RAB	0 986 594 505 <sup>3</sup>		
2.0 FSI, TDI, TDI 4WD, TFSI	05.06→	100/103/110/ 125/147			LAB	0 986 594 504 <sup>3</sup>		
					RAB	0 986 594 505 <sup>3</sup>		
2.0 FSI, TDI, TFSI	05.06-10.09	100/103/110/ 125/147			LAB	0 986 594 506 <sup>4</sup>		
					RAB	0 986 594 507 <sup>4</sup>		
<b>Altea [5P1]</b>								
								
 1.2 TSI	05.10→	77				0 986 473 071	 ← 54	1 987 470 506 <sup>8</sup>
						0 986 474 071	 → 54	1 987 470 506 <sup>8</sup>
1.4	05.06-05.13	63				0 986 473 071	 ← 54	1 987 470 506 <sup>8</sup>
						0 986 474 071	 → 54	1 987 470 506 <sup>8</sup>
1.4 TSI	11.07→	92				0 986 473 384	 ← 53,94	F 026 A06 106 <sup>7</sup>
						0 986 473 384	 ← 53,94	1 987 470 506 <sup>8</sup>
						0 986 474 384	 → 53,94	F 026 A06 106 <sup>7</sup>
1.6	03.04-05.05	75	PR-Code 1ZE, PR-Code 1LJ	288,312		0 986 473 384	 ← 53,94	F 026 A06 106 <sup>7</sup>
						0 986 473 384	 ← 53,94	1 987 470 506 <sup>8</sup>
						0 986 474 384	 → 53,94	F 026 A06 106 <sup>7</sup>
			PR-Code 1ZF	228		0 986 473 071	 ← 54	1 987 470 506 <sup>8</sup>
						0 986 474 071	 → 54	1 987 470 506 <sup>8</sup>
	05.05-05.13	75				0 986 473 071	 ← 54	1 987 470 506 <sup>8</sup>
						0 986 474 071	 → 54	1 987 470 506 <sup>8</sup>
	09.09→	72-75				0 986 473 071	 ← 54	1 987 470 506 <sup>8</sup>
						0 986 474 071	 → 54	1 987 470 506 <sup>8</sup>
1.6 MultiFuel	12.07-05.11	75				0 986 473 071	 ← 54	1 987 470 506 <sup>8</sup>
						0 986 474 071	 → 54	1 987 470 506 <sup>8</sup>
1.6 TDI	10.09→	77				0 986 473 384	 ← 53,94	F 026 A06 106 <sup>7</sup>
						0 986 473 384	 ← 53,94	1 987 470 506 <sup>8</sup>
						0 986 474 384	 → 53,94	F 026 A06 106 <sup>7</sup>
	05.10→	66				0 986 473 384	 ← 53,94	F 026 A06 106 <sup>7</sup>
						0 986 473 384	 ← 53,94	1 987 470 506 <sup>8</sup>
						0 986 474 384	 → 53,94	F 026 A06 106 <sup>7</sup>
1.8 TSI	01.07-03.09	118	PR-Code 1ZE, PR-Code 1LJ	288,312		0 986 473 384	 ← 53,94	F 026 A06 106 <sup>7</sup>
						0 986 473 384	 ← 53,94	1 987 470 506 <sup>8</sup>
						0 986 474 384	 → 53,94	F 026 A06 106 <sup>7</sup>

		S							
SEAT Altea [5P1]									
1.8 TSI	01.07-03.09	118	PR-Code 1ZF	228	0986 473 071		← 54	1987 470 506 <sup>8</sup>	
					0986 474 071		→ 54	1987 470 506 <sup>8</sup>	
	03.09→	118			0986 473 384		← 53,94	F 026 A06 106 <sup>7</sup>	
					0986 473 384		← 53,94	1987 470 506 <sup>8</sup>	
					0986 474 384		→ 53,94	F 026 A06 106 <sup>7</sup>	
1.9 TDI	04.04-05.06	77	PR-Code 1ZE, PR-Code 1LJ	288,312	0986 473 384		← 53,94	F 026 A06 106 <sup>7</sup>	
					0986 473 384		← 53,94	1987 470 506 <sup>8</sup>	
					0986 474 384		→ 53,94	F 026 A06 106 <sup>7</sup>	
			PR-Code 1ZF	228	0986 473 071		← 54	1987 470 506 <sup>8</sup>	
					0986 474 071		→ 54	1987 470 506 <sup>8</sup>	
	10.05-12.10	77			0986 473 384		← 53,94	F 026 A06 106 <sup>7</sup>	
					0986 473 384		← 53,94	1987 470 506 <sup>8</sup>	
					0986 474 384		→ 53,94	F 026 A06 106 <sup>7</sup>	
	08.09-12.10	66			0986 473 384		← 53,94	F 026 A06 106 <sup>7</sup>	
					0986 473 384		← 53,94	1987 470 506 <sup>8</sup>	
					0986 474 384		→ 53,94	F 026 A06 106 <sup>7</sup>	
2.0 FSI	05.04-03.09	110	PR-Code 1ZE, PR-Code 1LJ	288,312	0986 473 384		← 53,94	F 026 A06 106 <sup>7</sup>	
					0986 473 384		← 53,94	1987 470 506 <sup>8</sup>	
					0986 474 384		→ 53,94	F 026 A06 106 <sup>7</sup>	
			PR-Code 1ZF	228	0986 473 071		← 54	1987 470 506 <sup>8</sup>	
					0986 474 071		→ 54	1987 470 506 <sup>8</sup>	
2.0 TDI	03.04→	103			0986 473 384		← 53,94	F 026 A06 106 <sup>7</sup>	
					0986 473 384		← 53,94	1987 470 506 <sup>8</sup>	
					0986 474 384		→ 53,94	F 026 A06 106 <sup>7</sup>	
	04.04-03.09	100	PR-Code 1ZE, PR-Code 1LJ	288,312	0986 473 384		← 53,94	F 026 A06 106 <sup>7</sup>	
					0986 473 384		← 53,94	1987 470 506 <sup>8</sup>	
					0986 474 384		→ 53,94	F 026 A06 106 <sup>7</sup>	
			PR-Code 1ZF	228	0986 473 071		← 54	1987 470 506 <sup>8</sup>	
					0986 474 071		→ 54	1987 470 506 <sup>8</sup>	
	11.05-03.09	125	PR-Code 1ZE, PR-Code 1LJ	288,312	0986 473 384		← 53,94	F 026 A06 106 <sup>7</sup>	
					0986 473 384		← 53,94	1987 470 506 <sup>8</sup>	
					0986 474 384		→ 53,94	F 026 A06 106 <sup>7</sup>	
			PR-Code 1ZF	228	0986 473 071		← 54	1987 470 506 <sup>8</sup>	
					0986 474 071		→ 54	1987 470 506 <sup>8</sup>	
	03.09-05.10	125			0986 473 384		← 53,94	F 026 A06 106 <sup>7</sup>	
					0986 473 384		← 53,94	1987 470 506 <sup>8</sup>	
					0986 474 384		→ 53,94	F 026 A06 106 <sup>7</sup>	
2.0 TFSI	05.06-03.09	147	PR-Code 1ZE, PR-Code 1LJ	288,312	0986 473 384		← 53,94	F 026 A06 106 <sup>7</sup>	
					0986 473 384		← 53,94	1987 470 506 <sup>8</sup>	
					0986 474 384		→ 53,94	F 026 A06 106 <sup>7</sup>	
			PR-Code 1ZF	228	0986 473 071		← 54	1987 470 506 <sup>8</sup>	
					0986 474 071		→ 54	1987 470 506 <sup>8</sup>	
1.2 TSI	05.10→	77			0986 473 381		← 38,1	1987 470 040	
					0986 473 381		← 38,1	1987 474 496 <sup>8</sup>	
					0986 474 381		→ 38,1	1987 470 040	
1.4	05.06-05.10	63			0986 474 381		→ 38,1	1987 474 496 <sup>8</sup>	
					0986 473 381		← 38,1	1987 470 040	
					0986 474 381		→ 38,1	1987 470 040	
					0986 473 381		← 38,1	1987 474 496 <sup>8</sup>	
	05.10-05.13	63			0986 473 381		← 38,1	1987 474 496 <sup>8</sup>	
1.4 TSI	11.07→	92			0986 473 381		← 38,1	1987 470 040	
					0986 473 381		← 38,1	1987 474 496 <sup>8</sup>	
					0986 474 381		→ 38,1	1987 470 040	
1.6	03.04-05.05	75	PR-Code 1KD		0986 473 381		← 38,1	1987 470 040	
					0986 473 381		← 38,1	1987 474 496 <sup>8</sup>	
					0986 474 381		→ 38,1	1987 470 040	
			PR-Code 1KF		0986 473 448		← 41	1987 470 040	
					0986 474 448		→ 41	1987 470 040	
			PR-Code 1KJ		0986 134 048		← 38		
					0986 135 048		→ 38		

		<b>S</b>									
<b>1.6</b>	03.04-05.05	75	PR-Code 1KZ	0 986 <b>134 048</b>		← 38					
				0 986 <b>135 048</b>		→ 38					
				0 986 <b>473 381</b>		← 38,1	1 987 <b>470 040</b>				
				0 986 <b>473 381</b>		← 38,1	1 987 <b>474 496<sup>B</sup></b>				
				0 986 <b>474 381</b>		→ 38,1	1 987 <b>470 040</b>				
<b>1.6</b> <b>1.6 TDI</b>	09.09→	66/72-75		0 986 <b>473 381</b>		← 38,1	1 987 <b>470 040</b>				
				0 986 <b>473 381</b>		← 38,1	1 987 <b>474 496<sup>B</sup></b>				
				0 986 <b>474 381</b>		→ 38,1	1 987 <b>470 040</b>				
<b>1.6 MultiFuel</b>	12.07-05.11	75		0 986 <b>473 381</b>		← 38,1	1 987 <b>470 040</b>				
				0 986 <b>473 381</b>		← 38,1	1 987 <b>474 496<sup>B</sup></b>				
				0 986 <b>474 381</b>		→ 38,1	1 987 <b>470 040</b>				
<b>1.6 TDI</b>	10.09→	77		0 986 <b>473 381</b>		← 38,1	1 987 <b>470 040</b>				
				0 986 <b>473 381</b>		← 38,1	1 987 <b>474 496<sup>B</sup></b>				
				0 986 <b>474 381</b>		→ 38,1	1 987 <b>470 040</b>				
<b>1.8 TSI</b>	01.07-03.09	118	PR-Code 1KD	0 986 <b>473 381</b>		← 38,1	1 987 <b>470 040</b>				
				0 986 <b>473 381</b>		← 38,1	1 987 <b>474 496<sup>B</sup></b>				
				0 986 <b>474 381</b>		→ 38,1	1 987 <b>470 040</b>				
				PR-Code 1KF	0 986 <b>473 448</b>		← 41	1 987 <b>470 040</b>			
					0 986 <b>474 448</b>		→ 41	1 987 <b>470 040</b>			
				PR-Code 1KJ	0 986 <b>134 048</b>		← 38				
	03.09→	118		PR-Code 1KZ	0 986 <b>135 048</b>		→ 38				
					0 986 <b>134 048</b>		← 38				
					0 986 <b>135 048</b>		→ 38				
					0 986 <b>473 381</b>		← 38,1	1 987 <b>470 040</b>			
					0 986 <b>473 381</b>		← 38,1	1 987 <b>474 496<sup>B</sup></b>			
					0 986 <b>474 381</b>		→ 38,1	1 987 <b>470 040</b>			
<b>1.9 TDI</b>	04.04-05.06	77	PR-Code 1KD	0 986 <b>473 381</b>		← 38,1	1 987 <b>470 040</b>				
				0 986 <b>473 381</b>		← 38,1	1 987 <b>474 496<sup>B</sup></b>				
				0 986 <b>474 381</b>		→ 38,1	1 987 <b>470 040</b>				
				PR-Code 1KF	0 986 <b>473 448</b>		← 41	1 987 <b>470 040</b>			
					0 986 <b>474 448</b>		→ 41	1 987 <b>470 040</b>			
				PR-Code 1KJ	0 986 <b>134 048</b>		← 38				
	10.05-12.10	77		PR-Code 1KZ	0 986 <b>135 048</b>		→ 38				
					0 986 <b>134 048</b>		← 38				
					0 986 <b>473 381</b>		← 38,1	1 987 <b>470 040</b>			
					0 986 <b>473 381</b>		← 38,1	1 987 <b>474 496<sup>B</sup></b>			
					0 986 <b>474 381</b>		→ 38,1	1 987 <b>470 040</b>			
					0 986 <b>473 381</b>		← 38,1	1 987 <b>470 040</b>			
08.09-12.10	66			0 986 <b>473 381</b>		← 38,1	1 987 <b>470 040</b>				
				0 986 <b>473 381</b>		← 38,1	1 987 <b>474 496<sup>B</sup></b>				
				0 986 <b>474 381</b>		→ 38,1	1 987 <b>470 040</b>				
				0 986 <b>473 381</b>		← 38,1	1 987 <b>470 040</b>				
				0 986 <b>473 381</b>		← 38,1	1 987 <b>474 496<sup>B</sup></b>				
				0 986 <b>474 381</b>		→ 38,1	1 987 <b>470 040</b>				
<b>2.0 FSI</b>	05.04-03.09	110	PR-Code 1KD	0 986 <b>473 381</b>		← 38,1	1 987 <b>470 040</b>				
				0 986 <b>473 381</b>		← 38,1	1 987 <b>474 496<sup>B</sup></b>				
				0 986 <b>474 381</b>		→ 38,1	1 987 <b>470 040</b>				
				PR-Code 1KF	0 986 <b>473 448</b>		← 41	1 987 <b>470 040</b>			
					0 986 <b>474 448</b>		→ 41	1 987 <b>470 040</b>			
				PR-Code 1KJ	0 986 <b>134 048</b>		← 38				
<b>2.0 TDI</b>	03.04-07.11	103		0 986 <b>135 048</b>		→ 38					
				0 986 <b>134 048</b>		← 38					
				0 986 <b>474 381</b>		→ 38,1	1 987 <b>474 496<sup>B</sup></b>				
	03.04→	103			0 986 <b>473 381</b>		← 38,1	1 987 <b>470 040</b>			
					0 986 <b>474 381</b>		→ 38,1	1 987 <b>470 040</b>			
					0 986 <b>473 381</b>		← 38,1	1 987 <b>470 040</b>			
	04.04-03.09	100		PR-Code 1KD	0 986 <b>473 381</b>		← 38,1	1 987 <b>470 040</b>			
					0 986 <b>473 381</b>		← 38,1	1 987 <b>474 496<sup>B</sup></b>			
					0 986 <b>474 381</b>		→ 38,1	1 987 <b>470 040</b>			
					PR-Code 1KF	0 986 <b>473 448</b>		← 41	1 987 <b>470 040</b>		
						0 986 <b>474 448</b>		→ 41	1 987 <b>470 040</b>		
					PR-Code 1KJ	0 986 <b>134 048</b>		← 38			
					0 986 <b>135 048</b>		→ 38				
PR-Code 1KZ					0 986 <b>134 048</b>		← 38				
					0 986 <b>135 048</b>		→ 38				









































			S									
SEAT Altea [5P1]												
2.0 TDI	11.05-03.09	125	PR-Code 1KD	0986 473 381		38,1	1987 470 040					
				0986 473 381		38,1	1987 474 496 <sup>8</sup>					
				0986 474 381		38,1	1987 470 040					
				PR-Code 1KF	0986 473 448		41	1987 470 040				
				PR-Code 1KJ	0986 474 448		41	1987 470 040				
				PR-Code 1KZ	0986 134 048		38					
					0986 135 048		38					
	11.05-11.10	103	PR-Code 1KD	0986 473 381		38,1	1987 474 496 <sup>8</sup>					
				PR-Code 1KF	0986 473 448		41	1987 470 040				
				PR-Code 1KZ	0986 474 448		41	1987 470 040				
				PR-Code 1KJ	0986 134 048		38					
				PR-Code 1KZ	0986 134 048		38					
				PR-Code 1KZ	0986 135 048		38					
	03.09-05.10	125	PR-Code 1KJ	0986 134 203		38						
				PR-Code 1KZ	0986 135 203		38					
	09.10→	103	PR-Code 1KJ	0986 473 381		38,1	1987 474 496 <sup>8</sup>					
	2.0 TFSI	05.06-03.09	147	PR-Code 1KD	0986 473 381		38,1	1987 470 040				
					0986 473 381		38,1	1987 474 496 <sup>8</sup>				
0986 474 381						38,1	1987 470 040					
PR-Code 1KF					0986 473 448		41	1987 470 040				
PR-Code 1KJ					0986 474 448		41	1987 470 040				
PR-Code 1KZ					0986 134 048		38					
					0986 135 048		38					
					0986 134 048		38					
					0986 135 048		38					
					0986 134 048		38					
					0986 135 048		38					
S	1.2 TSI	05.10→	77	1987 477 958		1447						
				1.4	05.06-05.10	63	1987 477 957		1447			
					05.06-05.13	63	1987 477 958		1447			
		05.10-05.13	63	1987 477 958		1447						
	1.4 TSI	11.07→	92	1987 477 958		1447						
	1.6	03.04-05.05	75	1987 482 445		1447						
		05.05-11.05	75	Fg.-Nr. →5P..5..048 330	1987 482 445		1447					
		05.05-05.13	75	1987 477 958		1447						
		12.05-05.13	75	Fg.-Nr. 5P..5..048 331→	1987 477 957		1447					
		09.09→	66/72-75	1987 477 958		1447						
		1.6 MultiFuel	12.07-05.11	75	1987 477 957		1447					
	1.6 TDI	10.09→	77	1987 477 958		1447						
		05.10→	66/72-75	1987 477 958		1447						
	1.8 TSI	01.07-03.09	118	1987 477 957		1447						
		01.07→	118	1987 477 958		1447						
		03.09→	118	1987 477 958		1447						
	1.9 TDI	04.04-09.05	77	1987 482 445		1447						
		10.05-11.05	77	Fg.-Nr. →5P..5..048 330	1987 482 445		1447					
		12.05-05.10	77	Fg.-Nr. 5P..5..048 331→	1987 477 957		1447					
					1987 477 958		1447					
		02.06-12.10	77	1987 477 958		1447						
		08.09-12.10	66	1987 477 958		1447						
	2.0 FSI	05.04-11.05	110	1987 482 445		1447						
		12.05-03.09	110	Fg.-Nr. 5P..5..048 331→	1987 477 957		1447					
					1987 477 958		1447					
	2.0 TDI	03.04-11.05	103	Fg.-Nr. →5P..5..048 330	1987 482 445		1447					
		11.05-11.05	125	Fg.-Nr. →5P..5..048 330	1987 482 445		1447					
		12.05-03.09	100	Fg.-Nr. 5P..5..048 331→	1987 477 957		1447					
					1987 477 958		1447					
			125	Fg.-Nr. 5P..5..048 331→	1987 477 957		1447					
				1987 477 958		1447						
12.05-07.11		103	Fg.-Nr. 5P..5..048 331→	1987 477 957		1447						
				1987 477 958		1447						
03.09-05.10		125	1987 477 958		1447							

		S							
2.0 TDI		09.10→	103				1 987 477 958	↔ 1447	
2.0 TFSI		05.06-03.09	147				1 987 477 957	→ 1447	
							1 987 477 958	← 1447	
	1.2 TSI	05.10→	77			LAB	0 986 594 504 <sup>3</sup>		
						RAB	0 986 594 505 <sup>3</sup>		
	1.4	05.06-10.09	63/92			LAB	0 986 594 506 <sup>4</sup>		
	1.4 TSI					RAB	0 986 594 507 <sup>4</sup>		
		05.06→	63/92			LAB	0 986 594 504 <sup>3</sup>		
						RAB	0 986 594 505 <sup>3</sup>		
	1.6	03.04-10.09	72-75			LAB	0 986 594 506 <sup>4</sup>		
	1.6 MultiFuel					RAB	0 986 594 507 <sup>4</sup>		
		03.04→	72-75			LAB	0 986 594 504 <sup>3</sup>		
						RAB	0 986 594 505 <sup>3</sup>		
	1.6 TDI	10.09→	77			LAB	0 986 594 504 <sup>3</sup>		
						RAB	0 986 594 505 <sup>3</sup>		
		05.10→	66			LAB	0 986 594 504 <sup>3</sup>		
						RAB	0 986 594 505 <sup>3</sup>		
	1.8 TSI	01.07-10.09	118			LAB	0 986 594 506 <sup>4</sup>		
						RAB	0 986 594 507 <sup>4</sup>		
		01.07→	118			LAB	0 986 594 504 <sup>3</sup>		
						RAB	0 986 594 505 <sup>3</sup>		
	1.9 TDI	04.04-10.09	66/77			LAB	0 986 594 506 <sup>4</sup>		
						RAB	0 986 594 507 <sup>4</sup>		
		04.04-12.10	66/77			LAB	0 986 594 504 <sup>3</sup>		
						RAB	0 986 594 505 <sup>3</sup>		
	2.0 FSI	03.04-10.09	100/103/110/			LAB	0 986 594 506 <sup>4</sup>		
	2.0 TDI		125/147			RAB	0 986 594 507 <sup>4</sup>		
	2.0 TFSI	03.04→	100/103/110/			LAB	0 986 594 504 <sup>3</sup>		
			125/147			RAB	0 986 594 505 <sup>3</sup>		
<b>Arosa [6H1]</b>									
	1.0	02.97-06.04	37			INB	0 986 473 149	← 54	1 987 470 287 <sup>7</sup>
							0 986 474 149	→ 54	1 987 470 287 <sup>7</sup>
						INB	0 204 102 920	← 48	0 204 104 144 <sup>7</sup>
							0 204 102 921	→ 48	0 204 104 144 <sup>7</sup>
	1.4	02.97-06.04	44				0 204 102 580	← 48	0 204 104 144 <sup>7</sup>
							0 986 134 020		
							0 204 102 581	→ 48	0 204 104 144 <sup>7</sup>
							0 204 103 581		
							0 986 135 020		
	1.4 TDI	01.98-06.04	55/74				0 986 473 149	← 54	1 987 470 287 <sup>7</sup>
	1.4 16V						0 986 474 149	→ 54	1 987 470 287 <sup>7</sup>
	1.7 SDI	08.97-10.03	44				0 204 102 580	← 48	0 204 104 144 <sup>7</sup>
							0 986 134 020		
							0 204 102 581	→ 48	0 204 104 144 <sup>7</sup>
							0 204 103 581		
							0 986 135 020		
	1.0	ABO 02.97-06.04	37				0 986 475 438	↔ 15,87	
		ABS 02.97-06.04	37				0 986 475 260	↔ 17,46	
	1.4, TDI, 16V	ABO 02.97-06.04	44/55/74				0 986 475 438	↔ 15,87	
		ABS 02.97-06.04	44/55/74				0 986 475 260	↔ 17,46	
	1.7 SDI	ABO 08.97-10.03	44				0 986 475 438	↔ 15,87	
		ABS 08.97-10.03	44				0 986 475 260	↔ 17,46	
	1.4, TDI, 16V	02.97-06.04	44/55/74				0 986 473 352	← 33,9	1 987 474 496 <sup>8</sup>
							0 986 474 352	→ 33,9	1 987 474 496 <sup>8</sup>



			S								
<b>SEAT Arosa [6H1]</b>											
1.7 SDI		08.97-10.03	44					0986 473 352		33,9	1987 474 496 <sup>8</sup>
								0986 474 352		33,9	1987 474 496 <sup>8</sup>
<b>U</b>											
1.0		02.97-07.00	37		TBR			1987 477 680		1392	
		02.97-06.04	37		SBR			1987 477 705		1496	
		05.00-06.02	37	Fg.-Nr. →6H..3..004 732	TBR			1987 477 680		1392	
		07.02-06.04	37	Fg.-Nr. 6H..3..004 733→	TBR			1987 477 883		1395	
1.4		02.97-10.00	44		TBR			1987 477 680		1392	
		02.97-06.04	44		SBR			1987 477 705		1496	
		01.99-06.02	44	Fg.-Nr. →6H..3..004 732	TBR			1987 477 680		1392	
		07.02-06.04	44	Fg.-Nr. 6H..3..004 733→	TBR			1987 477 883		1395	
1.4 TDI		01.98-06.02	55	Fg.-Nr. →6H..3..004 732	TBR			1987 477 680		1392	
		01.98-06.04	55		SBR			1987 477 705		1496	
		07.02-06.04	55	Fg.-Nr. 6H..3..004 733→	TBR			1987 477 883		1395	
1.4 16V		01.99-09.00	74		TBR			1987 477 680		1392	
		01.99-06.04	74		SBR			1987 477 705		1496	
		09.00-06.02	74	Fg.-Nr. →6H..3..004 732	TBR			1987 477 680		1392	
		07.02-06.04	74	Fg.-Nr. 6H..3..004 733→	TBR			1987 477 883		1395	
1.7 SDI		08.97-06.02	44	Fg.-Nr. →6H..3..004 732	TBR			1987 477 680		1392	
		08.97-10.03	44		SBR			1987 477 705		1496	
		07.02-10.03	44	Fg.-Nr. 6H..3..004 733→	TBR			1987 477 883		1395	
<b>T</b>											
1.0		02.97-06.04	37					0986 594 004 <sup>4</sup>			
					LAB			0986 594 001 <sup>3</sup>			
					RAB			0986 594 000 <sup>3</sup>			
1.4		02.97-06.04	44/55/74					0986 594 004 <sup>4</sup>			
1.4 TDI					LAB			0986 594 001 <sup>3</sup>			
1.4 16V					RAB			0986 594 000 <sup>3</sup>			
1.7 SDI		08.97-10.03	44					0986 594 004 <sup>4</sup>			
					LAB			0986 594 001 <sup>3</sup>			
					RAB			0986 594 000 <sup>3</sup>			
<b>Cordoba Vario [6K5]</b>											
<b>S</b>											
1.4		05.97-08.03	44/55/74		1LA			0204 102 373		48	0204 104 144 <sup>7</sup>
								0204 103 373			
								0204 102 374		48	0204 104 144 <sup>7</sup>
								0204 103 374			
					1LM,239						0204 104 144 <sup>7</sup>
					1LY			0986 471 669		54	1987 470 287 <sup>7</sup>
								0986 473 669			
								0986 472 669		54	1987 470 287 <sup>7</sup>
								0986 474 669			
					228			0986 473 687		54	1987 470 287 <sup>7</sup>
								0986 474 687		54	1987 470 287 <sup>7</sup>
1.6		04.97-12.02	55/74		1LA			0204 102 373		48	0204 104 144 <sup>7</sup>
								0204 103 373			
								0204 102 374		48	0204 104 144 <sup>7</sup>
								0204 103 374			
					1LM,239						0204 104 144 <sup>7</sup>
					1LY			0986 471 669		54	1987 470 287 <sup>7</sup>
								0986 473 669			
								0986 472 669		54	1987 470 287 <sup>7</sup>
								0986 474 669			
					228			0986 473 687		54	1987 470 287 <sup>7</sup>
								0986 474 687		54	1987 470 287 <sup>7</sup>
1.8		07.96-06.99	66		1LA			0204 102 373		48	0204 104 144 <sup>7</sup>
								0204 103 373			
								0204 102 374		48	0204 104 144 <sup>7</sup>
								0204 103 374			

		S										
1.8		07.96-06.99	66			1LM,239			0 204 104 144 <sup>7</sup>			
						1LY	0 986 471 669	← 54	1 987 470 287 <sup>7</sup>			
							0 986 473 669					
							0 986 472 669	→ 54	1 987 470 287 <sup>7</sup>			
							0 986 474 669					
						228	0 986 473 687	 ← 54	1 987 470 287 <sup>7</sup>			
1.9 SDI		06.97-08.02	47/50/66/			1LA	0 204 102 373	← 48	0 204 104 144 <sup>7</sup>			
1.9 TDI			81				0 204 103 373					
							0 204 102 374	→ 48	0 204 104 144 <sup>7</sup>			
							0 204 103 374					
						1LM,239			0 204 104 144 <sup>7</sup>			
						1LY	0 986 471 669	← 54	1 987 470 287 <sup>7</sup>			
							0 986 473 669					
							0 986 472 669	→ 54	1 987 470 287 <sup>7</sup>			
							0 986 474 669					
						228	0 986 473 687	 ← 54	1 987 470 287 <sup>7</sup>			
							0 986 474 687	 → 54	1 987 470 287 <sup>7</sup>			
<hr/>												
												
1.4		05.97-12.02	44				0 986 475 260	↔ 17,46				
							0 986 475 433	↔ 19,05				
							05.99-08.03	55		0 986 475 260	↔ 17,46	
							09.99-07.00	74		0 986 475 433	↔ 19,05	
1.6		04.97-06.99	74				0 986 475 260	↔ 17,46				
							04.97-12.02	74		0 986 475 433	↔ 19,05	
							05.97-08.02	55		0 986 475 260	↔ 17,46	
							0 986 475 433	↔ 19,05				
		06.99-08.02	74			AG	0 986 475 260	↔ 17,46				
						GS	0 986 475 433	↔ 19,05				
		10.99-10.04	76				0 986 475 438	↔ 15,87				
1.8		07.96-06.99	66				0 986 475 260	↔ 17,46				
							0 986 475 433	↔ 19,05				
1.9 SDI		06.97-06.99	47				0 986 475 260	↔ 17,46				
							0 986 475 433	↔ 19,05				
		05.99-08.02	50				0 986 475 260	↔ 17,46				
1.9 TDI		06.97-06.99	66				0 986 475 260	↔ 17,46				
		06.97-08.02	66				0 986 475 433	↔ 19,05				
<hr/>												
1.4		05.99-08.03	44/55/74			BSR	0 986 473 352	 ← 33,9	1 987 474 496 <sup>8</sup>			
								0 986 474 352	 → 33,9	1 987 474 496 <sup>8</sup>		
						BSR	0 986 473 352	← 33,9	1 987 474 496 <sup>8</sup>			
							0 986 474 352	 → 33,9	1 987 474 496 <sup>8</sup>			
1.6		05.99-12.02	74			BSR	0 986 473 352	 ← 33,9	1 987 474 496 <sup>8</sup>			
								0 986 474 352	 → 33,9	1 987 474 496 <sup>8</sup>		
						BSR	0 986 473 352	 ← 33,9	1 987 474 496 <sup>8</sup>			
							0 986 474 352	 → 33,9	1 987 474 496 <sup>8</sup>			
1.9 SDI		05.99-08.02	50/66			BSR	0 986 473 352	 ← 33,9	1 987 474 496 <sup>8</sup>			
1.9 TDI							0 986 474 352	 → 33,9	1 987 474 496 <sup>8</sup>			
						BSR	0 986 473 352	 ← 33,9	1 987 474 496 <sup>8</sup>			
							0 986 474 352	 → 33,9	1 987 474 496 <sup>8</sup>			
1.9 TDI		02.98-06.99	81			1KD	0 986 473 150	← 38,1	1 987 470 040			
							0 986 474 150	 → 38,1	1 987 470 040			
						1KP			1 987 470 040			
		05.99-08.02	81			BSR	0 986 473 352	 ← 33,9	1 987 474 496 <sup>8</sup>			
							0 986 474 352	 → 33,9	1 987 474 496 <sup>8</sup>			
						BSR	0 986 473 352	 ← 33,9	1 987 474 496 <sup>8</sup>			
							0 986 474 352	 → 33,9	1 987 474 496 <sup>8</sup>			



SEAT Cordoba Vario [6K5]











































	1.4	05.97-08.97	44			1987 477 284	↔ 1511			
		09.97-03.98	44	Fg.-Nr. →6K..W..169 289		1987 477 284	↔ 1511			
		05.99-12.02	44			SBR	1987 477 627	↔ 1641		
						TBR	1987 477 695	↔ 1514		
		05.99-08.03	55/74			SBR	1987 477 627	↔ 1641		
						TBR	1987 477 695	↔ 1514		
		ABO 04.98-12.02	44	Fg.-Nr. 6K..W..169 290→			1987 477 679	↔ 1512		
		ABS 04.98-12.02	44	Fg.-Nr. 6K..W..169 290→			1987 477 695	↔ 1514		
		1.6	04.97-03.98	74	Fg.-Nr. →6K..W..169 289		1987 477 284	↔ 1511		
			05.97-03.98	55	Fg.-Nr. →6K..W..169 289		1987 477 284	↔ 1511		
			05.99-12.02	74			SBR	1987 477 627	↔ 1641	
							TBR	1987 477 695	↔ 1514	
10.99-10.04	76					1987 477 695	1514			
ABO 04.98-08.02	55/74		Fg.-Nr. 6K..W..169 290→			1987 477 679	↔ 1512			
ABS 04.98-08.02	55/74	Fg.-Nr. 6K..W..169 290→			1987 477 695	↔ 1514				
1.8	07.96-03.98	66	Fg.-Nr. →6K..W..169 289		1987 477 284	↔ 1511				
	ABO 04.98-06.99	66	Fg.-Nr. 6K..W..169 290→		1987 477 679	↔ 1512				
	ABS 04.98-06.99	66	Fg.-Nr. 6K..W..169 290→		1987 477 695	↔ 1514				
1.9 SDI	06.97-03.98	47	Fg.-Nr. →6K..W..169 289		1987 477 284	↔ 1511				
	05.99-08.02	50			SBR	1987 477 627	↔ 1641			
				TBR	1987 477 695	↔ 1514				
	ABO 04.98-06.99	47/66	Fg.-Nr. 6K..W..169 290→		1987 477 679	↔ 1512				
	ABS 04.98-06.99	47/66	Fg.-Nr. 6K..W..169 290→		1987 477 695	↔ 1514				
1.9 TDI	06.97-03.98	66	Fg.-Nr. →6K..W..169 289		1987 477 284	↔ 1511				
	02.98-08.02	81			1987 477 627	↔ 1641				
	05.99-08.02	66			SBR	1987 477 627	↔ 1641			
					TBR	1987 477 695	↔ 1514			
	ABO 04.98-06.99	47/66	Fg.-Nr. 6K..W..169 290→			1987 477 679	↔ 1512			
	ABS 04.98-06.99	47/66	Fg.-Nr. 6K..W..169 290→			1987 477 695	↔ 1514			

	1.4	05.97-08.03	44/55/74			0986 594 009 <sup>4</sup>							
					LAB	0986 594 001 <sup>3</sup>							
					RAB	0986 594 000 <sup>3</sup>							
				1.6	04.97-10.04	74/76			0986 594 009 <sup>4</sup>				
								LAB	0986 594 001 <sup>3</sup>				
								RAB	0986 594 000 <sup>3</sup>				
							05.97-06.99	55		TW	0986 594 009 <sup>4</sup>		
							05.97-08.02	55			0986 594 009 <sup>4</sup>		
										LAB	0986 594 001 <sup>3</sup>		
							RAB	0986 594 000 <sup>3</sup>					
				1.8	07.96-06.99	66			0986 594 001 <sup>3</sup>				
								RAB	0986 594 000 <sup>3</sup>				
	TW	0986 594 009 <sup>4</sup>											
1.9 SDI	06.97-08.02	47/50/66/			0986 594 009 <sup>4</sup>								
1.9 TDI		81			0986 594 001 <sup>3</sup>								
				RAB	0986 594 000 <sup>3</sup>								

Cordoba [6K2]





























































	1.0	09.96-12.02	37/51	1LA	0204 102 373	← 48	0204 104 144 <sup>7</sup>	
					0204 103 373	↻		
					0204 102 374	→ 48	0204 104 144 <sup>7</sup>	
					0204 103 374	↻		
					1LM,239		0204 104 144 <sup>7</sup>	
					1LY	0986 471 669	← 54	1987 470 287 <sup>7</sup>
						0986 473 669	↻	
						0986 472 669	→ 54	1987 470 287 <sup>7</sup>
						0986 474 669	↻	
					228	0986 473 687	↻ ← 54	1987 470 287 <sup>7</sup>
						0986 474 687	↻ → 54	1987 470 287 <sup>7</sup>

		<b>S</b>								
<b>1.4</b>	09.93-12.97	44			1LM				0 204 104 144 <sup>7</sup>	
	09.93-12.02	44			1LA	0 204 102 373	← 48		0 204 104 144 <sup>7</sup>	
						0 204 103 373				
						0 204 102 374	→ 48		0 204 104 144 <sup>7</sup>	
						0 204 103 374				
	07.96-12.02	74			1LA	0 204 102 373	← 48		0 204 104 144 <sup>7</sup>	
						0 204 103 373				
						0 204 102 374	→ 48		0 204 104 144 <sup>7</sup>	
						0 204 103 374				
					1LM,239					0 204 104 144 <sup>7</sup>
					1LY	0 986 471 669	← 54			1 987 470 287 <sup>7</sup>
						0 986 473 669				
						0 986 472 669	→ 54			1 987 470 287 <sup>7</sup>
						0 986 474 669				
					228	0 986 473 687	 ← 54			1 987 470 287 <sup>7</sup>
						0 986 474 687	 → 54			1 987 470 287 <sup>7</sup>
12.97-12.02	44				1LM,239				0 204 104 144 <sup>7</sup>	
05.99-12.02	44				1LY	0 986 471 669	← 54		1 987 470 287 <sup>7</sup>	
						0 986 473 669				
						0 986 472 669	→ 54		1 987 470 287 <sup>7</sup>	
						0 986 474 669				
				228	0 986 473 687	 ← 54			1 987 470 287 <sup>7</sup>	
						0 986 474 687	 → 54		1 987 470 287 <sup>7</sup>	
09.99-12.02	55				1LA	0 204 102 373	← 48		0 204 104 144 <sup>7</sup>	
						0 204 103 373				
						0 204 102 374	→ 48		0 204 104 144 <sup>7</sup>	
						0 204 103 374				
					1LM,239				0 204 104 144 <sup>7</sup>	
<b>1.6</b>	09.93-07.94	55							0 204 104 144 <sup>7</sup>	
	05.94-06.99	55			1LM,239				0 204 104 144 <sup>7</sup>	
					1LY	0 986 471 669	← 54		1 987 470 287 <sup>7</sup>	
						0 986 473 669				
						0 986 472 669	→ 54		1 987 470 287 <sup>7</sup>	
						0 986 474 669				
	05.94-12.02	55			1LA	0 204 102 373	← 48		0 204 104 144 <sup>7</sup>	
						0 204 103 373				
						0 204 102 374	→ 48		0 204 104 144 <sup>7</sup>	
						0 204 103 374				
					228	0 986 473 687	 ← 54			1 987 470 287 <sup>7</sup>
						0 986 474 687	 → 54			1 987 470 287 <sup>7</sup>
	12.95-12.02	74			1LA	0 204 102 373	← 48		0 204 104 144 <sup>7</sup>	
						0 204 103 373				
						0 204 102 374	→ 48		0 204 104 144 <sup>7</sup>	
						0 204 103 374				
				1LM,239					0 204 104 144 <sup>7</sup>	
				1LY	0 986 471 669	← 54			1 987 470 287 <sup>7</sup>	
					0 986 473 669					
					0 986 472 669	→ 54			1 987 470 287 <sup>7</sup>	
					0 986 474 669					
				228	0 986 473 687	 ← 54			1 987 470 287 <sup>7</sup>	
					0 986 474 687	 → 54			1 987 470 287 <sup>7</sup>	
09.97-12.02	55				239				0 204 104 144 <sup>7</sup>	
<b>1.8</b>	09.93-12.02	66/95			1LA	0 204 102 373	← 48		0 204 104 144 <sup>7</sup>	
						0 204 103 373				
						0 204 102 374	→ 48		0 204 104 144 <sup>7</sup>	
						0 204 103 374				
					1LM,239					0 204 104 144 <sup>7</sup>
					1LY	0 986 471 669	← 54			1 987 470 287 <sup>7</sup>
						0 986 473 669				
						0 986 472 669	→ 54			1 987 470 287 <sup>7</sup>
						0 986 474 669				
					228	0 986 473 687	 ← 54			1 987 470 287 <sup>7</sup>
					0 986 474 687	 → 54			1 987 470 287 <sup>7</sup>	



		S											
	SEAT Cordoba [6K2]												
1.8 T Cupra	05.99-12.02	115	1LV	0986 473 687		54	1987 470 287 <sup>7</sup>						
				0986 474 687		54	1987 470 287 <sup>7</sup>						
				1LW	0986 473 687		54	1987 470 287 <sup>7</sup>					
					0986 474 687		54	1987 470 287 <sup>7</sup>					
				1LY	0986 471 669		54	1987 470 287 <sup>7</sup>					
					0986 473 669								
					0986 472 669		54	1987 470 287 <sup>7</sup>					
					0986 474 669								
				1.9 D 1.9 SDI 1.9 TD 1.9 TDI	09.93-12.02	47-50/55/ 66/81	1LA	0204 102 373		48	0204 104 144 <sup>7</sup>		
								0204 103 373					
								0204 102 374		48	0204 104 144 <sup>7</sup>		
								0204 103 374					
1LM,239			0204 104 144 <sup>7</sup>										
1LY	0986 471 669		54					1987 470 287 <sup>7</sup>					
	0986 473 669												
	0986 472 669		54					1987 470 287 <sup>7</sup>					
	0986 474 669												
228	0986 473 687		54					1987 470 287 <sup>7</sup>					
	0986 474 687		54					1987 470 287 <sup>7</sup>					
2.0	09.93-12.02	85/110	1LA	0204 102 373		48	0204 104 144 <sup>7</sup>						
				0204 103 373									
				0204 102 374		48	0204 104 144 <sup>7</sup>						
				0204 103 374									
				1LM,239			0204 104 144 <sup>7</sup>						
				1LY	0986 471 669		54	1987 470 287 <sup>7</sup>					
					0986 473 669								
					0986 472 669		54	1987 470 287 <sup>7</sup>					
					0986 474 669								
				228	0986 473 687		54	1987 470 287 <sup>7</sup>					
					0986 474 687		54	1987 470 287 <sup>7</sup>					
1.0 1.4 1.6 1.8 1.9 D 1.9 SDI 1.9 TD 1.9 TDI	09.96-06.99 09.96-12.02 05.00-12.02 09.93-06.99 09.93-12.02 07.96-12.02 09.99-12.02 09.93-12.02 12.95-11.02 12.95-12.02 05.99-12.02 10.99-10.04 09.93-12.02 09.93-12.02 05.99-08.02 09.93-06.99 09.93-12.02	37 37 51 44 44 74 55 55 74 74 74 74 66 47-50 50 55/66 55/66	AG GS	0986 475 433		19,05							
				0986 475 260		17,46							
				0986 475 260		17,46							
				0986 475 433		19,05							
				0986 475 260		17,46							
				0986 475 260		17,46							
				0986 475 433		19,05							
				0986 475 260		17,46							
				0986 475 260		17,46							
				0986 475 433		19,05							
				0986 475 260		17,46							
				0986 475 438		15,87							
				0986 475 260		17,46							
				0986 475 433		19,05							
				0986 475 260		17,46							
				0986 475 433		19,05							
				0986 475 260		17,46							
				0986 475 260		17,46							
				0986 475 433		19,05							
				1.0 1.4	05.99-12.02	37/51 44/55/74	BSR	0986 473 352		33,9	1987 474 496 <sup>8</sup>		
								0986 474 352		33,9	1987 474 496 <sup>8</sup>		
								0986 473 352		33,9	1987 474 496 <sup>8</sup>		
								0986 474 352		33,9	1987 474 496 <sup>8</sup>		
								0986 473 352		33,9	1987 474 496 <sup>8</sup>		
0986 474 352		33,9	1987 474 496 <sup>8</sup>										

		S							
1.4	05.99-12.02	44/55/74	BSR	0986 473 352		← 33,9	1987 474 496 <sup>B</sup>		
				0986 474 352		→ 33,9	1987 474 496 <sup>B</sup>		
1.6	05.99-12.02	74	BSR	0986 473 352		← 33,9	1987 474 496 <sup>B</sup>		
				0986 474 352		→ 33,9	1987 474 496 <sup>B</sup>		
			BSR	0986 473 352		← 33,9	1987 474 496 <sup>B</sup>		
				0986 474 352		→ 33,9	1987 474 496 <sup>B</sup>		
1.8	09.93-03.94	95	Fg.-Nr. →6K..ZR085 725, →6K..ZR610 014	0986 474 875		← 38	1987 470 040		
				0986 474 876		→ 38	1987 470 040		
	04.94-06.96	95	Fg.-Nr. 6K..ZR085 726→, 6K..ZR610 015→	0986 473 150		← 38,1	1987 470 040		
				0986 474 150		→ 38,1	1987 470 040		
1.8 T Cupra	05.99-12.02	115		0986 473 072		← 38	1987 470 040		
				0986 473 072		← 38	1987 474 496 <sup>B</sup>		
				0986 474 072		→ 38	1987 470 040		
1.9 SDI	05.99-12.02	50/66	BSR	0986 473 352		← 33,9	1987 474 496 <sup>B</sup>		
1.9 TDI			BSR	0986 474 352		→ 33,9	1987 474 496 <sup>B</sup>		
				0986 473 352		← 33,9	1987 474 496 <sup>B</sup>		
				0986 474 352		→ 33,9	1987 474 496 <sup>B</sup>		
1.9 TDI	03.97-06.99	81	1KD	0986 473 150		← 38,1	1987 470 040		
				0986 474 150		→ 38,1	1987 470 040		
			1KP				1987 470 040		
	05.99-12.02	81	BSR	0986 473 352		← 33,9	1987 474 496 <sup>B</sup>		
				0986 474 352		→ 33,9	1987 474 496 <sup>B</sup>		
			BSR	0986 473 352		← 33,9	1987 474 496 <sup>B</sup>		
				0986 474 352		→ 33,9	1987 474 496 <sup>B</sup>		
2.0	09.93-03.94	85	Fg.-Nr. 6K..ZR014 327→6K..ZR085 725, 6K..ZR516 274→6K..ZR610 014	0986 474 875		← 38	1987 470 040		
				0986 474 876		→ 38	1987 470 040		
	04.94-04.96	85	Fg.-Nr. 6K..ZR085 726→, 6K..ZR610 015→	0986 473 150		← 38,1	1987 470 040		
				0986 474 150		→ 38,1	1987 470 040		
	04.96-12.02	85		0986 473 150		← 38,1	1987 470 040		
				0986 474 150		→ 38,1	1987 470 040		
	06.96-12.02	110	1KD	0986 473 150		← 38,1	1987 470 040		
			1KP	0986 474 150		→ 38,1	1987 470 040		
							1987 470 040		
1.0	09.96-03.98	37	Fg.-Nr. →6K..W..169 289	1987 477 284		↔ 1511			
				05.99-12.02	37	SBR	1987 477 627		↔ 1641
				TBR	1987 477 695		↔ 1514		
	05.00-12.02	51		SBR	1987 477 627		↔ 1641		
				TBR	1987 477 695		↔ 1514		
	ABO 04.98-06.99	37	Fg.-Nr. 6K..W..169 290→	1987 477 679		↔ 1512			
	ABS 04.98-06.99	37	Fg.-Nr. 6K..W..169 290→	1987 477 695		↔ 1514			
1.4	09.93-12.97	44		1987 477 284		↔ 1511			
				07.96-03.98	74	Fg.-Nr. →6K..W..169 289	1987 477 284		↔ 1511
	12.97-03.98	44	Fg.-Nr. →6K..W..169 289	1987 477 284		↔ 1511			
	05.99-12.02	44		SBR	1987 477 627		↔ 1641		
				TBR	1987 477 695		↔ 1514		
	09.99-12.02	55		SBR	1987 477 627		↔ 1641		
				TBR	1987 477 695		↔ 1514		
		74		SBR	1987 477 627		↔ 1641		
				TBR	1987 477 695		↔ 1514		
	ABO 04.98-12.02	44/74	Fg.-Nr. 6K..W..169 290→	1987 477 679		↔ 1512			
	ABS 04.98-12.02	44/74	Fg.-Nr. 6K..W..169 290→	1987 477 695		↔ 1514			
1.6	11.93-07.94	55	Fg.-Nr. 6K..ZR037 977→, 6K..ZR549 076→	1987 477 215		↔ 1532			
				05.94-03.98	55	Fg.-Nr. →6K..W..169 289	1987 477 284		↔ 1511
	12.95-03.98	74	Fg.-Nr. →6K..W..169 289	1987 477 284		↔ 1511			
	05.99-12.02	74		SBR	1987 477 627		↔ 1641		
				TBR	1987 477 695		↔ 1514		
	10.99-10.04	74		1987 477 695		1514			
	ABO 04.98-12.02	55/74	Fg.-Nr. 6K..W..169 290→	1987 477 679		↔ 1512			
	ABS 04.98-12.02	55/74	Fg.-Nr. 6K..W..169 290→	1987 477 695		↔ 1514			





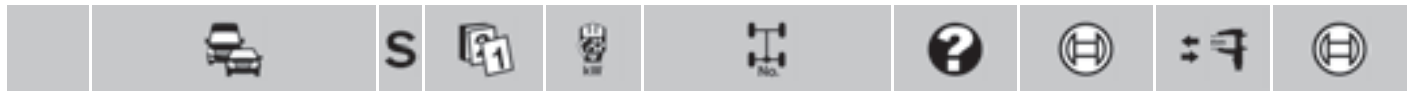











































SEAT Cordoba [6K2]































<b>1.8</b>	09.93-07.94	66			1987 477 284	↔ 1511
	09.93-06.96	95			1987 477 204	↔ 1625
	07.94-03.98	66	Fg.-Nr. →6K..W..169 289		1987 477 284	↔ 1511
ABO	04.98-12.02	66	Fg.-Nr. 6K..W..169 290→		1987 477 679	↔ 1512
	04.98-12.02	66	Fg.-Nr. 6K..W..169 290→		1987 477 695	↔ 1514
<b>1.8 T Cupra</b>	05.99-12.02	115			1987 477 627	↔ 1641
<b>1.9 D</b>	09.93-03.98	47-50	Fg.-Nr. →6K..W..169 289		1987 477 284	↔ 1511
	ABO 04.98-12.02	47-50/66	Fg.-Nr. 6K..W..169 290→		1987 477 679	↔ 1512
	ABS 04.98-12.02	47-50/66	Fg.-Nr. 6K..W..169 290→		1987 477 695	↔ 1514
<b>1.9 SDI</b>	12.95-03.98	47-50	Fg.-Nr. →6K..W..169 289		1987 477 284	↔ 1511
	05.99-08.02	50		SBR	1987 477 627	↔ 1641
				TBR	1987 477 695	↔ 1514
ABO	04.98-12.02	47-50/66	Fg.-Nr. 6K..W..169 290→		1987 477 679	↔ 1512
	ABS 04.98-12.02	47-50/66	Fg.-Nr. 6K..W..169 290→		1987 477 695	↔ 1514
<b>1.9 TD</b>	09.93-08.97	55			1987 477 284	↔ 1511
<b>1.9 TDI</b>	07.96-06.99	66			1987 477 284	↔ 1511
	03.97-12.02	81			1987 477 627	↔ 1641
	05.99-12.02	66		SBR	1987 477 627	↔ 1641
				TBR	1987 477 695	↔ 1514
ABO	04.98-06.99	47-50/66	Fg.-Nr. 6K..W..169 290→		1987 477 679	↔ 1512
	ABS 04.98-06.99	47-50/66	Fg.-Nr. 6K..W..169 290→		1987 477 695	↔ 1514
<b>2.0</b>	09.93-04.96	85			1987 477 204	↔ 1625
	04.96-09.96	85	Fg.-Nr. →6K..V..000 537, →6K..V..013 236		1987 477 204	↔ 1625
	06.96-09.96	110	Fg.-Nr. →6K..V..000 537, →6K..V..013 236		1987 477 204	↔ 1625
	10.96-12.02	85	Fg.-Nr. 6K..V..000 538→, 6K..V..013 237→		1987 477 627	↔ 1641
		110	Fg.-Nr. 6K..V..000 538→, 6K..V..013 237→		1987 477 627	↔ 1641

<b>1.0</b>	09.96-12.02	37/51			0986 594 009 <sup>4</sup>	
				LAB	0986 594 001 <sup>3</sup>	
				RAB	0986 594 000 <sup>3</sup>	
<b>1.4</b>	09.93-12.95	44		TW	0986 594 009 <sup>4</sup>	
	09.93-12.02	44		LAB	0986 594 001 <sup>3</sup>	
				RAB	0986 594 000 <sup>3</sup>	
	01.96-12.02	44			0986 594 009 <sup>4</sup>	
	07.96-12.02	55/74			0986 594 009 <sup>4</sup>	
LAB					0986 594 001 <sup>3</sup>	
				RAB	0986 594 000 <sup>3</sup>	
					0986 594 009 <sup>4</sup>	
<b>1.6</b>	09.93-12.02	55		LAB	0986 594 001 <sup>3</sup>	
	05.94-06.99	55		TW	0986 594 009 <sup>4</sup>	
	05.94-12.02	55		RAB	0986 594 000 <sup>3</sup>	
	12.95-10.04	74			0986 594 009 <sup>4</sup>	
LAB					0986 594 001 <sup>3</sup>	
				RAB	0986 594 000 <sup>3</sup>	
	03.97-12.02	55			0986 594 009 <sup>4</sup>	
<b>1.8</b>	09.93-12.02	66/95		LAB	0986 594 001 <sup>3</sup>	
				RAB	0986 594 000 <sup>3</sup>	
				TW	0986 594 009 <sup>4</sup>	
<b>1.8 T Cupra</b>	05.99-12.02	115			0986 594 009 <sup>4</sup>	
				LAB	0986 594 001 <sup>3</sup>	
				RAB	0986 594 000 <sup>3</sup>	
<b>1.9 D</b>	09.93-12.02	47-50		LAB	0986 594 001 <sup>3</sup>	
				RAB	0986 594 000 <sup>3</sup>	
				TW	0986 594 009 <sup>4</sup>	
<b>1.9 SDI</b>	12.95-12.02	47			0986 594 009 <sup>4</sup>	
				LAB	0986 594 001 <sup>3</sup>	
				RAB	0986 594 000 <sup>3</sup>	
LAB					0986 594 009 <sup>4</sup>	
				LAB	0986 594 001 <sup>3</sup>	
				RAB	0986 594 000 <sup>3</sup>	
<b>1.9 TD</b>	09.93-08.97	55		LAB	0986 594 001 <sup>3</sup>	
				RAB	0986 594 000 <sup>3</sup>	
				TW	0986 594 009 <sup>4</sup>	

		S							
1.9 TDI		07.96-12.02	66/81				0 986 594 009 <sup>4</sup>		
						LAB	0 986 594 001 <sup>3</sup>		
						RAB	0 986 594 000 <sup>3</sup>		
2.0		09.93-04.96	85			TW	0 986 594 009 <sup>4</sup>		
		09.93-12.02	85			LAB	0 986 594 001 <sup>3</sup>		
						RAB	0 986 594 000 <sup>3</sup>		
		04.96-12.02	85				0 986 594 009 <sup>4</sup>		
		06.96-12.02	110				0 986 594 009 <sup>4</sup>		
						LAB	0 986 594 001 <sup>3</sup>		
						RAB	0 986 594 000 <sup>3</sup>		
<b>Cordoba [6L2]</b>									
									
	1.2	10.02-04.04	47	PR-Code 1LN, PR-Code 1ZH	288		0 986 473 192	 ← 54	1 987 470 287 <sup>7</sup>
							0 986 474 192	 → 54	1 987 470 287 <sup>7</sup>
				PR-Code 1LQ, PR-Code 1ZF	252		0 986 473 071	 ← 54	1 987 470 506 <sup>8</sup>
							0 986 474 071	 → 54	1 987 470 506 <sup>8</sup>
		11.04-06.06	47	PR-Code 1LN, PR-Code 1ZH	288		0 986 473 192	 ← 54	1 987 470 287 <sup>7</sup>
							0 986 474 192	 → 54	1 987 470 287 <sup>7</sup>
				PR-Code 1LQ, PR-Code 1ZF	252		0 986 473 071	 ← 54	1 987 470 506 <sup>8</sup>
							0 986 474 071	 → 54	1 987 470 506 <sup>8</sup>
		05.06-11.09	51	PR-Code 1LN, PR-Code 1ZH	288		0 986 473 192	 ← 54	1 987 470 287 <sup>7</sup>
							0 986 474 192	 → 54	1 987 470 287 <sup>7</sup>
				PR-Code 1LQ, PR-Code 1ZF	252		0 986 473 071	 ← 54	1 987 470 506 <sup>8</sup>
							0 986 474 071	 → 54	1 987 470 506 <sup>8</sup>
1.4		09.02-11.09	51/55/58/	PR-Code 1LN, PR-Code 1ZH	288		0 986 473 192	 ← 54	1 987 470 287 <sup>7</sup>
1.4 TDI			59/63/74				0 986 474 192	 → 54	1 987 470 287 <sup>7</sup>
				PR-Code 1LQ, PR-Code 1ZF	252		0 986 473 071	 ← 54	1 987 470 506 <sup>8</sup>
							0 986 474 071	 → 54	1 987 470 506 <sup>8</sup>
1.6		04.03-11.09	74/77	PR-Code 1LN, PR-Code 1ZH	288		0 986 473 192	 ← 54	1 987 470 287 <sup>7</sup>
							0 986 474 192	 → 54	1 987 470 287 <sup>7</sup>
				PR-Code 1LQ, PR-Code 1ZF	252		0 986 473 071	 ← 54	1 987 470 506 <sup>8</sup>
							0 986 474 071	 → 54	1 987 470 506 <sup>8</sup>
1.9 SDI		09.02-11.09	47/74/96	PR-Code 1LN, PR-Code 1ZH	288		0 986 473 192	 ← 54	1 987 470 287 <sup>7</sup>
1.9 TDI							0 986 474 192	 → 54	1 987 470 287 <sup>7</sup>
				PR-Code 1LQ, PR-Code 1ZF	252		0 986 473 071	 ← 54	1 987 470 506 <sup>8</sup>
							0 986 474 071	 → 54	1 987 470 506 <sup>8</sup>
2.0		09.02-11.09	85	PR-Code 1LN, PR-Code 1ZH	288		0 986 473 192	 ← 54	1 987 470 287 <sup>7</sup>
							0 986 474 192	 → 54	1 987 470 287 <sup>7</sup>
				PR-Code 1LQ, PR-Code 1ZF	252		0 986 473 071	 ← 54	1 987 470 506 <sup>8</sup>
							0 986 474 071	 → 54	1 987 470 506 <sup>8</sup>
									
	1.2	10.02-04.04	47				0 986 475 260	↔ 17,46	
							0 986 475 433	↔ 19,05	
		11.04-06.06	47				0 986 475 260	↔ 17,46	
							0 986 475 433	↔ 19,05	
		05.06-11.09	51				0 986 475 260	↔ 17,46	
							0 986 475 433	↔ 19,05	
1.4		09.02-11.09	51/55/58/				0 986 475 260	↔ 17,46	
1.4 TDI			59/63/74				0 986 475 433	↔ 19,05	
1.6		04.03-11.09	74/77				0 986 475 260	↔ 17,46	
							0 986 475 433	↔ 19,05	
1.9 SDI		09.02-11.09	47/74/96				0 986 475 260	↔ 17,46	
1.9 TDI							0 986 475 433	↔ 19,05	
2.0		09.02-11.09	85				0 986 475 260	↔ 17,46	
							0 986 475 433	↔ 19,05	
	1.2	10.02-04.04	47	PR-Code 1KD, PR-Code 1KS	232		0 986 473 180	 ← 34	1 987 474 496 <sup>8</sup>
							0 986 474 180	 → 34	1 987 474 496 <sup>8</sup>

		S								
SEAT Cordoba [6L2]										
1.2	10.02-04.04	47	PR-Code 1KK, PR-Code 1KT	MVB	0986 473 099		← 38,1	1987 470 040		
					0986 473 099		← 38,1	1987 474 496 <sup>8</sup>		
					0986 474 099		→ 38,1	1987 470 040		
	11.04-06.06	47	PR-Code 1KD, PR-Code 1KS	232	0986 473 180		← 34	1987 474 496 <sup>8</sup>		
					0986 474 180		→ 34	1987 474 496 <sup>8</sup>		
					0986 473 099		← 38,1	1987 470 040		
			PR-Code 1KK, PR-Code 1KT	232	0986 473 099		← 38,1	1987 474 496 <sup>8</sup>		
					0986 474 099		→ 38,1	1987 470 040		
					0986 473 180		← 34	1987 474 496 <sup>8</sup>		
	05.06-11.09	51	PR-Code 1KD, PR-Code 1KS	MVB	0986 473 180		← 34	1987 474 496 <sup>8</sup>		
					0986 474 180		→ 34	1987 474 496 <sup>8</sup>		
					0986 473 180		← 34	1987 474 496 <sup>8</sup>		
PR-Code 1KK, PR-Code 1KT			MVB	0986 473 099		← 38,1	1987 470 040			
				0986 473 099		← 38,1	1987 474 496 <sup>8</sup>			
				0986 474 099		→ 38,1	1987 470 040			
1.4	09.02-04.04	55	PR-Code 1KK, PR-Code 1KT	MVB	0986 473 099		← 38,1	1987 470 040		
					0986 473 099		← 38,1	1987 474 496 <sup>8</sup>		
					0986 474 099		→ 38,1	1987 470 040		
	10.02-11.06	74	PR-Code 1KD, PR-Code 1KS	232	0986 473 180		← 34	1987 474 496 <sup>8</sup>		
					0986 474 180		→ 34	1987 474 496 <sup>8</sup>		
					0986 473 099		← 38,1	1987 470 040		
			PR-Code 1KK, PR-Code 1KT	232	0986 473 099		← 38,1	1987 474 496 <sup>8</sup>		
					0986 473 099		← 38,1	1987 470 040		
					0986 474 099		→ 38,1	1987 470 040		
	05.04-12.07	55	PR-Code 1KK, PR-Code 1KT	232	0986 473 099		← 38,1	1987 470 040		
					0986 473 099		← 38,1	1987 474 496 <sup>8</sup>		
					0986 474 099		→ 38,1	1987 470 040		
1.4 1.4 TDI			09.02-12.07	55	PR-Code 1KD, PR-Code 1KS	232	0986 473 180		← 34	1987 474 496 <sup>8</sup>
							0986 474 180		→ 34	1987 474 496 <sup>8</sup>
							0986 473 180		← 34	1987 474 496 <sup>8</sup>
	05.05-11.09	58/59/63	PR-Code 1KD, PR-Code 1KS	MVB	0986 473 180		← 34	1987 474 496 <sup>8</sup>		
					0986 474 180		→ 34	1987 474 496 <sup>8</sup>		
					0986 473 180		← 34	1987 474 496 <sup>8</sup>		
			PR-Code 1KK, PR-Code 1KT	MVB	0986 473 099		← 38,1	1987 470 040		
					0986 473 099		← 38,1	1987 474 496 <sup>8</sup>		
					0986 474 099		→ 38,1	1987 470 040		
	1.4 TDI	10.02-12.05	55	PR-Code 1KK, PR-Code 1KT	232	0986 473 099		← 38,1	1987 470 040	
						0986 473 099		← 38,1	1987 474 496 <sup>8</sup>	
						0986 474 099		→ 38,1	1987 470 040	
05.05-11.09		51	PR-Code 1KD, PR-Code 1KS	MVB	0986 473 180		← 34	1987 474 496 <sup>8</sup>		
					0986 474 180		→ 34	1987 474 496 <sup>8</sup>		
					0986 473 180		← 34	1987 474 496 <sup>8</sup>		
			PR-Code 1KK, PR-Code 1KT	MVB	0986 473 099		← 38,1	1987 470 040		
					0986 473 099		← 38,1	1987 474 496 <sup>8</sup>		
					0986 474 099		→ 38,1	1987 470 040		
1.6		04.03-11.09	74	PR-Code 1KD, PR-Code 1KS	232	0986 473 180		← 34	1987 474 496 <sup>8</sup>	
						0986 474 180		→ 34	1987 474 496 <sup>8</sup>	
						0986 473 099		← 38,1	1987 470 040	
	11.06-11.09	77	PR-Code 1KD, PR-Code 1KS	MVB	0986 473 180		← 34	1987 474 496 <sup>8</sup>		
					0986 474 180		→ 34	1987 474 496 <sup>8</sup>		
					0986 473 180		← 34	1987 474 496 <sup>8</sup>		
			PR-Code 1KK, PR-Code 1KT	MVB	0986 473 099		← 38,1	1987 470 040		
					0986 473 099		← 38,1	1987 474 496 <sup>8</sup>		
					0986 474 099		→ 38,1	1987 470 040		
	09.02-12.05	47	PR-Code 1KD, PR-Code 1KS	232	0986 473 180		← 34	1987 474 496 <sup>8</sup>		
					0986 474 180		→ 34	1987 474 496 <sup>8</sup>		
					0986 473 099		← 38,1	1987 470 040		
PR-Code 1KK, PR-Code 1KT			232	0986 473 099		← 38,1	1987 470 040			
				0986 473 099		← 38,1	1987 474 496 <sup>8</sup>			
				0986 474 099		→ 38,1	1987 470 040			



	<b>S</b>											
<b>1.9 TDI</b>	09.02-09.05	74/96	PR-Code 1KK, PR-Code 1KT	232	0 986 473 099		← 38,1	1 987 470 040				
					0 986 473 099		← 38,1	1 987 474 496 <sup>B</sup>				
					0 986 474 099		→ 38,1	1 987 470 040				
	09.02-11.09	74/96	PR-Code 1KD, PR-Code 1KS	232	0 986 473 180		← 34	1 987 474 496 <sup>B</sup>				
					0 986 474 180		→ 34	1 987 474 496 <sup>B</sup>				
	05.05-11.09	74/96	PR-Code 1KD, PR-Code 1KS	MVB	0 986 473 180		← 34	1 987 474 496 <sup>B</sup>				
					0 986 474 180		→ 34	1 987 474 496 <sup>B</sup>				
				PR-Code 1KK, PR-Code 1KT	MVB	0 986 473 099		← 38,1	1 987 470 040			
						0 986 473 099		← 38,1	1 987 474 496 <sup>B</sup>			
						0 986 474 099		→ 38,1	1 987 470 040			
	<b>2.0</b>	09.02-04.05	85	PR-Code 1KK, PR-Code 1KT	MVB	0 986 473 099		← 38,1	1 987 470 040			
						0 986 473 099		← 38,1	1 987 474 496 <sup>B</sup>			
0 986 474 099							→ 38,1	1 987 470 040				
09.02-11.09		85	PR-Code 1KD, PR-Code 1KS	232	0 986 473 180		← 34	1 987 474 496 <sup>B</sup>				
					0 986 474 180		→ 34	1 987 474 496 <sup>B</sup>				
04.03-11.09		85	PR-Code 1KK, PR-Code 1KT	232	0 986 473 099		← 38,1	1 987 470 040				
					0 986 473 099		← 38,1	1 987 474 496 <sup>B</sup>				
					0 986 474 099		→ 38,1	1 987 470 040				
					0 986 474 099		→ 38,1	1 987 470 040				
		10.02-04.04	47		HTB,SSZ	1 987 482 446	↔ 1580					
					HTB,SSZ	1 987 477 806	↔ 1580					
					4SB,SSZ	1 987 482 191	↔ 1645					
					4SB,SSZ	1 987 477 807	↔ 1640					
					11.04-06.06	47	HTB,SSZ	1 987 482 446	↔ 1580			
							HTB,SSZ	1 987 477 806	↔ 1580			
							4SB,SSZ	1 987 482 191	↔ 1645			
					05.06-11.09	51	4SB,SSZ	1 987 477 807	↔ 1640			
							HTB,SSZ	1 987 482 446	↔ 1580			
							HTB,SSZ	1 987 477 806	↔ 1580			
							4SB,SSZ	1 987 482 191	↔ 1645			
							4SB,SSZ	1 987 477 807	↔ 1640			
							4SB,SSZ	1 987 477 807	↔ 1640			
					<b>1.4</b>	09.02-11.09	51/55/58/ 59/63/74		HTB,SSZ	1 987 482 446	↔ 1580	
									HTB,SSZ	1 987 477 806	↔ 1580	
4SB,SSZ	1 987 482 191	↔ 1645										
4SB,SSZ	1 987 477 807	↔ 1640										
<b>1.4 TDI</b>	10.02-11.09	51/55/58/ 59/63/74		HTB,SSZ	1 987 482 446	↔ 1580						
				HTB,SSZ	1 987 477 806	↔ 1580						
				4SB,SSZ	1 987 482 191	↔ 1645						
				4SB,SSZ	1 987 477 807	↔ 1640						
<b>1.6</b>	04.03-11.09	74/77		HTB,SSZ	1 987 482 446	↔ 1580						
				HTB,SSZ	1 987 477 806	↔ 1580						
				4SB,SSZ	1 987 482 191	↔ 1645						
				4SB,SSZ	1 987 477 807	↔ 1640						
<b>1.9 SDI</b>	09.02-12.05	47/74/96		HTB,SSZ	1 987 482 446	↔ 1580						
				HTB,SSZ	1 987 477 806	↔ 1580						
				4SB,SSZ	1 987 482 191	↔ 1645						
				4SB,SSZ	1 987 477 807	↔ 1640						
<b>1.9 TDI</b>	09.02-11.09	47/74/96		HTB,SSZ	1 987 482 446	↔ 1580						
				HTB,SSZ	1 987 477 806	↔ 1580						
				4SB,SSZ	1 987 482 191	↔ 1645						
				4SB,SSZ	1 987 477 807	↔ 1640						
<b>2.0</b>	09.02-11.09	85		HTB,SSZ	1 987 482 446	↔ 1580						
				HTB,SSZ	1 987 477 806	↔ 1580						
				4SB,SSZ	1 987 482 191	↔ 1645						
				4SB,SSZ	1 987 477 807	↔ 1640						
	10.02-04.04	47		LAB	0 986 594 500 <sup>3</sup>							
					0 986 594 502 <sup>4</sup>							
					RAB	0 986 594 501 <sup>3</sup>						
						0 986 594 503 <sup>4</sup>						

	SEAT Cordoba [6L2]								
1.2	11.04-06.06	47		LAB	0986 594 500 <sup>3</sup>				
				RAB	0986 594 502 <sup>4</sup>				
				RAB	0986 594 501 <sup>3</sup>				
				RAB	0986 594 503 <sup>4</sup>				
	05.06-11.09	51		LAB	0986 594 500 <sup>3</sup>				
				RAB	0986 594 502 <sup>4</sup>				
				RAB	0986 594 501 <sup>3</sup>				
				RAB	0986 594 503 <sup>4</sup>				
1.4	09.02-11.09	51/55/58/		LAB	0986 594 500 <sup>3</sup>				
1.4 TDI		59/63/74		RAB	0986 594 502 <sup>4</sup>				
				RAB	0986 594 501 <sup>3</sup>				
				RAB	0986 594 503 <sup>4</sup>				
1.6	04.03-11.09	74/77		LAB	0986 594 500 <sup>3</sup>				
				RAB	0986 594 502 <sup>4</sup>				
				RAB	0986 594 501 <sup>3</sup>				
				RAB	0986 594 503 <sup>4</sup>				
1.9 SDI	09.02-11.09	47/74/96		LAB	0986 594 500 <sup>3</sup>				
1.9 TDI				RAB	0986 594 502 <sup>4</sup>				
				RAB	0986 594 501 <sup>3</sup>				
				RAB	0986 594 503 <sup>4</sup>				
2.0	09.02-11.09	85		LAB	0986 594 500 <sup>3</sup>				
				RAB	0986 594 502 <sup>4</sup>				
				RAB	0986 594 501 <sup>3</sup>				
				RAB	0986 594 503 <sup>4</sup>				

**Exeo ST [3R5]**

1.6	06.09-09.10	75			0986 473 070		← 56,93	1987 470 005 <sup>7</sup>	
					0986 473 070		← 56,93	1987 470 506 <sup>8</sup>	
					0986 474 070		→ 56,93	1987 470 005 <sup>7</sup>	
1.8	06.09→	88/110/			0986 473 070		← 56,93	1987 470 005 <sup>7</sup>	
1.8 TSI		118			0986 473 070		← 56,93	1987 470 506 <sup>8</sup>	
					0986 474 070		→ 56,93	1987 470 005 <sup>7</sup>	
2.0 TDI	06.09-12.11	125			0986 474 070		→ 56,93	1987 470 506 <sup>8</sup>	
	06.09→	88/105			0986 473 070		← 56,93	1987 470 005 <sup>7</sup>	
					0986 473 070		← 56,93	1987 470 506 <sup>8</sup>	
					0986 474 070		→ 56,93	1987 470 005 <sup>7</sup>	
					0986 473 070		← 56,93	1987 470 506 <sup>8</sup>	
					0986 474 070		→ 56,93	1987 470 005 <sup>7</sup>	
2.0 TSI	06.09→	147			0986 473 070		← 56,93	1987 470 005 <sup>7</sup>	
					0986 473 070		← 56,93	1987 470 506 <sup>8</sup>	
					0986 474 070		→ 56,93	1987 470 005 <sup>7</sup>	
	05.10→	155			0986 473 229		← 60	1987 470 506 <sup>8</sup>	
					0986 474 229		→ 60	1987 470 506 <sup>8</sup>	

























1.6	06.09-09.10	75			0986 473 109		← 38,1	1987 470 040	
					0986 474 109		→ 38,1	1987 470 040	
1.8	06.09→	88/110/			0986 473 109		← 38,1	1987 470 040	
1.8 TSI		118			0986 474 109		→ 38,1	1987 470 040	
2.0 TDI	06.09→	88/105/			0986 473 109		← 38,1	1987 470 040	
2.0 TSI		125/147			0986 474 109		→ 38,1	1987 470 040	
2.0 TSI	05.10→	155						1987 470 040	

1.6	06.09-09.10	75			1987 477 922		← 1928		
					1987 477 923		→ 2005		
1.8	06.09→	88/110/			1987 477 922		← 1928		
1.8 TSI		118			1987 477 923		→ 2005		

		S							
2.0 TDI		06.09→	88/105/125/				1 987 477 922	← 1928	
2.0 TSI			147/155				1 987 477 923	→ 2005	
1.6		06.09-09.10	75				0 265 006 809 <sup>3</sup>		
						ALR,LAB	0 265 006 824 <sup>4</sup>		
						ALR,RAB	0 265 006 824 <sup>4</sup>		
						ALR	0 265 006 824 <sup>4</sup>		
1.8		06.09→	88/110/				0 265 006 809 <sup>3</sup>		
1.8 TSI			118			ALR,LAB	0 265 006 824 <sup>4</sup>		
						ALR,RAB	0 265 006 824 <sup>4</sup>		
						ALR	0 265 006 824 <sup>4</sup>		
2.0 TDI		06.09→	88/105/				0 265 006 809 <sup>3</sup>		
2.0 TSI			125/147/			ALR,LAB	0 265 006 824 <sup>4</sup>		
			155			ALR,RAB	0 265 006 824 <sup>4</sup>		
						ALR	0 265 006 824 <sup>4</sup>		
<b>Exeo [3R2]</b>									
1.6		03.09-09.10	75				0 986 473 070	← 56,93	1 987 470 005 <sup>7</sup>
							0 986 473 070	← 56,93	1 987 470 506 <sup>8</sup>
							0 986 474 070	→ 56,93	1 987 470 005 <sup>7</sup>
1.8		12.08→	88/110/				0 986 473 070	← 56,93	1 987 470 005 <sup>7</sup>
1.8 TSI			118				0 986 473 070	← 56,93	1 987 470 506 <sup>8</sup>
							0 986 474 070	→ 56,93	1 987 470 005 <sup>7</sup>
2.0 TDI		12.08→	88/105/				0 986 473 070	← 56,93	1 987 470 005 <sup>7</sup>
2.0 TFSI			125/147				0 986 473 070	← 56,93	1 987 470 506 <sup>8</sup>
							0 986 474 070	→ 56,93	1 987 470 005 <sup>7</sup>
2.0 TSI		05.10→	155				0 986 473 229	← 60	1 987 470 506 <sup>8</sup>
							0 986 474 229	→ 60	1 987 470 506 <sup>8</sup>
1.6		03.09-09.10	75				0 986 473 109	← 38,1	1 987 470 040
							0 986 474 109	→ 38,1	1 987 470 040
1.8		12.08→	88/110/				0 986 473 109	← 38,1	1 987 470 040
1.8 TSI			118				0 986 474 109	→ 38,1	1 987 470 040
2.0 TDI		12.08→	88/105/				0 986 473 109	← 38,1	1 987 470 040
2.0 TFSI			125/147				0 986 474 109	→ 38,1	1 987 470 040
2.0 TSI		05.10→	155						1 987 470 040
1.6		03.09-09.10	75				1 987 477 922	← 1928	
							1 987 477 923	→ 2005	
1.8		12.08→	88/110/				1 987 477 922	← 1928	
1.8 TSI			118				1 987 477 923	→ 2005	
2.0 TDI, TFSI, TSI		12.08→	88/105/125/				1 987 477 922	← 1928	
			147/155				1 987 477 923	→ 2005	
1.6		03.09-09.10	75				0 265 006 809 <sup>3</sup>		
						ALR,LAB	0 265 006 824 <sup>4</sup>		
						ALR,RAB	0 265 006 824 <sup>4</sup>		
						ALR	0 265 006 824 <sup>4</sup>		
1.8		12.08→	88/110/				0 265 006 809 <sup>3</sup>		
1.8 TSI			118			ALR,LAB	0 265 006 824 <sup>4</sup>		
						ALR,RAB	0 265 006 824 <sup>4</sup>		
						ALR	0 265 006 824 <sup>4</sup>		
2.0 TDI		12.08→	88/105/				0 265 006 809 <sup>3</sup>		
2.0 TFSI			125/147/			ALR,LAB	0 265 006 824 <sup>4</sup>		
2.0 TSI			155			ALR,RAB	0 265 006 824 <sup>4</sup>		
						ALR	0 265 006 824 <sup>4</sup>		

























































		S																
◀ SEAT																		
Ibiza SC [6J1]																		
	1.2	07.08-05.11	51			288	0986 473 384		← 53,94	F 026 A06 106 <sup>7</sup>								
							0986 473 384		← 53,94	1987 470 506 <sup>8</sup>								
							0986 474 384		→ 53,94	F 026 A06 106 <sup>7</sup>								
											PR-Code 1LQ, PR-Code 1LR	252	0986 473 071		← 54	1987 470 506 <sup>8</sup>		
													0986 474 071		→ 54	1987 470 506 <sup>8</sup>		
							06.09→		51				0986 473 071		← 54	1987 470 506 <sup>8</sup>		
							07.09→		44				0986 474 071		→ 54	1987 470 506 <sup>8</sup>		
													0986 473 071		← 54	1987 470 506 <sup>8</sup>		
													0986 474 071		→ 54	1987 470 506 <sup>8</sup>		
							1.2 TDI		05.10→		55/63/77				0986 473 071		← 54	1987 470 506 <sup>8</sup>
							1.2 TSI								0986 474 071		→ 54	1987 470 506 <sup>8</sup>
							1.4		07.08→		59/63				0986 473 071		← 54	1987 470 506 <sup>8</sup>
							1.4 TDI								0986 474 071		→ 54	1987 470 506 <sup>8</sup>
							1.4 TSI		03.09→		103/110				0986 473 384		← 53,94	F 026 A06 106 <sup>7</sup>
															0986 473 384		← 53,94	1987 470 506 <sup>8</sup>
															0986 474 384		→ 53,94	F 026 A06 106 <sup>7</sup>
							1.4 TSI Cupra		03.09-06.12		132		288		0986 473 384		← 53,94	F 026 A06 106 <sup>7</sup>
															0986 473 384		← 53,94	1987 470 506 <sup>8</sup>
									07.12→		132				0986 474 384		→ 53,94	F 026 A06 106 <sup>7</sup>
															0986 473 384		← 53,94	1987 470 506 <sup>8</sup>
															0986 474 384		→ 53,94	F 026 A06 106 <sup>7</sup>
							1.6		07.08→		77				0986 473 071		← 54	1987 470 506 <sup>8</sup>
								0986 474 071		→ 54	1987 470 506 <sup>8</sup>							
1.6 GLP		05.11→		60				0986 473 071		← 54	1987 470 506 <sup>8</sup>							
								0986 474 071		→ 54	1987 470 506 <sup>8</sup>							
1.6 TDI		05.09→		66		PR-Code 1ZC		288	0986 473 384		← 53,94	F 026 A06 106 <sup>7</sup>						
									0986 473 384		← 53,94	1987 470 506 <sup>8</sup>						
						PR-Code 1ZG		252	0986 474 384		→ 53,94	F 026 A06 106 <sup>7</sup>						
									0986 473 071		← 54	1987 470 506 <sup>8</sup>						
									0986 474 071		→ 54	1987 470 506 <sup>8</sup>						
				77					0986 473 384		← 53,94	F 026 A06 106 <sup>7</sup>						
									0986 473 384		← 53,94	1987 470 506 <sup>8</sup>						
									0986 474 384		→ 53,94	F 026 A06 106 <sup>7</sup>						
1.9 TDI		02.08-06.10		77				0986 473 384		← 53,94	F 026 A06 106 <sup>7</sup>							
								0986 473 384		← 53,94	1987 470 506 <sup>8</sup>							
								0986 474 384		→ 53,94	F 026 A06 106 <sup>7</sup>							
		06.08-06.10		66		288		0986 473 384		← 53,94	F 026 A06 106 <sup>7</sup>							
								0986 473 384		← 53,94	1987 470 506 <sup>8</sup>							
						PR-Code 1LQ, PR-Code 1LR		252	0986 474 384		→ 53,94	F 026 A06 106 <sup>7</sup>						
									0986 473 071		← 54	1987 470 506 <sup>8</sup>						
									0986 474 071		→ 54	1987 470 506 <sup>8</sup>						
2.0 TDI		01.10→		105				0986 473 384		← 53,94	F 026 A06 106 <sup>7</sup>							
								0986 473 384		← 53,94	1987 470 506 <sup>8</sup>							
								0986 474 384		→ 53,94	F 026 A06 106 <sup>7</sup>							
	1.2, TDI, TSI		07.08→		44/51/55/63				0986 475 433		↔ 19,05							
	1.4, TDI, TSI Cupra		07.08→		59/63/132				0986 475 433		↔ 19,05							
	1.6 GLP		05.11→		60				0986 475 433		↔ 19,05							
	1.9 TDI		02.08-06.10		66/77				0986 475 433		↔ 19,05							
	1.2	07.08-05.11	51			PR-Code 1KK, PR-Code 1KT	0986 473 099		← 38,1	1987 470 040								
							0986 473 099		← 38,1	1987 474 496 <sup>8</sup>								
							0986 474 099		→ 38,1	1987 470 040								
	1.2 TSI		09.10→		63/77						1987 470 040							
											1987 474 496 <sup>8</sup>							
1.4		07.08-05.10		63						1987 470 040								
										1987 474 496 <sup>8</sup>								

























































		S								
1.4 TDI	07.08-06.10	59					0 986 473 099	 ← 38,1	1 987 470 040	
							0 986 473 099	 ← 38,1	1 987 474 496 <sup>B</sup>	
							0 986 474 099	 → 38,1	1 987 470 040	
1.4 TSI	10.13→	103						1 987 470 040		
								1 987 474 496 <sup>B</sup>		
1.4 TSI 1.4 TSI Cupra	03.09-11.09	110/132					0 986 473 099	 ← 38,1	1 987 470 040	
							0 986 473 099	 ← 38,1	1 987 474 496 <sup>B</sup>	
							0 986 474 099	 → 38,1	1 987 470 040	
	12.09→	110/132						1 987 470 040		
								1 987 474 496 <sup>B</sup>		
1.6 1.6 TDI	07.08-11.09	66/77					0 986 473 099	 ← 38,1	1 987 470 040	
							0 986 473 099	 ← 38,1	1 987 474 496 <sup>B</sup>	
							0 986 474 099	 → 38,1	1 987 470 040	
	12.09→	66/77						1 987 470 040		
								1 987 474 496 <sup>B</sup>		
1.9 TDI	02.08-06.10	77					0 986 473 099	 ← 38,1	1 987 470 040	
							0 986 473 099	 ← 38,1	1 987 474 496 <sup>B</sup>	
							0 986 474 099	 → 38,1	1 987 470 040	
	06.08-06.10	66	PR-Code 1KK, PR-Code 1KT					0 986 473 099	 ← 38,1	1 987 470 040
								0 986 473 099	 ← 38,1	1 987 474 496 <sup>B</sup>
								1 987 470 040		
								1 987 474 496 <sup>B</sup>		
2.0 TDI	01.10→	105							1 987 470 040	
									1 987 474 496 <sup>B</sup>	
										
	1.2	07.08-05.11	51		SBR		1 987 482 267	↔ 1642		
					TBR		1 987 482 266	↔ 1588		
		06.09→	51				1 987 482 266	↔ 1588		
		07.09→	44				1 987 482 266	↔ 1588		
	1.2 TDI	05.10→	55/63				1 987 482 266	↔ 1588		
1.2 TSI	09.10-09.12	77					1 987 482 267	↔ 1642		
							1 987 482 266	↔ 1588		
		08.12→	55/63				1 987 482 266	↔ 1588		
1.4	07.08→	63					1 987 482 266	↔ 1588		
1.4 TDI	07.08-06.10	59		SBR			1 987 482 267	↔ 1642		
				TBR			1 987 482 266	↔ 1588		
1.4 TSI	03.09→	103/110/132					1 987 482 267	↔ 1642		
1.4 TSI Cupra	03.09→	103/110/132					1 987 482 267	↔ 1642		
1.6	07.08→	66/77					1 987 482 267	↔ 1642		
1.6 GLP	05.11→	60					1 987 482 266	↔ 1588		
1.6 TDI	05.09→	66/77					1 987 482 267	↔ 1642		
1.9 TDI	02.08-06.10	66/77		SBR			1 987 482 267	↔ 1642		
				TBR			1 987 482 266	↔ 1588		
2.0 TDI	01.10→	105					1 987 482 267	↔ 1642		
										
1.2	07.08-05.11	51		LAB			0 986 594 502 <sup>4</sup>			
				RAB			0 986 594 503 <sup>4</sup>			
		07.08→	51		LAB		0 986 594 500 <sup>3</sup>			
					RAB		0 986 594 501 <sup>3</sup>			
		07.09→	44		LAB		0 986 594 500 <sup>3</sup>			
					RAB		0 986 594 501 <sup>3</sup>			
1.2 TDI	05.10→	55/63/77			LAB		0 986 594 500 <sup>3</sup>			
1.2 TSI					RAB		0 986 594 501 <sup>3</sup>			
1.4	07.08-06.10	59/63		LAB			0 986 594 502 <sup>4</sup>			
				RAB			0 986 594 503 <sup>4</sup>			
1.4 TDI	07.08→	59/63		LAB			0 986 594 500 <sup>3</sup>			
				RAB			0 986 594 501 <sup>3</sup>			
1.4 TSI	03.09→	103/110		LAB			0 986 594 500 <sup>3</sup>			
				RAB			0 986 594 501 <sup>3</sup>			
1.4 TSI Cupra	03.09-06.12	132		LAB			0 986 594 502 <sup>4</sup>			
				RAB			0 986 594 503 <sup>4</sup>			
				LAB			0 986 594 500 <sup>3</sup>			
		03.09→	132		RAB		0 986 594 501 <sup>3</sup>			



		S								
	<b>SEAT Ibiza SC [6J1]</b>									
	1.6	07.08→	60/66/77		LAB		0986 594 500 <sup>3</sup>			
	1.6 GLP, TDI				RAB		0986 594 501 <sup>3</sup>			
	1.9 TDI	02.08-06.10	66/77		LAB		0986 594 500 <sup>3</sup>			
					RAB		0986 594 502 <sup>4</sup>			
							0986 594 501 <sup>3</sup>			
	2.0 TDI	01.10→	105		LAB		0986 594 503 <sup>4</sup>			
					RAB		0986 594 501 <sup>3</sup>			
	<b>Ibiza ST [6J8]</b>									
	1.2	04.10→	44/51/55/				0986 473 071		← 54	1987 470 506 <sup>8</sup>
	1.2 TDI, TSI		63/77				0986 474 071		→ 54	1987 470 506 <sup>8</sup>
	1.4	04.10→	63/103				0986 473 071		← 54	1987 470 506 <sup>8</sup>
	1.4 TSI						0986 474 071		→ 54	1987 470 506 <sup>8</sup>
	1.4 TSI	02.12→	110				0986 473 384		← 53,94	F 026 A06 106 <sup>7</sup>
							0986 473 384		← 53,94	1987 470 506 <sup>8</sup>
							0986 474 384		→ 53,94	F 026 A06 106 <sup>7</sup>
	1.6 TDI	05.09→	66				0986 473 071		← 54	1987 470 506 <sup>8</sup>
							0986 474 071		→ 54	1987 470 506 <sup>8</sup>
		03.10→	77				0986 473 384		← 53,94	F 026 A06 106 <sup>7</sup>
							0986 473 384		← 53,94	1987 470 506 <sup>8</sup>
							0986 474 384		→ 53,94	F 026 A06 106 <sup>7</sup>
	1.2	04.10→	44/51/55				0986 475 433		↔ 19,05	
	1.2 TDI									
	1.2 TSI	09.10→	63/77							1987 470 040
										1987 474 496 <sup>8</sup>
	1.4	04.10→	63/103/							1987 470 040
	1.4 TSI		110							1987 474 496 <sup>8</sup>
	1.6 TDI	05.09→	66/77							1987 470 040
										1987 474 496 <sup>8</sup>
	1.2	05.10→	44/51/55				1987 482 266		↔ 1588	
	1.2 TDI	04.10→	44/51/55				1987 482 266		↔ 1588	
	1.2 TSI	09.10→	63/77				1987 482 267		↔ 1642	
	1.4	04.10→	63/103/110				1987 482 267		↔ 1642	
	1.4 TSI	02.12→	63/103/110				1987 482 267		↔ 1642	
	1.6 TDI	05.09→	66/77				1987 482 267		↔ 1642	
	1.2	04.10→	44/51/55/		LAB		0986 594 500 <sup>3</sup>			
	1.2 TDI, TSI		63/77		RAB		0986 594 501 <sup>3</sup>			
	1.4	04.10→	63/103/		LAB		0986 594 500 <sup>3</sup>			
	1.4 TSI		110		RAB		0986 594 501 <sup>3</sup>			
	1.6 TDI	05.09→	66/77		LAB		0986 594 500 <sup>3</sup>			
					RAB		0986 594 501 <sup>3</sup>			
	<b>Ibiza [6J5]</b>									
	1.2	03.08-05.11	51		288		0986 473 384		← 53,94	F 026 A06 106 <sup>7</sup>
							0986 473 384		← 53,94	1987 470 506 <sup>8</sup>
							0986 474 384		→ 53,94	F 026 A06 106 <sup>7</sup>
				PR-Code 1LQ, PR-Code 1LR	252		0986 473 071		← 54	1987 470 506 <sup>8</sup>
							0986 474 071		→ 54	1987 470 506 <sup>8</sup>
		06.09→	51				0986 473 071		← 54	1987 470 506 <sup>8</sup>
							0986 474 071		→ 54	1987 470 506 <sup>8</sup>

		S							
1.2		07.09→	44				0986 473 071	 ← 54	1987 470 506 <sup>B</sup>
							0986 474 071	 → 54	1987 470 506 <sup>B</sup>
1.2 TDI		06.10→	55/63/77				0986 473 071	 ← 54	1987 470 506 <sup>B</sup>
1.2 TSI							0986 474 071	 → 54	1987 470 506 <sup>B</sup>
1.4		03.08→	59/63				0986 473 071	 ← 54	1987 470 506 <sup>B</sup>
1.4 TDI							0986 474 071	 → 54	1987 470 506 <sup>B</sup>
1.4 TSI		03.09→	103/110				0986 473 384	 ← 53,94	F 026 A06 106 <sup>7</sup>
							0986 473 384	 ← 53,94	1987 470 506 <sup>B</sup>
							0986 474 384	 → 53,94	F 026 A06 106 <sup>7</sup>
1.6		05.08→	77				0986 473 071	 ← 54	1987 470 506 <sup>B</sup>
							0986 474 071	 → 54	1987 470 506 <sup>B</sup>
1.6 GLP		05.09→	60/66				0986 473 071	 ← 54	1987 470 506 <sup>B</sup>
1.6 TDI							0986 474 071	 → 54	1987 470 506 <sup>B</sup>
1.6 TDI		05.09→	77				0986 473 384	 ← 53,94	F 026 A06 106 <sup>7</sup>
							0986 473 384	 ← 53,94	1987 470 506 <sup>B</sup>
							0986 474 384	 → 53,94	F 026 A06 106 <sup>7</sup>
1.9 TDI		02.08-06.10	77				0986 473 384	 ← 53,94	F 026 A06 106 <sup>7</sup>
							0986 473 384	 ← 53,94	1987 470 506 <sup>B</sup>
							0986 474 384	 → 53,94	F 026 A06 106 <sup>7</sup>
		07.08-06.10	66		288		0986 473 384	 ← 53,94	F 026 A06 106 <sup>7</sup>
							0986 473 384	 ← 53,94	1987 470 506 <sup>B</sup>
							0986 474 384	 → 53,94	F 026 A06 106 <sup>7</sup>
				PR-Code 1LQ, PR-Code 1LR	252		0986 473 071	 ← 54	1987 470 506 <sup>B</sup>
							0986 474 071	 → 54	1987 470 506 <sup>B</sup>
2.0 TDI		01.10→	105				0986 473 384	 ← 53,94	F 026 A06 106 <sup>7</sup>
							0986 473 384	 ← 53,94	1987 470 506 <sup>B</sup>
							0986 474 384	 → 53,94	F 026 A06 106 <sup>7</sup>
									
	1.2, TDI, TSI	03.08→	44/51/55/63				0986 475 433	↔ 19,05	
	1.4, TDI	03.08→	59/63				0986 475 433	↔ 19,05	
	1.6 GLP	05.11→	60				0986 475 433	↔ 19,05	
	1.9 TDI	07.08-06.10	66				0986 475 433	↔ 19,05	
	1.2	03.08-05.11	51	PR-Code 1KK, PR-Code 1KT			0986 473 099	 ← 38,1	1987 470 040
							0986 473 099	 ← 38,1	1987 474 496 <sup>B</sup>
							0986 474 099	 → 38,1	1987 470 040
	1.2 TSI	09.10→	63/77						1987 470 040
									1987 474 496 <sup>B</sup>
	1.4	03.08-05.11	63						1987 470 040
									1987 474 496 <sup>B</sup>
	1.4 TDI	08.08-06.10	59				0986 473 099	 ← 38,1	1987 470 040
							0986 473 099	 ← 38,1	1987 474 496 <sup>B</sup>
							0986 474 099	 → 38,1	1987 470 040
	1.4 TSI	03.09-11.09	110				0986 473 099	 ← 38,1	1987 470 040
							0986 473 099	 ← 38,1	1987 474 496 <sup>B</sup>
							0986 474 099	 → 38,1	1987 470 040
		12.09→	110						1987 470 040
									1987 474 496 <sup>B</sup>
		10.13→	103						1987 470 040
									1987 474 496 <sup>B</sup>
	1.6	05.08-11.09	77				0986 473 099	 ← 38,1	1987 474 496 <sup>B</sup>
							0986 474 099	 → 38,1	1987 474 496 <sup>B</sup>
	1.6	05.08-11.09	77				0986 473 099	 ← 38,1	1987 470 040
	1.6 TDI	12.09→	77						1987 470 040
									1987 474 496 <sup>B</sup>
	1.6 TDI	05.09-11.09	66				0986 473 099	 ← 38,1	1987 470 040
							0986 473 099	 ← 38,1	1987 474 496 <sup>B</sup>
							0986 474 099	 → 38,1	1987 470 040
			77				0986 473 099	 ← 38,1	1987 474 496 <sup>B</sup>
							0986 474 099	 → 38,1	1987 470 040















































		S									
<b>SEAT Ibiza [6J5]</b>											
	1.6 TDI	12.09→	66						1987 470 040 1987 474 496 <sup>8</sup>		
	1.9 TDI	02.08-06.10	77				0986 473 099		38,1	1987 470 040	
						0986 473 099		38,1	1987 474 496 <sup>8</sup>		
			07.08-06.10	66	PR-Code 1KK, PR-Code 1KT			0986 474 099		38,1	1987 470 040
							0986 473 099		38,1	1987 474 496 <sup>8</sup>	
	2.0 TDI	01.10→	105						1987 470 040 1987 474 496 <sup>8</sup>		
<b>SEAT Ibiza [6K1]</b>											
	1.2	03.08-05.11	51		SBR		1987 482 267		1642		
					TBR	1987 482 266		1588			
		06.09→	51				1987 482 266		1588		
		07.09→	44				1987 482 266		1588		
	1.2 TDI	06.10→	55				1987 482 266		1588		
	1.2 TSI	09.10→	63/77				1987 482 267		1642		
	1.4	03.08→	63				1987 482 266		1588		
	1.4 TDI	08.08-06.10	59		SBR		1987 482 267		1642		
					TBR	1987 482 266		1588			
	1.4 TSI	03.09→	103/110				1987 482 267		1642		
	1.6	05.08→	66/77				1987 482 267		1642		
	1.6 GLP	05.11→	60				1987 482 266		1588		
	1.6 TDI	05.09→	66/77				1987 482 267		1642		
	1.9 TDI	02.08-06.10	77				1987 482 267		1642		
					07.08-06.10	66		SBR		1987 482 267	
					TBR		1987 482 266		1588		
	2.0 TDI	01.10→	105				1987 482 267		1642		
	1.2	03.08-05.11	51		LAB		0986 594 502 <sup>4</sup>				
					RAB	0986 594 503 <sup>4</sup>					
		03.08→	51		LAB		0986 594 500 <sup>3</sup>				
				RAB	0986 594 501 <sup>3</sup>						
		07.09→	44		LAB		0986 594 500 <sup>3</sup>				
				RAB	0986 594 501 <sup>3</sup>						
	1.2 TDI	06.10→	55/63/77		LAB		0986 594 500 <sup>3</sup>				
	1.2 TSI				RAB		0986 594 501 <sup>3</sup>				
	1.4	03.08-05.11	59/63		LAB		0986 594 502 <sup>4</sup>				
	1.4 TDI	03.08→	59/63		RAB		0986 594 503 <sup>4</sup>				
					LAB	0986 594 500 <sup>3</sup>					
					RAB		0986 594 501 <sup>3</sup>				
	1.4 TSI	03.09→	103/110		LAB		0986 594 500 <sup>3</sup>				
					RAB		0986 594 501 <sup>3</sup>				
	1.6	05.08→	60/66/77		LAB		0986 594 500 <sup>3</sup>				
	1.6 GLP, TDI				RAB		0986 594 501 <sup>3</sup>				
	1.9 TDI	02.08-06.10	66/77		LAB		0986 594 500 <sup>3</sup>				
					RAB	0986 594 502 <sup>4</sup>					
					RAB	0986 594 501 <sup>3</sup>					
							0986 594 503 <sup>4</sup>				
	2.0 TDI	01.10→	105		LAB		0986 594 500 <sup>3</sup>				
					RAB	0986 594 501 <sup>3</sup>					
<b>Ibiza [6K1]</b>											
	1.0	03.93-06.96	33		1LA		0 204 102 373		48	0 204 104 144 <sup>7</sup>	
						0 204 103 373					
						0 204 102 374		48	0 204 104 144 <sup>7</sup>		
						0 204 103 374					
					1LM,239					0 204 104 144 <sup>7</sup>	

		S								
1.0	03.93-06.96	33	1LV	0 986 473 687		← 54	1 987 470 287 <sup>7</sup>			
				0 986 474 687		→ 54	1 987 470 287 <sup>7</sup>			
				1LW	0 986 473 687		← 54	1 987 470 287 <sup>7</sup>		
				0 986 474 687		→ 54	1 987 470 287 <sup>7</sup>			
			1LY	0 986 471 669		← 54	1 987 470 287 <sup>7</sup>			
				0 986 473 669						
				0 986 472 669		→ 54	1 987 470 287 <sup>7</sup>			
				0 986 474 669						
	09.96-10.99	37	1LA	0 204 102 373		← 48	0 204 104 144 <sup>7</sup>			
				0 204 103 373						
				0 204 102 374		→ 48	0 204 104 144 <sup>7</sup>			
				0 204 103 374						
	09.96-05.02	37	1LM,239				0 204 104 144 <sup>7</sup>			
	05.99-05.02	37	1LV	0 986 473 687		← 54	1 987 470 287 <sup>7</sup>			
				0 986 474 687		→ 54	1 987 470 287 <sup>7</sup>			
1LW				0 986 473 687		← 54	1 987 470 287 <sup>7</sup>			
0 986 474 687					→ 54	1 987 470 287 <sup>7</sup>				
1LY			0 986 471 669		← 54	1 987 470 287 <sup>7</sup>				
			0 986 473 669							
			0 986 472 669		→ 54	1 987 470 287 <sup>7</sup>				
			0 986 474 669							
10.99-05.02	51	239				1 987 470 287 <sup>7</sup>				
						0 204 104 144 <sup>7</sup>				
1.3	03.93-07.94	40	1LV	0 986 473 687		← 54	1 987 470 287 <sup>7</sup>			
				0 986 474 687		→ 54	1 987 470 287 <sup>7</sup>			
				1LW	0 986 473 687		← 54	1 987 470 287 <sup>7</sup>		
				0 986 474 687		→ 54	1 987 470 287 <sup>7</sup>			
			1LY	0 986 471 669		← 54	1 987 470 287 <sup>7</sup>			
				0 986 473 669						
				0 986 472 669		→ 54	1 987 470 287 <sup>7</sup>			
				0 986 474 669						
1LA	0 204 102 373		← 48	0 204 104 144 <sup>7</sup>						
	0 204 103 373									
	0 204 102 374		→ 48	0 204 104 144 <sup>7</sup>						
	0 204 103 374									
1.4	09.93-10.99	44	1LM,239				0 204 104 144 <sup>7</sup>			
				1LV	0 986 473 687		← 54	1 987 470 287 <sup>7</sup>		
					0 986 474 687		→ 54	1 987 470 287 <sup>7</sup>		
			1LW		0 986 473 687		← 54	1 987 470 287 <sup>7</sup>		
			0 986 474 687			→ 54	1 987 470 287 <sup>7</sup>			
			1LY	0 986 471 669		← 54	1 987 470 287 <sup>7</sup>			
				0 986 473 669						
0 986 472 669		→ 54		1 987 470 287 <sup>7</sup>						
0 986 474 669										
09.93-05.02	44	1LA	0 204 102 373		← 48	0 204 104 144 <sup>7</sup>				
			0 204 103 373							
			0 204 102 374		→ 48	0 204 104 144 <sup>7</sup>				
			0 204 103 374							
05.97-06.99	74	1LA	0 204 102 373		← 48	0 204 104 144 <sup>7</sup>				
			0 204 103 373							
			0 204 102 374		→ 48	0 204 104 144 <sup>7</sup>				
			0 204 103 374							
1LM,239						0 204 104 144 <sup>7</sup>				





















		S							
	SEAT Ibiza [6K1]								
1.4	05.97-06.99	74	1LV	0986 473 687		← 54	1987 470 287 <sup>7</sup>		
				0986 474 687		→ 54	1987 470 287 <sup>7</sup>		
			1LW	0986 473 687		← 54	1987 470 287 <sup>7</sup>		
				0986 474 687		→ 54	1987 470 287 <sup>7</sup>		
			1LY	0986 471 669		← 54	1987 470 287 <sup>7</sup>		
				0986 473 669					
	01.98-05.98	40	1LA	0204 102 373		← 48	0204 104 144 <sup>7</sup>		
				0204 103 373					
				0204 102 374		→ 48	0204 104 144 <sup>7</sup>		
				0204 103 374					
			1LM,239			0204 104 144 <sup>7</sup>			
			1LV	0986 473 687		← 54	1987 470 287 <sup>7</sup>		
1LW	0986 473 687		← 54	1987 470 287 <sup>7</sup>					
	0986 474 687		→ 54	1987 470 287 <sup>7</sup>					
1LY	0986 471 669		← 54	1987 470 287 <sup>7</sup>					
	0986 473 669								
05.99-05.02	44 55	239				0204 104 144 <sup>7</sup>			
			1LV	0986 473 687		← 54	1987 470 287 <sup>7</sup>		
		1LW	0986 473 687		← 54	1987 470 287 <sup>7</sup>			
			0986 474 687		→ 54	1987 470 287 <sup>7</sup>			
		1LY	0986 471 669		← 54	1987 470 287 <sup>7</sup>			
			0986 473 669						
09.99-05.02	74	239				0204 104 144 <sup>7</sup>			
			1LV	0986 473 687		← 54	1987 470 287 <sup>7</sup>		
		1LW	0986 473 687		← 54	1987 470 287 <sup>7</sup>			
			0986 474 687		→ 54	1987 470 287 <sup>7</sup>			
		1LY	0986 471 669		← 54	1987 470 287 <sup>7</sup>			
			0986 473 669						
1.6	03.93-05.02	55	239			0204 104 144 <sup>7</sup>			
				1LA	0204 102 373		← 48	0204 104 144 <sup>7</sup>	
			1LW	0204 103 373					
				0204 102 374		→ 48	0204 104 144 <sup>7</sup>		
			1LY	0204 103 374					
				1LM,239			0204 104 144 <sup>7</sup>		
	1LV	0986 473 687		← 54	1987 470 287 <sup>7</sup>				
		0986 474 687		→ 54	1987 470 287 <sup>7</sup>				
	1LW	0986 473 687		← 54	1987 470 287 <sup>7</sup>				
		0986 474 687		→ 54	1987 470 287 <sup>7</sup>				
	1LY	0986 471 669		← 54	1987 470 287 <sup>7</sup>				
		0986 473 669							
239	0986 472 669		→ 54	1987 470 287 <sup>7</sup>					
	0986 474 669								
05.95-09.99	76	239				0204 104 144 <sup>7</sup>			
			1LA	0204 102 373		← 48	0204 104 144 <sup>7</sup>		
		1LW	0204 103 373						
			0204 102 374		→ 48	0204 104 144 <sup>7</sup>			
		1LY	0204 103 374						
			1LM,239			0204 104 144 <sup>7</sup>			
12.95-05.02	74	1LV	0986 473 687		← 54	1987 470 287 <sup>7</sup>			
			0986 474 687		→ 54	1987 470 287 <sup>7</sup>			
		1LW	0986 473 687		← 54	1987 470 287 <sup>7</sup>			
			0986 474 687		→ 54	1987 470 287 <sup>7</sup>			
		1LY	0986 471 669		← 54	1987 470 287 <sup>7</sup>			
			0986 473 669						



									
1.6	12.95-05.02	74	1LY	0 986 471 669	← 54	1 987 470 287 <sup>7</sup>			
				0 986 473 669					
				0 986 472 669	→ 54	1 987 470 287 <sup>7</sup>			
				0 986 474 669					
	05.99-05.02	74	239			0 204 104 144 <sup>7</sup>			
1.8	03.93-10.99	66/95	1LA	0 204 102 373	← 48	0 204 104 144 <sup>7</sup>			
				0 204 103 373					
				0 204 102 374	→ 48	0 204 104 144 <sup>7</sup>			
				0 204 103 374					
						1LM,239			0 204 104 144 <sup>7</sup>
						1LV	0 986 473 687	 ← 54	1 987 470 287 <sup>7</sup>
					0 986 474 687		 → 54	1 987 470 287 <sup>7</sup>	
						1LW	0 986 473 687	 ← 54	1 987 470 287 <sup>7</sup>
							0 986 474 687	 → 54	1 987 470 287 <sup>7</sup>
						1LY	0 986 471 669	← 54	1 987 470 287 <sup>7</sup>
							0 986 473 669		
							0 986 472 669	→ 54	1 987 470 287 <sup>7</sup>
				0 986 474 669					
1.8 T Cupra	10.99-05.02	115	1LV	0 986 473 687	 ← 54	1 987 470 287 <sup>7</sup>			
				0 986 474 687	 → 54	1 987 470 287 <sup>7</sup>			
						1LW	0 986 473 687	 ← 54	1 987 470 287 <sup>7</sup>
							0 986 474 687	 → 54	1 987 470 287 <sup>7</sup>
						1LY	0 986 471 669	← 54	1 987 470 287 <sup>7</sup>
							0 986 473 669		
			0 986 472 669	→ 54	1 987 470 287 <sup>7</sup>				
				0 986 474 669					
1.9 D 1.9 SDI	03.93-10.99	47-50	1LA	0 204 102 373	← 48	0 204 104 144 <sup>7</sup>			
				0 204 103 373					
				0 204 102 374	→ 48	0 204 104 144 <sup>7</sup>			
				0 204 103 374					
						1LM,239			0 204 104 144 <sup>7</sup>
						1LV	0 986 473 687	 ← 54	1 987 470 287 <sup>7</sup>
							0 986 474 687	 → 54	1 987 470 287 <sup>7</sup>
						1LW	0 986 473 687	 ← 54	1 987 470 287 <sup>7</sup>
							0 986 474 687	 → 54	1 987 470 287 <sup>7</sup>
						1LY	0 986 471 669	← 54	1 987 470 287 <sup>7</sup>
							0 986 473 669		
							0 986 472 669	→ 54	1 987 470 287 <sup>7</sup>
				0 986 474 669					
1.9 SDI	05.99-05.02	50	1LV	0 986 473 687	 ← 54	1 987 470 287 <sup>7</sup>			
				0 986 474 687	 → 54	1 987 470 287 <sup>7</sup>			
						1LW	0 986 473 687	 ← 54	1 987 470 287 <sup>7</sup>
							0 986 474 687	 → 54	1 987 470 287 <sup>7</sup>
						1LY	0 986 471 669	← 54	1 987 470 287 <sup>7</sup>
							0 986 473 669		
			0 986 472 669	→ 54	1 987 470 287 <sup>7</sup>				
				0 986 474 669					
1.9 TD	03.93-08.97	55	1LA	0 204 102 373	← 48	0 204 104 144 <sup>7</sup>			
				0 204 103 373					
				0 204 102 374	→ 48	0 204 104 144 <sup>7</sup>			
				0 204 103 374					
						1LM,239			0 204 104 144 <sup>7</sup>
						1LV	0 986 473 687	 ← 54	1 987 470 287 <sup>7</sup>
							0 986 474 687	 → 54	1 987 470 287 <sup>7</sup>
						1LW	0 986 473 687	 ← 54	1 987 470 287 <sup>7</sup>
							0 986 474 687	 → 54	1 987 470 287 <sup>7</sup>
						1LY	0 986 471 669	← 54	1 987 470 287 <sup>7</sup>
							0 986 473 669		
							0 986 472 669	→ 54	1 987 470 287 <sup>7</sup>
				0 986 474 669					



		S												
	SEAT Ibiza [6K1]													
1.9 TDI	07.96-06.99	66	1LA	0 204 102 373		← 48	0 204 104 144 <sup>7</sup>							
				0 204 103 373			↻							
				0 204 102 374		→ 48	0 204 104 144 <sup>7</sup>							
				0 204 103 374			↻							
				1LM,239			0 204 104 144 <sup>7</sup>							
				07.96-05.02	66	1LV	0 986 473 687		↻ ← 54	1 987 470 287 <sup>7</sup>				
							0 986 474 687		↻ → 54	1 987 470 287 <sup>7</sup>				
						1LW	0 986 473 687		↻ ← 54	1 987 470 287 <sup>7</sup>				
							0 986 474 687		↻ → 54	1 987 470 287 <sup>7</sup>				
						1LY	0 986 471 669		← 54	1 987 470 287 <sup>7</sup>				
							0 986 473 669			↻				
							0 986 472 669		→ 54	1 987 470 287 <sup>7</sup>				
							0 986 474 669		↻					
						03.97-06.99	81	1LA	0 204 102 373		← 48	0 204 104 144 <sup>7</sup>		
									0 204 103 373			↻		
								0 204 102 374		→ 48	0 204 104 144 <sup>7</sup>			
								0 204 103 374			↻			
				1LM,239			0 204 104 144 <sup>7</sup>							
				03.97-05.02	81	1LV	0 986 473 687		↻ ← 54	1 987 470 287 <sup>7</sup>				
							0 986 474 687		↻ → 54	1 987 470 287 <sup>7</sup>				
						1LW	0 986 473 687		↻ ← 54	1 987 470 287 <sup>7</sup>				
							0 986 474 687		↻ → 54	1 987 470 287 <sup>7</sup>				
						1LY	0 986 471 669		← 54	1 987 470 287 <sup>7</sup>				
							0 986 473 669			↻				
0 986 472 669		→ 54	1 987 470 287 <sup>7</sup>											
0 986 474 669		↻												
05.99-05.02	66	239					0 204 104 144 <sup>7</sup>							
2.0	03.93-10.99	85/110	1LA			0 204 102 373		← 48	0 204 104 144 <sup>7</sup>					
						0 204 103 373			↻					
				0 204 102 374		→ 48	0 204 104 144 <sup>7</sup>							
				0 204 103 374			↻							
				1LM,239			0 204 104 144 <sup>7</sup>							
				1LV	0 986 473 687		↻ ← 54	1 987 470 287 <sup>7</sup>						
					0 986 474 687		↻ → 54	1 987 470 287 <sup>7</sup>						
					1LW	0 986 473 687		↻ ← 54	1 987 470 287 <sup>7</sup>					
						0 986 474 687		↻ → 54	1 987 470 287 <sup>7</sup>					
					1LY	0 986 471 669		← 54	1 987 470 287 <sup>7</sup>					
						0 986 473 669			↻					
						0 986 472 669		→ 54	1 987 470 287 <sup>7</sup>					
						0 986 474 669		↻						
					1.0	03.93-06.96	33	0 986 475 260		↔ 17,46				
								0 986 475 433		↔ 19,05				
								0 986 475 433		↔ 19,05				
								0 986 475 260		↔ 17,46				
				0 986 475 260				↔ 17,46						
				1.0 16V				10.99-10.04		52		0 986 475 438		↔ 15,87
				1.3				03.93-07.94		40		0 986 475 260		↔ 17,46
												0 986 475 433		↔ 19,05
				1.4				09.93-10.99		40/44		0 986 475 433		↔ 19,05
								09.93-05.02		40/44		0 986 475 260		↔ 17,46
05.97-06.99		74						0 986 475 260		↔ 17,46				
					0 986 475 433		↔ 19,05							
05.99-05.02		55			0 986 475 260		↔ 17,46							
09.99-05.02		74			0 986 475 433		↔ 19,05							
1.6	03.93-05.02		55		0 986 475 260		↔ 17,46							
					0 986 475 433		↔ 19,05							
	05.95-09.99		76		0 986 475 260		↔ 17,46							
					0 986 475 433		↔ 19,05							
	12.95-05.02		74		0 986 475 260		↔ 17,46							
					0 986 475 433		↔ 19,05							





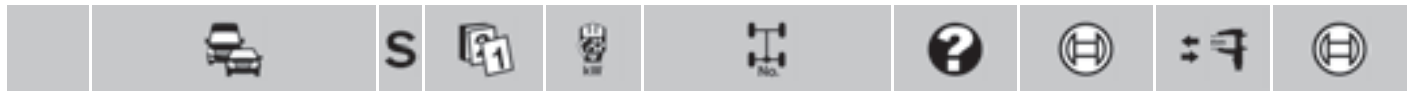











		S										
1.6		05.99-05.02	74			AG	0 986 475 260	↔ 17,46				
							GS	0 986 475 433	↔ 19,05			
		10.99-10.04	76				0 986 475 438	↔ 15,87				
1.8		03.93-10.99	66				0 986 475 260	↔ 17,46				
								0 986 475 433	↔ 19,05			
1.9D		03.93-10.99	47-50				0 986 475 260	↔ 17,46				
1.9SDI							0 986 475 433	↔ 19,05				
1.9SDI		05.99-05.02	50				0 986 475 260	↔ 17,46				
1.9TD		03.93-06.99	55/66				0 986 475 260	↔ 17,46				
1.9TDI		03.93-05.02	55/66				0 986 475 433	↔ 19,05				
	1.0	05.99-05.02	37/51			BSR	0 986 473 352	↔ 33,9	1 987 474 496 <sup>B</sup>			
								0 986 474 352	↔ 33,9	1 987 474 496 <sup>B</sup>		
								BSR	0 986 473 352	↔ 33,9	1 987 474 496 <sup>B</sup>	
							0 986 474 352	↔ 33,9	1 987 474 496 <sup>B</sup>			
1.4		05.99-05.02	44/55/74			BSR	0 986 473 352	↔ 33,9	1 987 474 496 <sup>B</sup>			
								0 986 474 352	↔ 33,9	1 987 474 496 <sup>B</sup>		
								BSR	0 986 473 352	↔ 33,9	1 987 474 496 <sup>B</sup>	
							0 986 474 352	↔ 33,9	1 987 474 496 <sup>B</sup>			
1.6		05.99-05.02	74			BSR	0 986 473 352	↔ 33,9	1 987 474 496 <sup>B</sup>			
								0 986 474 352	↔ 33,9	1 987 474 496 <sup>B</sup>		
								BSR	0 986 473 352	↔ 33,9	1 987 474 496 <sup>B</sup>	
							0 986 474 352	↔ 33,9	1 987 474 496 <sup>B</sup>			
1.8		09.93-03.94	95		Fg.-Nr. →6K..ZR085 725, →6K..ZR610 014		0 986 474 875	↔ 38	1 987 470 040			
								0 986 474 876	↔ 38	1 987 470 040		
		04.94-06.96	95		Fg.-Nr. 6K..ZR085 726→, 6K..ZR610 015→				0 986 473 150	↔ 38,1	1 987 470 040	
										0 986 474 150	↔ 38,1	1 987 470 040
1.8T Cupra		10.99-05.02	115				0 986 473 072	↔ 38	1 987 470 040			
								0 986 473 072	↔ 38	1 987 474 496 <sup>B</sup>		
								0 986 474 072	↔ 38	1 987 470 040		
1.9SDI		05.99-05.02	50/66			BSR	0 986 473 352	↔ 33,9	1 987 474 496 <sup>B</sup>			
1.9TDI						BSR	0 986 474 352	↔ 33,9	1 987 474 496 <sup>B</sup>			
							0 986 473 352	↔ 33,9	1 987 474 496 <sup>B</sup>			
							0 986 474 352	↔ 33,9	1 987 474 496 <sup>B</sup>			
1.9TDI		03.97-06.99	81			1KD	0 986 473 150	↔ 38,1	1 987 470 040			
								0 986 474 150	↔ 38,1	1 987 470 040		
		05.99-05.02	81			BSR	0 986 473 352	↔ 33,9	1 987 474 496 <sup>B</sup>			
							0 986 474 352	↔ 33,9	1 987 474 496 <sup>B</sup>			
						BSR	0 986 473 352	↔ 33,9	1 987 474 496 <sup>B</sup>			
							0 986 474 352	↔ 33,9	1 987 474 496 <sup>B</sup>			
2.0		03.93-03.94	85		Fg.-Nr. →6K..ZR014 326, →6K..ZR516 273		0 986 473 673	↔ 38	1 987 470 040			
								0 986 474 673	↔ 38	1 987 470 040		
		07.93-03.94	85		Fg.-Nr. 6K..ZR014 327→6K..ZR085 725, 6K..ZR516 274→6K..ZR610 014				0 986 474 875	↔ 38	1 987 470 040	
										0 986 474 876	↔ 38	1 987 470 040
		04.94-04.96	85		Fg.-Nr. 6K..ZR085 726→, 6K..ZR610 015→				0 986 473 150	↔ 38,1	1 987 470 040	
										0 986 474 150	↔ 38,1	1 987 470 040
		04.96-10.99	85						0 986 473 150	↔ 38,1	1 987 470 040	
										0 986 474 150	↔ 38,1	1 987 470 040
06.96-10.99	110					1KD	0 986 473 150	↔ 38,1	1 987 470 040			
								0 986 474 150	↔ 38,1	1 987 470 040		
						1KP			1 987 470 040			
	1.0	11.93-09.94	33		Fg.-Nr. 6K..ZR037 977→6K..ZR126 718, 6K..ZR549 076→6K..ZR663 842		1 987 477 215	↔ 1532				
									1 987 477 284	↔ 1511		
									1 987 477 284	↔ 1511		
									SBR	1 987 477 627	↔ 1641	
									TBR	1 987 477 695	↔ 1514	
									10.99-05.02	51		
						TBR	1 987 477 695	↔ 1514				































































SEAT Ibiza [6K1]





























<b>1.0</b>	ABO	04.98-10.99	37	Fg.-Nr. 6K..W..169 290→	1987 477 679	↔ 1512	
	ABS	04.98-10.99	37	Fg.-Nr. 6K..W..169 290→	1987 477 695	↔ 1514	
<b>1.0 16V</b>		10.99-10.04	52		1987 477 695	1514	
<b>1.3</b>		11.93-07.94	40	Fg.-Nr. 6K..ZR037 977→, 6K..ZR549 076→	1987 477 215	↔ 1532	
<b>1.4</b>		11.93-09.94	44	Fg.-Nr. 6K..ZR037 977→6K..ZR126 718, 6K..ZR549 076→6K..ZR663 842	1987 477 215	↔ 1532	
		10.94-12.95	44	Fg.-Nr. 6K..ZR126 719→, 6K..ZR663 843→	1987 477 284	↔ 1511	
		12.95-12.97	44		1987 477 284	↔ 1511	
		05.97-03.98	74	Fg.-Nr. →6K..W..169 289	1987 477 284	↔ 1511	
		12.97-03.98	44	Fg.-Nr. →6K..W..169 289	1987 477 284	↔ 1511	
		01.98-03.98	40	Fg.-Nr. →6K..W..169 289	1987 477 284	↔ 1511	
		05.99-05.02	44		SBR	1987 477 627	↔ 1641
				TBR	1987 477 695	↔ 1514	
		55			SBR	1987 477 627	↔ 1641
				TBR	1987 477 695	↔ 1514	
		09.99-05.02	74		SBR	1987 477 627	↔ 1641
					TBR	1987 477 695	↔ 1514
		ABO	04.98-10.99	40/44/74	Fg.-Nr. 6K..W..169 290→	1987 477 679	↔ 1512
		ABS	04.98-10.99	40/44/74	Fg.-Nr. 6K..W..169 290→	1987 477 695	↔ 1514
<b>1.6</b>		11.93-07.94	55	Fg.-Nr. 6K..ZR037 977→, 6K..ZR549 076→	1987 477 215	↔ 1532	
		05.94-03.98	55	Fg.-Nr. →6K..W..169 289	1987 477 284	↔ 1511	
		12.95-03.98	74	Fg.-Nr. →6K..W..169 289	1987 477 284	↔ 1511	
		05.99-05.02	74		SBR	1987 477 627	↔ 1641
				TBR	1987 477 695	↔ 1514	
	10.99-10.04	76		1987 477 695	1514		
	ABO	04.98-05.02	55/74	Fg.-Nr. 6K..W..169 290→	1987 477 679	↔ 1512	
	ABS	04.98-05.02	55/74	Fg.-Nr. 6K..W..169 290→	1987 477 695	↔ 1514	
<b>1.8</b>		09.93-06.96	95		1987 477 204	↔ 1625	
		11.93-07.94	66	Fg.-Nr. 6K..ZR037 977→, 6K..ZR549 076→	1987 477 215	↔ 1532	
		07.94-03.98	66	Fg.-Nr. →6K..W..169 289	1987 477 284	↔ 1511	
		ABO	04.98-10.99	66	Fg.-Nr. 6K..W..169 290→	1987 477 679	↔ 1512
		ABS	04.98-10.99	66	Fg.-Nr. 6K..W..169 290→	1987 477 695	↔ 1514
<b>1.8 T Cupra</b>		10.99-05.02	115		1987 477 627	↔ 1641	
<b>1.9 D</b>		11.93-09.94	47-50	Fg.-Nr. 6K..ZR037 977→6K..ZR126 718, 6K..ZR549 076→6K..ZR663 842	1987 477 215	↔ 1532	
		10.94-03.98	47-50	Fg.-Nr. 6K..ZR126 719→6K..W..169 289, 6K..ZR663 843→	1987 477 284	↔ 1511	
		ABO	04.98-10.99	47-50/66/81	Fg.-Nr. 6K..W..169 290→	1987 477 679	↔ 1512
		ABS	04.98-10.99	47-50/66/81	Fg.-Nr. 6K..W..169 290→	1987 477 695	↔ 1514
		12.95-03.98	47		SBR	1987 477 284	↔ 1511
				TBR	1987 477 695	↔ 1514	
	ABO	04.98-10.99	47-50/66/81	Fg.-Nr. 6K..W..169 290→	1987 477 679	↔ 1512	
	ABS	04.98-10.99	47-50/66/81	Fg.-Nr. 6K..W..169 290→	1987 477 695	↔ 1514	
<b>1.9 SDI</b>		12.95-03.98	47	Fg.-Nr. →6K..W..169 289	1987 477 284	↔ 1511	
		05.99-05.02	50		SBR	1987 477 627	↔ 1641
				TBR	1987 477 695	↔ 1514	
		ABO	04.98-10.99	47-50/66/81	Fg.-Nr. 6K..W..169 290→	1987 477 679	↔ 1512
		ABS	04.98-10.99	47-50/66/81	Fg.-Nr. 6K..W..169 290→	1987 477 695	↔ 1514
<b>1.9 TD</b>		11.93-09.94	55	Fg.-Nr. 6K..ZR037 977→6K..ZR126 718, 6K..ZR549 076→6K..ZR663 842	1987 477 215	↔ 1532	
		10.94-08.97	55	Fg.-Nr. 6K..ZR126 719→, 6K..ZR663 843→	1987 477 284	↔ 1511	
		07.96-12.96	66		1987 477 284	↔ 1511	
<b>1.9 TDI</b>		12.96-03.98	66	Fg.-Nr. →6K..W..169 289	1987 477 284	↔ 1511	
		03.97-03.98	81	Fg.-Nr. →6K..W..169 289	1987 477 284	↔ 1511	
		05.99-05.02	66		SBR	1987 477 627	↔ 1641
				TBR	1987 477 695	↔ 1514	
			81		1987 477 627	↔ 1641	
		ABO	04.98-06.99	47-50/66/81	Fg.-Nr. 6K..W..169 290→	1987 477 679	↔ 1512
		ABS	04.98-06.99	47-50/66/81	Fg.-Nr. 6K..W..169 290→	1987 477 695	↔ 1514
	<b>2.0</b>		03.93-04.96	85		1987 477 204	↔ 1625
		04.96-09.96	85	Fg.-Nr. →6K..V..000 537, →6K..V..013 236	1987 477 204	↔ 1625	

		S										
2.0				06.96-09.96	110	Fg.-Nr. →6K..V..000 537, →6K..V..013 236	1 987 477 204	↔ 1625				
							10.96-10.99	85	Fg.-Nr. 6K..V..000 538→, 6K..V..013 237→	1 987 477 627	↔ 1641	
								110	Fg.-Nr. 6K..V..000 538→, 6K..V..013 237→	1 987 477 627	↔ 1641	
	1.0	1.0 16V		09.96-10.04	37/51/52		0 986 594 009 <sup>4</sup>					
							LAB	0 986 594 001 <sup>3</sup>				
	1.4			09.93-12.95	44		TW	0 986 594 009 <sup>4</sup>				
							LAB	0 986 594 001 <sup>3</sup>				
				09.93-05.02	44		RAB	0 986 594 000 <sup>3</sup>				
							LAB	0 986 594 009 <sup>4</sup>				
				12.95-05.02	44			0 986 594 009 <sup>4</sup>				
							LAB	0 986 594 001 <sup>3</sup>				
				05.97-05.02	55/74		RAB	0 986 594 000 <sup>3</sup>				
							LAB	0 986 594 009 <sup>4</sup>				
				01.98-05.98	40			0 986 594 009 <sup>4</sup>				
							LAB	0 986 594 001 <sup>3</sup>				
				05.94-08.99	55		TW	0 986 594 009 <sup>4</sup>				
							LAB	0 986 594 001 <sup>3</sup>				
				05.94-05.02	55		RAB	0 986 594 000 <sup>3</sup>				
							LAB	0 986 594 009 <sup>4</sup>				
				05.95-10.04	74/76			0 986 594 009 <sup>4</sup>				
							LAB	0 986 594 001 <sup>3</sup>				
				03.97-05.02	55		RAB	0 986 594 000 <sup>3</sup>				
							LAB	0 986 594 009 <sup>4</sup>				
1.8				03.93-10.99	66/95		LAB	0 986 594 001 <sup>3</sup>				
							RAB	0 986 594 000 <sup>3</sup>				
							TW	0 986 594 009 <sup>4</sup>				
							LAB	0 986 594 001 <sup>3</sup>				
1.8 T Cupra				10.99-05.02	115			0 986 594 009 <sup>4</sup>				
							LAB	0 986 594 001 <sup>3</sup>				
							RAB	0 986 594 000 <sup>3</sup>				
							LAB	0 986 594 009 <sup>4</sup>				
1.9 D				03.93-10.99	47-50		LAB	0 986 594 001 <sup>3</sup>				
							RAB	0 986 594 000 <sup>3</sup>				
							TW	0 986 594 009 <sup>4</sup>				
							LAB	0 986 594 001 <sup>3</sup>				
1.9 SDI				12.95-10.99	47			0 986 594 009 <sup>4</sup>				
							LAB	0 986 594 001 <sup>3</sup>				
							RAB	0 986 594 000 <sup>3</sup>				
							LAB	0 986 594 009 <sup>4</sup>				
				05.99-05.02	50			0 986 594 009 <sup>4</sup>				
							LAB	0 986 594 001 <sup>3</sup>				
							RAB	0 986 594 000 <sup>3</sup>				
							LAB	0 986 594 009 <sup>4</sup>				
1.9 TD				03.93-08.97	55		LAB	0 986 594 001 <sup>3</sup>				
							RAB	0 986 594 000 <sup>3</sup>				
							TW	0 986 594 009 <sup>4</sup>				
							LAB	0 986 594 001 <sup>3</sup>				
1.9 TDI				07.96-05.02	66/81			0 986 594 009 <sup>4</sup>				
							LAB	0 986 594 001 <sup>3</sup>				
							RAB	0 986 594 000 <sup>3</sup>				
							LAB	0 986 594 009 <sup>4</sup>				
2.0				03.93-04.96	85		TW	0 986 594 009 <sup>4</sup>				
							LAB	0 986 594 001 <sup>3</sup>				
				03.93-10.99	85		RAB	0 986 594 000 <sup>3</sup>				
							LAB	0 986 594 009 <sup>4</sup>				
				04.96-10.99	85			0 986 594 009 <sup>4</sup>				
							LAB	0 986 594 001 <sup>3</sup>				
				06.96-10.99	110		RAB	0 986 594 000 <sup>3</sup>				
							LAB	0 986 594 009 <sup>4</sup>				
								0 986 594 009 <sup>4</sup>				
							LAB	0 986 594 001 <sup>3</sup>				
							RAB	0 986 594 000 <sup>3</sup>				
							LAB	0 986 594 009 <sup>4</sup>				
<b>Ibiza [6L1]</b>												
												
	1.2			11.01-11.09	44/47/51		252	0 986 473 071	 ← 54	1 987 470 506 <sup>8</sup>		
								0 986 474 071	 → 54	1 987 470 506 <sup>8</sup>		
							288	0 986 473 192	 ← 54	1 987 470 287 <sup>7</sup>		
								0 986 474 192	 → 54	1 987 470 287 <sup>7</sup>		
1.4	1.4 TDI			09.01-11.09	51/55/59/ 63/74		252	0 986 473 071	 ← 54	1 987 470 506 <sup>8</sup>		
								0 986 474 071	 → 54	1 987 470 506 <sup>8</sup>		

		S							
	SEAT Ibiza [6L1]								
1.4	09.01-11.09	51/55/59/			288	0986 473 192		54	1987 470 287 <sup>7</sup>
1.4 TDI		63/74				0986 474 192		54	1987 470 287 <sup>7</sup>
1.6	04.03-11.09	74/77			252	0986 473 071		54	1987 470 506 <sup>8</sup>
					288	0986 474 071		54	1987 470 506 <sup>8</sup>
1.8 T	12.03-11.09	110			252	0986 473 192		54	1987 470 287 <sup>7</sup>
					288	0986 474 192		54	1987 470 287 <sup>7</sup>
1.8 T Cupra R	05.04-02.08	132			BSR	0986 473 071		54	1987 470 506 <sup>8</sup>
					BSR	0986 474 071		54	1987 470 506 <sup>8</sup>
1.9 SDI	09.01-11.09	47/74/96			252	0986 473 192		54	1987 470 287 <sup>7</sup>
					288	0986 474 192		54	1987 470 287 <sup>7</sup>
1.9 TDI	09.01-11.09	47/74/96			252	0986 473 071		54	1987 470 506 <sup>8</sup>
					288	0986 474 071		54	1987 470 506 <sup>8</sup>
1.9 TDI Cupra R	03.04-11.05	118			BSR	0986 473 923		54	1987 470 506 <sup>8</sup>
					BSR	0986 474 924		54	1987 470 506 <sup>8</sup>
	11.05-02.08	118			252	0986 473 071		54	1987 470 506 <sup>8</sup>
					288	0986 474 071		54	1987 470 506 <sup>8</sup>
2.0	07.02-11.09	85			252	0986 473 192		54	1987 470 287 <sup>7</sup>
					288	0986 474 192		54	1987 470 287 <sup>7</sup>
1.2	11.01-06.06	47				0986 475 433		19,05	
	05.06-10.06	51	Fg.-Nr. →6L..7..108 000			0986 475 433		19,05	
	11.06-11.09	51	Fg.-Nr. 6L..7..108 001→			0986 475 260		17,46	
	06.07-05.08	44				0986 475 260		17,46	
1.4	09.01-05.02	74				0986 475 433		19,05	
						0986 475 433		19,05	
1.4	04.02-10.06	74	Fg.-Nr. →6L..7..108 000			0986 475 433		19,05	
			Fg.-Nr. →6L..7..108 000			0986 475 433		19,05	
1.4	11.06-12.07	55	Fg.-Nr. 6L..7..108 001→			0986 475 260		17,46	
			Fg.-Nr. 6L..7..108 001→			0986 475 260		17,46	
1.4	05.05-10.06	59/63	Fg.-Nr. →6L..7..108 000			0986 475 433		19,05	
			Fg.-Nr. 6L..7..108 001→			0986 475 260		17,46	
1.4 TDI	11.06-11.09	59/63	Fg.-Nr. 6L..7..108 001→			0986 475 260		17,46	
			Fg.-Nr. 6L..7..108 001→			0986 475 433		19,05	
1.4 TDI	05.02-12.05	55				0986 475 433		19,05	
						0986 475 433		19,05	
1.6	05.05-10.06	59/63	Fg.-Nr. →6L..7..108 000			0986 475 433		19,05	
			Fg.-Nr. 6L..7..108 001→			0986 475 260		17,46	
1.6	11.06-11.09	74	Fg.-Nr. →6L..7..108 000			0986 475 433		19,05	
			Fg.-Nr. 6L..7..108 001→			0986 475 260		17,46	
1.8 T Cupra R	05.04-10.06	132	Fg.-Nr. →6L..7..108 000			0986 475 433		19,05	
			Fg.-Nr. 6L..7..108 001→			0986 475 260		17,46	
1.9 SDI	11.06-02.08	132	Fg.-Nr. 6L..7..108 001→			0986 475 260		17,46	
			Fg.-Nr. 6L..7..108 001→			0986 475 433		19,05	
1.9 TDI	01.02-12.05	47				0986 475 433		19,05	
						0986 475 433		19,05	
1.9 TDI Cupra R	09.01-11.05	74/96/118				0986 475 433		19,05	
						0986 475 433		19,05	
1.9 TDI Cupra R	05.05-10.06	74/96/118	Fg.-Nr. →6L..7..108 000			0986 475 433		19,05	
			Fg.-Nr. 6L..7..108 001→			0986 475 260		17,46	
2.0	11.06-11.09	74	Fg.-Nr. 6L..7..108 001→			0986 475 260		17,46	
			Fg.-Nr. 6L..7..108 001→			0986 475 433		19,05	
2.0	07.02-04.04	85				0986 475 433		19,05	
						0986 475 433		19,05	
2.0	04.03-10.06	85	Fg.-Nr. →6L..7..108 000			0986 475 433		19,05	
			Fg.-Nr. 6L..7..108 001→			0986 475 260		17,46	
2.0	11.06-11.09	85	Fg.-Nr. 6L..7..108 001→			0986 475 260		17,46	
			Fg.-Nr. 6L..7..108 001→			0986 475 433		19,05	
	1.2	11.01-04.05	47	PR-Code 1KK, PR-Code 1KT		0986 474 099		38,1	1987 474 496 <sup>8</sup>
				PR-Code 1KD, PR-Code 1KS		0986 473 180		34	1987 474 496 <sup>8</sup>
	1.2	11.01-06.06	47	PR-Code 1KK, PR-Code 1KT		0986 474 180		34	1987 474 496 <sup>8</sup>
				PR-Code 1KK, PR-Code 1KT		0986 473 099		38,1	1987 470 040
	1.2	11.04-06.06	47	PR-Code 1KK, PR-Code 1KT		0986 474 099		38,1	1987 470 040
				PR-Code 1KK, PR-Code 1KT		0986 473 099		38,1	1987 474 496 <sup>8</sup>



































		<b>S</b>							
<b>1.2</b>	06.07-05.08	44	PR-Code 1KD, PR-Code 1KS	0 986 473 180		← 34	1 987 474 496 <sup>B</sup>		
				0 986 474 180		→ 34	1 987 474 496 <sup>B</sup>		
			PR-Code 1KK, PR-Code 1KT	0 986 473 099		← 38,1	1 987 470 040		
				0 986 473 099		← 38,1	1 987 474 496 <sup>B</sup>		
				0 986 474 099		→ 38,1	1 987 470 040		
<b>1.4</b>	09.01-05.02	74	PR-Code 1KK, PR-Code 1KT	0 986 474 099		→ 38,1	1 987 474 496 <sup>B</sup>		
			09.01-11.09	74	PR-Code 1KD, PR-Code 1KS	0 986 473 180		← 34	1 987 474 496 <sup>B</sup>
				0 986 474 180		→ 34	1 987 474 496 <sup>B</sup>		
				PR-Code 1KK, PR-Code 1KT	0 986 473 099		← 38,1	1 987 470 040	
				0 986 474 099		→ 38,1	1 987 470 040		
<b>1.4</b>	04.02-11.09	74	PR-Code 1KK, PR-Code 1KT	0 986 473 099		← 38,1	1 987 474 496 <sup>B</sup>		
			01.02-11.09	51/55/59/63	PR-Code 1KD, PR-Code 1KS	0 986 473 180		← 34	1 987 474 496 <sup>B</sup>
<b>1.4 TDI</b>			PR-Code 1KK, PR-Code 1KT	0 986 474 180		→ 34	1 987 474 496 <sup>B</sup>		
				0 986 473 099		← 38,1	1 987 470 040		
				0 986 473 099		← 38,1	1 987 474 496 <sup>B</sup>		
				0 986 474 099		→ 38,1	1 987 470 040		
<b>1.6</b>	04.03-11.09	74/77	PR-Code 1KD, PR-Code 1KS	0 986 473 180		← 34	1 987 474 496 <sup>B</sup>		
				0 986 474 180		→ 34	1 987 474 496 <sup>B</sup>		
			PR-Code 1KK, PR-Code 1KT	0 986 473 099		← 38,1	1 987 470 040		
				0 986 473 099		← 38,1	1 987 474 496 <sup>B</sup>		
				0 986 474 099		→ 38,1	1 987 470 040		
<b>1.8 T</b>	12.03-05.08	110	PR-Code 1KK, PR-Code 1KT	0 986 474 099		→ 38,1	1 987 474 496 <sup>B</sup>		
			12.03-11.09	110	PR-Code 1KD, PR-Code 1KS	0 986 473 180		← 34	1 987 474 496 <sup>B</sup>
				0 986 474 180		→ 34	1 987 474 496 <sup>B</sup>		
				PR-Code 1KK, PR-Code 1KT	0 986 473 099		← 38,1	1 987 470 040	
				0 986 473 099		← 38,1	1 987 474 496 <sup>B</sup>		
				0 986 474 099		→ 38,1	1 987 470 040		
<b>1.8 T Cupra R</b>	05.04-02.08	132	PR-Code 1KK, PR-Code 1KT	0 986 473 099		← 38,1	1 987 470 040		
				0 986 473 099		← 38,1	1 987 474 496 <sup>B</sup>		
			PR-Code 1KP	BSR					1 987 470 040
							1 987 474 496 <sup>B</sup>		
<b>1.9 SDI</b>	01.02-12.05	47	PR-Code 1KD, PR-Code 1KS	0 986 473 180		← 34	1 987 474 496 <sup>B</sup>		
				0 986 474 180		→ 34	1 987 474 496 <sup>B</sup>		
			PR-Code 1KK, PR-Code 1KT	0 986 473 099		← 38,1	1 987 470 040		
				0 986 473 099		← 38,1	1 987 474 496 <sup>B</sup>		
				0 986 474 099		→ 38,1	1 987 470 040		
<b>1.9 TDI</b>	09.01-05.05	74	PR-Code 1KK, PR-Code 1KT	0 986 474 099		→ 38,1	1 987 474 496 <sup>B</sup>		
			09.01-11.09	74	PR-Code 1KD, PR-Code 1KS	0 986 473 180		← 34	1 987 474 496 <sup>B</sup>
				0 986 474 180		→ 34	1 987 474 496 <sup>B</sup>		
				PR-Code 1KK, PR-Code 1KT	0 986 473 099		← 38,1	1 987 470 040	
				0 986 474 099		→ 38,1	1 987 470 040		
				0 986 473 180		← 34	1 987 474 496 <sup>B</sup>		
				0 986 474 180		→ 34	1 987 474 496 <sup>B</sup>		
				0 986 473 099		← 38,1	1 987 470 040		
				0 986 473 099		← 38,1	1 987 474 496 <sup>B</sup>		
				0 986 474 099		→ 38,1	1 987 470 040		
<b>1.9 TDI Cupra R</b>	03.04-11.05	118	PR-Code 1KK, PR-Code 1KT	0 986 473 099		← 38,1	1 987 470 040		
				0 986 473 099		← 38,1	1 987 474 496 <sup>B</sup>		
			PR-Code 1KP	BSR					1 987 470 040
							1 987 474 496 <sup>B</sup>		
<b>2.0</b>	07.02-04.04	85	PR-Code 1KK, PR-Code 1KT	0 986 473 180		← 34	1 987 474 496 <sup>B</sup>		
			07.02-11.09	85	PR-Code 1KD, PR-Code 1KS	0 986 474 180		→ 34	1 987 474 496 <sup>B</sup>
				0 986 473 099		← 38,1	1 987 470 040		
				PR-Code 1KK, PR-Code 1KT	0 986 473 099		← 38,1	1 987 474 496 <sup>B</sup>	
				0 986 474 099		→ 38,1	1 987 470 040		

		S							
	SEAT Ibiza [6L1]								
2.0		04.03-11.09	85	PR-Code 1KK, PR-Code 1KT			0986 473 099	← 38,1	1987 474 496 <sup>8</sup>
	1.2	11.01-11.09	44/47/51		HTB,SSZ	1987 482 446	↔ 1580		
					HTB,SSZ	1987 477 806	↔ 1580		
					4SB,SSZ	1987 482 191	↔ 1645		
					4SB,SSZ	1987 477 807	↔ 1640		
	1.4	09.01-11.09	51/55/59/ 63/74		HTB,SSZ	1987 482 446	↔ 1580		
					HTB,SSZ	1987 477 806	↔ 1580		
					4SB,SSZ	1987 482 191	↔ 1645		
					4SB,SSZ	1987 477 807	↔ 1640		
	1.4 TDI	05.02-11.09	51/55/59/ 63/74		HTB,SSZ	1987 482 446	↔ 1580		
					HTB,SSZ	1987 477 806	↔ 1580		
					4SB,SSZ	1987 482 191	↔ 1645		
					4SB,SSZ	1987 477 807	↔ 1640		
	1.6	04.03-11.09	74/77		HTB,SSZ	1987 482 446	↔ 1580		
					HTB,SSZ	1987 477 806	↔ 1580		
					4SB,SSZ	1987 482 191	↔ 1645		
					4SB,SSZ	1987 477 807	↔ 1640		
	1.8 T	12.03-11.09	110/132		HTB,SSZ	1987 482 446	↔ 1580		
					HTB,SSZ	1987 477 806	↔ 1580		
					4SB,SSZ	1987 482 191	↔ 1645		
					4SB,SSZ	1987 477 807	↔ 1640		
	1.8 T Cupra R	05.04-02.08	110/132		HTB,SSZ	1987 482 446	↔ 1580		
					HTB,SSZ	1987 477 806	↔ 1580		
					4SB,SSZ	1987 482 191	↔ 1645		
					4SB,SSZ	1987 477 807	↔ 1640		
	1.9 SDI	01.02-12.05	47/74/96/ 118		HTB,SSZ	1987 482 446	↔ 1580		
					HTB,SSZ	1987 477 806	↔ 1580		
					4SB,SSZ	1987 482 191	↔ 1645		
					4SB,SSZ	1987 477 807	↔ 1640		
	1.9 TDI	09.01-11.09	47/74/96/ 118		HTB,SSZ	1987 482 446	↔ 1580		
					HTB,SSZ	1987 477 806	↔ 1580		
					4SB,SSZ	1987 482 191	↔ 1645		
					4SB,SSZ	1987 477 807	↔ 1640		
	1.9 TDI Cupra R	03.04-02.08	47/74/96/ 118		HTB,SSZ	1987 482 446	↔ 1580		
					HTB,SSZ	1987 477 806	↔ 1580		
					4SB,SSZ	1987 482 191	↔ 1645		
					4SB,SSZ	1987 477 807	↔ 1640		
	2.0	07.02-11.09	85		HTB,SSZ	1987 482 446	↔ 1580		
					HTB,SSZ	1987 477 806	↔ 1580		
					4SB,SSZ	1987 482 191	↔ 1645		
					4SB,SSZ	1987 477 807	↔ 1640		
	1.2	11.01-11.09	47/51		LAB	0986 594 500 <sup>3</sup>			
						0986 594 502 <sup>4</sup>			
					RAB	0986 594 501 <sup>3</sup>			
						0986 594 503 <sup>4</sup>			
		06.07-05.08	44		LAB	0986 594 500 <sup>3</sup>			
					RAB	0986 594 501 <sup>3</sup>			
	1.4	09.01-11.09	51/55/59/ 63/74		LAB	0986 594 500 <sup>3</sup>			
	1.4 TDI					0986 594 502 <sup>4</sup>			
					RAB	0986 594 501 <sup>3</sup>			
						0986 594 503 <sup>4</sup>			
	1.6	04.03-11.09	74/77		LAB	0986 594 500 <sup>3</sup>			
						0986 594 502 <sup>4</sup>			
					RAB	0986 594 501 <sup>3</sup>			
						0986 594 503 <sup>4</sup>			
	1.8 T	12.03-11.09	110/132		LAB	0986 594 500 <sup>3</sup>			
	1.8 T Cupra R					0986 594 502 <sup>4</sup>			
					RAB	0986 594 501 <sup>3</sup>			
						0986 594 503 <sup>4</sup>			

		S							
1.9 SDI		09.01-11.09	47/74/96/			LAB	0 986 594 500 <sup>3</sup>		
1.9 TDI			118				0 986 594 502 <sup>4</sup>		
1.9 TDI Cupra R						RAB	0 986 594 501 <sup>3</sup>		
							0 986 594 503 <sup>4</sup>		
2.0		07.02-11.09	85			LAB	0 986 594 500 <sup>3</sup>		
							0 986 594 502 <sup>4</sup>		
						RAB	0 986 594 501 <sup>3</sup>		
							0 986 594 503 <sup>4</sup>		
<b>Inca [6K9]</b>									
									
	1.4	11.95-06.03	44/55	PR-Code 1LL, PR-Code 1LY, PR-Code 1ZK			0 986 471 669	← 54	1 987 470 287 <sup>7</sup>
							0 986 473 669		
							0 986 472 669	→ 54	1 987 470 287 <sup>7</sup>
							0 986 474 669		
	1.6	11.95-09.00	55	PR-Code 1LL, PR-Code 1LY, PR-Code 1ZK			0 986 471 669	← 54	1 987 470 287 <sup>7</sup>
							0 986 473 669		
							0 986 472 669	→ 54	1 987 470 287 <sup>7</sup>
							0 986 474 669		
	1.7 D	09.96-09.00	42	PR-Code 1LL, PR-Code 1LY, PR-Code 1ZK			0 986 471 669	← 54	1 987 470 287 <sup>7</sup>
							0 986 473 669		
							0 986 472 669	→ 54	1 987 470 287 <sup>7</sup>
							0 986 474 669		
	1.9 D	11.95-06.03	47	PR-Code 1LL, PR-Code 1LY, PR-Code 1ZK			0 986 471 669	← 54	1 987 470 287 <sup>7</sup>
	1.9 SDI						0 986 473 669		
							0 986 472 669	→ 54	1 987 470 287 <sup>7</sup>
							0 986 474 669		
									
	1.4	11.95-06.03	44/55				0 986 475 039	↔ 20,64	
	1.6	11.95-09.00	55				0 986 475 039	↔ 20,64	
	1.7 D	09.96-09.00	42				0 986 475 039	↔ 20,64	
	1.9 D	11.95-06.03	47				0 986 475 039	↔ 20,64	
	1.9 SDI								
									
	1.4	11.95-06.03	44/55				1 987 477 626	↔ 1671	
	1.6	11.95-09.00	55				1 987 477 626	↔ 1671	
	1.7 D	09.96-09.00	42				1 987 477 626	↔ 1671	
	1.9 D	11.95-06.03	47				1 987 477 626	↔ 1671	
	1.9 SDI	12.95-06.03	47				1 987 477 626	↔ 1671	
	1.4	11.95-06.03	44/55			LAB	0 986 594 001 <sup>3</sup>		
						RAB	0 986 594 000 <sup>3</sup>		
	1.6	11.95-09.00	55			LAB	0 986 594 001 <sup>3</sup>		
						RAB	0 986 594 000 <sup>3</sup>		
	1.7 D	09.96-09.00	42			LAB	0 986 594 001 <sup>3</sup>		
						RAB	0 986 594 000 <sup>3</sup>		
	1.9 D	11.95-06.03	47			LAB	0 986 594 001 <sup>3</sup>		
	1.9 SDI					RAB	0 986 594 000 <sup>3</sup>		
<b>Leon Cupra R [1M1]</b>									
									
	1.8 T	05.02-06.06	154/165				0 986 473 147	 ← 38	1 987 470 040
							0 986 473 147	 ← 38	1 987 474 496 <sup>8</sup>
							0 986 474 147	 → 38	1 987 470 040



















		S							
◀ SEAT Leon Cupra R [1M1]									
	1.8 T	05.02-06.06	154/165				1987 477 698	↔ 1693	
	1.8 T	05.02-06.06	154/165				0986 594 004 <sup>4</sup>		
							LAB 0986 594 001 <sup>3</sup>		
							RAB 0986 594 000 <sup>3</sup>		
Leon Cupra SC [5F5]									
	2.0 TSI	10.13→	195/206	PR-Code 1ZF					1987 470 506 <sup>8</sup>
	2.0 TSI	10.13→	195/206	PR-Code 1KD	D53				1987 470 040
									1987 474 496 <sup>8</sup>
				PR-Code 1KS					1987 470 040
	2.0 TSI	10.13→	195/206	PR-Code OB2	Y85		1987 482 456	↔ 1463	
	2.0 TSI	10.13→	195/206			GBM	0986 594 526 <sup>4</sup>		
						LAB	0986 594 500 <sup>3</sup>		
						RAB	0986 594 501 <sup>3</sup>		
Leon Cupra [1M1]									
	2.8 Syncro	10.00-10.00	150	Fg.-Nr. →1M..1B044 183, →	312		0986 473 923	← 54	1987 470 506 <sup>8</sup>
				1M..1R049 650			0986 473 924	→ 54	1987 470 506 <sup>8</sup>
		10.00-04.04	150		288		0986 471 923	← 54	1987 470 506 <sup>8</sup>
							0986 473 923		
							0986 471 924	→ 54	1987 470 506 <sup>8</sup>
							0986 473 924		
		11.00-07.01	150	Fg.-Nr. 1M..1B044 183→,	312		0986 473 923	← 54	1987 470 506 <sup>8</sup>
				1M..1R049 651→			0986 473 924	→ 54	1987 470 506 <sup>8</sup>
		06.01-04.04	150		312		0986 473 923	← 54	1987 470 506 <sup>8</sup>
							0986 473 924	→ 54	1987 470 506 <sup>8</sup>
	2.8 Syncro	10.00-07.01	150		252,BSR		0986 474 147	→ 38	1987 474 496 <sup>8</sup>
		10.00-04.04	150		252,BSR		0986 473 139	← 38,1	1987 470 040
							0986 473 139	← 38,1	1987 474 496 <sup>8</sup>
							0986 474 139	→ 38,1	1987 470 040
					252,BSR		0986 473 147	← 38	1987 470 040
							0986 474 147	→ 38	1987 470 040
		06.01-04.04	150		252,BSR		0986 473 147	← 38	1987 474 496 <sup>8</sup>
	2.8 Syncro	10.00-04.04	150				0986 594 008 <sup>4</sup>		
							LAB 0986 594 001 <sup>3</sup>		
							RAB 0986 594 000 <sup>3</sup>		































		<b>S</b>							
<b>Leon Cupra [1P1]</b>									
									
	2.0 TFSI	09.09-09.09	195						F 026 <b>A03 545</b> <sup>7</sup> 1987 <b>470 506</b> <sup>8</sup>
		10.09-12.12	195			0 986 <b>134 287</b>			F 026 <b>A03 545</b> <sup>7</sup> 1987 <b>470 506</b> <sup>8</sup>
						0 986 <b>134 287</b>			1987 <b>470 506</b> <sup>8</sup>
						0 986 <b>135 287</b>			F 026 <b>A03 545</b> <sup>7</sup>
									
	2.0 TFSI	09.09-12.12	195			0 986 <b>134 048</b>	 38		
						0 986 <b>135 048</b>	 38		
									
	2.0 TFSI	09.09-12.12	195		TW	1 987 <b>477 958</b>	 1447		
						1 987 <b>482 445</b>	 1447		
	2.0 TFSI	09.09-10.09	195		LAB	0 986 <b>594 506</b> <sup>4</sup>			
					RAB	0 986 <b>594 507</b> <sup>4</sup>			
		09.09-12.12	195		LAB	0 986 <b>594 504</b> <sup>3</sup>			
					RAB	0 986 <b>594 505</b> <sup>3</sup>			
<b>Leon Cupra [5F1]</b>									
									
	2.0 TSI	10.13→	195/ 206-210	PR-Code 1ZF					1987 <b>470 506</b> <sup>8</sup>
									
	2.0 TSI	10.13→	195/ 206-210	PR-Code 1KD	D53				1987 <b>470 040</b> 1987 <b>474 496</b> <sup>8</sup> 1987 <b>470 040</b>
				PR-Code 1KS					
									
	2.0 TSI	10.13→	195/ 206-210	PR-Code OB2	Y85	1 987 <b>482 456</b>	 1463		
	2.0 TSI	10.13→	195/ 206-210		GBM	0 986 <b>594 526</b> <sup>4</sup>			
					LAB	0 986 <b>594 500</b> <sup>3</sup>			
					RAB	0 986 <b>594 501</b> <sup>3</sup>			
<b>Leon SC [5F5]</b>									
									
	1.2 TSI	05.14→	81	PR-Code 1ZF					1987 <b>470 506</b> <sup>8</sup>
	1.4 TSI, TSI ACT	05.14→	92/110	PR-Code 1ZF					1987 <b>470 506</b> <sup>8</sup>
	1.6 TDI	11.14→	81	PR-Code 1ZF, PR-Code 1ZH					1987 <b>470 506</b> <sup>8</sup>
									
	1.2 TSI	01.13→	63/77						1987 <b>470 040</b> 1987 <b>474 496</b> <sup>8</sup>
		05.14→	81	PR-Code 1KD	D53				1987 <b>470 040</b> 1987 <b>474 496</b> <sup>8</sup>
				PR-Code 1KS					1987 <b>470 040</b>
	1.4 TSI	02.13→	90						1987 <b>470 040</b> 1987 <b>474 496</b> <sup>8</sup>
			103						1987 <b>470 040</b> 1987 <b>474 496</b> <sup>8</sup>



		S							
	SEAT Leon SC [5F5]								
1.4 TSI	05.14→	92	PR-Code 1KD	D53					1987 470 040 1987 474 496 <sup>8</sup>
			PR-Code 1KS						1987 470 040
1.4 TSI ACT	05.14→	110	PR-Code 1KD	D53					1987 470 040 1987 474 496 <sup>8</sup>
			PR-Code 1KS						1987 470 040
1.6 TDI	02.13→	66/77							1987 470 040 1987 474 496 <sup>8</sup>
	08.13→	81							1987 470 040 1987 474 496 <sup>8</sup>
	11.14→	81	PR-Code 1KD	D53					1987 470 040 1987 474 496 <sup>8</sup>
1.8 TSI	02.13→	132							1987 470 040
2.0 TDI	02.13→	110							1987 470 040 1987 474 496 <sup>8</sup>
	08.13→	81/105	PR-Code 1KD	D53					1987 470 040 1987 474 496 <sup>8</sup>
			PR-Code 1KS						1987 470 040
		135							1987 470 040
	1.2 TSI	01.13→	63/77/81	PR-Code OB2	Y85	1987 482 456		↔ 1463	
	1.4 TSI	02.13→	90/92/103/110	PR-Code OB2	Y85	1987 482 456		↔ 1463	
	1.4 TSI ACT	05.14→	90/92/103/110	PR-Code OB2	Y85	1987 482 456		↔ 1463	
	1.6 TDI	02.13→	66/77/81	PR-Code OB2	Y85	1987 482 456		↔ 1463	
	1.8 TSI	02.13→	132	PR-Code OB2	Y85	1987 482 456		↔ 1463	
	2.0 TDI	02.13→	81/105/110/135	PR-Code OB2	Y85	1987 482 456		↔ 1463	
	1.2 TSI	01.13→	63/77			0986 594 526 <sup>4</sup>			
					LAB	0986 594 500 <sup>3</sup>			
					RAB	0986 594 501 <sup>3</sup>			
		05.14→	81		GBM	0986 594 526 <sup>4</sup>			
					LAB	0986 594 500 <sup>3</sup>			
					RAB	0986 594 501 <sup>3</sup>			
	1.4 TSI	02.13→	90			0986 594 526 <sup>4</sup>			
					LAB	0986 594 500 <sup>3</sup>			
					RAB	0986 594 501 <sup>3</sup>			
			103			0986 594 526 <sup>4</sup>			
					LAB	0986 594 500 <sup>3</sup>			
					RAB	0986 594 501 <sup>3</sup>			
		05.14→	92		GBM	0986 594 526 <sup>4</sup>			
					LAB	0986 594 500 <sup>3</sup>			
					RAB	0986 594 501 <sup>3</sup>			
	1.4 TSI ACT	05.14→	110		GBM	0986 594 526 <sup>4</sup>			
					LAB	0986 594 500 <sup>3</sup>			
					RAB	0986 594 501 <sup>3</sup>			
	1.6 TDI	02.13→	66/77			0986 594 526 <sup>4</sup>			
					LAB	0986 594 500 <sup>3</sup>			
					RAB	0986 594 501 <sup>3</sup>			
		08.13→	81			0986 594 526 <sup>4</sup>			
					LAB	0986 594 500 <sup>3</sup>			
					RAB	0986 594 501 <sup>3</sup>			
		11.14→	81		GBM	0986 594 526 <sup>4</sup>			
	1.8 TSI	02.13→	132			0986 594 526 <sup>4</sup>			
					LAB	0986 594 500 <sup>3</sup>			
					RAB	0986 594 501 <sup>3</sup>			
	2.0 TDI	02.13→	81/105/110/135			0986 594 526 <sup>4</sup>			
					LAB	0986 594 500 <sup>3</sup>			
					RAB	0986 594 501 <sup>3</sup>			















































































		S							
<b>Leon ST Cupra [5F8]</b>									
									
	2.0 TSI	07.14→	195	PR-Code 1ZF					1 987 470 506 <sup>B</sup>
			206	PR-Code 1ZF					1 987 470 506 <sup>B</sup>
				PR-Code 1ZH					1 987 470 506 <sup>B</sup>
									
	2.0 TSI	07.14→	195/206	PR-Code 1KD	D53				1 987 470 040
				PR-Code 1KS					1 987 474 496 <sup>B</sup>
									1 987 470 040
									
	2.0 TSI	07.14→	195/206	PR-Code OB2	Y85	1 987 482 456	↔ 1463		
		2.0 TSI	07.14→	195	GBM	0 986 594 526 <sup>4</sup>			
					LAB	0 986 594 500 <sup>3</sup>			
					RAB	0 986 594 501 <sup>3</sup>			
			206		LAB	0 986 594 500 <sup>3</sup>			
					RAB	0 986 594 501 <sup>3</sup>			
<b>Leon ST [5F8]</b>									
									
	1.2 TSI	05.14→	81	PR-Code 1ZF					1 987 470 506 <sup>B</sup>
	1.4 TGI	08.14→	81	PR-Code 1ZF, PR-Code 1ZH					1 987 470 506 <sup>B</sup>
	1.4 TSI	05.14→	92/110	PR-Code 1ZF					1 987 470 506 <sup>B</sup>
	1.4 TSI ACT								
	1.6 TDI	11.14→	81	PR-Code 1ZF, PR-Code 1ZH					1 987 470 506 <sup>B</sup>
	1.6 TDI 4x4	02.14→	77	PR-Code 1ZF					1 987 470 506 <sup>B</sup>
	1.8 TSI 4Drive	11.14→	132	PR-Code 1ZF, PR-Code 1ZH					1 987 470 506 <sup>B</sup>
	2.0 TDI, TDI 4Drive	05.14→	110	PR-Code 1ZF					1 987 470 506 <sup>B</sup>
	2.0 TDI 4WD	06.14→	110	PR-Code 1ZF, PR-Code 1ZH					1 987 470 506 <sup>B</sup>
									
	1.2 TSI	08.13→	63/77						1 987 470 040
									1 987 474 496 <sup>B</sup>
		05.14→	81	PR-Code 1KD	D53				1 987 470 040
				PR-Code 1KS					1 987 474 496 <sup>B</sup>
				PR-Code 1KS					1 987 470 040
	1.4 TGI	08.14→	81	PR-Code 1KD	D53				1 987 470 040
				PR-Code 1KS					1 987 474 496 <sup>B</sup>
				PR-Code 1KS					1 987 470 040
	1.4 TSI	08.13→	90						1 987 470 040
			103						1 987 474 496 <sup>B</sup>
									1 987 470 040
		05.14→	92	PR-Code 1KD	D53				1 987 470 040
				PR-Code 1KS					1 987 474 496 <sup>B</sup>
				PR-Code 1KS					1 987 470 040
	1.4 TSI ACT	05.14→	110	PR-Code 1KD	D53				1 987 470 040
				PR-Code 1KS					1 987 474 496 <sup>B</sup>
				PR-Code 1KS					1 987 470 040
	1.6 TDI	08.13→	66						1 987 470 040
			77						1 987 474 496 <sup>B</sup>
									1 987 470 040
			81						1 987 474 496 <sup>B</sup>
									1 987 470 040
									1 987 474 496 <sup>B</sup>

		S							
	SEAT Leon ST [5F8]								
1.6 TDI		11.14→	81	PR-Code 1KD	D53				1 987 470 040 1 987 474 496 <sup>8</sup>
1.6 TDI 4Drive		11.14→	81						1 987 470 040 1 987 474 496 <sup>8</sup>
1.6 TDI 4x4		02.14→	77	PR-Code 1KD	D53				1 987 470 040 1 987 474 496 <sup>8</sup>
				PR-Code 1KS					1 987 470 040
1.8 TSI		08.13→	132						1 987 470 040
1.8 TSI 4Drive		11.14→	132	PR-Code 1KD	D53				1 987 470 040 1 987 474 496 <sup>8</sup>
				PR-Code 1KS					1 987 470 040
2.0 TDI		08.13→	81/105	PR-Code 1KD	D53				1 987 470 040 1 987 474 496 <sup>8</sup>
			110	PR-Code 1KS					1 987 470 040
		06.14→	110	PR-Code 1KD	D53				1 987 470 040
2.0 TDI, TDI 4Drive		08.13→	135						1 987 470 040
2.0 TDI, TDI 4Drive, TDI 4WD		05.14→	110	PR-Code 1KD	D53				1 987 474 496 <sup>8</sup>
2.0 TDI 4Drive		05.14→	110	PR-Code 1KD	D53				1 987 470 040
2.0 TDI 4WD				PR-Code 1KS					1 987 470 040
2.0 TSI		08.13→	110						1 987 470 040
	1.2 TSI	08.13→	63/77/81	PR-Code OB2	Y85	1 987 482 456	↔ 1463		
	1.4 TGI	08.14→	81/90/92/103/110	PR-Code OB2	Y85	1 987 482 456	↔ 1463		
	1.4 TSI	08.13→	81/90/92/103/110	PR-Code OB2	Y85	1 987 482 456	↔ 1463		
	1.4 TSI ACT	05.14→	81/90/92/103/110	PR-Code OB2	Y85	1 987 482 456	↔ 1463		
	1.6 TDI	08.13→	66/77/81	PR-Code OB2	Y85	1 987 482 456	↔ 1463		
	1.6 TDI 4Drive	11.14→	66/77/81	PR-Code OB2	Y85	1 987 482 456	↔ 1463		
	1.6 TDI 4x4	02.14→	66/77/81	PR-Code OB2	Y85	1 987 482 456	↔ 1463		
	1.8 TSI	08.13→	132	PR-Code OB2	Y85	1 987 482 456	↔ 1463		
	1.8 TSI 4Drive	11.14→	132	PR-Code OB2	Y85	1 987 482 456	↔ 1463		
	2.0 TDI	08.13→	81/105/110/135	PR-Code OB2	Y85	1 987 482 456	↔ 1463		
	2.0 TDI 4Drive	05.14→	81/105/110/135	PR-Code OB2	Y85	1 987 482 456	↔ 1463		
	2.0 TDI 4WD	06.14→	81/105/110/135	PR-Code OB2	Y85	1 987 482 456	↔ 1463		
	2.0 TSI	08.13→	81/105/110/135	PR-Code OB2	Y85	1 987 482 456	↔ 1463		
	1.2 TSI	08.13→	63/77			0 986 594 526 <sup>4</sup>			
					LAB	0 986 594 500 <sup>3</sup>			
					RAB	0 986 594 501 <sup>3</sup>			
		05.14→	81		GBM	0 986 594 526 <sup>4</sup>			
					LAB	0 986 594 500 <sup>3</sup>			
					RAB	0 986 594 501 <sup>3</sup>			
	1.4 TGI	08.14→	81		LAB	0 986 594 500 <sup>3</sup>			
					RAB	0 986 594 501 <sup>3</sup>			
	1.4 TSI	08.13→	90			0 986 594 526 <sup>4</sup>			
					LAB	0 986 594 500 <sup>3</sup>			
					RAB	0 986 594 501 <sup>3</sup>			
			103			0 986 594 526 <sup>4</sup>			
					LAB	0 986 594 500 <sup>3</sup>			
					RAB	0 986 594 501 <sup>3</sup>			
		05.14→	92		GBM	0 986 594 526 <sup>4</sup>			
					LAB	0 986 594 500 <sup>3</sup>			
					RAB	0 986 594 501 <sup>3</sup>			

								
1.4 TSI ACT	05.14→	110				GBM	0 986 594 526 <sup>4</sup>	
						LAB	0 986 594 500 <sup>3</sup>	
						RAB	0 986 594 501 <sup>3</sup>	
1.6 TDI	08.13→	66					0 986 594 526 <sup>4</sup>	
						LAB	0 986 594 500 <sup>3</sup>	
						RAB	0 986 594 501 <sup>3</sup>	
							0 986 594 526 <sup>4</sup>	
						RAB	0 986 594 501 <sup>3</sup>	
		77					0 986 594 526 <sup>4</sup>	
		81					0 986 594 526 <sup>4</sup>	
	11.14→	81			GBM	0 986 594 526 <sup>4</sup>		
1.6 TDI	08.13→	81			LAB	0 986 594 500 <sup>3</sup>		
1.6 TDI 4Drive					RAB	0 986 594 501 <sup>3</sup>		
1.6 TDI, TDI 4x4	08.13→	77			LAB	0 986 594 500 <sup>3</sup>		
1.6 TDI 4Drive	11.14→	81				0 986 594 526 <sup>4</sup>		
1.6 TDI 4x4	02.14→	77				GBM,LAB	0 986 594 504 <sup>4</sup>	
						GBM,RAB	0 986 594 505 <sup>4</sup>	
						RAB	0 986 594 501 <sup>3</sup>	
1.8 TSI	08.13→	132					0 986 594 526 <sup>4</sup>	
						RAB	0 986 594 501 <sup>3</sup>	
1.8 TSI, TSI 4Drive	08.13→	132			LAB	0 986 594 500 <sup>3</sup>		
1.8 TSI 4Drive	11.14→	132				GBM,LAB	0 986 594 504 <sup>4</sup>	
						GBM,RAB	0 986 594 505 <sup>4</sup>	
						RAB	0 986 594 501 <sup>3</sup>	
2.0 TDI	08.13→	81/105					0 986 594 526 <sup>4</sup>	
						LAB	0 986 594 500 <sup>3</sup>	
						RAB	0 986 594 501 <sup>3</sup>	
		110					0 986 594 526 <sup>4</sup>	
	06.14→	110			GBM	0 986 594 526 <sup>4</sup>		
2.0 TDI	08.13→	135				0 986 594 526 <sup>4</sup>		
2.0 TDI 4Drive						LAB	0 986 594 500 <sup>3</sup>	
						RAB	0 986 594 501 <sup>3</sup>	
2.0 TDI, TDI 4Drive, TDI 4WD, TSI	08.13→	110				LAB	0 986 594 500 <sup>3</sup>	
						RAB	0 986 594 501 <sup>3</sup>	
2.0 TDI 4Drive	05.14→	110			GBM	0 986 594 526 <sup>4</sup>		
2.0 TDI 4WD	06.14→	110				GBM,LAB	0 986 594 504 <sup>4</sup>	
						GBM,RAB	0 986 594 505 <sup>4</sup>	
2.0 TSI	08.13→	110				0 986 594 526 <sup>4</sup>		
<b>Leon [1M1]</b>								
								
	1.4	12.99-04.04	55	PR-Code 1LQ, PR-Code 1LS	228,252	0 986 473 071	 ← 54	1 987 470 506 <sup>B</sup>
						0 986 474 071	 → 54	1 987 470 506 <sup>B</sup>
1.6	10.98-06.06	74/75/77		PR-Code 1LQ, PR-Code 1LS	228,252	0 986 473 071	 ← 54	1 987 470 506 <sup>B</sup>
						0 986 474 071	 → 54	1 987 470 506 <sup>B</sup>
1.8	10.98-07.04	92		PR-Code 1LE	288	0 986 471 923	 ← 54	1 987 470 506 <sup>B</sup>
						0 986 473 923	 → 54	1 987 470 506 <sup>B</sup>
						0 986 471 924	 → 54	1 987 470 506 <sup>B</sup>
						0 986 473 924	 → 54	1 987 470 506 <sup>B</sup>
				PR-Code 1LQ, PR-Code 1LS	228,252	0 986 473 071	 ← 54	1 987 470 506 <sup>B</sup>
						0 986 474 071	 → 54	1 987 470 506 <sup>B</sup>
1.8 T	12.99-10.00	132		Fg.-Nr. →1M..1B044 183, PR-Code 1LJ, Fg.-Nr. → 1M..1R049 650, PR-Code 1LT	312	0 986 473 923	 ← 54	1 987 470 506 <sup>B</sup>
						0 986 473 924	 → 54	1 987 470 506 <sup>B</sup>
	12.99-04.04	132		PR-Code 1LE	288	0 986 471 923	 ← 54	1 987 470 506 <sup>B</sup>
						0 986 473 923	 → 54	1 987 470 506 <sup>B</sup>
						0 986 471 924	 → 54	1 987 470 506 <sup>B</sup>
						0 986 473 924	 → 54	1 987 470 506 <sup>B</sup>
	11.00-12.00	132		Fg.-Nr. 1M..1B044 183→, PR-Code 1LJ, Fg.-Nr. 1M..1R049 651→, PR-Code 1LT	312	0 986 473 923	 ← 54	1 987 470 506 <sup>B</sup>
						0 986 473 924	 → 54	1 987 470 506 <sup>B</sup>































		S							
SEAT Leon [1M1]									
<b>1.8 T</b>	11.00-11.01	132	Fg.-Nr. 1M..1B044 183→ 1M..2..060 744, PR-Code 1LJ, Fg.-Nr. 1M..1R049 651→, PR-Code 1LT	312	0986 473 923	← 54	1987 470 506 <sup>8</sup>		
					0986 473 924	→ 54	1987 470 506 <sup>8</sup>		
	12.01-04.04	132	Fg.-Nr. 1M..2..060 745→, PR-Code 1LJ, PR-Code 1LT	312	0986 473 923	← 54	1987 470 506 <sup>8</sup>		
					0986 473 924	→ 54	1987 470 506 <sup>8</sup>		
<b>1.8 T Syncro</b>	03.00-10.00	132	Fg.-Nr. →1M..1B044 183, →1M..1R049 650	312	0986 473 923	← 54	1987 470 506 <sup>8</sup>		
					0986 473 924	→ 54	1987 470 506 <sup>8</sup>		
	03.00-04.04	132		288	0986 471 923	← 54	1987 470 506 <sup>8</sup>		
					0986 473 923				
					0986 471 924	→ 54	1987 470 506 <sup>8</sup>		
					0986 473 924				
	11.00-01.01	132	Fg.-Nr. 1M..1B044 183→, 1M..1R049 651→	312	0986 473 923	← 54	1987 470 506 <sup>8</sup>		
					0986 473 924	→ 54	1987 470 506 <sup>8</sup>		
	11.00-11.01	132	Fg.-Nr. 1M..1B044 183→ 1M..2..060 744, 1M..1R049 651→	312	0986 473 923	← 54	1987 470 506 <sup>8</sup>		
					0986 473 924	→ 54	1987 470 506 <sup>8</sup>		
	12.01-04.04	132	Fg.-Nr. 1M..2..060 745→	312	0986 473 923	← 54	1987 470 506 <sup>8</sup>		
					0986 473 924	→ 54	1987 470 506 <sup>8</sup>		
<b>1.9 SDI</b>	10.98-06.06	50/66/74/81	PR-Code 1LQ, PR-Code 1LS	228,252	0986 473 071	← 54	1987 470 506 <sup>8</sup>		
<b>1.9 TDI</b>					0986 474 071	→ 54	1987 470 506 <sup>8</sup>		
<b>1.9 TDI</b>	09.00-12.05	110	PR-Code 1LE	288	0986 471 923	← 54	1987 470 506 <sup>8</sup>		
					0986 473 923				
					0986 471 924	→ 54	1987 470 506 <sup>8</sup>		
					0986 473 924				
	05.03-06.06	96	PR-Code 1LQ, PR-Code 1LS	228,252	0986 473 071	← 54	1987 470 506 <sup>8</sup>		
					0986 474 071	→ 54	1987 470 506 <sup>8</sup>		
	05.03-06.06	96	PR-Code 1LE	288	0986 471 923	← 54	1987 470 506 <sup>8</sup>		
					0986 473 923				
					0986 471 924	→ 54	1987 470 506 <sup>8</sup>		
					0986 473 924				
			PR-Code 1LJ, PR-Code 1LT	312	0986 473 923	← 54	1987 470 506 <sup>8</sup>		
					0986 473 924	→ 54	1987 470 506 <sup>8</sup>		
<b>1.9 TDI Syncro</b>	09.00-10.00	110	Fg.-Nr. →1M..1B044 183, → 1M..1R049 650	312	0986 473 923	← 54	1987 470 506 <sup>8</sup>		
					0986 473 924	→ 54	1987 470 506 <sup>8</sup>		
	09.00-07.04	110		288	0986 471 923	← 54	1987 470 506 <sup>8</sup>		
					0986 473 923				
					0986 471 924	→ 54	1987 470 506 <sup>8</sup>		
					0986 473 924				
	11.00-11.01	110	Fg.-Nr. 1M..1B044 183→ 1M..2..060 744, 1M..1R049 651→	312	0986 473 923	← 54	1987 470 506 <sup>8</sup>		
					0986 473 924	→ 54	1987 470 506 <sup>8</sup>		
	12.01-07.04	110	Fg.-Nr. 1M..2..060 745→	312	0986 473 923	← 54	1987 470 506 <sup>8</sup>		
					0986 473 924	→ 54	1987 470 506 <sup>8</sup>		
<b>2.8</b>	10.00-10.00	150	Fg.-Nr. →1M..1B044 183, PR-Code 1LJ, Fg.-Nr. →1M..1R049 650, PR-Code 1LT	312	0986 473 923	← 54	1987 470 506 <sup>8</sup>		
					0986 473 924	→ 54	1987 470 506 <sup>8</sup>		
	10.00-07.01	150	PR-Code 1LE	288	0986 471 923	← 54	1987 470 506 <sup>8</sup>		
					0986 473 923				
					0986 471 924	→ 54	1987 470 506 <sup>8</sup>		
					0986 473 924				
	11.00-07.01	150	Fg.-Nr. 1M..1B044 183→, PR-Code 1LJ, Fg.-Nr. 1M..1R049 651→, PR-Code 1LT	312	0986 473 923	← 54	1987 470 506 <sup>8</sup>		
					0986 473 924	→ 54	1987 470 506 <sup>8</sup>		
	05.02-04.04	150	PR-Code 1LE	288	0986 471 923	← 54	1987 470 506 <sup>8</sup>		
					0986 473 923				
					0986 471 924	→ 54	1987 470 506 <sup>8</sup>		
					0986 473 924				
			PR-Code 1LJ, PR-Code 1LT	312	0986 473 923	← 54	1987 470 506 <sup>8</sup>		
					0986 473 924	→ 54	1987 470 506 <sup>8</sup>		



		S								
										
	<b>1.4</b>	12.99-05.02	55	PR-Code 1KK	B38	0 986 474 099	 → 38,1	1 987 474 496 <sup>B</sup>		
		12.99-04.04	55	PR-Code 1KK	B38	0 986 473 099	 ← 38,1	1 987 470 040		
							0 986 473 099	 ← 38,1	1 987 474 496 <sup>B</sup>	
							0 986 474 099	 → 38,1	1 987 470 040	
				PR-Code 1KP	B41	0 986 473 029	 ← 41	1 987 474 496 <sup>B</sup>		
						0 986 474 029	 → 41	1 987 474 496 <sup>B</sup>		
<b>1.6</b>	10.98-05.99	74	Fg.-Nr. →1M..Y..006 500, PR-Code 1KK	B38	0 986 473 072	 ← 38	1 987 470 040			
					0 986 473 072	 ← 38	1 987 474 496 <sup>B</sup>			
					0 986 474 072	 → 38	1 987 470 040			
					0 986 473 106	 ← 41	1 987 474 496 <sup>B</sup>			
				Fg.-Nr. →1M..Y..006 500, PR-Code 1KP	B41	0 986 473 106	 ← 41	1 987 474 496 <sup>B</sup>		
						0 986 474 106	 → 41	1 987 474 496 <sup>B</sup>		
	06.99-07.04	74	Fg.-Nr. 1M..Y..006 501→, PR-Code 1KK	B38	0 986 473 099	 ← 38,1	1 987 470 040			
					0 986 473 099	 ← 38,1	1 987 474 496 <sup>B</sup>			
					0 986 474 099	 → 38,1	1 987 470 040			
					0 986 473 029	 ← 41	1 987 474 496 <sup>B</sup>			
				Fg.-Nr. 1M..Y..006 501→, PR-Code 1KP	B41	0 986 473 029	 ← 41	1 987 474 496 <sup>B</sup>		
						0 986 474 029	 → 41	1 987 474 496 <sup>B</sup>		
	06.00-04.01	77	PR-Code 1KK	B38	0 986 474 099	 → 38,1	1 987 474 496 <sup>B</sup>			
	06.00-06.06	77	PR-Code 1KK	B38	0 986 473 099	 ← 38,1	1 987 470 040			
					0 986 474 099	 → 38,1	1 987 470 040			
					0 986 473 029	 ← 41	1 987 474 496 <sup>B</sup>			
0 986 474 029					 → 41	1 987 474 496 <sup>B</sup>				
09.00-06.06	77	PR-Code 1KK	B38	0 986 473 099	 ← 38,1	1 987 474 496 <sup>B</sup>				
10.05-06.06	75	PR-Code 1KK	B38	0 986 473 099	 ← 38,1	1 987 470 040				
				0 986 473 099	 ← 38,1	1 987 474 496 <sup>B</sup>				
				0 986 474 099	 → 38,1	1 987 470 040				
				0 986 473 029	 ← 41	1 987 474 496 <sup>B</sup>				
			PR-Code 1KP	B41	0 986 473 029	 ← 41	1 987 474 496 <sup>B</sup>			
					0 986 474 029	 → 41	1 987 474 496 <sup>B</sup>			
<b>1.8</b>	10.98-05.99	92	Fg.-Nr. →1M..Y..006 500, PR-Code 1KK	232,B38	0 986 473 072	 ← 38	1 987 470 040			
					0 986 473 072	 ← 38	1 987 474 496 <sup>B</sup>			
					0 986 474 072	 → 38	1 987 470 040			
					0 986 473 106	 ← 41	1 987 474 496 <sup>B</sup>			
				Fg.-Nr. →1M..Y..006 500, PR-Code 1KP	232,B41	0 986 473 106	 ← 41	1 987 474 496 <sup>B</sup>		
						0 986 474 106	 → 41	1 987 474 496 <sup>B</sup>		
	10.98-07.04	92	PR-Code 1KY	252	0 986 473 139	 ← 38,1	1 987 470 040			
					0 986 473 139	 ← 38,1	1 987 474 496 <sup>B</sup>			
					0 986 474 139	 → 38,1	1 987 470 040			
	06.99-12.03	92	Fg.-Nr. 1M..Y..006 501→, PR-Code 1KK	232,B38	0 986 473 099	 ← 38,1	1 987 470 040			
					0 986 473 099	 ← 38,1	1 987 474 496 <sup>B</sup>			
					0 986 474 099	 → 38,1	1 987 470 040			
0 986 473 029					 ← 41	1 987 474 496 <sup>B</sup>				
			Fg.-Nr. 1M..Y..006 501→, PR-Code 1KP	232,B41	0 986 474 029	 → 41	1 987 474 496 <sup>B</sup>			
					0 986 474 029	 → 41	1 987 474 496 <sup>B</sup>			
12.99-07.04	92	PR-Code 1KK	232,B38	0 986 473 099	 ← 38,1	1 987 470 040				
				0 986 473 099	 ← 38,1	1 987 474 496 <sup>B</sup>				
				0 986 474 099	 → 38,1	1 987 470 040				
				0 986 473 029	 ← 41	1 987 474 496 <sup>B</sup>				
			PR-Code 1KP	232,B41	0 986 473 029	 ← 41	1 987 474 496 <sup>B</sup>			
					0 986 474 029	 → 41	1 987 474 496 <sup>B</sup>			
<b>1.8T</b>	12.99-04.04	132	PR-Code 1KP	232	0 986 473 029	 ← 41	1 987 474 496 <sup>B</sup>			
					0 986 474 029	 → 41	1 987 474 496 <sup>B</sup>			
					0 986 473 139	 ← 38,1	1 987 470 040			
					0 986 473 139	 ← 38,1	1 987 474 496 <sup>B</sup>			
			PR-Code 1KY	252	0 986 474 139	 → 38,1	1 987 470 040			
					0 986 473 139	 ← 38,1	1 987 474 496 <sup>B</sup>			
					0 986 474 139	 → 38,1	1 987 470 040			
					0 986 473 139	 ← 38,1	1 987 470 040			
					0 986 473 139	 ← 38,1	1 987 474 496 <sup>B</sup>			
					0 986 474 139	 → 38,1	1 987 470 040			
<b>1.8T Syncro</b>	03.00-01.01	132			0 986 474 139	 → 38,1	1 987 474 496 <sup>B</sup>			
					0 986 473 139	 ← 38,1	1 987 470 040			
					0 986 474 139	 → 38,1	1 987 470 040			
	09.00-04.04	132			0 986 473 139	 ← 38,1	1 987 474 496 <sup>B</sup>			
<b>1.9 SDI</b>	12.99-10.03	50	PR-Code 1KK	B38	0 986 473 099	 ← 38,1	1 987 470 040			
					0 986 473 099	 ← 38,1	1 987 474 496 <sup>B</sup>			
					0 986 474 099	 → 38,1	1 987 470 040			

		S							
	SEAT Leon [1M1]								
1.9 SDI	12.99-10.03	50	PR-Code 1KP	B41	0986 473 029		← 41	1987 474 496 <sup>8</sup>	
					0986 474 029		→ 41	1987 474 496 <sup>8</sup>	
1.9 TDI	10.98-05.99	81	Fg.-Nr. →1M..Y..006 500, PR-Code 1KK	232,B38	0986 473 072		← 38	1987 470 040	
					0986 473 072		← 38	1987 474 496 <sup>8</sup>	
					0986 474 072		→ 38	1987 470 040	
			Fg.-Nr. →1M..Y..006 500, PR-Code 1KP	232,B41	0986 473 106		← 41	1987 474 496 <sup>8</sup>	
					0986 474 106		→ 41	1987 474 496 <sup>8</sup>	
	10.98-10.05	81	PR-Code 1KY	252	0986 473 139		← 38,1	1987 470 040	
					0986 473 139		← 38,1	1987 474 496 <sup>8</sup>	
					0986 474 139		→ 38,1	1987 470 040	
	03.99-05.99	66	Fg.-Nr. →1M..Y..006 500, PR-Code 1KK	232,B38	0986 473 072		← 38	1987 470 040	
					0986 473 072		← 38	1987 474 496 <sup>8</sup>	
					0986 474 072		→ 38	1987 470 040	
			Fg.-Nr. →1M..Y..006 500, PR-Code 1KP	232,B41	0986 473 106		← 41	1987 474 496 <sup>8</sup>	
					0986 474 106		→ 41	1987 474 496 <sup>8</sup>	
	03.99-07.04	66	PR-Code 1KY	252	0986 473 139		← 38,1	1987 470 040	
					0986 473 139		← 38,1	1987 474 496 <sup>8</sup>	
					0986 474 139		→ 38,1	1987 470 040	
	06.99-09.02	81	Fg.-Nr. 1M..Y..006 501→, PR-Code 1KK	232,B38	0986 473 099		← 38,1	1987 470 040	
					0986 473 099		← 38,1	1987 474 496 <sup>8</sup>	
					0986 474 099		→ 38,1	1987 470 040	
			Fg.-Nr. 1M..Y..006 501→, PR-Code 1KP	232,B41	0986 473 029		← 41	1987 474 496 <sup>8</sup>	
					0986 474 029		→ 41	1987 474 496 <sup>8</sup>	
	06.99-07.04	66	Fg.-Nr. 1M..Y..006 501→, PR-Code 1KK	232,B38	0986 473 099		← 38,1	1987 470 040	
					0986 473 099		← 38,1	1987 474 496 <sup>8</sup>	
					0986 474 099		→ 38,1	1987 470 040	
			Fg.-Nr. 1M..Y..006 501→, PR-Code 1KP	232,B41	0986 473 029		← 41	1987 474 496 <sup>8</sup>	
					0986 474 029		→ 41	1987 474 496 <sup>8</sup>	
	10.99-10.05	81	PR-Code 1KK	232,B38	0986 473 099		← 38,1	1987 470 040	
					0986 473 099		← 38,1	1987 474 496 <sup>8</sup>	
					0986 474 099		→ 38,1	1987 470 040	
			PR-Code 1KP	232,B41	0986 473 029		← 41	1987 474 496 <sup>8</sup>	
					0986 474 029		→ 41	1987 474 496 <sup>8</sup>	
	12.99-09.02	66	PR-Code 1KK	B38	0986 473 099		← 38,1	1987 470 040	
					0986 473 099		← 38,1	1987 474 496 <sup>8</sup>	
					0986 474 099		→ 38,1	1987 470 040	
			PR-Code 1KP	B41	0986 473 029		← 41	1987 474 496 <sup>8</sup>	
					0986 474 029		→ 41	1987 474 496 <sup>8</sup>	
	09.00-12.05	110		INB	0986 473 139		← 38,1	1987 470 040	
					0986 473 139		← 38,1	1987 474 496 <sup>8</sup>	
					0986 474 139		→ 38,1	1987 470 040	
				INB	0986 473 099		← 38,1	1987 470 040	
					0986 473 099		← 38,1	1987 474 496 <sup>8</sup>	
					0986 474 099		→ 38,1	1987 470 040	
	05.03-06.06	96	PR-Code 1KK	232,B38	0986 473 099		← 38,1	1987 470 040	
					0986 473 099		← 38,1	1987 474 496 <sup>8</sup>	
					0986 474 099		→ 38,1	1987 470 040	
			PR-Code 1KP	232,B41	0986 473 029		← 41	1987 474 496 <sup>8</sup>	
					0986 474 029		→ 41	1987 474 496 <sup>8</sup>	
			PR-Code 1KY	252	0986 473 139		← 38,1	1987 470 040	
					0986 473 139		← 38,1	1987 474 496 <sup>8</sup>	
					0986 474 139		→ 38,1	1987 470 040	
	10.05-06.06	74	PR-Code 1KK	B38	0986 473 099		← 38,1	1987 470 040	
					0986 473 099		← 38,1	1987 474 496 <sup>8</sup>	
					0986 474 099		→ 38,1	1987 470 040	
			PR-Code 1KP	B41	0986 473 029		← 41	1987 474 496 <sup>8</sup>	
					0986 474 029		→ 41	1987 474 496 <sup>8</sup>	
1.9 TDI Syncro	09.00-07.04	110		252,BSR	0986 473 139		← 38,1	1987 470 040	
					0986 473 139		← 38,1	1987 474 496 <sup>8</sup>	
					0986 474 139		→ 38,1	1987 470 040	
				252,BSR	0986 473 147		← 38	1987 470 040	
					0986 473 147		← 38	1987 474 496 <sup>8</sup>	
					0986 474 147		→ 38	1987 470 040	





































































		S							
2.8		10.00-07.01	150				0 986 473 139	 ← 38,1	1 987 470 040
							0 986 473 139	 ← 38,1	1 987 474 496 <sup>B</sup>
							0 986 474 139	 → 38,1	1 987 470 040
		05.02-04.04	150				0 986 473 139	 ← 38,1	1 987 470 040
							0 986 473 139	 ← 38,1	1 987 474 496 <sup>B</sup>
							0 986 474 139	 → 38,1	1 987 470 040
									
	1.4	12.99-04.04	55				1 987 477 698	↔ 1693	
	1.6	10.98-06.06	74/75/77				1 987 477 698	↔ 1693	
	1.8	10.98-07.04	92/132				1 987 477 698	↔ 1693	
	1.8 T	12.99-04.04	92/132				1 987 477 698	↔ 1693	
	1.9 SDI	12.99-10.03	50/66/74/81/96/110				1 987 477 698	↔ 1693	
	1.9 TDI	10.98-06.06	50/66/74/81/96/110				1 987 477 698	↔ 1693	
	2.8	10.00-07.01	150				1 987 477 698	↔ 1693	
		05.02-04.04	150				1 987 477 698	↔ 1693	
	1.4	12.99-04.04	55				0 986 594 004 <sup>4</sup>		
						LAB	0 986 594 001 <sup>3</sup>		
						RAB	0 986 594 000 <sup>3</sup>		
	1.6	10.98-06.06	74/75/77				0 986 594 004 <sup>4</sup>		
						LAB	0 986 594 001 <sup>3</sup>		
						RAB	0 986 594 000 <sup>3</sup>		
	1.8	10.98-07.04	92				0 986 594 004 <sup>4</sup>		
						LAB	0 986 594 001 <sup>3</sup>		
						RAB	0 986 594 000 <sup>3</sup>		
	1.8 T	12.99-04.04	132				0 986 594 004 <sup>4</sup>		
	1.8 T Syncro	03.00-04.04	132				0 986 594 008 <sup>4</sup>		
	1.8 T	12.99-04.04	132			LAB	0 986 594 001 <sup>3</sup>		
	1.8 T Syncro					RAB	0 986 594 000 <sup>3</sup>		
	1.9 SDI	10.98-06.06	50/66/74/				0 986 594 004 <sup>4</sup>		
	1.9 TDI		81/96			LAB	0 986 594 001 <sup>3</sup>		
						RAB	0 986 594 000 <sup>3</sup>		
	1.9 TDI	09.00-12.05	110				0 986 594 004 <sup>4</sup>		
	1.9 TDI Syncro	09.00-07.04	110				0 986 594 008 <sup>4</sup>		
	1.9 TDI	09.00-12.05	110			LAB	0 986 594 001 <sup>3</sup>		
	1.9 TDI Syncro					RAB	0 986 594 000 <sup>3</sup>		
	2.8	10.00-07.01	150				0 986 594 004 <sup>4</sup>		
						LAB	0 986 594 001 <sup>3</sup>		
						RAB	0 986 594 000 <sup>3</sup>		
		05.02-04.04	150				0 986 594 004 <sup>4</sup>		
						LAB	0 986 594 001 <sup>3</sup>		
						RAB	0 986 594 000 <sup>3</sup>		
<b>Leon [1P1]</b>									
									
	1.2 TSI	02.10-12.12	77				0 986 473 071	 ← 54	1 987 470 506 <sup>B</sup>
							0 986 474 071	 → 54	1 987 470 506 <sup>B</sup>
	1.4	06.06-12.12	63				0 986 473 071	 ← 54	1 987 470 506 <sup>B</sup>
							0 986 474 071	 → 54	1 987 470 506 <sup>B</sup>
	1.4 TSI	11.07-12.12	92				0 986 473 384	 ← 53,94	F 026 A06 106 <sup>7</sup>
							0 986 473 384	 ← 53,94	1 987 470 506 <sup>B</sup>
							0 986 474 384	 → 53,94	F 026 A06 106 <sup>7</sup>
	1.6	07.05-12.12	66/75/77				0 986 473 071	 ← 54	1 987 470 506 <sup>B</sup>
	1.6 MultiFuel						0 986 474 071	 → 54	1 987 470 506 <sup>B</sup>
	1.6 TDI								
	1.8 TSI	06.07-03.09	118	PR-Code 1LU			0 986 134 257	 ←	F 026 A03 545 <sup>7</sup>
							0 986 134 257	 ←	1 987 470 506 <sup>B</sup>
							0 986 135 257	 →	F 026 A03 545 <sup>7</sup>













		S							
SEAT Leon [1P1]									
1.8 TSI	06.07-03.09	118	PR-Code 1ZE, PR-Code 1LJ	288,312	0986 473 384		53,94	F 026 A06 106 <sup>7</sup>	
					0986 473 384		53,94	1987 470 506 <sup>8</sup>	
					0986 474 384		53,94	F 026 A06 106 <sup>7</sup>	
	PR-Code 1ZF, PR-Code 1ZM	228	0986 473 071		54	1987 470 506 <sup>8</sup>			
			0986 474 071		54	1987 470 506 <sup>8</sup>			
			0986 473 384		53,94	F 026 A06 106 <sup>7</sup>			
	03.09-12.12	118	0986 473 384		53,94	1987 470 506 <sup>8</sup>			
			0986 474 384		53,94	F 026 A06 106 <sup>7</sup>			
			0986 473 384		53,94	F 026 A06 106 <sup>7</sup>			
1.9 TDI	07.05-02.06	77	PR-Code 1LU	0986 134 257			F 026 A03 545 <sup>7</sup>		
				0986 134 257			1987 470 506 <sup>8</sup>		
				0986 135 257			F 026 A03 545 <sup>7</sup>		
	PR-Code 1ZE, PR-Code 1LJ	288,312	0986 473 384		53,94	F 026 A06 106 <sup>7</sup>			
			0986 473 384		53,94	1987 470 506 <sup>8</sup>			
			0986 474 384		53,94	F 026 A06 106 <sup>7</sup>			
	PR-Code 1ZF, PR-Code 1ZM	228	0986 473 071		54	1987 470 506 <sup>8</sup>			
			0986 474 071		54	1987 470 506 <sup>8</sup>			
			0986 473 071		54	1987 470 506 <sup>8</sup>			
	11.05-12.10	77	0986 474 071		54	1987 470 506 <sup>8</sup>			
			0986 473 071		54	1987 470 506 <sup>8</sup>			
	06.07-12.10	66	0986 473 071		54	1987 470 506 <sup>8</sup>			
			0986 474 071		54	1987 470 506 <sup>8</sup>			
	2.0 FSI	07.05-03.09	110	PR-Code 1LU	0986 134 257			F 026 A03 545 <sup>7</sup>	
					0986 134 257			1987 470 506 <sup>8</sup>	
0986 135 257							F 026 A03 545 <sup>7</sup>		
PR-Code 1ZE, PR-Code 1LJ		288,312	0986 473 384		53,94	F 026 A06 106 <sup>7</sup>			
			0986 473 384		53,94	1987 470 506 <sup>8</sup>			
			0986 474 384		53,94	F 026 A06 106 <sup>7</sup>			
PR-Code 1ZF, PR-Code 1ZM		228	0986 473 071		54	1987 470 506 <sup>8</sup>			
			0986 474 071		54	1987 470 506 <sup>8</sup>			
						F 026 A03 545 <sup>7</sup>			
05.09-09.09		177				1987 470 506 <sup>8</sup>			
			0986 134 287			F 026 A03 545 <sup>7</sup>			
10.09-12.12		177	0986 134 287			1987 470 506 <sup>8</sup>			
			0986 135 287			F 026 A03 545 <sup>7</sup>			
			0986 134 257			F 026 A03 545 <sup>7</sup>			
2.0 TDI		07.05-03.09	100	PR-Code 1LU	0986 134 257			F 026 A03 545 <sup>7</sup>	
	0986 134 257						1987 470 506 <sup>8</sup>		
	0986 135 257						F 026 A03 545 <sup>7</sup>		
	PR-Code 1ZE, PR-Code 1LJ	288,312	0986 473 384		53,94	F 026 A06 106 <sup>7</sup>			
			0986 473 384		53,94	1987 470 506 <sup>8</sup>			
			0986 474 384		53,94	F 026 A06 106 <sup>7</sup>			
	PR-Code 1ZF, PR-Code 1ZM	228	0986 473 071		54	1987 470 506 <sup>8</sup>			
			0986 474 071		54	1987 470 506 <sup>8</sup>			
			0986 473 384		53,94	F 026 A06 106 <sup>7</sup>			
	07.05-12.12	103	0986 473 384		53,94	1987 470 506 <sup>8</sup>			
			0986 473 384		53,94	F 026 A06 106 <sup>7</sup>			
			0986 474 384		53,94	F 026 A06 106 <sup>7</sup>			
	05.06-03.09	125	PR-Code 1LU	0986 134 257			F 026 A03 545 <sup>7</sup>		
				0986 134 257			1987 470 506 <sup>8</sup>		
				0986 135 257			F 026 A03 545 <sup>7</sup>		
PR-Code 1ZE, PR-Code 1LJ	288,312	0986 473 384		53,94	F 026 A06 106 <sup>7</sup>				
		0986 473 384		53,94	1987 470 506 <sup>8</sup>				
		0986 474 384		53,94	F 026 A06 106 <sup>7</sup>				
PR-Code 1ZF, PR-Code 1ZM	228	0986 473 071		54	1987 470 506 <sup>8</sup>				
		0986 474 071		54	1987 470 506 <sup>8</sup>				
		0986 473 384		53,94	F 026 A06 106 <sup>7</sup>				
03.09-12.12	125	PR-Code 1ZA	TW	0986 473 384		53,94	F 026 A06 106 <sup>7</sup>		
			0986 473 384		53,94	1987 470 506 <sup>8</sup>			
			0986 474 384		53,94	F 026 A06 106 <sup>7</sup>			
PR-Code 1ZB	TW	0986 473 384		53,94	F 026 A06 106 <sup>7</sup>				
		0986 473 384		53,94	1987 470 506 <sup>8</sup>				
		0986 474 384		53,94	F 026 A06 106 <sup>7</sup>				
2.0 TFSI	05.05-03.09	136-147	PR-Code 1LU	0986 134 257			F 026 A03 545 <sup>7</sup>		
				0986 134 257			1987 470 506 <sup>8</sup>		
				0986 135 257			F 026 A03 545 <sup>7</sup>		



	<b>S</b>								
<b>2.0 TFSI</b>	05.05-03.09	136-147	PR-Code 1ZE, PR-Code 1LJ	288,312	0 986 473 384		53,94	F 026 A06 106 <sup>7</sup>	
					0 986 473 384		53,94	1 987 470 506 <sup>8</sup>	
					0 986 474 384		53,94	F 026 A06 106 <sup>7</sup>	
				PR-Code 1ZF, PR-Code 1ZM	228	0 986 473 071		54	1 987 470 506 <sup>8</sup>
						0 986 474 071		54	1 987 470 506 <sup>8</sup>
	11.06-05.09	177	PR-Code 1LU	0 986 134 257				F 026 A03 545 <sup>7</sup>	
				0 986 134 257			1 987 470 506 <sup>8</sup>		
				0 986 135 257			F 026 A03 545 <sup>7</sup>		
				PR-Code 1ZE, PR-Code 1LJ	288,312	0 986 473 384		53,94	F 026 A06 106 <sup>7</sup>
						0 986 473 384		53,94	1 987 470 506 <sup>8</sup>
						0 986 474 384		53,94	F 026 A06 106 <sup>7</sup>
	06.09-12.12	155	PR-Code 1ZA	TW	0 986 473 384		53,94	F 026 A06 106 <sup>7</sup>	
					0 986 473 384		53,94	1 987 470 506 <sup>8</sup>	
					0 986 474 384		53,94	F 026 A06 106 <sup>7</sup>	
				PR-Code 1ZB	TW	0 986 473 384		53,94	F 026 A06 106 <sup>7</sup>
					0 986 473 384		53,94	1 987 470 506 <sup>8</sup>	
					0 986 474 384		53,94	F 026 A06 106 <sup>7</sup>	
		<b>1.2 TSI</b>	02.10-12.12	77	0 986 473 381		38,1	1 987 470 040	
					0 986 473 381		38,1	1 987 474 496 <sup>8</sup>	
					0 986 474 381		38,1	1 987 470 040	
	<b>1.4</b>	06.06-12.12	63/92	<b>1.4 TSI</b>	0 986 473 381		38,1	1 987 470 040	
					0 986 473 381		38,1	1 987 474 496 <sup>8</sup>	
					0 986 474 381		38,1	1 987 470 040	
	<b>1.6</b>	07.05-12.12	75	<b>1.6 MultiFuel</b>	0 986 474 381		38,1	1 987 474 496 <sup>8</sup>	
					0 986 473 381		38,1	1 987 470 040	
	<b>1.6 MultiFuel</b>	07.05-12.12	75	<b>1.6 MultiFuel</b>	0 986 473 381		38,1	1 987 474 496 <sup>8</sup>	
					0 986 474 381		38,1	1 987 470 040	
	<b>1.6 MultiFuel</b>	12.07-06.08	75	Fg.-Nr. →2P..9..001 800, PR-Code 1KZ	0 986 134 048		38	1 987 474 496 <sup>8</sup>	
					0 986 135 048		38	1 987 474 496 <sup>8</sup>	
		02.10-12.12	77	0 986 473 381		38,1	1 987 470 040		
				0 986 473 381		38,1	1 987 474 496 <sup>8</sup>		
				0 986 474 381		38,1	1 987 470 040		
0 986 473 381					38,1	1 987 474 496 <sup>8</sup>			
<b>1.6 TDI</b>	11.10-12.12	66	0 986 473 381		38,1	1 987 470 040			
			0 986 473 381		38,1	1 987 474 496 <sup>8</sup>			
	06.07-10.07	118	Fg.-Nr. →1P..8..058 000, PR-Code 1KZ	0 986 134 048		38			
				0 986 135 048		38			
	06.07-03.09	118	PR-Code 1KY	0 986 474 381		38,1	1 987 474 496 <sup>8</sup>		
				0 986 134 244			1 987 474 496 <sup>8</sup>		
	06.07-12.12	118	0 986 135 244			1 987 474 496 <sup>8</sup>			
			0 986 473 381		38,1	1 987 470 040			
	11.07-06.08	118	Fg.-Nr. 1P..8..058 001→2P..9..001 800, PR-Code 1KZ	0 986 474 381		38,1	1 987 470 040		
				0 986 134 048		38	1 987 474 496 <sup>8</sup>		
	07.08-03.09	118	Fg.-Nr. 1P..9..001 801→, PR-Code 1KZ	0 986 135 048		38	1 987 474 496 <sup>8</sup>		
				0 986 134 048		38			
03.09-12.12	118		0 986 135 048		38				
<b>1.9 TDI</b>	07.05-02.06	77	PR-Code 1KY	0 986 473 381		38,1	1 987 474 496 <sup>8</sup>		
				0 986 134 244			1 987 474 496 <sup>8</sup>		
			PR-Code 1KZ	0 986 135 244			1 987 474 496 <sup>8</sup>		
				0 986 134 048		38			
				0 986 135 048		38			
	07.05-12.10	77	0 986 473 381		38,1	1 987 470 040			
0 986 473 381				38,1	1 987 474 496 <sup>8</sup>				
0 986 474 381				38,1	1 987 470 040				
0 986 473 381				38,1	1 987 470 040				
0 986 473 381				38,1	1 987 474 496 <sup>8</sup>				
0 986 474 381				38,1	1 987 470 040				

		S								
	SEAT Leon [1P1]									
2.0 FSI	07.05-11.05	110	PR-Code 1KZ	0986 134 048		38				
				0986 135 048		38				
	07.05-03.09	110		0986 473 381		38,1	1987 470 040			
				0986 473 381		38,1	1987 474 496 <sup>8</sup>			
				0986 474 381		38,1	1987 470 040			
			PR-Code 1KY	0986 134 244			1987 474 496 <sup>8</sup>			
				0986 135 244			1987 474 496 <sup>8</sup>			
	11.05-10.07	110	Fg.-Nr. →1P..8..058 000, PR-Code 1KZ	0986 134 048		38				
				0986 135 048		38				
	11.07-06.08	110	Fg.-Nr. 1P..8..058 001→2P..9..001 800, PR-Code 1KZ	0986 134 048		38	1987 474 496 <sup>8</sup>			
				0986 135 048		38	1987 474 496 <sup>8</sup>			
	07.08-03.09	110	Fg.-Nr. 1P..9..001 801→, PR-Code 1KZ	0986 134 048		38				
				0986 135 048		38				
	05.09-12.12	177		0986 134 048		38				
				0986 135 048		38				
2.0 TDI	07.05-10.07	100	Fg.-Nr. →1P..8..058 000, PR-Code 1KZ	0986 134 048		38				
				0986 135 048		38				
	07.05-03.09	100		0986 473 381		38,1	1987 470 040			
				0986 473 381		38,1	1987 474 496 <sup>8</sup>			
				0986 474 381		38,1	1987 470 040			
			PR-Code 1KY	0986 134 244			1987 474 496 <sup>8</sup>			
				0986 135 244			1987 474 496 <sup>8</sup>			
	07.05-12.12	103		0986 473 381		38,1	1987 470 040			
				0986 473 381		38,1	1987 474 496 <sup>8</sup>			
				0986 474 381		38,1	1987 470 040			
	11.07-06.08	100	Fg.-Nr. 1P..8..058 001→2P..9..001 800, PR-Code 1KZ	0986 134 048		38	1987 474 496 <sup>8</sup>			
				0986 135 048		38	1987 474 496 <sup>8</sup>			
	07.08-03.09	100	Fg.-Nr. 1P..9..001 801→, PR-Code 1KZ	0986 134 048		38				
				0986 135 048		38				
	2.0 TDI	05.05-10.07	125/ 136-147	Fg.-Nr. →1P..8..058 000, PR-Code 1KZ	0986 134 048		38			
0986 135 048						38				
2.0 TFSI	05.05-03.09	125/ 136-147	PR-Code 1KY	0986 134 244			1987 474 496 <sup>8</sup>			
				0986 135 244			1987 474 496 <sup>8</sup>			
				0986 473 381		38,1	1987 470 040			
				0986 473 381		38,1	1987 474 496 <sup>8</sup>			
				0986 474 381		38,1	1987 470 040			
11.07-06.08	125/ 136-147	Fg.-Nr. 1P..8..058 001→2P..9..001 800, PR-Code 1KZ	0986 134 048		38	1987 474 496 <sup>8</sup>				
			0986 135 048		38	1987 474 496 <sup>8</sup>				
07.08-03.09	125/ 136-147	Fg.-Nr. 1P..9..001 801→, PR-Code 1KZ	0986 134 048		38					
			0986 135 048		38					
2.0 TFSI	11.06-10.07	177	Fg.-Nr. →1P..8..058 000, PR-Code 1KZ	0986 134 048		38				
				0986 135 048		38				
	11.06-05.09	177		0986 473 381		38,1	1987 470 040			
				0986 473 381		38,1	1987 474 496 <sup>8</sup>			
				0986 474 381		38,1	1987 470 040			
			PR-Code 1KY	0986 134 244			1987 474 496 <sup>8</sup>			
				0986 135 244			1987 474 496 <sup>8</sup>			
	11.07-06.08	177	Fg.-Nr. 1P..8..058 001→2P..9..001 800, PR-Code 1KZ	0986 134 048		38	1987 474 496 <sup>8</sup>			
				0986 135 048		38	1987 474 496 <sup>8</sup>			
	07.08-05.09	177	Fg.-Nr. 1P..9..001 801→, PR-Code 1KZ	0986 134 048		38				
				0986 135 048		38				
	06.09-12.12	155		0986 134 203		38				
				0986 135 203		38				
		1.2 TSI	02.10-12.12	77				1987 477 958		1447
								1987 477 958		1447
1.4		06.06-05.10	63		TW			1987 482 445		1447
								1987 477 958		1447
1.4 TSI		11.07-12.12	92		TW			1987 477 958		1447
							1987 482 445		1447	

		S							
<b>1.6</b>		07.05-12.12	75			TW	1 987 477 958	↔ 1447	
							1 987 482 445	↔ 1447	
<b>1.6 MultiFuel</b>		12.07-12.12	75			TW	1 987 477 958	↔ 1447	
							1 987 482 445	↔ 1447	
<b>1.6 TDI</b>		02.10-12.12	77				1 987 477 958	↔ 1447	
		11.10-12.12	66				1 987 477 958	↔ 1447	
<b>1.8 TSI</b>		06.07-03.09	118				1 987 482 445	↔ 1447	
		03.09-12.12	118			TW	1 987 477 958	↔ 1447	
							1 987 482 445	↔ 1447	
<b>1.9 TDI</b>		07.05-02.06	77				1 987 482 445	↔ 1447	
		11.05-12.10	77			TW	1 987 477 958	↔ 1447	
							1 987 482 445	↔ 1447	
		06.07-12.10	66			TW	1 987 477 958	↔ 1447	
							1 987 482 445	↔ 1447	
<b>2.0 FSI</b>		07.05-03.09	110				1 987 482 445	↔ 1447	
		05.09-12.12	177			TW	1 987 477 958	↔ 1447	
							1 987 482 445	↔ 1447	
<b>2.0 TDI</b>		07.05-03.09	100				1 987 482 445	↔ 1447	
		07.05-12.12	103			TW	1 987 477 958	↔ 1447	
							1 987 482 445	↔ 1447	
		05.06-03.09	125				1 987 482 445	↔ 1447	
		03.09-12.12	125			TW	1 987 477 958	↔ 1447	
							1 987 482 445	↔ 1447	
		05.10-12.12	103				1 987 477 958	↔ 1447	
			125				1 987 477 958	↔ 1447	
<b>2.0 TFSI</b>		05.05-03.09	136-147				1 987 482 445	↔ 1447	
		11.06-05.09	177				1 987 482 445	↔ 1447	
		06.09-12.12	155				1 987 477 958	↔ 1447	
 <b>1.2 TSI</b>		02.10-12.12	77			LAB	0 986 594 504 <sup>3</sup>		
						RAB	0 986 594 505 <sup>3</sup>		
<b>1.4</b>		06.06-10.09	63/92			LAB	0 986 594 506 <sup>4</sup>		
<b>1.4 TSI</b>						RAB	0 986 594 507 <sup>4</sup>		
		06.06-12.12	63/92			LAB	0 986 594 504 <sup>3</sup>		
						RAB	0 986 594 505 <sup>3</sup>		
<b>1.6</b>		07.05-10.09	75			LAB	0 986 594 506 <sup>4</sup>		
<b>1.6 MultiFuel</b>						RAB	0 986 594 507 <sup>4</sup>		
		07.05-12.12	75			LAB	0 986 594 504 <sup>3</sup>		
						RAB	0 986 594 505 <sup>3</sup>		
<b>1.6 TDI</b>		02.10-12.12	77			LAB	0 986 594 504 <sup>3</sup>		
						RAB	0 986 594 505 <sup>3</sup>		
		11.10-12.12	66			LAB	0 986 594 504 <sup>3</sup>		
						RAB	0 986 594 505 <sup>3</sup>		
<b>1.8 TSI</b>		06.07-10.09	118			LAB	0 986 594 506 <sup>4</sup>		
						RAB	0 986 594 507 <sup>4</sup>		
		06.07-12.12	118			LAB	0 986 594 504 <sup>3</sup>		
						RAB	0 986 594 505 <sup>3</sup>		
<b>1.9 TDI</b>		07.05-10.09	66/77			LAB	0 986 594 506 <sup>4</sup>		
						RAB	0 986 594 507 <sup>4</sup>		
		07.05-12.10	66/77			LAB	0 986 594 504 <sup>3</sup>		
						RAB	0 986 594 505 <sup>3</sup>		
<b>2.0 FSI</b>		05.05-10.09	100/103/110/125/			LAB	0 986 594 506 <sup>4</sup>		
<b>2.0 TDI</b>			136-147/155/177			RAB	0 986 594 507 <sup>4</sup>		
<b>2.0 TFSI</b>		05.05-12.12	100/103/110/125/			LAB	0 986 594 504 <sup>3</sup>		
			136-147/155/177			RAB	0 986 594 505 <sup>3</sup>		
<b>Leon [5F1]</b>									
									
 <b>1.2 TSI</b>		04.14→	81			PR-Code 1ZF			1 987 470 506 <sup>8</sup>
<b>1.4 TGI, TSI, TSI ACT</b>		10.13→	81/92/110			PR-Code 1ZF			1 987 470 506 <sup>8</sup>
<b>1.6 TDI</b>		11.14→	81			PR-Code 1ZF, PR-Code 1ZH			1 987 470 506 <sup>8</sup>



SEAT Leon [5F1]



	1.2 TSI	12.12→	63/77					1987 470 040
								1987 474 496 <sup>8</sup>
		04.14→	81	PR-Code 1KD	D53			1987 470 040
				PR-Code 1KS				1987 474 496 <sup>8</sup>
	1.4 TGI	10.13→	81	PR-Code 1KD	D53			1987 470 040
				PR-Code 1KS				1987 474 496 <sup>8</sup>
	1.4 TSI	09.12→	90					1987 470 040
			103					1987 474 496 <sup>8</sup>
		05.14→	92	PR-Code 1KD	D53			1987 470 040
				PR-Code 1KS				1987 474 496 <sup>8</sup>
	1.4 TSI ACT	05.14→	110	PR-Code 1KD	D53			1987 470 040
				PR-Code 1KS				1987 474 496 <sup>8</sup>
	1.6 TDI	09.12→	66/77					1987 470 040
		08.13→	81					1987 474 496 <sup>8</sup>
		11.14→	81	PR-Code 1KD	D53			1987 470 040
								1987 474 496 <sup>8</sup>
	1.8 TSI	02.13→	132					1987 470 040
	2.0 TDI	10.12→	110					1987 470 040
		05.13→	81/105	PR-Code 1KD	D53			1987 474 496 <sup>8</sup>
				PR-Code 1KS				1987 470 040
		08.13→	135					1987 470 040



	1.2 TSI	12.12→	63/77/81	PR-Code OB2	Y85	1987 482 456	↔ 1463
	1.4 TGI	10.13→	81/90/92/103/110	PR-Code OB2	Y85	1987 482 456	↔ 1463
	1.4 TSI	09.12→	81/90/92/103/110	PR-Code OB2	Y85	1987 482 456	↔ 1463
	1.4 TSI ACT	05.14→	81/90/92/103/110	PR-Code OB2	Y85	1987 482 456	↔ 1463
	1.6 TDI	09.12→	66/77/81	PR-Code OB2	Y85	1987 482 456	↔ 1463
	1.8 TSI	02.13→	132	PR-Code OB2	Y85	1987 482 456	↔ 1463
	2.0 TDI	10.12→	81/105/110/135	PR-Code OB2	Y85	1987 482 456	↔ 1463



1.2 TSI	12.12→	63/77			0986 594 526 <sup>4</sup>
			LAB		0986 594 500 <sup>3</sup>
04.14→	81			RAB	0986 594 501 <sup>3</sup>
		GBM		0986 594 526 <sup>4</sup>	
1.4 TGI	10.13→	81		LAB	0986 594 500 <sup>3</sup>
			GBM		0986 594 526 <sup>4</sup>
09.12→	90			RAB	0986 594 501 <sup>3</sup>
		LAB		0986 594 526 <sup>4</sup>	
103				RAB	0986 594 501 <sup>3</sup>
	LAB			0986 594 500 <sup>3</sup>	
				RAB	0986 594 501 <sup>3</sup>

	S							
1.4 TSI	05.14→	92			GBM	0 986 594 526 <sup>4</sup>		
					LAB	0 986 594 500 <sup>3</sup>		
					RAB	0 986 594 501 <sup>3</sup>		
1.4 TSI ACT	05.14→	110			GBM	0 986 594 526 <sup>4</sup>		
					LAB	0 986 594 500 <sup>3</sup>		
					RAB	0 986 594 501 <sup>3</sup>		
1.6 TDI	09.12→	66/77				0 986 594 526 <sup>4</sup>		
					LAB	0 986 594 500 <sup>3</sup>		
					RAB	0 986 594 501 <sup>3</sup>		
	08.13→	81				0 986 594 526 <sup>4</sup>		
					LAB	0 986 594 500 <sup>3</sup>		
					RAB	0 986 594 501 <sup>3</sup>		
	11.14→	81			GBM	0 986 594 526 <sup>4</sup>		
1.8 TSI	02.13→	132				0 986 594 526 <sup>4</sup>		
					LAB	0 986 594 500 <sup>3</sup>		
					RAB	0 986 594 501 <sup>3</sup>		
2.0 TDI	10.12→	81/105/ 110/135				0 986 594 526 <sup>4</sup>		
					LAB	0 986 594 500 <sup>3</sup>		
					RAB	0 986 594 501 <sup>3</sup>		

**Marbella**

	0.9i	01.95-05.98	30			0 986 473 104		48
						0 986 474 104		48
	0.9	01.87-02.97	29-30	Fg.-Nr. →843494		F 026 002 470		17,46
		06.91-02.97	29-30			0 204 116 403		19,05
	0.9i	01.95-05.98	30			F 026 002 470		17,46
						0 204 116 403		19,05

	0.9i	01.95-05.98	30			1 987 477 086		2668

**Mii [KF1]**















































	1.0	10.11→	44/50/55			0 986 473 071		54
						0 986 474 071		54
								1 987 470 506 <sup>8</sup>
								1 987 470 506 <sup>8</sup>
	1.0	10.11→	44/50/55			0 986 475 260		17,46
	1.0	10.11-11.11	44			1 987 482 374		1528
			55			1 987 482 374		1528
		12.11→	44			1 987 482 375		1518
			55			1 987 482 375		1518
		10.12→	50			1 987 482 375		1518

	1.0	10.11→	44/50/55		LAB	0 986 594 500 <sup>3</sup>		
					RAB	0 986 594 501 <sup>3</sup>		



		S								
◀ SEAT										
<b>Terra</b>										
	0.9	01.87-12.94	29		BDE	0986 473 104		← 48		
						0986 474 104		→ 48		
	1.3D	03.90-12.94	33		BDE	0986 473 104		← 48		
						0986 474 104		→ 48		
	1.4D	10.90-12.94	35		BDE	0986 473 104		← 48		
						0986 474 104		→ 48		
	0.9	01.87-12.94	29			0 204 116 402		↔ 22,2		
	1.3D	03.90-12.94	33			0 204 116 402		↔ 22,2		
	1.4D	10.90-12.94	35			0 204 116 402		↔ 22,2		
	0.9	01.87-12.94	29			1 987 477 792		3170		
	1.3D	03.90-12.94	33			1 987 477 792		3170		
	1.4D	10.90-12.94	35			1 987 477 792		3170		
<b>Toledo [KG3]</b>										
	1.2	07.12→	55/63			0986 473 071		← 54	1 987 470 506 <sup>8</sup>	
	1.2 TSI					0986 474 071		→ 54	1 987 470 506 <sup>8</sup>	
	1.2 TSI	07.12→	77			0986 473 384		← 53,94	F 026 A06 106 <sup>7</sup>	
						0986 473 384		← 53,94	1 987 470 506 <sup>8</sup>	
						0986 474 384		→ 53,94	F 026 A06 106 <sup>7</sup>	
	1.4 TSI	07.12→	90			0986 473 384		← 53,94	F 026 A06 106 <sup>7</sup>	
						0986 473 384		← 53,94	1 987 470 506 <sup>8</sup>	
						0986 474 384		→ 53,94	F 026 A06 106 <sup>7</sup>	
	1.6	07.12→	77			0986 473 384		← 53,94	F 026 A06 106 <sup>7</sup>	
						0986 474 384		→ 53,94	1 987 470 506 <sup>8</sup>	
	1.6, TDI	07.12→	77			0986 474 384		→ 53,94	F 026 A06 106 <sup>7</sup>	
	1.6 TDI	07.12→	77			0986 473 384		← 53,94	F 026 A06 106 <sup>7</sup>	
						0986 473 384		← 53,94	1 987 470 506 <sup>8</sup>	
		10.13→	66			0986 473 384		← 53,94	F 026 A06 106 <sup>7</sup>	
						0986 473 384		← 53,94	1 987 470 506 <sup>8</sup>	
						0986 474 384		→ 53,94	F 026 A06 106 <sup>7</sup>	
	1.2 TSI	07.12→	63/77						1 987 470 040	
									1 987 474 496 <sup>8</sup>	
	1.4 TSI	07.12→	90						1 987 470 040	
									1 987 474 496 <sup>8</sup>	
	1.6	07.12→	66/77						1 987 470 040	
	1.6 TDI								1 987 474 496 <sup>8</sup>	
	1.2	07.12→	55			1 987 482 457		1707		
	1.2 TSI	07.12→	63/77		HTB	1 987 482 457		1707		
					4SB	1 987 482 458		1780		
	1.4 TSI	07.12→	90			1 987 482 458		1780		
	1.6	07.12→	66/77		HTB	1 987 482 457		1707		
	1.6 TDI				4SB	1 987 482 458		1780		
	1.2	07.12→	55/63/77		LAB	0986 594 500 <sup>3</sup>				
	1.2 TSI				RAB	0986 594 501 <sup>3</sup>				
	1.4 TSI	07.12→	90		LAB	0986 594 500 <sup>3</sup>				
					RAB	0986 594 501 <sup>3</sup>				



		S							
1.6		07.12→	66/77			LAB	0 986 594 500 <sup>3</sup>		
1.6 TDI						RAB	0 986 594 501 <sup>3</sup>		
<b>Toledo [1L2]</b>									
									
	1.6	05.91-03.99	55/74			1LM,239			0 204 104 144 <sup>7</sup>
						1LY	0 986 471 669	← 54	1 987 470 287 <sup>7</sup>
							0 986 473 669		
							0 986 472 669	→ 54	1 987 470 287 <sup>7</sup>
							0 986 474 669		
						228	0 986 473 687	 ← 54	1 987 470 287 <sup>7</sup>
							0 986 474 687	 → 54	1 987 470 287 <sup>7</sup>
	1.8	05.91-03.99	66/95			1LM,239			0 204 104 144 <sup>7</sup>
						1LY	0 986 471 669	← 54	1 987 470 287 <sup>7</sup>
							0 986 473 669		
							0 986 472 669	→ 54	1 987 470 287 <sup>7</sup>
							0 986 474 669		
						228	0 986 473 687	 ← 54	1 987 470 287 <sup>7</sup>
							0 986 474 687	 → 54	1 987 470 287 <sup>7</sup>
	1.9 D	05.91-03.99	47/55/66/			1LM,239			0 204 104 144 <sup>7</sup>
	1.9 TD		81			1LY	0 986 471 669	← 54	1 987 470 287 <sup>7</sup>
	1.9 TDI						0 986 473 669		
							0 986 472 669	→ 54	1 987 470 287 <sup>7</sup>
							0 986 474 669		
						228	0 986 473 687	 ← 54	1 987 470 287 <sup>7</sup>
							0 986 474 687	 → 54	1 987 470 287 <sup>7</sup>
	2.0	05.91-03.99	85/110			1LM,239			0 204 104 144 <sup>7</sup>
						1LY	0 986 471 669	← 54	1 987 470 287 <sup>7</sup>
							0 986 473 669		
							0 986 472 669	→ 54	1 987 470 287 <sup>7</sup>
							0 986 474 669		
						228	0 986 473 687	 ← 54	1 987 470 287 <sup>7</sup>
							0 986 474 687	 → 54	1 987 470 287 <sup>7</sup>
									
	1.6	05.91-03.99	55/74				0 986 475 260	↔ 17,46	
	1.8	05.91-03.99	66/95				0 986 475 260	↔ 17,46	
	1.9 D, TD, TDI	05.91-03.99	47/55/66/81				0 986 475 260	↔ 17,46	
	2.0	05.91-03.99	85/110				0 986 475 260	↔ 17,46	
	1.6	05.91-03.99	55/74				0 986 474 875	 ← 38	1 987 470 040
							0 986 474 876	 → 38	1 987 470 040
	1.8	05.91-03.94	95				0 986 473 673	 ← 38	1 987 470 040
							0 986 474 673	 → 38	1 987 470 040
		11.93-03.99	66				0 986 474 875	 ← 38	1 987 470 040
							0 986 474 876	 → 38	1 987 470 040
	1.9 D, TD, TDI	05.91-03.99	47/55/66/81				0 986 474 875	 ← 38	1 987 470 040
							0 986 474 876	 → 38	1 987 470 040
	2.0	05.91-03.94	85	Fg.-Nr. →1L..ZD328 000			0 986 473 673	 ← 38	1 987 470 040
							0 986 474 673	 → 38	1 987 470 040
		03.94-03.99	110				0 986 474 875	 ← 38	1 987 470 040
							0 986 474 876	 → 38	1 987 470 040
		04.94-06.96	85	Fg.-Nr. 1L..ZD328 001→			0 986 474 875	 ← 38	1 987 470 040
							0 986 474 876	 → 38	1 987 470 040
		03.96-03.99	85				0 986 474 875	 ← 38	1 987 470 040
							0 986 474 876	 → 38	1 987 470 040
									
	1.6	05.91-03.99	55/74				1 987 477 167	1622	
						TBR	1 987 477 164	1527	





SEAT Toledo [1L2]

1.8	05.91-03.99	66/95				1987 477 167	1622
				TBR		1987 477 164	1527
1.9 D, TD, TDI	05.91-03.99	47/55/66/81				1987 477 167	1622
				TBR		1987 477 164	1527
2.0	05.91-03.99	85/110				1987 477 167	1622
				TBR		1987 477 164	1527
1.6	04.93-03.99	55	Fg.-Nr. 1L..ZD247 299→			0986 594 001 <sup>3</sup>	
				LAB		0986 594 001 <sup>3</sup>	
	11.96-03.99	74				0986 594 001 <sup>3</sup>	
				LAB		0986 594 001 <sup>3</sup>	
				RAB		0986 594 000 <sup>3</sup>	
1.8	04.93-03.94	95	Fg.-Nr. 1L..ZD247 299→			0986 594 001 <sup>3</sup>	
				LAB		0986 594 001 <sup>3</sup>	
				RAB		0986 594 000 <sup>3</sup>	
	11.93-03.99	66				0986 594 001 <sup>3</sup>	
				LAB		0986 594 001 <sup>3</sup>	
				RAB		0986 594 000 <sup>3</sup>	
1.9 D	04.93-03.99	47/55	Fg.-Nr. 1L..ZD247 299→			0986 594 001 <sup>3</sup>	
1.9 TD						0986 594 000 <sup>3</sup>	
1.9 TDI	04.95-03.99	66/81				0986 594 001 <sup>3</sup>	
				LAB		0986 594 001 <sup>3</sup>	
				RAB		0986 594 000 <sup>3</sup>	
2.0	04.93-06.96	85	Fg.-Nr. 1L..ZD247 299→			0986 594 001 <sup>3</sup>	
				LAB		0986 594 001 <sup>3</sup>	
				RAB		0986 594 000 <sup>3</sup>	
	03.94-03.99	110				0986 594 001 <sup>3</sup>	
				LAB		0986 594 001 <sup>3</sup>	
				RAB		0986 594 000 <sup>3</sup>	
	03.96-03.99	85				0986 594 001 <sup>3</sup>	
				LAB		0986 594 001 <sup>3</sup>	
				RAB		0986 594 000 <sup>3</sup>	

Toledo [1M2]

1.4	01.00-05.02	55	PR-Code 1LE	288		0986 471 923	← 54	1987 470 506 <sup>8</sup>
						0986 473 923	🌀	
						0986 471 924	→ 54	1987 470 506 <sup>8</sup>
						0986 473 924	🌀	
			PR-Code 1LQ, PR-Code 1LR, PR-Code 1LS	228,252		0986 473 071	🌀 ← 54	1987 470 506 <sup>8</sup>
						0986 474 071	🌀 → 54	1987 470 506 <sup>8</sup>
1.6	10.98-07.04	74/77	PR-Code 1LE	288		0986 471 923	← 54	1987 470 506 <sup>8</sup>
						0986 473 923	🌀	
						0986 471 924	→ 54	1987 470 506 <sup>8</sup>
						0986 473 924	🌀	
			PR-Code 1LQ, PR-Code 1LR, PR-Code 1LS	228,252		0986 473 071	🌀 ← 54	1987 470 506 <sup>8</sup>
						0986 474 071	🌀 → 54	1987 470 506 <sup>8</sup>
1.8	10.98-12.03	92	PR-Code 1LE	288		0986 471 923	← 54	1987 470 506 <sup>8</sup>
						0986 473 923	🌀	
						0986 471 924	→ 54	1987 470 506 <sup>8</sup>
						0986 473 924	🌀	
			PR-Code 1LR, PR-Code 1LS	228		0986 473 071	🌀 ← 54	1987 470 506 <sup>8</sup>
						0986 474 071	🌀 → 54	1987 470 506 <sup>8</sup>
1.8 T	09.00-10.00	132	Fg.-Nr. →1M..1B044 183, →1M..1R049 650, PR-Code 1ZQ	312		0986 473 923	🌀 ← 54	1987 470 506 <sup>8</sup>
						0986 473 924	🌀 → 54	1987 470 506 <sup>8</sup>
	09.00-07.04	132	PR-Code 1LE	288		0986 471 923	← 54	1987 470 506 <sup>8</sup>
						0986 473 923	🌀	
						0986 471 924	→ 54	1987 470 506 <sup>8</sup>
						0986 473 924	🌀	
			PR-Code 1LR, PR-Code 1LS	228		0986 473 071	🌀 ← 54	1987 470 506 <sup>8</sup>
						0986 474 071	🌀 → 54	1987 470 506 <sup>8</sup>
	11.00-11.01	132	Fg.-Nr. 1M..1B044 184→ 1M..2..060 744, 1M..1R049 651→ 1M..2..060 744, PR-Code 1LJ	312		0986 473 923	🌀 ← 54	1987 470 506 <sup>8</sup>
						0986 473 924	🌀 → 54	1987 470 506 <sup>8</sup>
	12.01-07.04	132	Fg.-Nr. 1M..2..060 745→, PR-Code 1LJ	312		0986 473 923	🌀 ← 54	1987 470 506 <sup>8</sup>
						0986 473 924	🌀 → 54	1987 470 506 <sup>8</sup>
1.9 TDI	10.98-10.00	81	Fg.-Nr. →1M..1B044 183, →1M..1R049 650, PR-Code 1ZQ	312		0986 473 923	🌀 ← 54	1987 470 506 <sup>8</sup>
						0986 473 924	🌀 → 54	1987 470 506 <sup>8</sup>

				S							
1.9 TDI	10.98-07.04	81	PR-Code 1LE	288	0 986 471 923	← 54	1 987 470 506 <sup>B</sup>	0 986 473 923	↻		
					0 986 471 924	→ 54	1 987 470 506 <sup>B</sup>	0 986 473 924	↻		
			PR-Code 1LR, PR-Code 1LS	228	0 986 473 071	↻ ← 54	1 987 470 506 <sup>B</sup>	0 986 474 071	↻ → 54		
	04.99-07.04	66	PR-Code 1LE	288	0 986 471 923	← 54	1 987 470 506 <sup>B</sup>	0 986 473 923	↻		
					0 986 471 924	→ 54	1 987 470 506 <sup>B</sup>	0 986 473 924	↻		
			PR-Code 1LQ, PR-Code 1LR, PR-Code 1LS	228,252	0 986 473 071	↻ ← 54	1 987 470 506 <sup>B</sup>	0 986 474 071	↻ → 54		
	09.00-10.00	110	Fg.-Nr. →1M..1B044 183, →1M..1R049 650, PR-Code 1ZQ	312	0 986 473 923	↻ ← 54	1 987 470 506 <sup>B</sup>	0 986 473 924	↻ → 54		
	09.00-05.02	110	PR-Code 1LE	288	0 986 471 923	← 54	1 987 470 506 <sup>B</sup>	0 986 473 923	↻		
					0 986 471 924	→ 54	1 987 470 506 <sup>B</sup>	0 986 473 924	↻		
			PR-Code 1LR, PR-Code 1LS	228	0 986 473 071	↻ ← 54	1 987 470 506 <sup>B</sup>	0 986 474 071	↻ → 54		
	11.00-11.01	81	Fg.-Nr. 1M..1B044 184→ 1M..2..060 744, 1M..1R049 651→ 1M..2..060 744, PR-Code 1LJ	312	0 986 473 923	↻ ← 54	1 987 470 506 <sup>B</sup>	0 986 473 924	↻ → 54		
		110	Fg.-Nr. 1M..1B044 184→ 1M..2..060 744, 1M..1R049 651→ 1M..2..060 744, PR-Code 1LJ	312	0 986 473 923	↻ ← 54	1 987 470 506 <sup>B</sup>	0 986 473 924	↻ → 54		
	12.01-05.02	110	Fg.-Nr. 1M..2..060 745→, PR-Code 1LJ	312	0 986 473 923	↻ ← 54	1 987 470 506 <sup>B</sup>	0 986 473 924	↻ → 54		
	12.01-07.04	81	Fg.-Nr. 1M..2..060 745→, PR-Code 1LJ	312	0 986 473 923	↻ ← 54	1 987 470 506 <sup>B</sup>	0 986 473 924	↻ → 54		
	05.03-07.04	96	PR-Code 1LE	288	0 986 471 923	← 54	1 987 470 506 <sup>B</sup>	0 986 473 923	↻		
					0 986 471 924	→ 54	1 987 470 506 <sup>B</sup>	0 986 473 924	↻		
			PR-Code 1LJ	312	0 986 473 923	↻ ← 54	1 987 470 506 <sup>B</sup>	0 986 473 924	↻ → 54		
			PR-Code 1LR, PR-Code 1LS	228	0 986 473 071	↻ ← 54	1 987 470 506 <sup>B</sup>	0 986 474 071	↻ → 54		
2.3	10.98-10.00	110	Fg.-Nr. →1M..1B044 183, →1M..1R049 650, PR-Code 1ZQ	312	0 986 473 923	↻ ← 54	1 987 470 506 <sup>B</sup>	0 986 473 924	↻ → 54		
	10.98-11.00	110	PR-Code 1LE	288	0 986 471 923	← 54	1 987 470 506 <sup>B</sup>	0 986 473 923	↻		
					0 986 471 924	→ 54	1 987 470 506 <sup>B</sup>	0 986 473 924	↻		
			PR-Code 1LR, PR-Code 1LS	228	0 986 473 071	↻ ← 54	1 987 470 506 <sup>B</sup>	0 986 474 071	↻ → 54		
	09.00-10.00	125	Fg.-Nr. →1M..1B044 183, →1M..1R049 650, PR-Code 1ZQ	312	0 986 473 923	↻ ← 54	1 987 470 506 <sup>B</sup>	0 986 473 924	↻ → 54		
	09.00-11.03	125	PR-Code 1LE	288	0 986 471 923	← 54	1 987 470 506 <sup>B</sup>	0 986 473 923	↻		
					0 986 471 924	→ 54	1 987 470 506 <sup>B</sup>	0 986 473 924	↻		
			PR-Code 1LR, PR-Code 1LS	228	0 986 473 071	↻ ← 54	1 987 470 506 <sup>B</sup>	0 986 474 071	↻ → 54		
	11.00-11.00	110	Fg.-Nr. 1M..1B044 184→, 1M..1R049 651→, PR-Code 1LJ	312	0 986 473 923	↻ ← 54	1 987 470 506 <sup>B</sup>	0 986 473 924	↻ → 54		
	11.00-11.01	125	Fg.-Nr. 1M..1B044 184→ 1M..2..060 744, 1M..1R049 651→ 1M..2..060 744, PR-Code 1LJ	312	0 986 473 923	↻ ← 54	1 987 470 506 <sup>B</sup>	0 986 473 924	↻ → 54		







	S														
<b>SEAT Toledo [1M2]</b>															
	<b>2.3</b>	09.00-11.03	125	PR-Code 1KK	232,B38	0986 473 099		38,1	1987 470 040						
						0986 473 099		38,1	1987 474 496 <sup>8</sup>						
						0986 474 099		38,1	1987 470 040						
	PR-Code 1KP	232,B41	0986 473 029		41	1987 474 496 <sup>8</sup>									
			0986 474 029		41	1987 474 496 <sup>8</sup>									
			PR-Code 1KY	252	0986 473 139		38,1	1987 470 040							
	0986 473 139		38,1		1987 474 496 <sup>8</sup>										
	0986 474 139		38,1		1987 470 040										
	<b>SEAT Ibiza [6P2]</b>														
	<b>U</b>	<b>1.4</b>	01.00-05.02	55		1987 477 698		1693							
		<b>1.6</b>	10.98-07.04	74/77			1987 477 698		1693						
		<b>1.8</b>	10.98-12.03	92/132			1987 477 698		1693						
		<b>1.8 T</b>	09.00-07.04	92/132			1987 477 698		1693						
		<b>1.9 TDI</b>	10.98-05.99	81	Fg.-Nr. →1M..Y..006500			1987 477 696		1688					
			04.99-07.04	66				1987 477 698		1693					
			06.99-09.02	81	Fg.-Nr. 1M..Y..006501→			1987 477 698		1693					
			10.99-07.04	81		SSZ		1987 477 698		1693					
							SSZ		1987 477 817		1700				
				09.00-05.02	110			1987 477 698		1693					
				05.03-07.04	96			1987 477 698		1693					
		<b>2.3</b>	10.98-11.03	110/125				1987 477 698		1693					
		<b>SEAT Ibiza [6P2]</b>													
			<b>S</b>	<b>T</b>	01.00-05.02	55					0986 594 004 <sup>4</sup>				
											LAB	0986 594 001 <sup>3</sup>			
									RAB	0986 594 000 <sup>3</sup>					
<b>1.6</b>	10.98-07.04							74/77				0986 594 004 <sup>4</sup>			
												LAB	0986 594 001 <sup>3</sup>		
												RAB	0986 594 000 <sup>3</sup>		
<b>1.8</b>	10.98-07.04							92/132				0986 594 004 <sup>4</sup>			
												LAB	0986 594 001 <sup>3</sup>		
<b>1.8 T</b>												0986 594 001 <sup>3</sup>			
												RAB	0986 594 000 <sup>3</sup>		
<b>1.9 TDI</b>	10.98-07.04							66/81/96/ 110				0986 594 004 <sup>4</sup>			
												LAB	0986 594 001 <sup>3</sup>		
												RAB	0986 594 000 <sup>3</sup>		
<b>2.3</b>	10.98-11.03							110/125				0986 594 004 <sup>4</sup>			
												LAB	0986 594 001 <sup>3</sup>		
						RAB	0986 594 000 <sup>3</sup>								
<b>Toledo [5P2]</b>															
	<b>M</b>	<b>SEAT</b>	05.06-05.09	63/92	PR-Code 1ZE	288	0986 473 384		53,94	F 026 A06 106 <sup>7</sup>					
							0986 473 384		53,94	1987 470 506 <sup>8</sup>					
							0986 474 384		53,94	F 026 A06 106 <sup>7</sup>					
							PR-Code 1ZF	228	0986 473 071		54	1987 470 506 <sup>8</sup>			
									0986 474 071		54	1987 470 506 <sup>8</sup>			
									<b>1.6</b>	09.04-05.09	75	PR-Code 1ZE	288	0986 473 384	
							0986 473 384							53,94	1987 470 506 <sup>8</sup>
							0986 474 384							53,94	F 026 A06 106 <sup>7</sup>
							PR-Code 1ZF	228	0986 473 071		54	1987 470 506 <sup>8</sup>			
									0986 474 071		54	1987 470 506 <sup>8</sup>			
									<b>1.8 TSI</b>	01.07-05.09	118	PR-Code 1ZE	288	0986 473 384	
							0986 473 384							53,94	1987 470 506 <sup>8</sup>
							0986 474 384							53,94	F 026 A06 106 <sup>7</sup>
							PR-Code 1ZF	228	0986 473 071		54	1987 470 506 <sup>8</sup>			
									0986 474 071		54	1987 470 506 <sup>8</sup>			
									<b>1.9 TDI</b>	09.04-05.09	77	PR-Code 1ZE	288	0986 473 384	
							0986 473 384							53,94	1987 470 506 <sup>8</sup>
							0986 474 384							53,94	F 026 A06 106 <sup>7</sup>
							PR-Code 1ZF	228	0986 473 071		54	1987 470 506 <sup>8</sup>			
									0986 474 071		54	1987 470 506 <sup>8</sup>			







































											SEAT Toledo [5P2]									
2.0 TDI										12.05-05.09	103	Fg.-Nr. 5P..5..048 331→			1987 477 957	→ 1447				
														1987 477 958	← 1447					
										01.06-05.09	103				1987 477 957	→ 1447				
														1987 477 958	← 1447					
											125				1987 477 957	→ 1447				
														1987 477 958	← 1447					
2.0 TFSI										11.05-11.05	147	Fg.-Nr. →5P..5..048 330			1987 482 445	↔ 1447				
										12.05-05.09	147	Fg.-Nr. 5P..5..048 331→			1987 477 957	→ 1447				
														1987 477 958	← 1447					

											SKODA								
1.4										05.06-05.09	63/92			0986 594 504 <sup>3</sup>					
1.4 TSI												LAB		0986 594 506 <sup>4</sup>					
												RAB		0986 594 505 <sup>3</sup>					
														0986 594 507 <sup>4</sup>					
1.6										09.04-05.09	75			0986 594 504 <sup>3</sup>					
												LAB		0986 594 506 <sup>4</sup>					
												RAB		0986 594 505 <sup>3</sup>					
														0986 594 507 <sup>4</sup>					
1.8 TSI										01.07-05.09	118			0986 594 504 <sup>3</sup>					
												LAB		0986 594 506 <sup>4</sup>					
												RAB		0986 594 505 <sup>3</sup>					
														0986 594 507 <sup>4</sup>					
1.9 TDI										09.04-05.09	77			0986 594 504 <sup>3</sup>					
												LAB		0986 594 506 <sup>4</sup>					
												RAB		0986 594 505 <sup>3</sup>					
														0986 594 507 <sup>4</sup>					
2.0 FSI										09.04-05.09	100/103/			0986 594 504 <sup>3</sup>					
2.0 TDI											110/125/			0986 594 506 <sup>4</sup>					
2.0 TFSI											147			0986 594 505 <sup>3</sup>					
												RAB		0986 594 507 <sup>4</sup>					

**SKODA**













**Citigo [NF1]**

											Citigo [NF1]								
1.0										10.11→	44/50/55			0986 473 071		← 54	1987 470 506 <sup>8</sup>		
1.0 G-Tec														0986 474 071		→ 54	1987 470 506 <sup>8</sup>		
1.0										10.11→	44/50/55			0986 475 260		↔ 17,46			
1.0 G-Tec																			
1.0										10.11-11.11	44		FMU	1987 482 374		↔ 1528			
											55		FMU	1987 482 374		↔ 1528			
										12.11→	44		FMU	1987 482 375		↔ 1518			
											55		FMU	1987 482 375		↔ 1518			
1.0 G-Tec										11.12→	50		FMU	1987 482 375		↔ 1518			
1.0										10.11→	44/50/55		LAB	0986 594 500 <sup>3</sup>					
1.0 G-Tec														0986 594 502 <sup>4</sup>					
													RAB	0986 594 501 <sup>3</sup>					
														0986 594 503 <sup>4</sup>					
										<b>Fabia Combi [NJ5]</b>									
1.0 MPI										08.14→	44/55	PR-Code 1ZC	288	0986 473 384		← 53,94	F 026 A06 106 <sup>7</sup>		
														0986 474 384		→ 53,94	F 026 A06 106 <sup>7</sup>		

		S							
<b>1.0 MPI</b>		08.14→	44/55	PR-Code 1ZG	252	0 986 473 071	 ← 54		
						0 986 474 071	 → 54		
				PR-Code 1ZG, PR-Code 1ZC	252,288				1 987 470 506 <sup>8</sup>
<b>1.2 TSI</b>		08.14→	66/81	PR-Code 1ZC	288	0 986 473 384	 ← 53,94	F 026 A06 106 <sup>7</sup>	
						0 986 474 384	 → 53,94	F 026 A06 106 <sup>7</sup>	
				PR-Code 1ZG	252	0 986 473 071	 ← 54		
						0 986 474 071	 → 54		
				PR-Code 1ZG, PR-Code 1ZC	252,288				1 987 470 506 <sup>8</sup>
<b>1.4 TDI</b>		08.14→	66/77	PR-Code 1ZC	288	0 986 473 384	 ← 53,94	F 026 A06 106 <sup>7</sup>	
						0 986 474 384	 → 53,94	F 026 A06 106 <sup>7</sup>	
				PR-Code 1ZG	252	0 986 473 071	 ← 54		
						0 986 474 071	 → 54		
				PR-Code 1ZG, PR-Code 1ZC	252,288				1 987 470 506 <sup>8</sup>
									
	<b>1.0 MPI</b>	08.14→	44/55			0 986 475 433	↔ 19,05		
	<b>1.2 TSI</b>	08.14→	66/81			0 986 475 433	↔ 19,05		
	<b>1.4 TDI</b>	08.14→	66/77			0 986 475 433	↔ 19,05		
	<b>1.0 MPI</b>	08.14→	44/55						1 987 470 040 <sup>7</sup>
	<b>1.2 TSI</b>	08.14→	66/81						1 987 470 040 <sup>7</sup>
	<b>1.4 TDI</b>	08.14→	66/77						1 987 470 040 <sup>7</sup>
									
	<b>1.0 MPI</b>	08.14→	44/55			FMU,HTB	1 987 482 266	↔ 1588	
	<b>1.2 TSI</b>	08.14→	66/81			FMU,HTB	1 987 482 266	↔ 1588	
	<b>1.4 TDI</b>	08.14→	66/77			FMU,HTB	1 987 482 266	↔ 1588	
	<b>1.0 MPI</b>	08.14→	44/55			LAB	0 986 594 500 <sup>3</sup>		
						RAB	0 986 594 502 <sup>4</sup>		
							0 986 594 501 <sup>3</sup>		
							0 986 594 503 <sup>4</sup>		
	<b>1.2 TSI</b>	08.14→	66/81			LAB	0 986 594 500 <sup>3</sup>		
						RAB	0 986 594 502 <sup>4</sup>		
							0 986 594 501 <sup>3</sup>		
							0 986 594 503 <sup>4</sup>		
	<b>1.4 TDI</b>	08.14→	66/77			LAB	0 986 594 500 <sup>3</sup>		
						RAB	0 986 594 502 <sup>4</sup>		
							0 986 594 501 <sup>3</sup>		
							0 986 594 503 <sup>4</sup>		
<b>Fabia Combi [5J5]</b>									
									
	<b>1.2</b>	12.06-05.09	44	PR-Code 1LQ, PR-Code 1LR, PR-Code 1ZG	252	0 986 473 071	 ← 54		1 987 470 506 <sup>8</sup>
						0 986 474 071	 → 54		1 987 470 506 <sup>8</sup>
		12.06-03.10	44	PR-Code 1LB, PR-Code 1LM		0 204 102 580	← 48		0 204 104 144 <sup>7</sup>
						0 986 134 020			
						0 204 102 581	→ 48		0 204 104 144 <sup>7</sup>
						0 204 103 581			
						0 986 135 020			
		10.07-03.10	51	PR-Code 1LB, PR-Code 1LM		0 204 102 580	← 48		0 204 104 144 <sup>7</sup>
						0 986 134 020			
						0 204 102 581	→ 48		0 204 104 144 <sup>7</sup>
						0 204 103 581			
						0 986 135 020			
		10.07-12.14	51	PR-Code 1LQ, PR-Code 1LR, PR-Code 1ZG	252	0 986 473 071	 ← 54		1 987 470 506 <sup>8</sup>
						0 986 474 071	 → 54		1 987 470 506 <sup>8</sup>



			S												
◀ SKODA Fabia Combi [5J5]															
1.2	03.09-06.09	51						0 204 102 580	← 48	0 204 104 144 <sup>7</sup>					
								0 986 134 020							
								0 204 102 581	→ 48	0 204 104 144 <sup>7</sup>					
								0 204 103 581							
								0 986 135 020							
								252		0 986 473 071	← 54	1 987 470 506 <sup>8</sup>			
										0 986 474 071	→ 54	1 987 470 506 <sup>8</sup>			
								03.09-03.10	44		PR-Code 1LN, PR-Code 1ZH	288	0 986 473 192	← 54	1 987 470 287 <sup>7</sup>
													0 986 474 192	→ 54	1 987 470 287 <sup>7</sup>
											PR-Code 1LQ, PR-Code 1LR	252	0 986 473 071	← 54	1 987 470 506 <sup>8</sup>
													0 986 474 071	→ 54	1 987 470 506 <sup>8</sup>
								03.09-11.11	44		PR-Code 1ZG	252	0 986 473 071	← 54	1 987 470 506 <sup>8</sup>
0 986 474 071	→ 54	1 987 470 506 <sup>8</sup>													
04.10-11.11	44		PR-Code 1ZC	288	0 986 473 384	← 53,94	F 026 A06 106 <sup>7</sup>								
					0 986 473 384	← 53,94	1 987 470 506 <sup>8</sup>								
					0 986 474 384	→ 53,94	F 026 A06 106 <sup>7</sup>								
11.11-12.14	44		PR-Code 1ZG		0 986 473 071	← 54	1 987 470 506 <sup>8</sup>								
					0 986 474 071	→ 54	1 987 470 506 <sup>8</sup>								
1.2 TDI	03.10-12.14	55/63/77	PR-Code 1LQ, PR-Code 1LR, PR-Code 1ZG	252	0 986 473 071	← 54	1 987 470 506 <sup>8</sup>								
					0 986 474 071	→ 54	1 987 470 506 <sup>8</sup>								
			PR-Code 1ZC	288	0 986 473 384	← 53,94	F 026 A06 106 <sup>7</sup>								
					0 986 473 384	← 53,94	1 987 470 506 <sup>8</sup>								
					0 986 474 384	→ 53,94	F 026 A06 106 <sup>7</sup>								
1.4	10.07-03.10	63			252	0 986 473 071	← 54	1 987 470 506 <sup>8</sup>							
						0 986 474 071	→ 54	1 987 470 506 <sup>8</sup>							
					288	0 986 473 192	← 54	1 987 470 287 <sup>7</sup>							
						0 986 474 192	→ 54	1 987 470 287 <sup>7</sup>							
	03.10-12.14	63		PR-Code 1LQ, PR-Code 1LR, PR-Code 1ZG	252	0 986 473 071	← 54	1 987 470 506 <sup>8</sup>							
						0 986 474 071	→ 54	1 987 470 506 <sup>8</sup>							
	PR-Code 1ZC	288	0 986 473 384	← 53,94	F 026 A06 106 <sup>7</sup>										
			0 986 473 384	← 53,94	1 987 470 506 <sup>8</sup>										
			0 986 474 384	→ 53,94	F 026 A06 106 <sup>7</sup>										
			0 986 474 384	→ 53,94	F 026 A06 106 <sup>7</sup>										
1.4 TDI	10.07-03.10	51/59	PR-Code 1LB, PR-Code 1LM		0 204 102 580	← 48	0 204 104 144 <sup>7</sup>								
					0 986 134 020										
					0 204 102 581	→ 48	0 204 104 144 <sup>7</sup>								
					0 204 103 581										
					0 986 135 020										
					PR-Code 1LQ, PR-Code 1LR, PR-Code 1ZG	252	0 986 473 071	← 54	1 987 470 506 <sup>8</sup>						
		0 986 474 071	→ 54	1 987 470 506 <sup>8</sup>											
1.4 TSI	05.10-12.14	132					F 026 A06 106 <sup>7</sup>								
							1 987 470 506 <sup>8</sup>								
1.4 TSI RS			PR-Code 1ZC	BSR	0 986 473 384	← 53,94									
					0 986 474 384	→ 53,94									
					0 986 473 384	← 53,94									
					0 986 474 384	→ 53,94									
1.6	10.07-07.10	77	PR-Code 1LN, PR-Code 1ZH	288	0 986 473 192	← 54	1 987 470 287 <sup>7</sup>								
					0 986 474 192	→ 54	1 987 470 287 <sup>7</sup>								
			PR-Code 1ZC	288	0 986 473 384	← 53,94	F 026 A06 106 <sup>7</sup>								
					0 986 474 384	→ 53,94	F 026 A06 106 <sup>7</sup>								
1.6	10.07-12.14	77	PR-Code 1LQ, PR-Code 1LR, PR-Code 1ZG	252	0 986 473 071	← 54	1 987 470 506 <sup>8</sup>								
					0 986 474 071	→ 54	1 987 470 506 <sup>8</sup>								
1.6 TDI	03.10-12.14	77	PR-Code 1ZC	288	0 986 473 384	← 53,94	1 987 470 506 <sup>8</sup>								
					0 986 474 384	→ 53,94	F 026 A06 106 <sup>7</sup>								
1.6 TDI	03.10-12.14	55/66	PR-Code 1LQ, PR-Code 1LR, PR-Code 1ZG	252	0 986 473 071	← 54	1 987 470 506 <sup>8</sup>								
					0 986 474 071	→ 54	1 987 470 506 <sup>8</sup>								
			PR-Code 1ZC	288	0 986 473 384	← 53,94	F 026 A06 106 <sup>7</sup>								
					0 986 473 384	← 53,94	1 987 470 506 <sup>8</sup>								
								0 986 474 384	→ 53,94	F 026 A06 106 <sup>7</sup>					
								0 986 474 384	→ 53,94	1 987 470 506 <sup>8</sup>					
1.9 TDI	10.07-03.10	77	PR-Code 1LN, PR-Code 1ZH	288	0 986 473 192	← 54	1 987 470 287 <sup>7</sup>								
					0 986 474 192	→ 54	1 987 470 287 <sup>7</sup>								
			PR-Code 1LQ, PR-Code 1LR, PR-Code 1ZG	252	0 986 473 071	← 54	1 987 470 506 <sup>8</sup>								
					0 986 474 071	→ 54	1 987 470 506 <sup>8</sup>								

		S							
									
	1.2	12.06-06.09	44/51				0 986 475 433	↔ 19,05	
		03.09-12.14	44/51	PR-Code 1KM			0 986 475 433	↔ 19,05	
	1.2, TDI	03.10-12.14	55/63/77	PR-Code 1KM			0 986 475 433	↔ 19,05	
	1.4	10.07-03.10	63				0 986 475 433	↔ 19,05	
		03.10-12.14	63	PR-Code 1KM			0 986 475 433	↔ 19,05	
	1.4 TDI	10.07-03.10	51	PR-Code 1KM			0 986 475 433	↔ 19,05	
			59				0 986 475 433	↔ 19,05	
	1.6, TDI	10.07-12.14	55/77	PR-Code 1KM			0 986 475 433	↔ 19,05	
	1.2	12.06-05.09	44				0 986 473 099	↔ ← 38,1	1 987 470 040 <sup>7</sup>
							0 986 474 099	↔ → 38,1	1 987 470 040 <sup>7</sup>
		10.07-06.09	51				0 986 473 099	↔ ← 38,1	1 987 470 040 <sup>7</sup>
							0 986 474 099	↔ → 38,1	1 987 470 040 <sup>7</sup>
		03.09-05.09	44	PR-Code 1KK	BSR		0 986 473 099	↔ ← 38,1	
							0 986 474 099	↔ → 38,1	
		03.09-11.11	44						1 987 470 040 <sup>7</sup>
	1.2, TDI	03.10-12.14	55/63/77						1 987 470 040 <sup>7</sup>
	1.4	10.07-05.09	51/59/63	PR-Code 1KK	BSR		0 986 473 099	↔ ← 38,1	
	1.4 TDI						0 986 474 099	↔ → 38,1	
		10.07-12.14	51/59/63						1 987 470 040 <sup>7</sup>
	1.4 TSI, TSI RS	05.10-12.14	132						1 987 470 040 <sup>7</sup>
	1.6	10.07-05.09	77	PR-Code 1KK	BSR		0 986 473 099	↔ ← 38,1	
							0 986 474 099	↔ → 38,1	
	1.6, TDI	10.07-12.14	77						1 987 470 040 <sup>7</sup>
	1.6 TDI	03.10-12.14	55/66						1 987 470 040 <sup>7</sup>
	1.9 TDI	10.07-05.09	77	PR-Code 1KK	BSR		0 986 473 099	↔ ← 38,1	
							0 986 474 099	↔ → 38,1	
		10.07-03.10	77						1 987 470 040 <sup>7</sup>
									
	1.2	12.06-11.11	44		4SB,SSZ		1 987 477 807	↔ 1640	
		12.06-12.14	44		HTB,SSZ		1 987 482 446	↔ 1580	
					HTB,SSZ		1 987 477 806	↔ 1580	
					4SB,SSZ		1 987 482 451	↔ 1645	
		10.07-06.09	51/55		4SB,SSZ		1 987 477 807	↔ 1640	
		10.07-12.14	51/55		HTB,SSZ		1 987 482 446	↔ 1580	
					HTB,SSZ		1 987 477 806	↔ 1580	
					4SB,SSZ		1 987 482 451	↔ 1645	
		03.10-12.14	55/63/77		HTB,SSZ		1 987 482 446	↔ 1580	
					HTB,SSZ		1 987 477 806	↔ 1580	
					4SB,SSZ		1 987 482 451	↔ 1645	
					4SB,SSZ		1 987 477 807	↔ 1640	
	1.2 TDI	03.10-12.14	51/55		HTB,SSZ		1 987 482 446	↔ 1580	
					HTB,SSZ		1 987 477 806	↔ 1580	
					4SB,SSZ		1 987 482 451	↔ 1645	
			55/63/77		4SB,SSZ		1 987 477 807	↔ 1640	
	1.4	10.07-12.14	51/59/63		HTB,SSZ		1 987 482 446	↔ 1580	
					HTB,SSZ		1 987 477 806	↔ 1580	
					4SB,SSZ		1 987 482 451	↔ 1645	
					4SB,SSZ		1 987 477 807	↔ 1640	
	1.4 TDI	10.07-03.10	51/59/63		HTB,SSZ		1 987 482 446	↔ 1580	
					HTB,SSZ		1 987 477 806	↔ 1580	
					4SB,SSZ		1 987 482 451	↔ 1645	
					4SB,SSZ		1 987 477 807	↔ 1640	
	1.4 TSI	05.12-12.14	132		SSZ		1 987 482 451	↔ 1645	
					4SB,SSZ		1 987 477 807	↔ 1640	
	1.4 TSI RS	05.10-05.12	132		SSZ		1 987 482 451	↔ 1645	
					4SB,SSZ		1 987 477 807	↔ 1640	

		S												
<b>SKODA Fabia Combi [5J5]</b>														
1.6		10.07-12.14	55/66/77				HTB,SSZ	1987	<b>482 446</b>	↔ 1580				
							HTB,SSZ	1987	<b>477 806</b>	↔ 1580				
							4SB,SSZ	1987	<b>482 451</b>	↔ 1645				
							4SB,SSZ	1987	<b>477 807</b>	↔ 1640				
1.6 TDI		03.10-12.14	55/66/77				HTB,SSZ	1987	<b>482 446</b>	↔ 1580				
							HTB,SSZ	1987	<b>477 806</b>	↔ 1580				
							4SB,SSZ	1987	<b>482 451</b>	↔ 1645				
							4SB,SSZ	1987	<b>477 807</b>	↔ 1640				
1.9 TDI		10.07-03.10	77				HTB,SSZ	1987	<b>482 446</b>	↔ 1580				
							HTB,SSZ	1987	<b>477 806</b>	↔ 1580				
							4SB,SSZ	1987	<b>482 451</b>	↔ 1645				
							4SB,SSZ	1987	<b>477 807</b>	↔ 1640				
	1.2	12.06-12.14	44/51/55/ 63/77				LAB	0986	<b>594 500</b> <sup>3</sup>					
							RAB	0986	<b>594 502</b> <sup>4</sup>					
							RAB	0986	<b>594 501</b> <sup>3</sup>					
							RAB	0986	<b>594 503</b> <sup>4</sup>					
1.4	1.4 TDI	10.07-12.14	51/59/63/ 132				LAB	0986	<b>594 500</b> <sup>3</sup>					
							RAB	0986	<b>594 502</b> <sup>4</sup>					
							RAB	0986	<b>594 501</b> <sup>3</sup>					
							RAB	0986	<b>594 503</b> <sup>4</sup>					
1.4 TSI	1.4 TSI RS	10.07-12.14	55/66/77				LAB	0986	<b>594 500</b> <sup>3</sup>					
							RAB	0986	<b>594 502</b> <sup>4</sup>					
							RAB	0986	<b>594 501</b> <sup>3</sup>					
							RAB	0986	<b>594 503</b> <sup>4</sup>					
1.6	1.6 TDI	10.07-03.10	77				LAB	0986	<b>594 500</b> <sup>3</sup>					
							RAB	0986	<b>594 502</b> <sup>4</sup>					
							RAB	0986	<b>594 501</b> <sup>3</sup>					
							RAB	0986	<b>594 503</b> <sup>4</sup>					
1.9 TDI		10.07-03.10	77				LAB	0986	<b>594 500</b> <sup>3</sup>					
							RAB	0986	<b>594 502</b> <sup>4</sup>					
							RAB	0986	<b>594 501</b> <sup>3</sup>					
							RAB	0986	<b>594 503</b> <sup>4</sup>					
<b>Fabia Combi [6Y5]</b>														
	1.2	08.02-12.07	40				0204	<b>102 580</b>	← 48	0204 <b>104 144</b> <sup>7</sup>				
							0986	<b>134 020</b>	↻					
							0204	<b>102 581</b>	→ 48	0204 <b>104 144</b> <sup>7</sup>				
							0204	<b>103 581</b>	↻					
							0986	<b>135 020</b>	↻					
							02.03-11.04	47	PR-Code 1LB, PR-Code 1LM, PR-Code 1ZN	0204	<b>102 580</b>	← 48	0204 <b>104 144</b> <sup>7</sup>	
							0986	<b>134 020</b>	↻					
							0204	<b>102 581</b>	→ 48	0204 <b>104 144</b> <sup>7</sup>				
		0204	<b>103 581</b>	↻										
		0986	<b>135 020</b>	↻										
				PR-Code 1LQ, PR-Code 1LR	252	0986	<b>473 071</b>	↻ ← 54	1987 <b>470 506</b> <sup>8</sup>					
						0986	<b>474 071</b>	↻ → 54	1987 <b>470 506</b> <sup>8</sup>					
		11.04-12.07	47		0204	<b>102 580</b>	← 48	0204 <b>104 144</b> <sup>7</sup>						
					0986	<b>134 020</b>	↻							
					0204	<b>102 581</b>	→ 48	0204 <b>104 144</b> <sup>7</sup>						
					0204	<b>103 581</b>	↻							
					0986	<b>135 020</b>	↻							
					252	0986	<b>473 071</b>	↻ ← 54	1987 <b>470 506</b> <sup>8</sup>					
						0986	<b>474 071</b>	↻ → 54	1987 <b>470 506</b> <sup>8</sup>					
		1.4	09.00-03.03	44					PR-Code 1LM	0204	<b>102 580</b>	← 48	0204 <b>104 144</b> <sup>7</sup>	
0986	<b>134 020</b>								↻					
0204	<b>102 581</b>								→ 48	0204 <b>104 144</b> <sup>7</sup>				
0204	<b>103 581</b>								↻					
0986	<b>135 020</b>								↻					
									PR-Code 1LQ, PR-Code 1LR	252	0986	<b>473 071</b>	↻ ← 54	1987 <b>470 506</b> <sup>8</sup>
											0986	<b>474 071</b>	↻ → 54	1987 <b>470 506</b> <sup>8</sup>
											0986	<b>473 071</b>	↻ → 54	1987 <b>470 506</b> <sup>8</sup>

	S														
	1.4	09.00-12.07	74	PR-Code 1LB, PR-Code 1LM, PR-Code 1ZN		0 204 102 580	← 48	0 204 104 144 <sup>7</sup>							
						0 986 134 020									
						0 204 102 581	→ 48	0 204 104 144 <sup>7</sup>							
						0 204 103 581									
						0 986 135 020									
						PR-Code 1LN	288	0 986 473 192		← 54	1 987 470 287 <sup>7</sup>				
								0 986 474 192		→ 54	1 987 470 287 <sup>7</sup>				
						PR-Code 1LQ, PR-Code 1LR	252	0 986 473 071		← 54	1 987 470 506 <sup>8</sup>				
								0 986 474 071		→ 54	1 987 470 506 <sup>8</sup>				
						1.4 TDI	12.99-12.07	50/51/55/59	PR-Code 1LB, PR-Code 1LM, PR-Code 1ZN		0 204 102 580	← 48	0 204 104 144 <sup>7</sup>		
0 986 134 020															
0 204 102 581	→ 48	0 204 104 144 <sup>7</sup>													
0 204 103 581															
0 986 135 020															
PR-Code 1LQ, PR-Code 1LR	252	0 986 473 071		← 54	1 987 470 506 <sup>8</sup>										
		0 986 474 071		→ 54	1 987 470 506 <sup>8</sup>										
1.9 SDI	08.00-12.07	47			0 204 102 580						← 48	0 204 104 144 <sup>7</sup>			
					0 986 134 020										
					0 204 102 581						→ 48	0 204 104 144 <sup>7</sup>			
					0 204 103 581										
					0 986 135 020										
					1.9 TDI	08.00-12.07	74	PR-Code 1LB, PR-Code 1LM, PR-Code 1ZN		0 204 102 580	← 48	0 204 104 144 <sup>7</sup>			
										0 986 134 020					
										0 204 102 581	→ 48	0 204 104 144 <sup>7</sup>			
										0 204 103 581					
										0 986 135 020					
PR-Code 1LN	288	0 986 473 192		← 54						1 987 470 287 <sup>7</sup>					
		0 986 474 192		→ 54						1 987 470 287 <sup>7</sup>					
PR-Code 1LQ, PR-Code 1LR	252	0 986 473 071		← 54						1 987 470 506 <sup>8</sup>					
		0 986 474 071		→ 54						1 987 470 506 <sup>8</sup>					
2.0	09.00-12.07	85								0 986 473 192	← 54	1 987 470 287 <sup>7</sup>			
					0 986 474 192		→ 54	1 987 470 287 <sup>7</sup>							
	1.2	08.02-12.07	40/47			0 986 475 433	↔ 19,05								
						1.4, TDI	12.99-12.07	44/50/51/55/59			0 986 475 433	↔ 19,05			
											1.9 SDI	08.00-12.07	47		
	1.4	09.00-12.07	74			0 986 473 099		← 38,1	1 987 470 040 <sup>7</sup>						
						0 986 474 099		→ 38,1	1 987 470 040 <sup>7</sup>						
	1.9 TDI	08.00-12.07	74				0 986 473 099		← 38,1	1 987 470 040 <sup>7</sup>					
							0 986 474 099		→ 38,1	1 987 470 040 <sup>7</sup>					
	2.0	09.00-12.07	85				0 986 473 099		← 38,1	1 987 470 040 <sup>7</sup>					
							0 986 474 099		→ 38,1	1 987 470 040 <sup>7</sup>					
	1.2	08.02-12.07	40/47			SSZ		1 987 482 446	↔ 1580						
						SSZ		1 987 477 806	↔ 1580						
						1.4	12.99-12.07	44/50/51/55/59			SSZ		1 987 482 446	↔ 1580	
											SSZ		1 987 477 806	↔ 1580	
							09.00-12.07	74			SSZ		1 987 482 191	↔ 1645	
											SSZ		1 987 477 807	↔ 1640	
						1.4 TDI	05.03-12.07	44/50/51/55/59				SSZ		1 987 482 446	↔ 1580
												SSZ		1 987 477 806	↔ 1580
						1.9 SDI	08.00-12.07	47				SSZ		1 987 482 446	↔ 1580
												SSZ		1 987 477 806	↔ 1580
						1.9 TDI	08.00-12.07	74				SSZ		1 987 482 191	↔ 1645
												SSZ		1 987 477 807	↔ 1640
2.0	09.00-12.07	85				SSZ		1 987 482 191	↔ 1645						
						SSZ		1 987 477 807	↔ 1640						





◀ SKODA Fabia Combi [6Y5]

	1.2	08.02-12.07	40/47	LAB	0 986 594 500 <sup>3</sup>		
				RAB	0 986 594 502 <sup>4</sup>		
	1.4	12.99-12.07	44/50/51/ 55/59/74	LAB	0 986 594 501 <sup>3</sup>		
				RAB	0 986 594 503 <sup>4</sup>		
	1.9 SDI	08.00-12.07	47/74	LAB	0 986 594 502 <sup>4</sup>		
				RAB	0 986 594 503 <sup>4</sup>		
	1.9 TDI	08.00-12.07	47/74	LAB	0 986 594 501 <sup>3</sup>		
				RAB	0 986 594 503 <sup>4</sup>		
	2.0	09.00-12.07	85	LAB	0 986 594 502 <sup>4</sup>		
				RAB	0 986 594 503 <sup>4</sup>		

Fabia [NJ3]

	1.0 MPI	08.14→	44/55	PR-Code 1ZC	288	0 986 473 384	← 53,94	F 026 A06 106 <sup>7</sup>
				PR-Code 1ZG	252	0 986 474 384	→ 53,94	F 026 A06 106 <sup>7</sup>
	1.2 TSI	08.14→	66/81	PR-Code 1ZC	288	0 986 473 071	← 54	
				PR-Code 1ZG, PR-Code 1ZC	252,288	0 986 474 071	→ 54	1 987 470 506 <sup>8</sup>
	1.4 TDI	08.14→	66/77	PR-Code 1ZC	288	0 986 473 384	← 53,94	F 026 A06 106 <sup>7</sup>
				PR-Code 1ZG	252	0 986 474 384	→ 53,94	F 026 A06 106 <sup>7</sup>
	1.4 TDI	08.14→	66/77	PR-Code 1ZC	288	0 986 473 071	← 54	
				PR-Code 1ZG, PR-Code 1ZC	252,288	0 986 474 071	→ 54	1 987 470 506 <sup>8</sup>

	1.0 MPI	08.14→	44/55			0 986 475 433	↔ 19,05	
	1.2 TSI	08.14→	66/81			0 986 475 433	↔ 19,05	
	1.4 TDI	08.14→	66/77			0 986 475 433	↔ 19,05	

	1.0 MPI	08.14→	44/55					1 987 470 040 <sup>7</sup>
	1.2 TSI	08.14→	66/81					1 987 470 040 <sup>7</sup>
	1.4 TDI	08.14→	66/77					1 987 470 040 <sup>7</sup>

	1.0 MPI	08.14→	44/55		FMU,HTB	1 987 482 266	↔ 1588	
	1.2 TSI	08.14→	66/81		FMU,HTB	1 987 482 266	↔ 1588	
	1.4 TDI	08.14→	66/77		FMU,HTB	1 987 482 266	↔ 1588	

	1.0 MPI	08.14→	44/55	LAB	0 986 594 500 <sup>3</sup>		
				RAB	0 986 594 502 <sup>4</sup>		
	1.2 TSI	08.14→	66/81	LAB	0 986 594 501 <sup>3</sup>		
				RAB	0 986 594 503 <sup>4</sup>		

		S							
1.4 TDI		08.14→	66/77			LAB	0 986 594 500 <sup>3</sup>		
							0 986 594 502 <sup>4</sup>		
						RAB	0 986 594 501 <sup>3</sup>		
							0 986 594 503 <sup>4</sup>		
<b>Fabia RS [5J2]</b>									
	1.4 TSI	05.10-05.12	132						F 026 A06 106 <sup>7</sup>
						PR-Code 1ZC	BSR	0 986 473 384	↔ 53,94
								0 986 474 384	↔ 53,94
						PR-Code 1ZD	BSR	0 986 473 384	↔ 53,94
								0 986 474 384	↔ 53,94
	1.4 TSI	05.10-05.12	132						1 987 470 040 <sup>7</sup>
	1.4 TSI	05.10-05.12	132			SSZ	1 987 482 451	↔ 1645	
						SSZ	1 987 477 807	↔ 1640	
	1.4 TSI	05.10-05.12	132			LAB	0 986 594 500 <sup>3</sup>		
							0 986 594 502 <sup>4</sup>		
						RAB	0 986 594 501 <sup>3</sup>		
							0 986 594 503 <sup>4</sup>		
<b>Fabia Schrägheck [6Y2]</b>									
	1.0	09.99-08.02	37				0 204 102 580	← 48	0 204 104 144 <sup>7</sup>
							0 986 134 020	↔	
							0 204 102 581	→ 48	0 204 104 144 <sup>7</sup>
							0 204 103 581	↔	
							0 986 135 020	↔	
						252	0 986 473 071	↔ 54	1 987 470 506 <sup>8</sup>
							0 986 474 071	↔ 54	1 987 470 506 <sup>8</sup>
	1.2	07.01-04.07	40/47				0 204 102 580	← 48	0 204 104 144 <sup>7</sup>
							0 986 134 020	↔	
							0 204 102 581	→ 48	0 204 104 144 <sup>7</sup>
							0 204 103 581	↔	
							0 986 135 020	↔	
						252	0 986 473 071	↔ 54	1 987 470 506 <sup>8</sup>
							0 986 474 071	↔ 54	1 987 470 506 <sup>8</sup>
	1.4	09.99-04.07	74			PR-Code 1LB, PR-Code 1LM, PR-Code 1ZN	0 204 102 580	← 48	0 204 104 144 <sup>7</sup>
							0 986 134 020	↔	
							0 204 102 581	→ 48	0 204 104 144 <sup>7</sup>
							0 204 103 581	↔	
							0 986 135 020	↔	
						PR-Code 1LN	288	0 986 473 192	↔ 54
								0 986 474 192	↔ 54
						PR-Code 1LQ, PR-Code 1LR	252	0 986 473 071	↔ 54
								0 986 474 071	↔ 54
		04.00-03.03	44			PR-Code 1LM	0 204 102 580	← 48	0 204 104 144 <sup>7</sup>
							0 986 134 020	↔	
							0 204 102 581	→ 48	0 204 104 144 <sup>7</sup>
							0 204 103 581	↔	
							0 986 135 020	↔	
						PR-Code 1LQ, PR-Code 1LR	252	0 986 473 071	↔ 54
								0 986 474 071	↔ 54



		S							
<b>SKODA Fabia Schrägheck [6Y2]</b>									
<b>1.4</b>	09.99-04.07	50/51/55/	PR-Code 1LB, PR-Code 1LM, PR-Code 1ZN	0 204 102 580	← 48	0 204 104 144 <sup>7</sup>			
<b>1.4 TDI</b>		59		0 986 134 020					
				0 204 102 581	→ 48	0 204 104 144 <sup>7</sup>			
				0 204 103 581					
				0 986 135 020					
			PR-Code 1LQ, PR-Code 1LR	252	0 986 473 071	← 54	1 987 470 506 <sup>8</sup>		
					0 986 474 071	→ 54	1 987 470 506 <sup>8</sup>		
<b>1.9 SDI</b>	09.99-03.08	47		0 204 102 580	← 48	0 204 104 144 <sup>7</sup>			
				0 986 134 020					
				0 204 102 581	→ 48	0 204 104 144 <sup>7</sup>			
				0 204 103 581					
				0 986 135 020					
				252	0 986 473 071	← 54	1 987 470 506 <sup>8</sup>		
					0 986 474 071	→ 54	1 987 470 506 <sup>8</sup>		
<b>1.9 TDI</b>	09.99-04.07	74	PR-Code 1LB, PR-Code 1LM, PR-Code 1ZN	0 204 102 580	← 48	0 204 104 144 <sup>7</sup>			
				0 986 134 020					
				0 204 102 581	→ 48	0 204 104 144 <sup>7</sup>			
				0 204 103 581					
				0 986 135 020					
			PR-Code 1LN	288	0 986 473 192	← 54	1 987 470 287 <sup>7</sup>		
					0 986 474 192	→ 54	1 987 470 287 <sup>7</sup>		
			PR-Code 1LQ, PR-Code 1LR	252	0 986 473 071	← 54	1 987 470 506 <sup>8</sup>		
					0 986 474 071	→ 54	1 987 470 506 <sup>8</sup>		
<b>1.9 TDI RS</b>	06.03-04.07	96					1 987 470 287 <sup>7</sup>		
							1 987 470 287 <sup>7</sup>		
<b>2.0</b>	07.00-04.07	85					1 987 470 287 <sup>7</sup>		
							0 986 473 192	← 54	1 987 470 287 <sup>7</sup>
							0 986 474 192	→ 54	1 987 470 287 <sup>7</sup>
	<b>1.0</b>	09.99-08.02	37				0 986 475 433	↔ 19,05	
	<b>1.2</b>	07.01-04.07	40/47				0 986 475 433	↔ 19,05	
	<b>1.4, TDI</b>	09.99-04.07	44/50/51/55/59				0 986 475 433	↔ 19,05	
	<b>1.9 SDI</b>	09.99-03.08	47				0 986 475 433	↔ 19,05	
	<b>1.4</b>	09.99-04.07	74				0 986 473 099	← 38,1	1 987 470 040 <sup>7</sup>
							0 986 474 099	→ 38,1	1 987 470 040 <sup>7</sup>
	<b>1.9 TDI</b>	09.99-04.07	74				0 986 473 099	← 38,1	1 987 470 040 <sup>7</sup>
							0 986 474 099	→ 38,1	1 987 470 040 <sup>7</sup>
	<b>1.9 TDI RS</b>	06.03-04.07	96		KZG				1 987 470 040 <sup>7</sup>
									1 987 474 496 <sup>8</sup>
					KZR				1 987 470 040 <sup>7</sup>
									1 987 474 496 <sup>8</sup>
	<b>2.0</b>	07.00-04.07	85				0 986 473 099	← 38,1	1 987 470 040 <sup>7</sup>
							0 986 474 099	→ 38,1	1 987 470 040 <sup>7</sup>
	<b>1.0</b>	09.99-08.02	37		SSZ		1 987 482 446	↔ 1580	
					SSZ		1 987 477 806	↔ 1580	
	<b>1.2</b>	07.01-04.07	40/47		SSZ		1 987 482 446	↔ 1580	
					SSZ		1 987 477 806	↔ 1580	
	<b>1.4</b>	09.99-04.07	44/50/51/		SSZ		1 987 482 446	↔ 1580	
			55/59		SSZ		1 987 477 806	↔ 1580	
			74		SSZ		1 987 482 191	↔ 1645	
					SSZ		1 987 477 807	↔ 1640	
	<b>1.4 TDI</b>	05.03-04.07	44/50/51/		SSZ		1 987 482 446	↔ 1580	
			55/59		SSZ		1 987 477 806	↔ 1580	
	<b>1.9 SDI</b>	09.99-03.08	47		SSZ		1 987 482 446	↔ 1580	
					SSZ		1 987 477 806	↔ 1580	
	<b>1.9 TDI</b>	09.99-04.07	74/96		SSZ		1 987 482 191	↔ 1645	
					SSZ		1 987 477 807	↔ 1640	
	<b>1.9 TDI RS</b>	06.03-04.07	74/96		SSZ		1 987 482 191	↔ 1645	
					SSZ		1 987 477 807	↔ 1640	

		<b>S</b>							
2.0		07.00-04.07	85			SSZ	1 987 482 191	↔ 1645	
						SSZ	1 987 477 807	↔ 1640	
1.0		09.99-08.02	37			LAB	0 986 594 500 <sup>3</sup>		
							0 986 594 502 <sup>4</sup>		
						RAB	0 986 594 501 <sup>3</sup>		
							0 986 594 503 <sup>4</sup>		
1.2		07.01-04.07	40/47			LAB	0 986 594 500 <sup>3</sup>		
							0 986 594 502 <sup>4</sup>		
						RAB	0 986 594 501 <sup>3</sup>		
							0 986 594 503 <sup>4</sup>		
1.4		09.99-04.07	44/50/51/			LAB	0 986 594 500 <sup>3</sup>		
1.4 TDI			55/59/74				0 986 594 502 <sup>4</sup>		
						RAB	0 986 594 501 <sup>3</sup>		
							0 986 594 503 <sup>4</sup>		
1.9 SDI		09.99-03.08	47/74/96			LAB	0 986 594 500 <sup>3</sup>		
1.9 TDI							0 986 594 502 <sup>4</sup>		
1.9 TDI RS						RAB	0 986 594 501 <sup>3</sup>		
							0 986 594 503 <sup>4</sup>		
2.0		07.00-04.07	85			LAB	0 986 594 500 <sup>3</sup>		
							0 986 594 502 <sup>4</sup>		
						RAB	0 986 594 501 <sup>3</sup>		
							0 986 594 503 <sup>4</sup>		

**Fabia [5J2]**

1.2		12.06-05.09	44	PR-Code 1LQ, PR-Code 1LR, PR-Code 1ZG	252		0 986 473 071	↔ 54	1 987 470 506 <sup>B</sup>
							0 986 474 071	↔ 54	1 987 470 506 <sup>B</sup>
		12.06-03.10	44	PR-Code 1LB, PR-Code 1LM			0 204 102 580	← 48	0 204 104 144 <sup>7</sup>
							0 986 134 020	↔	
							0 204 102 581	→ 48	0 204 104 144 <sup>7</sup>
							0 204 103 581	↔	
							0 986 135 020	↔	
		01.07-09.10	51	PR-Code 1LB, PR-Code 1LM			0 204 102 580	← 48	0 204 104 144 <sup>7</sup>
							0 986 134 020	↔	
							0 204 102 581	→ 48	0 204 104 144 <sup>7</sup>
							0 204 103 581	↔	
							0 986 135 020	↔	
		01.07-12.14	51	PR-Code 1LQ, PR-Code 1LR, PR-Code 1ZG	252		0 986 473 071	↔ 54	1 987 470 506 <sup>B</sup>
							0 986 474 071	↔ 54	1 987 470 506 <sup>B</sup>
		01.08-09.10	51	PR-Code 1LN, PR-Code 1ZH	288		0 986 473 192	↔ 54	1 987 470 287 <sup>7</sup>
							0 986 474 192	↔ 54	1 987 470 287 <sup>7</sup>
		03.09-06.09	51				0 204 102 580	← 48	0 204 104 144 <sup>7</sup>
							0 986 134 020	↔	
							0 204 102 581	→ 48	0 204 104 144 <sup>7</sup>
							0 204 103 581	↔	
							0 986 135 020	↔	
					252		0 986 473 071	↔ 54	1 987 470 506 <sup>B</sup>
							0 986 474 071	↔ 54	1 987 470 506 <sup>B</sup>
		03.09-03.10	44	PR-Code 1LN, PR-Code 1ZH	288		0 986 473 192	↔ 54	1 987 470 287 <sup>7</sup>
							0 986 474 192	↔ 54	1 987 470 287 <sup>7</sup>
				PR-Code 1LQ, PR-Code 1LR	252		0 986 473 071	↔ 54	1 987 470 506 <sup>B</sup>
							0 986 474 071	↔ 54	1 987 470 506 <sup>B</sup>
		03.09-11.11	44	PR-Code 1ZG	252		0 986 473 071	↔ 54	1 987 470 506 <sup>B</sup>
							0 986 474 071	↔ 54	1 987 470 506 <sup>B</sup>
		04.10-11.11	44	PR-Code 1ZC	288		0 986 473 384	↔ 53,94	F 026 A06 106 <sup>7</sup>
							0 986 473 384	↔ 53,94	1 987 470 506 <sup>B</sup>
							0 986 474 384	↔ 53,94	F 026 A06 106 <sup>7</sup>
		11.11-12.14	44	PR-Code 1ZG			0 986 473 071	↔ 54	1 987 470 506 <sup>B</sup>
							0 986 474 071	↔ 54	1 987 470 506 <sup>B</sup>
1.2		03.10-12.14	55/63/77	PR-Code 1LQ, PR-Code 1LR, PR-Code 1ZG	252		0 986 473 071	↔ 54	1 987 470 506 <sup>B</sup>
1.2 TDI							0 986 474 071	↔ 54	1 987 470 506 <sup>B</sup>





	◀ SKODA Fabia [5J2]								
1.2	03.10-12.14	55/63/77	PR-Code 1ZC	288	0986 473 384	↔ 53,94	F 026 A06 106 <sup>7</sup>		
1.2 TDI					0986 473 384	↔ 53,94	1987 470 506 <sup>8</sup>		
					0986 474 384	↔ 53,94	F 026 A06 106 <sup>7</sup>		
1.4	01.07-03.10	63	PR-Code 1LN, PR-Code 1ZH	288	0986 473 192	↔ 54	1987 470 287 <sup>7</sup>		
	01.07-12.14	63	PR-Code 1LQ, PR-Code 1LR, PR-Code 1ZG	252	0986 473 071	↔ 54	1987 470 506 <sup>8</sup>		
	03.10-12.14	63	PR-Code 1ZC	288	0986 474 071	↔ 54	1987 470 506 <sup>8</sup>		
					0986 473 384	↔ 53,94	F 026 A06 106 <sup>7</sup>		
					0986 473 384	↔ 53,94	1987 470 506 <sup>8</sup>		
					0986 474 384	↔ 53,94	F 026 A06 106 <sup>7</sup>		
1.4 TDI	01.07-03.10	51/59	PR-Code 1LB, PR-Code 1LM		0204 102 580	↔ 48	0204 104 144 <sup>7</sup>		
					0986 134 020				
					0204 102 581	↔ 48	0204 104 144 <sup>7</sup>		
					0204 103 581				
					0986 135 020				
			PR-Code 1LQ, PR-Code 1LR, PR-Code 1ZG	252	0986 473 071	↔ 54	1987 470 506 <sup>8</sup>		
					0986 474 071	↔ 54	1987 470 506 <sup>8</sup>		
1.4 TSI RS	05.12-12.14	132					F 026 A06 106 <sup>7</sup>		
							1987 470 506 <sup>8</sup>		
			PR-Code 1ZC	BSR	0986 473 384	↔ 53,94			
					0986 474 384	↔ 53,94			
			PR-Code 1ZD	BSR	0986 473 384	↔ 53,94			
					0986 474 384	↔ 53,94			
1.6	04.07-07.10	77	PR-Code 1LN, PR-Code 1ZH	288	0986 473 192	↔ 54	1987 470 287 <sup>7</sup>		
	06.10-12.14	77	PR-Code 1ZC	288	0986 474 192	↔ 54	1987 470 287 <sup>7</sup>		
					0986 473 384	↔ 53,94	F 026 A06 106 <sup>7</sup>		
					0986 474 384	↔ 53,94	F 026 A06 106 <sup>7</sup>		
1.6	04.07-12.14	77	PR-Code 1LQ, PR-Code 1LR, PR-Code 1ZG	252	0986 473 071	↔ 54	1987 470 506 <sup>8</sup>		
1.6 TDI					0986 474 071	↔ 54	1987 470 506 <sup>8</sup>		
	03.10-12.14	77	PR-Code 1ZC	288	0986 473 384	↔ 53,94	1987 470 506 <sup>8</sup>		
1.6 TDI	03.10-12.14	55/66	PR-Code 1LQ, PR-Code 1LR, PR-Code 1ZG	252	0986 473 071	↔ 54	1987 470 506 <sup>8</sup>		
					0986 474 071	↔ 54	1987 470 506 <sup>8</sup>		
					0986 473 384	↔ 53,94	F 026 A06 106 <sup>7</sup>		
					0986 473 384	↔ 53,94	1987 470 506 <sup>8</sup>		
					0986 474 384	↔ 53,94	F 026 A06 106 <sup>7</sup>		
		77	PR-Code 1ZC	288	0986 473 384	↔ 53,94	F 026 A06 106 <sup>7</sup>		
					0986 474 384	↔ 53,94	1987 470 506 <sup>8</sup>		
1.9 TDI	04.07-03.10	77	PR-Code 1LN, PR-Code 1ZH	288	0986 473 192	↔ 54	1987 470 287 <sup>7</sup>		
					0986 474 192	↔ 54	1987 470 287 <sup>7</sup>		
			PR-Code 1LQ, PR-Code 1LR, PR-Code 1ZG	252	0986 473 071	↔ 54	1987 470 506 <sup>8</sup>		
					0986 474 071	↔ 54	1987 470 506 <sup>8</sup>		
	1.2	12.06-06.09	44/51		0986 475 433	↔ 19,05			
		01.08-12.14	44/51	PR-Code 1KM	0986 475 433	↔ 19,05			
	1.2, TDI	03.10-12.14	55/63/77	PR-Code 1KM	0986 475 433	↔ 19,05			
	1.4	01.07-03.10	63		0986 475 433	↔ 19,05			
		03.10-12.14	63	PR-Code 1KM	0986 475 433	↔ 19,05			
	1.4 TDI	01.07-03.10	59		0986 475 433	↔ 19,05			
		02.07-03.10	51	PR-Code 1KM	0986 475 433	↔ 19,05			
	1.6, TDI	03.10-12.14	55/66/77	PR-Code 1KM	0986 475 433	↔ 19,05			
	1.9 TDI	04.07-03.10	77		0986 475 433	↔ 19,05			
	1.2	12.06-06.09	44/51		0986 473 099	↔ 38,1	1987 470 040 <sup>7</sup>		
					0986 474 099	↔ 38,1	1987 470 040 <sup>7</sup>		
		01.08-05.09	44/51	PR-Code 1KK	BSR	0986 473 099			
					0986 474 099	↔ 38,1			
		01.08-11.11	44/51				1987 470 040 <sup>7</sup>		
	1.2, TDI	03.10-12.14	55/63/77				1987 470 040 <sup>7</sup>		
	1.4	01.07-05.09	51/59/63	PR-Code 1KK	BSR	0986 473 099			
					0986 474 099	↔ 38,1			
	1.4 TDI	01.07-12.14	51/59/63				1987 470 040 <sup>7</sup>		

		S							
<b>1.4 TSI RS</b>		05.12-12.14	132						1 987 470 040 <sup>7</sup>
<b>1.6</b>		04.07-05.09	77	PR-Code 1KK	BSR	0 986 473 099		38,1	
						0 986 474 099		38,1	
<b>1.6 TDI</b>		04.07-12.14	77						1 987 470 040 <sup>7</sup>
<b>1.6 TDI</b>		03.10-12.14	55/66						1 987 470 040 <sup>7</sup>
<b>1.9 TDI</b>		04.07-05.09	77	PR-Code 1KK	BSR	0 986 473 099		38,1	
						0 986 474 099		38,1	
		04.07-03.10	77						1 987 470 040 <sup>7</sup>
<hr/>									
	<b>1.2</b>	12.06-03.07	44		4SB,SSZ	1 987 482 191		1645	
		12.06-11.11	44		HTB,SSZ	1 987 482 446		1580	
					HTB,SSZ	1 987 477 806		1580	
					4SB,SSZ	1 987 477 807		1640	
		01.07-03.07	51		4SB,SSZ	1 987 482 191		1645	
		01.07-09.10	51		4SB,SSZ	1 987 477 807		1640	
		01.07-12.14	51		HTB,SSZ	1 987 482 446		1580	
					HTB,SSZ	1 987 477 806		1580	
		04.07-12.14	44		4SB,SSZ	1 987 482 451		1645	
			51		4SB,SSZ	1 987 482 451		1645	
		03.10-12.14	55/63/77		HTB,SSZ	1 987 482 446		1580	
					HTB,SSZ	1 987 477 806		1580	
					4SB,SSZ	1 987 482 451		1645	
					4SB,SSZ	1 987 477 807		1640	
		11.11-12.14	44	PR-Code 1KM	HTB,SSZ	1 987 482 446		1580	
					HTB,SSZ	1 987 477 806		1580	
<b>1.2 TDI</b>		03.10-12.14	55/63/77		HTB,SSZ	1 987 482 446		1580	
					HTB,SSZ	1 987 477 806		1580	
					4SB,SSZ	1 987 482 451		1645	
					4SB,SSZ	1 987 477 807		1640	
<b>1.4</b>		01.07-03.07	51/59/63		4SB,SSZ	1 987 482 191		1645	
		01.07-12.14	51/59/63		HTB,SSZ	1 987 482 446		1580	
					HTB,SSZ	1 987 477 806		1580	
					4SB,SSZ	1 987 477 807		1640	
		04.07-12.14	51/59/63		4SB,SSZ	1 987 482 451		1645	
<b>1.4 TDI</b>		01.07-03.07	51/59/63		4SB,SSZ	1 987 482 191		1645	
		01.07-03.10	51/59/63		HTB,SSZ	1 987 482 446		1580	
					HTB,SSZ	1 987 477 806		1580	
					4SB,SSZ	1 987 477 807		1640	
		04.07-03.10	51/59/63		4SB,SSZ	1 987 482 451		1645	
<b>1.4 TSI RS</b>		05.12-12.14	132		SSZ	1 987 482 451		1645	
					SSZ	1 987 477 807		1640	
<b>1.6</b>		04.07-12.14	55/66/77		HTB,SSZ	1 987 482 446		1580	
					HTB,SSZ	1 987 477 806		1580	
					4SB,SSZ	1 987 482 451		1645	
					4SB,SSZ	1 987 477 807		1640	
<b>1.6 TDI</b>		03.10-12.14	55/66/77		HTB,SSZ	1 987 482 446		1580	
					HTB,SSZ	1 987 477 806		1580	
					4SB,SSZ	1 987 482 451		1645	
					4SB,SSZ	1 987 477 807		1640	
<b>1.9 TDI</b>		04.07-03.10	77		HTB,SSZ	1 987 482 446		1580	
					HTB,SSZ	1 987 477 806		1580	
					4SB,SSZ	1 987 482 451		1645	
					4SB,SSZ	1 987 477 807		1640	
<hr/>									
	<b>1.2</b>	12.06-12.14	44/51/55/		LAB	0 986 594 500 <sup>3</sup>			
	<b>1.2 TDI</b>		63/77			0 986 594 502 <sup>4</sup>			
					RAB	0 986 594 501 <sup>3</sup>			
						0 986 594 503 <sup>4</sup>			
						0 986 594 504 <sup>4</sup>			
	<b>1.4, TDI, TSI RS</b>	01.07-12.14	51/59/63/		LAB	0 986 594 500 <sup>3</sup>			
			132			0 986 594 502 <sup>4</sup>			



			S							
<b>SKODA Fabia [5J2]</b>										
1.4, TDI, TSI RS	01.07-12.14	51/59/63/132	RAB	0986 <b>594 501</b> <sup>3</sup>						
				0986 <b>594 503</b> <sup>4</sup>						
1.6 1.6 TDI	04.07-12.14	55/66/77	LAB	0986 <b>594 500</b> <sup>3</sup>						
			RAB	0986 <b>594 502</b> <sup>4</sup>						
1.9 TDI	04.07-03.10	77	LAB	0986 <b>594 500</b> <sup>3</sup>						
				0986 <b>594 502</b> <sup>4</sup>						
			RAB	0986 <b>594 501</b> <sup>3</sup>						
				0986 <b>594 503</b> <sup>4</sup>						
<b>Fabia [6Y3]</b>										
1.2	08.02-05.04	40		0 204 <b>102 580</b>	← 48	0 204 <b>104 144</b> <sup>7</sup>				
				0986 <b>134 020</b>						
				0 204 <b>102 581</b>	→ 48	0 204 <b>104 144</b> <sup>7</sup>				
				0 204 <b>103 581</b>						
				0986 <b>135 020</b>						
	02.03-11.04	47		0 204 <b>102 580</b>	← 48	0 204 <b>104 144</b> <sup>7</sup>				
				0986 <b>134 020</b>						
				0 204 <b>102 581</b>	→ 48	0 204 <b>104 144</b> <sup>7</sup>				
				0 204 <b>103 581</b>						
				0986 <b>135 020</b>						
			252	0986 <b>473 071</b>	← 54	1 987 <b>470 506</b> <sup>8</sup>				
				0986 <b>474 071</b>	→ 54	1 987 <b>470 506</b> <sup>8</sup>				
1.4	09.99-12.07	74	PR-Code 1LB, PR-Code 1LM, PR-Code 1ZN	0 204 <b>102 580</b>	← 48	0 204 <b>104 144</b> <sup>7</sup>				
				0986 <b>134 020</b>						
				0 204 <b>102 581</b>	→ 48	0 204 <b>104 144</b> <sup>7</sup>				
				0 204 <b>103 581</b>						
				0986 <b>135 020</b>						
			PR-Code 1LN	288	0986 <b>473 192</b>	← 54	1 987 <b>470 287</b> <sup>7</sup>			
					0986 <b>474 192</b>	→ 54	1 987 <b>470 287</b> <sup>7</sup>			
			PR-Code 1LQ, PR-Code 1LR	252	0986 <b>473 071</b>	← 54	1 987 <b>470 506</b> <sup>8</sup>			
					0986 <b>474 071</b>	→ 54	1 987 <b>470 506</b> <sup>8</sup>			
	04.00-03.03	44	PR-Code 1LM		0 204 <b>102 580</b>	← 48	0 204 <b>104 144</b> <sup>7</sup>			
					0986 <b>134 020</b>					
					0 204 <b>102 581</b>	→ 48	0 204 <b>104 144</b> <sup>7</sup>			
					0 204 <b>103 581</b>					
					0986 <b>135 020</b>					
			PR-Code 1LQ, PR-Code 1LR	252	0986 <b>473 071</b>	← 54	1 987 <b>470 506</b> <sup>8</sup>			
					0986 <b>474 071</b>	→ 54	1 987 <b>470 506</b> <sup>8</sup>			
1.4 1.4 TDI	09.99-12.07	50/51/55/59	PR-Code 1LB, PR-Code 1LM, PR-Code 1ZN	0 204 <b>102 580</b>	← 48	0 204 <b>104 144</b> <sup>7</sup>				
				0986 <b>134 020</b>						
				0 204 <b>102 581</b>	→ 48	0 204 <b>104 144</b> <sup>7</sup>				
				0 204 <b>103 581</b>						
				0986 <b>135 020</b>						
			PR-Code 1LQ, PR-Code 1LR	252	0986 <b>473 071</b>	← 54	1 987 <b>470 506</b> <sup>8</sup>			
					0986 <b>474 071</b>	→ 54	1 987 <b>470 506</b> <sup>8</sup>			
1.9 SDI	09.99-12.07	47		0 204 <b>102 580</b>	← 48	0 204 <b>104 144</b> <sup>7</sup>				
				0986 <b>134 020</b>						
				0 204 <b>102 581</b>	→ 48	0 204 <b>104 144</b> <sup>7</sup>				
				0 204 <b>103 581</b>						
				0986 <b>135 020</b>						
1.9 TDI	09.99-12.07	74	PR-Code 1LB, PR-Code 1LM, PR-Code 1ZN	0 204 <b>102 580</b>	← 48	0 204 <b>104 144</b> <sup>7</sup>				
				0986 <b>134 020</b>						
				0 204 <b>102 581</b>	→ 48	0 204 <b>104 144</b> <sup>7</sup>				
				0 204 <b>103 581</b>						
				0986 <b>135 020</b>						
			PR-Code 1LN	288	0986 <b>473 192</b>	← 54	1 987 <b>470 287</b> <sup>7</sup>			
					0986 <b>474 192</b>	→ 54	1 987 <b>470 287</b> <sup>7</sup>			
			PR-Code 1LQ, PR-Code 1LR	252	0986 <b>473 071</b>	← 54	1 987 <b>470 506</b> <sup>8</sup>			
					0986 <b>474 071</b>	→ 54	1 987 <b>470 506</b> <sup>8</sup>			

		S							
2.0		07.00-12.07	85				0 986 473 192	← 54	1 987 470 287 <sup>7</sup>
							0 986 474 192	→ 54	1 987 470 287 <sup>7</sup>
	1.2	08.02-11.04	40/47				0 986 475 433	↔ 19,05	
	1.4 TDI	09.99-12.07	44/50/51/55/59				0 986 475 433	↔ 19,05	
	1.9 SDI	09.99-12.07	47				0 986 475 433	↔ 19,05	
	1.4	09.99-12.07	74				0 986 473 099	← 38,1	1 987 470 040 <sup>7</sup>
							0 986 474 099	→ 38,1	1 987 470 040 <sup>7</sup>
	1.9 TDI	09.99-12.07	74				0 986 473 099	← 38,1	1 987 470 040 <sup>7</sup>
							0 986 474 099	→ 38,1	1 987 470 040 <sup>7</sup>
	2.0	07.00-12.07	85				0 986 473 099	← 38,1	1 987 470 040 <sup>7</sup>
							0 986 474 099	→ 38,1	1 987 470 040 <sup>7</sup>
	1.2	08.02-11.04	40/47		SSZ		1 987 482 446	↔ 1580	
					SSZ		1 987 477 806	↔ 1580	
	1.4	09.99-12.07	44/50/51/55/59		SSZ		1 987 482 446	↔ 1580	
			74		SSZ		1 987 477 806	↔ 1580	
					SSZ		1 987 482 191	↔ 1645	
					SSZ		1 987 477 807	↔ 1640	
	1.4 TDI	05.03-12.07	44/50/51/55/59		SSZ		1 987 482 446	↔ 1580	
					SSZ		1 987 477 806	↔ 1580	
	1.9 SDI	09.99-12.07	47		SSZ		1 987 482 446	↔ 1580	
					SSZ		1 987 477 806	↔ 1580	
	1.9 TDI	09.99-12.07	74		SSZ		1 987 482 191	↔ 1645	
					SSZ		1 987 477 807	↔ 1640	
	2.0	07.00-12.07	85		SSZ		1 987 482 191	↔ 1645	
					SSZ		1 987 477 807	↔ 1640	
	1.2	08.02-11.04	40/47		LAB		0 986 594 500 <sup>3</sup>		
							0 986 594 502 <sup>4</sup>		
					RAB		0 986 594 501 <sup>3</sup>		
							0 986 594 503 <sup>4</sup>		
	1.4	09.99-12.07	44/50/51/55/59/74		LAB		0 986 594 500 <sup>3</sup>		
	1.4 TDI						0 986 594 502 <sup>4</sup>		
					RAB		0 986 594 501 <sup>3</sup>		
							0 986 594 503 <sup>4</sup>		
	1.9 SDI	09.99-12.07	47/74		LAB		0 986 594 500 <sup>3</sup>		
	1.9 TDI						0 986 594 502 <sup>4</sup>		
					RAB		0 986 594 501 <sup>3</sup>		
							0 986 594 503 <sup>4</sup>		
	2.0	07.00-12.07	85		LAB		0 986 594 500 <sup>3</sup>		
							0 986 594 502 <sup>4</sup>		
					RAB		0 986 594 501 <sup>3</sup>		
							0 986 594 503 <sup>4</sup>		
<b>Favorit</b>									
	135	09.88-09.94	40/43				0 986 473 112	← 53,95	1 987 470 507 <sup>8</sup>
							0 986 474 112	→ 53,95	1 987 470 507 <sup>8</sup>
	136	09.88-12.98	40/46/50				0 986 473 112	← 53,95	1 987 470 507 <sup>8</sup>
	136 i.e.						0 986 474 112	→ 53,95	1 987 470 507 <sup>8</sup>
	135	09.88-09.94	40/43				0 986 475 769	▲ ↔ 19	
	136, i.e.	09.88-12.98	40/46/50				0 986 475 769	▲ ↔ 19	



◀ SKODA Favorit								
	135	01.93-09.94	40/43			1987 477 690	1752	
	136, i.e.	01.93-12.98	40/46/50			1987 477 690	1752	
<b>Felicia Combi [6U5]</b>								
	1.3	10.94-08.01	40/42/43/			0986 473 112	← 53,95	1987 470 507 <sup>8</sup>
	1.3i		50			0986 474 112	→ 53,95	1987 470 507 <sup>8</sup>
	1.6i	10.95-08.01	55			0986 473 112	← 53,95	1987 470 507 <sup>8</sup>
						0986 474 112	→ 53,95	1987 470 507 <sup>8</sup>
	1.9D	10.95-08.01	47			0986 473 112	← 53,95	1987 470 507 <sup>8</sup>
						0986 474 112	→ 53,95	1987 470 507 <sup>8</sup>
	1.3	10.94-08.01	40/42/43/			0986 475 769	▲ ↔ 19	
	1.3i		50			0986 475 865	↔ 22,2	
	1.6i	10.95-08.01	55			0986 475 769	▲ ↔ 19	
						0986 475 864	↔ 20,6	
						0986 475 865	↔ 22,2	
	1.9D	10.95-08.01	47			0986 475 769	▲ ↔ 19	
						0986 475 864	↔ 20,6	
						0986 475 865	↔ 22,2	
	1.3	10.94-08.01	40/42/43/50			1987 477 690	↔ 1752	
	1.3i	10.94-08.01	40/42/43/50			1987 477 690	↔ 1752	
	1.6i	10.95-08.01	55			1987 477 690	↔ 1752	
	1.9D	10.95-08.01	47			1987 477 690	↔ 1752	
<b>Felicia Fun [6UF]</b>								
	1.3	08.96-03.01	50			0986 473 112	← 53,95	1987 470 507 <sup>8</sup>
						0986 474 112	→ 53,95	1987 470 507 <sup>8</sup>
	1.6	08.96-03.01	55			0986 473 112	← 53,95	1987 470 507 <sup>8</sup>
						0986 474 112	→ 53,95	1987 470 507 <sup>8</sup>
	1.9D	08.96-03.01	47			0986 473 112	← 53,95	1987 470 507 <sup>8</sup>
						0986 474 112	→ 53,95	1987 470 507 <sup>8</sup>
	1.3	08.96-03.01	50			0986 475 769	▲ ↔ 19	
						0986 475 865	↔ 22,2	
	1.6	08.96-03.01	55			0986 475 769	▲ ↔ 19	
						0986 475 865	↔ 22,2	
	1.9D	08.96-03.01	47			0986 475 769	▲ ↔ 19	
						0986 475 865	↔ 22,2	
	1.3	08.96-03.01	50			1987 477 690	↔ 1752	
	1.6	08.96-03.01	55			1987 477 690	↔ 1752	
	1.9D	08.96-03.01	47			1987 477 690	↔ 1752	
	1.3	08.96-03.01	50			0986 594 004 <sup>4</sup>		
	1.6	08.96-03.01	55			0986 594 004 <sup>4</sup>		
	1.9D	08.96-03.01	47			0986 594 004 <sup>4</sup>		

<b>Felicia [6U1]</b>								
	<b>1.3</b>	10.94-08.01	40/42/43/			0 986 473 112	← 53,95	1 987 470 507 <sup>8</sup>
	<b>1.3i</b>		50			0 986 474 112	→ 53,95	1 987 470 507 <sup>8</sup>
	<b>1.6i</b>	05.95-08.01	55			0 986 473 112	← 53,95	1 987 470 507 <sup>8</sup>
						0 986 474 112	→ 53,95	1 987 470 507 <sup>8</sup>
	<b>1.9D</b>	10.95-08.01	47			0 986 473 112	← 53,95	1 987 470 507 <sup>8</sup>
						0 986 474 112	→ 53,95	1 987 470 507 <sup>8</sup>
	<b>1.3</b>	10.94-08.01	40/42/43/			0 986 475 769	▲ ↔ 19	
	<b>1.3i</b>		50			0 986 475 865	↔ 22,2	
	<b>1.6i</b>	05.95-08.01	55			0 986 475 769	▲ ↔ 19	
						0 986 475 864	↔ 20,6	
	<b>1.9D</b>	10.95-08.01	47			0 986 475 865	↔ 22,2	
						0 986 475 769	▲ ↔ 19	
						0 986 475 864	↔ 20,6	
						0 986 475 865	↔ 22,2	
	<b>1.3</b>	10.94-08.01	40/42/43/50			1 987 477 690	↔ 1752	
	<b>1.3i</b>	10.94-08.01	40/42/43/50			1 987 477 690	↔ 1752	
	<b>1.6i</b>	05.95-08.01	55			1 987 477 690	↔ 1752	
	<b>1.9D</b>	10.95-08.01	47			1 987 477 690	↔ 1752	
<b>Forman</b>								
	<b>1.1</b>	10.90-12.95	38			0 986 473 112	← 53,95	1 987 470 507 <sup>8</sup>
	<b>1.3</b>	10.90-12.95	40/45/50			0 986 474 112	→ 53,95	1 987 470 507 <sup>8</sup>
	<b>1.3i.e.</b>					0 986 473 112	← 53,95	1 987 470 507 <sup>8</sup>
						0 986 474 112	→ 53,95	1 987 470 507 <sup>8</sup>
	<b>1.1</b>	10.90-12.95	38			0 986 475 769	▲ ↔ 19	
	<b>1.3</b>	10.90-12.95	45			0 986 475 769	▲ ↔ 19	
	<b>1.3i.e.</b>	07.93-12.95	40			0 986 475 769	▲ ↔ 19	
						0 986 475 865	↔ 22,2	
		09.93-12.95	50			0 986 475 769	▲ ↔ 19	
						0 986 475 865	↔ 22,2	
	<b>1.1</b>	01.93-12.95	38			1 987 477 690		1752
	<b>1.3, i.e.</b>	01.93-12.95	40/45/50			1 987 477 690		1752
<b>Octavia Combi</b>								
	<b>2.0 TDI</b>	05.13→	105					1 987 470 040 <sup>7</sup>
	<b>2.0 TDI</b>	05.13→	105			FPA,GBM	0 986 594 526 <sup>4</sup>	
						LAB	0 986 594 500 <sup>3</sup>	
						RAB	0 986 594 501 <sup>3</sup>	



		S								
◀ SKODA										
<b>Octavia Combi [1U5]</b>										
	1.4	08.00-12.10	55			228,252	0986 473 071	← 54	1987 470 506 <sup>8</sup>	
							0986 474 071	→ 54	1987 470 506 <sup>8</sup>	
	1.6	02.97-12.10	74/75			228,252	0986 473 071	← 54	1987 470 506 <sup>8</sup>	
							0986 474 071	→ 54	1987 470 506 <sup>8</sup>	
							288	0986 471 923	← 54	1987 470 506 <sup>8</sup>
								0986 473 923		
								0986 471 924	→ 54	1987 470 506 <sup>8</sup>
								0986 473 924		
		08.00-09.04	55			228,252	0986 473 071	← 54	1987 470 506 <sup>8</sup>	
							0986 474 071	→ 54	1987 470 506 <sup>8</sup>	
	1.8	10.96-04.99	92			228,252	0986 473 071	← 54	1987 470 506 <sup>8</sup>	
							0986 474 071	→ 54	1987 470 506 <sup>8</sup>	
	1.8 RS	01.03-01.06	132						1987 470 506 <sup>8</sup>	
	1.8 T	03.98-12.10	110			228,252	0986 473 071	← 54	1987 470 506 <sup>8</sup>	
							0986 474 071	→ 54	1987 470 506 <sup>8</sup>	
	1.8 T 4x4					288	0986 471 923	← 54	1987 470 506 <sup>8</sup>	
							0986 473 923			
							0986 471 924	→ 54	1987 470 506 <sup>8</sup>	
							0986 473 924			
	1.9 SDI	05.97-12.03	50			228,252	0986 473 071	← 54	1987 470 506 <sup>8</sup>	
							0986 474 071	→ 54	1987 470 506 <sup>8</sup>	
	1.9 TDI	05.98-03.10	66	PR-Code 1LE, PR-Code 1ZE		288	0986 471 923	← 54	1987 470 506 <sup>8</sup>	
							0986 473 923			
							0986 471 924	→ 54	1987 470 506 <sup>8</sup>	
							0986 473 924			
				PR-Code 1LQ, PR-Code 1LS, PR-Code 1ZM		228,252	0986 473 071	← 54	1987 470 506 <sup>8</sup>	
							0986 474 071	→ 54	1987 470 506 <sup>8</sup>	
	1.9 TDI	08.97-12.10	74/81/96			228,252	0986 473 071	← 54	1987 470 506 <sup>8</sup>	
	1.9 TDI 4x4						0986 474 071	→ 54	1987 470 506 <sup>8</sup>	
						288	0986 471 923	← 54	1987 470 506 <sup>8</sup>	
							0986 473 923			
							0986 471 924	→ 54	1987 470 506 <sup>8</sup>	
							0986 473 924			
	2.0	08.00-01.06	85			228,252	0986 473 071	← 54	1987 470 506 <sup>8</sup>	
	2.0 4x4						0986 474 071	→ 54	1987 470 506 <sup>8</sup>	
						288	0986 471 923	← 54	1987 470 506 <sup>8</sup>	
							0986 473 923			
							0986 471 924	→ 54	1987 470 506 <sup>8</sup>	
							0986 473 924			
	1.4	08.00-12.10	55				0986 475 039	↔ 20,64		
							0986 475 433	↔ 19,05		
	1.6	02.97-12.10	55/74/75				0986 475 039	↔ 20,64		
							0986 475 433	↔ 19,05		
	1.9 SDI	05.97-03.10	50/66/81				0986 475 039	↔ 20,64		
	1.9 TDI						0986 475 433	↔ 19,05		
	1.6	02.97-06.99	74	Fg.-Nr. →1U..Y..294 000		232	0986 473 106	← 41		
							0986 474 106	→ 41		
		07.99-09.04	74	Fg.-Nr. 1U..Y..294 001→		232	0986 473 029	← 41		
							0986 474 029	→ 41		

		S								
<b>1.6</b>		08.00-12.10	75				0 986 473 029		41	1 987 474 496 <sup>B</sup>
							0 986 474 029		41	1 987 474 496 <sup>B</sup>
<b>1.8</b>		10.96-04.99	92				0 986 473 106		41	
							0 986 474 106		41	
<b>1.8 RS</b>		01.03-01.06	132							1 987 470 040 <sup>7</sup>
<b>1.8 T</b>		03.98-06.98	110	Fg.-Nr. →1U..W..129 999	232		0 986 473 072		38	
							0 986 474 072		38	
		03.98-06.99	110	Fg.-Nr. →1U..Y..294 000	232		0 986 473 106		41	
							0 986 474 106		41	
		07.99-12.10	110	Fg.-Nr. 1U..Y..294 001→	232		0 986 473 029		41	
							0 986 474 029		41	
		01.00-12.10	110				0 986 473 029		41	1 987 474 496 <sup>B</sup>
							0 986 474 029		41	1 987 474 496 <sup>B</sup>
<b>1.8 T 4x4</b>		01.00-12.10	110				0 986 473 029		41	1 987 474 496 <sup>B</sup>
							0 986 474 029		41	1 987 474 496 <sup>B</sup>
<b>1.9 SDI</b>		05.97-06.99	50	Fg.-Nr. →1U..Y..294 000	232		0 986 473 106		41	
							0 986 474 106		41	
		07.99-07.00	50	Fg.-Nr. 1U..Y..294 001→	232		0 986 473 029		41	
							0 986 474 029		41	
<b>1.9 TDI</b>		08.97-06.99	81	Fg.-Nr. →1U..Y..294 000	232		0 986 473 106		41	
							0 986 474 106		41	
		05.98-06.99	66	Fg.-Nr. →1U..Y..294 000	232		0 986 473 106		41	
							0 986 474 106		41	
		07.99-01.06	81	Fg.-Nr. 1U..Y..294 001→	232		0 986 473 029		41	
							0 986 474 029		41	
		07.99-12.09	66	Fg.-Nr. 1U..Y..294 001→	232		0 986 473 029		41	
							0 986 474 029		41	
		08.00-01.06	81				0 986 473 029		41	1 987 474 496 <sup>B</sup>
							0 986 474 029		41	1 987 474 496 <sup>B</sup>
		01.03-09.04	96				0 986 473 029		41	1 987 474 496 <sup>B</sup>
							0 986 474 029		41	1 987 474 496 <sup>B</sup>
<b>1.9 TDI</b>		08.00-12.10	74				0 986 473 029		41	1 987 474 496 <sup>B</sup>
<b>1.9 TDI 4x4</b>							0 986 474 029		41	1 987 474 496 <sup>B</sup>
<b>1.9 TDI 4x4</b>		08.00-12.09	66				0 986 473 029		41	1 987 474 496 <sup>B</sup>
							0 986 474 029		41	1 987 474 496 <sup>B</sup>
<b>2.0</b>		08.00-01.06	85				0 986 473 029		41	1 987 474 496 <sup>B</sup>
<b>2.0 4x4</b>							0 986 474 029		41	1 987 474 496 <sup>B</sup>
	<b>1.4</b>	08.00-12.10	55				1 987 477 684		1620	
	<b>1.6</b>	02.97-06.99	74	Fg.-Nr. →1U..Y..294 000		SSZ,TBR	1 987 477 704		1620	
						SSZ,TBR	1 987 482 129		1620	
		02.97-07.00	74	Fg.-Nr. →1U..Y..294 000		SBR	1 987 477 696		1688	
		06.99-09.04	74	Fg.-Nr. 1U..Y..294 001→		TBR	1 987 477 684		1620	
		08.00-09.04	55				1 987 477 684		1620	
			74	Fg.-Nr. 1U..Y..294 001→		SBR	1 987 477 698		1693	
		08.00-12.10	75			SBR	1 987 477 698		1693	
						TBR	1 987 477 684		1620	
<b>1.8</b>		10.96-04.99	92				1 987 477 696		1688	
<b>1.8 RS</b>		01.03-01.06	132				1 987 477 698		1693	
<b>1.8 T</b>		03.98-03.00	110	Fg.-Nr. →1U..Y..294 000			1 987 477 696		1688	
		01.00-01.06	110				1 987 477 698		1693	
		08.00-12.10	110			SSZ	1 987 477 817		1700	
						SSZ	1 987 477 698		1693	
		04.02-12.10	110	Fg.-Nr. 1U..Y..294 001→			1 987 477 698		1693	
<b>1.8 T 4x4</b>		01.00-12.10	110				1 987 477 686		1723	
<b>1.9 SDI</b>		05.97-06.99	50	Fg.-Nr. →1U..Y..294 000		SSZ	1 987 477 704		1620	
						SSZ	1 987 482 129		1620	
		06.99-07.00	50	Fg.-Nr. 1U..Y..294 001→			1 987 477 684		1620	
		08.00-12.03	50				1 987 477 684		1620	
<b>1.9 TDI</b>		08.97-03.00	81	Fg.-Nr. →1U..Y..294 000			1 987 477 696		1688	
		05.98-03.10	66				1 987 477 684		1620	







 SKODA Octavia Combi [1U5]

1.9 TDI	08.00-09.04	74			1987 477 698	↔ 1693
	08.00-01.06	81			1987 477 698	↔ 1693
	01.03-09.04	96			1987 477 698	↔ 1693
	10.05-12.10	74			1987 477 698	↔ 1693
	08.00-01.06	74			1987 477 686	↔ 1723
1.9 TDI 4x4	08.00-01.06	74			1987 477 686	↔ 1723
	08.00-12.09	66			1987 477 686	↔ 1723
2.0	08.00-01.06	85			1987 477 698	↔ 1693
2.0 4x4	08.00-01.06	85			1987 477 686	↔ 1723











1.4	08.00-12.10	55			0986 594 004 <sup>4</sup>	
			LAB		0986 594 001 <sup>3</sup>	
			RAB		0986 594 000 <sup>3</sup>	
1.6	02.97-12.10	55/74/75			0986 594 004 <sup>4</sup>	
			LAB		0986 594 001 <sup>3</sup>	
			RAB		0986 594 000 <sup>3</sup>	
1.8	10.96-04.99	92			0986 594 004 <sup>4</sup>	
			LAB		0986 594 001 <sup>3</sup>	
			RAB		0986 594 000 <sup>3</sup>	
1.8 RS	01.03-01.06	132			0986 594 004 <sup>4</sup>	
			LAB		0986 594 001 <sup>3</sup>	
			RAB		0986 594 000 <sup>3</sup>	
1.8 T	03.98-12.10	110			0986 594 004 <sup>4</sup>	
1.8 T	03.98-12.10	110		LAB	0986 594 001 <sup>3</sup>	
1.8 T 4x4				RAB	0986 594 000 <sup>3</sup>	
1.8 T 4x4	01.00-12.10	110			0986 594 008 <sup>4</sup>	
1.9 SDI	05.97-12.03	50			0986 594 004 <sup>4</sup>	
			LAB		0986 594 001 <sup>3</sup>	
			RAB		0986 594 000 <sup>3</sup>	
1.9 TDI	08.97-01.06	81/96			0986 594 004 <sup>4</sup>	
			LAB		0986 594 001 <sup>3</sup>	
			RAB		0986 594 000 <sup>3</sup>	
	05.98-12.10	66/74			0986 594 004 <sup>4</sup>	
1.9 TDI	05.98-12.10	66/74		LAB	0986 594 001 <sup>3</sup>	
1.9 TDI 4x4				RAB	0986 594 000 <sup>3</sup>	
1.9 TDI 4x4	08.00-12.09	66/74			0986 594 008 <sup>4</sup>	
2.0	08.00-01.06	85			0986 594 004 <sup>4</sup>	
2.0	08.00-01.06	85		LAB	0986 594 001 <sup>3</sup>	
2.0 4x4				RAB	0986 594 000 <sup>3</sup>	
2.0 4x4	11.99-12.00	88			0986 594 004 <sup>4</sup>	
				LAB	0986 594 001 <sup>3</sup>	
				RAB	0986 594 000 <sup>3</sup>	
	08.00-01.06	85			0986 594 008 <sup>4</sup>	

Octavia Combi [1Z5]









1.2 TSI	02.10-06.13	77	PR-Code 1ZE	288	0986 473 384	👉 ← 53,94	F 026 A06 106 <sup>7</sup>
					0986 474 384	👉 → 53,94	F 026 A06 106 <sup>7</sup>
			PR-Code 1ZF	228	0986 473 071	👉 ← 54	
					0986 474 071	👉 → 54	
			PR-Code 1ZF, PR-Code 1ZE	228,288			1987 470 506 <sup>8</sup>
			PR-Code 1ZF, PR-Code 1ZM, PR-Code 1ZC	228	0986 473 071	👉 ← 54	1987 470 506 <sup>8</sup>
1.4	05.04-06.06	55	PR-Code 1ZE	288	0986 473 384	👉 ← 53,94	F 026 A06 106 <sup>7</sup>
					0986 473 384	👉 ← 53,94	1987 470 506 <sup>8</sup>
					0986 474 384	👉 → 53,94	F 026 A06 106 <sup>7</sup>
	PR-Code 1ZF, PR-Code 1ZM, PR-Code 1ZC	228	0986 473 071	👉 ← 54	1987 470 506 <sup>8</sup>		
			0986 474 071	👉 → 54	1987 470 506 <sup>8</sup>		
	05.06-06.13	59	PR-Code 1ZE	288	0986 473 384	👉 ← 53,94	F 026 A06 106 <sup>7</sup>
					0986 473 384	👉 ← 53,94	1987 470 506 <sup>8</sup>
					0986 474 384	👉 → 53,94	F 026 A06 106 <sup>7</sup>
	PR-Code 1ZF, PR-Code 1ZM, PR-Code 1ZC	228	0986 473 071	👉 ← 54	1987 470 506 <sup>8</sup>		
			0986 474 071	👉 → 54	1987 470 506 <sup>8</sup>		
	11.10-06.13	59	PR-Code 1ZF	228	0986 473 071	👉 ← 54	
					0986 474 071	👉 → 54	
				0986 473 071	👉 → 54		



	S							
	◀ SKODA Octavia Combi [1Z5]							
<b>2.0 TDI</b> RS	04.06-05.08	125			BSR			F 026 A06 106 <sup>7</sup> 1 987 470 506 <sup>8</sup>
	05.08-02.13	125				0986 473 384	← 53,94	F 026 A06 106 <sup>7</sup>
						0986 474 384	→ 53,94	F 026 A06 106 <sup>7</sup>
<b>2.0 TDI</b>	05.04-05.10	103	PR-Code 1ZE	288		0986 473 384	← 53,94	1 987 470 506 <sup>8</sup>
<b>2.0 TDI</b> 4x4						0986 474 384	→ 53,94	1 987 470 506 <sup>8</sup>
			PR-Code 1ZF, PR-Code 1ZM, PR-Code 1ZC	228		0986 473 071	← 54	1 987 470 506 <sup>8</sup>
						0986 474 071	→ 54	1 987 470 506 <sup>8</sup>
	05.04-05.13	103	PR-Code 1ZE	288		0986 473 384	← 53,94	F 026 A06 106 <sup>7</sup>
	02.10-05.13	103	PR-Code 1ZE	288		0986 474 384	→ 53,94	F 026 A06 106 <sup>7</sup>
			PR-Code 1ZF	228		0986 473 071	← 54	
						0986 474 071	→ 54	
			PR-Code 1ZF, PR-Code 1ZE	228,288				1 987 470 506 <sup>8</sup>
	03.10-06.13	81	PR-Code 1ZE	288		0986 473 384	← 53,94	F 026 A06 106 <sup>7</sup>
						0986 474 384	→ 53,94	F 026 A06 106 <sup>7</sup>
			PR-Code 1ZF	228		0986 473 071	← 54	
						0986 474 071	→ 54	
			PR-Code 1ZF, PR-Code 1ZE	228,288				1 987 470 506 <sup>8</sup>
<b>2.0 TSI</b> RS	11.08-02.13	147				0986 473 384	← 53,94	F 026 A06 106 <sup>7</sup>
						0986 474 384	→ 53,94	F 026 A06 106 <sup>7</sup>
								
	<b>1.2</b> TSI	02.10-03.10	77	PR-Code 1KS	BSR	0986 134 203	← 38	
						0986 135 203	→ 38	
		02.10-06.13	77	PR-Code 1KD	D53	0986 473 381	← 38,1	1 987 470 040 <sup>7</sup>
						0986 474 381	→ 38,1	1 987 470 040 <sup>7</sup>
						0986 473 448	← 41	
						0986 474 448	→ 41	
	<b>1.4</b>	05.04-06.06	55	PR-Code 1KD		0986 473 381	← 38,1	1 987 470 040 <sup>7</sup>
						0986 474 381	→ 38,1	1 987 470 040 <sup>7</sup>
						0986 473 448	← 41	
						0986 474 448	→ 41	
		05.06-06.13	59	PR-Code 1KD		0986 473 381	← 38,1	1 987 470 040 <sup>7</sup>
						0986 474 381	→ 38,1	1 987 470 040 <sup>7</sup>
						0986 473 448	← 41	
						0986 474 448	→ 41	
		11.10-06.13	59	PR-Code 1KD	D53	0986 473 381	← 38,1	1 987 470 040 <sup>7</sup>
						0986 474 381	→ 38,1	1 987 470 040 <sup>7</sup>
	<b>1.4</b> TSI	11.08-06.13	90	PR-Code 1KD	D53	0986 473 381	← 38,1	1 987 470 040 <sup>7</sup>
						0986 474 381	→ 38,1	1 987 470 040 <sup>7</sup>
						0986 473 448	← 41	
						0986 474 448	→ 41	
		11.09-03.10	90	PR-Code 1KS	BSR	0986 134 203	← 38	
						0986 135 203	→ 38	
	<b>1.6</b>	05.04-06.13	75	PR-Code 1KD		0986 473 381	← 38,1	1 987 470 040 <sup>7</sup>
						0986 474 381	→ 38,1	1 987 470 040 <sup>7</sup>
						0986 473 448	← 41	
						0986 474 448	→ 41	
		08.09-06.13	75	PR-Code 1KD	D53	0986 473 381	← 38,1	1 987 470 040 <sup>7</sup>
						0986 474 381	→ 38,1	1 987 470 040 <sup>7</sup>
		11.09-03.10	75	PR-Code 1KS	BSR	0986 134 203	← 38	
						0986 135 203	→ 38	
	<b>1.6</b> FSI	05.04-10.08	85	PR-Code 1KD		0986 473 381	← 38,1	1 987 470 040 <sup>7</sup>
						0986 474 381	→ 38,1	1 987 470 040 <sup>7</sup>
						0986 473 448	← 41	
						0986 474 448	→ 41	
	<b>1.6</b> TDI	06.09-04.13	77	PR-Code 1KD	D53	0986 473 381	← 38,1	1 987 470 040 <sup>7</sup>
						0986 474 381	→ 38,1	1 987 470 040 <sup>7</sup>
						0986 473 448	← 41	
						0986 474 448	→ 41	
		11.09-03.10	77	PR-Code 1KS	BSR	0986 134 203	← 38	
						0986 135 203	→ 38	



<b>1.6 TDI 4x4</b>	06.09-04.13	77	PR-Code 1KF			0 986 473 448	← 41		
			PR-Code 1KP			0 986 474 448	→ 41		
<b>1.8 TSI</b>	06.07-10.08	118	PR-Code 1KD			0 986 473 381	← 38,1	1 987 470 040 <sup>7</sup>	
			PR-Code 1KF			0 986 474 448	→ 41		
<b>1.9 TDI</b>	06.07-06.13	118	PR-Code 1KF			0 986 473 448	← 41		
			PR-Code 1KD			0 986 474 448	→ 41		
<b>1.8 TSI 4x4</b>	11.08-06.13	118	PR-Code 1KD	D53		0 986 473 381	← 38,1	1 987 470 040 <sup>7</sup>	
			PR-Code 1KF			0 986 474 381	→ 38,1	1 987 470 040 <sup>7</sup>	
<b>1.9 TDI</b>	05.09-06.13	112	PR-Code 1KD	D53		0 986 473 381	← 38,1	1 987 470 040 <sup>7</sup>	
			PR-Code 1KF			0 986 474 381	→ 38,1	1 987 470 040 <sup>7</sup>	
<b>1.8 TSI 4x4</b>	11.09-03.10	112	PR-Code 1KS	BSR		0 986 134 203	← 38		
			PR-Code 1KP			0 986 135 244	→ 38		
<b>1.9 TDI 4x4</b>	11.08-06.13	118	PR-Code 1KF			0 986 473 448	← 41		
			PR-Code 1KD			0 986 474 448	→ 41		
<b>2.0 FSI</b>	11.04-10.08	110	PR-Code 1KD			0 986 473 381	← 38,1	1 987 470 040 <sup>7</sup>	
			PR-Code 1KF			0 986 474 381	→ 38,1	1 987 470 040 <sup>7</sup>	
<b>2.0 RS, TDI RS, TSI RS</b>	10.05-02.13	125/147	PR-Code 1KP			0 986 134 244	←		
						0 986 135 244	→		
<b>2.0 TDI</b>	05.04-04.13	77	PR-Code 1KD			0 986 473 381	← 38,1	1 987 470 040 <sup>7</sup>	
			PR-Code 1KF			0 986 474 381	→ 38,1	1 987 470 040 <sup>7</sup>	
<b>2.0 FSI 4x4</b>	11.04-10.08	110	PR-Code 1KD			0 986 473 381	← 38,1	1 987 470 040 <sup>7</sup>	
			PR-Code 1KF			0 986 474 381	→ 38,1	1 987 470 040 <sup>7</sup>	
<b>2.0 TDI</b>	05.04-05.10	100	PR-Code 1KD			0 986 473 381	← 38,1	1 987 470 040 <sup>7</sup>	
			PR-Code 1KF			0 986 474 381	→ 38,1	1 987 470 040 <sup>7</sup>	
<b>2.0 TDI</b>	02.10-03.10	103	PR-Code 1KD			0 986 473 381	← 38,1	1 987 470 040 <sup>7</sup>	
			PR-Code 1KF			0 986 474 381	→ 38,1	1 987 470 040 <sup>7</sup>	
<b>2.0 TDI</b>	02.10-03.10	103	PR-Code 1KS	BSR		0 986 134 203	← 38		
			PR-Code 1KP			0 986 135 203	→ 38		
<b>2.0 TDI</b>	02.10-05.13	103	PR-Code 1KD	D53		0 986 473 381	← 38,1	1 987 470 040 <sup>7</sup>	
			PR-Code 1KF			0 986 474 381	→ 38,1	1 987 470 040 <sup>7</sup>	
<b>2.0 TDI</b>	03.10-03.10	81	PR-Code 1KS	BSR		0 986 134 244	←		
			PR-Code 1KP			0 986 135 244	→		
<b>2.0 TDI</b>	03.10-06.13	81	PR-Code 1KD	D53		0 986 473 381	← 38,1	1 987 470 040 <sup>7</sup>	
			PR-Code 1KF			0 986 474 381	→ 38,1	1 987 470 040 <sup>7</sup>	
<b>2.0 TDI</b>	03.10-06.13	81	PR-Code 1KF			0 986 473 448	← 41		
			PR-Code 1KP			0 986 474 448	→ 41		
<b>2.0 TDI</b>	03.10-06.13	81	PR-Code 1KD	D53		0 986 473 381	← 38,1	1 987 470 040 <sup>7</sup>	
			PR-Code 1KF			0 986 474 381	→ 38,1	1 987 470 040 <sup>7</sup>	
<b>2.0 TDI</b>	03.10-06.13	81	PR-Code 1KF			0 986 473 448	← 41		
			PR-Code 1KP			0 986 474 448	→ 41		
<b>2.0 TDI</b>	03.10-06.13	81	PR-Code 1KD	D53		0 986 473 381	← 38,1	1 987 470 040 <sup>7</sup>	
			PR-Code 1KF			0 986 474 381	→ 38,1	1 987 470 040 <sup>7</sup>	
<b>2.0 TDI</b>	03.10-06.13	81	PR-Code 1KF			0 986 473 448	← 41		
			PR-Code 1KP			0 986 474 448	→ 41		



	S				?			
1.6FSI	05.04-10.08	85			RAB	0 986 594 505 <sup>3</sup> 0 986 594 507 <sup>4</sup>		
1.6TDI	06.09-04.13	77			LAB RAB	0 986 594 504 <sup>3</sup> 0 986 594 506 <sup>4</sup> 0 986 594 505 <sup>3</sup> 0 986 594 507 <sup>4</sup>		
1.6TDI 4x4	06.09-04.13	77			LAB RAB	0 986 594 504 <sup>3</sup> 0 986 594 504 <sup>4</sup> 0 986 594 505 <sup>3</sup> 0 986 594 505 <sup>4</sup>		
1.8TSI	06.07-06.13	112/118			LAB RAB	0 986 594 504 <sup>3</sup> 0 986 594 506 <sup>4</sup> 0 986 594 505 <sup>3</sup> 0 986 594 507 <sup>4</sup>		
1.8TSI 4x4	11.08-06.13	112/118			LAB RAB	0 986 594 504 <sup>3</sup> 0 986 594 504 <sup>4</sup> 0 986 594 505 <sup>3</sup> 0 986 594 505 <sup>4</sup>		
1.9TDI	05.04-04.13	77			LAB RAB	0 986 594 504 <sup>3</sup> 0 986 594 506 <sup>4</sup> 0 986 594 505 <sup>3</sup> 0 986 594 507 <sup>4</sup>		
1.9TDI 4x4	11.04-05.10	77			LAB RAB	0 986 594 504 <sup>3</sup> 0 986 594 504 <sup>4</sup> 0 986 594 505 <sup>3</sup> 0 986 594 505 <sup>4</sup>		
2.0FSI	11.04-10.08	103/110			LAB RAB	0 986 594 504 <sup>3</sup> 0 986 594 505 <sup>3</sup>		
2.0FSI	05.04-05.13	103/110			LAB	0 986 594 506 <sup>4</sup>		
2.0TDI					RAB	0 986 594 507 <sup>4</sup>		
2.0FSI 4x4	11.04-10.08	103/110			LAB RAB	0 986 594 504 <sup>3</sup> 0 986 594 504 <sup>4</sup> 0 986 594 505 <sup>3</sup> 0 986 594 505 <sup>4</sup>		
2.0RS	10.05-02.13	125/147			LAB	0 986 594 504 <sup>3</sup>		
2.0TDI RS					RAB	0 986 594 506 <sup>4</sup> 0 986 594 505 <sup>3</sup>		
2.0TSI RS						0 986 594 507 <sup>4</sup>		
2.0TDI	05.04-05.10	100			LAB RAB	0 986 594 504 <sup>3</sup> 0 986 594 506 <sup>4</sup> 0 986 594 505 <sup>3</sup> 0 986 594 507 <sup>4</sup>		
	05.04-05.13	103/110			LAB RAB	0 986 594 504 <sup>3</sup> 0 986 594 505 <sup>3</sup>		
	03.10-06.13	81			LAB RAB	0 986 594 504 <sup>3</sup> 0 986 594 506 <sup>4</sup> 0 986 594 505 <sup>3</sup> 0 986 594 507 <sup>4</sup>		
2.0TDI 4x4	12.05-05.13	103/110			LAB RAB	0 986 594 504 <sup>3</sup> 0 986 594 504 <sup>4</sup> 0 986 594 505 <sup>3</sup> 0 986 594 505 <sup>4</sup>		
	05.11-05.13	81			LAB RAB	0 986 594 504 <sup>3</sup> 0 986 594 504 <sup>4</sup> 0 986 594 505 <sup>3</sup> 0 986 594 505 <sup>4</sup>		













**Octavia Combi [5E5]**

								
	1.2 TSI	11.12→	63/77					1 987 470 040 <sup>7</sup>
	1.4 TSI, TSI G-Tec	11.12→	81/103/110					1 987 470 040 <sup>7</sup>
	1.6, TDI, TDI 4x4	11.12→	66/77/81					1 987 470 040 <sup>7</sup>

		S							
◀ <b>SKODA Octavia Combi [5E5]</b>									
	1.8 TDI 4x4, TSI, TSI 4x4	11.12→	132						1987 470 040 <sup>7</sup>
	2.0 FSI RS, TDI	11.12→	105/110/135/162						1987 470 040 <sup>7</sup>
	1.2 TSI	11.12→	63/77		FPA,GBM	0986 594 526 <sup>4</sup>			
					LAB	0986 594 500 <sup>3</sup>			
					RAB	0986 594 501 <sup>3</sup>			
	1.4 TSI	11.12→	81/103/		FPA,GBM	0986 594 526 <sup>4</sup>			
	1.4 TSI G-Tec		110		LAB	0986 594 500 <sup>3</sup>			
					RAB	0986 594 501 <sup>3</sup>			
	1.6	11.12→	66/77/81		FPA,GBM	0986 594 526 <sup>4</sup>			
	1.6 TDI				LAB	0986 594 500 <sup>3</sup>			
	1.6 TDI 4x4				RAB	0986 594 501 <sup>3</sup>			
	1.8 TDI 4x4	11.12→	132		FPA,GBM	0986 594 526 <sup>4</sup>			
	1.8 TSI				RAB	0986 594 501 <sup>3</sup>			
	1.8 TDI 4x4, TSI, TSI 4x4	11.12→	132		LAB	0986 594 500 <sup>3</sup>			
	1.8 TSI 4x4	05.13→	132		FPA,LAB	0986 594 504 <sup>4</sup>			
					FPA,RAB	0986 594 505 <sup>4</sup>			
					RAB	0986 594 501 <sup>3</sup>			
	2.0 FSI RS	11.12→	105/110/		FPA,GBM	0986 594 526 <sup>4</sup>			
	2.0 TDI		135/162		LAB	0986 594 500 <sup>3</sup>			
	2.0 TDI 4x4				RAB	0986 594 501 <sup>3</sup>			
<b>Octavia RS Combi [5E5]</b>									
	2.0 FSI	05.13→	135						1987 470 040 <sup>7</sup>
	2.0 TDI								
	2.0 FSI	05.13→	135		FPA,GBM	0986 594 526 <sup>4</sup>			
	2.0 TDI				LAB	0986 594 500 <sup>3</sup>			
					RAB	0986 594 501 <sup>3</sup>			
<b>Octavia [1U2]</b>									
	1.4	06.99-12.10	44/55		228,252	0986 473 071		← 54	1987 470 506 <sup>8</sup>
						0986 474 071		→ 54	1987 470 506 <sup>8</sup>
	1.6	09.96-09.04	55		228,252	0986 473 071		← 54	1987 470 506 <sup>8</sup>
						0986 474 071		→ 54	1987 470 506 <sup>8</sup>
		11.96-12.10	74/75		228,252	0986 473 071		← 54	1987 470 506 <sup>8</sup>
						0986 474 071		→ 54	1987 470 506 <sup>8</sup>
					288	0986 471 923		← 54	1987 470 506 <sup>8</sup>
						0986 473 923			
						0986 471 924		→ 54	1987 470 506 <sup>8</sup>
						0986 473 924			
	1.8	09.96-04.99	92		228,252	0986 473 071		← 54	1987 470 506 <sup>8</sup>
						0986 474 071		→ 54	1987 470 506 <sup>8</sup>
	1.8 RS	08.00-09.04	132						1987 470 506 <sup>8</sup>
	1.8 T	03.98-12.10	110		228,252	0986 473 071		← 54	1987 470 506 <sup>8</sup>
	1.8 T 4x4					0986 474 071		→ 54	1987 470 506 <sup>8</sup>
					288	0986 471 923		← 54	1987 470 506 <sup>8</sup>
						0986 473 923			
						0986 471 924		→ 54	1987 470 506 <sup>8</sup>
						0986 473 924			
	1.9 SDI	05.97-12.03	50		228,252	0986 473 071		← 54	1987 470 506 <sup>8</sup>
						0986 474 071		→ 54	1987 470 506 <sup>8</sup>
	1.9 TDI	09.96-12.10	66/74/81/		228,252	0986 473 071		← 54	1987 470 506 <sup>8</sup>
			96			0986 474 071		→ 54	1987 470 506 <sup>8</sup>





































































		S							
<b>1.9 TDI</b>		09.96-12.10	66/74/81/ 96		288	0 986 471 923 0 986 473 923	← 54		1 987 470 506 <sup>B</sup>
						0 986 471 924 0 986 473 924	→ 54		1 987 470 506 <sup>B</sup>
<b>2.0</b>		06.99-05.07	85		228,252	0 986 473 071	← 54		1 987 470 506 <sup>B</sup>
<b>2.0i</b>						0 986 474 071	→ 54		1 987 470 506 <sup>B</sup>
<b>2.0 4x4</b>					288	0 986 471 923 0 986 473 923	← 54		1 987 470 506 <sup>B</sup>
						0 986 471 924 0 986 473 924	→ 54		1 987 470 506 <sup>B</sup>
<hr/>									
									
	<b>1.4</b>	06.99-12.10	44/55			0 986 475 039 0 986 475 433	↔ 20,64 ↔ 19,05		
	<b>1.6</b>	09.96-12.10	55/74/75			0 986 475 039 0 986 475 433	↔ 20,64 ↔ 19,05		
	<b>1.8</b>	09.96-04.99	92			0 986 475 039 0 986 475 433	↔ 20,64 ↔ 19,05		
	<b>1.9 SDI</b>	09.96-12.10	50/66/74/ 81/96			0 986 475 039	↔ 20,64		
	<b>1.9 TDI</b>					0 986 475 433	↔ 19,05		
	<b>2.0</b>	06.99-05.07	85			0 986 475 039	↔ 20,64		
	<b>2.0i</b>					0 986 475 433	↔ 19,05		
	<b>1.4</b>	06.99-03.01	44		232	0 986 473 029 0 986 474 029	← 41 → 41		1 987 474 496 <sup>B</sup>
	<b>1.6</b>	09.96-06.98	55	Fg.-Nr. →1U..W..129 999	232	0 986 473 072 0 986 474 072	← 38 → 38		
		11.96-06.98	74	Fg.-Nr. →1U..W..129 999	232	0 986 473 072 0 986 474 072	← 38 → 38		
		07.98-06.99	55	Fg.-Nr. 1U..W..130 000→1U..Y..294 000232		0 986 473 106 0 986 474 106	← 41 → 41		
			74	Fg.-Nr. 1U..W..130 000→1U..Y..294 000232		0 986 473 106 0 986 474 106	← 41 → 41		
		07.99-09.04	55	Fg.-Nr. 1U..Y..294 001→	232	0 986 473 029 0 986 474 029	← 41 → 41		
			74	Fg.-Nr. 1U..Y..294 001→	232	0 986 473 029 0 986 474 029	← 41 → 41		
		08.00-05.07	74			0 986 473 029 0 986 474 029	← 41 → 41		1 987 474 496 <sup>B</sup>
		08.00-12.10	75			0 986 473 029 0 986 474 029	← 41 → 41		1 987 474 496 <sup>B</sup>
	<b>1.8</b>	09.96-06.98	92	Fg.-Nr. →1U..W..129 999	232	0 986 473 072 0 986 474 072	← 38 → 38		
		07.98-04.99	92	Fg.-Nr. 1U..W..130 000→1U..Y..294 000232		0 986 473 106 0 986 474 106	← 41 → 41		
	<b>1.8 RS</b>	08.00-09.04	132						1 987 470 040 <sup>7</sup>
	<b>1.8 T</b>	03.98-06.98	110	Fg.-Nr. →1U..W..129 999	232	0 986 473 072 0 986 474 072	← 38 → 38		
		07.98-06.99	110	Fg.-Nr. 1U..W..130 000→1U..Y..294 000232		0 986 473 106 0 986 474 106	← 41 → 41		
		07.99-12.10	110	Fg.-Nr. 1U..Y..294 001→	232	0 986 473 029 0 986 474 029	← 41 → 41		
		01.00-12.10	110			0 986 473 029 0 986 474 029	← 41 → 41		1 987 474 496 <sup>B</sup>
						0 986 474 029	→ 41		1 987 474 496 <sup>B</sup>
	<b>1.8 T 4x4</b>	01.00-12.10	110			0 986 473 029 0 986 474 029	← 41 → 41		1 987 474 496 <sup>B</sup>
						0 986 474 029	→ 41		1 987 474 496 <sup>B</sup>
	<b>1.9 SDI</b>	05.97-06.98	50	Fg.-Nr. →1U..W..129 999	232	0 986 473 072 0 986 474 072	← 38 → 38		
		07.98-06.99	50	Fg.-Nr. 1U..W..130 000→1U..Y..294 000232		0 986 473 106 0 986 474 106	← 41 → 41		
		07.99-07.00	50	Fg.-Nr. 1U..Y..294 001→	232	0 986 473 029 0 986 474 029	← 41 → 41		



			S									
◀ SKODA Octavia [1U2]												
1.9 TDI	05.97-12.10	66/74/81/96						0986 473 029		41	1987 474 496 <sup>8</sup>	
								0986 474 029		41	1987 474 496 <sup>8</sup>	
2.0	06.99-03.02	85				232		0986 473 029		41	1987 474 496 <sup>8</sup>	
								0986 474 029		41	1987 474 496 <sup>8</sup>	
	06.99-05.07	85						0986 473 029		41	1987 474 496 <sup>8</sup>	
								0986 474 029		41	1987 474 496 <sup>8</sup>	
2.0 i	08.00-01.05	85						0986 473 029		41	1987 474 496 <sup>8</sup>	
2.0 4x4								0986 474 029		41	1987 474 496 <sup>8</sup>	
1.4	06.99-12.10	44/55						1987 477 684		1620		
1.6	09.96-06.99	55			Fg.-Nr. →1U..Y..294 000			SSZ		1987 477 704		1620
								SSZ		1987 482 129		1620
	11.96-06.99	74			Fg.-Nr. →1U..Y..294 000			SSZ,TBR		1987 477 704		1620
								SSZ,TBR		1987 482 129		1620
	11.96-05.07	74						SBR		1987 477 698		1693
	06.99-09.04	55			Fg.-Nr. 1U..Y..294 001→					1987 477 684		1620
		74			Fg.-Nr. 1U..Y..294 001→			TBR		1987 477 684		1620
	08.00-05.07	74						TBR		1987 477 684		1620
	08.00-12.10	75						SBR		1987 477 698		1693
								TBR		1987 477 684		1620
1.8	09.96-04.99	92								1987 477 696		1688
1.8 RS	08.00-09.04	132								1987 477 698		1693
1.8 T	03.98-12.10	110						SSZ		1987 477 817		1700
								SSZ		1987 477 698		1693
1.8 T 4x4	01.00-12.10	110								1987 477 686		1723
1.9 SDI	05.97-06.99	50			Fg.-Nr. →1U..Y..294 000			SSZ		1987 477 704		1620
								SSZ		1987 482 129		1620
	06.99-07.00	50			Fg.-Nr. 1U..Y..294 001→					1987 477 684		1620
	08.00-12.03	50								1987 477 684		1620
1.9 TDI	09.96-06.99	66			Fg.-Nr. →1U..Y..294 000			SSZ		1987 477 704		1620
								SSZ		1987 482 129		1620
	05.97-06.99	81			Fg.-Nr. →1U..Y..294 000			SSZ,TBR		1987 477 704		1620
								SSZ,TBR		1987 482 129		1620
	05.97-01.06	81						SBR		1987 477 698		1693
	06.99-01.06	81			Fg.-Nr. 1U..Y..294 001→			TBR		1987 477 684		1620
	06.99-12.09	66			Fg.-Nr. 1U..Y..294 001→					1987 477 684		1620
	08.00-01.06	81						TBR		1987 477 684		1620
	08.00-03.10	66						SBR		1987 477 698		1693
								TBR		1987 477 684		1620
	01.03-09.04	96						SBR		1987 477 698		1693
								TBR		1987 477 684		1620
	10.05-12.10	74						SBR		1987 477 698		1693
								TBR		1987 477 684		1620
2.0	06.99-06.99	85			Fg.-Nr. →1U..Y..294 000			SSZ,TBR		1987 477 704		1620
								SSZ,TBR		1987 482 129		1620
	06.99-03.02	85			Fg.-Nr. 1U..Y..294 001→			TBR		1987 477 684		1620
	06.99-05.07	85						SBR		1987 477 698		1693
	08.00-05.07	85						TBR		1987 477 684		1620
2.0 i	08.00-01.05	85						SBR		1987 477 698		1693
								TBR		1987 477 684		1620
2.0 4x4	08.00-09.04	85								1987 477 686		1723
1.4	06.99-12.10	44/55								0986 594 004 <sup>4</sup>		
								LAB		0986 594 001 <sup>3</sup>		
								RAB		0986 594 000 <sup>3</sup>		
1.6	09.96-12.10	55/74/75								0986 594 004 <sup>4</sup>		
								LAB		0986 594 001 <sup>3</sup>		
								RAB		0986 594 000 <sup>3</sup>		
1.8	09.96-04.99	92								0986 594 004 <sup>4</sup>		
								LAB		0986 594 001 <sup>3</sup>		
								RAB		0986 594 000 <sup>3</sup>		









		S							
1.8 RS		08.00-09.04	132				0 986 594 004 <sup>4</sup>		
						LAB	0 986 594 001 <sup>3</sup>		
						RAB	0 986 594 000 <sup>3</sup>		
1.8 T		03.98-12.10	110				0 986 594 004 <sup>4</sup>		
1.8 T		03.98-12.10	110			LAB	0 986 594 001 <sup>3</sup>		
1.8 T 4x4						RAB	0 986 594 000 <sup>3</sup>		
1.8 T 4x4		01.00-12.10	110				0 986 594 008 <sup>4</sup>		
1.9 SDI		09.96-12.10	50/66/74/				0 986 594 004 <sup>4</sup>		
1.9 TDI			81/96			LAB	0 986 594 001 <sup>3</sup>		
						RAB	0 986 594 000 <sup>3</sup>		
2.0		06.99-05.07	85				0 986 594 004 <sup>4</sup>		
2.0 i									
2.0		06.99-05.07	85			LAB	0 986 594 001 <sup>3</sup>		
2.0 i, 4x4						RAB	0 986 594 000 <sup>3</sup>		
2.0 4x4		08.00-09.04	85				0 986 594 008 <sup>4</sup>		
<b>Octavia [1Z3]</b>									
	1.2 TSI	02.10-06.13	77	PR-Code 1ZE	288		0 986 473 384	← 53,94	F 026 A06 106 <sup>7</sup>
							0 986 474 384	→ 53,94	F 026 A06 106 <sup>7</sup>
				PR-Code 1ZF	228		0 986 473 071	← 54	
							0 986 474 071	→ 54	
				PR-Code 1ZF, PR-Code 1ZE	228,288				1 987 470 506 <sup>8</sup>
1.4		05.04-12.10	55	PR-Code 1ZE	288		0 986 473 384	← 53,94	F 026 A06 106 <sup>7</sup>
							0 986 473 384	← 53,94	1 987 470 506 <sup>8</sup>
							0 986 474 384	→ 53,94	F 026 A06 106 <sup>7</sup>
				PR-Code 1ZF, PR-Code 1ZM, PR-Code 1ZC	228		0 986 473 071	← 54	1 987 470 506 <sup>8</sup>
							0 986 474 071	→ 54	1 987 470 506 <sup>8</sup>
		05.06-06.13	59	PR-Code 1ZE	288		0 986 473 384	← 53,94	F 026 A06 106 <sup>7</sup>
							0 986 473 384	← 53,94	1 987 470 506 <sup>8</sup>
							0 986 474 384	→ 53,94	F 026 A06 106 <sup>7</sup>
				PR-Code 1ZF, PR-Code 1ZM, PR-Code 1ZC	228		0 986 473 071	← 54	1 987 470 506 <sup>8</sup>
							0 986 474 071	→ 54	1 987 470 506 <sup>8</sup>
		11.10-06.13	59	PR-Code 1ZF	228		0 986 473 071	← 54	
							0 986 474 071	→ 54	
				PR-Code 1ZF, PR-Code 1ZE	228,288				1 987 470 506 <sup>8</sup>
1.4 TSI		11.08-06.13	90	PR-Code 1ZE	288		0 986 473 384	← 53,94	F 026 A06 106 <sup>7</sup>
							0 986 474 384	→ 53,94	F 026 A06 106 <sup>7</sup>
				PR-Code 1ZF	228		0 986 473 071	← 54	
							0 986 474 071	→ 54	
				PR-Code 1ZF, PR-Code 1ZE	228,288				1 987 470 506 <sup>8</sup>
1.6		05.04-06.13	75	PR-Code 1ZE	288		0 986 473 384	← 53,94	F 026 A06 106 <sup>7</sup>
							0 986 473 384	← 53,94	1 987 470 506 <sup>8</sup>
							0 986 474 384	→ 53,94	F 026 A06 106 <sup>7</sup>
				PR-Code 1ZF, PR-Code 1ZM, PR-Code 1ZC	228		0 986 473 071	← 54	1 987 470 506 <sup>8</sup>
							0 986 474 071	→ 54	1 987 470 506 <sup>8</sup>
		08.09-06.13	75	PR-Code 1ZF	228		0 986 473 071	← 54	
							0 986 474 071	→ 54	
				PR-Code 1ZF, PR-Code 1ZE	228,288				1 987 470 506 <sup>8</sup>
1.6 FSI		05.04-10.08	85	PR-Code 1ZE	288		0 986 473 384	← 53,94	F 026 A06 106 <sup>7</sup>
							0 986 473 384	← 53,94	1 987 470 506 <sup>8</sup>
							0 986 474 384	→ 53,94	F 026 A06 106 <sup>7</sup>
				PR-Code 1ZF, PR-Code 1ZM, PR-Code 1ZC	228		0 986 473 071	← 54	1 987 470 506 <sup>8</sup>
							0 986 474 071	→ 54	1 987 470 506 <sup>8</sup>
1.6 TDI		06.09-04.13	77	PR-Code 1ZE	288		0 986 473 384	← 53,94	F 026 A06 106 <sup>7</sup>
							0 986 474 384	→ 53,94	F 026 A06 106 <sup>7</sup>
				PR-Code 1ZF	228		0 986 473 071	← 54	
							0 986 474 071	→ 54	
				PR-Code 1ZF, PR-Code 1ZE	228,288				1 987 470 506 <sup>8</sup>
1.8 TSI		06.07-10.08	118	PR-Code 1ZE	288		0 986 473 384	← 53,94	1 987 470 506 <sup>8</sup>
							0 986 474 384	→ 53,94	1 987 470 506 <sup>8</sup>

		S																	
◀ SKODA Octavia [1Z3]																			
1.8 TSI		06.07-10.08	118	PR-Code 1ZF, PR-Code 1ZM, PR-Code 1ZC	228	0986 473 071		← 54	1987 470 506 <sup>8</sup>										
						0986 474 071		→ 54	1987 470 506 <sup>8</sup>										
						06.07-06.13	118	PR-Code 1ZE	288	0986 473 384		← 53,94	F 026 A06 106 <sup>7</sup>						
						11.08-06.13	118	PR-Code 1ZE	288	0986 474 384		→ 53,94	F 026 A06 106 <sup>7</sup>						
										PR-Code 1ZF	228	0986 473 071		← 54					
												0986 474 071		→ 54					
												PR-Code 1ZF, PR-Code 1ZE	228,288						1987 470 506 <sup>8</sup>
												03.09-06.13	112	PR-Code 1ZE	288	0986 473 384		← 53,94	F 026 A06 106 <sup>7</sup>
										PR-Code 1ZF	228	0986 474 384		→ 53,94	F 026 A06 106 <sup>7</sup>				
												0986 473 071		← 54					
0986 474 071		→ 54																	
PR-Code 1ZF, PR-Code 1ZE	228,288												1987 470 506 <sup>8</sup>						
1.9 TDI		05.04-04.13	77	PR-Code 1ZE	288	0986 473 384		← 53,94	F 026 A06 106 <sup>7</sup>										
						0986 473 384		← 53,94	1987 470 506 <sup>8</sup>										
1.9 TDI 4x4				PR-Code 1ZF, PR-Code 1ZM, PR-Code 1ZC	228	0986 474 384		→ 53,94	F 026 A06 106 <sup>7</sup>										
						0986 473 071		← 54	1987 470 506 <sup>8</sup>										
2.0 FSI		11.04-10.08	110	PR-Code 1ZE	288	0986 473 384		← 53,94	F 026 A06 106 <sup>7</sup>										
						0986 473 384		← 53,94	1987 470 506 <sup>8</sup>										
2.0 FSI 4x4				PR-Code 1ZF, PR-Code 1ZM, PR-Code 1ZC	228	0986 474 384		→ 53,94	F 026 A06 106 <sup>7</sup>										
						0986 473 071		← 54	1987 470 506 <sup>8</sup>										
2.0 RS		10.05-10.08	147		BSR				F 026 A06 106 <sup>7</sup>										
					BSR				1987 470 506 <sup>8</sup>										
									F 026 A06 106 <sup>7</sup>										
										1987 470 506 <sup>8</sup>									
2.0 TDI		05.04-05.10	100	PR-Code 1ZE	288	0986 473 384		← 53,94	F 026 A06 106 <sup>7</sup>										
						0986 473 384		← 53,94	1987 470 506 <sup>8</sup>										
						0986 474 384		→ 53,94	F 026 A06 106 <sup>7</sup>										
						PR-Code 1ZF, PR-Code 1ZM, PR-Code 1ZC	228	0986 473 071		← 54	1987 470 506 <sup>8</sup>								
								0986 474 071		→ 54	1987 470 506 <sup>8</sup>								
						103		PR-Code 1ZE	288	0986 473 384		← 53,94	1987 470 506 <sup>8</sup>						
										0986 474 384		→ 53,94	1987 470 506 <sup>8</sup>						
						PR-Code 1ZF, PR-Code 1ZM, PR-Code 1ZC	228			0986 473 071		← 54	1987 470 506 <sup>8</sup>						
										0986 474 071		→ 54	1987 470 506 <sup>8</sup>						
						05.04-05.13	103	PR-Code 1ZE	288	0986 473 384		← 53,94	F 026 A06 106 <sup>7</sup>						
02.10-05.13	103	PR-Code 1ZE	288	0986 474 384		→ 53,94	F 026 A06 106 <sup>7</sup>												
03.10-06.13	81	PR-Code 1ZE	288	0986 473 384		← 53,94	F 026 A06 106 <sup>7</sup>												
				0986 474 384		→ 53,94	F 026 A06 106 <sup>7</sup>												
PR-Code 1ZF	228			0986 473 071		← 54													
				0986 474 071		→ 54													
PR-Code 1ZF, PR-Code 1ZE	228,288							1987 470 506 <sup>8</sup>											
2.0 TDI RS		04.06-05.08	125		BSR				F 026 A06 106 <sup>7</sup>										
					BSR				1987 470 506 <sup>8</sup>										
									F 026 A06 106 <sup>7</sup>										
										1987 470 506 <sup>8</sup>									
05.08-02.13	125					0986 473 384		← 53,94	F 026 A06 106 <sup>7</sup>										
						0986 474 384		→ 53,94	F 026 A06 106 <sup>7</sup>										
2.0 TDI		02.10-05.13	103	PR-Code 1ZF	228	0986 473 071		← 54											
2.0 TDI 4x4				PR-Code 1ZF, PR-Code 1ZE	228,288				1987 470 506 <sup>8</sup>										
2.0 TDI 4x4		05.10-05.13	103	PR-Code 1ZE	288	0986 473 384		← 53,94	F 026 A06 106 <sup>7</sup>										
						0986 474 384		→ 53,94	F 026 A06 106 <sup>7</sup>										
PR-Code 1ZF	228			0986 474 071		→ 54													
2.0 TSI RS		11.08-02.13	147			0986 473 384		← 53,94	F 026 A06 106 <sup>7</sup>										
						0986 474 384		→ 53,94	F 026 A06 106 <sup>7</sup>										
	1.2 TSI	02.10-03.10	77	PR-Code 1KS	BSR	0986 134 203		← 38											
						0986 135 203		→ 38											
		02.10-06.13	77	PR-Code 1KD	D53	0986 473 381		← 38,1	1987 470 040 <sup>7</sup>										
						0986 474 381		→ 38,1	1987 470 040 <sup>7</sup>										



		<b>S</b>							
<b>1.2 TSI</b>			02.10-06.13	77	PR-Code 1KF		0 986 473 448	 ← 41	
							0 986 474 448	 → 41	
<b>1.4</b>			05.04-12.10	55	PR-Code 1KD		0 986 473 381	 ← 38,1	1 987 470 040 <sup>7</sup>
							0 986 474 381	 → 38,1	1 987 470 040 <sup>7</sup>
					PR-Code 1KF		0 986 473 448	 ← 41	
							0 986 474 448	 → 41	
			05.06-06.13	59	PR-Code 1KD		0 986 473 381	 ← 38,1	1 987 470 040 <sup>7</sup>
							0 986 474 381	 → 38,1	1 987 470 040 <sup>7</sup>
					PR-Code 1KF		0 986 473 448	 ← 41	
							0 986 474 448	 → 41	
			11.10-06.13	59	PR-Code 1KD	D53	0 986 473 381	 ← 38,1	1 987 470 040 <sup>7</sup>
							0 986 474 381	 → 38,1	1 987 470 040 <sup>7</sup>
<b>1.4 TSI</b>			11.08-06.13	90	PR-Code 1KD	D53	0 986 473 381	 ← 38,1	1 987 470 040 <sup>7</sup>
							0 986 474 381	 → 38,1	1 987 470 040 <sup>7</sup>
					PR-Code 1KF		0 986 473 448	 ← 41	
							0 986 474 448	 → 41	
			11.09-03.10	90	PR-Code 1KS	BSR	0 986 134 203	 ← 38	
							0 986 135 203	 → 38	
<b>1.6</b>			05.04-06.13	75	PR-Code 1KD		0 986 473 381	 ← 38,1	1 987 470 040 <sup>7</sup>
							0 986 474 381	 → 38,1	1 987 470 040 <sup>7</sup>
					PR-Code 1KF		0 986 473 448	 ← 41	
							0 986 474 448	 → 41	
			08.09-06.13	75	PR-Code 1KD	D53	0 986 473 381	 ← 38,1	1 987 470 040 <sup>7</sup>
							0 986 474 381	 → 38,1	1 987 470 040 <sup>7</sup>
			11.09-03.10	75	PR-Code 1KS	BSR	0 986 134 203	 ← 38	
							0 986 135 203	 → 38	
<b>1.6 FSI</b>			05.04-10.08	85	PR-Code 1KD		0 986 473 381	 ← 38,1	1 987 470 040 <sup>7</sup>
							0 986 474 381	 → 38,1	1 987 470 040 <sup>7</sup>
					PR-Code 1KF		0 986 473 448	 ← 41	
							0 986 474 448	 → 41	
<b>1.6 TDI</b>			06.09-04.13	77	PR-Code 1KD	D53	0 986 473 381	 ← 38,1	1 987 470 040 <sup>7</sup>
							0 986 474 381	 → 38,1	1 987 470 040 <sup>7</sup>
					PR-Code 1KF		0 986 473 448	 ← 41	
							0 986 474 448	 → 41	
			11.09-03.10	77	PR-Code 1KS	BSR	0 986 134 203	 ← 38	
							0 986 135 203	 → 38	
<b>1.8 TSI</b>			06.07-10.08	118	PR-Code 1KD		0 986 473 381	 ← 38,1	1 987 470 040 <sup>7</sup>
							0 986 474 381	 → 38,1	1 987 470 040 <sup>7</sup>
			06.07-06.13	118	PR-Code 1KF		0 986 473 448	 ← 41	
							0 986 474 448	 → 41	
			11.08-06.13	118	PR-Code 1KD	D53	0 986 473 381	 ← 38,1	1 987 470 040 <sup>7</sup>
							0 986 474 381	 → 38,1	1 987 470 040 <sup>7</sup>
			03.09-06.13	112	PR-Code 1KD	D53	0 986 473 381	 ← 38,1	1 987 470 040 <sup>7</sup>
							0 986 474 381	 → 38,1	1 987 470 040 <sup>7</sup>
					PR-Code 1KF		0 986 473 448	 ← 41	
							0 986 474 448	 → 41	
			11.09-03.10	112	PR-Code 1KS	BSR	0 986 134 203	 ← 38	
							0 986 135 203	 → 38	
				118	PR-Code 1KS	BSR	0 986 134 203	 ← 38	
							0 986 135 203	 → 38	
<b>1.9 TDI</b>			05.04-04.13	77	PR-Code 1KD		0 986 473 381	 ← 38,1	1 987 470 040 <sup>7</sup>
<b>1.9 TDI 4x4</b>							0 986 474 381	 → 38,1	1 987 470 040 <sup>7</sup>
					PR-Code 1KF		0 986 473 448	 ← 41	
							0 986 474 448	 → 41	
<b>2.0 FSI</b>			11.04-10.08	110	PR-Code 1KD		0 986 473 381	 ← 38,1	1 987 470 040 <sup>7</sup>
<b>2.0 FSI 4x4</b>							0 986 474 381	 → 38,1	1 987 470 040 <sup>7</sup>
					PR-Code 1KF		0 986 473 448	 ← 41	
							0 986 474 448	 → 41	
<b>2.0 RS, TDI RS, TSI RS</b>			10.05-02.13	125/147	PR-Code 1KP		0 986 134 244	 ←	
							0 986 135 244	→	
<b>2.0 TDI</b>			05.04-05.10	100	PR-Code 1KD		0 986 473 381	← 38,1	1 987 470 040 <sup>7</sup>
							0 986 474 381	→ 38,1	1 987 470 040 <sup>7</sup>



			S							
◀ SKODA Octavia [1Z3]										
2.0 TDI	05.04-05.10	100	PR-Code 1KF					0986 473 448		41
								0986 474 448		41
	103		PR-Code 1KD					0986 473 381		38,1
								0986 474 381		38,1
	05.04-05.13	103	PR-Code 1KF					0986 473 448		41
								0986 474 448		41
	02.10-03.10	103	PR-Code 1KS		BSR			0986 134 203		38
								0986 135 203		38
	02.10-05.13	103	PR-Code 1KD		D53			0986 473 381		38,1
								0986 474 381		38,1
			PR-Code 1KP		BSR			0986 134 244		
								0986 135 244		
	03.10-03.10	81	PR-Code 1KS		BSR			0986 134 203		38
								0986 135 203		38
	03.10-06.13	81	PR-Code 1KD		D53			0986 473 381		38,1
								0986 474 381		38,1
			PR-Code 1KF					0986 473 448		41
								0986 474 448		41
			PR-Code 1KP		BSR			0986 134 244		
								0986 135 244		
2.0 TDI RS	11.09-03.10	125/147	PR-Code 1KS		BSR			0986 134 203		38
2.0 TSI RS								0986 135 203		38
2.0 TDI 4x4	05.10-05.13	103	PR-Code 1KF					0986 473 448		41
								0986 474 448		41
			PR-Code 1KP					0986 134 244		
								0986 135 244		
1.2 TSI	02.10-06.13	77						1987 477 958		1447
1.4	05.04-11.05	55	Fg.-Nr. →1Z..62196 492, →1Z..68076 259					1987 482 445		1447
	12.05-12.10	55						1987 477 958		1447
	05.06-06.13	59/90						1987 477 958		1447
1.4 TSI	11.08-06.13	59/90						1987 477 958		1447
1.6	05.04-05.05	75						1987 482 445		1447
	05.05-11.05	75	Fg.-Nr. →1Z..62196 492, →1Z..68076 259					1987 482 445		1447
	12.05-06.13	75						1987 477 958		1447
1.6 FSI	05.04-11.05	85	Fg.-Nr. →1Z..62196 492, →1Z..68076 259					1987 482 445		1447
	12.05-10.08	85						1987 477 958		1447
1.6 TDI	06.09-04.13	77						1987 477 958		1447
1.8 TSI	06.07-06.13	112/118						1987 477 958		1447
1.9 TDI	05.04-11.05	77	Fg.-Nr. →1Z..62196 492, →1Z..68076 259					1987 482 445		1447
	12.05-04.13	77						1987 477 958		1447
1.9 TDI 4x4	05.06-05.10	77						1987 477 958		1447
2.0 FSI	11.04-11.05	110						1987 482 445		1447
	11.05-10.08	110						1987 477 958		1447
2.0 FSI 4x4	12.04-11.05	110						1987 482 445		1447
	11.05-10.08	110						1987 477 958		1447
2.0 RS	10.05-11.05	147	Fg.-Nr. →1Z..62196 492, →1Z..68076 259					1987 482 445		1447
	12.05-10.08	147						1987 477 958		1447
2.0 TDI	05.04-11.05	100	Fg.-Nr. →1Z..62196 492, →1Z..68076 259					1987 482 445		1447
		103	Fg.-Nr. →1Z..62196 492, →1Z..68076 259					1987 482 445		1447
	11.05-05.13	103						1987 477 958		1447
	12.05-05.10	100						1987 477 958		1447
	03.10-06.13	81						1987 477 958		1447
2.0 TDI RS	04.06-02.13	125						1987 477 958		1447
2.0 TDI 4x4	05.10-05.13	103						1987 477 958		1447
2.0 TSI RS	11.08-02.13	147						1987 477 958		1447
1.2 TSI	02.10-06.13	77					LAB	0986 594 504 <sup>3</sup>		
								0986 594 506 <sup>4</sup>		
							RAB	0986 594 505 <sup>3</sup>		
								0986 594 507 <sup>4</sup>		

		S								
<b>1.4</b> <b>1.4 TSI</b>		05.04-06.13	55/59/90			LAB	0 986 594 504 <sup>3</sup>			
							0 986 594 506 <sup>4</sup>			
							RAB	0 986 594 505 <sup>3</sup>		
								0 986 594 507 <sup>4</sup>		
<b>1.6</b> <b>1.6 FSI</b> <b>1.6 TDI</b>		05.04-06.13	75/77/85			LAB	0 986 594 504 <sup>3</sup>			
							0 986 594 506 <sup>4</sup>			
							RAB	0 986 594 505 <sup>3</sup>		
								0 986 594 507 <sup>4</sup>		
<b>1.8 TSI</b>		06.07-10.08	118			LAB	0 986 594 506 <sup>4</sup>			
							RAB	0 986 594 507 <sup>4</sup>		
		06.07-06.13	118			LAB	0 986 594 504 <sup>3</sup>			
							RAB	0 986 594 505 <sup>3</sup>		
		11.08-06.13	118			LAB	0 986 594 504 <sup>4</sup>			
							RAB	0 986 594 505 <sup>4</sup>		
		03.09-06.13	112			LAB	0 986 594 504 <sup>3</sup>			
							0 986 594 506 <sup>4</sup>			
							RAB	0 986 594 505 <sup>3</sup>		
								0 986 594 507 <sup>4</sup>		
<b>1.9 TDI</b>		05.04-04.13	77			LAB	0 986 594 504 <sup>3</sup>			
							0 986 594 506 <sup>4</sup>			
							RAB	0 986 594 505 <sup>3</sup>		
								0 986 594 507 <sup>4</sup>		
<b>1.9 TDI 4x4</b>		05.06-05.10	77			LAB	0 986 594 504 <sup>3</sup>			
							0 986 594 506 <sup>4</sup>			
							RAB	0 986 594 505 <sup>3</sup>		
								0 986 594 507 <sup>4</sup>		
<b>2.0 FSI</b>		11.04-10.08	110			LAB	0 986 594 504 <sup>3</sup>			
							0 986 594 506 <sup>4</sup>			
							RAB	0 986 594 505 <sup>3</sup>		
								0 986 594 507 <sup>4</sup>		
<b>2.0 FSI 4x4</b>		12.04-10.08	110			LAB	0 986 594 504 <sup>3</sup>			
							0 986 594 506 <sup>4</sup>			
							RAB	0 986 594 505 <sup>3</sup>		
								0 986 594 507 <sup>4</sup>		
<b>2.0 RS</b> <b>2.0 TDI RS</b> <b>2.0 TSI RS</b>		10.05-02.13	125/147			LAB	0 986 594 504 <sup>3</sup>			
							0 986 594 506 <sup>4</sup>			
							RAB	0 986 594 505 <sup>3</sup>		
								0 986 594 507 <sup>4</sup>		
<b>2.0 TDI</b>		05.04-05.13	103			LAB	0 986 594 504 <sup>3</sup>			
							0 986 594 506 <sup>4</sup>			
							RAB	0 986 594 505 <sup>3</sup>		
		05.04-06.13	81/100			LAB	0 986 594 504 <sup>3</sup>			
							0 986 594 506 <sup>4</sup>			
							RAB	0 986 594 505 <sup>3</sup>		
<b>2.0 TDI 4x4</b>		05.10-05.13	103			LAB	0 986 594 504 <sup>3</sup>			
							0 986 594 506 <sup>4</sup>			
							RAB	0 986 594 505 <sup>3</sup>		
								0 986 594 507 <sup>4</sup>		

**Octavia [5E3]**

								
	<b>1.2 TSI</b>	11.12→	63/77					1 987 470 040 <sup>7</sup>
	<b>1.4 TSI, TSI G-Tec</b>	11.12→	81/103/110					1 987 470 040 <sup>7</sup>
	<b>1.6, TDI, TDI 4x4</b>	11.12→	66/77/81					1 987 470 040 <sup>7</sup>
	<b>1.8 TSI, TSI 4x4</b>	11.12→	132					1 987 470 040 <sup>7</sup>
	<b>2.0 FSI RS, TDI, TDI RS, TDI 4x4</b>	11.12→	105/110/135/162					1 987 470 040 <sup>7</sup>





◀ SKODA Octavia [5E3]



	1.2 TSI	11.12→	63/77	FPA,GBM	0 986 594 526 <sup>4</sup>	
				LAB	0 986 594 500 <sup>3</sup>	
				RAB	0 986 594 501 <sup>3</sup>	
	1.4 TSI	11.12→	81/103/	FPA,GBM	0 986 594 526 <sup>4</sup>	
	1.4 TSI G-Tec		110	LAB	0 986 594 500 <sup>3</sup>	
				RAB	0 986 594 501 <sup>3</sup>	
	1.6	11.12→	66/77/81	FPA,GBM	0 986 594 526 <sup>4</sup>	
	1.6 TDI			LAB	0 986 594 500 <sup>3</sup>	
	1.6 TDI 4x4			RAB	0 986 594 501 <sup>3</sup>	
	1.8 TSI	11.12→	132	RAB	0 986 594 501 <sup>3</sup>	
	1.8 TSI	11.12→	132	FPA,GBM	0 986 594 526 <sup>4</sup>	
	1.8 TSI 4x4			LAB	0 986 594 500 <sup>3</sup>	
	1.8 TSI 4x4	05.14→	132	FPA,LAB	0 986 594 504 <sup>4</sup>	
				FPA,RAB	0 986 594 505 <sup>4</sup>	
				RAB	0 986 594 501 <sup>3</sup>	
	2.0 FSI RS	11.12→	105/110/	FPA,GBM	0 986 594 526 <sup>4</sup>	
	2.0 TDI		135/162	LAB	0 986 594 500 <sup>3</sup>	
	2.0 TDI RS			RAB	0 986 594 501 <sup>3</sup>	
	2.0 TDI 4x4					

Pick-Up [6U7]



	1.6 MPI	10.95-03.01	55		0 986 473 112		← 53,95	1 987 470 507 <sup>8</sup>
					0 986 474 112		→ 53,95	1 987 470 507 <sup>8</sup>
	1.9 D	01.96-03.01	47		0 986 473 112		← 53,95	1 987 470 507 <sup>8</sup>
					0 986 474 112		→ 53,95	1 987 470 507 <sup>8</sup>
	135	09.91-03.01	40/42/43		0 986 473 112		← 53,95	1 987 470 507 <sup>8</sup>
	135 i.e., MPI				0 986 474 112		→ 53,95	1 987 470 507 <sup>8</sup>
	136 i.e.	07.93-03.01	50		0 986 473 112		← 53,95	1 987 470 507 <sup>8</sup>
	136 MPI				0 986 474 112		→ 53,95	1 987 470 507 <sup>8</sup>



	1.6 MPI	10.95-03.01	55		0 986 475 769	▲ ↔ 19	
					0 986 475 865	↔ 22,2	
	1.9 D	01.96-03.01	47		0 986 475 769	▲ ↔ 19	
					0 986 475 865	↔ 22,2	
	135	09.91-03.01	40/42/43		0 986 475 769	▲ ↔ 19	
	135 i.e., MPI				0 986 475 865	↔ 22,2	
	136 i.e.	07.93-03.01	50		0 986 475 769	▲ ↔ 19	
	136 MPI				0 986 475 865	↔ 22,2	















	1.6 MPI	10.95-03.01	55		1 987 477 680	1392
	1.9 D	01.96-03.01	47		1 987 477 680	1392
	135 i.e., MPI	01.93-03.01	40/42/43		1 987 477 680	1392
	136 i.e., MPI	07.93-03.01	50		1 987 477 680	1392

Praktik [5J7]



	1.2	03.07-03.09	51	252	0 986 473 071		← 54	1 987 470 506 <sup>8</sup>	
					0 986 474 071		→ 54	1 987 470 506 <sup>8</sup>	
					0 986 473 192		← 54	1 987 470 287 <sup>7</sup>	
					0 986 474 192		→ 54	1 987 470 287 <sup>7</sup>	
			03.09-05.15	51		0 986 473 071		← 54	1 987 470 506 <sup>8</sup>
						0 986 474 071		→ 54	1 987 470 506 <sup>8</sup>
	1.2 TDI	03.10-05.15	55		0 986 473 071		← 54	1 987 470 506 <sup>8</sup>	
					0 986 474 071		→ 54	1 987 470 506 <sup>8</sup>	

									
<b>1.2 TSI</b>	03.10-05.15	63	PR-Code 1LN, PR-Code 1ZH, PR-Code 1ZC	288		0 986 473 384	↔ 53,94	F 026 A06 106 <sup>7</sup>	
						0 986 473 384	↔ 53,94	1 987 470 506 <sup>8</sup>	
						0 986 474 384	↔ 53,94	F 026 A06 106 <sup>7</sup>	
				PR-Code 1LR, PR-Code 1ZJ, PR-Code 1ZG	252		0 986 473 071	↔ 54	1 987 470 506 <sup>8</sup>
							0 986 474 071	↔ 54	1 987 470 506 <sup>8</sup>
							0 986 473 192	↔ 54	1 987 470 287 <sup>7</sup>
<b>1.4</b>	03.07-03.10	63		252		0 986 473 071	↔ 54	1 987 470 506 <sup>8</sup>	
						0 986 474 071	↔ 54	1 987 470 506 <sup>8</sup>	
						0 986 473 192	↔ 54	1 987 470 287 <sup>7</sup>	
	03.10-05.15	63	PR-Code 1LN, PR-Code 1ZH, PR-Code 1ZC	288			0 986 473 384	↔ 53,94	F 026 A06 106 <sup>7</sup>
							0 986 473 384	↔ 53,94	1 987 470 506 <sup>8</sup>
							0 986 474 384	↔ 53,94	F 026 A06 106 <sup>7</sup>
			PR-Code 1LR, PR-Code 1ZJ, PR-Code 1ZG	252		0 986 473 071	↔ 54	1 987 470 506 <sup>8</sup>	
						0 986 474 071	↔ 54	1 987 470 506 <sup>8</sup>	
						0 986 473 192	↔ 54	1 987 470 287 <sup>7</sup>	
<b>1.4 TDI</b>	03.07-03.10	51/59		252		0 986 473 071	↔ 54	1 987 470 506 <sup>8</sup>	
						0 986 474 071	↔ 54	1 987 470 506 <sup>8</sup>	
						0 986 473 192	↔ 54	1 987 470 287 <sup>7</sup>	
				288		0 986 473 192	↔ 54	1 987 470 287 <sup>7</sup>	
						0 986 474 192	↔ 54	1 987 470 287 <sup>7</sup>	
						0 986 473 384	↔ 53,94	F 026 A06 106 <sup>7</sup>	
<b>1.6 TDI</b>	03.10-05.15	66	PR-Code 1LN, PR-Code 1ZH, PR-Code 1ZC	288		0 986 473 384	↔ 53,94	F 026 A06 106 <sup>7</sup>	
						0 986 473 384	↔ 53,94	1 987 470 506 <sup>8</sup>	
						0 986 474 384	↔ 53,94	F 026 A06 106 <sup>7</sup>	
				PR-Code 1LR, PR-Code 1ZJ, PR-Code 1ZG	252		0 986 473 071	↔ 54	1 987 470 506 <sup>8</sup>
							0 986 474 071	↔ 54	1 987 470 506 <sup>8</sup>
							0 986 473 192	↔ 54	1 987 470 287 <sup>7</sup>
	<b>1.2</b>	03.07-03.09	51			0 986 475 433	↔ 19,05		
		03.09-05.15	51	PR-Code 1KC			0 986 475 433	↔ 19,05	
		03.10-05.15	55/63	PR-Code 1KC			0 986 475 433	↔ 19,05	
		03.10-05.15	63	PR-Code 1KC			0 986 475 433	↔ 19,05	
		03.07-03.10	51				0 986 475 433	↔ 19,05	
		03.10-05.15	66	PR-Code 1KC			0 986 475 433	↔ 19,05	
	<b>1.2</b>	03.07-03.09	51			0 986 473 099	↔ 38,1	1 987 470 040 <sup>7</sup>	
		03.09-05.15	51	PR-Code 1KK			0 986 474 099	↔ 38,1	1 987 470 040 <sup>7</sup>
		03.09-05.15	51	PR-Code 1KK, PR-Code 1KT					1 987 470 040 <sup>7</sup>
		03.10-05.15	55/63						1 987 470 040 <sup>7</sup>
		03.07-05.09	51/59/63	PR-Code 1KK			0 986 473 099	↔ 38,1	
		03.07-05.15	51/59/63				0 986 474 099	↔ 38,1	
	<b>1.2</b>	03.07-05.15	51/55/63	PR-Code 1KT	SBR	1 987 482 193	↔ 1882		
		03.10-05.15	51/55/63	PR-Code 1KT	SBR	1 987 482 193	↔ 1882		
		03.10-05.15	51/55/63	PR-Code 1KT	SBR	1 987 482 193	↔ 1882		
		03.07-05.15	51/59/63	PR-Code 1KT	SBR	1 987 482 193	↔ 1882		
		03.07-03.10	51/59/63	PR-Code 1KT	SBR	1 987 482 193	↔ 1882		
		03.10-05.15	66	PR-Code 1KT	SBR	1 987 482 193	↔ 1882		
	<b>1.2</b>	03.07-05.15	51/55/63		LAB	0 986 594 500 <sup>3</sup>			
		12.12-05.15	51/55/63		RAB	0 986 594 501 <sup>3</sup>			
	<b>1.2 TDI</b>	12.12-05.15	51/55/63		LAB	0 986 594 502 <sup>4</sup>			
		12.12-05.15	51/55/63		RAB	0 986 594 503 <sup>4</sup>			
	<b>1.4</b>	03.07-05.15	63		LAB	0 986 594 500 <sup>3</sup>			
		12.12-05.15	63		RAB	0 986 594 501 <sup>3</sup>			
<b>1.4 TDI</b>	03.07-05.15	63		LAB	0 986 594 502 <sup>4</sup>				
	03.07-05.15	63		RAB	0 986 594 503 <sup>4</sup>				
<b>1.4 TDI</b>	03.07-03.10	51/59		LAB	0 986 594 500 <sup>3</sup>				
	03.07-03.10	51/59		RAB	0 986 594 501 <sup>3</sup>				



		S							
	◀ SKODA Praktik [5J7]								
	1.6 TDI	03.10-05.15	66			LAB	0986 594 500 <sup>3</sup>		
						RAB	0986 594 501 <sup>3</sup>		
		12.12-05.15	66			LAB	0986 594 502 <sup>4</sup>		
						RAB	0986 594 503 <sup>4</sup>		
<b>Rapid [NA2]</b>									
	1.6	09.11→	77			LAB	0986 594 500 <sup>3</sup>		
	1.6 TDI						0986 594 502 <sup>4</sup>		
						RAB	0986 594 501 <sup>3</sup>		
							0986 594 503 <sup>4</sup>		
<b>Rapid [NH3]</b>									
	1.2	07.12→	55/63/66/	PR-Code 1ZC	288		0986 473 384		◀ 53,94 F 026 A06 106 <sup>7</sup>
	1.2 TSI		77/81				0986 473 384		◀ 53,94 1987 470 506 <sup>8</sup>
							0986 474 384		→ 53,94 F 026 A06 106 <sup>7</sup>
				PR-Code 1ZG	252,NMD		0986 473 071		◀ 54
							0986 474 071		→ 54
	1.4 TDI	07.12→	66/90/92	PR-Code 1ZC	288		0986 473 384		◀ 53,94 F 026 A06 106 <sup>7</sup>
	1.4 TSI						0986 473 384		◀ 53,94 1987 470 506 <sup>8</sup>
							0986 474 384		→ 53,94 F 026 A06 106 <sup>7</sup>
				PR-Code 1ZG	252,NMD		0986 473 071		◀ 54
							0986 474 071		→ 54
	1.6	07.12→	77/81/85	PR-Code 1ZC	288		0986 473 384		◀ 53,94 F 026 A06 106 <sup>7</sup>
	1.6 TDI						0986 473 384		◀ 53,94 1987 470 506 <sup>8</sup>
							0986 474 384		→ 53,94 F 026 A06 106 <sup>7</sup>
				PR-Code 1ZG	252,NMD		0986 473 071		◀ 54
							0986 474 071		→ 54
	1.6 TDI	08.13-05.15	66	PR-Code 1ZC	288		0986 473 384		◀ 53,94 F 026 A06 106 <sup>7</sup>
							0986 473 384		◀ 53,94 1987 470 506 <sup>8</sup>
							0986 474 384		→ 53,94 F 026 A06 106 <sup>7</sup>
				PR-Code 1ZG	252		0986 473 071		◀ 54 1987 470 506 <sup>8</sup>
							0986 474 071		→ 54 1987 470 506 <sup>8</sup>
					252,NMD		0986 473 071		◀ 54
							0986 474 071		→ 54
	1.2, TSI	07.12→	55/63/66/77/81						1987 470 040 <sup>7</sup>
	1.4 TDI, TSI	07.12→	66/90/92						1987 470 040 <sup>7</sup>
	1.6, TDI	07.12→	66/77/81/85						1987 470 040 <sup>7</sup>
	1.2	07.12-06.15	55/63/66/77/81	PR-Code 1KL	822,HTB		1987 482 457		↔ 1707
				PR-Code 1KT	4SB		1987 482 458		↔ 1780
	1.2 TSI	07.12→	55/63/66/77/81	PR-Code 1KL	822,HTB		1987 482 457		↔ 1707
				PR-Code 1KT	4SB		1987 482 458		↔ 1780
	1.4 TDI	05.15→	66/90/92	PR-Code 1KL	822,HTB		1987 482 457		↔ 1707
				PR-Code 1KT	4SB		1987 482 458		↔ 1780
	1.4 TSI	07.12→	66/90/92	PR-Code 1KL	822,HTB		1987 482 457		↔ 1707
				PR-Code 1KT	4SB		1987 482 458		↔ 1780
	1.6	07.12→	66/77/81/85	PR-Code 1KL	822,HTB		1987 482 457		↔ 1707
				PR-Code 1KT	4SB		1987 482 458		↔ 1780
	1.6 TDI	07.12→	66/77/81/85	PR-Code 1KL	822,HTB		1987 482 457		↔ 1707
				PR-Code 1KT	4SB		1987 482 458		↔ 1780
	1.2	07.12-06.15	55/63/77			LAB	0986 594 500 <sup>3</sup>		
	1.2 TSI						0986 594 502 <sup>4</sup>		
						RAB	0986 594 501 <sup>3</sup>		
							0986 594 503 <sup>4</sup>		



		<b>S</b>								
1.4 TSI		07.12-06.15	90			LAB	0 986 594 500 <sup>3</sup>			
							0 986 594 502 <sup>4</sup>			
						RAB	0 986 594 501 <sup>3</sup>			
							0 986 594 503 <sup>4</sup>			
1.6		07.12→	66/77/81			LAB	0 986 594 500 <sup>3</sup>			
1.6 TDI							0 986 594 502 <sup>4</sup>			
						RAB	0 986 594 501 <sup>3</sup>			
							0 986 594 503 <sup>4</sup>			

**Rapid Spaceback [NH1]**

	1.2 TSI	10.13→	63/66/77/81	PR-Code 1ZC	288		0 986 473 384		← 53,94	F 026 A06 106 <sup>7</sup>
							0 986 473 384		← 53,94	1 987 470 506 <sup>8</sup>
							0 986 474 384		→ 53,94	F 026 A06 106 <sup>7</sup>
				PR-Code 1ZG	252,NMD		0 986 473 071		← 54	
							0 986 474 071		→ 54	
	1.4 TDI	10.13→	66/90/92	PR-Code 1ZC	288		0 986 473 384		← 53,94	F 026 A06 106 <sup>7</sup>
	1.4 TSI						0 986 473 384		← 53,94	1 987 470 506 <sup>8</sup>
							0 986 474 384		→ 53,94	F 026 A06 106 <sup>7</sup>
				PR-Code 1ZG	252,NMD		0 986 473 071		← 54	
							0 986 474 071		→ 54	
	1.6	10.13-06.15	77	PR-Code 1ZG	252,NMD		0 986 473 071		← 54	
	1.6	10.13-06.15	77	PR-Code 1ZC	288		0 986 474 384		→ 53,94	1 987 470 506 <sup>8</sup>
	1.6 TDI	10.13→	77	PR-Code 1ZC	288		0 986 473 384		← 53,94	1 987 470 506 <sup>8</sup>
							0 986 474 384		→ 53,94	F 026 A06 106 <sup>7</sup>
				PR-Code 1ZG	252,NMD		0 986 474 071		→ 54	
		05.15→	81/85	PR-Code 1ZC	288		0 986 473 384		← 53,94	F 026 A06 106 <sup>7</sup>
							0 986 473 384		← 53,94	1 987 470 506 <sup>8</sup>
							0 986 474 384		→ 53,94	F 026 A06 106 <sup>7</sup>
				PR-Code 1ZG	252,NMD		0 986 473 071		← 54	
							0 986 474 071		→ 54	
	1.6 TDI	10.13-05.15	66	PR-Code 1ZC	288		0 986 473 384		← 53,94	F 026 A06 106 <sup>7</sup>
							0 986 473 384		← 53,94	1 987 470 506 <sup>8</sup>
							0 986 474 384		→ 53,94	F 026 A06 106 <sup>7</sup>
				PR-Code 1ZG	252,NMD		0 986 473 071		← 54	
							0 986 474 071		→ 54	
		10.13→	77	PR-Code 1ZC	288		0 986 473 384		← 53,94	F 026 A06 106 <sup>7</sup>
				PR-Code 1ZG	252,NMD		0 986 473 071		← 54	

















































	1.2 TSI	10.13→	63/66/77/81							1 987 470 040 <sup>7</sup>
	1.4 TDI, TSI	10.13→	66/90/92							1 987 470 040 <sup>7</sup>
	1.6, TDI	10.13→	66/77/81/85							1 987 470 040 <sup>7</sup>

	1.2 TSI	10.13→	63/66/77/81	PR-Code 1KL	822,HTB		1 987 482 457		↔ 1707	
				PR-Code 1KT	4SB		1 987 482 458		↔ 1780	
	1.4 TDI	05.15→	66/90/92	PR-Code 1KL	822,HTB		1 987 482 457		↔ 1707	
				PR-Code 1KT	4SB		1 987 482 458		↔ 1780	
	1.4 TSI	10.13→	66/90/92	PR-Code 1KL	822,HTB		1 987 482 457		↔ 1707	
				PR-Code 1KT	4SB		1 987 482 458		↔ 1780	
	1.6	10.13→	66/77/81/85	PR-Code 1KL	822,HTB		1 987 482 457		↔ 1707	
				PR-Code 1KT	4SB		1 987 482 458		↔ 1780	
	1.6 TDI	10.13→	66/77/81/85	PR-Code 1KL	822,HTB		1 987 482 457		↔ 1707	
				PR-Code 1KT	4SB		1 987 482 458		↔ 1780	

	1.2 TSI	10.13-05.15	63/77			LAB	0 986 594 500 <sup>3</sup>			
							0 986 594 502 <sup>4</sup>			
						RAB	0 986 594 501 <sup>3</sup>			
							0 986 594 503 <sup>4</sup>			



			S									
<b>SKODA Rapid Spaceback [NH1]</b>												
1.4 TSI	10.13-06.15	90	LAB	0986 594 500 <sup>3</sup>		0986 594 502 <sup>4</sup>						
				RAB	0986 594 501 <sup>3</sup>		0986 594 503 <sup>4</sup>					
1.6	10.13→	66/77/81	LAB	0986 594 500 <sup>3</sup>		0986 594 502 <sup>4</sup>						
1.6 TDI			RAB	0986 594 501 <sup>3</sup>		0986 594 503 <sup>4</sup>						
<b>Roomster [5J7]</b>												
	1.2	05.06-01.07	47	252	0986 473 071		54		1987 470 506 <sup>8</sup>			
					0986 474 071		54		1987 470 506 <sup>8</sup>			
				01.07-03.09	51	252	0986 473 192		54		1987 470 287 <sup>7</sup>	
							0986 474 192		54		1987 470 287 <sup>7</sup>	
				03.09-05.15	51	288	0986 473 071		54		1987 470 506 <sup>8</sup>	
							0986 474 071		54		1987 470 506 <sup>8</sup>	
			03.10-05.15	55	288	0986 473 192		54		1987 470 287 <sup>7</sup>		
						0986 474 192		54		1987 470 287 <sup>7</sup>		
			03.10-05.15	63/77	PR-Code 1LN, PR-Code 1ZH, PR-Code 1ZC	288	0986 473 384		53,94		F 026 A06 106 <sup>7</sup>	
							0986 474 384		53,94		F 026 A06 106 <sup>7</sup>	
			03.10-05.15	63	PR-Code 1LR, PR-Code 1ZJ, PR-Code 1ZG	252	0986 473 071		54		1987 470 506 <sup>8</sup>	
							0986 474 071		54		1987 470 506 <sup>8</sup>	
		05.06-03.10	63	252	0986 473 071		54		1987 470 506 <sup>8</sup>			
					0986 474 071		54		1987 470 506 <sup>8</sup>			
		05.06-03.10	63	288	0986 473 192		54		1987 470 287 <sup>7</sup>			
					0986 474 192		54		1987 470 287 <sup>7</sup>			
		03.10-05.15	63	PR-Code 1LN, PR-Code 1ZH, PR-Code 1ZC	288	0986 473 384		53,94		F 026 A06 106 <sup>7</sup>		
						0986 474 384		53,94		F 026 A06 106 <sup>7</sup>		
		03.10-05.15	63	PR-Code 1LR, PR-Code 1ZJ, PR-Code 1ZG	252	0986 473 071		54		1987 470 506 <sup>8</sup>		
						0986 474 071		54		1987 470 506 <sup>8</sup>		
		05.06-03.10	51/59	252	0986 473 071		54		1987 470 506 <sup>8</sup>			
					0986 474 071		54		1987 470 506 <sup>8</sup>			
		05.06-03.10	51/59	288	0986 473 192		54		1987 470 287 <sup>7</sup>			
					0986 474 192		54		1987 470 287 <sup>7</sup>			
		05.06-07.10	77	252	0986 473 071		54		1987 470 506 <sup>8</sup>			
					0986 474 071		54		1987 470 506 <sup>8</sup>			
		05.06-07.10	77	288	0986 473 192		54		1987 470 287 <sup>7</sup>			
					0986 474 192		54		1987 470 287 <sup>7</sup>			
		06.10-05.15	77	PR-Code 1LN, PR-Code 1ZH, PR-Code 1ZC	288	0986 473 384		53,94		F 026 A06 106 <sup>7</sup>		
						0986 474 384		53,94		F 026 A06 106 <sup>7</sup>		
		06.10-05.15	77	PR-Code 1LR, PR-Code 1ZJ, PR-Code 1ZG	252	0986 473 071		54		1987 470 506 <sup>8</sup>		
						0986 474 071		54		1987 470 506 <sup>8</sup>		
		03.10-05.15	77	PR-Code 1LN, PR-Code 1ZH, PR-Code 1ZC	288	0986 473 384		53,94		F 026 A06 106 <sup>7</sup>		
						0986 474 384		53,94		F 026 A06 106 <sup>7</sup>		
		03.10-05.15	66	PR-Code 1LR, PR-Code 1ZJ, PR-Code 1ZG	252	0986 473 071		54		1987 470 506 <sup>8</sup>		
						0986 474 071		54		1987 470 506 <sup>8</sup>		
		03.10-05.15	66	PR-Code 1LN, PR-Code 1ZH, PR-Code 1ZC	288	0986 473 384		53,94		F 026 A06 106 <sup>7</sup>		
						0986 474 384		53,94		F 026 A06 106 <sup>7</sup>		
		03.10-05.15	66	PR-Code 1LR, PR-Code 1ZJ, PR-Code 1ZG	252	0986 473 071		54		1987 470 506 <sup>8</sup>		
						0986 474 071		54		1987 470 506 <sup>8</sup>		
		03.06-03.10	74/77	252	0986 473 071		54		1987 470 506 <sup>8</sup>			
					0986 474 071		54		1987 470 506 <sup>8</sup>			

		S							
1.9 TDI		03.06-03.10	74/77			288	0 986 473 192	 54	1 987 470 287 <sup>7</sup>
							0 986 474 192	 54	1 987 470 287 <sup>7</sup>
									
	1.2	05.06-01.07	47				0 986 475 433	 19,05	
		01.07-03.09	51				0 986 475 433	 19,05	
		03.09-05.15	51	PR-Code 1KC			0 986 475 433	 19,05	
	1.2 TDI, TSI	03.10-05.15	55/63/77	PR-Code 1KC			0 986 475 433	 19,05	
	1.4	05.06-03.10	63				0 986 475 433	 19,05	
		03.10-05.15	63	PR-Code 1KC			0 986 475 433	 19,05	
	1.4 TDI	07.06-03.10	51				0 986 475 433	 19,05	
	1.6	05.06-07.10	77				0 986 475 433	 19,05	
		06.10-05.15	77	PR-Code 1KC			0 986 475 433	 19,05	
	1.6 TDI	03.10-05.15	66	PR-Code 1KC			0 986 475 433	 19,05	
		77	PR-Code 1KC			0 986 475 433	 19,05		
	1.2	05.06-01.07	47				0 986 473 099	 38,1	1 987 470 040 <sup>7</sup>
							0 986 474 099	 38,1	1 987 470 040 <sup>7</sup>
		01.07-03.09	51				0 986 473 099	 38,1	1 987 470 040 <sup>7</sup>
							0 986 474 099	 38,1	1 987 470 040 <sup>7</sup>
		03.09-05.09	51	PR-Code 1KK			0 986 473 099	 38,1	
							0 986 474 099	 38,1	
		03.09-05.15	51	PR-Code 1KK, PR-Code 1KT					1 987 470 040 <sup>7</sup>
	1.2 TDI, TSI	03.10-05.15	55/63/77						1 987 470 040 <sup>7</sup>
	1.4	05.06-05.09	51/59/63	PR-Code 1KK			0 986 473 099	 38,1	
	1.4 TDI						0 986 474 099	 38,1	
		05.06-05.15	51/59/63						1 987 470 040 <sup>7</sup>
	1.6	05.06-05.09	77	PR-Code 1KK			0 986 473 099	 38,1	
							0 986 474 099	 38,1	
1.6, TDI	05.06-05.15	77						1 987 470 040 <sup>7</sup>	
1.6 TDI	03.10-05.15	66						1 987 470 040 <sup>7</sup>	
1.9 TDI	03.06-05.06	74				0 986 473 099	 38,1	1 987 470 040 <sup>7</sup>	
						0 986 474 099	 38,1	1 987 470 040 <sup>7</sup>	
	05.06-05.09	77	PR-Code 1KK			0 986 473 099	 38,1		
						0 986 474 099	 38,1		
	05.06-03.10	77						1 987 470 040 <sup>7</sup>	
									
	1.2	05.06-05.15	47/51/55/63/77	PR-Code 1KT	SBR		1 987 482 193	 1882	
	1.2 TDI	03.10-05.15	47/51/55/63/77	PR-Code 1KT	SBR		1 987 482 193	 1882	
	1.2 TSI	03.10-05.15	47/51/55/63/77	PR-Code 1KT	SBR		1 987 482 193	 1882	
	1.4	05.06-05.15	51/59/63	PR-Code 1KT	SBR		1 987 482 193	 1882	
	1.4 TDI	05.06-03.10	51/59/63	PR-Code 1KT	SBR		1 987 482 193	 1882	
	1.6	05.06-05.15	66/77	PR-Code 1KT	SBR		1 987 482 193	 1882	
	1.6 TDI	03.10-05.15	66/77	PR-Code 1KT	SBR		1 987 482 193	 1882	
	1.9 TDI	03.06-03.10	74/77	PR-Code 1KT	SBR		1 987 482 193	 1882	
		1.2	05.06-01.07	47		LAB		0 986 594 500 <sup>3</sup>	
					RAB		0 986 594 501 <sup>3</sup>		
1.2		01.07-05.15	51/55/63/77		LAB		0 986 594 500 <sup>3</sup>		
1.2 TDI					RAB		0 986 594 501 <sup>3</sup>		
1.2 TSI		12.12-05.15	51/55/63/77		LAB		0 986 594 502 <sup>4</sup>		
					RAB		0 986 594 503 <sup>4</sup>		
1.4		05.06-05.15	63		LAB		0 986 594 500 <sup>3</sup>		
					RAB		0 986 594 501 <sup>3</sup>		
		12.12-05.15	63		LAB		0 986 594 502 <sup>4</sup>		
					RAB		0 986 594 503 <sup>4</sup>		
1.4 TDI		05.06-03.10	51/59		LAB		0 986 594 500 <sup>3</sup>		
					RAB		0 986 594 501 <sup>3</sup>		

		S							
<b>SKODA Roomster [5J7]</b>									
1.6		05.06-05.15	66/77			LAB	0986 594 500 <sup>3</sup>		
1.6 TDI		12.12-05.15	66/77			RAB	0986 594 501 <sup>3</sup>		
						LAB	0986 594 502 <sup>4</sup>		
						RAB	0986 594 503 <sup>4</sup>		
1.9 TDI		03.06-03.10	74/77			LAB	0986 594 500 <sup>3</sup>		
						RAB	0986 594 501 <sup>3</sup>		
<b>Superb Combi [3T5]</b>									
	1.4 TSI	09.09-05.15	92				0986 473 384		← 53,94 F 026 A06 106 <sup>7</sup>
							0986 473 384		← 53,94 1987 470 506 <sup>8</sup>
							0986 474 384		→ 53,94 F 026 A06 106 <sup>7</sup>
1.6 TDI	09.10-05.15	77					0986 473 384		← 53,94 F 026 A06 106 <sup>7</sup>
							0986 473 384		← 53,94 1987 470 506 <sup>8</sup>
							0986 474 384		→ 53,94 F 026 A06 106 <sup>7</sup>
1.8 TSI	03.09-05.15	112/118					0986 473 384		← 53,94 F 026 A06 106 <sup>7</sup>
							0986 473 384		← 53,94 1987 470 506 <sup>8</sup>
							0986 474 384		→ 53,94 F 026 A06 106 <sup>7</sup>
1.8 TSI 4x4	03.09-05.15	112/118					0986 473 384		← 53,94 1987 470 506 <sup>8</sup>
							0986 473 384		← 53,94 F 026 A06 106 <sup>7</sup>
							0986 474 384		→ 53,94 F 026 A06 106 <sup>7</sup>
1.9 TDI	09.09-11.10	77					0986 473 384		← 53,94 F 026 A06 106 <sup>7</sup>
							0986 473 384		← 53,94 1987 470 506 <sup>8</sup>
							0986 474 384		→ 53,94 F 026 A06 106 <sup>7</sup>
2.0 TDI	09.09-05.15	103/125					0986 473 384		← 53,94 F 026 A06 106 <sup>7</sup>
							0986 473 384		← 53,94 1987 470 506 <sup>8</sup>
							0986 474 384		→ 53,94 F 026 A06 106 <sup>7</sup>
2.0 TDI 4x4	09.09-05.15	103/125					0986 473 384		← 53,94 F 026 A06 106 <sup>7</sup>
							0986 473 384		← 53,94 1987 470 506 <sup>8</sup>
							0986 474 384		→ 53,94 F 026 A06 106 <sup>7</sup>
2.0 TSI	05.10-04.13	147		PR-Code 1LK			0986 134 257		← F 026 A03 545 <sup>7</sup>
							0986 134 257		← 1987 470 506 <sup>8</sup>
							0986 135 257		→ F 026 A03 545 <sup>7</sup>
2.0 TSI	05.10-05.15	147		PR-Code 1LJ, PR-Code 1ZA	312		0986 473 384		← 53,94 F 026 A06 106 <sup>7</sup>
							0986 473 384		← 53,94 1987 470 506 <sup>8</sup>
							0986 474 384		→ 53,94 F 026 A06 106 <sup>7</sup>
3.6 V6 4x4	09.09-04.13	191		PR-Code 1LK			0986 134 257		← F 026 A03 545 <sup>7</sup>
							0986 134 257		← 1987 470 506 <sup>8</sup>
							0986 135 257		→ F 026 A03 545 <sup>7</sup>
3.6 V6 4x4	09.09-05.15	191		PR-Code 1LJ, PR-Code 1ZA	312		0986 473 384		← 53,94 F 026 A06 106 <sup>7</sup>
							0986 473 384		← 53,94 1987 470 506 <sup>8</sup>
							0986 474 384		→ 53,94 F 026 A06 106 <sup>7</sup>
	1.4 TSI	09.09-05.15	92		PR-Code 1KF, PR-Code 1KJ		0986 473 448		← 41
							0986 474 448		→ 41
							PR-Code 1KS	0986 134 203	
1.6 TDI	09.10-05.15	77			PR-Code 1KF, PR-Code 1KJ		0986 135 203		→ 38
							0986 473 448		← 41
							0986 474 448		→ 41
1.8 TSI	03.09-05.15	112/118			PR-Code 1KF, PR-Code 1KJ		0986 134 203		← 38
							0986 473 448		← 41
							0986 474 448		→ 41
1.8 TSI 4x4	03.09-05.15	112/118			PR-Code 1KF, PR-Code 1KJ		0986 134 203		← 38
							0986 473 448		← 41
							0986 474 448		→ 41
1.9 TDI	09.09-11.10	77			PR-Code 1KF, PR-Code 1KJ		0986 135 203		→ 38
							0986 473 448		← 41
							0986 474 448		→ 41
1.9 TDI	11.09-11.10	77			PR-Code 1KS		0986 134 203		← 38
							0986 135 203		→ 38
							0986 135 203		→ 38
2.0 TDI	09.09-05.15	103/125/147			PR-Code 1KF, PR-Code 1KJ		0986 473 448		← 41
							0986 474 448		→ 41
							0986 134 203		← 38
2.0 TDI 4x4	09.09-05.15	103/125/147			PR-Code 1KF, PR-Code 1KJ		0986 134 203		← 38
							0986 473 448		← 41
							0986 474 448		→ 41
2.0 TSI	11.09-05.15	103/125/147			PR-Code 1KS		0986 135 203		→ 38
							0986 135 203		→ 38
							0986 135 203		→ 38
3.6 V6 4x4	09.09-05.15	191					0986 134 297		← 1987 474 496 <sup>8</sup>
							0986 134 297		← 1987 474 496 <sup>8</sup>
							0986 135 297		→ 1987 474 496 <sup>8</sup>



	1.4 TSI	09.09-05.15	92		1 987 477 695	↔ 1514
	1.6 TDI	09.10-05.15	77		1 987 477 695	↔ 1514
	1.8 TSI	03.09-05.15	112/118		1 987 477 695	↔ 1514
	1.8 TSI 4x4	03.09-05.15	112/118		1 987 477 695	↔ 1514
	1.9 TDI	09.09-11.10	77		1 987 477 695	↔ 1514
	2.0 TDI	09.09-05.15	103/125/147		1 987 477 695	↔ 1514
	2.0 TDI 4x4	09.09-05.15	103/125/147		1 987 477 695	↔ 1514
	2.0 TSI	05.10-05.15	103/125/147		1 987 477 695	↔ 1514
	3.6 V6 4x4	09.09-05.15	191		1 987 477 695	↔ 1514

	1.4 TSI	09.09-05.15	92	FPA,LAB	0 986 594 561 <sup>4</sup>	
				FPA,RAB	0 986 594 560 <sup>4</sup>	
				FPA,LAB	0 986 594 506 <sup>4</sup>	
				FPA,RAB	0 986 594 507 <sup>4</sup>	
				LAB	0 986 594 504 <sup>3</sup>	
				RAB	0 986 594 505 <sup>3</sup>	
	1.6 TDI	09.10-05.15	77	FPA,LAB	0 986 594 561 <sup>4</sup>	
				FPA,RAB	0 986 594 560 <sup>4</sup>	
				FPA,LAB	0 986 594 506 <sup>4</sup>	
				FPA,RAB	0 986 594 507 <sup>4</sup>	
				LAB	0 986 594 504 <sup>3</sup>	
				RAB	0 986 594 505 <sup>3</sup>	
	1.8 TSI	03.09-05.15	112/118	FPA,LAB	0 986 594 561 <sup>4</sup>	
				FPA,RAB	0 986 594 560 <sup>4</sup>	
				FPA,LAB	0 986 594 506 <sup>4</sup>	
				FPA,RAB	0 986 594 507 <sup>4</sup>	
				LAB	0 986 594 504 <sup>3</sup>	
				RAB	0 986 594 505 <sup>3</sup>	
1.8 TSI 4x4	03.09-05.15	112/118	FPA,LAB	0 986 594 504 <sup>4</sup>		
			FPA,RAB	0 986 594 505 <sup>4</sup>		
			LAB	0 986 594 504 <sup>3</sup>		
			RAB	0 986 594 505 <sup>3</sup>		
			LAB	0 986 594 504 <sup>3</sup>		
			RAB	0 986 594 505 <sup>3</sup>		
1.9 TDI	09.09-11.10	77	LAB	0 986 594 504 <sup>3</sup>		
				0 986 594 506 <sup>4</sup>		
			RAB	0 986 594 505 <sup>3</sup>		
				0 986 594 507 <sup>4</sup>		
				0 986 594 506 <sup>4</sup>		
				0 986 594 507 <sup>4</sup>		
2.0 TDI	09.09-03.10	103	LAB	0 986 594 506 <sup>4</sup>		
			RAB	0 986 594 507 <sup>4</sup>		
	09.09-05.10	125	LAB	0 986 594 506 <sup>4</sup>		
			RAB	0 986 594 507 <sup>4</sup>		
	09.09-05.15	103	LAB	0 986 594 504 <sup>3</sup>		
			RAB	0 986 594 505 <sup>3</sup>		
		125	LAB	0 986 594 504 <sup>3</sup>		
			RAB	0 986 594 505 <sup>3</sup>		
	02.10-05.15	103	FPA,LAB	0 986 594 561 <sup>4</sup>		
			FPA,RAB	0 986 594 560 <sup>4</sup>		
			FPA,LAB	0 986 594 506 <sup>4</sup>		
			FPA,RAB	0 986 594 507 <sup>4</sup>		
05.10-05.15	125	FPA,LAB	0 986 594 561 <sup>4</sup>			
		FPA,RAB	0 986 594 560 <sup>4</sup>			
		FPA,LAB	0 986 594 506 <sup>4</sup>			
		FPA,RAB	0 986 594 507 <sup>4</sup>			
2.0 TDI 4x4	09.09-05.10	125	LAB	0 986 594 504 <sup>4</sup>		
			RAB	0 986 594 507 <sup>4</sup>		
	09.09-05.15	125	LAB	0 986 594 504 <sup>3</sup>		
			RAB	0 986 594 505 <sup>3</sup>		
	05.10-05.15	125	FPA,LAB	0 986 594 504 <sup>4</sup>		
			FPA,RAB	0 986 594 505 <sup>4</sup>		
11.10-05.15	103	FPA,LAB	0 986 594 504 <sup>4</sup>			
		FPA,RAB	0 986 594 505 <sup>4</sup>			
		LAB	0 986 594 504 <sup>3</sup>			



<b>SKODA Superb Combi [3T5]</b>									
2.0 TDI 4x4	11.10-05.15	103			RAB	0986 594 505 <sup>3</sup>			
2.0 TSI	05.10-05.15	147			FPA,LAB	0986 594 561 <sup>4</sup>			
					FPA,RAB	0986 594 560 <sup>4</sup>			
					FPA,LAB	0986 594 506 <sup>4</sup>			
					FPA,RAB	0986 594 507 <sup>4</sup>			
					LAB	0986 594 504 <sup>3</sup>			
3.6 V6 4x4	09.09-05.15	191			RAB	0986 594 505 <sup>3</sup>			
					FPA,LAB	0986 594 504 <sup>4</sup>			
					FPA,RAB	0986 594 505 <sup>4</sup>			
					LAB	0986 594 504 <sup>3</sup>			
					RAB	0986 594 505 <sup>3</sup>			
<b>Superb [3T4]</b>									
	1.4 TSI	04.08-05.15	92			0986 473 384		← 53,94	F 026 A06 106 <sup>7</sup>
						0986 473 384		← 53,94	1987 470 506 <sup>8</sup>
						0986 474 384		→ 53,94	F 026 A06 106 <sup>7</sup>
1.6 TDI	09.10-05.15	77			0986 473 384		← 53,94	F 026 A06 106 <sup>7</sup>	
					0986 473 384		← 53,94	1987 470 506 <sup>8</sup>	
					0986 474 384		→ 53,94	F 026 A06 106 <sup>7</sup>	
1.8 TSI	03.08-05.09	118		PR-Code 1ZE, PR-Code 1ZA, PR-Code 1LJ	288,312	0986 473 384		← 53,94	F 026 A06 106 <sup>7</sup>
						0986 473 384		← 53,94	1987 470 506 <sup>8</sup>
						0986 474 384		→ 53,94	F 026 A06 106 <sup>7</sup>
	09.08-05.15	118			0986 473 384		← 53,94	F 026 A06 106 <sup>7</sup>	
					0986 473 384		← 53,94	1987 470 506 <sup>8</sup>	
					0986 474 384		→ 53,94	F 026 A06 106 <sup>7</sup>	
1.8 TSI	03.09-05.15	112			0986 473 384		← 53,94	F 026 A06 106 <sup>7</sup>	
			1.8 TSI 4x4			0986 473 384		← 53,94	1987 470 506 <sup>8</sup>
						0986 474 384		→ 53,94	F 026 A06 106 <sup>7</sup>
1.8 TSI 4x4	11.08-05.15	118			0986 473 384		← 53,94	F 026 A06 106 <sup>7</sup>	
					0986 473 384		← 53,94	1987 470 506 <sup>8</sup>	
					0986 474 384		→ 53,94	F 026 A06 106 <sup>7</sup>	
1.9 TDI	03.08-11.10	77			0986 473 384		← 53,94	F 026 A06 106 <sup>7</sup>	
					0986 473 384		← 53,94	1987 470 506 <sup>8</sup>	
					0986 474 384		→ 53,94	F 026 A06 106 <sup>7</sup>	
2.0 TDI	03.08-05.15	103/125			0986 473 384		← 53,94	F 026 A06 106 <sup>7</sup>	
			2.0 TDI 4x4			0986 473 384		← 53,94	1987 470 506 <sup>8</sup>
						0986 474 384		→ 53,94	F 026 A06 106 <sup>7</sup>
2.0 TSI	05.10-04.13	147		PR-Code 1LK		0986 134 257		←	F 026 A03 545 <sup>7</sup>
						0986 134 257		←	1987 470 506 <sup>8</sup>
						0986 135 257		→	F 026 A03 545 <sup>7</sup>
	05.10-05.15	147			0986 473 384		← 53,94	F 026 A06 106 <sup>7</sup>	
					0986 473 384		← 53,94	1987 470 506 <sup>8</sup>	
					0986 474 384		→ 53,94	F 026 A06 106 <sup>7</sup>	
3.6 V6 4x4	11.08-04.13	191		PR-Code 1LK		0986 134 257		←	F 026 A03 545 <sup>7</sup>
						0986 134 257		←	1987 470 506 <sup>8</sup>
						0986 135 257		→	F 026 A03 545 <sup>7</sup>
	11.08-05.15	191		PR-Code 1LJ, PR-Code 1ZA	312	0986 473 384		← 53,94	F 026 A06 106 <sup>7</sup>
						0986 473 384		← 53,94	1987 470 506 <sup>8</sup>
						0986 474 384		→ 53,94	F 026 A06 106 <sup>7</sup>
1.4 TSI	04.08-05.15	92		PR-Code 1KF, PR-Code 1KJ		0986 473 448		← 41	
						0986 474 448		→ 41	
						0986 134 203		← 38	
1.6 TDI	09.10-05.15	77		PR-Code 1KF, PR-Code 1KJ		0986 135 203		→ 38	
						0986 473 448		← 41	
						0986 474 448		→ 41	
				PR-Code 1KS		0986 134 203		← 38	
						0986 135 203		→ 38	



<b>1.8 TSI</b>	03.08-05.15	112/118	PR-Code 1KF, PR-Code 1KJ	0 986 473 448	↔ 41	
				0 986 474 448	↔ 41	
<b>1.8 TSI 4x4</b>	09.08-05.15	112/118	PR-Code 1KS	0 986 134 203	↔ 38	
				0 986 135 203	↔ 38	
<b>1.9 TDI</b>	03.08-11.10	77	PR-Code 1KF, PR-Code 1KJ	0 986 473 448	↔ 41	
				0 986 474 448	↔ 41	
	11.09-11.10	77	PR-Code 1KS	0 986 134 203	↔ 38	
			0 986 135 203	↔ 38		
<b>2.0 TDI</b>	03.08-05.15	103/125/	PR-Code 1KF, PR-Code 1KJ	0 986 473 448	↔ 41	
				0 986 474 448	↔ 41	
<b>2.0 TDI 4x4</b>		147				
<b>2.0 TSI</b>	11.09-05.15	103/125/	PR-Code 1KS	0 986 134 203	↔ 38	
				0 986 135 203	↔ 38	
<b>3.6 V6 4x4</b>	11.08-05.15	191		0 986 134 297	↔ 41	1 987 474 496 <sup>B</sup>
				0 986 135 297	↔ 41	1 987 474 496 <sup>B</sup>



<b>1.4 TSI</b>	04.08-11.08	92		1 987 482 265	↔ 1590		
	12.08-05.15	92		1 987 477 695	↔ 1514		
<b>1.6 TDI</b>	09.10-05.15	77		1 987 477 695	↔ 1514		
<b>1.8 TSI</b>	03.08-11.08	118		1 987 482 265	↔ 1590		
	12.08-05.15	118		1 987 477 695	↔ 1514		
<b>1.8 TSI 4x4</b>	03.09-05.15	112		1 987 477 695	↔ 1514		
	11.08-05.15	118		1 987 477 695	↔ 1514		
			03.09-05.15	112		1 987 477 695	↔ 1514
<b>1.9 TDI</b>	03.08-11.10	77		1 987 477 695	↔ 1514		
<b>2.0 TDI</b>	03.08-05.15	103/125/147		1 987 477 695	↔ 1514		
<b>2.0 TDI 4x4</b>	09.08-05.15	103/125/147		1 987 477 695	↔ 1514		
<b>2.0 TSI</b>	05.10-05.15	103/125/147		1 987 477 695	↔ 1514		
<b>3.6 V6 4x4</b>	11.08-05.15	191		1 987 477 695	↔ 1514		

<b>1.4 TSI</b>	04.08-05.15	92	FPA,LAB	0 986 594 561 <sup>4</sup>		
			FPA,RAB	0 986 594 560 <sup>4</sup>		
			FPA,LAB	0 986 594 506 <sup>4</sup>		
			FPA,RAB	0 986 594 507 <sup>4</sup>		
			LAB	0 986 594 504 <sup>3</sup>		
			RAB	0 986 594 505 <sup>3</sup>		
<b>1.6 TDI</b>	09.10-05.15	77	FPA,LAB	0 986 594 561 <sup>4</sup>		
			FPA,RAB	0 986 594 560 <sup>4</sup>		
			FPA,LAB	0 986 594 506 <sup>4</sup>		
			FPA,RAB	0 986 594 507 <sup>4</sup>		
			LAB	0 986 594 504 <sup>3</sup>		
			RAB	0 986 594 505 <sup>3</sup>		
<b>1.8 TSI</b>	03.08-05.09	118	LAB	0 986 594 506 <sup>4</sup>		
			RAB	0 986 594 507 <sup>4</sup>		
	03.08-05.15	118	LAB	0 986 594 504 <sup>3</sup>		
			RAB	0 986 594 505 <sup>3</sup>		
	09.08-05.15	118	FPA,LAB	0 986 594 561 <sup>4</sup>		
			FPA,RAB	0 986 594 560 <sup>4</sup>		
			FPA,LAB	0 986 594 506 <sup>4</sup>		
			FPA,RAB	0 986 594 507 <sup>4</sup>		
	03.09-05.15	112	FPA,LAB	0 986 594 561 <sup>4</sup>		
			FPA,RAB	0 986 594 560 <sup>4</sup>		
			FPA,LAB	0 986 594 506 <sup>4</sup>		
			FPA,RAB	0 986 594 507 <sup>4</sup>		
LAB			0 986 594 504 <sup>3</sup>			
			0 986 594 505 <sup>3</sup>			
	<b>1.8 TSI 4x4</b>	11.08-05.15	118	FPA,LAB	0 986 594 504 <sup>4</sup>	
				FPA,RAB	0 986 594 505 <sup>4</sup>	
LAB				0 986 594 504 <sup>3</sup>		
RAB				0 986 594 505 <sup>3</sup>		
03.09-05.15	112	FPA,LAB	0 986 594 504 <sup>4</sup>			
		FPA,RAB	0 986 594 505 <sup>4</sup>			

















		S							
<b>SKODA Superb [3T4]</b>									
<b>1.8 TSI 4x4</b>	03.09-05.15	112		LAB	0986	594 504 <sup>3</sup>			
						RAB	0986	594 505 <sup>3</sup>	
<b>1.9 TDI</b>	03.08-11.10	77		LAB	0986	594 504 <sup>3</sup>			
						RAB	0986	594 506 <sup>4</sup>	
				LAB	0986	594 505 <sup>3</sup>			
						RAB	0986	594 507 <sup>4</sup>	
<b>2.0 TDI</b>	03.08-03.10	103		LAB	0986	594 506 <sup>4</sup>			
				RAB	0986	594 507 <sup>4</sup>			
	03.08-05.15	103		LAB	0986	594 504 <sup>3</sup>			
				RAB	0986	594 505 <sup>3</sup>			
	06.08-05.10	125		LAB	0986	594 506 <sup>4</sup>			
				RAB	0986	594 507 <sup>4</sup>			
	06.08-05.15	125		LAB	0986	594 504 <sup>3</sup>			
				RAB	0986	594 505 <sup>3</sup>			
	02.10-05.15	103		FPA,LAB	0986	594 561 <sup>4</sup>			
				FPA,RAB	0986	594 560 <sup>4</sup>			
				FPA,LAB	0986	594 506 <sup>4</sup>			
				FPA,RAB	0986	594 507 <sup>4</sup>			
				FPA,LAB	0986	594 561 <sup>4</sup>			
				FPA,RAB	0986	594 560 <sup>4</sup>			
				FPA,LAB	0986	594 506 <sup>4</sup>			
				FPA,RAB	0986	594 507 <sup>4</sup>			
05.10-05.15	125		FPA,LAB	0986	594 561 <sup>4</sup>				
			FPA,RAB	0986	594 560 <sup>4</sup>				
<b>2.0 TDI 4x4</b>	09.08-05.10	125		LAB	0986	594 504 <sup>4</sup>			
				RAB	0986	594 507 <sup>4</sup>			
	09.08-05.15	125		LAB	0986	594 504 <sup>3</sup>			
				RAB	0986	594 505 <sup>3</sup>			
	05.10-05.15	125		FPA,LAB	0986	594 504 <sup>4</sup>			
				FPA,RAB	0986	594 505 <sup>4</sup>			
	11.10-05.15	103		FPA,LAB	0986	594 504 <sup>4</sup>			
				FPA,RAB	0986	594 505 <sup>4</sup>			
LAB				0986	594 504 <sup>3</sup>				
RAB				0986	594 505 <sup>3</sup>				
<b>2.0 TSI</b>	05.10-05.15	147		FPA,LAB	0986	594 561 <sup>4</sup>			
				FPA,RAB	0986	594 560 <sup>4</sup>			
				FPA,LAB	0986	594 506 <sup>4</sup>			
				FPA,RAB	0986	594 507 <sup>4</sup>			
				LAB	0986	594 504 <sup>3</sup>			
				RAB	0986	594 505 <sup>3</sup>			
				FPA,LAB	0986	594 504 <sup>4</sup>			
				FPA,RAB	0986	594 505 <sup>4</sup>			
<b>3.6 V6 4x4</b>	11.08-05.15	191		FPA,LAB	0986	594 504 <sup>4</sup>			
				FPA,RAB	0986	594 505 <sup>4</sup>			
				LAB	0986	594 504 <sup>3</sup>			
				RAB	0986	594 505 <sup>3</sup>			

<b>Superb [3U4]</b>									
	<b>1.8 T</b>	12.01-03.08	110	PR-Code 1LT	312	0986 473 070		← 56,93	1987 470 005 <sup>7</sup>
						0986 473 070		← 56,93	1987 470 506 <sup>8</sup>
						0986 474 070		→ 56,93	1987 470 005 <sup>7</sup>
						PR-Code 1ZC	288	0986 473 070	
	1.9 TDI	12.01-03.08	74/77/85/96	PR-Code 1LT	312	0986 473 070		← 56,93	1987 470 005 <sup>7</sup>
						0986 473 070		← 56,93	1987 470 506 <sup>8</sup>
						0986 474 070		→ 56,93	1987 470 005 <sup>7</sup>
						PR-Code 1ZC	288	0986 473 070	
<b>2.0</b>	12.01-03.08	85/91/103	PR-Code 1LT	312	0986 473 070		← 56,93	1987 470 005 <sup>7</sup>	
					0986 473 070		← 56,93	1987 470 506 <sup>8</sup>	
					0986 474 070		→ 56,93	1987 470 005 <sup>7</sup>	
					0986 474 070		→ 56,93	1987 470 005 <sup>7</sup>	

		S							
2.0	12.01-03.08	85/91/103	PR-Code 1ZC	288	0 986 473 070		← 56,93	1 987 470 005 <sup>7</sup>	
2.0 TDI					0 986 473 070		← 56,93	1 987 470 506 <sup>8</sup>	
					0 986 474 070		→ 56,93	1 987 470 005 <sup>7</sup>	
2.5 TDI	12.01-03.08	114/120	PR-Code 1LT	312	0 986 473 070		← 56,93	1 987 470 005 <sup>7</sup>	
					0 986 473 070		← 56,93	1 987 470 506 <sup>8</sup>	
					0 986 474 070		→ 56,93	1 987 470 005 <sup>7</sup>	
			PR-Code 1ZC	288	0 986 473 070		← 56,93	1 987 470 005 <sup>7</sup>	
					0 986 473 070		← 56,93	1 987 470 506 <sup>8</sup>	
					0 986 474 070		→ 56,93	1 987 470 005 <sup>7</sup>	
2.8	12.01-03.08	140/142	PR-Code 1LT	312	0 986 473 070		← 56,93	1 987 470 005 <sup>7</sup>	
					0 986 473 070		← 56,93	1 987 470 506 <sup>8</sup>	
					0 986 474 070		→ 56,93	1 987 470 005 <sup>7</sup>	
			PR-Code 1ZC	288	0 986 473 070		← 56,93	1 987 470 005 <sup>7</sup>	
					0 986 473 070		← 56,93	1 987 470 506 <sup>8</sup>	
					0 986 474 070		→ 56,93	1 987 470 005 <sup>7</sup>	
	1.8 T	12.01-03.08	110		0 986 472 831		→ 38	1 987 470 040 <sup>7</sup>	
					0 986 474 831				
					0 986 474 830		← 38	1 987 470 040 <sup>7</sup>	
					0 986 474 830		← 38	1 987 474 496 <sup>8</sup>	
	1.9 TDI	12.01-03.08	74/77/85/ 96		0 986 472 831		→ 38	1 987 470 040 <sup>7</sup>	
					0 986 474 831				
					0 986 474 830		← 38	1 987 470 040 <sup>7</sup>	
					0 986 474 830		← 38	1 987 474 496 <sup>8</sup>	
	2.0	12.01-03.08	85/91/103		0 986 472 831		→ 38	1 987 470 040 <sup>7</sup>	
	2.0 TDI				0 986 474 831				
					0 986 474 830		← 38	1 987 470 040 <sup>7</sup>	
					0 986 474 830		← 38	1 987 474 496 <sup>8</sup>	
	2.5 TDI	12.01-03.08	114/120		0 986 472 831		→ 38	1 987 470 040 <sup>7</sup>	
					0 986 474 831				
					0 986 474 830		← 38	1 987 470 040 <sup>7</sup>	
					0 986 474 830		← 38	1 987 474 496 <sup>8</sup>	
	2.8	12.01-03.08	140/142		0 986 472 831		→ 38	1 987 470 040 <sup>7</sup>	
					0 986 474 831				
					0 986 474 830		← 38	1 987 470 040 <sup>7</sup>	
					0 986 474 830		← 38	1 987 474 496 <sup>8</sup>	
	1.8 T	12.01-03.08	110		1 987 477 242		→ 1989		
					1 987 477 244		← 1989		
	1.9 TDI	12.01-03.08	74/77/85/ 96		1 987 477 242		→ 1989		
					1 987 477 244		← 1989		
	2.0	12.01-03.08	85/91/103		1 987 477 242		→ 1989		
	2.0 TDI				1 987 477 244		← 1989		
	2.5 TDI	12.01-03.08	114/120		1 987 477 242		→ 1989		
					1 987 477 244		← 1989		
	2.8	12.01-03.08	140/142		1 987 477 242		→ 1989		
					1 987 477 244		← 1989		
	1.8 T	12.01-03.08	110		0 986 594 002 <sup>3</sup>				
	1.9 TDI	12.01-03.08	74/77/85/96		0 986 594 002 <sup>3</sup>				
	2.0 TDI	12.01-03.08	85/91/103		0 986 594 002 <sup>3</sup>				
	2.5 TDI	12.01-03.08	114/120		0 986 594 002 <sup>3</sup>				
	2.8	12.01-03.08	140/142		0 986 594 002 <sup>3</sup>				
<b>Superb [3V3]</b>									
	1.4 TSI	05.15→	92/110		FPA,LAB			0 986 594 561 <sup>4</sup>	
					FPA,LAB			0 986 594 506 <sup>4</sup>	

		S							
<b>SKODA Superb [3V3]</b>									
1.4 TSI		05.15→	92/110			LAB	0986 594 504 <sup>3</sup>		
						RAB	0986 594 505 <sup>3</sup>		
1.6 TDI		05.15→	88			FPA,LAB	0986 594 561 <sup>4</sup>		
						FPA,LAB	0986 594 506 <sup>4</sup>		
						LAB	0986 594 504 <sup>3</sup>		
						RAB	0986 594 505 <sup>3</sup>		
1.8 TSI		05.15→	132			FPA,LAB	0986 594 561 <sup>4</sup>		
						FPA,LAB	0986 594 506 <sup>4</sup>		
						LAB	0986 594 504 <sup>3</sup>		
						RAB	0986 594 505 <sup>3</sup>		
2.0 TDI		05.15→	110			FPA,LAB	0986 594 561 <sup>4</sup>		
						FPA,LAB	0986 594 506 <sup>4</sup>		
						LAB	0986 594 504 <sup>3</sup>		
						RAB	0986 594 505 <sup>3</sup>		
			140			FPA,LAB	0986 594 561 <sup>4</sup>		
						FPA,LAB	0986 594 506 <sup>4</sup>		
						LAB	0986 594 504 <sup>3</sup>		
2.0 TDI, TDI 4x4		05.15→	140			RAB	0986 594 505 <sup>3</sup>		
2.0 TDI 4x4		05.15→	140			FPA,LAB	0986 594 504 <sup>4</sup>		
						LAB	0986 594 504 <sup>3</sup>		
2.0 TSI		05.15→	162			FPA,LAB	0986 594 561 <sup>4</sup>		
						FPA,LAB	0986 594 506 <sup>4</sup>		
						LAB	0986 594 504 <sup>3</sup>		
						RAB	0986 594 505 <sup>3</sup>		
<b>Yeti</b>									
1.8 TSI		02.11→	112	PR-Code 1ZE, PR-Code 1ZA	288,312	0986 473 384	← 53,94	F 026 A06 106 <sup>7</sup>	
						0986 473 384	← 53,94	1987 470 506 <sup>8</sup>	
						0986 474 384	→ 53,94	F 026 A06 106 <sup>7</sup>	
				PR-Code 1ZF	228	0986 473 071	← 54	1987 470 506 <sup>8</sup>	
						0986 474 071	→ 54	1987 470 506 <sup>8</sup>	
1.8 TSI		02.11→	112	PR-Code 1KD	D53	0986 473 381	← 38,1	1987 470 040 <sup>7</sup>	
						0986 474 381	→ 38,1	1987 470 040 <sup>7</sup>	
				PR-Code 1KS		0986 134 203	← 38		
						0986 135 203	→ 38		
1.8 TSI		02.11→	112			1987 477 958	↔ 1447		
1.8 TSI		02.11-10.13	112			LAB	0986 594 506 <sup>4</sup>		
						RAB	0986 594 507 <sup>4</sup>		
		02.11→	112			LAB	0986 594 504 <sup>3</sup>		
						RAB	0986 594 505 <sup>3</sup>		
		11.13→	112			FPA,LAB	0986 594 561 <sup>4</sup>		
						FPA,RAB	0986 594 560 <sup>4</sup>		
						FPA,LAB	0986 594 506 <sup>4</sup>		
						FPA,RAB	0986 594 507 <sup>4</sup>		
<b>Yeti [5L7]</b>									
1.2 TSI		09.09→	77	PR-Code 1ZE	288	0986 473 384	← 53,94	F 026 A06 106 <sup>7</sup>	
						0986 474 384	→ 53,94	F 026 A06 106 <sup>7</sup>	
				PR-Code 1ZF	228	0986 473 071	← 54		
						0986 474 071	→ 54		
				PR-Code 1ZF, PR-Code 1ZE	228,288				1987 470 506 <sup>8</sup>

		S							
1.4 TSI		06.10→	90	PR-Code 1ZE	288		0 986 473 384	↔ ← 53,94	F 026 A06 106 <sup>7</sup>
							0 986 474 384	↔ → 53,94	F 026 A06 106 <sup>7</sup>
				PR-Code 1ZF	228		0 986 473 071	↔ ← 54	
							0 986 474 071	↔ → 54	
			PR-Code 1ZF, PR-Code 1ZE	228,288					1 987 470 506 <sup>8</sup>
1.6 1.6 TDI		11.10→	77/81	PR-Code 1ZE	288		0 986 473 384	↔ ← 53,94	F 026 A06 106 <sup>7</sup>
							0 986 474 384	↔ → 53,94	F 026 A06 106 <sup>7</sup>
				PR-Code 1ZF	228		0 986 473 071	↔ ← 54	
							0 986 474 071	↔ → 54	
			PR-Code 1ZF, PR-Code 1ZE	228,288					1 987 470 506 <sup>8</sup>
1.8 TSI 4x4		05.09→	112/118	PR-Code 1ZE, PR-Code 1ZA	288,312		0 986 473 384	↔ ← 53,94	F 026 A06 106 <sup>7</sup>
							0 986 474 384	↔ ← 53,94	1 987 470 506 <sup>8</sup>
				PR-Code 1ZF	228		0 986 474 384	↔ → 53,94	F 026 A06 106 <sup>7</sup>
							0 986 473 071	↔ ← 54	1 987 470 506 <sup>8</sup>
			PR-Code 1ZF, PR-Code 1ZE	228,288					1 987 470 506 <sup>8</sup>
2.0 TDI 2.0 TDI 4x4		05.09→	81/103/ 125	PR-Code 1ZE, PR-Code 1ZA	288,312		0 986 473 384	↔ ← 53,94	F 026 A06 106 <sup>7</sup>
							0 986 474 384	↔ ← 53,94	1 987 470 506 <sup>8</sup>
		11.09→	81/103/ 125	PR-Code 1ZF	228		0 986 473 384	↔ → 53,94	F 026 A06 106 <sup>7</sup>
							0 986 474 071	↔ ← 54	1 987 470 506 <sup>8</sup>
			PR-Code 1ZF, PR-Code 1ZE	228,288					1 987 470 506 <sup>8</sup>
									
	1.2 TSI	09.09→	77	PR-Code 1KD	D53		0 986 473 381	↔ ← 38,1	1 987 470 040 <sup>7</sup>
							0 986 474 381	↔ → 38,1	1 987 470 040 <sup>7</sup>
				PR-Code 1KS		0 986 134 203	↔ ← 38		
						0 986 135 203	↔ → 38		
1.4 TSI		06.10→	90	PR-Code 1KD	D53		0 986 473 381	↔ ← 38,1	1 987 470 040 <sup>7</sup>
							0 986 474 381	↔ → 38,1	1 987 470 040 <sup>7</sup>
				PR-Code 1KS		0 986 134 203	↔ ← 38		
						0 986 135 203	↔ → 38		
1.6 1.6 TDI		11.10→	77/81	PR-Code 1KD	D53		0 986 473 381	↔ ← 38,1	1 987 470 040 <sup>7</sup>
							0 986 474 381	↔ → 38,1	1 987 470 040 <sup>7</sup>
				PR-Code 1KS		0 986 134 203	↔ ← 38		
						0 986 135 203	↔ → 38		
1.8 TSI 4x4		05.09→	112/118	PR-Code 1KJ			0 986 473 448	↔ ← 41	
							0 986 474 448	↔ → 41	
				PR-Code 1KS		0 986 134 203	↔ ← 38		
						0 986 135 203	↔ → 38		
2.0 TDI		11.09→	81/103	PR-Code 1KD	D53		0 986 473 381	↔ ← 38,1	1 987 470 040 <sup>7</sup>
							0 986 474 381	↔ → 38,1	1 987 470 040 <sup>7</sup>
2.0 TDI		05.09→	81/103	PR-Code 1KS			0 986 134 203	↔ ← 38	
2.0 TDI 4x4							0 986 135 203	↔ → 38	
2.0 TDI 4x4		05.09→	81/103	PR-Code 1KJ			0 986 473 448	↔ ← 41	
							0 986 474 448	↔ → 41	
		11.09→	125	PR-Code 1KJ		0 986 473 448	↔ ← 41		
						0 986 474 448	↔ → 41		
				PR-Code 1KS			0 986 134 203	↔ ← 38	
							0 986 135 203	↔ → 38	
									
	1.2 TSI	09.09→	77				1 987 477 958	↔ 1447	
	1.4 TSI	06.10→	90				1 987 477 958	↔ 1447	
	1.6	04.14→	77/81				1 987 477 958	↔ 1447	
	1.6 TDI	11.10→	77/81				1 987 477 958	↔ 1447	
	1.8 TSI 4x4	05.09→	112/118				1 987 477 958	↔ 1447	
	2.0 TDI	11.09→	81/103/125				1 987 477 958	↔ 1447	
	2.0 TDI 4x4	05.09→	81/103/125				1 987 477 958	↔ 1447	
	1.2 TSI	09.09-10.13	77				0 986 594 506 <sup>4</sup>		
							0 986 594 507 <sup>4</sup>		
	09.09→	77					0 986 594 504 <sup>3</sup>		
							0 986 594 505 <sup>3</sup>		



SKODA Yeti [5L7]								
1.2 TSI	11.13→	77	FPA,LAB	0 986 594 561 <sup>4</sup>				
			FPA,RAB	0 986 594 560 <sup>4</sup>				
			FPA,LAB	0 986 594 506 <sup>4</sup>				
			FPA,RAB	0 986 594 507 <sup>4</sup>				
1.4 TSI	06.10-10.13	90	LAB	0 986 594 506 <sup>4</sup>				
			RAB	0 986 594 507 <sup>4</sup>				
	06.10→	90	LAB	0 986 594 504 <sup>3</sup>				
			RAB	0 986 594 505 <sup>3</sup>				
	11.13→	90	FPA,LAB	0 986 594 561 <sup>4</sup>				
			FPA,RAB	0 986 594 560 <sup>4</sup>				
			FPA,LAB	0 986 594 506 <sup>4</sup>				
			FPA,RAB	0 986 594 507 <sup>4</sup>				
1.6	04.14→	81	FPA,LAB	0 986 594 561 <sup>4</sup>				
			FPA,RAB	0 986 594 560 <sup>4</sup>				
			FPA,LAB	0 986 594 506 <sup>4</sup>				
			FPA,RAB	0 986 594 507 <sup>4</sup>				
			LAB	0 986 594 504 <sup>3</sup>				
			RAB	0 986 594 505 <sup>3</sup>				
1.6 TDI	11.10-10.13	77	LAB	0 986 594 506 <sup>4</sup>				
			RAB	0 986 594 507 <sup>4</sup>				
	11.10→	77	LAB	0 986 594 504 <sup>3</sup>				
			RAB	0 986 594 505 <sup>3</sup>				
	11.13→	77	FPA,LAB	0 986 594 561 <sup>4</sup>				
			FPA,RAB	0 986 594 560 <sup>4</sup>				
			FPA,LAB	0 986 594 506 <sup>4</sup>				
			FPA,RAB	0 986 594 507 <sup>4</sup>				
			FPA,RAB	0 986 594 505 <sup>3</sup>				
1.8 TSI 4x4	05.09-10.13	112/118	LAB	0 986 594 504 <sup>4</sup>				
			RAB	0 986 594 505 <sup>4</sup>				
	05.09→	112/118	LAB	0 986 594 504 <sup>3</sup>				
			RAB	0 986 594 505 <sup>3</sup>				
	11.13→	112/118	FPA,LAB	0 986 594 504 <sup>4</sup>				
			FPA,RAB	0 986 594 505 <sup>4</sup>				
2.0 TDI	11.09-10.13	81/103	LAB	0 986 594 506 <sup>4</sup>				
			RAB	0 986 594 507 <sup>4</sup>				
	11.09→	81/103	LAB	0 986 594 504 <sup>3</sup>				
			RAB	0 986 594 505 <sup>3</sup>				
	11.13→	81/103	FPA,LAB	0 986 594 561 <sup>4</sup>				
			FPA,RAB	0 986 594 560 <sup>4</sup>				
			FPA,LAB	0 986 594 506 <sup>4</sup>				
			FPA,RAB	0 986 594 507 <sup>4</sup>				
			FPA,RAB	0 986 594 505 <sup>3</sup>				
2.0 TDI 4x4	05.09-10.13	81/103	LAB	0 986 594 504 <sup>4</sup>				
			RAB	0 986 594 505 <sup>4</sup>				
	05.09→	81/103	LAB	0 986 594 504 <sup>3</sup>				
			RAB	0 986 594 505 <sup>3</sup>				
	11.09-10.13	125	LAB	0 986 594 504 <sup>4</sup>				
			RAB	0 986 594 505 <sup>4</sup>				
	11.09→	125	LAB	0 986 594 504 <sup>3</sup>				
			RAB	0 986 594 505 <sup>3</sup>				
	11.13→	81/103	FPA,LAB	0 986 594 504 <sup>4</sup>				
			FPA,RAB	0 986 594 505 <sup>4</sup>				
		125	FPA,LAB	0 986 594 504 <sup>4</sup>				
			FPA,RAB	0 986 594 505 <sup>4</sup>				

**SMART (MCC)**

**Forfour [454]**



	1.1	01.04-06.07	47/55	0 986 475 956	↔ 19
	1.3	01.04-06.07	70	0 986 475 956	↔ 19
	1.5 cdi	09.04-06.07	50	0 986 475 956	↔ 19

		S							
	1.1	01.04-06.07	47/55				1 987 482 271	← 1540	
							1 987 482 272	→ 1570	
	1.3	01.04-06.07	70				1 987 482 271	← 1540	
							1 987 482 272	→ 1570	
	1.5, Brabus, cdi, Sportstyle	01.04-06.07	50/70/80/ 90/130				1 987 482 271	← 1540	
							1 987 482 272	→ 1570	
	1.1	01.04-06.07	47/55				0 265 007 637 <sup>3</sup>		
							0 265 007 638 <sup>4</sup>		
	1.3	01.04-06.07	70				0 265 007 637 <sup>3</sup>		
							0 265 007 638 <sup>4</sup>		
	1.5, Brabus, cdi, Sportstyle	01.04-06.07	50/70/80/ 90/130				0 265 007 637 <sup>3</sup>		
							0 265 007 638 <sup>4</sup>		
<b>Fortwo Cabrio [450]</b>									
	0.7	02.04-03.07	45/55				0 204 204 988	← 42	
	0.7 Brabus						0 986 473 268		
							0 204 204 989	→ 42	
							0 986 474 268		
	0.8 cdi	02.04-03.07	30				0 204 204 988	← 42	
							0 986 473 268		
							0 204 204 989	→ 42	
							0 986 474 268		
	0.7	02.04-03.07	45/55				F 026 002 579	← 22,2	
	0.7 Brabus						F 026 002 580	→ 22,2	
	0.8 cdi	02.04-03.07	30				F 026 002 579	← 22,2	
							F 026 002 580	→ 22,2	
	0.7, Brabus	02.04-03.07	45/55		SAZ		1 987 477 751	990	
	0.8 cdi	02.04-03.07	30		SAZ		1 987 477 751	990	
	0.8 cdi	02.04-03.07	30		LAB		0 265 006 556 <sup>4</sup>		
					RAB		0 265 006 557 <sup>4</sup>		
<b>Fortwo Cabrio [451]</b>									
	0.8 cdi	04.07-09.13	33/40				0 986 475 980	← 20,6	
							0 986 475 981	→ 20,6	
	1.0, Brabus, mhd	04.07→	52/62/72/ 75				0 986 475 980	← 20,6	
							0 986 475 981	→ 20,6	
	0.8 cdi	04.07-09.13	33/40		SAZ		1 987 482 423	1028	
	1.0, Brabus, mhd	04.07→	52/62/72/75		SAZ		1 987 482 423	1028	
<b>Fortwo Coupé [450]</b>									
	0.7	02.04-03.07	37/45/55				0 204 204 988	← 42	
	0.7 Brabus						0 986 473 268		
							0 204 204 989	→ 42	
							0 986 474 268		



		S							
	<b>SMART Fortwo Coupé [450]</b>								
	0.8 cdi	02.04-03.07	30				0 204 <b>204 988</b>	← 42	
							0 986 <b>473 268</b>	→ 42	
							0 204 <b>204 989</b>	← 42	
							0 986 <b>474 268</b>	→ 42	
	0.7	02.04-03.07	37/45/55				F 026 <b>002 579</b>	← 22,2	
	0.7 Brabus						F 026 <b>002 580</b>	→ 22,2	
	0.8 cdi	02.04-03.07	30				F 026 <b>002 579</b>	← 22,2	
							F 026 <b>002 580</b>	→ 22,2	
	0.7, Brabus	02.04-03.07	37/45/55		SAZ		1 987 <b>477 751</b>	990	
	0.8 cdi	02.04-03.07	30		SAZ		1 987 <b>477 751</b>	990	
	0.7	02.04-03.07	45		LAB		0 265 <b>006 556<sup>4</sup></b>		
					RAB		0 265 <b>006 557<sup>4</sup></b>		
	0.8 cdi	02.04-03.07	30		LAB		0 265 <b>006 556<sup>4</sup></b>		
					RAB		0 265 <b>006 557<sup>4</sup></b>		
<b>Fortwo Coupé [451]</b>									
	0.8 cdi	04.07-09.13	33/40				0 986 <b>475 980</b>	← 20,6	
							0 986 <b>475 981</b>	→ 20,6	
	1.0, Brabus, mhd	04.07→	45/52/62/ 72/75				0 986 <b>475 980</b>	← 20,6	
							0 986 <b>475 981</b>	→ 20,6	
	0.8 cdi	04.07-09.13	33/40		SAZ		1 987 <b>482 423</b>	1028	
	1.0, Brabus, mhd	04.07→	45/52/62/72/75		SAZ		1 987 <b>482 423</b>	1028	
<b>Fortwo ED Cabrio [451]</b>									
		05.07→	20-30/ 35-55				0 986 <b>475 980</b>	← 20,6	
							0 986 <b>475 981</b>	→ 20,6	
	Brabus	06.12→	60				0 986 <b>475 980</b>	← 20,6	
							0 986 <b>475 981</b>	→ 20,6	
		05.07→	20-30/35-55		SAZ		1 987 <b>482 423</b>	1028	
	Brabus	06.12→	60		SAZ		1 987 <b>482 423</b>	1028	
<b>Fortwo ED Coupé [451]</b>									
		05.07→	20-30/ 35-55/60				0 986 <b>475 980</b>	← 20,6	
							0 986 <b>475 981</b>	→ 20,6	
		05.07→	20-30/35-55/60		SAZ		1 987 <b>482 423</b>	1028	



		S							
<b>Roadster Coupé [452]</b>									
	<b>0.7</b> 0.7 Brabus	04.03-11.05	45/60/74				0 204 204 988 0 986 473 268 0 204 204 989 0 986 474 268	← 42 → 42	
	<b>0.7</b> 0.7 Brabus	04.03-11.05	45/60/74				0 265 006 753 <sup>3</sup> LAB 0 265 006 556 <sup>4</sup> RAB 0 265 006 557 <sup>4</sup>		
<b>Roadster [452]</b>									
	<b>0.7</b> 0.7 Brabus	04.03-11.05	45/60/74				0 204 204 988 0 986 473 268 0 204 204 989 0 986 474 268	← 42 → 42	
	<b>0.7</b>	04.03-11.05	60		SAZ		1 987 477 751	990	
	<b>0.7</b> 0.7 Brabus	04.03-11.05	45/60/74				0 265 006 753 <sup>3</sup> LAB 0 265 006 556 <sup>4</sup> RAB 0 265 006 557 <sup>4</sup>		
<b>Smart Cabrio [450]</b>									
	<b>0.6</b>	03.00-01.04	40/45/52				0 204 204 988 0 986 473 268 0 204 204 989 0 986 474 268	← 42 → 42	
	<b>0.7</b> 0.7 Brabus	11.02-01.04	45/55				0 204 204 988 0 986 473 268 0 204 204 989 0 986 474 268	← 42 → 42	
	<b>0.8 cdi</b>	03.01-01.04	30				0 204 204 988 0 986 473 268 0 204 204 989 0 986 474 268	← 42 → 42	
	<b>0.6</b>	03.00-01.04	40/45/52				F 026 002 579 F 026 002 580	← 22,2 → 22,2	
	<b>0.7</b> 0.7 Brabus	11.02-01.04	45/55				F 026 002 579 F 026 002 580	← 22,2 → 22,2	
	<b>0.8 cdi</b>	03.01-01.04	30				F 026 002 579 F 026 002 580	← 22,2 → 22,2	
	<b>0.6</b> 0.7, Brabus 0.8 cdi	03.00-01.04 11.02-01.04 03.01-01.04	40/45/52 45/55 30		SAZ SAZ SAZ		1 987 477 751 1 987 477 751 1 987 477 751	990 990 990	





		S							
◀ SMART Smart Cabrio [450]									
	0.8 cdi		03.01-01.04	30		LAB	0 265 006 556 <sup>4</sup>		
						RAB	0 265 006 557 <sup>4</sup>		
<b>Smart Coupé [450]</b>									
	0.6		07.98-01.04	33/40/45/52			0 204 204 988	← 42	
							0 986 473 268		
							0 204 204 989	→ 42	
							0 986 474 268		
	0.7		11.02-01.04	37/45/55			0 204 204 988	← 42	
	0.7 Brabus						0 986 473 268		
							0 204 204 989	→ 42	
							0 986 474 268		
	0.8 cdi		11.99-01.04	30			0 204 204 988	← 42	
							0 986 473 268		
							0 204 204 989	→ 42	
							0 986 474 268		
	0.6		07.98-11.99	33/40			F 026 002 014	←	
							F 026 002 015	→ 17,5	
			11.99-01.04	33/40			F 026 002 579	← 22,2	
							F 026 002 580	→ 22,2	
			01.01-01.04	45/52			F 026 002 579	← 22,2	
							F 026 002 580	→ 22,2	
	0.7		11.02-01.04	37/55			F 026 002 579	← 22,2	
	0.7 Brabus						F 026 002 580	→ 22,2	
	0.8 cdi		11.99-01.04	30			F 026 002 579	← 22,2	
							F 026 002 580	→ 22,2	
	0.6		07.98-01.04	33/40/45/52		SAZ	1 987 477 751	990	
	0.7, Brabus		11.02-01.04	37/45/55		SAZ	1 987 477 751	990	
	0.8 cdi		11.99-01.04	30		SAZ	1 987 477 751	990	
	0.7		11.02-01.04	45		LAB	0 265 006 556 <sup>4</sup>		
						RAB	0 265 006 557 <sup>4</sup>		
	0.8 cdi		11.99-01.04	30		LAB	0 265 006 556 <sup>4</sup>		
						RAB	0 265 006 557 <sup>4</sup>		
<b>Smart Crossblade [450]</b>									
	0.6		10.02-01.04	52			0 204 204 988	← 42	
							0 986 473 268		
							0 204 204 989	→ 42	
							0 986 474 268		
	0.6		10.02-01.04	52		SAZ	1 987 477 751	990	
	0.6		10.02-01.04	52		LAB	0 265 006 556 <sup>4</sup>		
						RAB	0 265 006 557 <sup>4</sup>		





**SSANGYONG**

**Istana**



**2.9 D Van** 04.95-06.03 70

0 265 **006 341**<sup>4</sup>

**Istana [L]**



**2.3 i 16V** 11.96-12.03 110

0 265 **006 341**<sup>4</sup>

**Korando [KJ]**



**2.0 i** 07.96-12.05 94

0 265 **006 343**<sup>4</sup>

**2.3 D** 07.96-12.05 58-59/  
**2.3 i 16V** 103-105

0 265 **006 712**<sup>3</sup>

0 265 **006 343**<sup>4</sup>

0 265 **006 712**<sup>3</sup>

**2.9 D** 07.96-12.05 70-74/

0 265 **006 343**<sup>4</sup>

**2.9 TD Intercooler 4WD** 88-97

0 265 **006 712**<sup>3</sup>

**3.2 i 4WD** 07.96-12.05 154-162

0 265 **006 343**<sup>4</sup>

0 265 **006 712**<sup>3</sup>

**Musso [MJ]**



**2.0 i** 05.96-12.05 100

0 265 **006 135**<sup>4</sup>

0 265 **006 712**<sup>3</sup>

**2.3 D** 07.93-12.05 57-58/

0 265 **006 135**<sup>4</sup>

**2.3 i** 103-110

0 265 **006 712**<sup>3</sup>

**2.9 D** 07.93-12.05 70-74

0 265 **006 135**<sup>4</sup>

0 265 **006 712**<sup>3</sup>

**2.9 D, TD Intercooler** 07.93-12.05 88

0 265 **006 712**<sup>3</sup>

**2.9 TD Intercooler** 05.97-12.05 88

0 265 **006 135**<sup>4</sup>

**3.2 i** 01.96-12.05 162

0 265 **006 135**<sup>4</sup>

0 265 **006 712**<sup>3</sup>

**STEYR (STEYR-DAIMLER-PUCH AG)**

**G**



**300 DT** 01.98→ 130

0 986 **475 033**

↔ 17,46



**300 DT** 01.98→ 130

0 204 **102 834**

← 48

0 204 **102 835**

→ 48

0 204 **102 910**

← 48

0 204 **102 911**

→ 48

**320** 01.98→ 158

0 204 **102 834**

← 48

0 204 **102 835**

→ 48

0 204 **102 910**

← 48

0 204 **102 911**

→ 48

**500 V8** 01.98→ 218

0 204 **102 834**

← 48

0 204 **102 835**

→ 48

0 204 **102 910**

← 48

0 204 **102 911**

→ 48



		S							
◀ STEYR G									
	500 V8	01.98→	218		SBR		1987 477 852	1513	
	300 DT	01.98→	130				0 265 002 262 <sup>3</sup>		
	320	01.98→	158				0 265 002 262 <sup>3</sup>		
	500 V8	01.98→	218				0 265 002 262 <sup>3</sup>		
<b>SUBARU</b>									
<b>BRZ [Z10]</b>									
	2.0	01.12→	147		277				F 026 A03 551 <sup>7</sup>
<b>Forester [SF]</b>									
	2.0 i S Turbo 4x4	01.97-05.02	90/92/						F 026 A03 529 <sup>7</sup>
	2.0 i 4x4		125-130						
	2.0 i 4x4	01.97-05.02	90/92			0 986 475 891		↔ 19,05	
	2.0 i S Turbo 4x4	01.97-05.02	90/92/						F 026 A03 492 <sup>7</sup>
	2.0 i 4x4		125-130						
	2.0 i S Turbo 4x4	01.97-05.02	90/92/			1987 482 080		→ 1603	
	2.0 i 4x4		125-130			1987 482 081		← 1625	
	2.0 i S Turbo 4x4	03.98-12.99	92/125-130		LAB	F 01G 065 0LT <sup>3</sup>			
	2.0 i 4x4				RAB	F 01G 065 0LU <sup>3</sup>			
		03.98-05.02	92/125-130		LAB	F 01G 065 0L7 <sup>4</sup>			
					RAB	F 01G 065 0L8 <sup>4</sup>			
		01.00-05.02	92/125-130		LAB	F 01G 065 0PL <sup>3</sup>			
					RAB	F 01G 065 0PM <sup>3</sup>			
	2.0 i 4x4	01.97-07.98	90		LAB	F 01G 065 0K6 <sup>3</sup>			
						F 01G 065 0L7 <sup>4</sup>			
					RAB	F 01G 065 0K7 <sup>3</sup>			
						F 01G 065 0L8 <sup>4</sup>			
<b>Forester [SG]</b>									
	2.0 i S Turbo 4x4, i 4x4	06.02-11.07	92/116/130						F 026 A03 551 <sup>7</sup>
	2.5 i Turbo 4x4, i 4x4	06.02-11.07	115-123/129/155/169						F 026 A03 551 <sup>7</sup>
	2.0 i 4x4	06.02-11.07	92/116			0 986 475 891		↔ 19,05	
	2.5 i 4x4	06.02-11.07	115-123/129			0 986 475 891		↔ 19,05	
	2.0 i S Turbo 4x4, i 4x4	06.02-11.07	116/130						F 026 A03 492 <sup>7</sup>
	2.5 i Turbo 4x4, i 4x4	06.02-11.07	115-123/129/155/169						F 026 A03 492 <sup>7</sup>



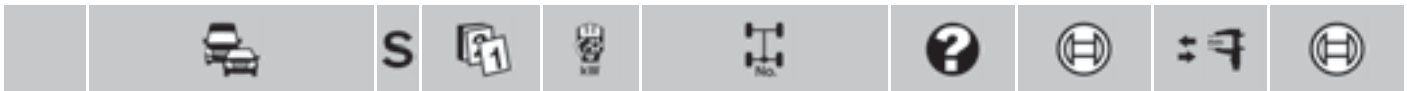

	2.0 i S Turbo 4x4	06.02-05.06	92/116/130	LAB		F 01G <b>065 0PF</b> <sup>3</sup>		
	2.0 i 4x4	06.02-11.07	92/116/130	LAB		F 01G <b>065 ONX</b> <sup>4</sup>		
				RAB		F 01G <b>065 ONY</b> <sup>4</sup>		
	2.5 i Turbo 4x4	06.02-05.06	115-123/129/155/169	LAB		F 01G <b>065 0PF</b> <sup>3</sup>		
	2.5 i 4x4	06.02-11.07	115-123/129/155/169	LAB		F 01G <b>065 ONX</b> <sup>4</sup>		
				RAB		F 01G <b>065 ONY</b> <sup>4</sup>		

**Forester [S12]**

	2.0	12.07-12.12	110					F 026 <b>A03 551</b> <sup>7</sup>
	2.0D	12.07-12.12	108					F 026 <b>A03 551</b> <sup>7</sup>
	2.5	12.07-03.10	126					F 026 <b>A03 551</b> <sup>7</sup>
		04.10-12.10	126		Z15			F 026 <b>A03 551</b> <sup>7</sup>
					16Z			F 026 <b>A03 551</b> <sup>7</sup>
	2.5 Turbo	12.07-12.12	169					F 026 <b>A03 551</b> <sup>7</sup>
	2.5 X	09.10-12.12	125					F 026 <b>A03 551</b> <sup>7</sup>

	2.0, D	12.07-12.12	108/110					F 026 <b>A06 138</b> <sup>7</sup>
	2.5, Turbo, X	12.07-12.12	125/126/169					F 026 <b>A06 138</b> <sup>7</sup>

	2.0	12.07-12.12	108/110	LAB		0 265 <b>008 339</b> <sup>3</sup>		
	2.0D			RAB		0 265 <b>008 346</b> <sup>4</sup>		
						0 265 <b>008 338</b> <sup>3</sup>		
						0 265 <b>008 347</b> <sup>4</sup>		
	2.5	12.07-12.12	125/126/	LAB		0 265 <b>008 339</b> <sup>3</sup>		
	2.5 Turbo		169			0 265 <b>008 346</b> <sup>4</sup>		
	2.5 X			RAB		0 265 <b>008 338</b> <sup>3</sup>		
						0 265 <b>008 347</b> <sup>4</sup>		

**Forester [S13]**

	2.0	11.12→	110					F 026 <b>A03 551</b> <sup>7</sup>
	2.0D	11.12→	108		294			F 026 <b>A03 551</b> <sup>7</sup>
	2.5 i	06.14→	126					F 026 <b>A03 551</b> <sup>7</sup>















	2.0	11.12→	110					F 026 <b>A06 138</b> <sup>7</sup>
	2.0D	11.12→	108		INB			F 026 <b>A06 138</b> <sup>7</sup>
	2.5 i	06.14→	126					F 026 <b>A06 138</b> <sup>7</sup>

**Impreza [G12]**

	1.5 R	06.07-02.10	79					F 026 <b>A03 523</b> <sup>7</sup>
		MFD 03.10-09.11	79					F 026 <b>A03 551</b> <sup>7</sup>
		OFD 03.10-09.11	79					F 026 <b>A03 523</b> <sup>7</sup>
	1.5 R 4x4	06.07-09.11	79					F 026 <b>A03 551</b> <sup>7</sup>
	2.0 D Crossover 4x4	03.10-12.11	80					F 026 <b>A03 551</b> <sup>7</sup>
	2.0 D 4x4	09.08-12.11	110					F 026 <b>A03 551</b> <sup>7</sup>
	2.0 R Crossover 4x4	06.07-04.10	110					F 026 <b>A03 551</b> <sup>7</sup>
	2.0 R 4x4	05.10-12.11	110		TW			F 026 <b>A03 551</b> <sup>7</sup>



		S							
<b>◀ SUBARU Impreza [G12]</b>									
	1.5 R, R 4x4			06.07-09.11	79				F 026 <b>A06 138</b> <sup>7</sup>
	2.0 D Crossover 4x4, D 4x4			06.07-12.11	80/110				F 026 <b>A06 138</b> <sup>7</sup>
	R Crossover 4x4, R 4x4								
	1.5 R			06.07-09.11	79	LAB	0 265 <b>008 339</b> <sup>3</sup>		
	1.5 R 4x4					RAB	0 265 <b>008 344</b> <sup>4</sup>		
							0 265 <b>008 338</b> <sup>3</sup>		
							0 265 <b>008 345</b> <sup>4</sup>		
	2.0 D Crossover 4x4			06.07-12.11	80/110	LAB	0 265 <b>008 339</b> <sup>3</sup>		
	2.0 D 4x4						0 265 <b>008 344</b> <sup>4</sup>		
	2.0 R Crossover 4x4					RAB	0 265 <b>008 338</b> <sup>3</sup>		
	2.0 R 4x4						0 265 <b>008 345</b> <sup>4</sup>		
<b>Impreza [G23]</b>									
	1.6, 4x4			10.11→	84				F 026 <b>A03 551</b> <sup>7</sup>
	2.0 4x4			10.11→	110				F 026 <b>A03 551</b> <sup>7</sup>
	1.6, 4x4			10.11→	84				F 026 <b>A06 138</b> <sup>7</sup>
	2.0 4x4			10.11→	110				F 026 <b>A06 138</b> <sup>7</sup>
	1.6, 4x4			10.11-07.12	84	LAB	0 265 <b>008 755</b> <sup>3</sup>		
	2.0 4x4			10.11-07.12	110	LAB	0 265 <b>008 755</b> <sup>3</sup>		
<b>Impreza Kombi [GC, GF]</b>									
	1.6 i	ABS		08.98-09.00	70				F 026 <b>A03 523</b> <sup>7</sup>
	1.6 i 4WD			08.98-09.00	70				F 026 <b>A03 523</b> <sup>7</sup>
	2.0 i 4WD			08.98-09.00	92				F 026 <b>A03 523</b> <sup>7</sup>
	2.0 i 4WD Turbo			08.96-07.98	155				F 026 <b>A03 529</b> <sup>7</sup>
				08.98-09.00	160				F 026 <b>A03 480</b> <sup>7</sup>
	1.6 i			08.98-09.00	70	TW	0 986 <b>475 891</b>	↔ 19,05	
							0 986 <b>475 900</b>	↔ 17,46	
	1.6 i 4WD			08.98-09.00	70		0 986 <b>475 891</b>	↔ 19,05	
		ABO		01.93-07.98	66		0 986 <b>475 891</b>	↔ 19,05	
	1.8 i 4WD	ABO		01.93-06.97	76		0 986 <b>475 891</b>	↔ 19,05	
	2.0 i 4WD			08.98-09.00	92		0 986 <b>475 891</b>	↔ 19,05	
	2.0 i 4WD Turbo			08.98-09.00	160				F 026 <b>A03 492</b> <sup>7</sup>
	1.6 i			08.95-07.98	66	LAB	F 01G <b>065 0K0</b> <sup>3</sup>		
	1.6 i 4WD					RAB	F 01G <b>065 0K2</b> <sup>4</sup>		
							F 01G <b>065 0K1</b> <sup>3</sup>		
							F 01G <b>065 0K3</b> <sup>4</sup>		
				08.98-06.99	70	LAB	F 01G <b>065 0LR</b> <sup>3</sup>		
						RAB	F 01G <b>065 0LS</b> <sup>3</sup>		
				08.98-09.00	70	LAB	F 01G <b>065 0K2</b> <sup>4</sup>		
						RAB	F 01G <b>065 0K3</b> <sup>4</sup>		

		S							
1.6i			07.99-09.00	70		LAB	F 01G 065 0PJ <sup>3</sup>		
1.6i 4WD						RAB	F 01G 065 0PK <sup>3</sup>		
1.8i 4WD			08.95-06.97	76		LAB	F 01G 065 0K0 <sup>3</sup>		
							F 01G 065 0K2 <sup>4</sup>		
						RAB	F 01G 065 0K1 <sup>3</sup>		
							F 01G 065 0K3 <sup>4</sup>		
2.0i 4WD			08.95-07.98	85		LAB	F 01G 065 0K0 <sup>3</sup>		
							F 01G 065 0K2 <sup>4</sup>		
						RAB	F 01G 065 0K1 <sup>3</sup>		
							F 01G 065 0K3 <sup>4</sup>		
			08.98-06.99	92		LAB	F 01G 065 0LR <sup>3</sup>		
						RAB	F 01G 065 0LS <sup>3</sup>		
			08.98-09.00	92		LAB	F 01G 065 0K2 <sup>4</sup>		
						RAB	F 01G 065 0K3 <sup>4</sup>		
			07.99-09.00	92		LAB	F 01G 065 0PJ <sup>3</sup>		
						RAB	F 01G 065 0PK <sup>3</sup>		
2.0i 4WD Turbo			08.95-07.98	155		LAB	F 01G 065 0K0 <sup>3</sup>		
							F 01G 065 0K2 <sup>4</sup>		
						RAB	F 01G 065 0K1 <sup>3</sup>		
							F 01G 065 0K3 <sup>4</sup>		
			08.98-06.99	160		LAB	F 01G 065 0LR <sup>3</sup>		
						RAB	F 01G 065 0LS <sup>3</sup>		
			08.98-09.00	160		LAB	F 01G 065 0K2 <sup>4</sup>		
						RAB	F 01G 065 0K3 <sup>4</sup>		
			07.99-09.00	160		LAB	F 01G 065 0PJ <sup>3</sup>		
						RAB	F 01G 065 0PK <sup>3</sup>		
<b>Impreza Kombi [GD, GG]</b>									
									
	1.5i 4WD		05.06-06.07	77					F 026 A03 523 <sup>7</sup>
	1.6i		10.00-06.01	70					F 026 A03 523 <sup>7</sup>
	1.6i 4WD		10.00-06.07	70					F 026 A03 523 <sup>7</sup>
	2.0i 4WD		10.00-10.02	92		RLE,TW			F 026 A03 551 <sup>7</sup>
						TW			F 026 A03 529 <sup>7</sup>
			11.02-06.07	92					F 026 A03 551 <sup>7</sup>
			06.05-06.07	118					F 026 A03 551 <sup>7</sup>
	2.0i 4WD Turbo		10.00-10.02	160					F 026 A03 480 <sup>7</sup>
			11.02-02.05	165					F 026 A03 480 <sup>7</sup>
			03.05-05.05	165		LLE,TW			F 026 A03 551 <sup>7</sup>
						TW			F 026 A03 480 <sup>7</sup>
	2.5i 4WD		07.04-05.05	112					F 026 A03 551 <sup>7</sup>
	2.5i 4WD Turbo		06.05-06.07	169		LLE,TW			F 026 A03 551 <sup>7</sup>
						TW			F 026 A03 480 <sup>7</sup>
									
	2.0i 4WD		10.00-06.07	92/118					F 026 A03 492 <sup>7</sup>
	2.0i 4WD Turbo		10.00-10.02	160					F 026 A06 138 <sup>7</sup>
	2.5i 4WD		07.04-05.05	112					F 026 A03 492 <sup>7</sup>
									
	1.5i 4WD		05.06-06.07	77		LAB	F 01G 065 0MR <sup>4</sup>		
						RAB	F 01G 065 0MS <sup>4</sup>		
	1.6i		10.00-06.07	70		LAB	F 01G 065 0MR <sup>4</sup>		
	1.6i 4WD						F 01G 065 0PE <sup>3</sup>		
						RAB	F 01G 065 0MS <sup>4</sup>		
	2.0i 4WD		10.00-06.07	92/160		LAB	F 01G 065 0MR <sup>4</sup>		
	2.0i 4WD Turbo						F 01G 065 0PE <sup>3</sup>		
						RAB	F 01G 065 0MS <sup>4</sup>		

































		S							
◀ SUBARU									
<b>Impreza Outback [GD, GG]</b>									
	2.0 i4WD			10.00-06.07	92				F 026 A03 551 <sup>7</sup>
	2.0 i4WD			10.00-06.07	92				F 026 A03 492 <sup>7</sup>
	2.0 i4WD			10.00-06.07	92	LAB	F 01G 065 OMR <sup>4</sup>		
							F 01G 065 OPE <sup>3</sup>		
						RAB	F 01G 065 OMS <sup>4</sup>		
<b>Impreza Sedan [GC, GF]</b>									
	1.6 i	ABS		08.98-09.00	70				F 026 A03 523 <sup>7</sup>
	1.6 i4WD			08.98-09.00	70				F 026 A03 523 <sup>7</sup>
	2.0 i, i4WD			08.98-09.00	92				F 026 A03 523 <sup>7</sup>
	2.0 i4WD Turbo			08.96-07.98	155				F 026 A03 529 <sup>7</sup>
				08.98-09.00	160				F 026 A03 480 <sup>7</sup>
	1.6 i			08.98-09.00	70		0986 475 900	↔ 17,46	
	1.6 i4WD			08.98-09.00	70		0986 475 891	↔ 19,05	
		ABO		01.93-07.98	66		0986 475 891	↔ 19,05	
	1.8 i4WD	ABO		01.93-06.97	76		0986 475 891	↔ 19,05	
	2.0 i, i4WD			08.98-09.00	92		0986 475 891	↔ 19,05	
	2.0 i4WD	ABO		08.95-07.98	85		0986 475 891	↔ 19,05	
	2.0 i4WD Turbo			08.98-09.00	160				F 026 A03 492 <sup>7</sup>
	1.6 i			08.95-07.98	66	LAB	F 01G 065 0K0 <sup>3</sup>		
	1.6 i4WD						F 01G 065 0K2 <sup>4</sup>		
						RAB	F 01G 065 0K1 <sup>3</sup>		
							F 01G 065 0K3 <sup>4</sup>		
				08.98-06.99	70	LAB	F 01G 065 0LR <sup>3</sup>		
						RAB	F 01G 065 0LS <sup>3</sup>		
				08.98-09.00	70	LAB	F 01G 065 0K2 <sup>4</sup>		
						RAB	F 01G 065 0K3 <sup>4</sup>		
				07.99-09.00	70	LAB	F 01G 065 0PJ <sup>3</sup>		
						RAB	F 01G 065 0PK <sup>3</sup>		
	1.8 i			08.95-06.97	76	LAB	F 01G 065 0K0 <sup>3</sup>		
	1.8 i4WD						F 01G 065 0K2 <sup>4</sup>		
						RAB	F 01G 065 0K1 <sup>3</sup>		
							F 01G 065 0K3 <sup>4</sup>		
	2.0 i			08.95-07.98	85	LAB	F 01G 065 0K0 <sup>3</sup>		
	2.0 i4WD						F 01G 065 0K2 <sup>4</sup>		
						RAB	F 01G 065 0K1 <sup>3</sup>		
							F 01G 065 0K3 <sup>4</sup>		
	2.0 i4WD			08.98-06.99	92	LAB	F 01G 065 0LR <sup>3</sup>		
						RAB	F 01G 065 0LS <sup>3</sup>		
				08.98-09.00	92	LAB	F 01G 065 0K2 <sup>4</sup>		
						RAB	F 01G 065 0K3 <sup>4</sup>		
				07.99-09.00	92	LAB	F 01G 065 0PJ <sup>3</sup>		
						RAB	F 01G 065 0PK <sup>3</sup>		



		S									
2.0i 4WD Turbo	08.95-07.98	155				LAB	F 01G 065 0K0 <sup>3</sup>				
							F 01G 065 0K2 <sup>4</sup>				
							RAB	F 01G 065 0K1 <sup>3</sup>			
								F 01G 065 0K3 <sup>4</sup>			
	08.98-06.99	160					LAB	F 01G 065 0LR <sup>3</sup>			
								F 01G 065 0LS <sup>3</sup>			
	08.98-09.00	160					LAB	F 01G 065 0K2 <sup>4</sup>			
								F 01G 065 0K3 <sup>4</sup>			
07.99-09.00	160					LAB	F 01G 065 0PJ <sup>3</sup>				
							F 01G 065 0PK <sup>3</sup>				
<b>Impreza Sedan [GD, GG]</b>											
	1.6i	10.00-06.07	70						F 026 A03 523 <sup>7</sup>		
	1.6i 4WD	10.00-06.07	70						F 026 A03 523 <sup>7</sup>		
	2.0i 4WD	10.00-10.02	92				RLE,TW			F 026 A03 551 <sup>7</sup>	
							TW			F 026 A03 529 <sup>7</sup>	
		11.02-06.07	92							F 026 A03 551 <sup>7</sup>	
							06.05-06.07	118			F 026 A03 551 <sup>7</sup>
							2.0i 4WD Turbo	10.00-10.02	160		
		11.02-02.05	165							F 026 A03 480 <sup>7</sup>	
							03.05-05.05	165			F 026 A03 551 <sup>7</sup>
									LLE,TW		F 026 A03 480 <sup>7</sup>
	2.5i 4WD	07.01-10.02	112				TW			F 026 A03 480 <sup>7</sup>	
									RLE,TW		F 026 A03 551 <sup>7</sup>
	11.02-05.05	112				TW			F 026 A03 529 <sup>7</sup>		
										F 026 A03 551 <sup>7</sup>	
2.5i 4WD Turbo	06.05-06.07	169							F 026 A03 480 <sup>7</sup>		
	2.0i 4WD	10.00-06.07	92/118						F 026 A03 492 <sup>7</sup>		
	2.0i 4WD Turbo	10.00-10.02	160						F 026 A06 138 <sup>7</sup>		
	2.5i 4WD	07.01-05.05	112						F 026 A03 492 <sup>7</sup>		
	1.6i	10.00-06.04	70				1 987 482 080	→ 1603			
	1.6i 4WD						1 987 482 081	← 1625			
	2.0i 4WD	10.00-06.04	92/160/				1 987 482 078	→ 1590			
	2.0i 4WD Turbo		165				1 987 482 079	← 1610			
	2.5i 4WD	07.01-06.04	112				1 987 482 078	→ 1590			
						1 987 482 079	← 1610				
	1.6i	10.00-06.07	70			LAB	F 01G 065 0MR <sup>4</sup>				
	1.6i 4WD						F 01G 065 0PE <sup>3</sup>				
						RAB	F 01G 065 0MS <sup>4</sup>				
	2.0i 4WD	10.00-06.07	92/118				LAB	F 01G 065 0MR <sup>4</sup>			
								F 01G 065 0PE <sup>3</sup>			
							RAB	F 01G 065 0MS <sup>4</sup>			
	2.0i 4WD Turbo, i 4WD Turbo STI	10.00-05.05	118/160/195				LAB	F 01G 065 0MR <sup>4</sup>			
	2.0i 4WD	10.00-04.06	118/160/195				LAB	F 01G 065 0PE <sup>3</sup>			
	2.0i 4WD Turbo, i 4WD Turbo STI	10.00-06.07	118/160/195				RAB	F 01G 065 0MS <sup>4</sup>			
	2.5i 4WD	07.01-05.05	112				LAB	F 01G 065 0MR <sup>4</sup>			
								F 01G 065 0PE <sup>3</sup>			
RAB							F 01G 065 0MS <sup>4</sup>				
<b>Impreza Sedan [G12]</b>											
	1.5 R	MFD	09.10-09.11	79					F 026 A03 551 <sup>7</sup>		
		OFD	09.10-09.11	79					F 026 A03 523 <sup>7</sup>		
	1.5 R 4x4	03.08-09.11	79						F 026 A03 551 <sup>7</sup>		























		S							
◀ SUBARU Impreza Sedan [G12]									
									
	1.5 R 1.5 R 4x4	03.08-09.11	79						F 026 A06 138 <sup>7</sup>
									
	1.5 R 1.5 R 4x4	03.08-09.11	79		LAB	0 265 008 339 <sup>3</sup> 0 265 008 344 <sup>4</sup>			
					RAB	0 265 008 338 <sup>3</sup> 0 265 008 345 <sup>4</sup>			
Impreza Sedan [G13]									
									
	1.6 1.6 4x4 2.0 4x4	10.11→	84			277			F 026 A03 523 <sup>7</sup> F 026 A03 551 <sup>7</sup> F 026 A03 551 <sup>7</sup>
									
	1.6, 4x4 2.0 4x4	10.11→	84						F 026 A06 138 <sup>7</sup> F 026 A06 138 <sup>7</sup>
									
	1.6, 4x4 2.0 4x4	10.11-07.12	84		LAB	0 265 008 755 <sup>3</sup>			
		10.11-07.12	110		LAB	0 265 008 755 <sup>3</sup>			
Impreza WRX [G22]									
									
	2.5	09.10-01.14	169/195						F 026 A03 551 <sup>7</sup>
									
	2.5	09.10-01.14	169/195						F 026 A06 138 <sup>7</sup>
									
	2.5	09.10-01.14	169/195		LAB	0 265 008 339 <sup>3</sup> 0 265 008 344 <sup>4</sup>			
					RAB	0 265 008 338 <sup>3</sup> 0 265 008 345 <sup>4</sup>			
Impreza WRX Hatchback [G12]									
									
	2.5 4x4	06.07-12.11	169-195						F 026 A03 551 <sup>7</sup>
									
	2.5 4x4	06.07-12.11	169-195						F 026 A06 138 <sup>7</sup>
									
	2.5 4x4	06.07-12.11	169-195		LAB	0 265 008 339 <sup>3</sup> 0 265 008 344 <sup>4</sup>			
					RAB	0 265 008 338 <sup>3</sup> 0 265 008 345 <sup>4</sup>			



		S							
<b>Impreza WRX Hatchback [G22]</b>									
	2.5	09.10-01.14	169/195						F 026 A03 551 <sup>7</sup>
	2.5	09.10-01.14	169/195						F 026 A06 138 <sup>7</sup>
	2.5 2.5 STI 320R	09.10-01.14	169/195/ 236		LAB	0 265 008 339 <sup>3</sup> 0 265 008 344 <sup>4</sup>			
					RAB	0 265 008 338 <sup>3</sup> 0 265 008 345 <sup>4</sup>			
<b>Impreza WRX STI [G22]</b>									
	2.5	09.10-01.14	221		LAB	0 265 008 339 <sup>3</sup> 0 265 008 344 <sup>4</sup>			
					RAB	0 265 008 338 <sup>3</sup> 0 265 008 345 <sup>4</sup>			
<b>Impreza WRX STI Hatchback [G22]</b>									
	2.5	06.07-01.14	221-243		LAB	0 265 008 339 <sup>3</sup> 0 265 008 344 <sup>4</sup>			
					RAB	0 265 008 338 <sup>3</sup> 0 265 008 345 <sup>4</sup>			
<b>Impreza WRX STI 320R [G22]</b>									
	2.5	04.11-12.12	236		LAB	0 265 008 339 <sup>3</sup> 0 265 008 344 <sup>4</sup>			
					RAB	0 265 008 338 <sup>3</sup> 0 265 008 345 <sup>4</sup>			
<b>Impreza WRX Wagon [G22]</b>									
	2.5 STI AWD	06.07-01.14			LAB	0 265 008 339 <sup>3</sup> 0 265 008 344 <sup>4</sup>			
					RAB	0 265 008 338 <sup>3</sup> 0 265 008 345 <sup>4</sup>			
<b>Justy [G3X]</b>									
	1.3 4x4	09.03-08.07	69						0 204 104 299 <sup>8</sup>
	1.5 4x4	09.03-08.07	73						0 204 104 299 <sup>8</sup>
	1.3 4x4	09.03-08.07	69			0 986 475 954	↔ 15,87		
	1.5 4x4	09.03-08.07	73			0 986 475 954	↔ 15,87		



◀ SUBARU								
<b>Justy [MA]</b>								
	1.3 4x4	10.95-09.96	50			0986 475 856	← 17,5	
						0986 475 857	→ 17,5	
<b>Justy [MS]</b>								
	1.3 4x4	10.96-09.00	50			0986 475 856	← 17,5	
						0986 475 857	→ 17,5	
		04.01-08.03	63			F 026 002 559	→ 17,46	
						F 026 002 560	← 17,46	
<b>Justy [M3]</b>								
	1.0	09.07-12.10	51			0986 475 881	← 17,46	
						0986 475 882	→ 17,46	
<b>Legacy [BL/BP]</b>								
	2.0 D 4WD, R 4WD, 4WD	07.03-05.09	101/110-121					F 026 A03 551 <sup>7</sup>
	2.5 4WD	07.03-05.09	121/127					F 026 A03 551 <sup>7</sup>
	3.0 4WD	07.03-05.09	180		LLE,TW			F 026 A03 551 <sup>7</sup>
	2.0 D 4WD	04.07-05.09	110-121					F 026 A06 138 <sup>7</sup>
	2.0 R 4WD	03.05-06.08	110-121					F 026 A06 138 <sup>7</sup>
		07.08-05.09	110-121		TW			F 026 A06 138 <sup>7</sup>
	2.0 4WD	07.03-06.05	101					F 026 A06 138 <sup>7</sup>
	2.5 4WD	07.03-06.06	121					F 026 A06 138 <sup>7</sup>
		07.06-05.09	127					F 026 A06 138 <sup>7</sup>
	3.0 4WD	07.03-12.04	180		LLE,TW			F 026 A03 492 <sup>7</sup>
					RLE			F 026 A03 492 <sup>7</sup>
		07.03-05.09	180		LLE,TW			F 026 A06 138 <sup>7</sup>
		01.05-03.06	180		TW			F 026 A03 492 <sup>7</sup>
		04.06-05.09	180		LLE,TW			F 026 A03 492 <sup>7</sup>
					RLE			F 026 A03 492 <sup>7</sup>
	2.0 D 4WD, R 4WD, 4WD	07.03-05.09	101/ 110-121			1987 482 351	→ 1750	
						1987 482 352	← 1750	
	2.5 4WD	07.03-05.09	121/127			1987 482 351	→ 1750	
						1987 482 352	← 1750	
	3.0 4WD	07.03-05.09	180			1987 482 351	→ 1750	
						1987 482 352	← 1750	
	2.0 D 4WD	04.07-05.09	110-121		RAB	0265 008 341 <sup>4</sup>		
	2.0 D 4WD	07.06-05.09	110-121		LAB	0265 008 339 <sup>3</sup>		
	2.0 R 4WD					0265 008 340 <sup>4</sup>		
					RAB	0265 008 338 <sup>3</sup>		
	2.0 R 4WD	03.05-06.06	110-121		LAB	0265 007 945 <sup>4</sup>		
						0265 008 357 <sup>3</sup>		
					RAB	0265 007 944 <sup>4</sup>		
						0265 008 358 <sup>3</sup>		
		07.06-05.09	110-121		RAB	0265 008 341 <sup>4</sup>		

		S								
2.0 4WD		07.03-06.05	101			LAB	0 265 007 945 <sup>4</sup>			
							RAB	0 265 008 357 <sup>3</sup>		
2.5 4WD		07.03-06.06	121			LAB	0 265 007 944 <sup>4</sup>			
							RAB	0 265 008 358 <sup>3</sup>		
		07.06-05.09	127			LAB	0 265 007 944 <sup>4</sup>			
							RAB	0 265 008 339 <sup>3</sup>		
3.0 4WD		07.03-06.06	180			LAB	0 265 008 340 <sup>4</sup>			
							RAB	0 265 008 338 <sup>3</sup>		
		07.06-05.09	180			LAB	0 265 008 358 <sup>3</sup>			
							RAB	0 265 007 944 <sup>4</sup>		
<b>Legacy [B14]</b>										
										
	2.0	06.09→	110						F 026 A03 551 <sup>7</sup>	
		2.0D	06.09→	110						F 026 A03 551 <sup>7</sup>
		2.5	06.09→	123						F 026 A03 551 <sup>7</sup>
			03.12→	127		277				F 026 A03 551 <sup>7</sup>
								294	F 026 A03 551 <sup>7</sup>	
										
	2.0, D	06.09→	110						F 026 A06 138 <sup>7</sup>	
		2.5	06.09→	123/127						F 026 A06 138 <sup>7</sup>
										
	2.0, D	06.09-02.12	110				1 987 482 351	1750		
		2.5, GT	06.09-02.12	123/195			1 987 482 351	1750		
		3.6	06.09-12.12	191			1 987 482 351	1750		
<b>Legacy Kombi [BE/BH]</b>										
										
	2.0i 4WD	10.98-06.03	92						F 026 A03 529 <sup>7</sup>	
										
	2.0i 4WD	10.98-06.03	92						F 026 A03 492 <sup>7</sup>	
										
	2.0i 4WD	10.98-06.99	92			LAB	F 01G 065 0LK <sup>3</sup>			
						RAB	F 01G 065 0LL <sup>3</sup>			
		10.98-06.03	92			LAB	F 01G 065 0PG <sup>4</sup>			
						RAB	F 01G 065 0PH <sup>4</sup>			
	2.5i 4WD	07.99-06.03	92			LAB	F 01G 065 0PE <sup>3</sup>			
		10.98-06.99	115			LAB	F 01G 065 0LK <sup>3</sup>			
						RAB	F 01G 065 0LL <sup>3</sup>			
		10.98-06.03	115			LAB	F 01G 065 0PG <sup>4</sup>			
				RAB	F 01G 065 0PH <sup>4</sup>					
		07.99-06.03	115			LAB	F 01G 065 0PE <sup>3</sup>			





◀ SUBARU

**Legacy Kombi [BL/BP]**

	2.0 D 4WD, R 4WD, 4WD	07.03-05.09	101/110-121				F 026 A03 551 <sup>7</sup>
	2.5 4WD	07.03-05.09	121/127				F 026 A03 551 <sup>7</sup>

	2.0 D 4WD	04.07-05.09	110-121				F 026 A06 138 <sup>7</sup>
	2.0 R 4WD	03.05-06.08	110-121				F 026 A06 138 <sup>7</sup>
		07.08-05.09	110-121		TW		F 026 A06 138 <sup>7</sup>
	2.0 4WD	07.03-06.05	101				F 026 A06 138 <sup>7</sup>
	2.5 4WD	07.03-06.06	121				F 026 A06 138 <sup>7</sup>
		07.06-05.09	127				F 026 A06 138 <sup>7</sup>
	3.0 4WD	07.03-05.09	180				F 026 A03 492 <sup>7</sup>

	2.0 D 4WD, R 4WD, 4WD	07.03-05.09	101/110-121			1987 482 351 → 1750	
						1987 482 352 ← 1750	
	2.5 4WD	07.03-05.09	121/127			1987 482 351 → 1750	
						1987 482 352 ← 1750	
	3.0 4WD	07.03-05.09	180			1987 482 351 → 1750	
						1987 482 352 ← 1750	

	2.0 D 4WD	04.07-05.09	110-121		RAB	0 265 008 341 <sup>4</sup>	
	2.0 D 4WD	07.06-05.09	110-121		LAB	0 265 008 339 <sup>3</sup>	
	2.0 R 4WD					0 265 008 340 <sup>4</sup>	
					RAB	0 265 008 338 <sup>3</sup>	
	2.0 R 4WD	03.05-06.06	110-121		LAB	0 265 007 945 <sup>4</sup>	
						0 265 008 357 <sup>3</sup>	
					RAB	0 265 007 944 <sup>4</sup>	
						0 265 008 358 <sup>3</sup>	
		07.06-05.09	110-121		RAB	0 265 008 341 <sup>4</sup>	
	2.0 4WD	07.03-06.05	101		LAB	0 265 007 945 <sup>4</sup>	
						0 265 008 357 <sup>3</sup>	
					RAB	0 265 007 944 <sup>4</sup>	
						0 265 008 358 <sup>3</sup>	
	2.5 4WD	07.03-06.06	121		LAB	0 265 007 945 <sup>4</sup>	
						0 265 008 357 <sup>3</sup>	
					RAB	0 265 007 944 <sup>4</sup>	
						0 265 008 358 <sup>3</sup>	
		07.06-05.09	127		LAB	0 265 008 339 <sup>3</sup>	
						0 265 008 340 <sup>4</sup>	
					RAB	0 265 008 338 <sup>3</sup>	
						0 265 008 341 <sup>4</sup>	
	3.0 4WD	07.03-06.06	180		LAB	0 265 007 945 <sup>4</sup>	
						0 265 008 357 <sup>3</sup>	
					RAB	0 265 007 944 <sup>4</sup>	
						0 265 008 358 <sup>3</sup>	
		07.06-05.09	180		LAB	0 265 008 339 <sup>3</sup>	
						0 265 008 340 <sup>4</sup>	
					RAB	0 265 008 338 <sup>3</sup>	
						0 265 008 341 <sup>4</sup>	

**Legacy Kombi [B14]**

	2.5	06.09-12.12	123				F 026 A03 551 <sup>7</sup>

		S							
	2.5	06.09-12.12	123						F 026 A06 138 <sup>7</sup>
	2.5	06.09-12.12	123				1 987 482 351	1750	
<b>Legacy Outback [BE/BH]</b>									
	2.5 i 4WD	10.98-06.03	115						F 026 A03 529 <sup>7</sup>
	3.0 i 4WD	07.00-04.01	154						F 026 A03 529 <sup>7</sup>
		01.01-04.02	154			TW			F 026 A03 529 <sup>7</sup>
		05.02-06.03	154						F 026 A03 529 <sup>7</sup>
	2.5 i 4WD	10.98-06.03	115						F 026 A03 492 <sup>7</sup>
	3.0 i 4WD	07.00-06.03	154						F 026 A03 492 <sup>7</sup>
	2.5 i 4WD	10.98-06.99	115		LAB		F 01G 065 0LM <sup>3</sup>		
					RAB		F 01G 065 0LN <sup>3</sup>		
		10.98-06.03	115		LAB		F 01G 065 0PG <sup>4</sup>		
					RAB		F 01G 065 0PH <sup>4</sup>		
		07.99-06.03	115		LAB		F 01G 065 0PF <sup>3</sup>		
	3.0 i 4WD	07.00-06.03	154		LAB		F 01G 065 0PF <sup>3</sup>		
							F 01G 065 0PG <sup>4</sup>		
					RAB		F 01G 065 0PH <sup>4</sup>		
<b>Legacy Outback [BL/BP]</b>									
	2.0 D 4WD	04.07-05.09	110-121						F 026 A03 551 <sup>7</sup>
	2.5 4WD	07.03-06.09	121/127						F 026 A03 551 <sup>7</sup>
	3.0 4WD	07.03-05.09	180						F 026 A03 551 <sup>7</sup>
	2.0 D 4WD	04.07-05.09	110-121						F 026 A06 138 <sup>7</sup>
	2.5 4WD	07.03-06.09	121						F 026 A06 138 <sup>7</sup>
		07.06-05.09	127						F 026 A06 138 <sup>7</sup>
	3.0 4WD	07.03-05.09	180						F 026 A06 138 <sup>7</sup>
	2.0 D 4WD	04.07-05.09	110-121				1 987 482 351	→ 1750	
							1 987 482 352	← 1750	
	2.5 4WD	08.04-06.09	121/127				1 987 482 351	→ 1750	
							1 987 482 352	← 1750	
	3.0 4WD	08.04-05.09	180				1 987 482 351	→ 1750	
							1 987 482 352	← 1750	
	2.0 D 4WD	04.07-05.09	110-121		LAB		0 265 008 339 <sup>3</sup>		
							0 265 008 340 <sup>4</sup>		
					RAB		0 265 008 338 <sup>3</sup>		
							0 265 008 341 <sup>4</sup>		



		S							
<b>Subaru Legacy Outback [BL/BP]</b>									
	2.5 4WD	07.03-03.06	121	LAB	RAB	0 265 007 945 <sup>4</sup>	0 265 008 357 <sup>3</sup>		
						0 265 007 944 <sup>4</sup>	0 265 008 358 <sup>3</sup>		
	04.06-06.09	121	LAB	RAB	0 265 008 339 <sup>3</sup>	0 265 008 340 <sup>4</sup>			
					0 265 008 338 <sup>3</sup>	0 265 008 341 <sup>4</sup>			
	07.06-05.09	127	LAB	RAB	0 265 008 339 <sup>3</sup>	0 265 008 340 <sup>4</sup>			
					0 265 008 338 <sup>3</sup>	0 265 008 341 <sup>4</sup>			
	07.03-06.06	180	LAB	RAB	0 265 007 945 <sup>4</sup>	0 265 008 357 <sup>3</sup>			
					0 265 007 944 <sup>4</sup>	0 265 008 358 <sup>3</sup>			
	07.06-05.09	180	LAB	RAB	0 265 008 339 <sup>3</sup>	0 265 008 340 <sup>4</sup>			
					0 265 008 338 <sup>3</sup>	0 265 008 341 <sup>4</sup>			
<b>Legacy Sedan [BE/BH]</b>									
	2.5 i 4WD	10.98-06.03	115						F 026 A03 529 <sup>7</sup>
	2.5 i 4WD	10.98-06.03	115						F 026 A03 492 <sup>7</sup>
	2.0 i 4WD	10.98-06.99	92	LAB	RAB	F 01G 065 0LK <sup>3</sup>	F 01G 065 0LL <sup>3</sup>		
		10.98-06.03	92	LAB	RAB	F 01G 065 0PG <sup>4</sup>	F 01G 065 0PH <sup>4</sup>		
		07.99-06.03	92	LAB		F 01G 065 0PE <sup>3</sup>			
	2.5 i 4WD	10.98-06.99	115	LAB	RAB	F 01G 065 0LK <sup>3</sup>	F 01G 065 0LL <sup>3</sup>		
		10.98-06.03	115	LAB	RAB	F 01G 065 0PG <sup>4</sup>	F 01G 065 0PH <sup>4</sup>		
		07.99-06.03	115	LAB		F 01G 065 0PE <sup>3</sup>			
<b>Legacy Station Wagon [B14]</b>									
	2.0	06.09→	110						F 026 A03 551 <sup>7</sup>
	2.0D	06.09→	110						F 026 A03 551 <sup>7</sup>
	2.5	03.12→	125-127			277			F 026 A03 551 <sup>7</sup>
						294			F 026 A03 551 <sup>7</sup>
	2.0, D	06.09→	110						F 026 A06 138 <sup>7</sup>
	2.5	03.12→	125-127						F 026 A06 138 <sup>7</sup>
	2.0	06.09-02.12	110				1987 482 351	1750	
	2.0D								

		S				?			
<b>Legacy Station Wagoni [B14]</b>									
	2.5GT	06.09-02.12	195				1 987 482 351	1750	
<b>Outback [B14]</b>									
	2.0D	06.09-04.15	110		294				F 026 A03 551 <sup>7</sup>
	2.5	06.09-04.15	123		294				F 026 A03 551 <sup>7</sup>
	2.0D	06.09-04.15	110		15Z				F 026 A06 138 <sup>7</sup>
	2.5	06.09-04.15	123		15Z				F 026 A06 138 <sup>7</sup>
	2.0D	06.09-02.12	110				1 987 482 351	1750	
	2.5	06.09-02.12	123				1 987 482 351	1750	
	3.6	06.09-02.12	191				1 987 482 351	1750	
<b>SVX</b>									
	3.3i 4WD	09.92-12.96	169-176		LAB		F 01G 065 0AC <sup>4</sup>		
<b>Trezia [NLP]</b>									
	1.4D	03.11→	66		HTB		1 987 482 463	← 1657	
							1 987 482 464	→ 1695	
<b>Trezia [NSP]</b>									
	1.3	03.11→	73		HTB		1 987 482 463	← 1657	
							1 987 482 464	→ 1695	
<b>WRX [V10]</b>									
	2.0	05.14→	197						F 026 A06 138 <sup>7</sup>
<b>XV [G33]</b>									
	1.6i	09.11→	84						F 026 A03 551 <sup>7</sup>
	2.0D, DL, i	08.11→	80/108/110						F 026 A03 551 <sup>7</sup>
	1.6i	09.11→	84						F 026 A06 138 <sup>7</sup>
	2.0D, DL, i	08.11→	80/108/110						F 026 A06 138 <sup>7</sup>
	1.6i	09.11-07.12	84		LAB		0 265 008 755 <sup>3</sup>		
	2.0D, DL, i	08.11-07.12	80/108/110		LAB		0 265 008 755 <sup>3</sup>		







**SUZUKI**

**Alto Hatchback [AMF]**

	1.0	12.08→	50		F 026 <b>002 009</b>	↔ 19,05
--	-----	--------	----	--	----------------------	---------

**Alto Hatchback [EF]**

	1.0	10.94-02.02	40		0986 <b>475 952</b>	→ 17,5
	1.0i	10.94-02.02	39	Fg.-Nr. →00180000	0986 <b>475 953</b>	← 17,5
	1.0i	10.94-02.02	39/40		0986 <b>475 952</b>	→ 17,5
	1.0i	10.94-02.02	39/40		0986 <b>475 953</b>	← 17,5

	1.0i	10.94-02.02	39/40		1987 <b>482 088</b>	3135
--	------	-------------	-------	--	---------------------	------

























**Alto [MA]**

	1.1i 16V	02.02-12.06	46		F 01G <b>060 12G</b>	↔
	1.1i 16V	02.02-12.06	46		1987 <b>482 096</b>	← 1478
	1.1i 16V	02.02-12.06	46		1987 <b>482 211</b>	→ 1475

**Baleno Hatchback**

	1.3i 16V	04.95-04.05	62-63	Fg.-Nr. 00160001→00400000		F 026 <b>A07 008</b> <sup>7</sup>
	1.3i 16V	04.95-04.05	62-63		0986 <b>475 856</b>	← 17,5
	1.6i 16V	04.95-04.05	72-74		0986 <b>475 857</b>	→ 17,5
	1.6i 16V 4WD	04.95-04.05	72-74		0986 <b>475 856</b>	← 17,5
	1.6i 16V 4WD	04.95-04.05	72-74		0986 <b>475 857</b>	→ 17,5
	1.3i 16V	04.95-04.05	62-63	Fg.-Nr. →00160000	1987 <b>477 607</b>	→ 1572
	1.3i 16V	04.95-04.05	62-63	Fg.-Nr. →00160000	1987 <b>477 793</b>	→ 1499
	1.3i 16V	04.95-04.05	62-63	Fg.-Nr. 00160001→	1987 <b>477 607</b>	→ 1572
	1.3i 16V	04.95-04.05	62-63	Fg.-Nr. 00160001→	1987 <b>477 610</b>	← 1656
	1.3i 16V	04.95-04.05	62-63	Fg.-Nr. 00160001→	1987 <b>477 793</b>	→ 1499
	1.6i 16V, i 16V 4WD	04.95-04.05	72-74		1987 <b>477 793</b>	→ 1499
	1.8i 16V	09.95-09.05	89		1987 <b>477 608</b>	→ 1475
	1.8i 16V	09.95-09.05	89		1987 <b>477 609</b>	← 1557
	1.9D Turbo	04.98-05.02	55		1987 <b>477 608</b>	→ 1475
	1.9D Turbo	04.98-05.02	55		1987 <b>477 609</b>	← 1557





































		S							
<b>Baleno Sedan</b>									
									
	1.3i 16V	04.95-04.05	62-63				0 986 475 856	← 17,5	
							0 986 475 857	→ 17,5	
	1.5i 16V	04.95-04.05	71				0 986 475 856	← 17,5	
							0 986 475 857	→ 17,5	
	1.6i 16V	04.95-04.05	72-74				0 986 475 856	← 17,5	
	1.6i 16V 4WD						0 986 475 857	→ 17,5	
									
	1.3i 16V	04.95-04.05	62-63				1 987 477 607	→ 1572	
							1 987 477 610	← 1656	
	1.5i 16V	04.95-04.05	71				1 987 477 607	→ 1572	
	1.6i 16V	04.95-04.05	72-74				1 987 477 607	→ 1572	
	1.6i 16V 4WD						1 987 477 610	← 1656	
	1.8i 16V	09.95-09.05	89				1 987 477 608	→ 1475	
							1 987 477 609	← 1557	
	1.9D Turbo	12.98-05.02	55				1 987 477 608	→ 1475	
							1 987 477 609	← 1557	
<b>Baleno Wagon</b>									
									
	1.3i 16V	09.97-09.07	62-63				0 986 475 856	← 17,5	
							0 986 475 857	→ 17,5	
	1.6i 16V	08.96-05.02	72-74				0 986 475 856	← 17,5	
	1.6i 16V 4WD						0 986 475 857	→ 17,5	
									
	1.3i 16V	09.97-09.07	62-63				1 987 477 607	→ 1572	
							1 987 477 610	← 1656	
	1.6i 16V	08.96-05.02	72-74				1 987 477 607	→ 1572	
	1.6i 16V 4WD						1 987 477 610	← 1656	
	1.8i 16V	08.96-08.06	89				1 987 477 608	→ 1475	
							1 987 477 609	← 1557	
	1.9D Turbo	12.98-05.02	55				1 987 477 608	→ 1475	
							1 987 477 609	← 1557	
<b>Carry [ED]</b>									
									
	1.0	10.85-03.99	33				F 026 A02 232	↔	
<b>Carry [FD]</b>									
									
	1.3 16V	03.99-03.09	58						F 026 A03 476 <sup>6</sup>
									
	1.3 16V	03.99-03.09	58				0 986 475 964	→ 19	
							0 986 475 965	← 19	
<b>Escudo</b>									
									
	1.6i	01.94→	79				0 986 475 962	→ 22,2	
							0 986 475 963	← 22,2	

		S							
◀ SUZUKI									
<b>Grand Vitara</b>									
	2.0 D Turbo	03.98-03.08	68/94	Fg.-Nr. →00150000	0986 473 510		← 57		
	2.0 i 16V				0986 474 510		→ 57		
	1.6 i 16V	03.98-12.05	69-71		0986 475 962		→ 22,2		
					0986 475 963		← 22,2		
	1.6 4WD	10.05→	78	Fg.-Nr. →00500000	0986 475 963		↔ 22,2		
	2.0 D Turbo, i 4WD, i 16V, TDi XL-7	03.98→	68/80/94/ 103-108		0986 475 962		→ 22,2		
					0986 475 963		← 22,2		
	2.5 i 4WD	04.98-12.05	87/106-116		0986 475 962		→ 22,2		
	2.5 i 4x4				0986 475 963		← 22,2		
	2.7 i XL-7 4WD	06.01→	127-135		0986 475 962		→ 22,2		
	2.7 XL-7				0986 475 963		← 22,2		
	1.6 i 16V	03.98-12.05	69-71		1987 482 090		→ 1390		
					1987 482 091		← 1336		
	2.0 D Turbo	03.98-03.08	68/80		1987 482 094		→ 1625		
					1987 482 095		← 1575		
	2.0 i 4WD	10.00→	103-108		1987 482 094		→ 1625		
					1987 482 095		← 1575		
	2.0 i 16V	03.98-12.05	94		1987 482 090		→ 1390		
					1987 482 091		← 1336		
					1987 482 094		→ 1625		
					1987 482 095		← 1575		
	2.5 i 4WD	04.98-12.05	87/106-116		1987 482 094		→ 1625		
	2.5 i 4x4				1987 482 095		← 1575		
<b>Grand Vitara Cabrio</b>									
	1.6 i 16V	03.98-03.08	69	Fg.-Nr. →00470000	0986 475 962		→ 22,2		
					0986 475 963		← 22,2		
	2.0 i 16V	03.98-03.08	94		0986 475 962		→ 22,2		
					0986 475 963		← 22,2		
	1.6 i 16V	03.98-03.08	69		1987 482 090		→ 1390		
					1987 482 091		← 1336		
	2.0 i 16V	03.98-03.08	94		1987 482 090		→ 1390		
					1987 482 091		← 1336		
<b>Ignis Hatchback</b>									
	1.3 DDiS Turbo	10.03-12.07	51		0 204 204 711		← 48	0 204 104 298 <sup>7</sup>	
					0 204 204 712		→ 48	0 204 104 298 <sup>7</sup>	
	1.3 i 16V	10.00-09.03	61	Fg.-Nr. →S00170000				F 026 A03 476 <sup>6</sup>	
	1.3 i 16V 4WD			Fg.-Nr. S00170001→				F 026 A03 476 <sup>6</sup>	
		10.03-12.07	69		0 204 204 711		← 48		
					0 204 204 712		→ 48		
								0 204 104 298 <sup>7</sup>	
	1.5 i 16V Sport	12.03-12.07	80					F 026 A03 476 <sup>6</sup>	
	1.5 i 16V	10.03-12.07	73		0 204 204 711		← 48	0 204 104 298 <sup>7</sup>	
	1.5 i 16V 4WD				0 204 204 712		→ 48	0 204 104 298 <sup>7</sup>	

	1.3 DDiS Turbo	10.03-12.07	51				0 986 475 954	↔ 15,87	
	1.3 i 16V	10.00-09.03	61				F 026 002 384	↔ 15,87	
	1.3 i 16V 4WD	10.03-12.07	69				0 986 475 954	↔ 15,87	
	1.5 i 16V, i 16V 4WD	10.03-12.07	73				0 986 475 954	↔ 15,87	
	1.3 DDiS Turbo	10.03-12.07	51				1 987 482 092	→ 1523	
							1 987 482 093	← 1532	
	1.3 i 16V	10.00-09.03	61				1 987 482 176	← 1512	
	1.3 i 16V 4WD	10.03-12.07	69				1 987 482 092	→ 1523	
							1 987 482 093	← 1532	
	1.5 i 16V	10.03-12.07	73				1 987 482 092	→ 1523	
	1.5 i 16V 4WD						1 987 482 093	← 1532	
<b>Jimny</b>									
	1.0	01.90-12.95	33			ABL	F 026 A02 218	→	
							F 026 A02 219	←	
						AFL	F 026 A02 220	→	
							F 026 A02 221	←	
	1.0	01.90-12.95	33				0 986 475 858	← 22,2	
							0 986 475 859	→ 22,2	
<b>Jimny [FJ]</b>									
	1.3 i 16V, i 16V 4WD	10.98-10.08	59						F 026 A08 164 <sup>7</sup>
	1.5 DDiS 4WD	12.03→	48/63						F 026 A03 476 <sup>6</sup>
	1.3 i 16V	10.98→	59/60-63				0 986 475 964	→ 19	
	1.3 i 16V 4WD						0 986 475 965	← 19	
	1.5 DDiS 4WD	12.03→	48/63				0 986 475 964	→ 19	
							0 986 475 965	← 19	
	1.3 i 16V, i 16V 4WD	10.98→	59/60-63				1 987 477 875	→ 1570	
	1.5 DDiS 4WD	12.03→	48/63				1 987 477 875	→ 1570	
<b>Kizashi</b>									
	2.4 i	06.10→	131			LAB	0 265 008 422 <sup>3</sup>		
	2.4 i 4WD						0 265 008 424 <sup>4</sup>		
						RAB	0 265 008 423 <sup>3</sup>		
<b>Liana Hatchback</b>									
	1.3 i 16V	03.01-12.04	66				0 986 475 856	← 17,5	
							0 986 475 857	→ 17,5	
	1.4 D	03.05-12.07	66				0 986 475 856	← 17,5	
							0 986 475 857	→ 17,5	
	1.6 i 16V	03.01-04.08	76				0 986 475 856	← 17,5	
	1.6 i 16V 4WD						0 986 475 857	→ 17,5	





















		S							
<b>◀ SUZUKI Liana Hatchback</b>									
		1.8 i 16V	04.05-12.07	92			0986 475 856	← 17,5	
							0986 475 857	→ 17,5	
		1.3 i 16V	03.01-12.04	66			1987 482 257	→ 1585	
							1987 482 258	← 1635	
		1.4 D	03.05-12.07	66			1987 482 257	→ 1585	
							1987 482 258	← 1635	
		1.6 i 16V	03.01-04.08	76			1987 482 257	→ 1585	
		1.6 i 16V 4WD					1987 482 258	← 1635	
		1.8 i 16V	04.05-12.07	92			1987 482 257	→ 1585	
							1987 482 258	← 1635	
<b>Liana Sedan</b>									
		1.3 i 16V	04.02-12.04	66			0986 475 856	← 17,5	
							0986 475 857	→ 17,5	
		1.4 D	03.05-12.07	66			0986 475 856	← 17,5	
							0986 475 857	→ 17,5	
		1.6 i 16V	04.02-12.07	76			0986 475 856	← 17,5	
		1.6 i 16V 4WD					0986 475 857	→ 17,5	
		1.8 i 16V	04.05-12.07	92			0986 475 856	← 17,5	
							0986 475 857	→ 17,5	
		1.3 i 16V	04.02-12.04	66			1987 482 257	→ 1585	
							1987 482 258	← 1635	
		1.4 D	03.05-12.07	66			1987 482 257	→ 1585	
							1987 482 258	← 1635	
		1.6 i 16V	04.02-12.07	76			1987 482 257	→ 1585	
		1.6 i 16V 4WD					1987 482 258	← 1635	
		1.8 i 16V	04.05-12.07	92			1987 482 257	→ 1585	
							1987 482 258	← 1635	
<b>Samurai</b>									
		1.3	03.87-12.97	44/47/50/51			0986 473 399	↔ 51	
							0986 474 399	↔ 51	
		1.3 i	11.88-12.04	44/47/50/51			0986 473 399	↔ 51	
							0986 474 399	↔ 51	
		1.0	07.84-12.94	33			0986 475 967	↔ 22,2	
		1.3	03.87-12.97	51			F 026 A02 337	→	
							F 026 A02 338	←	
			08.88-12.04	47			0986 475 967	↔ 22,2	
			11.88-03.95	50			F 026 A02 337	→	
							F 026 A02 338	←	
			11.88-12.01	40/44			F 026 A02 337	→	
							F 026 A02 338	←	
		1.3 i	11.88-12.04	47			F 026 A02 337	→	
							F 026 A02 338	←	
			08.93-12.04	51			0986 475 967	↔ 22,2	
		1.9 D Turbo 4x4	08.93-12.04	46			0986 475 967	↔ 22,2	

		S							
<b>Samurai Cabrio</b>									
									
	1.3	03.87-12.97	47/51			0 986 473 399		← 51	
						0 986 474 399		→ 51	
	1.3i	04.95-12.04	47/51			0 986 473 399		← 51	
						0 986 474 399		→ 51	
									
	1.3	03.87-12.97	51			F 026 A02 337		→	
						F 026 A02 338		←	
	1.3	11.88-12.04	47			F 026 A02 337		→	
	1.3i					F 026 A02 338		←	
	1.9D Turbo 4x4	08.93-12.04	46			0 986 475 967		↔ 22,2	
<b>Splash [A5B]</b>									
									
	1.0	01.08→	48-50			0 986 134 325		← 54	F 026 A06 215 <sup>7</sup>
						0 986 135 325		→ 54	F 026 A06 215 <sup>7</sup>
	1.2	01.08→	63/66-69			0 986 134 325		← 54	F 026 A06 215 <sup>7</sup>
						0 986 135 325		→ 54	F 026 A06 215 <sup>7</sup>
	1.3 DDiS	01.08→	55			0 986 134 325		← 54	F 026 A06 215 <sup>7</sup>
						0 986 135 325		→ 54	F 026 A06 215 <sup>7</sup>
									
	1.0	01.08→	48-50			0 986 475 951		↔ 19,05	
	1.2	01.08→	63/66-69			0 986 475 951		↔ 19,05	
	1.3 DDiS	01.08→	55			0 986 475 951		↔ 19,05	
									
	1.0	01.08→	48-50			1 987 482 427		→ 1600	
						1 987 482 428		← 1600	
	1.2	01.08→	63/66-69			1 987 482 427		→ 1600	
						1 987 482 428		← 1600	
	1.3 DDiS	01.08→	55			1 987 482 427		→ 1600	
						1 987 482 428		← 1600	
<b>Swift Cabrio [EA]</b>									
									
	1.3	09.91-12.95	49/50						F 026 A06 593 <sup>6</sup>
	1.3i								
									
	1.3	09.91-12.95	49/50			0 986 475 680		↔ 15,87	
	1.3i								
<b>Swift Hatchback [EA]</b>									
									
	1.0, i	10.89-09.95	39/40			0 986 475 680		↔ 15,87	
	1.3i	09.91-04.95	50			0 986 475 680		↔ 15,87	
		09.91-09.95	50			0 986 475 856		← 17,5	
	1.3i, i 4WD	03.91-09.95	50			0 986 475 857		→ 17,5	
	1.3i 4WD	03.91-04.95	50			0 986 475 856		← 17,5	



		S							
◀ SUZUKI									
<b>Swift Hatchback [MA]</b>									
	1.0 i	03.96-12.04	39	Fg.-Nr. →*00320339					F 026 A06 593 <sup>6</sup>
		05.98-12.04	39	Fg.-Nr. *00320340→	0 204 001 393	← 48			
					0 204 001 394	→ 48			
	1.3 i	06.96-12.04	50/63	Fg.-Nr. →*00320339					F 026 A06 593 <sup>6</sup>
		05.98-12.04	50/63	Fg.-Nr. *00320340→	0 204 001 393	← 48			
	1.3 i 16V				0 204 001 394	→ 48			
	1.0 i	03.96-12.04	39		0 986 475 680	↔ 15,87			
		ABO 04.97-12.04	39		F 026 002 007	↔ 17,46			
		ABS 03.96-12.04	39		F 026 002 559	→ 17,46			
					F 026 002 560	← 17,46			
				Fg.-Nr. →*00320339	0 986 475 856	← 17,5			
					0 986 475 857	→ 17,5			
	1.3 i	06.96-12.04	50/63		0 986 475 680	↔ 15,87			
	1.3 i 16V	ABO 04.97-12.04	50/63		F 026 002 007	↔ 17,46			
		ABS 06.96-12.04	50/63		F 026 002 559	→ 17,46			
					F 026 002 560	← 17,46			
				Fg.-Nr. →*00320339	0 986 475 856	← 17,5			
					0 986 475 857	→ 17,5			
<b>Swift Hatchback [MZ/EZ]</b>									
	1.3, DDiS, DDiS D Turbo, 4WD	11.04→	51-55/67		0 986 134 325	← 54			F 026 A06 215 <sup>7</sup>
					0 986 135 325	→ 54			F 026 A06 215 <sup>7</sup>
	1.5	11.04→	75-81		0 986 134 325	← 54			F 026 A06 215 <sup>7</sup>
					0 986 135 325	→ 54			F 026 A06 215 <sup>7</sup>
	1.6	01.07→	92		0 986 134 325	← 54			F 026 A06 215 <sup>7</sup>
					0 986 135 325	→ 54			F 026 A06 215 <sup>7</sup>
	1.3	11.04→	67		0 986 475 951	↔ 19,05			
		1.3 DDiS, DDiS D Turbo	08.05→	51-55		0 986 475 951	↔ 19,05		
	1.3 4WD	11.04→	67		F 026 A02 331	→			
					F 026 A02 332	←			
	1.5	11.04→	75-81		0 986 475 951	↔ 19,05			
	1.3, DDiS, DDiS D Turbo	11.04→	51-55/67		1 987 482 356	→ 1810			
					1 987 482 357	← 1814			
	1.5	11.04→	75-81		1 987 482 356	→ 1810			
					1 987 482 357	← 1814			
<b>Swift [MA]</b>									
	1.0 i	03.96-12.04	39	Fg.-Nr. →*00320339					F 026 A06 593 <sup>6</sup>
		05.98-12.04	39	Fg.-Nr. *00320340→	0 204 001 393	← 48			
					0 204 001 394	→ 48			
	1.3 i	06.96-12.04	50/63	Fg.-Nr. →*00320339					F 026 A06 593 <sup>6</sup>
	1.3 i 16V	05.98-12.04	50/63	Fg.-Nr. *00320340→	0 204 001 393	← 48			
					0 204 001 394	→ 48			
	1.0 i	04.97-12.04	39	Fg.-Nr. →TSMMA...S00320339	0 986 475 856	← 17,5			
					0 986 475 857	→ 17,5			























		S							
1.0i		05.98-12.04	39	Fg.-Nr. TSMMA...S00320340→			F 026 <b>002 559</b>	→ 17,46	
							F 026 <b>002 560</b>	← 17,46	
1.3i		06.96-03.01	50				0 986 <b>475 857</b>	→ 17,5	
		04.97-03.01	50	Fg.-Nr. →TSMMA...S00320339			0 986 <b>475 856</b>	← 17,5	
		05.98-03.01	50	Fg.-Nr. TSMMA...S00320340→			F 026 <b>002 559</b>	→ 17,46	
							F 026 <b>002 560</b>	← 17,46	
		ABS 06.96-03.01	50				F 026 <b>002 559</b>	→ 17,46	
							F 026 <b>002 560</b>	← 17,46	
1.3i 16V		04.01-12.04	63				F 026 <b>002 559</b>	→ 17,46	
							F 026 <b>002 560</b>	← 17,46	
<b>Swift [MZ/EZ]</b>									
									
	1.3i	11.04-09.10	67				F 026 <b>002 601</b>	↔ 19,05	
<b>Swift Sedan [EA]</b>									
									
	1.3i	08.91-09.95	50				0 986 <b>475 856</b>	← 17,5	
							0 986 <b>475 857</b>	→ 17,5	
	1.6i 16V, i 16V 4WD, 16V, 16V 4WD	09.91-09.95	68/70				F 026 <b>A02 331</b>	→	
							F 026 <b>A02 332</b>	←	
<b>SX4</b>									
									
	1.6 VVT	12.07→	75-79/88				0 986 <b>475 951</b>	↔ 19,05	
									
	1.6 VVT	12.07→	75-79/88	LAB			0 265 <b>007 954</b> <sup>3</sup>		
							0 265 <b>007 956</b> <sup>4</sup>		
				RAB			0 265 <b>007 955</b> <sup>3</sup>		
							0 265 <b>007 957</b> <sup>4</sup>		
<b>SX4 Hatchback</b>									
									
	1.5	05.06→	73				0 986 <b>475 951</b>	↔ 19,05	
	1.6 DDiS, VVT, VVT 4WD	05.06→	66/75-81/88				0 986 <b>475 951</b>	↔ 19,05	
	1.9 DDiS, DDiS 4WD	05.06→	88				0 986 <b>475 951</b>	↔ 19,05	
									
	1.5	05.06→	73				1 987 <b>482 434</b>	→ 1797	
							1 987 <b>482 435</b>	← 1787	
	1.6 DDiS, VVT, VVT 4WD	05.06→	66/79-81				1 987 <b>482 434</b>	→ 1797	
							1 987 <b>482 435</b>	← 1787	
	1.6 VVT	09.09→	88				1 987 <b>482 465</b>	→ 1638	
	1.6 VVT 4WD						1 987 <b>482 466</b>	← 1638	
	1.9 DDiS	05.06→	88				1 987 <b>482 434</b>	→ 1797	
	1.9 DDiS 4WD						1 987 <b>482 435</b>	← 1787	
	2.0 DDiS	09.09→	99				1 987 <b>482 465</b>	→ 1638	
	2.0 DDiS 4WD						1 987 <b>482 466</b>	← 1638	
	1.5	05.06→	73	LAB			0 265 <b>007 954</b> <sup>3</sup>		
							0 265 <b>007 956</b> <sup>4</sup>		
				RAB			0 265 <b>007 955</b> <sup>3</sup>		
							0 265 <b>007 957</b> <sup>4</sup>		

































			S								
<b>SUZUKI SX4 Hatchback</b>											
	1.6 DDiS	04.07→	66/75-79		LAB	0 265 007 954 <sup>3</sup>					
	1.6 VWT				RAB	0 265 007 956 <sup>4</sup>					
	1.6 VWT	05.06→	79-81/88		LAB	0 265 007 955 <sup>3</sup>					
	1.6 VWT				RAB	0 265 007 957 <sup>4</sup>					
	1.6 VWT	05.06→	79-81/88		LAB	0 265 007 956 <sup>4</sup>					
	1.6 VWT 4WD				RAB	0 265 007 954 <sup>3</sup>					
	1.6 VWT 4WD	05.06→	79		LAB	0 265 007 955 <sup>3</sup>					
	1.6 VWT 4WD				RAB	0 265 007 954 <sup>3</sup>					
	1.9 DDiS	05.06→	88		LAB	0 265 007 955 <sup>3</sup>					
	1.9 DDiS				RAB	0 265 007 956 <sup>4</sup>					
	1.9 DDiS	05.06→	88		LAB	0 265 007 957 <sup>4</sup>					
	1.9 DDiS 4WD				RAB	0 265 007 954 <sup>3</sup>					
	2.0 DDiS	09.09→	99		LAB	0 265 007 955 <sup>3</sup>					
	2.0 DDiS				RAB	0 265 007 956 <sup>4</sup>					
	2.0 DDiS	09.09→	99		LAB	0 265 007 957 <sup>4</sup>					
	2.0 DDiS 4WD				RAB	0 265 007 954 <sup>3</sup>					
<b>Vitara Cabrio [ET]</b>											
	1.6	03.90-03.98	55/60			0 986 473 137		←	48,04		
	1.6 i					0 986 474 137		→	48,04		
	1.6	09.88-03.98	55/60			0 986 475 726		←	23,81		
	1.6 i					0 986 475 727		→	23,81		
	1.6 i 16V	02.91-03.98	70-74			0 986 475 860		←	23,8		
	1.6 i 16V					0 986 475 861		→	23,8		
	1.9 D 4x4	01.95-03.98	50			0 986 475 814		↔	22,2		
	1.9 D 4x4										
	1.9 D 4x4	01.95-03.98	50			1 987 482 089		→	1395		
	1.9 D 4x4					1 987 482 184		←	1340		
<b>Vitara Cabrio [OS]</b>											
	1.6 i	01.93-03.98	59			0 986 475 860		←	23,8		
	1.6 i					0 986 475 861		→	23,8		
	1.6 i	01.93-03.98	59			1 987 482 089		→	1395		
	1.6 i					1 987 482 184		←	1340		
<b>Vitara [ET]</b>											
	1.6	03.90-03.98	55/60			0 986 473 137		←	48,04		
	1.6 i					0 986 474 137		→	48,04		
	1.6	09.88-03.98	55/60			0 986 475 726		←	23,81		
	1.6 i					0 986 475 727		→	23,81		
	1.6 i 16V	02.91-03.98	70			0 986 475 860		←	23,8		
	1.6 i 16V					0 986 475 861		→	23,8		
	1.6 i 16V	03.95-03.98	71			F 026 A02 396		→			
	1.6 i 16V					F 026 A02 397		←			

		S							
<b>1.9 D 4x4</b>			01.95-03.98	50		FKR FLR	0 986 <b>475 814</b> F 026 <b>A02 396</b> F 026 <b>A02 397</b>	↔ 22,2 → ←	
<b>2.0 D Turbo, D Turbo Interc., i 24V</b>			03.95-03.98	52/64/100			F 026 <b>A02 396</b> F 026 <b>A02 397</b>	→ ←	
<b>2.5 i 24V</b>			03.95-03.98	118			F 026 <b>A02 396</b> F 026 <b>A02 397</b>	→ ←	
									
 <b>1.6 i 16V</b>			03.95-03.98	71		FKR FLR	1 987 <b>482 089</b> 1 987 <b>482 184</b> 1 987 <b>477 874</b>	→ 1395 ← 1340 ← 1630	
<b>1.9 D 4x4</b>			01.95-03.98	50		FKR FLR	1 987 <b>482 089</b> 1 987 <b>482 184</b> 1 987 <b>477 874</b>	→ 1395 ← 1340 ← 1630	
<b>Vitara [SV]</b>									
									
 <b>1.9 D</b>			08.96-12.98	55			0 986 <b>475 967</b>	↔ 22,2	
<b>Wagon R+ [EM]</b>									
									
 <b>1.0 i 16V</b>			09.97-05.00	48-52			F 01G <b>09G 06V</b>	↔	
<b>1.2 i 16V, i 16V 4WD</b>			07.98-05.00	51			F 01G <b>09G 06V</b>	↔	
<b>Wagon R+ [MM]</b>									
									
 <b>1.0 i 16V</b>			05.00-08.03	39			0 986 <b>473 344</b> 0 986 <b>474 344</b>	↔ 48 ↔ 48	
<b>1.2 i</b>			05.04-08.08	59			0 204 <b>204 711</b> 0 204 <b>204 712</b>	← 48 → 48	
<b>1.3 DDiS D Turbo</b>			09.03-03.06	51			0 204 <b>204 711</b> 0 204 <b>204 712</b>	← 48 → 48	0 204 <b>104 298</b> <sup>7</sup>
<b>1.3 i 16V</b>			05.00-08.03	56	Fg.-Nr. →00210000		0 986 <b>473 344</b> 0 986 <b>474 344</b>	↔ 48 ↔ 48	
<b>1.3 i 16V 4WD</b>					Fg.-Nr. 00210001→		0 204 <b>204 711</b> 0 204 <b>204 712</b>	← 48 → 48	0 204 <b>104 298</b> <sup>7</sup>
			09.03-03.06	69			0 204 <b>204 711</b> 0 204 <b>204 712</b>	← 48 → 48	0 204 <b>104 298</b> <sup>7</sup>
									
 <b>1.0 i 16V</b>			05.00-08.03	39			F 026 <b>002 384</b>	↔ 15,87	
<b>1.2 i</b>			05.04-08.08	59			0 986 <b>475 954</b>	↔ 15,87	
<b>1.3 DDiS D Turbo</b>			09.03-03.06	51			0 986 <b>475 954</b>	↔ 15,87	
<b>1.3 i 16V</b>			05.00-08.03	56	Fg.-Nr. →00210000		F 026 <b>002 384</b>	↔ 15,87	
<b>1.3 i 16V 4WD</b>					Fg.-Nr. 00210001→		0 986 <b>475 954</b>	↔ 15,87	
			09.03-03.06	69			0 986 <b>475 954</b>	↔ 15,87	
									
 <b>1.3 i 16V</b>			05.00-08.03	56	Fg.-Nr. →00210000		1 987 <b>477 995</b>	→ 1507	
<b>1.3 i 16V 4WD</b>									

		S								
<b>◀ SUZUKI</b>										
<b>X-90</b>										
	1.6 i 1.6 i 4x4	09.95→	71							F 026 <b>A08 106</b> <sup>7</sup>
	1.6 i 1.6 i 4x4	09.95→	71			F 026 <b>A02 396</b>		→		
						F 026 <b>A02 397</b>		←		
	1.6 i 1.6 i 4x4	09.95→	71			1 987 <b>482 089</b>		→	1395	
						1 987 <b>482 184</b>		←	1340	
<b>TATA (TELCO)</b>										
<b>ACE</b>										
	0.7 D	05.05→	12-16			0 986 <b>AB8 112</b>		→	15,88	
						0 986 <b>AB8 113</b>		←	15,88	
<b>TOFAS</b>										
<b>Sahin [131]</b>										
	1.4	06.97→	61			F 026 <b>002 080</b>		↔	22,2	
<b>TOYOTA</b>										
<b>Auris [E15]</b>										
	2.0 D-4D	09.06→	93							0 204 <b>104 359</b> <sup>8</sup>
	2.0 D-4D	09.06→	93							0 204 <b>104 359</b> <sup>8</sup>
	2.0 D-4D	09.06→	93			1 987 <b>482 438</b>		→	1920	
						1 987 <b>482 439</b>		←	1665	
						TW	1 987 <b>482 273</b>		336	
	2.0 D-4D	09.06→	93			DRK	0 265 <b>007 802</b> <sup>4</sup>			
						LAB	0 265 <b>007 806</b> <sup>3</sup>			
						RAB	0 265 <b>007 805</b> <sup>3</sup>			



									
<b>Auris [E15, JTN]</b>									
									
	<b>1.3</b> VWT-i	09.08-10.09	74				0 986 <b>134 347</b>	 ← 60	F 026 <b>A06 625</b> <sup>7</sup>
							0 986 <b>135 347</b>	 → 60	F 026 <b>A06 625</b> <sup>7</sup>
	<b>1.4</b>	10.06-12.08	71				0 986 <b>134 347</b>	 ← 60	F 026 <b>A06 625</b> <sup>7</sup>
							0 986 <b>135 347</b>	 → 60	F 026 <b>A06 625</b> <sup>7</sup>
	<b>1.4</b> D-4D	10.06-08.12	66				0 204 <b>902 127</b>	←	0 204 <b>104 359</b> <sup>B</sup>
							0 204 <b>902 128</b>	→	0 204 <b>104 359</b> <sup>B</sup>
	<b>1.6</b>	10.06-08.12	91/97				0 986 <b>134 347</b>	 ← 60	F 026 <b>A06 625</b> <sup>7</sup>
							0 986 <b>135 347</b>	 → 60	F 026 <b>A06 625</b> <sup>7</sup>
	<b>1.8</b> i	12.08-10.09	108				0 986 <b>134 347</b>	 ← 60	F 026 <b>A06 625</b> <sup>7</sup>
							0 986 <b>135 347</b>	 → 60	F 026 <b>A06 625</b> <sup>7</sup>
	<b>2.0</b> D-4D	10.06-10.09	93						0 204 <b>104 359</b> <sup>B</sup>
									
	<b>1.3</b> VWT-i	09.08-10.09	74						0 204 <b>104 359</b> <sup>B</sup>
	<b>1.4</b> , D-4D	10.06-08.12	66/71						0 204 <b>104 359</b> <sup>B</sup>
	<b>1.6</b>	10.06-08.12	91/97						0 204 <b>104 359</b> <sup>B</sup>
	<b>1.8</b> i	12.08-10.09	108						0 204 <b>104 359</b> <sup>B</sup>
	<b>2.0</b> D-4D	10.06-10.09	93						0 204 <b>104 359</b> <sup>B</sup>
									
	<b>1.3</b> VWT-i	09.08-10.09	74				1 987 <b>482 273</b>	336	
	<b>1.4</b> , D-4D	10.06-10.09	66/71				1 987 <b>482 273</b>	336	
	<b>1.6</b>	10.06-10.09	91/97				1 987 <b>482 273</b>	336	
	<b>1.8</b> i	12.08-10.09	108				1 987 <b>482 273</b>	336	
	<b>2.0</b> D-4D	10.06-10.09	93				1 987 <b>482 273</b>	336	
	<b>1.4</b> D-4D	10.06-08.12	66			LAB	0 265 <b>007 947</b> <sup>3</sup>		
						RAB	0 265 <b>007 946</b> <sup>3</sup>		
	<b>2.0</b> D-4D	10.06-10.09	93			LAB	0 265 <b>007 947</b> <sup>3</sup>		
						RAB	0 265 <b>007 946</b> <sup>3</sup>		
<b>Auris [E15, NMT, SB1]</b>									
									
	<b>1.3</b> VWT-i	11.08-10.12	74				0 204 <b>902 127</b>	←	0 204 <b>104 359</b> <sup>B</sup>
							0 204 <b>902 128</b>	→	0 204 <b>104 359</b> <sup>B</sup>
	<b>1.4</b>	02.07-10.12	66/71				0 204 <b>902 127</b>	←	0 204 <b>104 359</b> <sup>B</sup>
	<b>1.4</b> D-4D						0 204 <b>902 128</b>	→	0 204 <b>104 359</b> <sup>B</sup>
	<b>1.6</b>	02.07-10.12	91/97				0 204 <b>902 127</b>	←	0 204 <b>104 359</b> <sup>B</sup>
							0 204 <b>902 128</b>	→	0 204 <b>104 359</b> <sup>B</sup>
	<b>1.8</b>	02.09-10.12	108				0 204 <b>902 127</b>	←	0 204 <b>104 359</b> <sup>B</sup>
							0 204 <b>902 128</b>	→	0 204 <b>104 359</b> <sup>B</sup>
	<b>1.8</b> VWT-i HSD	06.10-10.12	73						0 204 <b>104 359</b> <sup>B</sup>
	<b>2.0</b> D-4D	02.07-10.12	93						0 204 <b>104 359</b> <sup>B</sup>
<b>2.2</b> D-CAT	02.07-10.12	130						0 204 <b>104 359</b> <sup>B</sup>	
									
	<b>1.3</b> VWT-i	11.08-10.12	74						0 204 <b>104 359</b> <sup>B</sup>
	<b>1.4</b> , D-4D	02.07-10.12	66/71						0 204 <b>104 359</b> <sup>B</sup>
	<b>1.6</b>	02.07-10.12	91/97						0 204 <b>104 359</b> <sup>B</sup>
	<b>1.8</b> , VWT-i HSD	02.09-10.12	73/108						0 204 <b>104 359</b> <sup>B</sup>
	<b>2.0</b> D-4D	02.07-10.12	93						0 204 <b>104 359</b> <sup>B</sup>
	<b>2.2</b> D-CAT	02.07-10.12	130						0 204 <b>104 359</b> <sup>B</sup>
									
	<b>1.3</b> VWT-i	11.08-10.12	74				1 987 <b>482 438</b>	→ 1920	
							1 987 <b>482 439</b>	← 1665	



		S							
	◀ TOYOTA Auris [E15, NMT, SB1]								
	1.4	02.07-10.12	66/71				1987 482 438	→ 1920	
	1.4D-4D						1987 482 439	← 1665	
	1.6	02.07-10.12	91/97				1987 482 438	→ 1920	
							1987 482 439	← 1665	
	1.8	02.09-10.12	108				1987 482 438	→ 1920	
							1987 482 439	← 1665	
	2.0D-4D	02.07-10.12	93				1987 482 438	→ 1920	
							1987 482 439	← 1665	
	1.3 WT-i	11.08-10.12	74		LAB		0 265 007 806 <sup>3</sup>		
					RAB		0 265 007 805 <sup>3</sup>		
	1.4	02.07-10.12	66/71		LAB		0 265 007 806 <sup>3</sup>		
	1.4D-4D				RAB		0 265 007 805 <sup>3</sup>		
	1.6	02.07-10.12	91/97		LAB		0 265 007 806 <sup>3</sup>		
					RAB		0 265 007 805 <sup>3</sup>		
	1.8	02.09-10.12	108		LAB		0 265 007 806 <sup>3</sup>		
					RAB		0 265 007 805 <sup>3</sup>		
	2.0D-4D	02.07-10.12	93		LAB		0 265 007 806 <sup>3</sup>		
					RAB		0 265 007 805 <sup>3</sup>		
	2.2D-CAT	02.07-10.12	130		LAB		0 265 007 806 <sup>3</sup>		
					RAB		0 265 007 805 <sup>3</sup>		
<b>Auris [E18]</b>									
	2.0D-D4	10.12→	93				0986 134 334	← 57	0 204 104 359 <sup>8</sup>
							0986 135 334	→ 57	0 204 104 359 <sup>8</sup>
	1.3 WT-i	10.12→	74				0986 134 054	← 36	0 204 104 359 <sup>8</sup>
							0986 135 054	→ 36	0 204 104 359 <sup>8</sup>
	1.4D-4D	10.12→	66				0986 134 054	← 36	0 204 104 359 <sup>8</sup>
							0986 135 054	→ 36	0 204 104 359 <sup>8</sup>
	1.3 WT-i	10.12→	74				1987 482 438	→ 1920	
							1987 482 439	← 1665	
	1.4D-4D	10.12→	66				1987 482 438	→ 1920	
							1987 482 439	← 1665	
	1.3 WT-i	10.12→	74		LAB		0 265 007 806 <sup>3</sup>		
					RAB		0 265 007 805 <sup>3</sup>		
	1.4D-4D	10.12→	66		LAB		0 265 007 806 <sup>3</sup>		
					RAB		0 265 007 805 <sup>3</sup>		
	1.6	10.12→	97		LAB		0 265 007 806 <sup>3</sup>		
					RAB		0 265 007 805 <sup>3</sup>		
	1.8 WT-IHSD	10.12→	73		LAB		0 265 007 806 <sup>3</sup>		
					RAB		0 265 007 805 <sup>3</sup>		
	2.0D-D4	10.12→	93		LAB		0 265 007 806 <sup>3</sup>		
					RAB		0 265 007 805 <sup>3</sup>		
<b>Auris Touring Sports [E18]</b>									
	2.0D-4D	07.13→	91				0986 134 334	← 57	0 204 104 359 <sup>8</sup>
							0986 135 334	→ 57	0 204 104 359 <sup>8</sup>
	1.3	07.13→	73				0986 134 054	← 36	0 204 104 359 <sup>8</sup>
							0986 135 054	→ 36	0 204 104 359 <sup>8</sup>

	1.4D-4D	07.13→	66				0 986 134 054	36	0 204 104 359 <sup>B</sup>
							0 986 135 054	36	0 204 104 359 <sup>B</sup>
	1.3	07.13→	73				1 987 482 438	→ 1920	
							1 987 482 439	← 1665	
	1.4D-4D	07.13→	66				1 987 482 438	→ 1920	
							1 987 482 439	← 1665	
	1.3	07.13→	73			LAB	0 265 007 806 <sup>3</sup>		
						RAB	0 265 007 805 <sup>3</sup>		
	1.4D-4D	07.13→	66			LAB	0 265 007 806 <sup>3</sup>		
						RAB	0 265 007 805 <sup>3</sup>		
	1.6	07.13→	97			LAB	0 265 007 806 <sup>3</sup>		
						RAB	0 265 007 805 <sup>3</sup>		
	1.8 Vt-i HSD	07.13→	73			LAB	0 265 007 806 <sup>3</sup>		
						RAB	0 265 007 805 <sup>3</sup>		
	2.0D-4D	07.13→	91			LAB	0 265 007 806 <sup>3</sup>		
						RAB	0 265 007 805 <sup>3</sup>		
<b>Avanza</b>									
	1.3i	04.04→	67				0 986 AB8 084	→ 20,64	
	1.5i	10.06→	80				0 986 AB8 084	→ 20,64	
<b>Avensis Liftback [T22]</b>									
	1.6i 16V	10.97-01.03	74/81				0 986 473 116	56,93	
							0 986 474 116	56,93	
		01.00-07.00	74/81		4SB		0 986 473 217	40	
							0 986 474 217	40	
	1.8i 16V	10.97-07.00	81				0 986 473 116	56,93	
							0 986 474 116	56,93	
		01.00-07.00	81		4SB		0 986 473 217	40	
							0 986 474 217	40	
		07.00-01.03	95				0 986 473 116	56,93	
							0 986 474 116	56,93	
	2.0D Turbo	10.97-07.00	66				0 986 473 116	56,93	
							0 986 474 116	56,93	
		01.00-07.00	66		4SB		0 986 473 217	40	
							0 986 474 217	40	
		01.00-01.03	85		4SB		0 986 473 217	40	
							0 986 474 217	40	
	2.0i 16V	10.97-01.03	94				0 986 473 116	56,93	
							0 986 474 116	56,93	
		01.00-01.03	94		4SB		0 986 473 217	40	
							0 986 474 217	40	
		07.00-01.03	110		4SB		0 986 473 217	40	
							0 986 474 217	40	
	1.6i 16V	10.97-01.03	74/81				0 986 475 883	← 20,64	
							0 986 475 884	→ 20,64	
	1.8i 16V	10.97-01.03	81/95				0 986 475 883	← 20,64	
							0 986 475 884	→ 20,64	
	2.0D Turbo	10.97-01.03	66/85/94/				0 986 475 883	← 20,64	
	2.0i 16V		110				0 986 475 884	→ 20,64	





◀ TOYOTA Avensis Liftback [T22]

	1.6 i 16V	10.97-07.00	74		0 986 473 216		← 38	
					0 986 474 216		→ 38	
		10.97-06.01	81		0 986 473 216		← 38	
					0 986 474 216		→ 38	
		07.01-01.03	81		0 986 473 993		← 38	
					0 986 474 993		→ 38	
	1.8 i 16V	10.97-07.00	81		0 986 473 216		← 38	
		07.00-06.01	95		0 986 473 216		← 38	
				0 986 474 216		→ 38		
	07.01-01.03	95		0 986 473 993		← 38		
				0 986 474 993		→ 38		
	2.0 D Turbo	10.97-07.00	66		0 986 473 216		← 38	
					0 986 474 216		→ 38	
	2.0 D Turbo	10.97-06.01	85/94/110		0 986 473 216		← 38	
	2.0 i 16V				0 986 474 216		→ 38	
		07.01-01.03	85/94/110		0 986 473 993		← 38	
					0 986 474 993		→ 38	



	1.6 i 16V	10.97-07.00	74		1 987 477 539		330		
					SBR	1 987 477 541		→ 1760	
						1 987 477 546		← 1805	
					TBR	1 987 477 540		→ 1789	
						1 987 477 545		← 1829	
		10.97-07.01	81		SBR	1 987 477 541		→ 1760	
						1 987 477 546		← 1805	
		10.97-01.03	81			1 987 477 539		330	
					TBR	1 987 477 540		→ 1789	
						1 987 477 545		← 1829	
		08.01-01.03	81		SBR	1 987 482 158		← 1868	
						1 987 482 159		→ 1824	
	1.8 i 16V	10.97-07.00	81			1 987 477 539		330	
					SBR	1 987 477 541		→ 1760	
						1 987 477 546		← 1805	
					TBR	1 987 477 540		→ 1789	
						1 987 477 545		← 1829	
		07.00-07.01	95		SBR	1 987 477 541		→ 1760	
						1 987 477 546		← 1805	
		07.00-01.03	95			1 987 477 539		330	
					TBR	1 987 477 540		→ 1789	
						1 987 477 545		← 1829	
		08.01-01.03	95		SBR	1 987 482 158		← 1868	
						1 987 482 159		→ 1824	
2.0 D Turbo	10.97-07.00	66			1 987 477 539		330		
				SBR	1 987 477 541		→ 1760		
					1 987 477 546		← 1805		
				TBR	1 987 477 540		→ 1789		
					1 987 477 545		← 1829		
2.0 D Turbo	10.97-07.01	85/94/110		SBR	1 987 477 541		→ 1760		
2.0 i 16V					1 987 477 546		← 1805		
	10.97-01.03	85/94/110			1 987 477 539		330		
				TBR	1 987 477 540		→ 1789		
					1 987 477 545		← 1829		
	08.01-01.03	85/94/110		SBR	1 987 482 158		← 1868		
					1 987 482 159		→ 1824		

	1.6 i 16V	10.97-01.03	74/81		LAB	0 265 006 665 <sup>3</sup>		
						0 265 006 667 <sup>4</sup>		
					RAB	0 265 006 666 <sup>3</sup>		
						0 265 006 668 <sup>4</sup>		

		S									
1.8i 16V		10.97-01.03	81/95	LAB			0 265 006 665 <sup>3</sup>				
										RAB	0 265 006 667 <sup>4</sup>
											0 265 006 666 <sup>3</sup>
											0 265 006 668 <sup>4</sup>
2.0D Turbo 2.0i 16V		10.97-01.03	66/85/94/ 110	LAB			0 265 006 665 <sup>3</sup>				
										RAB	0 265 006 667 <sup>4</sup>
											0 265 006 666 <sup>3</sup>
											0 265 006 668 <sup>4</sup>
<b>Avensis Liftback [T25]</b>											
	1.6i 16V	01.03-11.08	81				0 986 473 218	← 53	0 204 104 308 <sup>B</sup>		
							0 986 474 218	→ 53	0 204 104 308 <sup>B</sup>		
	1.8i 16V	01.03-11.08	95				0 986 473 218	← 53	0 204 104 308 <sup>B</sup>		
							0 986 474 218	→ 53	0 204 104 308 <sup>B</sup>		
	2.0D Turbo	03.03-04.06	85						0 204 104 308 <sup>B</sup>		
							0 986 473 218	← 53	0 204 104 308 <sup>B</sup>		
							0 986 474 218	→ 53	0 204 104 308 <sup>B</sup>		
							0 986 473 218	← 53	0 204 104 308 <sup>B</sup>		
	2.0D-4D 2.0i 16V	01.03-11.08	93/108/ 114				0 986 473 218	← 53	0 204 104 308 <sup>B</sup>		
							0 986 474 218	→ 53	0 204 104 308 <sup>B</sup>		
	2.2D-CAT 2.2D-4D	04.05-11.08	110/130				0 986 473 218	← 53	0 204 104 308 <sup>B</sup>		
							0 986 474 218	→ 53	0 204 104 308 <sup>B</sup>		
	2.4i	09.03-11.08	120				0 986 473 218	← 53	0 204 104 308 <sup>B</sup>		
							0 986 474 218	→ 53	0 204 104 308 <sup>B</sup>		
	1.6i 16V	01.03-11.08	81				0 986 473 201	← 38	0 204 104 309 <sup>B</sup>		
							0 986 474 201	→ 38	0 204 104 309 <sup>B</sup>		
	1.8i 16V	01.03-11.08	95				0 986 473 201	← 38	0 204 104 309 <sup>B</sup>		
							0 986 474 201	→ 38	0 204 104 309 <sup>B</sup>		
	2.0D Turbo, D-4D, i 16V	01.03-11.08	85/93/108/ 114				0 986 473 201	← 38	0 204 104 309 <sup>B</sup>		
							0 986 474 201	→ 38	0 204 104 309 <sup>B</sup>		
							0 986 473 201	← 38	0 204 104 309 <sup>B</sup>		
							0 986 474 201	→ 38	0 204 104 309 <sup>B</sup>		
	2.2D-CAT 2.2D-4D	04.05-11.08	110/130				0 986 473 201	← 38	0 204 104 309 <sup>B</sup>		
							0 986 474 201	→ 38	0 204 104 309 <sup>B</sup>		
	2.4i	09.03-11.08	120				0 986 473 201	← 38	0 204 104 309 <sup>B</sup>		
							0 986 474 201	→ 38	0 204 104 309 <sup>B</sup>		
	1.6i 16V	01.03-11.08	81				1 987 477 985	398			
							1 987 482 297	→ 1823			
	1.8i 16V	01.03-11.08	95				1 987 482 300	← 1770			
							1 987 477 985	398			
	2.0D Turbo 2.0D-4D 2.0i 16V	01.03-11.08	85/93/108/ 114				1 987 477 985	398			
							1 987 482 297	→ 1823			
							1 987 482 300	← 1770			
							1 987 477 985	398			
	2.2D-CAT 2.2D-4D	04.05-11.08	110/130				1 987 477 985	398			
							1 987 482 297	→ 1823			
	2.4i	09.03-11.08	120				1 987 477 985	398			
							1 987 482 297	→ 1823			
							1 987 482 300	← 1770			
							1 987 477 985	398			
	1.6i 16V	01.03-11.08	81			LAB	0 265 006 676 <sup>3</sup>				
							RAB	0 265 006 677 <sup>3</sup>			
	1.8i 16V	01.03-11.08	95				LAB	0 265 006 676 <sup>3</sup>			
							RAB	0 265 006 677 <sup>3</sup>			
2.0D Turbo, D-4D, i 16V	01.03-11.08	85/93/108/ 114				LAB	0 265 006 676 <sup>3</sup>				
						RAB	0 265 006 677 <sup>3</sup>				







	◀ TOYOTA Avensis Liftback [T25]							
	2.2 D-CAT	04.05-11.08	110/130		LAB	0 265 006 676 <sup>3</sup>		
	2.2 D-4D				RAB	0 265 006 677 <sup>3</sup>		
	2.4 i	09.03-11.08	120		LAB	0 265 006 676 <sup>3</sup>		
					RAB	0 265 006 677 <sup>3</sup>		

**Avensis [T22]**

	1.6 i 16V	10.97-01.03	74/81			0 986 473 116		← 56,93
						0 986 474 116		→ 56,93
		01.00-07.00	74/81		4SB	0 986 473 217		← 40
						0 986 474 217		→ 40
	1.8 i 16V	10.97-07.00	81			0 986 473 116		← 56,93
						0 986 474 116		→ 56,93
		01.00-07.00	81		4SB	0 986 473 217		← 40
						0 986 474 217		→ 40
		07.00-01.03	95			0 986 473 116		← 56,93
						0 986 474 116		→ 56,93
	2.0 D Turbo	10.97-07.00	66			0 986 473 116		← 56,93
						0 986 474 116		→ 56,93
		01.00-07.00	66		4SB	0 986 473 217		← 40
						0 986 474 217		→ 40
		01.00-01.03	85		4SB	0 986 473 217		← 40
						0 986 474 217		→ 40
	2.0 i 16V	10.97-01.03	94			0 986 473 116		← 56,93
						0 986 474 116		→ 56,93
		01.00-01.03	94		4SB	0 986 473 217		← 40
						0 986 474 217		→ 40
		07.00-01.03	110		4SB	0 986 473 217		← 40
						0 986 474 217		→ 40

	1.6 i 16V	10.97-01.03	74/81			0 986 475 883		← 20,64
						0 986 475 884		→ 20,64
	1.8 i 16V	10.97-01.03	81/95			0 986 475 883		← 20,64
						0 986 475 884		→ 20,64
	2.0 D Turbo	10.97-01.03	66/85/94/			0 986 475 883		← 20,64
	2.0 i 16V		110			0 986 475 884		→ 20,64

	1.6 i 16V	10.97-07.00	74			0 986 473 216		← 38
						0 986 474 216		→ 38
		10.97-06.01	81			0 986 473 216		← 38
						0 986 474 216		→ 38
		07.01-01.03	81			0 986 473 993		← 38
						0 986 474 993		→ 38
	1.8 i 16V	10.97-07.00	81			0 986 473 216		← 38
						0 986 474 216		→ 38
		07.00-06.01	95			0 986 473 216		← 38
						0 986 474 216		→ 38
		07.01-01.03	95			0 986 473 993		← 38
						0 986 474 993		→ 38
	2.0 D Turbo	10.97-07.00	66			0 986 473 216		← 38
						0 986 474 216		→ 38
	2.0 D Turbo	10.97-06.01	85/94/110			0 986 473 216		← 38
	2.0 i 16V					0 986 474 216		→ 38
		07.01-01.03	85/94/110			0 986 473 993		← 38
						0 986 474 993		→ 38

	1.6 i 16V	10.97-07.00	74			1 987 477 539		330
					SBR	1 987 477 541		→ 1760
						1 987 477 546		← 1805

		S									
1.6i 16V		10.97-07.00	74		TBR			1 987 477 540	→	1789	
								1 987 477 545	←	1829	
		10.97-07.01	81		SBR			1 987 477 541	→	1760	
								1 987 477 546	←	1805	
		10.97-01.03	81			TBR		1 987 477 539		330	
								1 987 477 540	→	1789	
			08.01-01.03	81		SBR		1 987 482 158	←	1868	
								1 987 482 159	→	1824	
1.8i 16V		10.97-07.00	81		SBR			1 987 477 539		330	
								1 987 477 541	→	1760	
						TBR		1 987 477 546	←	1805	
								1 987 477 540	→	1789	
						TBR		1 987 477 545	←	1829	
								1 987 477 541	→	1760	
		07.00-07.01	95			SBR		1 987 477 546	←	1805	
								1 987 477 539		330	
		07.00-01.03	95		TBR		1 987 477 540	→	1789		
							1 987 477 545	←	1829		
		08.01-01.03	95		SBR		1 987 482 158	←	1868		
							1 987 482 159	→	1824		
2.0D Turbo		10.97-07.00	66					1 987 477 539		330	
								1 987 477 541	→	1760	
						SBR		1 987 477 546	←	1805	
								1 987 477 540	→	1789	
					TBR		1 987 477 545	←	1829		
							1 987 477 541	→	1760		
2.0D Turbo 2.0i 16V		10.97-07.01	85/94/110		SBR			1 987 477 541	→	1760	
								1 987 477 546	←	1805	
		10.97-01.03	85/94/110			TBR		1 987 477 539		330	
								1 987 477 540	→	1789	
						TBR		1 987 477 545	←	1829	
								1 987 477 541	→	1760	
		08.01-01.03	85/94/110			SBR		1 987 482 158	←	1868	
								1 987 482 159	→	1824	
	1.6i 16V	10.97-01.03	74/81		LAB			0 265 006 665 <sup>3</sup>			
								0 265 006 667 <sup>4</sup>			
						RAB			0 265 006 666 <sup>3</sup>		
									0 265 006 668 <sup>4</sup>		
	1.8i 16V	10.97-01.03	81/95			LAB			0 265 006 665 <sup>3</sup>		
									0 265 006 667 <sup>4</sup>		
						RAB			0 265 006 666 <sup>3</sup>		
									0 265 006 668 <sup>4</sup>		
2.0D Turbo 2.0i 16V	10.97-01.03	66/85/94/ 110			LAB			0 265 006 665 <sup>3</sup>			
								0 265 006 667 <sup>4</sup>			
					RAB			0 265 006 666 <sup>3</sup>			
								0 265 006 668 <sup>4</sup>			

**Avensis [T25]**

	1.6i 16V	01.03-11.08	81					0 986 473 218	☺ ←	53	0 204 104 308 <sup>B</sup>
								0 986 474 218	☺ →	53	0 204 104 308 <sup>B</sup>
	1.8i 16V	01.03-11.08	95					0 986 473 218	☺ ←	53	0 204 104 308 <sup>B</sup>
								0 986 474 218	☺ →	53	0 204 104 308 <sup>B</sup>
	2.0D Turbo	03.03-04.06	85								0 204 104 308 <sup>B</sup>
								0 986 473 218	☺ ←	53	0 204 104 308 <sup>B</sup>
								0 986 474 218	☺ →	53	0 204 104 308 <sup>B</sup>
								0 986 473 218	☺ ←	53	0 204 104 308 <sup>B</sup>
2.0D-4D 2.0i 16V	01.03-11.08	93/108/ 114						0 986 473 218	☺ ←	53	0 204 104 308 <sup>B</sup>
								0 986 474 218	☺ →	53	0 204 104 308 <sup>B</sup>
2.2D-CAT 2.2D-4D	04.05-11.08	110/130						0 986 473 218	☺ ←	53	0 204 104 308 <sup>B</sup>
								0 986 474 218	☺ →	53	0 204 104 308 <sup>B</sup>
2.4i	09.03-11.08	120						0 986 473 218	☺ ←	53	0 204 104 308 <sup>B</sup>
								0 986 474 218	☺ →	53	0 204 104 308 <sup>B</sup>





◀ TOYOTA Avensis [T25]



	1.6 i 16V	01.03-11.08	81		0 986 473 201		← 38	0 204 104 309 <sup>8</sup>
					0 986 474 201		→ 38	0 204 104 309 <sup>8</sup>
	1.8 i 16V	01.03-11.08	95		0 986 473 201		← 38	0 204 104 309 <sup>8</sup>
					0 986 474 201		→ 38	0 204 104 309 <sup>8</sup>
	2.0 D Turbo, D-4D, i 16V	01.03-11.08	85/93/108		0 986 473 201		← 38	0 204 104 309 <sup>8</sup>
					0 986 474 201		→ 38	0 204 104 309 <sup>8</sup>
	2.0 i 16V	01.03-11.08	114		0 986 473 201		← 38	0 204 104 309 <sup>8</sup>
					0 986 474 201		→ 38	0 204 104 309 <sup>8</sup>
	2.0 i 16V 4WD	10.03-11.08	114		0 986 473 201		← 38	
					0 986 474 201		→ 38	
	2.2 D-CAT	04.05-11.08	110/130		0 986 473 201		← 38	0 204 104 309 <sup>8</sup>
	2.2 D-4D				0 986 474 201		→ 38	0 204 104 309 <sup>8</sup>
	2.4 i	09.03-11.08	120		0 986 473 201		← 38	0 204 104 309 <sup>8</sup>
					0 986 474 201		→ 38	0 204 104 309 <sup>8</sup>



	1.6 i 16V	01.03-11.08	81		1 987 477 985		398	
					1 987 482 297		→ 1823	
					1 987 482 300		← 1770	
	1.8 i 16V	01.03-11.08	95		1 987 477 985		398	
					1 987 482 297		→ 1823	
					1 987 482 300		← 1770	
	2.0 D Turbo	01.03-11.08	85/93/108/		1 987 477 985		398	
	2.0 D-4D		114		1 987 482 297		→ 1823	
	2.0 i 16V				1 987 482 300		← 1770	
	2.2 D-CAT	04.05-11.08	110/130		1 987 477 985		398	
	2.2 D-4D				1 987 482 297		→ 1823	
					1 987 482 300		← 1770	
	2.4 i	09.03-11.08	120		1 987 477 985		398	
					1 987 482 297		→ 1823	
					1 987 482 300		← 1770	

	1.6 i 16V	01.03-11.08	81	LAB	0 265 006 676 <sup>3</sup>			
				RAB	0 265 006 677 <sup>3</sup>			
	1.8 i 16V	01.03-11.08	95	LAB	0 265 006 676 <sup>3</sup>			
				RAB	0 265 006 677 <sup>3</sup>			
	2.0 D Turbo, D-4D, i 16V	01.03-11.08	85/93/108/	LAB	0 265 006 676 <sup>3</sup>			
			114	RAB	0 265 006 677 <sup>3</sup>			
	2.2 D-CAT	04.05-11.08	110/130	LAB	0 265 006 676 <sup>3</sup>			
	2.2 D-4D			RAB	0 265 006 677 <sup>3</sup>			
	2.4 i	09.03-11.08	120	LAB	0 265 006 676 <sup>3</sup>			
				RAB	0 265 006 677 <sup>3</sup>			

Avensis [T27]



	1.6	11.08→	97		0 986 134 334		← 57	0 204 104 359 <sup>8</sup>
					0 986 135 334		→ 57	0 204 104 359 <sup>8</sup>
	1.8	11.08→	108		0 986 134 334		← 57	0 204 104 359 <sup>8</sup>
					0 986 135 334		→ 57	0 204 104 359 <sup>8</sup>
	2.0	11.08→	93/102/		0 986 134 334		← 57	0 204 104 359 <sup>8</sup>
	2.0 D-4D		112		0 986 135 334		→ 57	0 204 104 359 <sup>8</sup>
	2.2 D-CAT, D-4D	11.08→	110-130					0 204 104 359 <sup>8</sup>



	1.6	11.08→	97					0 204 104 359 <sup>8</sup>
	1.8	11.08→	108					0 204 104 359 <sup>8</sup>
	2.0, D-4D	11.08→	93/102/112					0 204 104 359 <sup>8</sup>
	2.2 D-CAT, D-4D	11.08→	110-130					0 204 104 359 <sup>8</sup>



	<b>1.6</b>	11.08→	97	LAB	0 265 007 806 <sup>3</sup>	
				RAB	0 265 007 805 <sup>3</sup>	
	<b>1.8</b>	11.08→	108	LAB	0 265 007 806 <sup>3</sup>	
				RAB	0 265 007 805 <sup>3</sup>	
	<b>2.0</b>	11.08→	93/102/	LAB	0 265 007 806 <sup>3</sup>	
	<b>2.0 D-4D</b>		112	RAB	0 265 007 805 <sup>3</sup>	
<b>2.2 D-CAT</b>	11.08→	110-130	LAB	0 265 007 806 <sup>3</sup>		
<b>2.2 D-4D</b>			RAB	0 265 007 805 <sup>3</sup>		

**Avensis Verso [M2]**

	<b>2.0 D Turbo, i 16V</b>	05.01→	85/110		1 987 482 157	319
	<b>2.4 i 16V</b>	10.03→	115		1 987 482 157	319

**Avensis Wagon [T22]**

	<b>1.6 i 16V</b>	10.97-01.03	74/81		0 986 473 116	← 56,93
					0 986 474 116	→ 56,93
		01.00-07.00	74/81	4SB	0 986 473 217	← 40
					0 986 474 217	→ 40
	<b>1.8 i 16V</b>	10.97-07.00	81		0 986 473 116	← 56,93
					0 986 474 116	→ 56,93
		01.00-07.00	81	4SB	0 986 473 217	← 40
					0 986 474 217	→ 40
		07.00-06.01	95	4SB	0 986 473 217	← 40
					0 986 474 217	→ 40
		07.00-01.03	95	HTB	0 986 473 116	← 56,93
					0 986 474 116	→ 56,93
	<b>2.0 D Turbo</b>	10.97-07.00	66		0 986 473 116	← 56,93
					0 986 474 116	→ 56,93
		01.00-07.00	66	4SB	0 986 473 217	← 40
					0 986 474 217	→ 40
		01.00-01.03	85	4SB	0 986 473 217	← 40
					0 986 474 217	→ 40
	<b>2.0 i 16V</b>	10.97-01.03	94		0 986 473 116	← 56,93
					0 986 474 116	→ 56,93
		01.00-01.03	94	4SB	0 986 473 217	← 40
					0 986 474 217	→ 40
		07.00-01.03	110	4SB	0 986 473 217	← 40
					0 986 474 217	→ 40

	<b>1.6 i 16V</b>	10.97-01.03	74/81		0 986 475 883	← 20,64
					0 986 475 884	→ 20,64
	<b>1.8 i 16V</b>	10.97-01.03	81/95		0 986 475 883	← 20,64
					0 986 475 884	→ 20,64
	<b>2.0 D Turbo</b>	10.97-01.03	66/85/94/		0 986 475 883	← 20,64
	<b>2.0 i 16V</b>		110		0 986 475 884	→ 20,64

	<b>1.6 i 16V</b>	10.97-07.00	74		0 986 473 216	← 38
					0 986 474 216	→ 38
		10.97-06.01	81		0 986 473 216	← 38
					0 986 474 216	→ 38
		07.01-01.03	81		0 986 473 993	← 38
					0 986 474 993	→ 38
	<b>1.8 i 16V</b>	10.97-07.00	81		0 986 473 216	← 38
					0 986 474 216	→ 38



			<b>S</b>							
	<b>TOYOTA</b> Avensis Wagon [T22]									
<b>1.8 i 16V</b>	07.00-06.01	95						0986 <b>473 216</b>		← 38
								0986 <b>474 216</b>		→ 38
	07.01-01.03	95						0986 <b>473 993</b>		← 38
								0986 <b>474 993</b>		→ 38
<b>2.0 D Turbo</b>	10.97-07.00	66						0986 <b>473 216</b>		← 38
								0986 <b>474 216</b>		→ 38
<b>2.0 D Turbo</b>	10.97-06.01	85/94/110						0986 <b>473 216</b>		← 38
								0986 <b>474 216</b>		→ 38
<b>2.0 i 16V</b>	07.01-01.03	85/94/110						0986 <b>473 993</b>		← 38
								0986 <b>474 993</b>		→ 38
	<b>1.6 i 16V</b>									
	10.97-07.00	74						1987 <b>477 539</b>		330
							SBR	1987 <b>477 541</b>		→ 1760
								1987 <b>477 546</b>		← 1805
							TBR	1987 <b>477 540</b>		→ 1789
								1987 <b>477 545</b>		← 1829
	10.97-07.01	81					SBR	1987 <b>477 541</b>		→ 1760
								1987 <b>477 546</b>		← 1805
	10.97-01.03	81						1987 <b>477 539</b>		330
							TBR	1987 <b>477 540</b>		→ 1789
								1987 <b>477 545</b>		← 1829
	08.01-01.03	81					SBR	1987 <b>482 158</b>		← 1868
								1987 <b>482 159</b>		→ 1824
<b>1.8 i 16V</b>	10.97-07.00	81						1987 <b>477 539</b>		330
							SBR	1987 <b>477 541</b>		→ 1760
								1987 <b>477 546</b>		← 1805
							TBR	1987 <b>477 540</b>		→ 1789
								1987 <b>477 545</b>		← 1829
	07.00-07.01	95					SBR	1987 <b>477 541</b>		→ 1760
								1987 <b>477 546</b>		← 1805
	07.00-01.03	95						1987 <b>477 539</b>		330
							TBR	1987 <b>477 540</b>		→ 1789
								1987 <b>477 545</b>		← 1829
	08.01-01.03	95					SBR	1987 <b>482 158</b>		← 1868
								1987 <b>482 159</b>		→ 1824
<b>2.0 D Turbo</b>	10.97-07.00	66						1987 <b>477 539</b>		330
							SBR	1987 <b>477 541</b>		→ 1760
								1987 <b>477 546</b>		← 1805
							TBR	1987 <b>477 540</b>		→ 1789
								1987 <b>477 545</b>		← 1829
<b>2.0 D Turbo</b>	10.97-07.01	85/94/110					SBR	1987 <b>477 541</b>		→ 1760
								1987 <b>477 546</b>		← 1805
<b>2.0 i 16V</b>	10.97-01.03	85/94/110						1987 <b>477 539</b>		330
							TBR	1987 <b>477 540</b>		→ 1789
								1987 <b>477 545</b>		← 1829
	08.01-01.03	85/94/110					SBR	1987 <b>482 158</b>		← 1868
								1987 <b>482 159</b>		→ 1824
	<b>1.6 i 16V</b>									
	10.97-01.03	74/81					LAB	0 265 <b>006 665</b> <sup>3</sup>		
								0 265 <b>006 667</b> <sup>4</sup>		
							RAB	0 265 <b>006 666</b> <sup>3</sup>		
								0 265 <b>006 668</b> <sup>4</sup>		
<b>1.8 i 16V</b>	10.97-01.03	81/95					LAB	0 265 <b>006 665</b> <sup>3</sup>		
								0 265 <b>006 667</b> <sup>4</sup>		
							RAB	0 265 <b>006 666</b> <sup>3</sup>		
								0 265 <b>006 668</b> <sup>4</sup>		
<b>2.0 D Turbo</b>	10.97-01.03	66/85/94/110					LAB	0 265 <b>006 665</b> <sup>3</sup>		
								0 265 <b>006 667</b> <sup>4</sup>		
<b>2.0 i 16V</b>							RAB	0 265 <b>006 666</b> <sup>3</sup>		
								0 265 <b>006 668</b> <sup>4</sup>		

		S								
<b>Avensis Wagon [T25]</b>										
	1.6i 16V	01.03-11.08	81				0 986 473 218		53 ←	0 204 104 308 <sup>B</sup>
							0 986 474 218		53 →	0 204 104 308 <sup>B</sup>
	1.8i 16V	01.03-11.08	95				0 986 473 218		53 ←	0 204 104 308 <sup>B</sup>
							0 986 474 218		53 →	0 204 104 308 <sup>B</sup>
	2.0D Turbo	03.03-04.06	85							0 204 104 308 <sup>B</sup>
							0 986 473 218		53 ←	0 204 104 308 <sup>B</sup>
							0 986 474 218		53 →	0 204 104 308 <sup>B</sup>
	2.0D-4D	01.03-11.08	93/108/				0 986 473 218		53 ←	0 204 104 308 <sup>B</sup>
	2.0i 16V		114				0 986 474 218		53 →	0 204 104 308 <sup>B</sup>
	2.2D-CAT	04.05-11.08	110/130				0 986 473 218		53 ←	0 204 104 308 <sup>B</sup>
2.2D-4D						0 986 474 218		53 →	0 204 104 308 <sup>B</sup>	
2.4i	09.03-11.08	120				0 986 473 218		53 ←	0 204 104 308 <sup>B</sup>	
						0 986 474 218		53 →	0 204 104 308 <sup>B</sup>	
	1.6i 16V	01.03-11.08	81				0 986 473 201		38 ←	0 204 104 309 <sup>B</sup>
							0 986 474 201		38 →	0 204 104 309 <sup>B</sup>
	1.8i 16V	01.03-11.08	95				0 986 473 201		38 ←	0 204 104 309 <sup>B</sup>
							0 986 474 201		38 →	0 204 104 309 <sup>B</sup>
	2.0D Turbo, D-4D, i 16V	01.03-11.08	85/93/108/				0 986 473 201		38 ←	0 204 104 309 <sup>B</sup>
			114				0 986 474 201		38 →	0 204 104 309 <sup>B</sup>
	2.2D-CAT	04.05-11.08	110/130				0 986 473 201		38 ←	0 204 104 309 <sup>B</sup>
	2.2D-4D						0 986 474 201		38 →	0 204 104 309 <sup>B</sup>
	2.4i	09.03-11.08	120				0 986 473 201		38 ←	0 204 104 309 <sup>B</sup>
							0 986 474 201		38 →	0 204 104 309 <sup>B</sup>
	1.6i 16V	01.03-11.08	81				1 987 477 985		398	
							1 987 482 297		→ 1823	
							1 987 482 300		← 1770	
	1.8i 16V	01.03-11.08	95				1 987 477 985		398	
							1 987 482 297		→ 1823	
							1 987 482 300		← 1770	
	2.0D Turbo	01.03-11.08	85/93/108/				1 987 477 985		398	
	2.0D-4D		114				1 987 482 297		→ 1823	
	2.0i 16V						1 987 482 300		← 1770	
	2.2D-CAT	04.05-11.08	110/130				1 987 477 985		398	
	2.2D-4D						1 987 482 297		→ 1823	
							1 987 482 300		← 1770	
	2.4i	09.03-11.08	120				1 987 477 985		398	
							1 987 482 297		→ 1823	
							1 987 482 300		← 1770	
	1.6i 16V	01.03-11.08	81			LAB	0 265 006 676 <sup>3</sup>			
						RAB	0 265 006 677 <sup>3</sup>			
	1.8i 16V	01.03-11.08	95			LAB	0 265 006 676 <sup>3</sup>			
						RAB	0 265 006 677 <sup>3</sup>			
	2.0D Turbo, D-4D, i 16V	01.03-11.08	85/93/108/			LAB	0 265 006 676 <sup>3</sup>			
			114			RAB	0 265 006 677 <sup>3</sup>			
	2.2D-CAT	04.05-11.08	110/130			LAB	0 265 006 676 <sup>3</sup>			
	2.2D-4D					RAB	0 265 006 677 <sup>3</sup>			
	2.4i	09.03-11.08	120			LAB	0 265 006 676 <sup>3</sup>			
						RAB	0 265 006 677 <sup>3</sup>			



		S							
◀ TOYOTA									
<b>Avensis Wagon [T27]</b>									
	1.6	11.08→	97				0986 134 334	← 57	0 204 104 359 <sup>8</sup>
							0986 135 334	→ 57	0 204 104 359 <sup>8</sup>
	1.8	11.08→	108				0986 134 334	← 57	0 204 104 359 <sup>8</sup>
							0986 135 334	→ 57	0 204 104 359 <sup>8</sup>
	2.0	11.08→	93/102/				0986 134 334	← 57	0 204 104 359 <sup>8</sup>
	2.0 D-4D		112				0986 135 334	→ 57	0 204 104 359 <sup>8</sup>
	2.2 D-CAT, D-4D	11.08→	110-130						0 204 104 359 <sup>8</sup>
	1.6	11.08→	97						0 204 104 359 <sup>8</sup>
	1.8	11.08→	108						0 204 104 359 <sup>8</sup>
	2.0, D-4D	11.08→	93/102/112						0 204 104 359 <sup>8</sup>
	2.2 D-CAT, D-4D	11.08→	110-130						0 204 104 359 <sup>8</sup>
	1.6	11.08→	97		LAB		0 265 007 806 <sup>3</sup>		
					RAB		0 265 007 805 <sup>3</sup>		
	1.8	11.08→	108		LAB		0 265 007 806 <sup>3</sup>		
					RAB		0 265 007 805 <sup>3</sup>		
	2.0	11.08→	93/102/		LAB		0 265 007 806 <sup>3</sup>		
	2.0 D-4D		112		RAB		0 265 007 805 <sup>3</sup>		
	2.2 D-CAT	11.08→	110-130		LAB		0 265 007 806 <sup>3</sup>		
	2.2 D-4D				RAB		0 265 007 805 <sup>3</sup>		
<b>Aygo</b>									
	1.0	02.05→	50				0 204 004 330	← 48	
							0986 134 093		
							0 204 004 331	→ 48	
							0986 135 093		
	1.4	05.05-09.10	40				0 204 004 330	← 48	
							0986 134 093		
							0 204 004 331	→ 48	
							0986 135 093		
	1.0	02.05→	50				F 026 002 607	↔ 17,46	
	1.4	05.05-09.10	40				F 026 002 607	↔ 17,46	
	1.0	02.05→	50				1 987 477 951	→ 1478	
							1 987 477 952	← 1487	
	1.4	05.05-09.10	40				1 987 477 951	→ 1478	
							1 987 477 952	← 1487	
	1.0	02.05-01.12	50				0 265 007 687 <sup>3</sup>		
							0 265 007 688 <sup>4</sup>		
		02.12→	50				0 265 008 633 <sup>4</sup>		
	1.4	05.05-09.10	40				0 265 007 687 <sup>3</sup>		
							0 265 007 688 <sup>4</sup>		



		S								
<b>Aygo [B4]</b>										
	1.0	05.14→	51					0 204 004 330	← 48	
								0 986 134 093		
								0 204 004 331	→ 48	
								0 986 135 093		
	1.2	05.14→	60					0 204 004 330	← 48	
								0 986 134 093		
								0 204 004 331	→ 48	
								0 986 135 093		
	1.0	05.14→	51					0 265 008 633 <sup>4</sup>		
	1.2	05.14→	60					0 265 008 633 <sup>4</sup>		
<b>bB</b>										
	1.3i	01.06-06.10	68					0 986 475 881	← 17,46	
								0 986 475 882	→ 17,46	
	1.5i	01.06-06.10	80					0 986 475 881	← 17,46	
								0 986 475 882	→ 17,46	
<b>Camry</b>										
	2.2i	10.96-12.02	95					0 986 473 333	← 35	F 026 A03 445 <sup>7</sup>
								0 986 474 333	→ 35	F 026 A03 445 <sup>7</sup>
<b>Camry Sedan</b>										
	2.0i	11.92-10.97	92							F 026 A08 182 <sup>7</sup>
	2.4i	03.03-12.05	112							F 026 A08 196
	3.0i	07.97-02.03	138							F 026 A03 510
	3.0Si	11.92-08.97	138							F 026 A08 182 <sup>7</sup>
	2.0i	05.96-08.01	92					0 986 473 333	← 35	F 026 A03 445 <sup>7</sup>
								0 986 474 333	→ 35	F 026 A03 445 <sup>7</sup>
	2.2i	05.96-10.97	97					0 986 473 333	← 35	F 026 A03 445 <sup>7</sup>
								0 986 473 333	← 35	F 026 A03 445 <sup>7</sup>
								0 986 474 333	→ 35	F 026 A03 445 <sup>7</sup>
								0 986 474 333	→ 35	F 026 A03 445 <sup>7</sup>
	3.0i	07.97-02.03	138			TW		0 986 473 216	← 38	F 026 A03 445
								0 986 473 333	← 35	F 026 A03 445 <sup>7</sup>
								0 986 474 216	→ 38	F 026 A03 445
								0 986 474 333	→ 35	F 026 A03 445 <sup>7</sup>
	3.0Si	11.92-08.97	138							F 026 A03 445 <sup>7</sup>
<b>Camry [V1]</b>										
	2.2i, i 16V	06.91-04.98	93/100-103							F 026 A08 526 <sup>7</sup>
	3.0i 24V	09.93-08.96	138							F 026 A08 526 <sup>7</sup>
	2.2i 16V	08.93-08.96	100-103					0 986 473 216	← 38	
								0 986 474 216	→ 38	





		S							
	◀ TOYOTA Camry [V1]								
	3.0i24V	08.93-08.96	138				0986 473 216		← 38
							0986 474 216		→ 38
	2.2i16V	06.91-08.96	100-103				1987 477 797		← 1718
	3.0i24V	ABO 06.91-08.96	138				1987 477 797		← 1718
							1987 482 160		→ 1735
	<b>Camry [V2]</b>								
	2.2i16V	08.96-08.99	96/100				0986 473 216		← 38
							0986 474 216		→ 38
	3.0i24V	06.96-08.99	140/141				0986 473 216		← 38
							0986 474 216		→ 38
	<b>Camry [V3]</b>								
	2.0i16V	08.01-01.06	118						F 026 A03 538 <sup>7</sup>
	2.4i	08.01-01.06	113		TW				F 026 A03 538 <sup>7</sup>
	2.4i16V	08.01-01.06	112		15Z				F 026 A03 538 <sup>7</sup>
	<b>Camry Wagon [V1]</b>								
	2.2i16V	09.93-07.96	100-103						F 026 A08 526 <sup>7</sup>
	3.0i24V	08.93-08.96	138						F 026 A08 526 <sup>7</sup>
	2.2i16V	03.92-08.94	100-103		TW		0986 473 216		← 38
							0986 474 216		→ 38
	3.0i24V	08.93-08.96	138				0986 473 216		← 38
							0986 474 216		→ 38
	2.2i16V	03.92-07.96	100-103				1987 477 797		← 1718
							1987 482 160		→ 1735
	3.0i24V	03.92-07.96	138				1987 477 797		← 1718
							1987 482 160		→ 1735
		ABO 06.91-08.96	138				1987 477 797		← 1718
							1987 482 160		→ 1735
	<b>Camry [XV30]</b>								
	2.4i	09.01-01.06	117		15Z				F 026 A03 538 <sup>7</sup>
	<b>Carina</b>								
	1.5i	08.96-12.01	74				0986 475 734		← 19
							0986 475 735		→ 19
	1.8i	08.96-12.01	85				0986 475 734		← 19
							0986 475 735		→ 19





**Carina E Liftback [T19]**

Icon	Engine	Start	End	Power	Code	Power	Code
	<b>1.6i 16V</b>	02.92-01.96	79/85		0 986 473 126	← 57,15	
					0 986 474 126	→ 57,15	
		12.92-10.97	79/85		0 986 473 382	← 57,15	
					0 986 474 382	→ 57,15	
		02.94-01.96	75		0 986 473 382	← 57,15	
					0 986 474 382	→ 57,15	
	<b>1.8i 16V</b>	12.94-10.97	79		0 986 473 382	← 57,15	
					0 986 474 382	→ 57,15	
	<b>2.0D</b>	02.92-01.96	53-54		0 986 473 126	← 57,15	
					0 986 474 126	→ 57,15	
		10.94-01.96	53-54		0 986 473 382	← 57,15	
					0 986 474 382	→ 57,15	
	<b>2.0D Turbo</b>	01.96-10.97	61		0 986 473 382	← 57,15	
					0 986 474 382	→ 57,15	
	<b>2.0i 16V</b>	02.92-01.96	98	AGT	0 986 473 369	← 38	
					0 986 474 369	→ 38	
				GLA	0 986 473 382	← 57,15	
					0 986 474 382	→ 57,15	
			115-116/ 129	AGT	0 986 473 369	← 38	
					0 986 474 369	→ 38	
				GLA	0 986 473 382	← 57,15	
					0 986 474 382	→ 57,15	
		12.93-10.97	98		0 986 473 382	← 57,15	
					0 986 474 382	→ 57,15	
	<b>1.6i 16V</b>	02.92-01.96	79/85		0 986 475 734	← 19	
					0 986 475 735	→ 19	
		02.94-01.96	75		0 986 475 734	← 19	
					0 986 475 735	→ 19	
		02.96-10.97	79/85		0 986 475 862	← 20,6	
					0 986 475 863	→ 20,6	
	<b>1.8i 16V</b>	12.94-01.96	79		0 986 475 734	← 19	
					0 986 475 735	→ 19	
		02.96-10.97	79		0 986 475 862	← 20,6	
					0 986 475 863	→ 20,6	
	<b>2.0D</b>	02.92-01.96	53-54		0 986 475 734	← 19	
					0 986 475 735	→ 19	
	<b>2.0D Turbo</b>	02.92-01.96	61/98		0 986 475 734	← 19	
	<b>2.0i 16V</b>				0 986 475 735	→ 19	
		02.96-10.97	61/98		0 986 475 862	← 20,6	
					0 986 475 863	→ 20,6	
	<b>2.0i 16V</b>	02.92-01.96	115-116/ 129		0 986 475 734	← 19	
					0 986 475 735	→ 19	
	<b>2.0i 16V</b>	02.92-02.94	98/115-116/ 129		0 986 473 333	← 35	
					0 986 474 333	→ 35	
	<b>1.6i 16V</b>	02.92-01.96	75/79/85		1 987 477 410	→ 1727	
					1 987 477 414	← 1780	
		02.92-10.97	75/79/85		1 987 477 986	346	
	<b>1.8i 16V</b>	12.94-01.96	79		1 987 477 410	→ 1727	
					1 987 477 414	← 1780	
		12.94-10.97	79		1 987 477 986	346	
	<b>2.0D</b>	02.92-01.96	53-54/61		1 987 477 410	→ 1727	
	<b>2.0D Turbo</b>				1 987 477 414	← 1780	
		02.92-10.97	53-54/61		1 987 477 986	346	





TOYOTA Carina E Liftback [T19]										
2.0 i 16V	02.92-01.96	98	GLA,XLA	1987 477 410	→ 1727					
				1987 477 414	← 1780					
	115-116/ 129		GLA,XLA	1987 477 986	346					
				1987 477 410	→ 1727					
	02.92-10.97	98			1987 477 414	← 1780				
					1987 477 986	346				
12.93-01.96	98			1987 477 410	→ 1727					
				1987 477 414	← 1780					
1.6 i 16V	11.94-01.96	75	LAB	0 265 001 417 <sup>3</sup>						
			RAB	0 265 001 416 <sup>3</sup>						
	11.94-10.97	79	85	LAB	0 265 001 417 <sup>3</sup>					
				RAB	0 265 001 416 <sup>3</sup>					
		85		LAB	0 265 001 417 <sup>3</sup>					
				RAB	0 265 001 416 <sup>3</sup>					
	02.96-10.97	79	85	LAB	0 265 001 419 <sup>4</sup>					
				RAB	0 265 001 418 <sup>4</sup>					
		85		LAB	0 265 001 419 <sup>4</sup>					
				RAB	0 265 001 418 <sup>4</sup>					
	1.8 i 16V	12.94-10.97	79	LAB	0 265 001 417 <sup>3</sup>					
				RAB	0 265 001 416 <sup>3</sup>					
2.0 D	11.94-01.96	53-54	LAB	0 265 001 417 <sup>3</sup>						
			RAB	0 265 001 416 <sup>3</sup>						
2.0 D Turbo	01.96-10.97	61	LAB	0 265 001 417 <sup>3</sup>						
			RAB	0 265 001 416 <sup>3</sup>						
2.0 i 16V	11.94-10.97	98	LAB	0 265 001 417 <sup>3</sup>						
			RAB	0 265 001 416 <sup>3</sup>						
2.0 i 16V	02.96-10.97	98	LAB	0 265 001 419 <sup>4</sup>						
			RAB	0 265 001 418 <sup>4</sup>						

**Carina E Sedan [T19]**

Carina E Sedan [T19]										
1.6 i 16V	02.92-01.96	79/85		0 986 473 126	👁️ ← 57,15					
				0 986 474 126	👁️ → 57,15					
	09.93-10.97	79/85			0 986 473 382	👁️ ← 57,15				
					0 986 474 382	👁️ → 57,15				
	02.94-01.96	75			0 986 473 382	👁️ ← 57,15				
					0 986 474 382	👁️ → 57,15				
	1.8 i 16V	12.94-10.97	79		0 986 473 382	👁️ ← 57,15				
					0 986 474 382	👁️ → 57,15				
	2.0 D	02.92-01.96	53-54		0 986 473 126	👁️ ← 57,15				
					0 986 474 126	👁️ → 57,15				
	2.0 D	10.94-01.96	53-54		0 986 473 382	👁️ ← 57,15				
					0 986 474 382	👁️ → 57,15				
2.0 D Turbo	01.96-10.97	61		0 986 473 382	👁️ ← 57,15					
				0 986 474 382	👁️ → 57,15					
2.0 i 16V	02.92-01.96	98	AGT	0 986 473 369	👁️ ← 38					
				0 986 474 369	👁️ → 38					
				GLA	0 986 473 382	👁️ ← 57,15				
					0 986 474 382	👁️ → 57,15				
	115-116/ 129			AGT	0 986 473 369	👁️ ← 38				
					0 986 474 369	👁️ → 38				
				GLA	0 986 473 382	👁️ ← 57,15				
					0 986 474 382	👁️ → 57,15				
	12.92-10.97	98			0 986 473 382	👁️ ← 57,15				
					0 986 474 382	👁️ → 57,15				

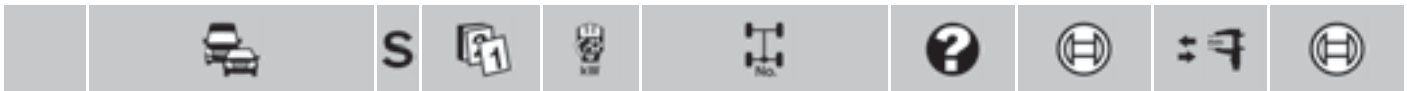







































	1.6i 16V	02.92-01.96	79/85			0 986 475 734	← 19		
						0 986 475 735	→ 19		
		02.94-01.96	75			0 986 475 734	← 19		
						0 986 475 735	→ 19		
		02.96-10.97	79/85			0 986 475 862	← 20,6		
						0 986 475 863	→ 20,6		
	1.8i 16V	12.94-01.96	79			0 986 475 734	← 19		
						0 986 475 735	→ 19		
		02.96-10.97	79			0 986 475 862	← 20,6		
						0 986 475 863	→ 20,6		
	2.0D	02.92-01.96	53-54			0 986 475 734	← 19		
						0 986 475 735	→ 19		
2.0D Turbo	02.92-01.96	61/98			0 986 475 734	← 19			
2.0i 16V					0 986 475 735	→ 19			
	02.96-10.97	61/98			0 986 475 862	← 20,6			
					0 986 475 863	→ 20,6			
2.0i 16V	02.92-01.96	115-116/ 129			0 986 475 734	← 19			
					0 986 475 735	→ 19			
	2.0i 16V	02.92-02.94	98/115-116/ 129			0 986 473 333	← 35		
						0 986 474 333	→ 35		
	1.6i 16V	02.92-01.96	75/79/85			1 987 477 410	→ 1727		
						1 987 477 414	← 1780		
		02.92-10.97	75/79/85			1 987 477 986	346		
	1.8i 16V	12.94-01.96	79			1 987 477 410	→ 1727		
						1 987 477 414	← 1780		
		12.94-10.97	79			1 987 477 986	346		
	2.0D	02.92-01.96	53-54/61			1 987 477 410	→ 1727		
	2.0D Turbo					1 987 477 414	← 1780		
		02.92-10.97	53-54/61			1 987 477 986	346		
	2.0i 16V	02.92-01.96	98		GLA,XLA	1 987 477 410	→ 1727		
						1 987 477 414	← 1780		
			115-116/ 129		GLA,XLA	1 987 477 986	346		
						1 987 477 410	→ 1727		
						1 987 477 414	← 1780		
			02.92-10.97	98			1 987 477 986	346	
	12.92-01.96	98			1 987 477 410	→ 1727			
					1 987 477 414	← 1780			
	1.6i 16V	11.94-01.96	75		LAB	0 265 001 417 <sup>3</sup>			
					RAB	0 265 001 416 <sup>3</sup>			
		11.94-10.97	79		LAB	0 265 001 417 <sup>3</sup>			
					RAB	0 265 001 416 <sup>3</sup>			
			85		LAB	0 265 001 417 <sup>3</sup>			
					RAB	0 265 001 416 <sup>3</sup>			
	02.96-10.97	79		LAB	0 265 001 419 <sup>4</sup>				
				RAB	0 265 001 418 <sup>4</sup>				
		85		LAB	0 265 001 419 <sup>4</sup>				
				RAB	0 265 001 418 <sup>4</sup>				
	1.8i 16V	12.94-10.97	79		LAB	0 265 001 417 <sup>3</sup>			
					RAB	0 265 001 416 <sup>3</sup>			
		02.96-10.97	79		LAB	0 265 001 419 <sup>4</sup>			
					RAB	0 265 001 418 <sup>4</sup>			
	2.0D	11.94-01.96	53-54		LAB	0 265 001 417 <sup>3</sup>			
				RAB	0 265 001 416 <sup>3</sup>				
2.0D Turbo	01.96-10.97	61		LAB	0 265 001 417 <sup>3</sup>				
	02.96-10.97	61		LAB	0 265 001 419 <sup>4</sup>				















































		S							
	◀ TOYOTA Carina E Sedan [T19]								
	2.0 D Turbo	02.96-10.97	61			RAB	0 265 001 416 <sup>3</sup>		
							0 265 001 418 <sup>4</sup>		
	2.0 i 16V	11.94-10.97	98			LAB	0 265 001 417 <sup>3</sup>		
						RAB	0 265 001 416 <sup>3</sup>		
		02.96-10.97	98			LAB	0 265 001 419 <sup>4</sup>		
						RAB	0 265 001 418 <sup>4</sup>		
	<b>Carina E Wagon [T19]</b>								
	1.6 i 16V	11.92-01.96	85				0 986 473 126		← 57,15
							0 986 474 126		→ 57,15
		05.95-10.97	79				0 986 473 382		← 57,15
							0 986 474 382		→ 57,15
	1.8 i 16V	11.94-01.96	79				0 986 473 126		← 57,15
							0 986 474 126		→ 57,15
		05.95-10.97	79				0 986 473 382		← 57,15
							0 986 474 382		→ 57,15
	2.0 D	11.92-01.96	53-54				0 986 473 126		← 57,15
							0 986 474 126		→ 57,15
		05.95-01.96	53-54				0 986 473 382		← 57,15
							0 986 474 382		→ 57,15
	2.0 D Turbo	01.96-10.97	61				0 986 473 382		← 57,15
							0 986 474 382		→ 57,15
	2.0 i 16V	11.92-01.96	98			AGT	0 986 473 369		← 38
							0 986 474 369		→ 38
						GLA	0 986 473 382		← 57,15
							0 986 474 382		→ 57,15
		05.95-10.97	98				0 986 473 382		← 57,15
							0 986 474 382		→ 57,15
	1.6 i 16V	11.92-01.96	85				0 986 475 734		← 19
							0 986 475 735		→ 19
		05.95-01.96	79				0 986 475 734		← 19
							0 986 475 735		→ 19
		02.96-10.97	79				0 986 475 862		← 20,6
							0 986 475 863		→ 20,6
	1.8 i 16V	11.94-01.96	79				0 986 475 734		← 19
							0 986 475 735		→ 19
		02.96-10.97	79				0 986 475 862		← 20,6
							0 986 475 863		→ 20,6
	2.0 D	11.92-01.96	53-54				0 986 475 734		← 19
							0 986 475 735		→ 19
	2.0 D Turbo	11.92-01.96	61/98				0 986 475 734		← 19
	2.0 i 16V						0 986 475 735		→ 19
		02.96-10.97	61/98				0 986 475 862		← 20,6
							0 986 475 863		→ 20,6
		2.0 i 16V	11.92-02.94	98			0 986 473 333		← 35
							0 986 474 333		→ 35
	1.6 i 16V	11.92-01.96	79/85				1 987 477 410		→ 1727
							1 987 477 414		← 1780
		11.92-10.97	79/85				1 987 477 986		346
	1.8 i 16V	11.94-01.96	79				1 987 477 410		→ 1727
							1 987 477 414		← 1780
		11.94-10.97	79				1 987 477 986		346
	2.0 D	11.92-01.96	53-54/61				1 987 477 410		→ 1727
	2.0 D Turbo						1 987 477 414		← 1780
		11.92-10.97	53-54/61				1 987 477 986		346

		S							
2.0i16V		11.92-01.96	98			GLA,XLA	1 987 477 410	→ 1727	
							1 987 477 414	← 1780	
		11.92-10.97	98				1 987 477 986	346	
		05.95-01.96	98				1 987 477 410	→ 1727	
							1 987 477 414	← 1780	
		05.95-10.97	79			LAB	0 265 001 417 <sup>3</sup>		
						RAB	0 265 001 416 <sup>3</sup>		
		02.96-10.97	79			LAB	0 265 001 419 <sup>4</sup>		
						RAB	0 265 001 418 <sup>4</sup>		
1.8i16V		02.96-10.97	79			LAB	0 265 001 419 <sup>4</sup>		
						RAB	0 265 001 418 <sup>4</sup>		
2.0D		05.95-01.96	53-54			LAB	0 265 001 417 <sup>3</sup>		
						RAB	0 265 001 416 <sup>3</sup>		
2.0D Turbo		01.96-10.97	61			LAB	0 265 001 417 <sup>3</sup>		
		02.96-10.97	61			LAB	0 265 001 419 <sup>4</sup>		
						RAB	0 265 001 416 <sup>3</sup>		
							0 265 001 418 <sup>4</sup>		
2.0i16V		05.95-10.97	98			LAB	0 265 001 417 <sup>3</sup>		
						RAB	0 265 001 416 <sup>3</sup>		
		02.96-10.97	98			LAB	0 265 001 419 <sup>4</sup>		
						RAB	0 265 001 418 <sup>4</sup>		
<b>Celica Cabrio [T20]</b>									
		2.0i16V	08.94-05.99	129					F 026 A08 182 <sup>7</sup>
		2.0i16V	08.94-05.99	129			1 987 477 795	→ 1627	
<b>Celica Coupé [T23]</b>									
		1.8i16V	08.99-08.02	105			0 986 473 196	↔ 57	
							0 986 474 196	↔ 57	
		08.00-08.05	140						F 026 A03 542 <sup>7</sup>
		09.02-09.05	105						F 026 A03 542 <sup>7</sup>
		1.8i16V	08.99-09.05	105/140			1 987 482 259	388	
								↔ 388	
							1 987 482 260	← 1707	
							1 987 482 261	→ 1672	
<b>Celica Liftback [T20]</b>									
		1.8i16V	11.93-08.96	85			0 986 473 126	↔ 57,15	F 026 A08 182 <sup>7</sup>
							0 986 474 126	↔ 57,15	F 026 A08 182 <sup>7</sup>
		09.96-08.99	85						F 026 A08 182 <sup>7</sup>
		2.0i16V	11.93-08.99	129		FEN			F 026 A08 182 <sup>7</sup>
		1.8i16V	11.93-08.99	85			0 986 473 198	↔ 32	F 026 A08 151 <sup>7</sup>
							0 986 474 198	↔ 32	F 026 A08 151 <sup>7</sup>



								
◀ TOYOTA Celica Liftback [T20]								
								
	1.8 i 16V	11.93-08.99	85			1987 477 795	→	1627
	2.0 i 16V	11.93-08.99	129			1987 477 795	→	1627
<b>Condor</b>								
								
	2.4 i	06.00-02.05	85					F 026 A03 535
<b>Condor Estate</b>								
								
	1.8	06.00-06.03	65					F 026 A03 535
	2.4 i	06.00-02.05	85					F 026 A03 535
<b>Conquest</b>								
								
	1.6 i	09.93-07.06	79			0986 473 089		← 51,04
						0986 474 089		→ 51,04
	1.8 Si	09.93-06.96	85			0986 473 089		← 51,04
						0986 474 089		→ 51,04
								
	1.3	06.93-09.96	55			F 026 002 371		↔ 19,05
		11.00-07.06	55			F 026 002 371		↔ 19,05
	1.6 i	09.93-07.06	79			F 026 002 371		↔ 19,05
	1.8 Si	09.93-06.96	85			0986 473 489		← 30 F 026 A03 490
<b>Conquest [Carri]</b>								
								
	1.3	11.98→	55			F 026 002 371		↔ 19,05
<b>Corolla Altis</b>								
								
	1.8 i	03.99-01.08	101			0986 473 196		← 57
						0986 474 196		→ 57
								
	1.6 i	05.01-10.06	82			0986 475 881	←	17,46
						0986 475 882	→	17,46
	1.8 i	03.99-01.08	101			0986 475 881	←	17,46
						0986 475 882	→	17,46
	1.6 i	05.01-10.06	82					F 026 A03 512 <sup>7</sup>
	1.8 i	03.99-01.08	101					F 026 A03 512 <sup>7</sup>
								
	1.6 i	05.01-10.06	82			1987 482 306	→	1688
						1987 482 307	←	1616
	1.8 i	03.99-01.08	101			1987 482 306	→	1688
						1987 482 307	←	1616



































		S							
<b>Corolla [E9]</b>									
									
	1.6i	09.93-09.96	79				0 986 473 089	 ← 51,04	
							0 986 474 089	 → 51,04	
									
	1.3	10.93-12.95	55				F 026 002 371	↔ 19,05	
	1.6i	09.93-09.96	79				F 026 002 371	↔ 19,05	
	1.6i	09.93-09.96	79				0 986 473 489	 ← 30	F 026 A03 508 <sup>7</sup>
							0 986 474 489	 → 30	F 026 A03 508 <sup>7</sup>
<b>Corolla [E10]</b>									
									
	1.3 12V	05.92-04.97	55				0 986 473 089	 ← 51,04	
							0 986 474 089	 → 51,04	
	1.6i 16V	05.92-08.96	84-85				0 986 473 064	 ← 54	
							0 986 474 064	 → 54	
		09.96-04.97	84-85				0 986 473 064	 ← 54	F 026 A03 454 <sup>7</sup>
							0 986 474 064	 → 54	F 026 A03 454 <sup>7</sup>
	1.8i 16V	09.92-08.96	77-85				0 986 473 064	 ← 54	
							0 986 474 064	 → 54	
		09.96-08.97	77-85				0 986 473 064	 ← 54	F 026 A03 454 <sup>7</sup>
							0 986 474 064	 → 54	F 026 A03 454 <sup>7</sup>
									
	1.3 12V	05.92-04.97	55				0 986 475 895	← 17,46	
							0 986 475 896	→ 17,46	
	1.6i 16V	05.92-04.97	84-85				0 986 475 734	← 19	
							0 986 475 735	→ 19	
	1.8i 16V	09.92-08.97	77-85				0 986 475 734	← 19	
							0 986 475 735	→ 19	
									
	1.3 12V	05.92-05.95	55				1 987 477 983	292	
		05.92-04.97	55				1 987 477 409	→ 1603	
							1 987 477 413	← 1585	
		06.95-04.97	55				1 987 477 984	296	
	1.6i 16V	05.92-05.95	84-85				1 987 477 983	292	
		05.92-04.97	84-85				1 987 477 409	→ 1603	
							1 987 477 413	← 1585	
		06.95-04.97	84-85				1 987 477 984	296	
	1.8i 16V	09.92-05.95	77-85				1 987 477 983	292	
		06.95-08.97	77-85				1 987 477 984	296	
<b>Corolla [E11]</b>									
									
	1.3	04.97-11.04	53/54				0 986 473 089	 ← 51,04	
							0 986 474 089	 → 51,04	
	1.3i 16V	04.97-10.99	55-63				0 986 473 064	 ← 54	F 026 A03 454 <sup>7</sup>
							0 986 474 064	 → 54	F 026 A03 454 <sup>7</sup>
	1.6i	09.96-09.02	79				0 986 473 089	 ← 51,04	
							0 986 474 089	 → 51,04	
	1.8i	10.96-08.02	85				0 986 473 089	 ← 51,04	
							0 986 474 089	 → 51,04	
	1.8i 16V	09.97-08.02	92				0 986 473 064	 ← 54	F 026 A03 454 <sup>7</sup>
							0 986 474 064	 → 54	F 026 A03 454 <sup>7</sup>





















		S								
	<b>TOYOTA Corolla [E11]</b>									
1.9D		01.00-07.01	51				0986 473 064	← 54	F 026 A03 454 <sup>7</sup>	
							0986 474 064	→ 54	F 026 A03 454 <sup>7</sup>	
2.0D		04.97-10.99	53				0986 473 064	← 54	F 026 A03 454 <sup>7</sup>	
							0986 474 064	→ 54	F 026 A03 454 <sup>7</sup>	
2.0D Turbo		08.00-09.01	66				0986 473 064	← 54	F 026 A03 454 <sup>7</sup>	
							0986 474 064	→ 54	F 026 A03 454 <sup>7</sup>	
	1.3	09.96-08.99	55				F 026 002 371	↔ 19,05		
		04.97-07.01	53				0986 475 734	← 19		
							0986 475 735	→ 19		
		11.97-11.04	54				0986 475 895	← 17,46		
1.3 i 16V		04.97-10.99	55-63				0986 475 734	← 19		
							0986 475 735	→ 19		
1.6 i		09.96-09.02	79				F 026 002 371	↔ 19,05		
1.8 i 16V		09.97-08.02	92				0986 475 734	← 19		
							0986 475 735	→ 19		
1.9D		01.00-07.01	51				0986 475 734	← 19		
2.0D		04.97-10.99	53				0986 475 735	→ 19		
							0986 475 734	← 19		
0986 475 735								→ 19		
								← 19		
	1.3 i 16V	08.98-10.99	55-63				0986 473 489	← 30	F 026 A03 508 <sup>7</sup>	
							0986 474 489	→ 30	F 026 A03 508 <sup>7</sup>	
1.6 i		09.96-09.02	79				0986 473 489	← 30	F 026 A03 508 <sup>7</sup>	
							0986 474 489	→ 30	F 026 A03 508 <sup>7</sup>	
1.8 i		10.96-08.02	85				0986 473 489	← 30	F 026 A03 508 <sup>7</sup>	
							0986 474 489	→ 30	F 026 A03 508 <sup>7</sup>	
1.9D		01.00-07.01	51				0986 473 214	← 35	F 026 A03 508 <sup>7</sup>	
							0986 474 214	→ 35	F 026 A03 508 <sup>7</sup>	
2.0D		08.98-10.99	53				0986 473 489	← 30	F 026 A03 508 <sup>7</sup>	
							0986 474 489	→ 30	F 026 A03 508 <sup>7</sup>	
2.0D Turbo		08.00-09.01	66				0986 473 214	← 35	F 026 A03 508 <sup>7</sup>	
							0986 474 214	→ 35	F 026 A03 508 <sup>7</sup>	
	1.3	04.97-07.01	53				1987 477 984	296		
							TBR	1987 477 409	← 1603	
								1987 477 413	→ 1585	
								1987 477 409	→ 1603	
1.3 i 16V		04.97-10.99	55-63				1987 477 413	← 1585		
							1987 477 984	296		
1.8 i 16V		09.97-08.02	92				TBR	1987 477 409	← 1603	
								1987 477 413	→ 1585	
1.9D		01.00-07.01	51				1987 477 984	296		
							TBR	1987 477 409	← 1603	
2.0D		04.97-10.99	53				1987 477 413	→ 1585		
							1987 477 984	296		
2.0D Turbo		08.00-09.01	66				TBR	1987 477 409	← 1603	
								1987 477 413	→ 1585	
<b>Corolla [E12]</b>										
	1.4D Turbo	08.04-02.07	66				0986 473 200	← 57		
							0986 474 200	→ 57		
1.4 i		09.02-07.07	71						F 026 A06 150 <sup>7</sup>	
		06.04-02.07	71				0986 473 200	← 57		
1.4 i, i 16V		06.04-02.07	71				0986 474 200	→ 57		

		S							
1.4i 16V		10.01-05.04	71				0 986 473 196	 ← 57	
							0 986 474 196	 → 57	
1.5i		06.04-11.06	71				0 986 473 200	 ← 57	
		08.00-10.06	80-81				0 986 473 196	 ← 57	
1.6i		09.02-07.07	81						F 026 A06 150 <sup>7</sup>
		06.04-02.07	81				0 986 473 200	 ← 57	
1.6i, i 16V		06.04-02.07	81				0 986 474 200	 → 57	
1.6i 16V		10.01-05.04	81				0 986 473 196	 ← 57	
							0 986 474 196	 → 57	
1.8		ABO 08.00-08.08	93-108						F 026 A06 149 <sup>7</sup>
							ABS 08.00-08.08	93-108	
1.8i		08.00-10.06	97-100				0 986 474 196	 → 57	
							0 986 473 196	 ← 57	
1.8i RXi		09.02-07.07	141						F 026 A06 150 <sup>7</sup>
							0 986 474 196	 → 57	
2.0D Turbo		06.04-02.07	66				0 986 473 200	 ← 57	
							0 986 474 200	 → 57	
									
	1.3i	08.00-10.06	64-65				0 986 475 881	← 17,46	
							0 986 475 882	→ 17,46	
1.8	1.8i	08.00-08.08	93-108				0 986 475 881	← 17,46	
							0 986 475 882	→ 17,46	
	1.4i	09.02-07.07	71						F 026 A06 154 <sup>7</sup>
	1.4i 16V	10.01-05.04	71				0 986 473 213	 ← 36	
1.5i	1.6i	08.00-04.04	80-81						F 026 A03 512 <sup>7</sup>
							09.02-07.07	81	
1.6i 16V		10.01-05.04	81				0 986 473 213	 ← 36	
							0 986 474 213	 → 36	
1.8	1.8i	08.00-04.04	93-108						F 026 A03 512 <sup>7</sup>
							09.02-07.07	99	
1.8i RXi		09.02-07.07	141				0 986 473 213	 ← 36	
							0 986 474 213	 → 36	
									
	1.3i	08.00-10.06	64-65				1 987 477 985	398	
	1.4D Turbo, i, i 16V	10.01-07.07	66/71				1 987 477 985	398	
1.4D Turbo	1.4i 16V	10.01-05.04	66/71				1 987 482 306	→ 1688	
							1 987 482 307	← 1616	
1.5i		08.00-10.06	80-81				1 987 477 985	398	
							1 987 482 306	→ 1688	
1.6i	1.6i 16V	01.02-02.07	81				1 987 482 307	← 1616	
							1 987 477 985	398	
1.6i 16V		10.01-05.04	81				1 987 482 306	→ 1688	
							1 987 482 307	← 1616	
1.8		10.01-11.06	81				1 987 477 985	398	
		08.00-03.06	93-108				1 987 477 985	398	
1.8		08.00-08.08	93-108			4SB	1 987 482 306	→ 1688	
							1 987 482 307	← 1616	
1.8i	2.0D Turbo	08.00-10.06	97-100				1 987 477 985	398	
							01.02-02.07	66	
	1.4D Turbo	06.04-02.07	66/71			LAB	0 265 006 676 <sup>3</sup>		
	1.4i					RAB	0 265 006 677 <sup>3</sup>		
1.6i		06.04-02.07	81			LAB	0 265 006 676 <sup>3</sup>		
						RAB	0 265 006 677 <sup>3</sup>		





















		S							
	◀ TOYOTA Corolla [E12]								
	2.0 D Turbo	06.04-02.07	66				LAB	0 265 006 676 <sup>3</sup>	
							RAB	0 265 006 677 <sup>3</sup>	
<b>Corolla [E14/E15]</b>									
	2.0 D-4D	11.06-02.10	93						0 204 104 359 <sup>8</sup>
	2.0 D-4D	11.06-02.10	93						0 204 104 359 <sup>8</sup>
<b>Corolla [E15]</b>									
	1.3 VVT-i	12.08-04.13	74					0 986 134 347	← 60 F 026 A06 625 <sup>7</sup>
								0 986 134 347	← 60 0 204 104 359 <sup>8</sup>
								0 986 135 347	→ 60 F 026 A06 625 <sup>7</sup>
	1.4 D-4D	11.06-04.13	66/71					0 204 902 127	← 0 204 104 359 <sup>8</sup>
	1.4 WT-i							0 204 902 128	→ 0 204 104 359 <sup>8</sup>
	1.6	11.06-04.13	91/97					0 986 134 347	← 60 F 026 A06 625 <sup>7</sup>
	1.6 WT-i							0 986 134 347	← 60 0 204 104 359 <sup>8</sup>
								0 986 135 347	→ 60 F 026 A06 625 <sup>7</sup>
	1.8 i	09.07-03.10	100					0 204 902 127	← 0 204 104 359 <sup>8</sup>
								0 204 902 128	→ 0 204 104 359 <sup>8</sup>
	1.3 VVT-i	12.08-04.13	74						0 204 104 359 <sup>8</sup>
	1.4 D-4D, VVT-i	11.06-04.13	66/71						0 204 104 359 <sup>8</sup>
	1.6, VVT-i	11.06-04.13	91/97						0 204 104 359 <sup>8</sup>
	1.8 i	09.07-03.10	100						0 204 104 359 <sup>8</sup>
	1.4 D-4D	11.06-04.13	66				LAB	0 265 007 947 <sup>3</sup>	
							RAB	0 265 007 946 <sup>3</sup>	
<b>Corolla [E18]</b>									
	1.6	06.13→	91/97			BSS		0 986 134 347	← 60 F 026 A06 625 <sup>7</sup>
	1.6 WT-i							0 986 134 347	← 60 0 204 104 359 <sup>8</sup>
								0 986 135 347	→ 60 F 026 A06 625 <sup>7</sup>
	1.8 WT-i	06.13→	100-103			BSS		0 986 134 347	← 60 F 026 A06 625 <sup>7</sup>
								0 986 134 347	← 60 0 204 104 359 <sup>8</sup>
								0 986 135 347	→ 60 F 026 A06 625 <sup>7</sup>
	1.3 WT-i	06.13→	74						0 204 104 359 <sup>8</sup>
	1.4 D-4D	06.13→	66						0 204 104 359 <sup>8</sup>
	1.6	06.13→	91/97			BSS			0 204 104 359 <sup>8</sup>
	1.6 WT-i					BSS			0 204 104 359 <sup>8</sup>
	1.8 WT-i	06.13→	100-103			BSS			0 204 104 359 <sup>8</sup>
						BSS			0 204 104 359 <sup>8</sup>
	1.3 WT-i	06.13→	74				LAB	0 265 007 806 <sup>3</sup>	
							RAB	0 265 007 805 <sup>3</sup>	
	1.4 D-4D	06.13→	66				LAB	0 265 007 806 <sup>3</sup>	
							RAB	0 265 007 805 <sup>3</sup>	

		S							
1.6		06.13→	91/97			BSS,LAB	0 265 007 806 <sup>3</sup>		
1.6 VWT-i						BSS,RAB	0 265 007 805 <sup>3</sup>		
1.8 VWT-i		06.13→	100-103			BSS,LAB	0 265 007 806 <sup>3</sup>		
						BSS,RAB	0 265 007 805 <sup>3</sup>		
<b>Corolla Fielder</b>									
									
 1.5 i		08.00-10.06	80-81				0 986 475 881	← 17,46	
							0 986 475 882	→ 17,46	
									
 1.5 i		08.00-10.06	80-81				1 987 477 985	398	
<b>Corolla Hatchback [E10]</b>									
									
 1.3 i16V		05.92-05.95	65				0 986 473 064	← 54	
							0 986 474 064	→ 54	
		05.95-08.96	55				0 986 473 064	← 54	
							0 986 474 064	→ 54	
		09.96-04.97	55				0 986 473 064	← 54	F 026 A03 454 <sup>7</sup>
							0 986 474 064	→ 54	F 026 A03 454 <sup>7</sup>
1.3 12V		05.92-05.95	55				0 986 473 089	← 51,04	
							0 986 474 089	→ 51,04	
1.6 i16V		05.92-08.96	84-85				0 986 473 064	← 54	
							0 986 474 064	→ 54	
		09.96-04.97	84-85				0 986 473 064	← 54	F 026 A03 454 <sup>7</sup>
							0 986 474 064	→ 54	F 026 A03 454 <sup>7</sup>
1.8 i16V		11.92-05.95	86				0 986 473 064	← 54	
							0 986 474 064	→ 54	
2.0 D		05.92-08.96	53-54				0 986 473 064	← 54	
							0 986 474 064	→ 54	
		09.96-04.97	53-54				0 986 473 064	← 54	F 026 A03 454 <sup>7</sup>
							0 986 474 064	→ 54	F 026 A03 454 <sup>7</sup>
									
 1.3 i16V		05.92-05.95	65				0 986 475 734	← 19	
							0 986 475 735	→ 19	
		05.95-04.97	55				0 986 475 734	← 19	
							0 986 475 735	→ 19	
1.3 12V		05.92-05.95	55				0 986 475 895	← 17,46	
							0 986 475 896	→ 17,46	
1.6 i16V		05.92-04.97	84-85				0 986 475 734	← 19	
							0 986 475 735	→ 19	
2.0 D		05.92-04.97	53-54				0 986 475 734	← 19	
							0 986 475 735	→ 19	
									
1.3 i16V		05.92-05.95	65				1 987 477 409	→ 1603	
							1 987 477 413	← 1585	
							1 987 477 983	292	
		05.95-04.97	55				1 987 477 413	← 1585	
							1 987 477 984	296	
1.3 i16V, 12V		05.92-04.97	55				1 987 477 409	→ 1603	
1.3 12V		05.92-05.95	55				1 987 477 413	← 1585	
							1 987 477 983	292	
1.6 i16V		05.92-05.95	84-85				1 987 477 983	292	
		05.92-04.97	84-85				1 987 477 409	→ 1603	
							1 987 477 413	← 1585	



		S									
	◀ TOYOTA Corolla Hatchback [E10]										
	1.6 i 16V	06.95-04.97	84-85				1987 477 984	296			
	1.8 i 16V	11.92-05.95	86				1987 477 983	292			
	2.0D	05.92-05.95	53-54				1987 477 983	292			
		05.92-04.97	53-54				1987 477 409	→ 1603			
		06.95-04.97	53-54				1987 477 413	← 1585			
							1987 477 984	296			
	<b>Corolla Hatchback [E11]</b>										
	1.3 i 16V	05.97-09.99	63				0986 473 064	← 54	F 026 A03 454 <sup>7</sup>		
								0986 474 064	→ 54	F 026 A03 454 <sup>7</sup>	
	1.4 i 16V	10.99-07.01	71				0986 473 064	← 54	F 026 A03 454 <sup>7</sup>		
							0986 474 064	→ 54	F 026 A03 454 <sup>7</sup>		
	1.6 i 16V	05.97-07.01	79-81				0986 473 064	← 54	F 026 A03 454 <sup>7</sup>		
								0986 474 064	→ 54	F 026 A03 454 <sup>7</sup>	
	1.9D	01.00-07.01	51				0986 473 064	← 54	F 026 A03 454 <sup>7</sup>		
							0986 474 064	→ 54	F 026 A03 454 <sup>7</sup>		
	2.0D	05.97-09.99	53				0986 473 064	← 54	F 026 A03 454 <sup>7</sup>		
							0986 474 064	→ 54	F 026 A03 454 <sup>7</sup>		
	2.0D Turbo	08.00-07.01	66				0986 473 064	← 54	F 026 A03 454 <sup>7</sup>		
								0986 474 064	→ 54	F 026 A03 454 <sup>7</sup>	
	1.3 i 16V	05.97-09.99	63				0986 475 734	← 19			
								0986 475 735	→ 19		
	1.4 i 16V	10.99-07.01	71				0986 475 734	← 19			
							0986 475 735	→ 19			
	1.6 i 16V	05.97-07.01	79-81				0986 475 734	← 19			
								0986 475 735	→ 19		
	1.9D	01.00-07.01	51				0986 475 734	← 19			
							0986 475 735	→ 19			
	2.0D	05.97-09.99	53				0986 475 734	← 19			
								0986 475 735	→ 19		
	1.3 i 16V	08.98-09.99	63				0986 473 489	← 30	F 026 A03 508 <sup>7</sup>		
								0986 474 489	→ 30	F 026 A03 508 <sup>7</sup>	
	1.4 i 16V	10.99-07.01	71				0986 473 214	← 35	F 026 A03 508 <sup>7</sup>		
								0986 474 214	→ 35	F 026 A03 508 <sup>7</sup>	
	1.6 i 16V	08.98-09.99	79-81				0986 473 489	← 30	F 026 A03 508 <sup>7</sup>		
								0986 474 489	→ 30	F 026 A03 508 <sup>7</sup>	
		10.99-07.01	81				0986 473 214	← 35	F 026 A03 508 <sup>7</sup>		
							0986 474 214	→ 35	F 026 A03 508 <sup>7</sup>		
	1.9D	01.00-07.01	51				0986 473 214	← 35	F 026 A03 508 <sup>7</sup>		
								0986 474 214	→ 35	F 026 A03 508 <sup>7</sup>	
	2.0D	08.98-09.99	53				0986 473 489	← 30	F 026 A03 508 <sup>7</sup>		
								0986 474 489	→ 30	F 026 A03 508 <sup>7</sup>	
	2.0D Turbo	08.00-07.01	66				0986 473 214	← 35	F 026 A03 508 <sup>7</sup>		
								0986 474 214	→ 35	F 026 A03 508 <sup>7</sup>	
	1.3 i 16V	05.97-09.99	63				1987 477 984	296			
							TBR	1987 477 409	← 1603		
							1987 477 413	→ 1585			
	1.4 i 16V	10.99-07.01	71				1987 477 984	296			
							TBR	1987 477 409	→ 1603		
							1987 477 413	← 1585			
	1.6 i 16V	05.97-09.99	79-81				1987 477 409	→ 1603			
									1987 477 413	← 1585	
									1987 477 984	296	
		10.99-07.01	81				1987 477 984	296			

								
1.9D	01.00-07.01	51				1 987 477 984	296	
					TBR	1 987 477 409	→ 1603	
						1 987 477 413	← 1585	
2.0D	05.97-09.99	53				1 987 477 409	→ 1603	
						1 987 477 413	← 1585	
2.0D Turbo	08.00-07.01	66				1 987 477 984	296	
<b>Corolla Hatchback [E12]</b>								
								
	1.4D Turbo	11.01-12.07	66/71			0 986 473 200	← 57	
	1.4i16V					0 986 474 200	→ 57	
	1.6i16V	11.01-02.07	81			0 986 473 200	← 57	
						0 986 474 200	→ 57	
	1.8i16V	11.01-12.07	140-165			0 986 473 200	← 57	
						0 986 474 200	→ 57	
	2.0D Turbo	11.01-05.04	66/81-85			0 986 473 200	← 57	
						0 986 474 200	→ 57	
								
	1.4D Turbo	09.02-12.07	66			1 987 477 985	398	
	1.4i16V	11.01-12.07	71		TW	1 987 477 985	398	
	1.6i16V	11.01-02.07	81		TW	1 987 477 985	398	
	1.8i16V	11.01-12.07	140-165		TW	1 987 477 985	398	
	2.0D Turbo	11.01-05.04	66/81-85		TW	1 987 477 985	398	
	1.8i16V	11.01-12.07	140-165		LAB	0 265 006 676 <sup>3</sup>		
					RAB	0 265 006 677 <sup>3</sup>		
<b>Corolla Liftback [E10]</b>								
								
	1.3i16V	05.92-05.95	65			0 986 473 064	← 54	
						0 986 474 064	→ 54	
	1.3 12V	05.92-05.95	55			0 986 473 089	← 51,04	
						0 986 474 089	→ 51,04	
	1.6i16V	05.92-05.95	84-85			0 986 473 064	← 54	
						0 986 474 064	→ 54	
	1.8i16V	11.92-05.95	86			0 986 473 064	← 54	
						0 986 474 064	→ 54	
	2.0D	05.92-05.95	53-54			0 986 473 064	← 54	
						0 986 474 064	→ 54	
								
	1.3i16V	05.92-05.95	65			0 986 475 734	← 19	
						0 986 475 735	→ 19	
	1.3 12V	05.92-05.95	55			0 986 475 895	← 17,46	
						0 986 475 896	→ 17,46	
	1.6i16V	05.92-05.95	84-85			0 986 475 734	← 19	
						0 986 475 735	→ 19	
	2.0D	05.92-05.95	53-54			0 986 475 734	← 19	
						0 986 475 735	→ 19	
								
	1.3i16V	05.92-05.95	55/65			1 987 477 409	→ 1603	
	1.3 12V					1 987 477 413	← 1585	
						1 987 477 983	292	
	1.6i16V	05.92-05.95	84-85			1 987 477 409	→ 1603	
						1 987 477 413	← 1585	
						1 987 477 983	292	





◀ TOYOTA Corolla Liftback [E10]

1.8 i16V	11.92-05.95	86		1987 477 983	292
2.0D	05.92-05.95	53-54		1987 477 409	→ 1603
				1987 477 413	← 1585
				1987 477 983	292

Corolla Liftback [E11]



	1.3 i16V	05.97-09.99	63	SSZ	0986 473 064	← 54	F 026 A03 454 <sup>7</sup>
					0986 474 064	→ 54	F 026 A03 454 <sup>7</sup>
				SSZ			F 026 A08 059 <sup>7</sup>
	1.4 i16V	10.99-09.01	71	SSZ	0986 473 064	← 54	F 026 A03 454 <sup>7</sup>
					0986 474 064	→ 54	F 026 A03 454 <sup>7</sup>
				SSZ			F 026 A08 059 <sup>7</sup>
	1.6 i16V	05.97-09.01	79-81	SSZ	0986 473 064	← 54	F 026 A03 454 <sup>7</sup>
					0986 474 064	→ 54	F 026 A03 454 <sup>7</sup>
				SSZ			F 026 A08 059 <sup>7</sup>
	1.9D	12.99-11.01	51		0986 473 064	← 54	F 026 A03 454 <sup>7</sup>
					0986 474 064	→ 54	F 026 A03 454 <sup>7</sup>
	2.0D	05.97-09.99	53		0986 473 064	← 54	F 026 A03 454 <sup>7</sup>
					0986 474 064	→ 54	F 026 A03 454 <sup>7</sup>
	2.0D Turbo	08.00-09.01	66		0986 473 064	← 54	F 026 A03 454 <sup>7</sup>
					0986 474 064	→ 54	F 026 A03 454 <sup>7</sup>



	1.3 i16V	05.97-09.99	63	SSZ	0986 475 734	← 19	
					0986 475 735	→ 19	
				SSZ	0986 475 895	← 17,46	
					0986 475 896	→ 17,46	
	1.4 i16V	10.99-09.01	71	SSZ	0986 475 734	← 19	
					0986 475 735	→ 19	
				SSZ	0986 475 895	← 17,46	
					0986 475 896	→ 17,46	
	1.6 i16V	05.97-09.01	79-81	SSZ	0986 475 734	← 19	
					0986 475 735	→ 19	
				SSZ	0986 475 895	← 17,46	
					0986 475 896	→ 17,46	
	1.9D	12.99-11.01	51	SSZ	0986 475 734	← 19	
					0986 475 735	→ 19	
				SSZ	0986 475 895	← 17,46	
					0986 475 896	→ 17,46	
	2.0D	05.97-09.99	53	SSZ	0986 475 734	← 19	
					0986 475 735	→ 19	
				SSZ	0986 475 895	← 17,46	
					0986 475 896	→ 17,46	

	1.3 i16V	08.98-11.99	63/79		0986 473 489	← 30	F 026 A03 508 <sup>7</sup>
					0986 474 489	→ 30	F 026 A03 508 <sup>7</sup>
	1.4 i16V	10.99-09.01	71		0986 473 214	← 35	F 026 A03 508 <sup>7</sup>
					0986 474 214	→ 35	F 026 A03 508 <sup>7</sup>
	1.6 i16V	08.98-09.99	79-81		0986 473 489	← 30	F 026 A03 508 <sup>7</sup>
					0986 474 489	→ 30	F 026 A03 508 <sup>7</sup>
		10.99-09.01	81		0986 473 214	← 35	F 026 A03 508 <sup>7</sup>
					0986 474 214	→ 35	F 026 A03 508 <sup>7</sup>
	1.9D	12.99-11.01	51		0986 473 214	← 35	F 026 A03 508 <sup>7</sup>
					0986 474 214	→ 35	F 026 A03 508 <sup>7</sup>
	2.0D	08.98-09.99	53		0986 473 489	← 30	F 026 A03 508 <sup>7</sup>
					0986 474 489	→ 30	F 026 A03 508 <sup>7</sup>
	2.0D Turbo	08.00-09.01	66		0986 473 214	← 35	F 026 A03 508 <sup>7</sup>
					0986 474 214	→ 35	F 026 A03 508 <sup>7</sup>



	1.3i 16V	05.97-09.99	63	TBR	1 987 477 409	← 1603		
					1 987 477 413	→ 1585		
		05.97-11.99	63		1 987 477 984	296		
		09.98-11.99	79		1 987 477 984	296		
	1.4i 16V	10.99-09.01	71	TBR	1 987 477 409	→ 1603		
					1 987 477 413	← 1585		
		10.99-11.01	71		1 987 477 984	296		
	1.6i 16V	05.97-09.99	79-81		1 987 477 409	→ 1603		
					1 987 477 413	← 1585		
					1 987 477 984	296		
		10.99-11.01	81		1 987 477 984	296		
1.9D	12.99-11.01	51		1 987 477 984	296			
			TBR	1 987 477 409	→ 1603			
				1 987 477 413	← 1585			
2.0D	05.97-09.99	53		1 987 477 409	→ 1603			
				1 987 477 413	← 1585			
				1 987 477 984	296			
		12.99-11.01	51		1 987 477 984	296		
2.0D Turbo	08.00-09.01	66		1 987 477 984	296			

**Corolla RunX [E12]**

	1.4i	09.02-07.07	71				F 026 A06 150 <sup>7</sup>
	1.6i	09.02-07.07	81				F 026 A06 150 <sup>7</sup>
	1.8i	08.04-07.07	99				F 026 A06 150 <sup>7</sup>
	1.4i	09.02-07.07	71				F 026 A06 154 <sup>7</sup>
	1.6i	09.02-07.07	81				F 026 A06 154 <sup>7</sup>
	1.8i	08.04-07.07	99				F 026 A06 154 <sup>7</sup>

	1.4i	09.02-07.07	71		1 987 477 985	398	

**Corolla Sedan**

	1.6	04.07-02.15	81		0 986 134 347	← 60	F 026 A06 625 <sup>7</sup>
					0 986 135 347	→ 60	F 026 A06 625 <sup>7</sup>
	1.8	04.07→	97		0 986 134 347	← 60	F 026 A06 625 <sup>7</sup>
					0 986 135 347	→ 60	F 026 A06 625 <sup>7</sup>

**Corolla Sedan [E10]**

	1.3i 16V	05.92-08.96	55-65		0 986 473 064	← 54	
					0 986 474 064	→ 54	
		09.96-04.97	55-65		0 986 473 064	← 54	F 026 A03 454 <sup>7</sup>
					0 986 474 064	→ 54	F 026 A03 454 <sup>7</sup>
	2.0D	05.92-08.96	53-54		0 986 473 064	← 54	
					0 986 474 064	→ 54	
	09.96-04.97	53-54		0 986 473 064	← 54	F 026 A03 454 <sup>7</sup>	
				0 986 474 064	→ 54	F 026 A03 454 <sup>7</sup>	





		S							
◀ TOYOTA Corolla Sedan [E10]									
	1.3 i 16V	05.92-04.97	55-65				0986 475 734	← 19	
							0986 475 735	→ 19	
	2.0 D	05.92-04.97	53-54				0986 475 734	← 19	
							0986 475 735	→ 19	
	1.3 i 16V	05.92-05.95	55-65				1987 477 983	292	
		05.92-04.97	55-65				1987 477 409	→ 1603	
		06.95-04.97	55-65				1987 477 413	← 1585	
							1987 477 984	296	
	2.0 D	05.92-05.95	53-54				1987 477 983	292	
		05.92-04.97	53-54				1987 477 409	→ 1603	
		06.95-04.97	53-54				1987 477 413	← 1585	
		06.95-04.97	53-54				1987 477 984	296	
<b>Corolla Sedan [E11]</b>									
	1.4 i 16V	10.99-09.01	71				0986 473 064	← 54	F 026 A03 454 <sup>7</sup>
							0986 474 064	→ 54	F 026 A03 454 <sup>7</sup>
	1.6 i 16V	04.97-09.01	79-81				0986 473 064	← 54	F 026 A03 454 <sup>7</sup>
							0986 474 064	→ 54	F 026 A03 454 <sup>7</sup>
	1.4 i 16V	10.99-09.01	71				0986 475 734	← 19	
							0986 475 735	→ 19	
	1.6 i 16V	04.97-09.01	79-81				0986 475 734	← 19	
							0986 475 735	→ 19	
	1.4 i 16V	10.99-09.01	71				0986 473 214	← 35	F 026 A03 508 <sup>7</sup>
							0986 474 214	→ 35	F 026 A03 508 <sup>7</sup>
	1.6 i 16V	08.98-10.99	79-81				0986 473 489	← 30	F 026 A03 508 <sup>7</sup>
							0986 474 489	→ 30	F 026 A03 508 <sup>7</sup>
		10.99-09.01	81				0986 473 214	← 35	F 026 A03 508 <sup>7</sup>
							0986 474 214	→ 35	F 026 A03 508 <sup>7</sup>
	1.4 i 16V	10.99-09.01	71				1987 477 984	296	
						TBR	1987 477 409	← 1603	
							1987 477 413	→ 1585	
	1.6 i 16V	04.97-09.01	79-81				1987 477 984	296	
						TBR	1987 477 409	← 1603	
							1987 477 413	→ 1585	
<b>Corolla Sedan [E12]</b>									
	2.0 D Turbo	10.01-05.04	82						F 026 A06 149 <sup>7</sup>
	2.0 D Turbo	10.01-05.04	82				0986 473 213	← 36	
							0986 474 213	→ 36	
	1.6 i 16V	05.02-03.08	81				1987 477 985	398	
	1.8 i 16V	05.02-03.08	97-100				1987 477 985	398	



		S							
2.0D Turbo		10.01-05.04	82				1 987 477 985	398	
							1 987 482 306	→ 1688	
							1 987 482 307	← 1616	
1.8i 16V		05.02-03.08	97-100			LAB	0 265 006 676 <sup>3</sup>		
						RAB	0 265 006 677 <sup>3</sup>		
<b>Corolla Station Wagon [E9]</b>									
1.6		02.92-09.95	85				0 986 473 089	← 51,04	
							0 986 474 089	→ 51,04	
1.6		08.90-09.95	85				F 026 002 371	↔ 19,05	
1.6		02.92-09.95	85				0 986 473 489	← 30	F 026 A03 508 <sup>7</sup>
							0 986 474 489	→ 30	F 026 A03 508 <sup>7</sup>
<b>Corolla Verso [E12]</b>									
1.6i 16V		09.01-08.02	81				0 986 473 196	← 57	F 026 A03 542 <sup>7</sup>
							0 986 474 196	→ 57	F 026 A03 542 <sup>7</sup>
1.8i 16V		09.01-08.02	99				0 986 473 196	← 57	F 026 A03 542 <sup>7</sup>
							0 986 474 196	→ 57	F 026 A03 542 <sup>7</sup>
2.0D Turbo		09.01-01.04	66						F 026 A03 542 <sup>7</sup>
1.6i 16V		09.01-01.04	81				0 986 473 213	← 36	
							0 986 474 213	→ 36	
1.8i 16V		09.01-01.04	99				0 986 473 213	← 36	
							0 986 474 213	→ 36	
2.0D Turbo		09.01-01.04	66				0 986 473 213	← 36	
							0 986 474 213	→ 36	
1.6i 16V		09.01-01.04	81				1 987 477 985	398	
							1 987 482 306	→ 1688	
							1 987 482 307	← 1616	
1.8i 16V		09.01-01.04	99				1 987 477 985	398	
							1 987 482 306	→ 1688	
							1 987 482 307	← 1616	
2.0D Turbo		09.01-01.04	66				1 987 477 985	398	
							1 987 482 306	→ 1688	
							1 987 482 307	← 1616	
<b>Corolla Verso [R1]</b>									
1.6i 16V		02.04-02.09	81				0 986 473 218	← 53	0 204 104 308 <sup>B</sup>
							0 986 474 218	→ 53	0 204 104 308 <sup>B</sup>
1.8i 16V		02.04-02.09	95				0 986 473 218	← 53	0 204 104 308 <sup>B</sup>
							0 986 474 218	→ 53	0 204 104 308 <sup>B</sup>
2.0D Turbo		02.04-08.05	85				0 986 473 218	← 53	
							0 986 474 218	→ 53	
2.2D-CAT		08.05-02.09	100/130				0 986 473 218	← 53	0 204 104 308 <sup>B</sup>
2.2D-4D							0 986 474 218	→ 53	0 204 104 308 <sup>B</sup>



		S							
◀ TOYOTA Corolla Verso [R1]									
	1.6 i 16V	02.04-02.09	81			0986 473 201		← 38	0 204 104 309 <sup>8</sup>
						0986 474 201		→ 38	0 204 104 309 <sup>8</sup>
	1.8 i 16V	02.04-02.09	95			0986 473 201		← 38	0 204 104 309 <sup>8</sup>
						0986 474 201		→ 38	0 204 104 309 <sup>8</sup>
	2.0 D Turbo	02.04-08.05	85			0986 473 201		← 38	
						0986 474 201		→ 38	
	2.2 D-CAT	08.05-02.09	100/130			0986 473 201		← 38	0 204 104 309 <sup>8</sup>
	2.2 D-4D					0986 474 201		→ 38	0 204 104 309 <sup>8</sup>
	1.6 i 16V	02.04-02.09	81			1987 477 240			276
	1.8 i 16V	02.04-02.09	95			1987 477 240			276
	2.0 D Turbo	02.04-08.05	85			1987 477 240			276
	2.2 D-CAT, D-4D	08.05-02.09	100/130			1987 477 240			276
	1.6 i 16V	02.04-02.09	81		LAB	0 265 006 676 <sup>3</sup>			
					RAB	0 265 006 677 <sup>3</sup>			
	1.8 i 16V	02.04-02.09	95		LAB	0 265 006 676 <sup>3</sup>			
					RAB	0 265 006 677 <sup>3</sup>			
	2.0 D Turbo	02.04-08.05	85		LAB	0 265 006 676 <sup>3</sup>			
					RAB	0 265 006 677 <sup>3</sup>			
	2.2 D-CAT	08.05-02.09	100/130		LAB	0 265 006 676 <sup>3</sup>			
	2.2 D-4D				RAB	0 265 006 677 <sup>3</sup>			
<b>Corolla Verso [R2]</b>									
	1.6 D4D-D, i	02.09→	82/97						0 204 104 359 <sup>8</sup>
	1.8 VVT-i	02.09→	108						0 204 104 359 <sup>8</sup>
	2.0 D-4D	02.09→	93						0 204 104 359 <sup>8</sup>
	2.2 D-CAT	02.09→	110-130						0 204 104 359 <sup>8</sup>
	1.6 D4D-D	02.09→	82/97			0 204 902 079		←	0 204 104 384 <sup>8</sup>
	1.6 i					0 204 902 080		→	0 204 104 384 <sup>8</sup>
	1.8 VVT-i	02.09→	108			0 204 902 079		←	0 204 104 384 <sup>8</sup>
						0 204 902 080		→	0 204 104 384 <sup>8</sup>
	2.0 D-4D	02.09→	93			0 204 902 079		←	0 204 104 384 <sup>8</sup>
						0 204 902 080		→	0 204 104 384 <sup>8</sup>
	2.2 D-CAT	02.09→	110-130			0 204 902 079		←	0 204 104 384 <sup>8</sup>
						0 204 902 080		→	0 204 104 384 <sup>8</sup>
	1.6 D4D-D	02.09→	82/97		LAB	0 265 007 806 <sup>3</sup>			
	1.6 i				RAB	0 265 007 805 <sup>3</sup>			
	1.8 VVT-i	02.09→	108		LAB	0 265 007 806 <sup>3</sup>			
					RAB	0 265 007 805 <sup>3</sup>			
	2.0 D-4D	02.09→	93		LAB	0 265 007 806 <sup>3</sup>			
					RAB	0 265 007 805 <sup>3</sup>			
	2.2 D-CAT	02.09→	110-130		LAB	0 265 007 806 <sup>3</sup>			
					RAB	0 265 007 805 <sup>3</sup>			
<b>Corolla Verso [R10/11]</b>									
	1.6 i 16V	02.10→	97			0986 134 334		← 57	0 204 104 359 <sup>8</sup>
						0986 135 334		→ 57	0 204 104 359 <sup>8</sup>

		S							
	1.6i 16V	02.10→	97				0 204 902 079	←	0 204 104 384 <sup>B</sup>
							0 204 902 080	→	0 204 104 384 <sup>B</sup>
	1.6i 16V	02.10→	97			LAB	0 265 007 806 <sup>3</sup>		
						RAB	0 265 007 805 <sup>3</sup>		
<b>Corolla Verso [R11]</b>									
	1.8i 16V	02.04→	97				0 986 473 218	← 53	0 204 104 308 <sup>B</sup>
							0 986 474 218	→ 53	0 204 104 308 <sup>B</sup>
	1.8i 16V	02.04→	97				0 986 473 201	← 38	0 204 104 309 <sup>B</sup>
							0 986 474 201	→ 38	0 204 104 309 <sup>B</sup>
	1.8i 16V	02.04→	97				1 987 477 240	276	
	1.8i 16V	02.04→	97			LAB	0 265 006 676 <sup>3</sup>		
						RAB	0 265 006 677 <sup>3</sup>		
<b>Corolla Wagon</b>									
	1.8i 16V Fielder	05.04-12.07	100				1 987 477 985	398	
	1.8i 16V Fielder	05.04-12.07	100			LAB	0 265 006 676 <sup>3</sup>		
						RAB	0 265 006 677 <sup>3</sup>		
<b>Corolla Wagon [E10]</b>									
	1.3i 16V	05.92-08.96	55-65				0 986 473 064	← 54	
							0 986 474 064	→ 54	
		09.96-04.97	55-65				0 986 473 064	← 54	F 026 A03 454 <sup>7</sup>
							0 986 474 064	→ 54	F 026 A03 454 <sup>7</sup>
	1.3i 12V	05.92-05.95	55				0 986 473 089	← 51,04	
							0 986 474 089	→ 51,04	
	1.6i 16V	05.92-08.96	84-85				0 986 473 064	← 54	
							0 986 474 064	→ 54	
		09.96-04.97	84-85				0 986 473 064	← 54	F 026 A03 454 <sup>7</sup>
							0 986 474 064	→ 54	F 026 A03 454 <sup>7</sup>
	1.8 4x4	05.95-08.96	81				0 986 473 064	← 54	
							0 986 474 064	→ 54	
		09.96-04.97	81				0 986 473 064	← 54	F 026 A03 454 <sup>7</sup>
							0 986 474 064	→ 54	F 026 A03 454 <sup>7</sup>
	2.0D	05.92-08.96	53-54				0 986 473 064	← 54	
							0 986 474 064	→ 54	
		09.96-04.97	53-54				0 986 473 064	← 54	F 026 A03 454 <sup>7</sup>
							0 986 474 064	→ 54	F 026 A03 454 <sup>7</sup>





◀ TOYOTA Corolla Wagon [E10]



	1.3 i 16V	05.92-04.97	55-65	0986 475 734	← 19
				0986 475 735	→ 19
	1.3 12V	05.92-05.95	55	0986 475 895	← 17,46
				0986 475 896	→ 17,46
	1.6 i 16V	05.92-04.97	84-85	0986 475 734	← 19
				0986 475 735	→ 19
	1.8 4x4	05.95-04.97	81	0986 475 734	← 19
				0986 475 735	→ 19
	2.0 D	05.92-04.97	53-54	0986 475 734	← 19
				0986 475 735	→ 19



	1.3 i 16V	05.92-05.95	55-65	1987 477 983	292
		05.92-04.97	55-65	1987 477 409	→ 1603
				1987 477 413	← 1585
		06.95-04.97	55-65	1987 477 984	296
	1.3 12V	05.92-05.95	55	1987 477 409	→ 1603
				1987 477 413	← 1585
				1987 477 983	292
	1.6 i 16V	05.92-05.95	84-85	1987 477 983	292
		05.92-04.97	84-85	1987 477 409	→ 1603
				1987 477 413	← 1585
		06.95-04.97	84-85	1987 477 984	296
	1.8 4x4	05.95-04.97	81	1987 477 984	296
	2.0 D	05.92-05.95	53-54	1987 477 983	292
		05.92-04.97	53-54	1987 477 409	→ 1603
				1987 477 413	← 1585
		05.95-04.97	53-54	1987 477 984	296

Corolla Wagon [E11]



	1.3 i 16V	04.97-10.99	63	0986 473 064	← 54	F 026 A03 454 <sup>7</sup>
				0986 474 064	→ 54	F 026 A03 454 <sup>7</sup>
	1.4 i 16V	10.99-09.01	71	0986 473 064	← 54	F 026 A03 454 <sup>7</sup>
				0986 474 064	→ 54	F 026 A03 454 <sup>7</sup>
	1.6 i 16V	04.97-09.01	79-81	0986 473 064	← 54	F 026 A03 454 <sup>7</sup>
				0986 474 064	→ 54	F 026 A03 454 <sup>7</sup>
	1.8 i 16V 4x4	04.97-07.01	81	0986 473 064	← 54	F 026 A03 454 <sup>7</sup>
				0986 474 064	→ 54	F 026 A03 454 <sup>7</sup>
	1.9 D 4x4	01.00-07.01	51	0986 473 064	← 54	F 026 A03 454 <sup>7</sup>
				0986 474 064	→ 54	F 026 A03 454 <sup>7</sup>
	2.0 D Turbo	08.00-09.01	66	0986 473 064	← 54	F 026 A03 454 <sup>7</sup>
				0986 474 064	→ 54	F 026 A03 454 <sup>7</sup>
	2.0 D 4x4	04.97-10.99	53	0986 473 064	← 54	F 026 A03 454 <sup>7</sup>
				0986 474 064	→ 54	F 026 A03 454 <sup>7</sup>



	1.3 i 16V	04.97-10.99	63	0986 475 734	← 19
				0986 475 735	→ 19
	1.4 i 16V	10.99-09.01	71	0986 475 734	← 19
				0986 475 735	→ 19
	1.6 i 16V	04.97-09.01	79-81	0986 475 734	← 19
				0986 475 735	→ 19
	1.8 i 16V 4x4	04.97-07.01	81	0986 475 734	← 19
				0986 475 735	→ 19
	1.9 D 4x4	01.00-07.01	51	0986 475 734	← 19
				0986 475 735	→ 19
	2.0 D 4x4	04.97-10.99	53	0986 475 734	← 19
				0986 475 735	→ 19

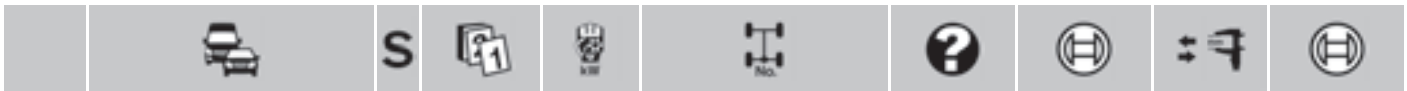

	1.3i 16V	08.98-10.99	63		0 986 473 489	← 30	F 026 A03 508 <sup>7</sup>
					0 986 474 489	→ 30	F 026 A03 508 <sup>7</sup>
	1.4i 16V	10.99-09.01	71		0 986 473 214	← 35	F 026 A03 508 <sup>7</sup>
					0 986 474 214	→ 35	F 026 A03 508 <sup>7</sup>
	1.6i 16V	08.98-10.99	79-81		0 986 473 489	← 30	F 026 A03 508 <sup>7</sup>
					0 986 474 489	→ 30	F 026 A03 508 <sup>7</sup>
		10.99-09.01	81		0 986 473 214	← 35	F 026 A03 508 <sup>7</sup>
					0 986 474 214	→ 35	F 026 A03 508 <sup>7</sup>
	1.9D 4x4	01.00-07.01	51		0 986 473 214	← 35	F 026 A03 508 <sup>7</sup>
					0 986 474 214	→ 35	F 026 A03 508 <sup>7</sup>
2.0D Turbo	08.00-09.01	66		0 986 473 214	← 35	F 026 A03 508 <sup>7</sup>	
				0 986 474 214	→ 35	F 026 A03 508 <sup>7</sup>	
2.0D 4x4	08.98-10.99	53		0 986 473 489	← 30	F 026 A03 508 <sup>7</sup>	
				0 986 474 489	→ 30	F 026 A03 508 <sup>7</sup>	

	1.3i 16V	04.97-10.99	63		1 987 477 984	296	
				TBR	1 987 477 409	← 1603	
					1 987 477 413	→ 1585	
	1.4i 16V	10.99-09.01	71		1 987 477 984	296	
				TBR	1 987 477 409	← 1603	
					1 987 477 413	→ 1585	
	1.6i 16V	04.97-09.01	79-81		1 987 477 984	296	
				TBR	1 987 477 409	← 1603	
					1 987 477 413	→ 1585	
	1.8i 16V 4x4	04.97-07.01	81		1 987 477 984	296	
1.9D 4x4	01.00-07.01	51		1 987 477 984	296		
			TBR	1 987 477 409	← 1603		
				1 987 477 413	→ 1585		
2.0D Turbo	08.00-09.01	66		1 987 477 984	296		
2.0D 4x4	04.97-10.99	53		1 987 477 984	296		
			TBR	1 987 477 409	← 1603		
				1 987 477 413	→ 1585		

**Corolla Wagon [E12]**

	1.4D Turbo	06.04-02.07	66		0 986 473 200	← 57	
					0 986 474 200	→ 57	
	1.4i	08.02-02.07	71		0 986 473 200	← 57	
					0 986 474 200	→ 57	
	1.4i 16V	10.01-05.04	71		0 986 473 196	← 57	
					0 986 474 196	→ 57	
		06.04-11.06	71		0 986 473 200	← 57	
					0 986 474 200	→ 57	
	1.6i	06.04-02.07	81		0 986 473 200	← 57	
	1.6i, i 16V	06.04-02.07	81		0 986 474 200	→ 57	
1.6i 16V	10.01-05.04	81		0 986 473 196	← 57		
				0 986 474 196	→ 57		
	06.04-11.06	81		0 986 473 200	← 57		
1.8i 16V	ABO	08.00-12.06	99			F 026 A06 149 <sup>7</sup>	
	ABS	08.00-12.06	99		0 986 473 196	← 57	
					0 986 474 196	→ 57	
2.0D Turbo	10.01-05.04	66-85				F 026 A06 149 <sup>7</sup>	
	06.04-02.07	66-85			0 986 473 200	← 57	
					0 986 474 200	→ 57	

	1.8i 16V	08.00-12.06	99		0 986 475 881	← 17,46	
					0 986 475 882	→ 17,46	



		S							
◀ TOYOTA Corolla Wagon [E12]									
	1.4 i 16V	10.01-05.04	71				0 986 473 213		← 36
							0 986 474 213		→ 36
	1.6 i 16V	10.01-05.04	81				0 986 473 213		← 36
							0 986 474 213		→ 36
	1.8 i 16V	08.00-04.04	99						F 026 A03 512 <sup>7</sup>
	2.0 D Turbo	10.01-05.04	66-85				0 986 473 213		← 36
							0 986 474 213		→ 36
	1.4 D Turbo	04.04-02.07	66				1 987 477 985		398
	1.4 i	08.02-02.07	71				1 987 477 985		398
	1.4 i 16V	10.01-05.04	71				1 987 482 306		→ 1688
							1 987 482 307		← 1616
			10.01-11.06	71			1 987 477 985		398
	1.6 i	08.02-02.07	81				1 987 477 985		398
	1.6 i 16V	10.01-05.04	81				1 987 482 306		→ 1688
							1 987 482 307		← 1616
			10.01-11.06	81			1 987 477 985		398
	1.8 i 16V	08.00-03.06	99				1 987 477 985		398
		08.00-12.06	99		4SB		1 987 482 306		→ 1688
							1 987 482 307		← 1616
	2.0 D Turbo	10.01-05.04	66-85				1 987 482 306		→ 1688
							1 987 482 307		← 1616
		10.01-02.07	66-85			1 987 477 985		398	
	1.4 D Turbo	04.04-02.07	66		LAB		0 265 006 676 <sup>3</sup>		
					RAB		0 265 006 677 <sup>3</sup>		
	1.4 i	06.04-02.07	71		LAB		0 265 006 676 <sup>3</sup>		
					RAB		0 265 006 677 <sup>3</sup>		
	1.6 i	06.04-02.07	81		LAB		0 265 006 676 <sup>3</sup>		
					RAB		0 265 006 677 <sup>3</sup>		
2.0 D Turbo	06.04-02.07	66-85		LAB		0 265 006 676 <sup>3</sup>			
				RAB		0 265 006 677 <sup>3</sup>			
<b>Corona</b>									
	1.6 i	04.93-02.98	86				1 987 477 410		→ 1727
							1 987 477 414		← 1780
	2.0 i	04.93-12.99	96				1 987 477 410		→ 1727
							1 987 477 414		← 1780
<b>Corona Sedan [T14]</b>									
	1.8	12.86-07.99	57				0 986 475 574		↔ 20,63
<b>Dyna</b>									
	2.5 D-4D	08.01-10.06	65-75		TW,ZWB		F 026 A05 993		←
							F 026 A05 995		→
	4.0	11.88-04.99	70		TW		F 026 A06 524		→
							F 026 A06 525		←
							F 026 A06 526		→
							F 026 A06 527		←
5-103	12.95-04.03	72				F 026 A02 378		→	
						F 026 A02 380		←	

		S							
7-145 4.1		05.99-04.03	100			TW	F 026 A06 524	→	
							F 026 A06 525	←	
							F 026 A06 526	→	
							F 026 A06 527	←	
	2.5 D-4D	08.01-10.06	65-75						F 026 A06 157
	3.0 D	07.01→	66						F 026 A06 120
	4.6 D	10.00-02.08	96/108						F 026 A06 160 <sup>7</sup>
	6-104/5 4.0	05.03→	77						F 026 A06 160 <sup>7</sup>
	2.5 D-4D	08.01-10.06	65-75			OZB	F 026 A02 256	↔	
	4.0	11.88-04.99	70			TW	F 026 A06 528	→	
							F 026 A06 529	←	
							F 026 A06 530	→	
							F 026 A06 531	←	
	4.6 D	10.00-06.02	96			Fg.-Nr. XZU302/342	F 026 A05 997	←	
							F 026 A05 998	←	
							F 026 A05 999	→	
							F 026 A06 000	→	
	5-103	12.95-04.03	72			TW	F 026 A02 358	→	
							F 026 A02 360	←	
							F 026 A02 382	→	
							F 026 A02 383	←	
	6-104/5 4.0	05.03→	77			TW	F 026 A05 997	←	
							F 026 A05 998	←	
							F 026 A05 999	→	
							F 026 A06 000	→	
	7-145 4.1	05.99-04.03	100			TW	F 026 A06 528	→	
							F 026 A06 529	←	
							F 026 A06 530	→	
							F 026 A06 531	←	
<b>Dyna 100</b>									
	1.8	08.87-05.95	57				0 986 473 129	← 60,23	F 026 A03 477 <sup>7</sup>
							0 986 474 129	→ 60,23	F 026 A03 477 <sup>7</sup>
	2.5 D	08.87-08.01	53/55				0 986 473 129	← 60,23	F 026 A03 477 <sup>7</sup>
							0 986 474 129	→ 60,23	F 026 A03 477 <sup>7</sup>
	1.8	08.87-05.95	57				0 986 475 657	↔ 23,8	
						STB	0 986 475 876	↔ 22,2	
						TRV	0 986 475 845	↔ 20,6	
	2.5 D	08.87-05.95	53				0 986 475 657	↔ 23,8	
			55			STB	0 986 475 876	↔ 22,2	
						TRV	0 986 475 845	↔ 20,6	
		05.95-08.01	55				0 986 475 657	↔ 23,8	
<b>Dyna 100 [Y2]</b>									
	3.0 D-4D	09.06→	80						F 026 A06 157
	3.0 D-4D	09.06→	80				F 026 A02 256	↔	





		S							
◀ TOYOTA									
<b>Dyna [150]</b>									
	4-093 3.0D	11.99-10.01	67			TW			F 026 A06 120
		11.99→	67			TW			F 026 A06 157
	4-093 3.0D	10.01→	67				F 026 A05 993	←	
							F 026 A05 995	→	
<b>Dyna 150</b>									
	2.8D	05.95-07.01	58						F 026 A06 120 <sup>7</sup>
	3.0D	05.98-08.01	65						F 026 A06 120 <sup>7</sup>
	2.8D	05.95-07.01	58			OZB	F 026 A05 989	→	
							F 026 A05 990	←	
							F 026 A05 991	→	
							F 026 A05 992	←	
	3.0D	05.98-08.01	65			OZB	F 026 A05 989	→	
							F 026 A05 990	←	
							F 026 A05 991	→	
							F 026 A05 992	←	
<b>Dyna 150 [Y2]</b>									
	3.0D-4D	09.06→	80						F 026 A06 157
	3.0D-4D	09.06→	80				F 026 A05 993	←	
							F 026 A05 995	→	
<b>Echo</b>									
	1.5 i 16V	09.99-08.00	80				0986 473 110	← 51,04	
							0986 474 110	→ 51,04	
		08.00→	80				0986 473 211	← 51	
							0986 474 211	→ 51	
		06.03→	78				0986 473 211	← 51	
							0986 474 211	→ 51	
	1.5 i 16V	09.99→	78/80				0986 475 881	← 17,46	
							0986 475 882	→ 17,46	
	1.5 i 16V	09.99→	78/80				1987 477 543	→ 1503	
							1987 477 548	← 1548	





**Estima**

		2.4 i	01.06→	125					
						F 01G 260 045	→	F 01G 060 0UK <sup>7</sup>	
						F 01G 260 046	←	F 01G 060 0UK <sup>7</sup>	
		2.4 i	01.06→	125					
						F 01G 260 047	→	F 01G 060 0UN <sup>7</sup>	
						F 01G 260 048	←	F 01G 060 0UN <sup>7</sup>	

**Fortuner**

		2.7 i 4WD	06.04→	118	TW				F 026 A06 116 <sup>7</sup>
			02.06→	118	VSP				F 026 A06 115 <sup>7</sup>
			OFD 06.04→	118	TW				F 026 A06 155 <sup>7</sup>
		4.0 i 4WD	05.06→	175	TW				F 026 A06 116 <sup>7</sup>
		2.7 i 4WD	06.04→	118	TW	F 026 A06 012	↔		
		3.0 D Turbo 4WD	11.04→	120		F 026 A06 012	↔		
		4.0 i 4WD	05.06→	175		F 026 A06 012	↔		

**Funcargo**

		1.3 i	08.99-09.05	64-65					
						0 986 473 211	↔	← 51	
						0 986 474 211	↔	→ 51	
		1.3 i	08.99-09.05	64-65					
						0 986 475 881	↔	← 17,46	
						0 986 475 882	↔	→ 17,46	

**Hiace**

		2.2 Super 16 & 12 Commuter	11.92-12.07	75					
						0 986 473 129	↔	← 60,23	F 026 A03 477 <sup>7</sup>
						0 986 474 129	↔	→ 60,23	F 026 A03 477 <sup>7</sup>
		2.5 D Turbo	08.01→	75					
						0 986 473 224	↔	← 67	F 026 A06 163 <sup>7</sup>
						0 986 474 224	↔	→ 67	F 026 A06 163 <sup>7</sup>
		2.5 D Turbo	08.01→	75		F 026 A06 937	↔		

**Hiace Commuter**

		2.5 D Turbo	01.05-09.07	80					
						0 986 AB8 140	↔	↔ 22,23	
		3.0 D Turbo	01.05→	80		F 026 A06 937	↔		





































**Hiace [H2]**

		2.7	01.05→	111					
						0 986 473 224	↔	← 67	F 026 A06 163 <sup>7</sup>
						0 986 474 224	↔	→ 67	F 026 A06 163 <sup>7</sup>



		S				?			
◀ TOYOTA Hiace [H2]									
	2.7	01.05→	111				F 026 A06 937	↔	
<b>Hiace [KLH]</b>									
	2.5 D Turbo 4x4	08.01→	65				0986 473 224	← 67	F 026 A06 163 <sup>7</sup>
							0986 474 224	→ 67	F 026 A06 163 <sup>7</sup>
	2.5 D-4D	08.01→	70-86				0986 473 224	← 67	F 026 A06 163 <sup>7</sup>
							0986 474 224	→ 67	F 026 A06 163 <sup>7</sup>
	2.5 D-4D 4x4	08.01→	70-86						F 026 A06 163 <sup>7</sup>
	2.5 D Turbo 4x4, D-4D, D-4D 4x4	08.01→	65/70-86				F 026 002 385	↔ 25,4	
<b>Hiace [LXH]</b>									
	2.4 D	08.95-08.01	62				0986 473 224	← 67	F 026 A03 503 <sup>7</sup>
							0986 474 224	→ 67	F 026 A03 503 <sup>7</sup>
	2.4 D Turbo	08.95-08.01	66				0986 473 224	← 67	F 026 A03 503 <sup>7</sup>
							0986 474 224	→ 67	F 026 A03 503 <sup>7</sup>
	2.4 D Turbo 4WD	08.96-08.01	66						F 026 A03 503 <sup>7</sup>
	2.4 D	08.95-08.01	62				F 026 002 385	↔ 25,4	
	2.4 D Turbo	08.95-08.01	66				F 026 002 385	↔ 25,4	
	2.4 D Turbo 4WD	08.96-08.01	66				F 026 002 385	↔ 25,4	
<b>Hiace [RCH]</b>									
	2.4	03.97-11.08	85				0986 473 224	← 67	F 026 A06 583 <sup>6</sup>
	2.4	08.95-11.08	85				0986 473 224	← 67	F 026 A06 163 <sup>7</sup>
	2.4 i						0986 474 224	→ 67	F 026 A06 583 <sup>6</sup>
	2.4 i	08.95-11.08	85				0986 473 224	← 67	F 026 A06 583 <sup>6</sup>
		08.96-04.98	85				0986 474 224	→ 67	F 026 A06 163 <sup>7</sup>
	2.4 i 4WD	08.96-04.98	85						F 026 A03 503 <sup>7</sup>
	2.7	04.98-05.09	105				0986 473 224	← 67	F 026 A06 163 <sup>7</sup>
							0986 473 224	← 67	F 026 A06 583 <sup>6</sup>
							0986 474 224	→ 67	F 026 A06 163 <sup>7</sup>
	2.7	04.98-05.09	105						F 026 A06 163 <sup>7</sup>
	2.7 4x4								F 026 A06 583 <sup>6</sup>
	2.4	03.97-11.08	85				F 026 002 385	↔ 25,4	
	2.4 i	08.95-11.08	85				F 026 002 385	↔ 25,4	
	2.4 i 4WD	08.96-04.98	85				F 026 002 385	↔ 25,4	
	2.7, 4x4	04.98-05.09	105				F 026 002 385	↔ 25,4	
<b>Hiace Van [LH]</b>									
	2.4 D	08.89-01.05	62				F 026 A02 084	→	
	2.4 D 4x4	08.89-08.95	62				F 026 A02 084	→	
	2.8 D	08.89-08.00	58				F 026 A02 084	→	





































		S							
	2.4D	08.89-01.05	62			TW			F 026 A03 458 <sup>7</sup>
		05.94-01.05	62			TW			F 026 A03 503 <sup>7</sup>
							0 986 473 224	 ← 67	
							0 986 474 224	 → 67	
	2.4D 4x4	08.89-08.95	62				0 986 473 224	 ← 67	F 026 A03 503 <sup>7</sup>
						0 986 474 224	 → 67	F 026 A03 503 <sup>7</sup>	
2.8D	08.89-08.00	58					0 986 473 224	 ← 67	F 026 A03 503 <sup>7</sup>
							0 986 474 224	 → 67	F 026 A03 503 <sup>7</sup>
									
	2.4D	08.89-07.96	62			STB	0 986 475 657	↔ 23,8	
						TBR	0 986 475 727	↔ 23,81	
	2.4D 4x4	08.89-08.95	62				0 986 475 657	↔ 23,8	
2.8D	08.89-07.96	58				0 986 475 657	↔ 23,8		
<b>Hiace Van [LXH]</b>									
									
	2.4D Turbo	08.96-08.01	66						F 026 A03 503 <sup>7</sup>
									
	2.4D Turbo	08.96-08.01	66				F 026 002 385	↔ 25,4	
<b>Hiace Van [ZH]</b>									
									
	2.0	08.89-09.02	74				F 026 A02 084	→	
									
	2.0	08.89-07.95	74				0 986 475 657	↔ 23,8	
		2.4, i, i 4WD	08.89-07.95	84/88				0 986 475 657	↔ 23,8
<b>Hiace Wagon</b>									
									
	3.0D Turbo 4WD	08.93-05.96	96				F 026 A02 256	↔	
		06.96-07.04	96				F 026 002 348	↔ 23,81	
<b>Hiace Wagon [LH]</b>									
									
	2.4D	08.89-02.06	62				F 026 A02 084	→	
		2.8D	08.89-08.00	58				F 026 A02 084	→
	2.4D	08.89-02.06	62			TW			F 026 A03 458 <sup>7</sup>
		05.94-02.06	62			TW			F 026 A03 503 <sup>7</sup>
							0 986 473 224	 ← 67	
							0 986 474 224	 → 67	
	2.8D	08.89-08.00	58				0 986 473 224	 ← 67	F 026 A03 503 <sup>7</sup>
						0 986 474 224	 → 67	F 026 A03 503 <sup>7</sup>	
3.0D	08.98-02.06	65/75				TW			F 026 A03 458 <sup>7</sup>
									F 026 A03 503 <sup>7</sup>
						0 986 473 224	 ← 67		
						0 986 474 224	 → 67		



		S							
◀ TOYOTA Hiace Wagon [LH]									
	2.4D	08.89-07.96	62			STB	0986 475 657	↔ 23,8	
						TBR	0986 475 727	↔ 23,81	
	2.8D	08.89-07.96	58				0986 475 657	↔ 23,8	
	3.0D	08.98-02.06	65				F 026 A02 256	↔	
Hiace Wagon [ZH]									
	2.4 i	08.89-09.02	88				F 026 A02 084	→	
	2.4 i	08.89-07.95	88				0986 475 657	↔ 23,8	
Hilux									
	2.0	10.98-12.02	68			TW			F 026 A03 477
							0986 473 129	↔ 60,23	F 026 A03 477 <sup>7</sup>
							0986 474 129	↔ 60,23	F 026 A03 477 <sup>7</sup>
	2.2 4x4	02.86-06.94	70				0986 473 129	↔ 60,23	
							0986 474 129	↔ 60,23	
	2.4D	03.88-06.94	55				0986 473 129	↔ 60,23	
							0986 474 129	↔ 60,23	
	2.4D Turbo	05.95-12.00	64						F 026 A03 477
	2.5 4x4	08.08-07.11	106						F 026 A06 155 <sup>7</sup>
	3.0 TD	01.02-02.05	85				F 026 A03 330	→ 42,8	F 026 A08 112 <sup>7</sup>
							0986 474 067	↔	
							F 026 A03 331	← 42,8	F 026 A08 112 <sup>7</sup>
							0986 473 067	↔	
	1.8	11.86-08.98	59				0986 AB8 142	↔ 22,23	
	2.0	10.98-12.02	68				F 026 002 385	↔ 25,4	
	2.4D Turbo	05.95-12.00	64				F 026 002 385	↔ 25,4	
	2.5 16VD Turbo	03.05-12.11	75				0986 AB8 130	↔ 22,23	
	2.5 4x4	08.08-07.11	106				F 026 A06 012	↔	
	3.0 TD	01.02-02.05	85				0986 BB3 003	↔	
Hilux [Africa]									
	3.0 D 4x4	01.98-→	67						F 026 A08 112 <sup>7</sup>
Hilux [N5/N6]									
	1.6	08.86-07.98	50				F 026 A02 082	→	
							F 026 A02 083	←	
	2.2	08.86-07.98	75				F 026 A02 082	→	
							F 026 A02 083	←	
	2.4D	08.84-07.98	62				F 026 A02 082	→	
							F 026 A02 083	←	
	2.8D	08.95-07.98	58				F 026 A02 082	→	
							F 026 A02 083	←	



		S							
	1.6	08.86-07.98	50				0 986 473 129	 ← 60,23	
							0 986 474 129	 → 60,23	
	2.2	08.86-07.98	75				0 986 473 129	 ← 60,23	
							0 986 474 129	 → 60,23	
	2.4	08.84-07.98	62/80				0 986 473 129	 ← 60,23	
	2.4D						0 986 474 129	 → 60,23	
	2.8D	08.95-07.98	58				0 986 473 129	 ← 60,23	
							0 986 474 129	 → 60,23	
<b>Hilux [N14/N15]</b>									
									
	2.7	08.97-03.06	108				0 986 473 129	 ← 60,23	F 026 A03 477 <sup>7</sup>
							0 986 474 129	 → 60,23	F 026 A03 477 <sup>7</sup>
									
	2.7	08.97-03.06	108				F 026 002 385	↔ 25,4	
<b>Hilux [N15]</b>									
									
	2.5 D-4D	07.05-08.11	75		TW				F 026 A06 152 <sup>7</sup>
		07.05→	88-106		TW				F 026 A06 152 <sup>7</sup>
									
	2.5 D-4D	07.05-08.11	75		TW		F 026 A06 011	↔	
			88-106		TW		F 026 A06 011	↔	
		03.08→	88-106				F 026 A06 011	↔	
<b>Hilux [N25]</b>									
									
	2.5 D-4D 4x4	MFD 07.05→	75/88-106		TW				F 026 A06 116 <sup>7</sup>
		OFD 07.05-08.11	88-106		TW				F 026 A06 155 <sup>7</sup>
		07.11→	75		TW				F 026 A06 155 <sup>7</sup>
			106		TW				F 026 A06 155 <sup>7</sup>
									
	2.5 D-4D 4x4	07.05→	75/88-106		TW		F 026 A06 012	↔	
<b>Hilux [N26]</b>									
									
	3.0 D Turbo 4x4	OFD 03.05→	120		TW				F 026 A06 155 <sup>7</sup>
	3.0 D Turbo 4x4, D-4D 4x4	MFD 03.05→	120-126		TW				F 026 A06 116 <sup>7</sup>
	3.0 D-4D 4x4	OFD 10.06-08.11	120-126		TW				F 026 A06 155 <sup>7</sup>
		07.11→	120		TW				F 026 A06 155 <sup>7</sup>
			126		TW				F 026 A06 155 <sup>7</sup>
									
	3.0 D Turbo 4x4	03.05→	120-126		TW		F 026 A06 012	↔	
	3.0 D-4D 4x4								









































		S							
◀ TOYOTA									
<b>Hilux [N35]</b>									
	2.5 D-4D	MFD 07.11→ OFD 07.11→	75/106 75 106		TW TW TW				F 026 A06 116 <sup>7</sup> F 026 A06 155 <sup>7</sup> F 026 A06 155 <sup>7</sup>
	2.5 D-4D	07.11→	75/106		TW	F 026 A06 012	↔		
<b>Hilux Pickup [N8]</b>									
	1.8	01.89-10.94	57			0986 473 129 0986 474 129	← 60,23 → 60,23	F 026 A03 477 <sup>7</sup> F 026 A03 477 <sup>7</sup>	
	1.8	01.89-10.94	57			0986 475 876	↔ 22,2		
<b>Hilux Pickup [N8...13]</b>									
	1.8	08.88-08.94	57			0986 473 129 0986 474 129	← 60,23 → 60,23	F 026 A03 477 <sup>7</sup> F 026 A03 477 <sup>7</sup>	
	2.2 4WD	08.88-08.94	69			F 026 A03 330 0986 474 067	→ 42,8 	F 026 A08 112 <sup>7</sup> F 026 A08 112 <sup>7</sup>	
	2.4 D	08.88-07.97	62			F 026 A03 330 0986 474 067	→ 42,8 	F 026 A08 112 <sup>7</sup> F 026 A08 112 <sup>7</sup>	
	2.4 D	08.88-08.97	62			0986 473 129 0986 474 129	← 60,23 → 60,23	F 026 A03 477 <sup>7</sup> F 026 A03 477 <sup>7</sup>	
	2.4 D	08.88-08.97	62			F 026 A03 331 0986 473 067	← 42,8 	F 026 A08 112 <sup>7</sup> F 026 A08 112 <sup>7</sup>	
	2.4 D 4x4	09.88-08.97	62			F 026 A03 330 0986 474 067	→ 42,8 	F 026 A08 112 <sup>7</sup> F 026 A08 112 <sup>7</sup>	
	2.4 D 4x4	01.94-12.97	58			F 026 A03 330 0986 474 067	→ 42,8 	F 026 A08 112 <sup>7</sup> F 026 A08 112 <sup>7</sup>	
	2.4 D	08.88-08.97	62			0986 473 067		F 026 A08 112 <sup>7</sup>	
	2.4 i 4WD	09.88-08.97	84			F 026 A03 330 0986 474 067	→ 42,8 	F 026 A08 112 <sup>7</sup> F 026 A08 112 <sup>7</sup>	
	2.4 i 4x4	09.88-08.97	84			F 026 A03 331 0986 473 067	← 42,8 	F 026 A08 112 <sup>7</sup> F 026 A08 112 <sup>7</sup>	
	1.8	08.88-08.94	57			0986 475 876	↔ 22,2		
	2.2 4WD	08.88-08.94	69			0986 475 894	↔ 22,2		
	2.4 D	08.88-07.97	62			0986 475 894	↔ 22,2		
	2.4 D	08.88-08.97	62			0986 475 876	↔ 22,2		
	2.4 D 4x4	09.88-08.97	62			0986 475 894	↔ 22,2		
	2.4 i 4WD, i 4x4	09.88-08.97	84			0986 475 894	↔ 22,2		
<b>Hilux Pickup [N14...19]</b>									
	2.4 D	08.97-08.01	62			0986 473 129 0986 474 129	← 60,23 → 60,23	F 026 A03 477 <sup>7</sup> F 026 A03 477 <sup>7</sup>	



		S							
	2.4 D Turbo, i, i 4WD	08.97-08.01	66/79/104						F 026 A08 112 <sup>7</sup>
	2.5 D Turbo 4x4	08.01-08.05	65/75	Fg.-Nr. *KDN145*, Fg.-Nr. *KDN150*			0 986 473 129	← 60,23	F 026 A03 477 <sup>7</sup>
				Fg.-Nr. *KDN165*, Fg.-Nr. *KDN170*, Fg.-Nr. *KDN190*			0 986 474 129	→ 60,23	F 026 A03 477 <sup>7</sup>
									F 026 A08 112 <sup>7</sup>
	2.4 D	08.97-08.01	62				F 026 002 385	↔ 25,4	
	2.5 D Turbo 4x4	08.01-08.05	65/75	Fg.-Nr. *KDN145*, Fg.-Nr. *KDN150*			F 026 002 385	↔ 25,4	
<b>Hilux [Raider]</b>									
	2.7 i VVTi 4x4	06.05→	119				F 026 A06 012	↔	
<b>Hilux Vigo</b>									
	2.5 D Turbo	07.02→	76				F 026 A06 011	↔	
							0 986 AB8 134	↔ 23,81	
	2.5 D Turbo 4x4	10.04→	75-76				0 986 AB8 134	↔ 23,81	
<b>Hilux Wagon [N8...13]</b>									
	2.4 D Turbo	01.90-11.95	69				F 026 A02 256	↔	
	3.0 D, i	08.89-11.95	92/105				F 026 A02 256	↔	
<b>iQ</b>									
	EV	09.12→	47						F 026 A06 218 <sup>7</sup>
	1.0	11.08-05.14	50				0 986 475 881	← 17,46	
							0 986 475 882	→ 17,46	
	1.3 VVT-i	05.09-05.14	72				0 986 475 881	← 17,46	
							0 986 475 882	→ 17,46	
	1.4	11.08-05.12	66				0 986 475 881	← 17,46	
							0 986 475 882	→ 17,46	
	1.0	11.08-05.14	50				0 986 134 237	←	
							0 986 135 237	→	
	1.3 VVT-i	05.09-05.14	72				0 986 134 237	←	
							0 986 135 237	→	
	1.4	11.08-05.12	66				0 986 134 237	←	
							0 986 135 237	→	
	1.0	11.08-05.14	50				1 987 482 346	1698	
	1.3 VVT-i	05.09-05.14	72				1 987 482 346	1698	
	1.4	11.08-05.12	66				1 987 482 346	1698	
<b>Isis</b>									
	2.0 i	09.04-09.09	114						F 026 A03 538 <sup>7</sup>





								
<b>◀ TOYOTA</b>								
<b>Ist</b>								
								
	<b>1.3i</b>	04.02-07.07	64			0986 <b>473 211</b>	 ← 51	
						0986 <b>474 211</b>	 → 51	
								
	<b>1.3i</b>	04.02-07.07	64			0986 <b>475 881</b>	← 17,46	
						0986 <b>475 882</b>	→ 17,46	
								
	<b>1.3i</b>	04.02-07.07	64			1987 <b>477 543</b>	→ 1503	
						1987 <b>477 548</b>	← 1548	
<b>Kluger</b>								
								
	<b>3.3i</b>	10.03→	172					F 026 <b>A06 114</b> <sup>7</sup>
								
	<b>3.3i</b>	10.03→	172					F 026 <b>A06 217</b> <sup>7</sup>
<b>Land Cruiser</b>								
								
	<b>3.0D Turbo 4x4</b>	01.05-10.09	98			0986 <b>134 312</b>	 ←	F 026 <b>A06 116</b> <sup>7</sup>
						0986 <b>135 312</b>	 →	F 026 <b>A06 116</b> <sup>7</sup>
	<b>4.2D</b>	12.91-03.00	96			F 026 <b>A03 330</b>	→ 42,8	F 026 <b>A08 112</b> <sup>7</sup>
						0986 <b>474 067</b>		
						F 026 <b>A03 331</b>	← 42,8	F 026 <b>A08 112</b> <sup>7</sup>
						0986 <b>473 067</b>		
	<b>4.5 24V</b>	04.92-01.98				F 026 <b>A03 330</b>	→ 42,8	F 026 <b>A08 112</b> <sup>7</sup>
						0986 <b>474 067</b>		
						F 026 <b>A03 331</b>	← 42,8	F 026 <b>A08 112</b> <sup>7</sup>
						0986 <b>473 067</b>		
								
	<b>4.2D</b>	12.91-03.00	96			0986 <b>475 877</b>	↔ 25,4	
	<b>4.5 24V</b>	04.92-01.98				0986 <b>475 877</b>	↔ 25,4	
	<b>3.0D Turbo 4x4</b>	01.05-10.09	98			0986 <b>134 250</b>	 ←	F 026 <b>A08 119</b> <sup>7</sup>
						0986 <b>135 250</b>	 →	F 026 <b>A08 119</b> <sup>7</sup>
<b>Land Cruiser [J2]</b>								
								
	<b>5.7 4x4</b>	09.07→	280					F 026 <b>A06 612</b>
								
	<b>5.7 4x4</b>	09.07→	280					F 026 <b>A07 001</b> <sup>7</sup>



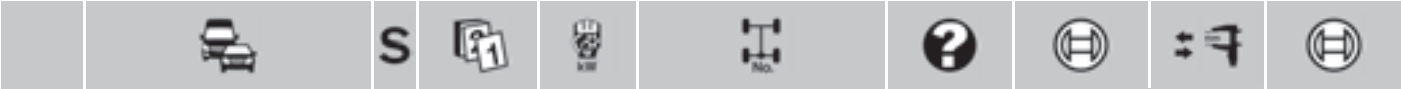

**Land Cruiser [J6/7/10]**



	4.5 4x4	03.98-04.05	158		F 026 <b>009 877</b>	↔ 25,4	
		10.99-02.07	165		0 986 <b>475 877</b>	↔ 25,4	

**Land Cruiser [J7]**



	2.4 D Turbo	10.85-04.96	63/69/81/		F 026 <b>A03 330</b>	→ 42,8	F 026 <b>A08 112</b> <sup>7</sup>
	2.4 i		84		0 986 <b>474 067</b>	↺	
					F 026 <b>A03 331</b>	← 42,8	F 026 <b>A08 112</b> <sup>7</sup>
					0 986 <b>473 067</b>	↺	
	3.0 D Turbo	05.93-04.96	92		F 026 <b>A03 330</b>	→ 42,8	F 026 <b>A08 112</b> <sup>7</sup>
					0 986 <b>474 067</b>	↺	
					F 026 <b>A03 331</b>	← 42,8	F 026 <b>A08 112</b> <sup>7</sup>
					0 986 <b>473 067</b>	↺	
	3.4 D	11.84-02.94	66		F 026 <b>A03 330</b>	→ 42,8	F 026 <b>A08 112</b> <sup>7</sup>
					0 986 <b>474 067</b>	↺	
					F 026 <b>A03 331</b>	← 42,8	F 026 <b>A08 112</b> <sup>7</sup>
					0 986 <b>473 067</b>	↺	
	4.2 D	01.90-08.01	96-99		F 026 <b>A03 330</b>	→ 42,8	F 026 <b>A08 112</b> <sup>7</sup>
					0 986 <b>474 067</b>	↺	
					F 026 <b>A03 331</b>	← 42,8	F 026 <b>A08 112</b> <sup>7</sup>
					0 986 <b>473 067</b>	↺	
	4.2 D	08.99→	96		F 026 <b>A03 332</b>	←	F 026 <b>A03 464</b>
	4.2 D 4x4				F 026 <b>A03 333</b>	→	F 026 <b>A03 464</b>
	4.5	01.07→	165		F 026 <b>A03 332</b>	←	F 026 <b>A03 464</b> <sup>7</sup>
					F 026 <b>A03 333</b>	→	F 026 <b>A03 464</b> <sup>7</sup>



	2.4 D Turbo	06.93-08.94	69		0 986 <b>475 877</b>	↔ 25,4	
	2.4 i	12.88-04.96	84		0 986 <b>475 877</b>	↔ 25,4	
	3.0 D Turbo	05.93-04.96	92		0 986 <b>475 877</b>	↔ 25,4	
	3.4 D	01.90-02.94	66		0 986 <b>475 877</b>	↔ 25,4	
	4.2 D, D 4x4	01.90→	96-99		0 986 <b>475 877</b>	↔ 25,4	
	4.5	01.07→	165		0 986 <b>475 877</b>	↔ 25,4	
	4.5 4x4	03.07→	151		0 986 <b>475 877</b>	↔ 25,4	



	2.4 D Turbo	10.85-04.96	63/69/81/		F 026 <b>A03 326</b>	→	F 026 <b>A08 119</b> <sup>7</sup>
	2.4 i		84		F 026 <b>A03 327</b>	←	F 026 <b>A08 119</b> <sup>7</sup>
	3.0 D Turbo	05.93-04.96	92		F 026 <b>A03 326</b>	→	F 026 <b>A08 119</b> <sup>7</sup>
					F 026 <b>A03 327</b>	←	F 026 <b>A08 119</b> <sup>7</sup>
	3.4 D	11.84-02.94	66		F 026 <b>A03 326</b>	→	F 026 <b>A08 119</b> <sup>7</sup>
					F 026 <b>A03 327</b>	←	F 026 <b>A08 119</b> <sup>7</sup>
	4.2 D	01.90→	96-99		F 026 <b>A03 326</b>	→	F 026 <b>A08 119</b> <sup>7</sup>
	4.2 D 4x4				F 026 <b>A03 327</b>	←	F 026 <b>A08 119</b> <sup>7</sup>
	4.5 4x4	03.07→	151		F 026 <b>A03 326</b>	→	F 026 <b>A08 119</b> <sup>7</sup>
					F 026 <b>A03 327</b>	←	F 026 <b>A08 119</b> <sup>7</sup>

**Land Cruiser [J7/10]**



	4.2 D 4x4	03.98-10.07	96				
				TW	F 026 <b>A03 264</b>	→	F 026 <b>A03 520</b>
					F 026 <b>A03 265</b>	←	F 026 <b>A03 520</b>
					F 026 <b>A07 970</b>	→	F 026 <b>A03 521</b>
					F 026 <b>A07 971</b>	←	F 026 <b>A03 521</b>
		08.99-02.07	96		F 026 <b>A03 332</b>	←	F 026 <b>A03 464</b>
					F 026 <b>A03 333</b>	→	F 026 <b>A03 464</b>



		S				?			
<b>← TOYOTA Land Cruiser [J7/10]</b>									
	4.2 D 4x4	03.99-02.07	96				0986 475 877	↔ 25,4	
	4.2 D 4x4	03.98-10.07	96				F 026 A03 326	→	F 026 A08 119 <sup>7</sup>
							F 026 A03 327	←	F 026 A08 119 <sup>7</sup>
<b>Land Cruiser [J8]</b>									
	4.2 D	01.90-01.98	99						F 026 A08 118 <sup>7</sup>
		09.92-06.95	99				F 026 A03 337	←	
							F 026 A03 339	→	
		07.95-01.98	99				F 026 A03 335	→	
							F 026 A03 338	←	
	4.2 D Turbo	01.90-01.95	118-125						F 026 A08 118 <sup>7</sup>
		09.92-01.95	118-125				F 026 A03 337	←	
							F 026 A03 339	→	
	4.2 24V D Turbo	01.95-06.95	125						
		01.95-01.98	125				F 026 A03 337	←	
		07.95-01.98	125				F 026 A03 339	→	F 026 A08 118 <sup>7</sup>
							F 026 A03 335	→	
							F 026 A03 338	←	
	4.5 i 24V	08.92-01.98	151-158						F 026 A08 118 <sup>7</sup>
		09.92-06.95	151-158				F 026 A03 337	←	
							F 026 A03 339	→	
		07.95-01.98	151-158				F 026 A03 335	→	
							F 026 A03 338	←	
<b>T</b>									
	4.2 D	01.90-01.98	99				0986 475 877	↔ 25,4	
	4.5 i 24V	08.92-01.98	151-158				0986 475 877	↔ 25,4	
	4.2 D	01.90-01.95	99/118-125				F 026 A03 326	→	F 026 A08 119 <sup>7</sup>
	4.2 D Turbo						F 026 A03 327	←	F 026 A08 119 <sup>7</sup>
	4.2 24V D Turbo	01.95-01.98	125				F 026 A03 326	→	F 026 A08 119 <sup>7</sup>
							F 026 A03 327	←	F 026 A08 119 <sup>7</sup>
	4.5 i 24V	08.92-01.98	151-158				F 026 A03 326	→	F 026 A08 119 <sup>7</sup>
							F 026 A03 327	←	F 026 A08 119 <sup>7</sup>
<b>Land Cruiser [J9]</b>									
	2.7 i 16V	10.96-12.06	97-112						F 026 A03 513 <sup>7</sup>
	2.8 D	04.96-09.02	58						F 026 A03 513 <sup>7</sup>
	3.0 D Turbo, D Turbo Interc.	04.96-12.06	88-92/120						F 026 A03 513 <sup>7</sup>
	3.4 i 24V	04.96-12.06	131-136						F 026 A03 513 <sup>7</sup>
	2.7 i 16V	10.96-12.06	97-112				F 026 002 348	↔ 23,81	
	2.8 D	04.96-09.02	58				F 026 A06 538	↔	
	3.0 D Turbo, D Turbo Interc.	04.96-12.06	88-92				F 026 A06 538	↔	
	2.7 i 16V	10.96-12.06	97-112				F 026 A03 326	→	F 026 A08 119 <sup>7</sup>
							F 026 A03 327	←	F 026 A08 119 <sup>7</sup>
	2.8 D	04.96-09.02	58				F 026 A03 326	→	F 026 A08 119 <sup>7</sup>
							F 026 A03 327	←	F 026 A08 119 <sup>7</sup>
	3.0 D Turbo	04.96-12.06	88-92/120				F 026 A03 326	→	F 026 A08 119 <sup>7</sup>
	3.0 D Turbo Interc.						F 026 A03 327	←	F 026 A08 119 <sup>7</sup>



































		<b>S</b>				<b>?</b>			
3.4i 24V							F 026 <b>A03 326</b>	→	F 026 <b>A08 119</b> <sup>7</sup>
							F 026 <b>A03 327</b>	←	F 026 <b>A08 119</b> <sup>7</sup>
<b>Land Cruiser [J10]</b>									
	<b>4.2 D Turbo 4x4</b>	01.98-07.08	122-150			TW	F 026 <b>A03 264</b>	→	F 026 <b>A03 520</b>
							F 026 <b>A03 265</b>	←	F 026 <b>A03 520</b>
							F 026 <b>A07 970</b>	→	F 026 <b>A03 521</b>
							F 026 <b>A07 971</b>	←	F 026 <b>A03 521</b>
	<b>4.5</b>	03.98→	165			TW	F 026 <b>A03 264</b>	→	F 026 <b>A03 520</b>
							F 026 <b>A03 265</b>	←	F 026 <b>A03 520</b>
							F 026 <b>A07 970</b>	→	F 026 <b>A03 521</b>
							F 026 <b>A07 971</b>	←	F 026 <b>A03 521</b>
	<b>4.7 i 32V 4x4</b>	01.98-07.08	173			TW	F 026 <b>A03 264</b>	→	F 026 <b>A03 520</b>
							F 026 <b>A03 265</b>	←	F 026 <b>A03 520</b>
							F 026 <b>A07 970</b>	→	F 026 <b>A03 521</b>
							F 026 <b>A07 971</b>	←	F 026 <b>A03 521</b>
	<b>4.2 D Turbo 4x4</b>	01.98-07.08	122-150				0 986 <b>475 877</b>	↔ 25,4	
	<b>4.7 i 32V 4x4</b>	01.98-07.08	173				0 986 <b>475 877</b>	↔ 25,4	
	<b>4.2 D Turbo 4x4</b>	01.98-12.02	122-150						F 026 <b>A03 491</b> <sup>7</sup>
	<b>4.7 i 32V 4x4</b>	01.98-12.02	173						F 026 <b>A03 491</b> <sup>7</sup>
<b>Land Cruiser [J12]</b>									
	<b>3.0 D-4D</b>	09.02-08.09	120				0 986 <b>134 312</b>	←	F 026 <b>A06 116</b> <sup>7</sup>
							0 986 <b>135 312</b>	→	F 026 <b>A06 116</b> <sup>7</sup>
	<b>4.0</b>	09.02-08.05	183				0 986 <b>134 312</b>	←	
		09.05→	183				0 986 <b>134 312</b>	←	F 026 <b>A06 116</b> <sup>7</sup>
							0 986 <b>135 312</b>	→	F 026 <b>A06 116</b> <sup>7</sup>
	<b>4.0 i 24V</b>	01.03-08.09	183				0 986 <b>134 312</b>	←	F 026 <b>A06 116</b> <sup>7</sup>
							0 986 <b>135 312</b>	→	F 026 <b>A06 116</b> <sup>7</sup>
	<b>3.0 D-4D</b>	09.02-08.09	120				0 986 <b>134 250</b>	←	F 026 <b>A08 119</b> <sup>7</sup>
							0 986 <b>135 250</b>	→	F 026 <b>A08 119</b> <sup>7</sup>
	<b>4.0</b>	09.02→	183				0 986 <b>134 250</b>	←	F 026 <b>A08 119</b> <sup>7</sup>
							0 986 <b>135 250</b>	→	F 026 <b>A08 119</b> <sup>7</sup>
	<b>4.0 i 24V</b>	01.03-08.09	183				0 986 <b>134 250</b>	←	F 026 <b>A08 119</b> <sup>7</sup>
							0 986 <b>135 250</b>	→	F 026 <b>A08 119</b> <sup>7</sup>
<b>Land Cruiser [J15]</b>									
	<b>3.0 D-4D</b>	08.09→	120-140				0 986 <b>134 250</b>	←	F 026 <b>A08 119</b> <sup>7</sup>
							0 986 <b>135 250</b>	→	F 026 <b>A08 119</b> <sup>7</sup>
	<b>4.0</b>	08.09→	202				0 986 <b>134 250</b>	←	F 026 <b>A08 119</b> <sup>7</sup>
	<b>4.0 i 24V</b>						0 986 <b>135 250</b>	→	F 026 <b>A08 119</b> <sup>7</sup>
<b>Land Cruiser [J20]</b>									
	<b>4.5 D-4D 4x4</b>	09.07→	195-210						F 026 <b>A06 612</b>
		04.10→	173						F 026 <b>A06 612</b> <sup>7</sup>
	<b>4.6</b>	01.12→	227-234						F 026 <b>A06 612</b> <sup>7</sup>
	<b>4.7, i 4x4</b>	08.07-01.12	212						F 026 <b>A06 612</b> <sup>7</sup>

		S							
◀ TOYOTA Land Cruiser [J20]									
	4.5 D-4D 4x4	09.07→	195-210						F 026 A07 001
		04.10→	173						F 026 A07 001 <sup>7</sup>
	4.6	01.12→	227-234						F 026 A07 001
	4.7	08.07-01.12	212						F 026 A07 001 <sup>7</sup>
	4.7 i 4x4	09.07-01.12	212						F 026 A07 001
<b>Land Cruiser Prado</b>									
	4.0	08.07→	202						F 026 A06 612 <sup>7</sup>
	4.0	08.07→	202						F 026 A07 001 <sup>7</sup>
<b>Land Cruiser Prado [J9]</b>									
	2.7 i 16V 4x4	10.96-09.04	112						F 026 A03 513 <sup>7</sup>
	3.4 i 24V, 4x4	04.96-09.03	131-136/142						F 026 A03 513 <sup>7</sup>
	2.7 i 16V 4x4	10.96-09.04	112			F 026 A06 538	↔		
	2.7 i 16V 4x4	10.96-09.04	112			F 026 A03 326	→	F 026 A08 119 <sup>7</sup>	
						F 026 A03 327	←	F 026 A08 119 <sup>7</sup>	
	3.4 i 24V	04.96-09.03	131-136/			F 026 A03 326	→	F 026 A08 119 <sup>7</sup>	
	3.4 4x4		142			F 026 A03 327	←	F 026 A08 119 <sup>7</sup>	
<b>Land Cruiser Prado [J12]</b>									
	2.7 i 4x4	08.04-09.09	120			0986 134 312	←	F 026 A06 116 <sup>7</sup>	
						0986 135 312	→	F 026 A06 116 <sup>7</sup>	
	4.0 i	01.03→	179			0986 134 312	←		
						0986 135 312	→		
	2.7 i 4x4	08.04-09.09	120			0986 134 250	←	F 026 A08 119 <sup>7</sup>	
						0986 135 250	→	F 026 A08 119 <sup>7</sup>	
	4.0 i	01.03→	179			0986 134 250	←	F 026 A08 119 <sup>7</sup>	
						0986 135 250	→	F 026 A08 119 <sup>7</sup>	
<b>Land Cruiser [105]</b>									
	4.5 i 24V	01.98→	165			F 026 A03 264	→	F 026 A03 521	
						F 026 A03 265	←	F 026 A03 521	
	4.5 i 24V	01.98→	165			0986 475 877	↔ 25,4		
	4.5 i 24V	01.98→	165			F 026 A03 326	→	F 026 A08 119	
						F 026 A03 327	←	F 026 A08 119	

T

		S				?			
<b>Limo</b>									
	1.5 i	05.04→	80				0 986 475 881	← 17,46	
							0 986 475 882	→ 17,46	
	1.5 i	05.04→	80				0 986 473 210	← 30	
							0 986 474 210	→ 30	
	1.5 i	05.04→	80				1 987 482 219	← 1664	
							1 987 482 220	→ 1604	
<b>MR2 Cabrio [W3]</b>									
	1.8 16V	12.99-05.06	103				1 987 482 296	→ 1583	
							1 987 482 299	← 1575	
<b>Paseo Coupé [L5]</b>									
	1.5 i 16V	08.95-08.99	69/81-85				0 986 475 895	← 17,46	
							0 986 475 896	→ 17,46	
<b>Picnic</b>									
	2.0 i	08.03→	110				1 987 482 157	319	
	2.0 i 16V	09.96-05.01	98				1 987 482 060	→ 1390	
							1 987 482 061	← 1305	
	2.2 D Turbo	09.97-05.01	66				1 987 482 060	→ 1390	
							1 987 482 061	← 1305	
<b>Porte</b>									
	1.3 i	07.04→	64				0 986 475 897	← 19,05	
							0 986 475 898	→ 19,05	
<b>Previa</b>									
	2.0 D Turbo	02.01-04.03	85						F 026 A03 531 <sup>7</sup>
		05.03-01.06	85						F 01G 09G 038 <sup>7</sup>
	2.4 i 16V	05.90-12.99	97		STB		0 986 473 400	← 44,33	
							0 986 474 400	→ 44,33	
		08.93-12.99	99-103		STB		0 986 473 400	← 44,33	
							0 986 474 400	→ 44,33	
		02.00-03.03	118						F 026 A03 531 <sup>7</sup>
		04.03→	118						F 01G 09G 038 <sup>7</sup>
		ABS 05.90-12.00	97				0 986 473 400	← 44,33	
							0 986 474 400	→ 44,33	
	2.4 i 16V 4x4	05.90-12.99	97		STB		0 986 473 400	← 44,33	
							0 986 474 400	→ 44,33	
		02.00-04.03	118						F 026 A03 531 <sup>7</sup>
		05.03-01.06	118		LLE				F 01G 09G 038 <sup>7</sup>



								
◀ TOYOTA Previa								
								
	2.4 i 16V	05.90-12.00	97/99-103			0986 <b>473 402</b>	 ← 42,78	F 026 <b>A06 141</b> <sup>7</sup>
	2.4 i 16V 4x4					0986 <b>474 402</b>	 → 42,78	F 026 <b>A06 141</b> <sup>7</sup>
								
	2.4 i 16V	05.90-12.99	97		LLE	1987 <b>482 161</b>	1513	
		05.90-12.00	97			1987 <b>482 161</b>	1513	
		08.93-12.99	99-103		LLE	1987 <b>482 161</b>	1513	
		09.93-12.99	97			1987 <b>482 162</b>	→ 956	
	2.4 i 16V 4x4	05.90-12.99	97		LLE	1987 <b>482 161</b>	1513	
<b>Previda</b>								
								
	2.4	01.06→	125			F 01G <b>260 045</b>	→	F 01G <b>060 0UK</b> <sup>7</sup>
						F 01G <b>260 046</b>	←	F 01G <b>060 0UK</b> <sup>7</sup>
								
	2.4	01.06→	125			F 01G <b>260 047</b>	→	F 01G <b>060 0UN</b> <sup>7</sup>
						F 01G <b>260 048</b>	←	F 01G <b>060 0UN</b> <sup>7</sup>
<b>Prius</b>								
								
	1.5 i	12.03→	57					F 026 <b>A06 161</b> <sup>7</sup>
								
	1.5 i	09.03→	57			0986 <b>475 897</b>	← 19,05	
						0986 <b>475 898</b>	→ 19,05	
<b>Prius [W20]</b>								
								
	1.5 i	12.03-03.09	57					F 026 <b>A06 161</b> <sup>7</sup>
								
	1.5 i	09.03-08.04	57			0986 <b>474 213</b>	 → 36	
		09.04-03.09	57					F 026 <b>A06 162</b> <sup>7</sup>
								
	1.5 i	09.03-03.09	57			1987 <b>482 347</b>	← 1775	
						1987 <b>482 348</b>	→ 1715	
<b>Prius [W30]</b>								
								
	1.8 i	04.09→	73-100					0 204 <b>104 359</b> <sup>8</sup>
<b>Prius [W35]</b>								
								
	1.8 Plug-in	12.09-04.12	73					0 204 <b>104 359</b> <sup>8</sup>

T

		S							
<b>Probox Van</b>									
	1.3i	06.02-09.14	64				0 986 474 211		→ 51
	1.5i	06.02-09.14	80				0 986 474 211		→ 51
	1.3i	06.02-09.14	64				0 986 475 931		← 19,05
	1.5i	06.02-09.14	80				0 986 475 931		← 19,05
<b>Quantum</b>									
	2.5 D-4D	03.05→	75				0 986 473 224		← 67
							0 986 474 224		→ 67
									F 026 A06 163 <sup>7</sup>
	2.5 D-4D	03.05-04.12	75				F 026 A06 937		↔
<b>Ractis</b>									
	1.5i	09.05-11.10	81				0 986 134 237		←
							0 986 135 237		→
<b>RAV4</b>									
	2.0	04.94-08.00	95/99				0 986 473 202		← 54
	2.0i 4WD						0 986 474 202		→ 54
									F 026 A03 457 <sup>7</sup>
	2.0	04.94-08.00	95/99				0 986 475 918		↔ 17,5
	2.0i 4WD								
	2.0	04.94-08.00	95/99				1 987 477 996		258
	2.0i 4WD								
<b>RAV4 [A1]</b>									
	2.0i 16V 4x4	04.94-08.00	94/96/99				0 986 473 202		← 54
							0 986 474 202		→ 54
									F 026 A03 457 <sup>7</sup>
	2.0i 16V 4x4	04.94-08.00	94/96/99				0 986 475 918		↔ 17,5
	2.0i 16V 4x4	04.94-08.00	94/96/99						F 026 A03 512 <sup>7</sup>
	2.0i 16V 4x4	04.94-08.00	96				1 987 477 542		→ 1335
							1 987 477 547		← 1345
							1 987 477 996		258





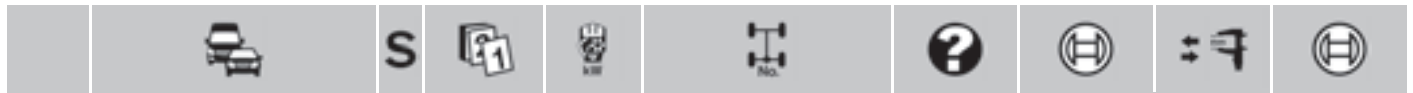

	◀ TOYOTA RAV4 [A1]							
	2.0 i 16V 4x4	04.94-08.00	99			1987 477 996	258	
				Fg.-Nr. SXA10		1987 477 542	→ 1335	
						1987 477 547	← 1345	
		04.95-08.00	94			1987 477 996	258	
		11.95-08.00	94	Fg.-Nr. SXA15		1987 477 542	→ 1335	
						1987 477 547	← 1345	

**RAV4 [A2]**

	1.8 i 16V	05.00-11.05	103			0986 134 036	↔ 61	F 026 A03 527 <sup>7</sup>
						0986 135 036	↔ 61	F 026 A03 527 <sup>7</sup>
	2.0 D Turbo	05.00-11.05	85/110			0986 134 036	↔ 61	F 026 A03 527 <sup>7</sup>
	2.0 VVT-i 4x4					0986 135 036	↔ 61	F 026 A03 527 <sup>7</sup>
	2.4 i 4x4	07.03-01.06	120			0986 134 036	↔ 61	F 026 A03 527 <sup>7</sup>
						0986 135 036	↔ 61	F 026 A03 527 <sup>7</sup>

	1.8 i 16V	05.00-11.05	103			0986 475 931	↔ 19,05	
	2.0 D Turbo, VVT-i 4x4	05.00-11.05	85/110			0986 475 931	↔ 19,05	
	2.4 i 4x4	07.03-01.06	120			0986 475 931	↔ 19,05	

	1.8 i 16V	05.00-11.05	103			0986 473 478	↔ 32	F 026 A03 512 <sup>7</sup>
						0986 474 478	↔ 32	F 026 A03 512 <sup>7</sup>
	2.0 D Turbo	05.00-11.05	85/110			0986 473 478	↔ 32	F 026 A03 512 <sup>7</sup>
	2.0 VVT-i 4x4					0986 474 478	↔ 32	F 026 A03 512 <sup>7</sup>
	2.4 i 4x4	07.03-01.06	120			0986 473 478	↔ 32	F 026 A03 512 <sup>7</sup>
						0986 474 478	↔ 32	F 026 A03 512 <sup>7</sup>

	1.8 i 16V	05.00-11.05	103			1987 477 794	408	
				Fg.-Nr. ZCA25*→	4SB	1987 482 366	← 1274	
						1987 482 367	→ 1274	
	2.0 D Turbo	05.01-11.05	85			1987 477 794	408	
				Fg.-Nr. CLA20*→	4SB	1987 482 366	← 1274	
						1987 482 367	→ 1274	
	2.0 VVT-i 4x4	05.00-11.05	110			1987 477 794	408	
				Fg.-Nr. ACA20*→	4SB	1987 482 366	← 1274	
						1987 482 367	→ 1274	
	2.4 i 4x4	07.03-01.06	120			1987 477 794	408	
				Fg.-Nr. ACA22		1987 482 366	← 1274	
						1987 482 367	→ 1274	

**RAV4 [A3]**

	2.0, 4x4	11.05-11.12	112/116					0 204 104 359 <sup>8</sup>
	2.2 D-CAT 4x4, D-4D, D-4D 4x4	11.05-11.12	100-110/130					0 204 104 359 <sup>8</sup>
	2.4 4x4	11.05-11.12	125		TW			0 204 104 359 <sup>8</sup>
	3.5 4x4	11.05→	201					0 204 104 359 <sup>8</sup>

**RAV4 Cabrio [A1]**

	2.0 i 16V 4x4	11.95-08.00	94/96			0986 473 202	↔ 54	F 026 A03 457 <sup>7</sup>
						0986 474 202	↔ 54	F 026 A03 457 <sup>7</sup>
	2.0 i 16V 4x4	11.95-08.00	94/96			0986 475 918	↔ 17,5	

		S							
	2.0i 16V 4x4		12.97-08.00	94					F 026 A03 512 <sup>7</sup>
	2.0i 16V 4x4		11.95-08.00	94/96			1 987 477 542	→ 1335	
							1 987 477 547	← 1345	
							1 987 477 996	258	
<b>Rush</b>									
	1.5 i		01.06→	80			0 986 475 931	↔ 19,05	
	1.5 i		01.06→	80			1 987 482 233	← 1993	
<b>Sequoia</b>									
	4.7		09.00-09.02	179-204					F 026 A03 287 <sup>6</sup>
	4.7 4x4		10.02-08.07	179-204					F 026 A06 115 <sup>7</sup>
	4.7		09.00-08.07	179-204			0 986 134 250	←	F 026 A08 119 <sup>7</sup>
	4.7 4x4						0 986 135 250	→	F 026 A08 119 <sup>7</sup>
<b>Starlet [P8]</b>									
	1.0	ABO	12.89-01.96	40			0 986 475 730	← 17,5	
							0 986 475 731	→ 17,5	
		ABS	12.89-01.96	40			0 986 475 912	→ 15,87	
							0 986 475 913	← 15,87	
	1.3i 12V	ABO	12.89-01.96	53/55-60			0 986 475 730	← 17,5	
	1.3 12V						0 986 475 731	→ 17,5	
		ABS	12.89-01.96	53/55-60			0 986 475 912	→ 15,87	
							0 986 475 913	← 15,87	
	1.5 D	ABO	12.89-01.96	40			0 986 475 730	← 17,5	
							0 986 475 731	→ 17,5	
	1.0		12.89-01.96	40			1 987 482 306	→ 1688	
							1 987 482 307	← 1616	
	1.3i 12V		12.89-01.96	53/55-60			1 987 482 306	→ 1688	
	1.3 12V						1 987 482 307	← 1616	
	1.5 D		12.89-01.96	40			1 987 482 306	→ 1688	
							1 987 482 307	← 1616	
<b>Starlet [P9]</b>									
	1.3i 16V	ABO	01.96-07.99	53/55/			0 986 475 895	← 17,46	
	1.3 12V			60-62			0 986 475 896	→ 17,46	
		ABS	01.96-07.99	53/55/			F 026 A02 353	←	
				60-62			F 026 A02 354	→	



		S							
◀ TOYOTA Starlet [P9]									
	1.3 i 16V	01.96-07.99	53/55/				1987 477 996	258	
	1.3 12V		60-62				1987 477 997	→ 1518	
							1987 477 998	← 1485	
<b>Succeed Van</b>									
	1.5 i	06.02-09.14	80				0986 474 211	→ 51	
	1.5 i	06.02-09.14	80				0986 475 931	← 19,05	
<b>Tarago</b>									
	2.4 i 16V	05.90-12.00	97						F 026 A03 535 <sup>7</sup>
	2.4 i 16V	05.90-12.00	97				0986 473 402	← 42,78	F 026 A06 141 <sup>7</sup>
							0986 474 402	→ 42,78	F 026 A06 141 <sup>7</sup>
<b>Tercel [L5]</b>									
	1.5 i 16V	09.94-07.99	61				0986 475 895	← 17,46	
							0986 475 896	→ 17,46	
<b>Urban Cruiser [P1]</b>									
	1.3 WT-i	01.09→	74				0986 134 347	← 60	F 026 A06 625 <sup>7</sup>
							0986 135 347	→ 60	F 026 A06 625 <sup>7</sup>
	1.4 D-4D 4x4	01.09→	66				0986 134 347	← 60	F 026 A06 625 <sup>7</sup>
							0986 135 347	→ 60	F 026 A06 625 <sup>7</sup>
	1.3 WT-i	01.09→	74				0986 134 237	←	
							0986 135 237	→	
	1.4 D-4D 4x4	01.09→	66	Fg.-Nr. NLP110			0986 134 237	←	
							0986 135 237	→	
	1.3 WT-i	01.09→	74				1987 482 440	→ 1892	
							1987 482 441	← 1617	
	1.4 D-4D 4x4	01.09→	66	Fg.-Nr. NLP110			1987 482 440	→ 1892	
							1987 482 441	← 1617	
<b>Verso-S</b>									
	1.3 WT-i	11.10→	73				0986 134 347	← 60	F 026 A06 625 <sup>7</sup>
							0986 135 347	→ 60	F 026 A06 625 <sup>7</sup>
	1.4 D-4D	11.10→	66				0986 134 347	← 60	F 026 A06 625 <sup>7</sup>
							0986 135 347	→ 60	F 026 A06 625 <sup>7</sup>



		S							
	1.3 VVT-i	11.10→	73				0 986 134 237		←
							0 986 135 237		→
	1.4 D-4D	11.10→	66				0 986 134 237		←
							0 986 135 237		→
	1.3 VVT-i	11.10→	73			STB	1 987 482 463	←	1657
							1 987 482 464	→	1695
	1.4 D-4D	11.10→	66			STB	1 987 482 463	←	1657
							1 987 482 464	→	1695
<b>Vitz</b>									
	1.0 i	01.99-08.00	51				0 986 473 110		← 51,04
							0 986 474 110		→ 51,04
		01.05-12.10	52				0 986 135 343		→ 54 F 026 A06 218 <sup>7</sup>
	1.3 i	09.99-02.05	64-65				0 986 473 211		← 51
							0 986 474 211		→ 51
		01.05-12.10	64				0 986 135 343		→ 54 F 026 A06 218 <sup>7</sup>
	1.0 i	01.99-02.05	51				0 986 475 881	←	17,46
							0 986 475 882	→	17,46
		01.05-12.10	52				0 986 475 897	←	19,05
							0 986 475 898	→	19,05
	1.3 i	01.05-12.10	64				0 986 475 897	←	19,05
							0 986 475 898	→	19,05
		12.10→	70				0 986 475 881	←	17,46
							0 986 475 882	→	17,46
	1.5 i	01.05-12.10	81				0 986 475 897	←	19,05
							0 986 475 898	→	19,05
	1.3 i	09.99-02.05	64-65				0 986 134 221		←
							0 986 135 221		→
	1.5 i	12.10→	80				0 986 134 237		←
							0 986 135 237		→
	1.0 i	01.05-12.10	52				1 987 482 512	←	1558
							1 987 482 513	→	1600
	1.3 i	09.99-02.05	64-65				1 987 477 918	←	1520
							1 987 477 919	→	1481
		01.05-12.10	64				1 987 482 512	←	1558
							1 987 482 513	→	1600
<b>Wish</b>									
	1.8 i	01.03-04.09	97						F 026 A03 538 <sup>7</sup>
	2.0 i	04.03-04.09	114						F 026 A03 538 <sup>7</sup>
<b>Yaris [P1]</b>									
	1.0 i16V	01.99-12.02	50			STB	0 986 473 110		← 51,04
							0 986 474 110		→ 51,04
		08.99-08.05	50			4SB	0 986 473 211		← 51
							0 986 474 211		→ 51



		S							
	◀ TOYOTA Yaris [P1]								
1.0 i 16V	01.01-08.05	50	HTB	0 204 102 985	← 51	0 204 104 320 <sup>7</sup>			
				0 986 473 212					
1.3 i 16V	08.99-12.02	66	STB	0 204 102 986	→ 51	0 204 104 320 <sup>7</sup>			
				0 986 474 212					
1.3 i 16V	08.99-12.02	66	STB	0 986 473 110	← 51,04				
				0 986 474 110		→ 51,04			
	05.02-08.05	63	HTB	0 986 473 211	← 51				
				0 986 474 211		→ 51			
1.3 Wt-i	08.11→	64	HTB	0 204 102 985	← 51	0 204 104 320 <sup>7</sup>			
				0 986 473 212					
1.3 Wt-i	08.11→	64	HTB	0 204 102 986	→ 51	0 204 104 320 <sup>7</sup>			
				0 986 474 212					
1.3 Wt-i	08.11→	64	TW	0 986 473 211	← 51				
				0 986 474 211		→ 51			
1.4 D Turbo	10.01-08.05	55	HTB	0 986 134 343	← 54	F 026 A06 218 <sup>7</sup>			
				0 986 135 343		→ 54	F 026 A06 218 <sup>7</sup>		
1.4 D Turbo	10.01-08.06	55	4SB	0 986 473 110	← 51,04				
				0 986 474 110		→ 51,04			
1.4 D Turbo	10.01-08.06	55	4SB	0 986 473 211	← 51				
				0 986 474 211		→ 51			
1.4 D Turbo	02.03-08.06	55	HTB	0 204 102 985	← 51	0 204 104 320 <sup>7</sup>			
				0 986 473 212					
1.4 D Turbo	02.03-08.06	55	HTB	0 204 102 986	→ 51	0 204 104 320 <sup>7</sup>			
				0 986 474 212					
1.5 i 16V	01.01-08.05	78	HTB	0 986 473 211	← 51				
				0 986 474 211		→ 51			
	1.0 i 16V	01.99-08.99	50	0 986 475 902	← 17,46				
				0 986 475 903		→ 17,46			
	1.0 i 16V	09.99-12.02	50	0 986 475 881	← 17,46				
				0 986 475 882		→ 17,46			
	1.0 i 16V	01.01-08.05	50	F 026 009 217	↔ 19,05				
	1.3 i 16V	08.99-12.02	66	0 986 475 881	← 17,46				
				0 986 475 882		→ 17,46			
	1.3 i 16V	05.02-08.05	63	F 026 009 217	↔ 19,05				
	1.3 Wt-i	08.11→	64	F 026 002 393	← 20,64				
				F 026 002 394		→ 20,64			
	1.3 Wt-i	08.11→	64	0 986 475 897	← 19,05				
				0 986 475 898		→ 19,05			
	1.4 D Turbo	10.01-08.05	55	0 986 475 881	← 17,46				
				0 986 475 882		→ 17,46			
	1.4 D Turbo	02.03-08.06	55	F 026 009 217	↔ 19,05				
	1.0 i 16V	01.99-02.03	50	0 986 473 210	← 30				
				0 986 474 210		→ 30			
	1.0 i 16V	03.03-08.05	50	0 986 134 221	←				
				0 986 135 221		→			
	1.3 i 16V	08.99-12.02	66	0 986 473 210	← 30				
				0 986 474 210		→ 30			
	1.3 i 16V	05.02-02.03	63	0 986 473 210	← 30				
				0 986 474 210		→ 30			
	1.3 i 16V	03.03-08.05	63	0 986 134 221	←				
				0 986 135 221		→			
	1.4 D Turbo	10.01-01.03	55	0 986 473 210	← 30				
				0 986 474 210		→ 30			
	1.4 D Turbo	02.03-08.06	55	0 986 134 221	←				
				0 986 135 221		→			
	1.5 i 16V	01.01-01.03	78	0 986 473 210	← 30				
				0 986 474 210		→ 30			
	1.5 i 16V	02.03-08.05	78	0 986 134 221	←				
				0 986 135 221		→			

		S								
	1.0i 16V	01.99-12.02	50			TBR	1 987 477 543	→ 1503		
							1 987 477 548	← 1548		
		01.99-08.05	50			SBR	1 987 477 918	← 1520		
							1 987 477 919	→ 1481		
		01.01-08.05	50			TBR	1 987 482 155	← 1580		
							1 987 482 156	→ 1553		
	1.3i 16V	08.99-12.02	66				SBR	1 987 477 918	← 1520	
								1 987 477 919	→ 1481	
							TBR	1 987 477 543	→ 1503	
								1 987 477 548	← 1548	
		05.02-08.05	63				SBR	1 987 477 918	← 1520	
								1 987 477 919	→ 1481	
						TBR	1 987 482 155	← 1580		
							1 987 482 156	→ 1553		
1.4D Turbo	10.01-08.05	55				TBR	1 987 477 543	→ 1503		
							1 987 477 548	← 1548		
		10.01-08.06	55			SBR	1 987 477 918	← 1520		
							1 987 477 919	→ 1481		
	02.03-08.06	55				TBR	1 987 482 155	← 1580		
							1 987 482 156	→ 1553		
1.5i 16V	01.01-08.05	78					1 987 477 918	← 1520		
							1 987 477 919	→ 1481		
	1.0i 16V	01.01-08.05	50			LAB	0 265 006 674 <sup>3</sup>			
							RAB	0 265 006 675 <sup>3</sup>		
	1.3i 16V	05.02-08.05	63				LAB	0 265 006 674 <sup>3</sup>		
								RAB	0 265 006 675 <sup>3</sup>	
	1.4D Turbo	02.03-08.06	55				LAB	0 265 006 674 <sup>3</sup>		
								RAB	0 265 006 675 <sup>3</sup>	
<b>Yaris [P9]</b>										
	1.3 VVT-i	08.05→	64				0 986 134 343	← 54	F 026 A06 218 <sup>7</sup>	
								0 986 135 343	→ 54	F 026 A06 218 <sup>7</sup>
	1.5 VVT-i	01.06→	81					0 986 134 343	← 54	F 026 A06 218 <sup>7</sup>
									0 986 135 343	→ 54
	1.3 VVT-i	08.05→	64			TW	F 026 002 393	← 20,64		
								F 026 002 394	→ 20,64	
								0 986 475 897	← 19,05	
								0 986 475 898	→ 19,05	
								0 986 475 897	← 19,05	
								0 986 475 898	→ 19,05	
	1.5 VVT-i	01.06→	81					0 986 475 897	← 19,05	
									0 986 475 898	→ 19,05
		1.3 VVT-i	08.05→	64				1 987 482 512	← 1558	
									1 987 482 513	→ 1600
								1 987 482 442	← 1648	
		01.06→	64					1 987 482 443	→ 1690	
1.5 VVT-i		01.06→	81					1 987 482 442	← 1648	
									1 987 482 443	→ 1690



		S							
◀ TOYOTA									
<b>Yaris [P9, JTD]</b>									
	1.0 WT-i	08.05-07.11	51		STB	0986 134 343		← 54	F 026 A06 2187
						0986 135 343		→ 54	F 026 A06 2187
	1.0 WT-i	08.05-07.11	51			F 026 002 393		← 20,64	
						F 026 002 394		→ 20,64	
	1.0 WT-i	08.05-07.11	51			0986 134 237		←	
						0986 135 237		→	
	1.8 WVT-i	11.06-07.11	97			0986 134 237		←	
						0986 135 237		→	
	1.0 WVT-i	08.05-07.11	51		STB	1987 482 512		← 1558	
						1987 482 513		→ 1600	
					4SB	1987 482 440		→ 1892	
						1987 482 441		← 1617	
	1.8 WVT-i	11.06-07.11	97			1987 482 440		→ 1892	
						1987 482 441		← 1617	
<b>Yaris [P9, VNK]</b>									
	1.0 WVT-i	11.05-07.11	51			0986 134 288		← 54	
						0986 135 288		→ 54	
	1.3 WVT-i	11.05-07.11	64/74			0986 134 288		← 54	
						0986 135 288		→ 54	
	1.4 D-4D	11.05-07.11	66			0986 134 288		← 54	
						0986 135 288		→ 54	
	1.0 WVT-i	11.05-07.11	51			0986 475 936		↔ 20,64	
	1.3 WVT-i	11.05-07.11	64/74			0986 475 936		↔ 20,64	
	1.4 D-4D	11.05-07.11	66			0986 475 936		↔ 20,64	
	1.0 WVT-i	11.05-07.11	51			0986 134 246		←	
						0986 135 246		→	
	1.3 WVT-i	11.05-07.11	64/74			0986 134 246		←	
						0986 135 246		→	
	1.4 D-4D	11.05-07.11	66			0986 134 246		←	
						0986 135 246		→	
	1.0 WVT-i	11.05-07.11	51		HTB	1987 477 090		→ 1600	
						1987 482 221		← 1556	
					4SB	1987 477 070		→ 1678	
						1987 482 222		← 1634	
	1.3 WVT-i	11.05-07.11	64/74		HTB	1987 477 090		→ 1600	
						1987 482 221		← 1556	
					4SB	1987 477 070		→ 1678	
						1987 482 222		← 1634	
	1.4 D-4D	11.05-07.11	66		HTB	1987 477 090		→ 1600	
						1987 482 221		← 1556	
					4SB	1987 477 070		→ 1678	
						1987 482 222		← 1634	



		S							
<b>Yaris [P12, VNK]</b>									
	1.3	07.14→	73				0 986 134 288		← 54
							0 986 135 288		→ 54
	1.3	07.14→	73				0 986 475 992		↔ 20,64
	1.3	07.14→	73				0 986 134 246		←
							0 986 135 246		→
	1.5 HSD	07.14→	55				0 986 134 246		←
							0 986 135 246		→
<b>Yaris [P13, JTD]</b>									
	1.0	08.11→	51				0 986 134 343		← 54
							0 986 135 343		→ 54
									F 026 A06 218 <sup>7</sup>
	1.0	08.11→	51				F 026 002 393		← 20,64
							F 026 002 394		→ 20,64
<b>Yaris [P13, VNK]</b>									
	1.0	07.11→	51				0 986 134 288		← 54
							0 986 135 288		→ 54
	1.3	07.11→	73				0 986 134 288		← 54
							0 986 135 288		→ 54
	1.4D-4D	07.11→	66				0 986 134 288		← 54
							0 986 135 288		→ 54
	1.5 HSD	04.12-01.13	55						F 026 A06 625 <sup>7</sup>
	1.0	07.11→	51				0 986 475 992		↔ 20,64
	1.3	07.11→	73				0 986 475 992		↔ 20,64
	1.4D-4D	07.11→	66				0 986 475 992		↔ 20,64
	1.0	07.11→	51				0 986 134 246		←
							0 986 135 246		→
	1.3	07.11→	73				0 986 134 246		←
							0 986 135 246		→
	1.4D-4D	07.11→	66				0 986 134 246		←
							0 986 135 246		→
	1.5 HSD	04.12→	55				0 986 134 246		←
							0 986 135 246		→
<b>Yaris Verso [P2]</b>									
	1.3i16V	08.99-09.05	63				0 986 473 211		← 51
							0 986 474 211		→ 51
	1.4D Turbo	08.01-09.05	55				0 986 473 211		← 51
							0 986 474 211		→ 51
	1.5i16V	08.99-09.05	81				0 986 473 211		← 51
							0 986 474 211		→ 51





		S							
◀ TOYOTA Yaris Verso [P2]									
	1.3 i 16V	08.99-09.05	63				0986 475 897	← 19,05	
							0986 475 898	→ 19,05	
	1.4 D Turbo	08.01-09.05	55				0986 475 897	← 19,05	
							0986 475 898	→ 19,05	
	1.5 i 16V	08.99-09.05	81		STB		0986 475 897	← 19,05	
							0986 475 898	→ 19,05	
	1.3 i 16V	08.99-09.05	63				0986 473 215	← 30	
							0986 474 215	→ 30	
	1.4 D Turbo	08.01-09.05	55				0986 473 215	← 30	F 026 A03 512 <sup>7</sup>
							0986 474 215	→ 30	F 026 A03 512 <sup>7</sup>
	1.5 i 16V	08.99-11.02	81		4SB		0986 473 215	← 30	F 026 A03 512 <sup>7</sup>
		08.99-01.03	81		4SB		0986 474 215	→ 30	
	1.3 i 16V	08.99-09.05	63		TBR		1987 477 544	← 1623	
					4SB		1987 477 549	→ 1686	
							1987 482 219	← 1664	
							1987 482 220	→ 1604	
	1.4 D Turbo	08.01-09.05	55		TBR		1987 477 544	← 1623	
							1987 477 549	→ 1686	
					4SB		1987 482 219	← 1664	
							1987 482 220	→ 1604	
	1.5 i 16V	08.99-09.05	81		TBR		1987 477 544	← 1623	
							1987 477 549	→ 1686	
					4SB		1987 482 219	← 1664	
							1987 482 220	→ 1604	
<b>4-Runner [N13]</b>									
	2.4 D Turbo	01.90-11.95	69				F 026 A02 256	↔	
	3.0 i	09.89-08.95	105				F 026 A02 256	↔	
<b>4-Runner [N18]</b>									
	2.7 i 16V	11.95-08.00	112		16Z				F 026 A03 513 <sup>7</sup>
	3.0 D Turbo, D Turbo AWD	11.95-08.02	92		16Z				F 026 A03 513 <sup>7</sup>
	3.4 i	11.95-08.02	136		16Z				F 026 A03 513 <sup>7</sup>
	2.7 i 16V	11.95-08.00	112		15Z	F 026 002 348	↔ 23,81		
					16Z	F 026 A06 538	↔		
	3.0 D Turbo	11.95-08.00	92		15Z	F 026 002 348	↔ 23,81		
					16Z	F 026 002 348	↔ 23,81		
	3.4 i	11.95-07.00	136		15Z	F 026 002 348	↔ 23,81		
					16Z	F 026 A06 538	↔		
<b>4-Runner [N21]</b>									
	4.0 i	09.02-09.05	236						F 026 A06 115 <sup>7</sup>
		09.02→	236						F 026 A03 287 <sup>6</sup>
					VSP				F 026 A06 115 <sup>7</sup>
					VSP	0986 134 312	←		F 026 A06 116 <sup>7</sup>
						0986 135 312	→		F 026 A06 116 <sup>7</sup>
			10.05→	236					F 026 A06 116 <sup>7</sup>

		<b>S</b>							
4.7 i 4x4		09.02-09.05	260						F 026 <b>A06 115</b> <sup>7</sup>
		09.02-08.09	260						F 026 <b>A03 287</b> <sup>6</sup>
					VSP				F 026 <b>A06 115</b> <sup>7</sup>
					VSP	0 986 <b>134 312</b>			F 026 <b>A06 116</b> <sup>7</sup>
						0 986 <b>135 312</b>			F 026 <b>A06 116</b> <sup>7</sup>
		10.05-08.09	260						F 026 <b>A06 116</b> <sup>7</sup>
4.7 4x4		08.02-08.09	175-194		VSP				F 026 <b>A06 115</b> <sup>7</sup>
					VSP	0 986 <b>134 312</b>			F 026 <b>A06 116</b> <sup>7</sup>
						0 986 <b>135 312</b>			F 026 <b>A06 116</b> <sup>7</sup>

**UAZ**

**Hunter**



	2.7 i 4x4	01.08→	94,1	LAB	0 265 <b>007 799</b>		
				RAB	0 265 <b>007 800</b>		

**Patriot**



	2.2 TD 4x4	01.07→	85	LAB	0 265 <b>007 799</b> <sup>3</sup>		
				RAB	0 265 <b>007 800</b> <sup>3</sup>		
	2.7 4x4	09.06→	105	LAB	0 265 <b>007 799</b> <sup>3</sup>		
				RAB	0 265 <b>007 800</b> <sup>3</sup>		
		01.08→	105	LAB	0 265 <b>007 799</b>		
				RAB	0 265 <b>007 800</b>		

**Pickup**



	2.7 4x4	06.08→	105	LAB	0 265 <b>007 799</b>		
				RAB	0 265 <b>007 800</b>		

**VAUXHALL**

**Adam**



	1.2	04.13→	51	257	0 204 <b>902 032</b>		54
					0 986 <b>473 487</b>		
					0 204 <b>902 033</b>		54
					0 986 <b>474 487</b>		
				308, SBJ			1 987 <b>470 005</b> <sup>7</sup>
				308, SBJ	0 986 <b>473 062</b>		57
					0 986 <b>474 062</b>		57
							1 987 <b>470 005</b> <sup>7</sup>
	1.4	04.13→	64/74/110	257	0 204 <b>902 032</b>		54
	1.4 Turbo				0 986 <b>473 487</b>		
					0 204 <b>902 033</b>		54
					0 986 <b>474 487</b>		
				308, SBJ			1 987 <b>470 005</b> <sup>7</sup>
				308, SBJ	0 986 <b>473 062</b>		57
					0 986 <b>474 062</b>		57
							1 987 <b>470 005</b> <sup>7</sup>



	1.0	09.14→	85		0 986 <b>475 949</b>		19,05
	1.2	04.13→	51		0 986 <b>475 949</b>		19,05
	1.4, Turbo	04.13→	64/74/110		0 986 <b>475 949</b>		19,05



			S							
◀ VAUXHALL Adam										
	<b>1.0</b>	09.14→	85					0 265 <b>008 089</b> <sup>3</sup>		
	<b>1.2</b>	04.13→	51					0 265 <b>008 089</b> <sup>3</sup>		
	<b>1.4, Turbo</b>	04.13→	64/74/110					0 265 <b>008 089</b> <sup>3</sup>		
<b>Agila [A]</b>										
	<b>1.0 i</b>	09.99-08.03	43	Fg.-Nr. →3G002367, →3G002706		0 204 <b>102 950</b>	← 48	0 204 <b>104 299</b> <sup>8</sup>		
						0 986 <b>473 344</b>				
						0 204 <b>102 951</b>	→ 48	0 204 <b>104 299</b> <sup>8</sup>		
						0 986 <b>474 344</b>				
				Fg.-Nr. 3G000001→				0 204 <b>104 298</b> <sup>7</sup>		
	<b>1.0 Twinport</b>	08.03-02.08	44	Fg.-Nr. →3G002367, →3G002706		0 204 <b>102 950</b>	← 48			
						0 986 <b>473 344</b>				
						0 204 <b>102 951</b>	→ 48			
						0 986 <b>474 344</b>				
				Fg.-Nr. 3G000001→				0 204 <b>104 298</b> <sup>7</sup>		
				Fg.-Nr. 3G002368→, 3G002707→		0 204 <b>204 711</b>	← 48			
						0 986 <b>473 343</b>				
						0 204 <b>204 712</b>	→ 48			
						0 986 <b>474 343</b>				
	<b>1.2 i</b>	09.00-06.04	55	Fg.-Nr. →3G002367, →3G002706		0 204 <b>102 950</b>	← 48			
						0 986 <b>473 344</b>				
						0 204 <b>102 951</b>	→ 48			
						0 986 <b>474 344</b>				
				Fg.-Nr. 3G002368→, 3G002707→		0 204 <b>204 711</b>	← 48			
						0 986 <b>473 343</b>				
						0 204 <b>204 712</b>	→ 48			
						0 986 <b>474 343</b>				
	<b>1.2 Twinport</b>	07.04-02.08	59	Fg.-Nr. 3G000001→				0 204 <b>104 299</b> <sup>8</sup>		
				Fg.-Nr. 3G002368→, 3G002707→		0 204 <b>204 711</b>	← 48	0 204 <b>104 298</b> <sup>7</sup>		
						0 986 <b>473 343</b>				
						0 204 <b>204 712</b>	→ 48			
						0 986 <b>474 343</b>				
	<b>1.0 i, Twinport</b>	09.99-02.08	43/44			0 986 <b>475 886</b>	↔ 15,87			
	<b>1.2 i, Twinport</b>	09.00-02.08	55/59			0 986 <b>475 886</b>	↔ 15,87			
	<b>1.0 i</b>	09.99-02.08	43/44	Fg.-Nr. →1G075421		1 987 <b>477 771</b>	← 1518			
	<b>1.0 Twinport</b>					1 987 <b>477 995</b>	→ 1507			
				Fg.-Nr. 1G075422→2G999999		1 987 <b>477 771</b>	← 1518			
						1 987 <b>477 772</b>	→ 1498			
				Fg.-Nr. 3G000001→		1 987 <b>482 136</b>	→ 1530			
						1 987 <b>482 137</b>	← 1536			
	<b>1.2 i</b>	09.00-02.08	55/59	Fg.-Nr. →1G075421		1 987 <b>477 771</b>	← 1518			
	<b>1.2 Twinport</b>					1 987 <b>477 995</b>	→ 1507			
				Fg.-Nr. 1G075422→2G999999		1 987 <b>477 771</b>	← 1518			
						1 987 <b>477 772</b>	→ 1498			
				Fg.-Nr. 3G000001→		1 987 <b>482 136</b>	→ 1530			
						1 987 <b>482 137</b>	← 1536			





**Agila [B]**

	<b>1.0</b> Twinport	03.08→	48-50			0 986 <b>475 951</b>	↔ 19,05
	<b>1.2</b> Twinport, VVT	03.08→	63/69			0 986 <b>475 951</b>	↔ 19,05
	<b>1.3</b> CDTI	03.08→	55			0 986 <b>475 951</b>	↔ 19,05

	<b>1.0</b> Twinport	03.08→	48-50			1 987 <b>482 427</b>	→ 1600
	<b>1.2</b> Twinport	03.08→	63/69			1 987 <b>482 427</b>	→ 1600
	<b>1.2</b> VVT					1 987 <b>482 428</b>	← 1600
	<b>1.3</b> CDTI	03.08→	55			1 987 <b>482 427</b>	→ 1600
						1 987 <b>482 428</b>	← 1600

**Antara**

	<b>2.0</b> CDTI 4x4	11.06-12.11	93/110	Fg.-Nr. →80999999, →A3999999, →AB999999	FEB	1 987 <b>482 293</b>	← 1431
	<b>2.4</b> 4x4	11.06-12.11	104	Fg.-Nr. →80999999, →A3999999, →AB999999	FEB	1 987 <b>482 293</b>	← 1431
	<b>3.2</b> V6 4x4	11.06-12.11	165		FEB	1 987 <b>482 293</b>	← 1431
						1 987 <b>482 294</b>	→ 1454

**Arena**

	<b>1.9</b> D	03.98-08.01	44			0 204 <b>102 052</b>	← 45
						0 204 <b>103 052</b>	↻
						0 204 <b>102 054</b>	→ 45
						0 204 <b>103 054</b>	↻
	<b>2.5</b>	03.98-08.01	55			0 204 <b>102 052</b>	← 45
	<b>2.5</b> D					0 204 <b>103 052</b>	↻
						0 204 <b>102 054</b>	→ 45
						0 204 <b>103 054</b>	↻

	<b>1.9</b> D	03.98-08.01	44			1 987 <b>477 662</b>	↔ 747
		ABO 03.98-08.01	44			1 987 <b>477 663</b>	← 1330
						1 987 <b>477 665</b>	→ 1424
		ABS 03.98-08.01	44			1 987 <b>477 664</b>	← 1295
						1 987 <b>477 666</b>	→ 1390
	<b>2.5</b>	03.98-08.01	55			1 987 <b>477 662</b>	↔ 747
	<b>2.5</b>	ABO 03.98-08.01	55			1 987 <b>477 663</b>	← 1330
	<b>2.5</b> D					1 987 <b>477 665</b>	→ 1424
		ABS 03.98-08.01	55			1 987 <b>477 664</b>	← 1295
						1 987 <b>477 666</b>	→ 1390
	<b>2.5</b> D	03.98-08.01	55			1 987 <b>477 662</b>	↔ 747

**Astra**

	<b>1.7</b> CDTI	01.12→	81/96		D32	0 986 <b>134 319</b>	↻ ← 60
						0 986 <b>135 319</b>	↻ → 60

	<b>1.7</b> CDTI	01.12→	81/96		FEB	1 987 <b>482 502</b>	→ 1814
						1 987 <b>482 503</b>	← 1812



		S								
◀ VAUXHALL										
<b>Astra Convertible [F]</b>										
	1.6 i	09.91-02.98	52/55/74		ABM,STB,TW	1987 477 129	↔ 1690			
					4SB,ABM,TW	1987 477 258	↔ 1398			
	1.8 i	09.91-02.98	66/85/92		ABM,STB,TW	1987 477 129	↔ 1690			
					4SB,ABM,TW	1987 477 258	↔ 1398			
	2.0 i	09.91-02.98	85/100		ABM,STB,TW	1987 477 129	↔ 1690			
					4SB,ABM,TW	1987 477 258	↔ 1398			
	1.6 i	09.91-02.98	52/55/74			0986 594 026 <sup>3</sup>				
	1.8 i	09.91-02.98	66/85/92			0986 594 026 <sup>3</sup>				
	2.0 i	09.91-02.98	85/100			0986 594 026 <sup>3</sup>				
<b>Astra Convertible [G]</b>										
	1.6 i	ABS	09.00-08.05	74		0986 473 062	↔ 57	1987 470 005 <sup>7</sup>		
						0986 474 062	↔ 57	1987 470 005 <sup>7</sup>		
	1.6 i Twinport		03.03-08.05	76		0986 473 057	↔ 52			
						0986 474 057	↔ 52			
	1.8 i	ABS	09.00-08.05	92		0986 473 062	↔ 57	1987 470 005 <sup>7</sup>		
						0986 474 062	↔ 57	1987 470 005 <sup>7</sup>		
	2.0 i Turbo		03.02-08.05	141		0986 473 062	↔ 57	1987 470 005 <sup>7</sup>		
						0986 474 062	↔ 57	1987 470 005 <sup>7</sup>		
	2.2 i		09.00-08.05	108		0986 473 062	↔ 57	1987 470 005 <sup>7</sup>		
						0986 474 062	↔ 57	1987 470 005 <sup>7</sup>		
		1.6 i		09.00-08.05	74		0986 475 143	↔ 19,05		
	1.6 i		09.00-08.05	74		0986 473 325	↔ 36			
						0986 474 325	↔ 36			
					LUC	0986 474 261	↔ 36			
	1.6 i Twinport		03.03-08.05	76	Fg.-Nr. →3B999999	LUC 0986 474 261	↔ 36			
					Fg.-Nr. 4B000001→	LUC 0986 473 474	↔ 36			
						0986 474 474	↔ 36			
	1.8 i		09.00-08.05	92		LUC 0986 473 223	↔ 38,1			
						0986 474 223	↔ 38,1			
	2.0 i Turbo		03.02-08.05	141		LUC 0986 473 223	↔ 38,1			
						0986 474 223	↔ 38,1			
	2.2 i		09.00-08.05	108		LUC 0986 473 223	↔ 38,1			
						0986 474 223	↔ 38,1			
	1.6 i		09.00-08.05	74	SSZ,STB	1987 477 764	1254			
					4SB	1987 477 527	1593			
	1.6 i Twinport		03.03-08.05	76	4SB	1987 477 527	1593			
	1.8 i		09.00-08.05	92	4SB	1987 477 527	1593			
	2.0 i Turbo		03.02-08.05	141		1987 477 527	↔ 1593			
	2.2 i		09.00-08.05	108	4SB	1987 477 527	1593			
<b>Astra Coupé [G]</b>										
	1.6 i Twinport		03.03-08.05	76		0986 473 062	↔ 57	1987 470 005 <sup>7</sup>		
						0986 474 062	↔ 57	1987 470 005 <sup>7</sup>		
	1.8 i		09.97-08.05	85/87-93		0986 473 062	↔ 57	1987 470 005 <sup>7</sup>		
	1.8 i Dualfuel					0986 474 062	↔ 57	1987 470 005 <sup>7</sup>		

<b>2.0i Turbo</b>	09.00-08.05	141				0 986 473 062	↺ 57	1 987 470 005 <sup>7</sup>
						0 986 474 062	↻ 57	1 987 470 005 <sup>7</sup>
<b>2.2i</b>	09.00-08.05	108				0 986 473 062	↺ 57	1 987 470 005 <sup>7</sup>
						0 986 474 062	↻ 57	1 987 470 005 <sup>7</sup>
	<b>1.6i Twinport</b>	03.03-08.05	76	Fg.-Nr. →34999999	LUC	0 986 473 223	↺ 38,1	
					LUC	0 986 474 223	↻ 38,1	
				Fg.-Nr. 4B000001→	LUC	0 986 473 258	↺ 38	
					LUC	0 986 474 258	↻ 38	
	<b>1.8i</b>	09.97-08.05	85/87-93		LUC	0 986 473 223	↺ 38,1	
	<b>1.8i Dualfuel</b>				LUC	0 986 474 223	↻ 38,1	
	<b>2.0i Turbo</b>	09.00-08.05	141		LUC	0 986 473 223	↺ 38,1	
					LUC	0 986 474 223	↻ 38,1	
	<b>2.2i</b>	09.00-08.05	108		LUC	0 986 473 223	↺ 38,1	
					LUC	0 986 474 223	↻ 38,1	
	<b>1.6i Twinport</b>	03.03-08.05	76			1 987 482 537	↔ 1587	
	<b>1.8i</b>	09.97-08.00	85			1 987 477 527	↔ 1593	
		09.00-08.05	92			1 987 477 527	↔ 1593	
		03.01-08.05	85			1 987 477 527	↔ 1593	
	<b>1.8i Dualfuel</b>	09.02-08.05	87-93		STB	1 987 477 764	↔ 1254	
				Fg.-Nr. →22006460, →25003001, →16999999, →28006254, →1B999999		1 987 477 527	↔ 1593	
				Fg.-Nr. 22006461→32999999, 4SB 25003002→35999999, 26000001→36999999, 28006255→38999999, 2B000001→3B999999		1 987 482 102	↔ 1592	
				Fg.-Nr. 42000001→, 45000001→, 46000001→, 48000001→, 4B000001→	4SB	1 987 482 537	↔ 1587	
	<b>2.0i Turbo</b>	09.00-08.05	141			1 987 477 527	↔ 1593	
	<b>2.2i</b>	09.00-08.05	108			1 987 477 527	↔ 1593	
<b>Astra Estate [F]</b>								
	<b>1.4i</b>	09.90-02.98	44/60/66		ABM,STB,TW	1 987 477 129	↔ 1690	
					4SB,ABM,TW	1 987 477 258	↔ 1398	
	<b>1.6i</b>	09.91-02.98	52/55/74		ABM,STB,TW	1 987 477 129	↔ 1690	
					4SB,ABM,	1 987 477 258	↔ 1398	
	<b>1.7 D/DR</b>	12.91-02.98	42-44/50/ 60		ABM,STB,TW	1 987 477 129	↔ 1690	
					4SB,ABM,	1 987 477 258	↔ 1398	
	<b>1.7 DTL</b>	07.95-02.98	42-44/50/ 60		ABM,STB,TW	1 987 477 129	↔ 1690	
					4SB,ABM,TW	1 987 477 258	↔ 1398	
	<b>1.7 TD</b>	12.91-02.98	42-44/50/ 60		ABM,STB,TW	1 987 477 129	↔ 1690	
					4SB,ABM,TW	1 987 477 258	↔ 1398	
	<b>1.8i</b>	09.91-02.98	66/85/92		ABM,STB,TW	1 987 477 129	↔ 1690	
					4SB,ABM,TW	1 987 477 258	↔ 1398	
	<b>2.0i</b>	09.91-02.98	85/100/ 110		ABM,STB,TW	1 987 477 129	↔ 1690	
					4SB,ABM,TW	1 987 477 258	↔ 1398	
	<b>1.4i</b>	09.90-02.98	44/60/66			0 986 594 026 <sup>3</sup>		
	<b>1.6i</b>	09.91-02.98	52/55/74			0 986 594 026 <sup>3</sup>		
	<b>1.7 D/DR, DTL, TD</b>	12.91-02.98	42-44/50/60			0 986 594 026 <sup>3</sup>		
	<b>1.8i</b>	09.91-02.98	66/85/92			0 986 594 026 <sup>3</sup>		
	<b>2.0i</b>	09.91-02.98	85/100/110			0 986 594 026 <sup>3</sup>		



◀ VAUXHALL										
Astra Estate [G]										
	1.2 i		09.97-08.05	48/55		STB	0986 473 058		← 48	
							0986 474 058		→ 48	
	1.6 i	ABS	09.00-08.05	74			0986 473 062		← 57	1987 470 005 <sup>7</sup>
							0986 474 062		→ 57	1987 470 005 <sup>7</sup>
	1.6 i Dualfuel		09.02-08.05	63-73			0986 473 062		← 57	1987 470 005 <sup>7</sup>
							0986 474 062		→ 57	1987 470 005 <sup>7</sup>
	1.7 CDTI		03.03-08.05	59			0986 473 057		← 52	
							0986 474 057		→ 52	
	1.8 i Dualfuel	ABO	09.02-08.05	87-93			0986 473 057		← 52	
							0986 474 057		→ 52	
	1.8 i	ABS	09.97-08.05	85/87-93			0986 473 062		← 57	1987 470 005 <sup>7</sup>
	1.8 i Dualfuel						0986 474 062		→ 57	1987 470 005 <sup>7</sup>
	2.0 DTI	ABS	03.98-08.05	60/74			0986 473 062		← 57	1987 470 005 <sup>7</sup>
	2.0 DTL						0986 474 062		→ 57	1987 470 005 <sup>7</sup>
2.0 i		09.97-08.05	100/141			0986 473 062		← 57	1987 470 005 <sup>7</sup>	
2.0 Turbo						0986 474 062		→ 57	1987 470 005 <sup>7</sup>	
2.2 i		09.00-08.05	108			0986 473 062		← 57	1987 470 005 <sup>7</sup>	
						0986 474 062		→ 57	1987 470 005 <sup>7</sup>	
	1.2 i		09.97-08.05	48/55			0986 475 143		↔ 19,05	
	1.4 i		09.97-08.05	66			0986 475 143		↔ 19,05	
	1.6 i, i Dualfuel		09.97-08.05	55/62/63-73/74			0986 475 143		↔ 19,05	
	1.7 CDTI, DT, DTI		03.98-08.05	50/55/59			0986 475 143		↔ 19,05	
	1.2 i		09.97-08.05	48/55	Fg.-Nr. →Y2147599, →Y5154158, →Y6069183	4SB	0986 473 324		← 34	
							0986 474 324		→ 34	
					Fg.-Nr. →Y8074627	4SB	0986 473 324		← 34	
							0986 474 324		→ 34	
	1.4 i		09.97-08.05	66	Fg.-Nr. →Y2147599, →Y5154158, →Y6069183	4SB	0986 473 324		← 34	
							0986 474 324		→ 34	
					Fg.-Nr. →Y8074627	4SB	0986 473 324		← 34	
							0986 474 324		→ 34	
			09.00-08.05	66			LUC	0986 473 252		← 34
								0986 474 252		→ 34
	1.6 i		09.97-08.05	55	Fg.-Nr. →Y2147599, →Y5154158, →Y6069183	4SB	0986 473 324		← 34	
								0986 474 324		→ 34
					Fg.-Nr. →Y8074627	4SB	0986 473 324		← 34	
								0986 474 324		→ 34
				74	Fg.-Nr. →Y2147599, →Y5154158, →Y6069183	4SB	0986 473 324		← 34	
								0986 474 324		→ 34
					Fg.-Nr. →Y8074627	4SB	0986 473 324		← 34	
								0986 474 324		→ 34
			09.00-08.05	62			LUC	0986 473 252		← 34
								0986 474 252		→ 34
					Fg.-Nr. →Y2147599, →Y5154158, →Y6069183	4SB	0986 473 324		← 34	
								0986 474 324		→ 34
					Fg.-Nr. →Y8074627	4SB	0986 473 324		← 34	
								0986 474 324		→ 34
				74			LUC	0986 473 252		← 34
								0986 474 252		→ 34
	1.6 i Dualfuel		09.02-08.05	63-73	Fg.-Nr. 32000001→32999999, 35000001→35999999, 36000001→ 36999999, 38000001→38999999		LUC	0986 474 261		→ 36
					Fg.-Nr. 42000001→, 45000001→, 46000001→, 48000001→		LUC	0986 473 258		← 38
								0986 474 258		→ 38
	1.7 CDTI		03.03-08.05	59			LUC	0986 473 252		← 34
1.7 DT		03.98-08.00	50	Fg.-Nr. →Y2147599, →Y5154158, →Y6069183	4SB		0986 473 324		← 34	
							0986 474 324		→ 34	

		S							
<b>1.7 DT</b>		03.98-08.00	50		Fg.-Nr. →Y8074627	4SB	0 986 473 324		← 34
							0 986 474 324		→ 34
<b>1.7 DTi</b>		09.00-08.05	55			LUC	0 986 473 252		← 34
							0 986 474 252		→ 34
					Fg.-Nr. →Y2147599, →Y5154158, →Y6069183	4SB	0 986 473 324		← 34
					Fg.-Nr. →Y8074627	4SB	0 986 473 324		← 34
							0 986 474 324		→ 34
<b>1.8 i</b>		09.00-08.05	92			LUC	0 986 473 252		← 34
							0 986 474 252		→ 34
	ABO	09.97-08.00	85		Fg.-Nr. →Y2147599, →Y5154288, →Y6069183		0 986 473 324		← 34
							0 986 474 324		→ 34
	ABS	09.97-08.00	85				0 986 473 325		← 36
							0 986 474 325		→ 36
		09.00-08.05	92				0 986 473 325		← 36
							0 986 474 325		→ 36
						LUC	0 986 474 261		→ 36
<b>1.8 i Dualfuel</b>	ABO	09.02-08.05	87-93			LUC	0 986 473 252		← 34
	ABS	09.02-08.05	87-93		Fg.-Nr. →32999999, →35999999, →36999999, →38999999	LUC	0 986 474 261		→ 36
					Fg.-Nr. Y2147600→, Y5133295→, Y6069184→, Y8074628→	BSY	0 986 473 325		← 36
							0 986 474 325		→ 36
					Fg.-Nr. 42000001→, 45000001→, 46000001→, 48000001→	LUC	0 986 134 313		←
							0 986 135 313		→
<b>2.0 DTi</b>		09.00-08.05	74			LUC	0 986 474 261		→ 36
<b>2.0 DTi</b>	ABS	09.97-08.05	74/100				0 986 473 325		← 36
<b>2.0 i</b>							0 986 474 325		→ 36
<b>2.0 DTL</b>		09.00-08.05	60			LUC	0 986 473 252		← 34
							0 986 474 252		→ 34
	ABO	03.98-08.05	60		Fg.-Nr. →Y2147599, →Y5154288, →Y6069183		0 986 473 324		← 34
					Fg.-Nr. →Y8074627		0 986 474 324		→ 34
							0 986 473 324		← 34
							0 986 474 324		→ 34
	ABS	03.98-08.05	60				0 986 473 325		← 36
							0 986 474 325		→ 36
		09.00-08.05	60			LUC	0 986 474 261		→ 36
<b>2.0 Turbo</b>		09.02-08.05	141			LUC	0 986 473 223		← 38,1
							0 986 474 223		→ 38,1
<b>2.2 i</b>		09.00-08.05	108			LUC	0 986 474 261		→ 36
	ABS	09.00-08.05	108				0 986 473 325		← 36
							0 986 474 325		→ 36

		<b>1.2 i</b>	09.97-08.05	48/55		SSZ,STB	1 987 477 764		1254
						STB	1 987 477 764		1254
					Fg.-Nr. →X2240264, →X6125306, →X8116202	4SB	1 987 477 767		1577
					Fg.-Nr. X2240265→, X6125307→, X8116203→	4SB	1 987 477 527		1593
		<b>1.4 i</b>	09.97-08.05	66		SSZ,STB	1 987 477 764		1254
						STB	1 987 477 764		1254
					Fg.-Nr. →X2240264, →X6125306, →X8116202	4SB	1 987 477 767		1577
					Fg.-Nr. X2240265→, X6125307→, X8116203→	4SB	1 987 477 527		1593
		<b>1.6 i</b>	09.97-08.05	55/62		SSZ,STB	1 987 477 764		1254
						STB	1 987 477 764		1254
					Fg.-Nr. →X2240264, →X6125306, →X8116202	4SB	1 987 477 767		1577
					Fg.-Nr. X2240265→, X6125307→, X8116203→	4SB	1 987 477 527		1593





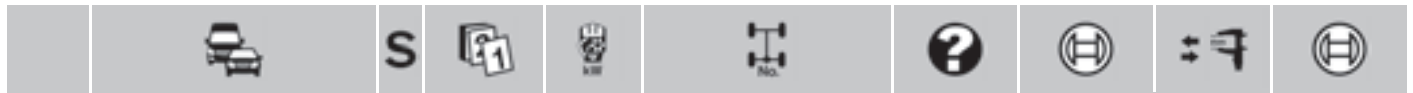

VAUXHALL Astra Estate [G]

1.6 i	09.97-08.05	74	SSZ,STB	1987 477 764	1254	
			STB	1987 477 764	1254	
			Fg.-Nr. →X2240264, →X6125306, →X8116202	4SB	1987 477 767	1577
			Fg.-Nr. X2240265→, X6125307→, X8116203→	4SB	1987 477 527	1593
1.6 i Dualfuel	09.02-08.05	63-73	SSZ,STB	1987 477 764	1254	
			4SB	1987 477 527	1593	
1.7 CDTI	03.03-08.05	59	Fg.-Nr. →22006460, →25003001, →16999999, →28006254, →1B999999	4SB	1987 477 527	1593
			Fg.-Nr. 22006461→32999999, 25003002→35999999, 26000001→36999999, 28006255→38999999, 2B000001→3B999999	4SB	1987 482 102	1592
			Fg.-Nr. 42000001→, 45000001→, 46000001→, 48000001→, 4B000001→	4SB	1987 482 537	1587
			SSZ,STB	1987 477 764	1254	
1.7 DTI	03.98-08.05	50/55	STB	1987 477 764	1254	
1.7 DTI			Fg.-Nr. →X2240264, →X6125306, →X8116202	4SB	1987 477 767	1577
			Fg.-Nr. X2240265→, X6125307→, X8116203→	4SB	1987 477 527	1593
			SSZ,STB	1987 477 764	1254	
1.8 i	09.97-08.00	85	Fg.-Nr. →X2240264, →X6125306, →X8116202	4SB	1987 477 767	1577
			Fg.-Nr. X2240265→, X6125307→, X8116203→	4SB	1987 477 527	↔ 1593
			SSZ,STB	1987 477 764	1254	
	09.00-08.05	92		1987 477 527	↔ 1593	
1.8 i Dualfuel	09.02-08.05	87-93	STB	1987 477 764	1254	
			Fg.-Nr. →22006460, →25003001, →16999999, →28006254, →1B999999	4SB	1987 477 527	1593
2.0 DTI	09.00-08.05	74		1987 477 527	↔ 1593	
2.0 DTL	03.98-08.00	60	Fg.-Nr. →X2240264, →X6125306, →X8116202	4SB	1987 477 767	1577
			Fg.-Nr. X2240265→, X6125307→, X8116203→	4SB	1987 477 527	↔ 1593
			SSZ,STB	1987 477 764	1254	
	09.00-08.05	60		1987 477 527	↔ 1593	
2.0 i	09.97-08.05	100	Fg.-Nr. →X2240264, →X6125306, →X8116202	4SB	1987 477 767	1577
			Fg.-Nr. X2240265→, X6125307→, X8116203→	4SB	1987 477 527	↔ 1593
2.0 Turbo	09.02-08.05	141		1987 477 527	↔ 1593	
2.2 i	09.00-08.05	108		1987 477 527	↔ 1593	

Astra Estate [H]



1.2 Twinport	03.07-03.09	59		0986 473 062	← 57	1987 470 005 <sup>7</sup>
				0986 474 062	→ 57	1987 470 005 <sup>7</sup>
1.3 CDTI	06.05-03.10	66	SBJ	0986 473 062	← 57	1987 470 005 <sup>7</sup>
				0986 474 062	→ 57	1987 470 005 <sup>7</sup>
1.4	08.04-03.10	55/66		0986 473 062	← 57	1987 470 005 <sup>7</sup>
1.4 Twinport				0986 474 062	→ 57	1987 470 005 <sup>7</sup>
1.6	09.07-03.10	85		0986 473 062	← 57	1987 470 005 <sup>7</sup>
				0986 474 062	→ 57	1987 470 005 <sup>7</sup>
1.6 Twinport	08.04-03.07	77		0986 473 062	← 57	1987 470 005 <sup>7</sup>
				0986 474 062	→ 57	1987 470 005 <sup>7</sup>
			09.07-03.09	77		0986 473 062
				0986 474 062	→ 57	1987 470 005 <sup>7</sup>

	S									
1.7 CDTI	08.04-03.07	59/74				0986 473 062	↻ ← 57	1987 470 005 <sup>7</sup>		
						0986 474 062	↻ → 57	1987 470 005 <sup>7</sup>		
	03.07-03.10	81/92				0986 473 062	↻ ← 57	1987 470 005 <sup>7</sup>		
						0986 474 062	↻ → 57	1987 470 005 <sup>7</sup>		
	03.10-12.12	81/92				0986 473 062	↻ ← 57	1987 470 005 <sup>7</sup>		
						0986 474 062	↻ → 57	1987 470 005 <sup>7</sup>		
1.8 i	08.04-02.09	92				0986 473 062	↻ ← 57	1987 470 005 <sup>7</sup>		
						0986 474 062	↻ → 57	1987 470 005 <sup>7</sup>		
	08.05-03.10	103				0986 473 062	↻ ← 57	1987 470 005 <sup>7</sup>		
						0986 474 062	↻ → 57	1987 470 005 <sup>7</sup>		
	07.10-09.13	103				0986 473 062	↻ ← 57	1987 470 005 <sup>7</sup>		
						0986 474 062	↻ → 57	1987 470 005 <sup>7</sup>		
1.9 CDTI	08.04-03.10	74/88/110	0986 473 062	↻ ← 57	1987 470 005 <sup>7</sup>					
			0986 474 062	↻ → 57	1987 470 005 <sup>7</sup>					
2.0 Turbo	08.04-03.10	125/147/	0986 473 062	↻ ← 57	1987 470 005 <sup>7</sup>					
2.0 Turbo 16V		177	0986 474 062	↻ → 57	1987 470 005 <sup>7</sup>					
	1.2 Twinport	03.07-03.09	59			0986 475 869	↔ 20,64			
	1.3 CDTI	06.05-03.10	66			0986 475 869	↔ 20,64			
	1.8 i	08.05-03.10	103			0986 475 869	↔ 20,64			
	1.9 CDTI	09.05-03.10	74/88			0986 475 869	↔ 20,64			
	1.2 Twinport	03.07-03.09	59		4LO, SBJ	0986 473 474	↻ ← 36			
						0986 474 474	↻ → 36			
						5LO, SBJ	0986 473 258	↻ ← 38		
						0986 474 258	↻ → 38			
	1.3 CDTI	06.05-03.10	66			4LO, SBJ	0986 473 474	↻ ← 36		
							0986 474 474	↻ → 36		
							5LO, SBJ	0986 473 258	↻ ← 38	
							0986 474 258	↻ → 38		
	1.4	08.04-03.10	55/66				0986 473 258	↻ ← 38		
							0986 474 258	↻ → 38		
	1.6	09.07-03.10	85			4LO, SBJ	0986 473 474	↻ ← 36		
							0986 474 474	↻ → 36		
							5LO, SBJ	0986 473 258	↻ ← 38	
							0986 474 258	↻ → 38		
	1.6 Twinport	08.04-03.07	77				0986 473 258	↻ ← 38		
							0986 474 258	↻ → 38		
		09.07-03.09	77				4LO	0986 473 474	↻ ← 36	
							0986 474 474	↻ → 36		
		5LO	0986 473 258				↻ ← 38			
			0986 474 258				↻ → 38			
1.7 CDTI	08.04-03.07	59/74				0986 473 258	↻ ← 38			
						0986 474 258	↻ → 38			
	03.07-03.10	81/92				0986 473 258	↻ ← 38			
						0986 474 258	↻ → 38			
	03.10-12.12	81/92				4LO, SBJ	0986 473 474	↻ ← 36		
						0986 474 474	↻ → 36			
						5LO, SBJ	0986 473 258	↻ ← 38		
						0986 474 258	↻ → 38			
1.8 i	08.04-02.09	92				0986 473 258	↻ ← 38			
						0986 474 258	↻ → 38			
	08.05-03.10	103				4LO, SBJ	0986 473 474	↻ ← 36		
						0986 474 474	↻ → 36			
	5LO, SBJ	0986 473 258				↻ ← 38				
		0986 474 258				↻ → 38				
07.10-09.13	103	SBJ	0986 473 258	↻ ← 38						
		0986 474 258	↻ → 38							
1.9 CDTI	08.04-03.10	74/88/110	0986 473 258	↻ ← 38						
			0986 474 258	↻ → 38						

















			S				?			
<b>VAUXHALL Astra Estate [H]</b>										
	2.0 Turbo	08.04-03.10	125/147/					0986 473 258		← 38
	2.0 Turbo 16V		177					0986 474 258		→ 38
	1.2 Twinport	03.07-03.09	59	Fg.-Nr. →45999999, →48999999				1987 477 934		1760
				Fg.-Nr. 62000001→, 65000001→, 68000001→				1987 477 934		1760
	1.3 CDTI	06.05-03.10	66	Fg.-Nr. →45999999, →48999999				1987 477 934		1760
				Fg.-Nr. 62000001→, 65000001→, 68000001→				1987 477 934		1760
	1.4	08.04-03.10	55/66	Fg.-Nr. →45999999, →48999999				1987 477 934		1760
	1.4 Twinport			Fg.-Nr. 62000001→, 65000001→, 68000001→				1987 477 934		1760
	1.6	09.07-03.10	85/132	Fg.-Nr. →45999999, →48999999				1987 477 934		1760
	1.6 Turbo			Fg.-Nr. 62000001→, 65000001→, 68000001→				1987 477 934		1760
	1.6 Twinport	08.04-03.07	77	Fg.-Nr. →45999999, →48999999				1987 477 934		1760
				Fg.-Nr. 62000001→, 65000001→, 68000001→				1987 477 934		1760
		09.07-03.09	77	Fg.-Nr. →45999999, →48999999				1987 477 934		1760
				Fg.-Nr. 62000001→, 65000001→, 68000001→				1987 477 934		1760
	1.7 CDTI	08.04-03.07	59/74	Fg.-Nr. →45999999, →48999999				1987 477 934		1760
				Fg.-Nr. 62000001→, 65000001→, 68000001→				1987 477 934		1760
		03.07-03.10	81/92	Fg.-Nr. →45999999, →48999999				1987 477 934		1760
				Fg.-Nr. 62000001→, 65000001→, 68000001→				1987 477 934		1760
		03.10-12.12	81/92					1987 477 934		1760
	1.8 i	08.04-02.09	92	Fg.-Nr. →45999999, →48999999				1987 477 934		1760
				Fg.-Nr. 62000001→, 65000001→, 68000001→				1987 477 934		1760
		08.05-03.10	103		STB			1987 477 908		1326
					4SB			1987 477 909		1665
		07.10-09.13	103					1987 477 934		1760
	1.9 CDTI	08.04-03.10	74/88/110	Fg.-Nr. →45999999, →48999999				1987 477 934		1760
				Fg.-Nr. 62000001→, 65000001→, 68000001→				1987 477 934		1760
	2.0 Turbo	08.04-03.10	125/147/	Fg.-Nr. →45999999, →48999999				1987 477 934		1760
	2.0 Turbo 16V		177	Fg.-Nr. 62000001→, 65000001→, 68000001→				1987 477 934		1760
<b>Astra [F]</b>										
	2.0 i	09.91-02.98	85					0986 473 905		← 52
								0986 473 906		→ 52
	2.0 i	09.91-02.98	85					0986 473 947		← 35
								0986 473 948		→ 35
	1.4 i	09.90-02.98	44/60/66		ABM,STB,TW			1987 477 129		↔ 1690
					4SB,ABM,TW			1987 477 258		↔ 1398
	1.6 i	09.91-02.98	52/55/74		ABM,STB,TW			1987 477 129		↔ 1690
					4SB,ABM,TW			1987 477 258		↔ 1398
	1.7 D/DR	12.91-02.98	42-44/50/60		ABM,STB,TW			1987 477 129		↔ 1690
					4SB,ABM,TW			1987 477 258		↔ 1398
	1.7 DTL	07.95-02.98	42-44/50/60		ABM,STB,TW			1987 477 129		↔ 1690
					4SB,ABM,TW			1987 477 258		↔ 1398
	1.7 TD	12.91-02.98	42-44/50/60		ABM,STB,TW			1987 477 129		↔ 1690
					4SB,ABM,TW			1987 477 258		↔ 1398
	1.8 i	09.91-02.98	66/82/85/92		ABM,STB,TW			1987 477 129		↔ 1690
					4SB,ABM,TW			1987 477 258		↔ 1398
	2.0 i	09.91-02.98	85/100/110		ABM,STB,TW			1987 477 129		↔ 1690
					4SB,ABM,TW			1987 477 258		↔ 1398
	1.4 i	09.90-02.98	44/60/66					0986 594 026 <sup>3</sup>		
	1.6 i	09.91-02.98	52/55/74					0986 594 026 <sup>3</sup>		
	1.7 D/DR, DTL, TD	12.91-02.98	42-44/50/60					0986 594 026 <sup>3</sup>		
	1.8 i	09.91-02.98	66/85/92					0986 594 026 <sup>3</sup>		

















































		S							
2.0i		09.91-02.98	85/100/110						0 986 594 026 <sup>3</sup>
<b>Astra [G]</b>									
	1.2i	09.97-08.05	48/55		STB				0 986 473 058  ← 48 0 986 474 058  → 48
	1.6i	ABS 09.00-08.05	74						0 986 473 062  ← 57 1 987 470 005 <sup>7</sup> 0 986 474 062  → 57 1 987 470 005 <sup>7</sup>
	1.7 CDTI 16V	03.03-08.05	59						0 986 473 057  ← 52 0 986 474 057  → 52
	1.8i Dualfuel	ABO 09.02-08.05	87-93						0 986 473 057  ← 52 0 986 474 057  → 52
	1.8i	ABS 09.97-08.05	85/87-93						0 986 473 062  ← 57 1 987 470 005 <sup>7</sup> 0 986 474 062  → 57 1 987 470 005 <sup>7</sup>
	1.8i Dualfuel								
	2.0 DTI	ABS 03.98-08.05	60/74						0 986 473 062  ← 57 1 987 470 005 <sup>7</sup> 0 986 474 062  → 57 1 987 470 005 <sup>7</sup>
	2.0 DTL								
	2.0i	09.97-08.05	100/118/						0 986 473 062  ← 57 1 987 470 005 <sup>7</sup> 0 986 474 062  → 57 1 987 470 005 <sup>7</sup>
	2.0 Turbo		141						
	2.2 DTI	09.00-08.05	92/108						0 986 473 062  ← 57 1 987 470 005 <sup>7</sup> 0 986 474 062  → 57 1 987 470 005 <sup>7</sup>
	2.2i								
	1.2i	09.97-08.05	48/55						0 986 475 143  ↔ 19,05
	1.4i	09.97-08.05	66						0 986 475 143  ↔ 19,05
	1.6i	09.97-08.05	55/62/74						0 986 475 143  ↔ 19,05
	1.7 CDTI 16V, DT, DTI	03.98-08.05	50/55/59						0 986 475 143  ↔ 19,05
	2.0 Turbo	07.02-08.05	141						0 986 475 143  ↔ 19,05
	1.2i	09.97-08.00	48	Fg.-Nr. →Y2147599, →Y5154158, →Y6069183	4SB				0 986 473 324  ← 34 0 986 474 324  → 34
				Fg.-Nr. →Y8074627	4SB				0 986 473 324  ← 34 0 986 474 324  → 34
		09.00-08.05	55		LUC				0 986 473 252  ← 34 0 986 474 252  → 34
				Fg.-Nr. →Y2147599, →Y5154158, →Y6069183	4SB				0 986 473 324  ← 34 0 986 474 324  → 34
				Fg.-Nr. →Y8074627	4SB				0 986 473 324  ← 34 0 986 474 324  → 34
	1.4i	09.97-08.05	66	Fg.-Nr. →Y2147599, →Y5154158, →Y6069183	4SB				0 986 473 324  ← 34 0 986 474 324  → 34
				Fg.-Nr. →Y8074627	4SB				0 986 473 324  ← 34 0 986 474 324  → 34
		09.00-08.05	66		LUC				0 986 473 252  ← 34 0 986 474 252  → 34
	1.6i	09.97-08.05	55	Fg.-Nr. →Y2147599, →Y5154158, →Y6069183	4SB				0 986 473 324  ← 34 0 986 474 324  → 34
				Fg.-Nr. →Y8074627	4SB				0 986 473 324  ← 34 0 986 474 324  → 34
			62/74	Fg.-Nr. →Y2147599, →Y5154158, →Y6069183	4SB				0 986 473 324  ← 34 0 986 474 324  → 34
				Fg.-Nr. →Y8074627	4SB				0 986 473 324  ← 34 0 986 474 324  → 34
		09.00-08.05	62/74		LUC				0 986 473 252  ← 34 0 986 474 252  → 34
	1.7 CDTI 16V	03.03-08.05	59		LUC				0 986 473 252  ← 34
	1.7 DT	03.98-08.00	50	Fg.-Nr. →Y2147599, →Y5154158, →Y6069183	4SB				0 986 473 324  ← 34 0 986 474 324  → 34
				Fg.-Nr. →Y8074627	4SB				0 986 473 324  ← 34 0 986 474 324  → 34
	1.7 DTI	09.00-08.05	55		LUC				0 986 473 252  ← 34 0 986 474 252  → 34



		S							
1.7 DTI		09.00-08.05	55	Fg.-Nr. →Y2147599, →Y5154158, →Y6069183	4SB		0986 473 324		← 34
				Fg.-Nr. →Y8074627	4SB		0986 474 324		→ 34
							0986 473 324		← 34
							0986 474 324		→ 34
1.8 i		09.00-08.05	92		LUC		0986 473 252		← 34
							0986 474 252		→ 34
	ABO	09.97-08.00	85	Fg.-Nr. →Y2147599, →Y5154288, →Y6069183			0986 473 324		← 34
							0986 474 324		→ 34
	ABS	09.97-08.00	85				0986 473 325		← 36
							0986 474 325		→ 36
		09.00-08.05	92				0986 473 325		← 36
							0986 474 325		→ 36
					LUC		0986 474 261		→ 36
1.8 i Dualfuel	ABO	09.02-08.05	87-93		LUC		0986 473 252		← 34
	ABS	09.02-08.05	87-93	Fg.-Nr. →32999999, →35999999, →36999999, →38999999	LUC		0986 474 261		→ 36
				Fg.-Nr. Y2147600→, Y5133295→, Y6069184→, Y8074628→	BSY		0986 473 325		← 36
							0986 474 325		→ 36
				Fg.-Nr. 42000001→, 45000001→, 46000001→, 48000001→	LUC		0986 134 313		←
							0986 135 313		→
2.0 DTI		09.00-08.05	74		LUC		0986 474 261		→ 36
2.0 DTI	ABS	09.97-08.05	74/100				0986 473 325		← 36
2.0 i							0986 474 325		→ 36
2.0 DTL		09.00-08.05	60		LUC		0986 473 252		← 34
							0986 474 252		→ 34
	ABO	03.98-08.05	60	Fg.-Nr. →Y2147599, →Y5154288, →Y6069183			0986 473 324		← 34
				Fg.-Nr. →Y8074627			0986 474 324		→ 34
							0986 473 324		← 34
							0986 474 324		→ 34
	ABS	03.98-08.05	60				0986 473 325		← 36
							0986 474 325		→ 36
		09.00-08.05	60		LUC		0986 474 261		→ 36
2.0 i		09.00-08.05	118	Fg.-Nr. →Y2147599, →Y5151036, →Y6069183			0986 473 326		← 38
				Fg.-Nr. →Y8074627			0986 474 326		→ 38
							0986 473 326		← 38
							0986 474 326		→ 38
2.0 Turbo		07.02-08.05	141		LUC		0986 473 223		← 38,1
							0986 474 223		→ 38,1
				Fg.-Nr. 32000001→32999999, 35000001→35999999, 36000001→ 36999999, 38000001→38999999	LUC		0986 474 261		→ 36
				Fg.-Nr. 42000001→, 45000001→, 46000001→, 48000001→	LUC		0986 473 258		← 38
							0986 474 258		→ 38
2.2 DTI, i		09.00-08.05	92/108		LUC		0986 474 261		→ 36
2.2 i	ABS	09.00-08.05	108				0986 473 325		← 36
							0986 474 325		→ 36
1.2 i		09.97-08.05	48/55		SSZ,STB		1987 477 764		1254
					STB		1987 477 764		1254
				Fg.-Nr. →X2240264, →X6125306, →X8116202	4SB		1987 477 767		1577
				Fg.-Nr. X2240265→, X6125307→, X8116203→	4SB		1987 477 527		1593
1.4 i		09.97-08.05	66		SSZ,STB		1987 477 764		1254
					STB		1987 477 764		1254
				Fg.-Nr. →X2240264, →X6125306, →X8116202	4SB		1987 477 767		1577
				Fg.-Nr. X2240265→, X6125307→, X8116203→	4SB		1987 477 527		1593
1.6 i		09.97-08.05	55/62/74		SSZ,STB		1987 477 764		1254
					STB		1987 477 764		1254

		S							
1.6i		09.97-08.05	55/62/74	Fg.-Nr. →X2240264, →X6125306, →X8116202	4SB		1 987 477 767		1577
				Fg.-Nr. X2240265→, X6125307→, X8116203→	4SB		1 987 477 527		1593
1.7 CDTi 16V		03.03-08.05	59	Fg.-Nr. →22006460, →25003001, →16999999, →28006254, →1B999999	4SB		1 987 477 527		1593
				Fg.-Nr. 22006461→32999999, 4SB 25003002→35999999, 26000001→36999999, 28006255→38999999, 2B000001→3B999999	4SB		1 987 482 102		1592
				Fg.-Nr. 42000001→, 45000001→, 46000001→, 48000001→, 4B000001→	4SB		1 987 482 537		1587
1.7 DT		03.98-08.05	50/55		SSZ,STB		1 987 477 764		1254
1.7 DTi					STB		1 987 477 764		1254
				Fg.-Nr. →X2240264, →X6125306, →X8116202	4SB		1 987 477 767		1577
				Fg.-Nr. X2240265→, X6125307→, X8116203→	4SB		1 987 477 527		1593
1.8i		09.97-08.00	85	Fg.-Nr. →X2240264, →X6125306, →X8116202	4SB		1 987 477 767		1577
				Fg.-Nr. X2240265→, X6125307→, X8116203→	4SB		1 987 477 527	↔	1593
		09.00-08.05	92				1 987 477 527	↔	1593
1.8i Dualfuel		09.02-08.05	87-93		STB		1 987 477 764		1254
				Fg.-Nr. →22006460, →25003001, →16999999, →28006254, →1B999999	4SB		1 987 477 527		1593
2.0 DTi		09.00-08.05	74				1 987 477 527	↔	1593
2.0 DTL		03.98-08.00	60	Fg.-Nr. →X2240264, →X6125306, →X8116202	4SB		1 987 477 767		1577
				Fg.-Nr. X2240265→, X6125307→, X8116203→	4SB		1 987 477 527	↔	1593
		09.00-08.05	60				1 987 477 527	↔	1593
2.0i		09.97-08.05	100	Fg.-Nr. →X2240264, →X6125306, →X8116202	4SB		1 987 477 767		1577
				Fg.-Nr. X2240265→, X6125307→, X8116203→	4SB		1 987 477 527	↔	1593
		09.00-08.05	118				1 987 477 527	↔	1593
2.0 Turbo		07.02-08.05	141		STB		1 987 477 764		1254
				Fg.-Nr. →22006460, →25003001, →16999999, →28006254, →1B999999	4SB		1 987 477 527		1593
				Fg.-Nr. 22006461→32999999, 4SB 25003002→35999999, 26000001→36999999, 28006255→38999999, 2B000001→3B999999	4SB		1 987 482 102		1592
				Fg.-Nr. 42000001→, 45000001→, 46000001→, 48000001→, 4B000001→	4SB		1 987 482 537		1587
2.2i		09.00-08.05	108				1 987 477 527	↔	1593
<b>Astra GTC [H]</b>									
									
	1.4 Twinport	06.05-03.09	55/66		SBJ		0 986 473 062	 ← 57	1 987 470 005 <sup>7</sup>
							0 986 474 062	 → 57	1 987 470 005 <sup>7</sup>
	1.6	09.05-12.12	77/85		SBJ		0 986 473 062	 ← 57	1 987 470 005 <sup>7</sup>
	1.6 Twinport, VVT						0 986 474 062	 → 57	1 987 470 005 <sup>7</sup>

		S							
	◀ VAUXHALL Astra GTC [H]								
1.7 CDTI	06.05-12.09	59/74/81/92		SBJ		0986 473 062		← 57	1987 470 0057
						0986 474 062		→ 57	1987 470 0057
1.8 i	06.05-02.09	92		SBJ		0986 473 062		← 57	1987 470 0057
						0986 474 062		→ 57	1987 470 0057
1.8 i VVT	01.11-12.12	103		SBJ		0986 473 062		← 57	1987 470 0057
						0986 474 062		→ 57	1987 470 0057
1.9 CDTI	06.05-12.09	88/110		SBJ		0986 473 062		← 57	1987 470 0057
						0986 474 062		→ 57	1987 470 0057
2.0 Turbo	06.05-12.09	125/147/177		SBJ		0986 473 062		← 57	1987 470 0057
2.0 Turbo 16V						0986 474 062		→ 57	1987 470 0057
	1.4 Twinport	06.05-03.09	55/66			0986 475 869		↔ 20,64	
	1.6	01.11-12.12	85			0986 475 949		↔ 19,05	
	1.6 Twinport	09.05-03.08	77			0986 475 869		↔ 20,64	
	1.6 VVT	12.06-12.12	85		TW	0986 475 869		↔ 20,64	
						0986 475 949		↔ 19,05	
	1.7 CDTI	06.05-03.07	59/74			0986 475 869		↔ 20,64	
	1.8 i	06.05-02.09	92			0986 475 869		↔ 20,64	
	1.8 i VVT	01.11-12.12	103			0986 475 949		↔ 19,05	
	1.9 CDTI	06.05-12.09	88/110			0986 475 869		↔ 20,64	
	2.0 Turbo, Turbo 16V	06.05-12.09	125/147/177			0986 475 869		↔ 20,64	
	1.4 Twinport	06.05-03.09	55/66		4LO,SBJ	0986 473 474		← 36	
						0986 474 474		→ 36	
					5LO,SBJ	0986 473 258		← 38	
						0986 474 258		→ 38	
	1.6	09.05-12.12	77/85		4LO,SBJ	0986 473 474		← 36	
	1.6 Twinport					0986 474 474		→ 36	
	1.6 VVT				5LO,SBJ	0986 473 258		← 38	
						0986 474 258		→ 38	
	1.7 CDTI	06.05-12.09	59/74/81/92		4LO,SBJ	0986 473 474		← 36	
						0986 474 474		→ 36	
					5LO,SBJ	0986 473 258		← 38	
						0986 474 258		→ 38	
	1.8 i	06.05-02.09	92		4LO,SBJ	0986 473 474		← 36	
						0986 474 474		→ 36	
					5LO,SBJ	0986 473 258		← 38	
						0986 474 258		→ 38	
	1.8 i VVT	01.11-12.12	103		4LO,SBJ	0986 473 474		← 36	
						0986 474 474		→ 36	
					5LO,SBJ	0986 473 258		← 38	
						0986 474 258		→ 38	
	1.9 CDTI	06.05-12.09	88/110		4LO,SBJ	0986 473 474		← 36	
						0986 474 474		→ 36	
					5LO,SBJ	0986 473 258		← 38	
						0986 474 258		→ 38	
	2.0 Turbo	06.05-12.09	125/147/177		4LO,SBJ	0986 473 474		← 36	
	2.0 Turbo 16V					0986 474 474		→ 36	
					5LO,SBJ	0986 473 258		← 38	
						0986 474 258		→ 38	
	1.4 Twinport	06.05-03.09	55/66		STB	1987 477 908			1326
					4SB	1987 477 909			1665
	1.6	01.11-12.12	85		STB	1987 477 908			1326
	1.6	12.06-12.12	85		STB,TW	1987 482 382			187
	1.6 VVT					1987 482 449			182
	1.6 Twinport	09.05-03.08	77		STB	1987 477 908			1326
					4SB	1987 477 909			1665
	1.6 VVT	12.06-12.12	85		STB	1987 477 908			1326
					4SB,TW	1987 477 909			1665

		S							
1.7 CDTI		06.05-03.07	59/74			STB	1 987 477 908	1326	
						4SB	1 987 477 909	1665	
		03.07-12.09	81/92			4SB	1 987 477 909	1665	
1.8 i		06.05-02.09	92			STB	1 987 477 908	1326	
						4SB	1 987 477 909	1665	
1.8 i VVT		01.11-12.12	103			STB	1 987 477 908	1326	
						STB,TW	1 987 482 382	187	
							1 987 482 449	182	
1.9 CDTI		06.05-12.09	88/110			4SB	1 987 477 909	1665	
2.0 Turbo, Turbo 16V		06.05-12.09	125/147/177			4SB	1 987 477 909	1665	
<b>Astra GTC [J]</b>									
									
	1.4 Turbo	09.11→	88/103			D32	0 986 134 319	 ← 60	
							0 986 135 319	 → 60	
	1.6 Turbo	09.11→	132/147			D32	0 986 134 319	 ← 60	
							0 986 135 319	 → 60	
	1.7	11.11→	81/96			D32	0 986 134 319	 ← 60	
							0 986 135 319	 → 60	
	2.0	09.11→	121			D32	0 986 134 319	 ← 60	
							0 986 135 319	 → 60	
									
	1.4 Turbo	09.11→	88/103			FEB	1 987 482 535	→ 1816	
							1 987 482 536	← 1812	
	1.6 Turbo	09.11→	132/147			FEB	1 987 482 535	→ 1816	
							1 987 482 536	← 1812	
	1.7	11.11→	81/96			FEB	1 987 482 535	→ 1816	
							1 987 482 536	← 1812	
	2.0	09.11→	121			FEB	1 987 482 535	→ 1816	
							1 987 482 536	← 1812	
<b>Astra [H]</b>									
									
	1.2 Twinport	03.07-03.09	59				0 986 473 062	 ← 57	1 987 470 005 <sup>7</sup>
							0 986 474 062	 → 57	1 987 470 005 <sup>7</sup>
	1.3 CDTI	01.06-03.10	66			SBJ	0 986 473 062	 ← 57	1 987 470 005 <sup>7</sup>
							0 986 474 062	 → 57	1 987 470 005 <sup>7</sup>
	1.4 i, Twinport, Twinport Dualfuel	03.04-03.10	55/66				0 986 473 062	 ← 57	1 987 470 005 <sup>7</sup>
							0 986 474 062	 → 57	1 987 470 005 <sup>7</sup>
	1.6	03.07-03.10	85				0 986 473 062	 ← 57	1 987 470 005 <sup>7</sup>
							0 986 474 062	 → 57	1 987 470 005 <sup>7</sup>
		01.11-09.13	85			SBJ	0 986 473 062	 ← 57	1 987 470 005 <sup>7</sup>
							0 986 474 062	 → 57	1 987 470 005 <sup>7</sup>
	1.6 Turbo	01.11-09.13	132			SBJ	0 986 473 062	 ← 57	1 987 470 005 <sup>7</sup>
							0 986 474 062	 → 57	1 987 470 005 <sup>7</sup>
	1.6 Twinport	03.04-03.09	77				0 986 473 062	 ← 57	1 987 470 005 <sup>7</sup>
							0 986 474 062	 → 57	1 987 470 005 <sup>7</sup>
	1.7 CDTI	03.04-09.09	59/74/81				0 986 473 062	 ← 57	1 987 470 005 <sup>7</sup>
							0 986 474 062	 → 57	1 987 470 005 <sup>7</sup>
		05.07-03.10	92				0 986 473 062	 ← 57	1 987 470 005 <sup>7</sup>
							0 986 474 062	 → 57	1 987 470 005 <sup>7</sup>
		03.10-12.12	92			SBJ	0 986 473 062	 ← 57	1 987 470 005 <sup>7</sup>
							0 986 474 062	 → 57	1 987 470 005 <sup>7</sup>
	1.8 i	03.04-02.09	92				0 986 473 062	 ← 57	1 987 470 005 <sup>7</sup>
							0 986 474 062	 → 57	1 987 470 005 <sup>7</sup>
		08.05-03.10	103			SBJ	0 986 473 062	 ← 57	1 987 470 005 <sup>7</sup>
							0 986 474 062	 → 57	1 987 470 005 <sup>7</sup>
		07.10-09.13	103			SBJ	0 986 473 062	 ← 57	1 987 470 005 <sup>7</sup>
							0 986 474 062	 → 57	1 987 470 005 <sup>7</sup>





		S							
	◀ VAUXHALL Astra [H]								
1.9 CDTI	03.04-03.10	74/88/110	0986 473 062		← 57	1987 470 0057			
			0986 474 062		→ 57	1987 470 0057			
2.0 Turbo	03.04-03.10	125/147/	0986 473 062		← 57	1987 470 0057			
2.0 Turbo 16V		177	0986 474 062		→ 57	1987 470 0057			
	1.2 Twinport	03.07-03.09	59	0986 475 869		↔ 20,64			
	1.3 CDTI	01.06-03.10	66	0986 475 869		↔ 20,64			
	1.4 Twinport	03.04-03.10	66	0986 475 869	TW	↔ 20,64			
				0986 475 949		↔ 19,05			
	1.6 Twinport	03.04-03.07	77	0986 475 869	TW	↔ 20,64			
				0986 475 949		↔ 19,05			
	1.7 CDTI	03.10-12.12	92	0986 475 949		↔ 19,05			
	1.8 i	03.04-02.09	92	0986 475 869	TW	↔ 20,64			
				0986 475 949		↔ 19,05			
		08.05-03.10	103	0986 475 869		↔ 20,64			
	1.9 CDTI	09.05-03.10	74/88	0986 475 869		↔ 20,64			
	1.2 Twinport	03.07-03.09	59	4LO,SBJ	0986 473 474		← 36		
					0986 474 474		→ 36		
				5LO,SBJ	0986 473 258		← 38		
					0986 474 258		→ 38		
	1.3 CDTI	01.06-03.10	66	4LO,SBJ	0986 473 474		← 36		
					0986 474 474		→ 36		
				5LO,SBJ	0986 473 258		← 38		
					0986 474 258		→ 38		
	1.4 i	09.04-12.05	55		0986 473 258		← 38		
					0986 474 258		→ 38		
	1.4 Twinport	03.04-03.10	66	SPF	0986 473 258		← 38		
	1.4 Twinport Dualfuel			SPN	0986 474 258		→ 38		
					0986 473 474		← 36		
					0986 474 474		→ 36		
	1.6	03.07-03.10	85	4LO,SBJ	0986 473 474		← 36		
					0986 474 474		→ 36		
				5LO,SBJ	0986 473 258		← 38		
					0986 474 258		→ 38		
		01.11-09.13	85	SBJ	0986 473 258		← 38		
					0986 474 258		→ 38		
	1.6 Turbo	01.11-09.13	132	SBJ	0986 473 258		← 38		
					0986 474 258		→ 38		
	1.6 Twinport	03.04-03.07	77	SPF	0986 473 258		← 38		
				SPN	0986 474 258		→ 38		
					0986 473 474		← 36		
					0986 474 474		→ 36		
		03.07-03.09	77	4LO	0986 473 474		← 36		
					0986 474 474		→ 36		
				5LO	0986 473 258		← 38		
					0986 474 258		→ 38		
	1.7 CDTI	03.04-09.09	59/74/81		0986 473 258		← 38		
					0986 474 258		→ 38		
		05.07-03.10	92		0986 473 258		← 38		
					0986 474 258		→ 38		
		03.10-12.12	92	4LO,SBJ	0986 473 474		← 36		
					0986 474 474		→ 36		
				5LO,SBJ	0986 473 258		← 38		
					0986 474 258		→ 38		
	1.8 i	03.04-02.09	92		0986 473 258		← 38		
					0986 474 258		→ 38		
		08.05-03.10	103	4LO,SBJ	0986 473 474		← 36		
					0986 474 474		→ 36		
				5LO,SBJ	0986 473 258		← 38		
					0986 474 258		→ 38		

		S							
<b>1.8 i</b>		07.10-09.13	103			SBJ	0 986 473 258		← 38
							0 986 474 258		→ 38
<b>1.9 CDTI</b>		03.04-03.10	74/88/110				0 986 473 258		← 38
							0 986 474 258		→ 38
<b>2.0 Turbo</b>		03.04-03.10	125/147/				0 986 473 258		← 38
<b>2.0 Turbo 16V</b>			177				0 986 474 258		→ 38
	<b>1.2 Twinport</b>	03.07-03.09	59			STB	1 987 477 908		1326
						4SB	1 987 477 909		1665
	<b>1.3 CDTI</b>	01.06-03.10	66			STB	1 987 477 908		1326
						4SB	1 987 477 909		1665
	<b>1.4 i, Twinport, Twinport Dualfuel</b>	03.04-03.10	55/66			STB	1 987 477 908		1326
						4SB	1 987 477 909		1665
	<b>1.6</b>	03.04-03.10	77/85			STB	1 987 477 908		1326
	<b>1.6 Twinport</b>					4SB	1 987 477 909		1665
	<b>1.6 Turbo</b>	03.07-03.10	132			STB	1 987 477 908		1326
						4SB	1 987 477 909		1665
		01.11-09.13	132			TW	1 987 477 909		1665
	<b>1.7 CDTI</b>	03.04-09.09	59/74/81			STB	1 987 477 908		1326
						4SB	1 987 477 909		1665
		05.07-03.10	92			4SB	1 987 477 909		1665
		05.07-12.12	92			STB	1 987 477 908		1326
		03.10-12.12	92			STB	1 987 482 382		187
	<b>1.8 i</b>	03.04-03.10	92/103			STB	1 987 477 908		1326
						4SB	1 987 477 909		1665
	<b>1.9 CDTI</b>	03.04-03.10	74/88/110			STB	1 987 477 908		1326
						4SB	1 987 477 909		1665
	<b>2.0 Turbo</b>	03.04-03.10	125/147/			STB	1 987 477 908		1326
	<b>2.0 Turbo 16V</b>		177			4SB	1 987 477 909		1665
<b>Astra [J]</b>									
	<b>1.3 CDTI</b>	09.09→	70			D32	0 986 134 319		← 60
							0 986 135 319		→ 60
	<b>1.4 i</b>	09.09→	64/74/88/			D32	0 986 134 319		← 60
	<b>1.4 Turbo</b>		103				0 986 135 319		→ 60
	<b>1.6 CDTI, GTC, i, i Turbo</b>	09.09→	81/85/100/			D32	0 986 134 319		← 60
			132				0 986 135 319		→ 60
	<b>1.7 CDTI</b>	09.09→	81/92/96			D32	0 986 134 319		← 60
							0 986 135 319		→ 60
	<b>2.0 CDTI</b>	09.09→	118/121/			D32	0 986 134 319		← 60
	<b>2.0 GTC</b>		143				0 986 135 319		→ 60
	<b>1.3 CDTI</b>	09.09→	70			FEB	1 987 482 502		→ 1814
							1 987 482 503		← 1812
	<b>1.4 i</b>	09.09→	64/74/88/			FEB	1 987 482 502		→ 1814
	<b>1.4 Turbo</b>		103				1 987 482 503		← 1812
	<b>1.6 CDTI</b>	10.13→	81			FEB	1 987 482 502		→ 1814
							1 987 482 503		← 1812
			100			FEB	1 987 482 502		→ 1814
							1 987 482 503		← 1812
	<b>1.6 GTC</b>	06.14→	81			FEB	1 987 482 535		→ 1816
							1 987 482 536		← 1812
			100			FEB	1 987 482 535		→ 1816
							1 987 482 536		← 1812
	<b>1.6 i</b>	09.09→	85			FEB	1 987 482 502		→ 1814
							1 987 482 503		← 1812
	<b>1.6 i Turbo</b>	09.09→	132			FEB	1 987 482 502		→ 1814
							1 987 482 503		← 1812



		S							
	◀ VAUXHALL Astra [J]								
		09.09→	81/92/96			FEB	1987 482 502	→ 1814	
							1987 482 503	← 1812	
		09.09→	118/121			FEB	1987 482 502	→ 1814	
							1987 482 503	← 1812	
		08.12→	143			FEB	1987 482 502	→ 1814	
							1987 482 503	← 1812	
		08.12→	143			FEB	1987 482 535	→ 1816	
							1987 482 536	← 1812	
		06.12→	206			FEB	1987 482 535	→ 1816	
							1987 482 536	← 1812	
<b>Astra Sport Tourer</b>									
		01.12→	96			D32	0986 134 319	← 60	
							0986 135 319	→ 60	
		01.12→	96			FEB	1987 482 502	→ 1814	
							1987 482 503	← 1812	
<b>Astra Sports Tourer</b>									
		01.12→	81/96			D32	0986 134 319	← 60	
							0986 135 319	→ 60	
		01.12→	81/96			FEB	1987 482 502	→ 1814	
							1987 482 503	← 1812	
<b>Astra Sports Tourer [J]</b>									
		09.10→	70			D32	0986 134 319	← 60	
							0986 135 319	→ 60	
		09.10→	74/103			D32	0986 134 319	← 60	
							0986 135 319	→ 60	
		09.10→	81/85/100			D32	0986 134 319	← 60	
							0986 135 319	→ 60	
		09.10→	81/92			D32	0986 134 319	← 60	
							0986 135 319	→ 60	
		09.10→	118/121/ 143			D32	0986 134 319	← 60	
							0986 135 319	→ 60	
		09.10→	70			FEB	1987 482 502	→ 1814	
							1987 482 503	← 1812	
		09.10→	74/103			FEB	1987 482 502	→ 1814	
							1987 482 503	← 1812	
		09.10→	81/85/100			FEB	1987 482 502	→ 1814	
							1987 482 503	← 1812	
		09.10→	81/92			FEB	1987 482 502	→ 1814	
							1987 482 503	← 1812	
		09.10→	118/121/ 143			FEB	1987 482 502	→ 1814	
							1987 482 503	← 1812	





**Astra TwinTop [H]**

	<b>1.6 i</b>	09.05-12.09	76-77/85/		SBJ	0 986 473 062	☞ ← 57 1 987 470 005 <sup>7</sup>
	<b>1.6 i Turbo</b>		132			0 986 474 062	☞ → 57 1 987 470 005 <sup>7</sup>
	<b>1.8 i</b>	03.06-03.09	103		SBJ	0 986 473 062	☞ ← 57 1 987 470 005 <sup>7</sup>
						0 986 474 062	☞ → 57 1 987 470 005 <sup>7</sup>
	<b>1.9 CDTi</b>	09.05-12.09	110		SBJ	0 986 473 062	☞ ← 57 1 987 470 005 <sup>7</sup>
						0 986 474 062	☞ → 57 1 987 470 005 <sup>7</sup>
	<b>2.0 i Turbo</b>	09.05-12.09	125/147		SBJ	0 986 473 062	☞ ← 57 1 987 470 005 <sup>7</sup>
						0 986 474 062	☞ → 57 1 987 470 005 <sup>7</sup>

	<b>1.6 i</b>	09.05-03.08	76-77			0 986 475 869	↔ 20,64
		03.07-12.09	85			0 986 475 949	↔ 19,05
	<b>1.8 i</b>	03.06-03.09	103			0 986 475 869	↔ 20,64
	<b>1.9 CDTi</b>	09.05-12.09	110			0 986 475 869	↔ 20,64
	<b>2.0 i Turbo</b>	09.05-12.09	125/147			0 986 475 869	↔ 20,64

	<b>1.6 i</b>	09.05-12.09	76-77/85/		4LO,SBJ	0 986 473 474	☞ ← 36
	<b>1.6 i Turbo</b>		132			0 986 474 474	☞ → 36
					5LO,SBJ	0 986 473 258	☞ ← 38
						0 986 474 258	☞ → 38
	<b>1.8 i</b>	03.06-03.09	103		4LO,SBJ	0 986 473 474	☞ ← 36
						0 986 474 474	☞ → 36
					5LO,SBJ	0 986 473 258	☞ ← 38
						0 986 474 258	☞ → 38
	<b>1.9 CDTi</b>	09.05-12.09	110		4LO,SBJ	0 986 473 474	☞ ← 36
						0 986 474 474	☞ → 36
					5LO,SBJ	0 986 473 258	☞ ← 38
						0 986 474 258	☞ → 38
	<b>2.0 i Turbo</b>	09.05-12.09	125/147		4LO,SBJ	0 986 473 474	☞ ← 36
						0 986 474 474	☞ → 36
					5LO,SBJ	0 986 473 258	☞ ← 38
						0 986 474 258	☞ → 38

	<b>1.6 i</b>	09.05-12.09	76-77/85/		STB	1 987 477 908	1326
	<b>1.6 i Turbo</b>		132		4SB	1 987 477 909	1665
	<b>1.8 i</b>	03.06-03.09	103		STB	1 987 477 908	1326
					4SB	1 987 477 909	1665
	<b>1.9 CDTi</b>	09.05-12.09	110		STB	1 987 477 908	1326
					4SB	1 987 477 909	1665
	<b>2.0 i Turbo</b>	09.05-12.09	125/147		STB	1 987 477 908	1326
					4SB	1 987 477 909	1665



















































**Astra Van [F]**

	<b>1.4 i</b>	09.90-02.98	44		ABM,STB,TW	1 987 477 129	↔ 1690
						1 987 477 258	↔ 1398
	<b>1.6 i</b>	09.91-02.98	52/55		ABM,STB,TW	1 987 477 129	↔ 1690
						1 987 477 258	↔ 1398
	<b>1.7 D/DR</b>	12.91-02.98	42-44/50		ABM,STB,TW	1 987 477 129	↔ 1690
						1 987 477 258	↔ 1398
	<b>1.7 DTL</b>	07.95-02.98	42-44/50		ABM,STB,TW	1 987 477 129	↔ 1690
						1 987 477 258	↔ 1398
	<b>1.4 i</b>	09.90-02.98	44			0 986 594 026 <sup>3</sup>	
	<b>1.6 i</b>	09.91-02.98	52/55			0 986 594 026 <sup>3</sup>	
	<b>1.7 D/DR, DTL</b>	12.91-02.98	42-44/50			0 986 594 026 <sup>3</sup>	



			S								
◀ VAUXHALL											
<b>Astra Van [G]</b>											
	1.7 CDTI		03.03-08.05	59				0986 473 057		← 52	
								0986 474 057		→ 52	
	2.0 DTI	ABS	03.98-08.05	60/74				0986 473 062		← 57	
	2.0 DTL							0986 474 062		→ 57	
	1.6 i		09.97-08.05	55/62				0986 475 143		↔ 19,05	
	1.7 CDTI		03.03-08.05	59				0986 475 143		↔ 19,05	
	1.7 DT		03.98-08.00	50				0986 475 143		↔ 19,05	
	1.6 i		09.97-08.05	55	Fg.-Nr. →Y2147599, →Y5154158, →Y6069183	4SB		0986 473 324		← 34	
					Fg.-Nr. →Y8074627	4SB		0986 474 324		→ 34	
								0986 473 324		← 34	
								0986 474 324		→ 34	
			09.00-08.05	62			LUC	0986 473 252		← 34	
								0986 474 252		→ 34	
						Fg.-Nr. →Y2147599, →Y5154158, →Y6069183	4SB	0986 473 324		← 34	
						Fg.-Nr. →Y8074627	4SB	0986 474 324		→ 34	
								0986 473 324		← 34	
								0986 474 324		→ 34	
		1.7 CDTI		03.03-08.05	59			LUC	0986 473 252		← 34
		1.7 DT		03.98-08.00	50	Fg.-Nr. →Y2147599, →Y5154158, →Y6069183	4SB		0986 473 324		← 34
					Fg.-Nr. →Y8074627	4SB		0986 474 324		→ 34	
								0986 473 324		← 34	
								0986 474 324		→ 34	
	2.0 DTI		09.00-08.05	74			LUC	0986 474 261		→ 36	
	2.0 DTI	ABS	03.98-08.05	60/74				0986 473 325		← 36	
	2.0 DTL							0986 474 325		→ 36	
	2.0 DTL	ABO	03.98-08.00	60	Fg.-Nr. →Y2147599, →Y5154288, →Y6069183			0986 473 324		← 34	
					Fg.-Nr. →Y8074627			0986 474 324		→ 34	
								0986 473 324		← 34	
								0986 474 324		→ 34	
	1.6 i		09.97-08.05	55/62			SSZ,STB	1987 477 764		1254	
							STB	1987 477 764		1254	
						Fg.-Nr. →X2240264, →X6125306, →X8116202	4SB	1987 477 767		1577	
						Fg.-Nr. X2240265→, X6125307→, X8116203→	4SB	1987 477 527		1593	
		1.7 CDTI		03.03-08.05	59	Fg.-Nr. →22006460, →25003001, →16999999, →28006254, →1B999999	4SB	1987 477 527		1593	
						Fg.-Nr. 22006461→32999999, 25003002→35999999, 26000001→36999999, 28006255→38999999, 2B000001→3B999999	4SB	1987 482 102		1592	
						Fg.-Nr. 42000001→, 45000001→, 46000001→, 48000001→, 4B000001→	4SB	1987 482 537		1587	
		1.7 DT		03.98-08.00	50			SSZ,STB	1987 477 764		1254
								STB	1987 477 764		1254
						Fg.-Nr. →X2240264, →X6125306, →X8116202	4SB	1987 477 767		1577	
						Fg.-Nr. X2240265→, X6125307→, X8116203→	4SB	1987 477 527		1593	
		2.0 DTI		09.00-08.05	74				1987 477 527		↔ 1593



		S							
2.0 DTL		03.98-08.00	60	Fg.-Nr. →X2240264, →X6125306, →X8116202	4SB		1 987 477 767	1577	
				Fg.-Nr. X2240265→, X6125307→, X8116203→	4SB		1 987 477 527	↔1593	
<b>Brava Pick-Up [TF0]</b>									
									
 2.2 D		06.89-09.96	39		AA		0 986 473 306	 ← 60	
							0 986 474 306	 → 60	
2.3		09.91-09.96	69/72		AA		0 986 473 306	 ← 60	
2.3 i							0 986 474 306	 → 60	
2.5 D		02.89-12.96	56-74		AA		0 986 473 306	 ← 60	
2.5 TD							0 986 474 306	 → 60	
									
 2.2 D		06.89-09.95	39				0 986 475 807	↔25,4	
2.3, i		09.91-09.95	69/72				0 986 475 807	↔25,4	
2.5 D, TD		02.89-09.95	56-74				0 986 475 807	↔25,4	
<b>Brava Pick-Up [TF1]</b>									
									
 2.5 TD		03.97-08.02	56		AA		0 986 473 306	 ← 60	
							0 986 474 306	 → 60	
3.1 TD		03.97-08.02	80		AA		0 986 473 306	 ← 60	
							0 986 474 306	 → 60	
									
 2.5 TD		03.97-08.02	56				0 986 475 807	↔25,4	
3.1 TD		03.97-08.02	80				0 986 475 807	↔25,4	
<b>Calibra</b>									
									
 2.0 i		03.90-03.98	83-85/100/ 110				0 986 473 905	 ← 52	
							0 986 473 906	 → 52	
					AA		0 986 473 913	 ← 54	
							0 986 473 914	 → 54	
2.0 i turbo		03.92-07.97	150	Fg.-Nr. T1000001→, T9000001→			0 986 473 056	 ← 57	1 987 470 005 <sup>7</sup>
							0 986 474 056	 → 57	1 987 470 005 <sup>7</sup>
2.5 i V6		04.93-03.97	125	Fg.-Nr. T1000001→, T9000001→			0 986 473 056	 ← 57	1 987 470 005 <sup>7</sup>
							0 986 474 056	 → 57	1 987 470 005 <sup>7</sup>
									
 2.0 i		03.90-03.98	83-85/100/ 110/150				0 986 473 947	 ← 35	
2.0 i turbo							0 986 473 948	 → 35	
2.5 i V6		04.93-03.97	125	Fg.-Nr. →T1000582, →T9000000			0 986 473 947	 ← 35	
							0 986 473 948	 → 35	
					AA		0 986 473 943	 ← 33	
							0 986 473 944	 → 33	
				Fg.-Nr. T1000583→, T9000001→			0 986 473 949	 ← 35	
							0 986 473 950	 → 35	
					AA		0 986 473 947	 ← 35	
							0 986 473 948	 → 35	
									
 2.0 i, i turbo		03.90-03.98	83-85/100/110/150				1 987 477 130	1498	
2.5 i V6		04.93-03.97	125				1 987 477 130	1498	



















































◀ VAUXHALL Calibra									
	2.0i	03.90-03.98	83-85/100/	Fg.-Nr. L1000001→M1999999		0 265 001 206 <sup>3</sup>			
	2.0i turbo		110/150		AA,LAB	0 265 001 226 <sup>4</sup>			
					LAB,NAA	0 265 001 233 <sup>4</sup>			
					NAA,RAB	0 265 001 232 <sup>4</sup>			
				Fg.-Nr. N1000001→	AA,LAB	0 265 006 487 <sup>4</sup>			
					AA,RAB	0 265 006 486 <sup>4</sup>			
					LAB,NAA	0 265 003 094 <sup>4</sup>			
					NAA,RAB	0 265 003 093 <sup>4</sup>			
	2.5iV6	04.93-03.97	125	Fg.-Nr. L1000001→M1999999		0 265 001 206 <sup>3</sup>			
					AA,LAB	0 265 001 226 <sup>4</sup>			
				LAB,NAA	0 265 001 233 <sup>4</sup>				
				NAA,RAB	0 265 001 232 <sup>4</sup>				
			Fg.-Nr. N1000001→	AA,LAB	0 265 006 487 <sup>4</sup>				
				AA,RAB	0 265 006 486 <sup>4</sup>				
				LAB,NAA	0 265 003 094 <sup>4</sup>				
				NAA,RAB	0 265 003 093 <sup>4</sup>				
<b>Carlton III</b>									
	1.8	09.86-10.94	65-66/85	Fg.-Nr. →L1019854	DMO	0 986 471 004	← 54	1 987 470 060 <sup>7</sup>	
	1.8i					0 986 473 004		1 987 470 498 <sup>8</sup>	
						0 986 472 004	→ 54	1 987 470 060 <sup>7</sup>	
						0 986 474 004			
				Fg.-Nr. L1019855→	ATE	0 986 473 913	← 54	1 987 470 060 <sup>7</sup>	
						0 986 473 913	← 54	1 987 470 498 <sup>8</sup>	
						0 986 473 914	→ 54	1 987 470 060 <sup>7</sup>	
						0 986 473 914			
	2.0i	09.86-10.94	73-74/85/	Fg.-Nr. →K1000098	DMO	0 986 471 005	← 54	1 987 470 060 <sup>7</sup>	
			90			0 986 473 005		1 987 470 498 <sup>8</sup>	
					0 986 472 005	→ 54	1 987 470 060 <sup>7</sup>		
					0 986 474 005				
			Fg.-Nr. K1000099→	ATE	0 986 473 913	← 54	1 987 470 060 <sup>7</sup>		
					0 986 473 913	← 54	1 987 470 498 <sup>8</sup>		
					0 986 473 914	→ 54	1 987 470 060 <sup>7</sup>		
2.3D	09.86-10.94	54/74	Fg.-Nr. →L1019854	DMO	0 986 471 004	← 54	1 987 470 060 <sup>7</sup>		
2.3TD Interc.					0 986 473 004		1 987 470 498 <sup>8</sup>		
					0 986 472 004	→ 54	1 987 470 060 <sup>7</sup>		
					0 986 474 004				
			Fg.-Nr. L1019855→	ATE	0 986 473 913	← 54	1 987 470 060 <sup>7</sup>		
					0 986 473 913	← 54	1 987 470 498 <sup>8</sup>		
					0 986 473 914	→ 54	1 987 470 060 <sup>7</sup>		
2.4i	09.86-10.94	92	Fg.-Nr. →K1000098	DMO	0 986 471 005	← 54	1 987 470 060 <sup>7</sup>		
					0 986 473 005		1 987 470 498 <sup>8</sup>		
					0 986 472 005	→ 54	1 987 470 060 <sup>7</sup>		
					0 986 474 005				
			Fg.-Nr. K1000099→	ATE	0 986 473 913	← 54	1 987 470 060 <sup>7</sup>		
					0 986 473 913	← 54	1 987 470 498 <sup>8</sup>		
					0 986 473 914	→ 54	1 987 470 060 <sup>7</sup>		
2.6i	09.90-10.94	110	Fg.-Nr. →L1999999	ATE	0 986 474 860	← 60			
					0 986 474 861	→ 60			
			Fg.-Nr. M1000001→	GIR	0 986 473 820	← 57			
					0 986 473 821	→ 57			
3.0i	03.87-10.94	130	Fg.-Nr. →L1999999	ATE	0 986 474 860	← 60			
					0 986 474 861	→ 60			
			Fg.-Nr. M1000001→	GIR	0 986 473 820	← 57			
					0 986 473 821	→ 57			
	01.89-10.94	147-150		GIR	0 986 473 820	← 57			
					0 986 473 821	→ 57			

		S							
	<b>1.8</b> <b>1.8i</b>	09.86-10.94	65-66/85	Fg.-Nr. →K1000098	LIM	0 986 473 945	←		
						0 986 473 947	←		
						0 986 473 946	→		
						0 986 473 948	→		
				Fg.-Nr. →K1042197	KOB	0 986 473 957	← 38		
						0 986 473 958	→ 38		
				Fg.-Nr. K1000099→	LIM	0 986 473 949	← 35		
						0 986 473 950	→ 35		
				Fg.-Nr. K1042198→	KOB	0 986 473 307	← 40		
						0 986 474 307	→ 40		
<b>2.0i</b>		09.86-10.94	73-74/85/ 90	Fg.-Nr. →K1000098	LIM	0 986 473 945	←		
						0 986 473 947	←		
						0 986 473 946	→		
						0 986 473 948	→		
				Fg.-Nr. →K1042197	KOB	0 986 473 957	← 38		
						0 986 473 958	→ 38		
				Fg.-Nr. K1000099→	LIM	0 986 473 949	← 35		
						0 986 473 950	→ 35		
				Fg.-Nr. K1042198→	KOB	0 986 473 307	← 40		
						0 986 474 307	→ 40		
<b>2.3D</b> <b>2.3TD Interc.</b>		09.86-10.94	54/74	Fg.-Nr. →K1000098	LIM	0 986 473 945	←		
						0 986 473 947	←		
						0 986 473 946	→		
						0 986 473 948	→		
				Fg.-Nr. →K1042197	KOB	0 986 473 957	← 38		
						0 986 473 958	→ 38		
				Fg.-Nr. K1000099→	LIM	0 986 473 949	← 35		
						0 986 473 950	→ 35		
				Fg.-Nr. K1042198→	KOB	0 986 473 307	← 40		
						0 986 474 307	→ 40		
<b>2.4i</b>		09.86-10.94	92	Fg.-Nr. →K1000098	LIM	0 986 473 945	←		
						0 986 473 947	←		
						0 986 473 946	→		
						0 986 473 948	→		
				Fg.-Nr. →K1042197	KOB	0 986 473 957	← 38		
						0 986 473 958	→ 38		
				Fg.-Nr. K1000099→	LIM	0 986 473 949	← 35		
						0 986 473 950	→ 35		
				Fg.-Nr. K1042198→	KOB	0 986 473 307	← 40		
						0 986 474 307	→ 40		
<b>2.6i</b>		09.90-10.94	110		KOB	0 986 473 307	← 40		
						0 986 474 307	→ 40		
				Fg.-Nr. →K1000098	LIM	0 986 473 945	←		
						0 986 473 947	←		
						0 986 473 946	→		
						0 986 473 948	→		
				Fg.-Nr. K1000099→	LIM	0 986 473 949	← 35		
						0 986 473 950	→ 35		
<b>3.0i</b>		03.87-10.94	130		KOB	0 986 473 307	← 40		
						0 986 474 307	→ 40		
				Fg.-Nr. →K1000098	LIM	0 986 473 945	←		
						0 986 473 947	←		
						0 986 473 946	→		
						0 986 473 948	→		
				Fg.-Nr. K1000099→	LIM	0 986 473 949	← 35		
						0 986 473 950	→ 35		
		01.89-10.94	147-150		KOB	0 986 473 307	← 40		
						0 986 474 307	→ 40		
					LIM	0 986 473 957	← 38		
						0 986 473 958	→ 38		





			S								
◀ VAUXHALL Carlton III											
	1.8	09.86-10.94	65-66/85					1987 477 250	↔	1550	
	1.8 i	09.86-10.94	65-66/85					1987 477 250	↔	1550	
	2.0 i	09.86-10.94	73-74/85/90					1987 477 250	↔	1550	
	2.3 D	09.86-10.94	54/74					1987 477 250	↔	1550	
	2.3 TD Interc.	09.88-10.94	54/74					1987 477 250	↔	1550	
	2.4 i	09.86-10.94	92					1987 477 250	↔	1550	
	2.6 i	09.90-10.94	110					1987 477 250	↔	1550	
	3.0 i	03.87-10.94	130/147-150					1987 477 250	↔	1550	
3.6 i	01.90-03.94	277-281					1987 477 250	↔	1550		
	1.8	09.86-10.94	65-66/85					0265 001 134			
	1.8 i							Fg.-Nr. →J1185909			
								Fg.-Nr. J1185910→			
	2.0 i	09.86-10.94	73-74/85/90					0265 001 134			
								Fg.-Nr. →J1185909			
								Fg.-Nr. J1185910→			
	2.3 D	09.86-10.94	54/74					0265 001 134			
	2.3 TD Interc.							Fg.-Nr. →J1185909			
								Fg.-Nr. J1185910→			
	2.4 i	09.86-10.94	92					0265 001 134			
								Fg.-Nr. →J1185909			
								Fg.-Nr. J1185910→			
	2.6 i	09.90-10.94	110					0265 001 134			
								Fg.-Nr. →J1185909			
							Fg.-Nr. J1185910→				
3.0 i	03.87-10.94	130/147-150					0265 001 134				
							Fg.-Nr. →J1185909				
							Fg.-Nr. J1185910→				
<b>Cascada</b>											
	1.4 Turbo	04.13→	88/103					0986 134 319		← 60	
								0986 135 319		→ 60	
	1.6 Turbo	04.13→	125/147					0986 134 319		← 60	
								0986 135 319		→ 60	
2.0 CDTI	04.13→	121/143					0986 134 319		← 60		
							0986 135 319		→ 60		
	1.4 Turbo	04.13→	88/103			FEB		1987 482 535	→	1816	
								1987 482 536	←	1812	
	1.6 Turbo	04.13→	125/147			FEB		1987 482 535	→	1816	
								1987 482 536	←	1812	
	2.0 CDTI	04.13→	121/143			FEB		1987 482 535	→	1816	
								1987 482 536	←	1812	
<b>Cavalier III</b>											
	1.4	09.88-11.95	55				Fg.-Nr. →N1038529, →M5999999	ATE	0986 473 889		← 48
									0986 473 890		→ 48
							Fg.-Nr. N1038530→, N5000001→	ATE	0986 471 899		← 48
									0986 473 899		
									0986 473 901		
									0986 471 900	→	48
									0986 473 900		
								0986 473 902			

		S										
1.6i		09.94-08.95	55	Fg.-Nr. →R7999999, →R1999999, →R5999999	ATE		0 986 471 901	← 48				
							0 986 473 901					
							0 986 471 902	→ 48				
							0 986 473 902					
		09.94-11.95	52	Fg.-Nr. →N1038529, →M5999999	ATE		0 986 473 905	 ← 52				
							0 986 473 906	 → 52				
		09.94-11.95	52	Fg.-Nr. →N1038530, →N5000001→	ATE		0 986 473 889	 ← 48				
							0 986 473 890	 → 48				
							0 986 471 899	← 48				
							0 986 473 899					
0 986 473 901												
0 986 471 900	→ 48											
1.6i KAT		09.88-11.95	55-60	Fg.-Nr. →N1038529, →M5999999	ATE		0 986 473 889	 ← 48				
							0 986 473 890	 → 48				
1.6S		09.88-11.95	55-60	Fg.-Nr. →N1038530, →N5000001→	ATE		0 986 471 899	← 48				
							0 986 473 899					
							0 986 473 901					
							0 986 471 900	→ 48				
1.7D		09.88-11.95	42/60	Fg.-Nr. →R7999999, →R1999999, →R5999999	ATE		0 986 471 901	← 48				
							0 986 473 901					
1.7TD		09.88-11.95	42/60	Fg.-Nr. →R7999999, →R1999999, →R5999999	ATE		0 986 471 902	→ 48				
							0 986 473 902					
1.8		09.88-11.95	65/66	Fg.-Nr. →R7999999, →R1999999, →R5999999	ATE		0 986 473 905	 ← 52				
							0 986 473 906	 → 52				
1.8i		09.88-11.95	65/66	Fg.-Nr. →R7999999, →R1999999, →R5999999	ATE		0 986 471 901	← 48				
							0 986 473 901					
1.8S		09.88-11.95	65/66	Fg.-Nr. →R7999999, →R1999999, →R5999999	ATE		0 986 471 902	→ 48				
							0 986 473 902					
2.0i		09.88-08.95	95		ATE		0 986 473 905	 ← 52				
							0 986 473 906	 → 52				
2.0i 4x4		09.88-08.95	95		AA	ATE	0 986 473 913	 ← 54	1 987 470 060 <sup>7</sup>			
							0 986 473 913	 ← 54	1 987 470 498 <sup>8</sup>			
2.0i 16V		09.88-11.95	110		ATE		0 986 473 914	 → 54	1 987 470 060 <sup>7</sup>			
							0 986 473 905	 ← 52				
2.0i 16V 4x4		09.88-11.95	110		AA	ATE	0 986 473 906	 → 52				
							0 986 473 905	 ← 52				
2.0i 16V 4x4		09.88-11.95	110		AA	ATE	0 986 473 905	 ← 52				
							0 986 473 906	 → 52				
2.0i 16V 4x4		09.88-11.95	110		AA	ATE	0 986 473 913	 ← 54	1 987 470 060 <sup>7</sup>			
							0 986 473 913	 ← 54	1 987 470 498 <sup>8</sup>			
2.0i 16V 4x4		09.88-11.95	110		AA	ATE	0 986 473 914	 → 54	1 987 470 060 <sup>7</sup>			
							0 986 473 914	 → 54	1 987 470 060 <sup>7</sup>			
		09.88-11.95	55				0 986 475 143	↔ 19,05				
							1.6i, i KAT, S	09.88-11.95	52/55-60	0 986 475 143	↔ 19,05	
							1.7D, TD	09.88-11.95	42/60	0 986 475 143	↔ 19,05	
							1.8, i, S	09.88-11.95	65/66	0 986 475 143	↔ 19,05	
		09.88-08.95	95				0 986 473 947	 ← 35				
							0 986 473 948	 → 35				
		09.88-11.95	85/86						0 986 473 947	 ← 35		
									0 986 473 948	 → 35		
2.0i 4x4		09.88-08.95	95		AA		0 986 473 943	 ← 33				
							0 986 473 944	 → 33				



		S							
<b>VAUXHALL Cavalier III</b>									
2.0 i 4x4		09.92-08.95	150			AA	0986 473 943		33
							0986 473 944		33
2.0 i 16V		09.88-11.95	110				0986 473 947		35
							0986 473 948		35
		09.93-11.95	100				0986 473 947		35
							0986 473 948		35
2.0 i 16V 4x4		09.88-11.95	110			AA	0986 473 943		33
							0986 473 944		33
2.5 i V6		02.93-11.95	125				0986 473 947		35
							0986 473 948		35
1.4		09.88-11.95	55				1987 477 140		750
							1987 477 141		2079
1.6 i, i KAT, S		09.88-11.95	52/55-60				1987 477 140		750
							1987 477 141		2079
1.7 D		09.88-11.95	42/60				1987 477 140		750
1.7 TD							1987 477 141		2079
1.8, i, S		09.88-11.95	65/66				1987 477 140		750
							1987 477 141		2079
2.0 i, i 4x4, i 16V		09.88-11.95	85/86/95/ 100				1987 477 142		665
							1987 477 143		2022
2.0 i 4x4		09.92-08.95	150				1987 477 130		1498
2.0 i 16V		09.88-11.95	110			Fg.-Nr. →N1999999, →N5999999, →NV999999	1987 477 130		1498
2.0 i 16V 4x4						Fg.-Nr. P1000001→, P5000001→, P7500001→	1987 477 142		665
							1987 477 143		2022
2.5 i V6		02.93-11.95	125				1987 477 142		665
							1987 477 143		2022
1.4		09.88-11.95	55			Fg.-Nr. →M1999999, →N5000039, →MV999999	0 265 001 206 <sup>3</sup>		
						Fg.-Nr. →NV999999, L10,RAB →N1999999, →N5999999 L13,LAB	0 265 001 207 <sup>4</sup> 0 265 001 208 <sup>4</sup>		
1.6 i		09.88-11.95	52/55-60			Fg.-Nr. →M1999999, →N5000039, →MV999999	0 265 001 206 <sup>3</sup>		
1.6 i KAT									
1.6 S						Fg.-Nr. →NV999999, L10,RAB →N1999999, →N5999999 L13,LAB	0 265 001 207 <sup>4</sup> 0 265 001 208 <sup>4</sup>		
1.7 D		09.88-11.95	42/60			Fg.-Nr. →M1999999, →N5000039, →MV999999	0 265 001 206 <sup>3</sup>		
1.7 TD						Fg.-Nr. →NV999999, L10,RAB →N1999999, →N5999999 L13,LAB	0 265 001 207 <sup>4</sup> 0 265 001 208 <sup>4</sup>		
1.8		09.88-11.95	65/66			Fg.-Nr. →M1999999, →N5000039, →MV999999	0 265 001 206 <sup>3</sup>		
1.8 i									
1.8 S						Fg.-Nr. →NV999999, L10,RAB →N1999999, →N5999999 L13,LAB	0 265 001 207 <sup>4</sup> 0 265 001 208 <sup>4</sup>		
2.0 i		09.88-08.95	95			Fg.-Nr. →NV999999, L10,RAB →N1999999, →N5999999 L13,LAB	0 265 001 207 <sup>4</sup> 0 265 001 208 <sup>4</sup>		
		09.88-11.95	85/86			Fg.-Nr. →M1999999, →N5000039, →MV999999	0 265 001 206 <sup>3</sup>		
						Fg.-Nr. →NV999999, L10,RAB →N1999999, →N5999999 L13,LAB	0 265 001 207 <sup>4</sup> 0 265 001 208 <sup>4</sup>		
2.0 i		09.88-08.95	95			Fg.-Nr. →M1999999, →N5000039, →MV999999	0 265 001 206 <sup>3</sup>		
2.0 i 4x4									
2.0 i 4x4		09.88-08.95	95			Fg.-Nr. →M1999999 AA,LAB Fg.-Nr. N1000001→ AA,LAB	0 265 001 226 <sup>4</sup> 0 265 006 487 <sup>4</sup>		
							0 265 006 486 <sup>4</sup>		
		09.92-08.95	150			Fg.-Nr. →M1999999 AA,LAB Fg.-Nr. →M1999999, →N5000039, →MV999999	0 265 001 226 <sup>4</sup> 0 265 001 206 <sup>3</sup>		
						Fg.-Nr. N1000001→ AA,LAB	0 265 006 487 <sup>4</sup>		
							0 265 006 486 <sup>4</sup>		

	S							
<b>2.0i 16V</b>	09.88-11.95	110	Fg.-Nr. →MV999999,	LAB	0 265 <b>001 233</b> <sup>4</sup>			
			→M1999999, →M5999999	RAB	0 265 <b>001 232</b> <sup>4</sup>			
	09.93-11.95	100	Fg.-Nr. →M1999999,		0 265 <b>001 206</b> <sup>3</sup>			
			→N5000039, →MV999999					
			Fg.-Nr. NV100001→	LAB	0 265 <b>003 094</b> <sup>4</sup>			
			NV999999, N1000001→	RAB	0 265 <b>003 093</b> <sup>4</sup>			
09.93-11.95	100	Fg.-Nr. →M1999999,		0 265 <b>001 206</b> <sup>3</sup>				
		→N5000039, →MV999999						
<b>2.0i 16V 4x4</b>	09.88-11.95	110	Fg.-Nr. →M1999999	L10,RAB	0 265 <b>001 207</b> <sup>4</sup>			
			→N1999999, →N5999999	L13,LAB	0 265 <b>001 208</b> <sup>4</sup>			
	09.88-11.95	110	Fg.-Nr. →M1999999	AA,LAB	0 265 <b>001 226</b> <sup>4</sup>			
			→N5000039, →MV999999		0 265 <b>001 206</b> <sup>3</sup>			
02.93-11.95	125	Fg.-Nr. N1000001→	AA,LAB	0 265 <b>006 487</b> <sup>4</sup>				
			AA,RAB	0 265 <b>006 486</b> <sup>4</sup>				
<b>2.5i V6</b>	02.93-11.95	125	Fg.-Nr. →M1999999,		0 265 <b>001 206</b> <sup>3</sup>			
			→N5000039, →MV999999					
<b>Combo</b>								
	<b>1.2i</b>	09.94-10.01	33		0 986 <b>471 899</b>	← 48		
					0 986 <b>473 899</b>			
					0 986 <b>473 901</b>			
					0 986 <b>471 900</b>	→ 48		
	09.94-10.01	44/60/66		0 986 <b>473 900</b>				
				0 986 <b>473 902</b>				
				0 986 <b>471 899</b>	← 48			
				0 986 <b>473 899</b>				
	09.94-10.01	44		0 986 <b>473 901</b>				
				0 986 <b>471 900</b>	→ 48			
				0 986 <b>473 900</b>				
				0 986 <b>473 902</b>				
<b>1.7D</b>	09.94-10.01	44		0 986 <b>471 899</b>	← 48			
				0 986 <b>473 899</b>				
				0 986 <b>473 901</b>				
				0 986 <b>471 900</b>	→ 48			
<b>1.2i</b>	09.94-10.01	33		0 986 <b>475 045</b>	↔ 22,2			
				0 986 <b>475 045</b>	↔ 22,2			
				0 986 <b>475 045</b>	↔ 22,2			
<b>1.4i</b>	09.94-10.01	44/60/66		1 987 <b>477 769</b>	1659			
				1 987 <b>477 769</b>	1659			
				1 987 <b>477 769</b>	1659			
<b>1.7D</b>	09.94-10.01	44		0 986 <b>594 025</b> <sup>4</sup>				
				0 986 <b>594 028</b> <sup>3</sup>				
				0 986 <b>594 025</b> <sup>4</sup>				
<b>1.4i</b>	09.94-10.01	44/60/66		0 986 <b>594 028</b> <sup>3</sup>				
				0 986 <b>594 025</b> <sup>4</sup>				
				0 986 <b>594 028</b> <sup>3</sup>				
<b>1.7D</b>	09.94-10.01	44		0 986 <b>594 025</b> <sup>4</sup>				
				0 986 <b>594 028</b> <sup>3</sup>				



		S				?			
◀ VAUXHALL									
<b>Combo [D]</b>									
	1.3	02.12→	66		TW	0986 475 971	↔ 25,4		
	1.4	02.12→	70/88		TW	0986 475 971	↔ 25,4		
	1.6	02.12→	66/74/77		TW	0986 475 971	↔ 25,4		
	2.0	02.12→	99		TW	0986 475 971	↔ 25,4		
<b>Combo [Tour]</b>									
	1.3 CDTi	09.04-01.12	51/55		TW	0986 473 062	← 57	1987 470 005 <sup>7</sup>	
						0986 473 991	← 54		
						0986 474 062	→ 57	1987 470 005 <sup>7</sup>	
						0986 474 991	→ 54		
	1.4 i Twinport	01.04-01.12	65/66		TW	0986 473 062	← 57	1987 470 005 <sup>7</sup>	
	1.4 i Twinport Dualfuel					0986 473 991	← 54		
						0986 474 062	→ 57	1987 470 005 <sup>7</sup>	
						0986 474 991	→ 54		
	1.6 CNG	04.05-01.12	69/71			0986 473 062	← 57	1987 470 005 <sup>7</sup>	
						0986 474 062	→ 57	1987 470 005 <sup>7</sup>	
	1.6 i	10.01-08.04	64			0986 473 991	← 54		
						0986 474 991	→ 54		
	1.7 CDTi	09.04-01.12	74			0986 473 062	← 57	1987 470 005 <sup>7</sup>	
						0986 474 062	→ 57	1987 470 005 <sup>7</sup>	
	1.7 DI	09.01-08.04	48/55			0986 473 991	← 54		
	1.7 DTI					0986 474 991	→ 54		
	1.3 CDTi	09.04-01.12	51/55			0986 475 143	↔ 19,05		
	1.4 i Twinport, i Twinport Dualfuel	01.04-01.12	65/66			0986 475 143	↔ 19,05		
	1.6 i	10.01-08.04	64			0986 475 143	↔ 19,05		
	1.7 CDTi	09.04-01.12	74			0986 475 869	↔ 20,64		
	1.7 DI, DTI	09.01-08.04	48/55			0986 475 143	↔ 19,05		
	1.3 CDTi	09.04-01.12	51/55			0986 473 258	← 38		
						0986 474 258	→ 38		
	1.4 i Twinport	01.04-01.12	65/66			0986 473 258	← 38		
	1.4 i Twinport Dualfuel					0986 474 258	→ 38		
	1.6 CNG	04.05-01.12	69/71			0986 473 258	← 38		
						0986 474 258	→ 38		
	1.6 i	10.01-08.04	64			0986 473 256	←		
						0986 474 256	→		
	1.7 CDTi	09.04-01.12	74			0986 473 258	← 38		
						0986 474 258	→ 38		
	1.7 DI	09.01-08.04	48/55			0986 473 256	←		
	1.7 DTI					0986 474 256	→		
	1.3 CDTi	09.04-01.12	51/55			1987 482 449	182		
					HTB,MI	1987 477 869	1235		
					4SB,MI	1987 482 138	1582		
	1.4 i Twinport	01.04-01.12	65/66			1987 482 449	182		
	1.4 i Twinport Dualfuel				HTB,MI	1987 477 869	1235		
					4SB,MI	1987 482 138	1582		
	1.6 CNG	04.05-05.06	71		HTB	1987 477 869	1235		
		06.06-01.12	69			1987 482 449	182		
					MI	1987 482 138	1582		
		ABO 04.05-05.06	71		4SB	1987 477 869	1235		
		ABS 04.05-05.06	71		4SB	1987 482 138	1582		
	1.6 i	10.01-08.04	64			1987 477 869	↔ 1235		

		S							
1.7 CDTi		09.04-01.12	74					1 987 482 449	182
							HTB,MI	1 987 477 869	1235
							4SB,MI	1 987 482 138	1582
1.7 DI		09.01-08.04	48/55					1 987 477 869	↔ 1235
1.7 DTI		10.01-08.04	48/55					1 987 477 869	↔ 1235
1.3 CDTi		09.04-01.12	51/55					0 986 594 027 <sup>3</sup>	
1.4 i Twinport, i Twinport Dualfuel		01.04-01.12	65/66					0 986 594 027 <sup>3</sup>	
1.6 CNG		04.05-01.12	69/71					0 986 594 027 <sup>3</sup>	
1.6 i		10.01-08.04	64					0 986 594 027 <sup>3</sup>	
1.7 CDTi, DI, DTI		09.01-01.12	48/55/74					0 986 594 027 <sup>3</sup>	
<b>Corsa [B]</b>									
1.0 i		09.96-09.00	40			GS		0 986 473 895	← 48
								0 986 473 896	→ 48
1.2 i		09.94-08.00	33/48			GS		0 986 473 895	← 48
								0 986 473 896	→ 48
						KL		0 986 473 895	← 48
								0 986 473 896	→ 48
1.4 i		09.94-08.00	44			GS		0 986 473 895	← 48
								0 986 473 896	→ 48
						KL		0 986 473 895	← 48
								0 986 473 896	→ 48
			60					0 986 471 899	← 48
								0 986 473 899	
								0 986 473 901	
								0 986 471 900	→ 48
								0 986 473 900	
								0 986 473 902	
						AG	Fg.-Nr. V3023598→, V4166926→, V6066280→	0 986 473 895	← 48
								0 986 473 896	→ 48
			63/66					0 986 471 899	← 48
								0 986 473 899	
								0 986 473 901	
								0 986 471 900	→ 48
								0 986 473 900	
								0 986 473 902	
		09.96-08.98	44					0 986 471 899	← 48
								0 986 473 899	
								0 986 473 901	
								0 986 471 900	→ 48
								0 986 473 900	
								0 986 473 902	
1.5 D, TD, XTD		09.94-08.00	37/49			GS		0 986 473 895	← 48
								0 986 473 896	→ 48
1.6 GSI		09.94-08.00	74/78/80					0 986 471 901	← 48
1.6 i								0 986 473 901	
								0 986 471 902	→ 48
								0 986 473 902	
1.7 D		09.94-08.00	44			KL		0 986 471 899	← 48
								0 986 473 899	
								0 986 473 901	
								0 986 471 900	→ 48
								0 986 473 900	
								0 986 473 902	
						KL		0 986 473 895	← 48
								0 986 473 896	→ 48



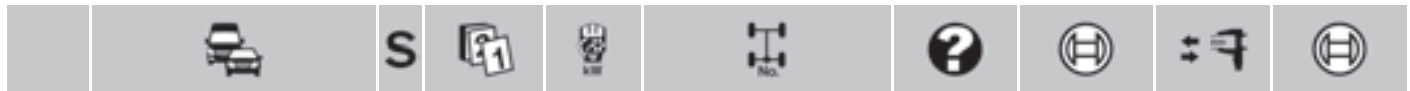

◀ VAUXHALL Corsa [B]



	<b>1.0 i</b>	09.96-09.00	40	0986 475 143	↔ 19,05
	<b>1.2 i</b>	09.94-08.00	33/48	0986 475 143	↔ 19,05
	<b>1.4 i</b>	09.94-08.00	44/60/63/66	0986 475 143	↔ 19,05
	<b>1.5 D, TD, XTD</b>	09.94-08.00	37/49	0986 475 143	↔ 19,05
	<b>1.6 GSi, i</b>	09.94-08.00	74/78/80	0986 475 143	↔ 19,05
	<b>1.7 D</b>	09.94-08.00	44	0986 475 143	↔ 19,05









































	<b>1.0 i</b>	09.96-09.00	40	1987 477 309	← 1373
				1987 477 310	→ 1078
	<b>1.2 i</b>	09.94-08.00	33/48	1987 477 309	← 1373
				1987 477 310	→ 1078
	<b>1.4 i</b>	09.94-08.00	44/60/63/66	1987 477 309	← 1373
				1987 477 310	→ 1078
	<b>1.5 D, TD, XTD</b>	09.94-08.00	37/49	1987 477 309	← 1373
				1987 477 310	→ 1078
	<b>1.6 GSi</b>	09.94-08.00	74/78/80	1987 477 309	← 1373
	<b>1.6 i</b>			1987 477 310	→ 1078
	<b>1.7 D</b>	09.94-08.00	44	1987 477 309	← 1373
				1987 477 310	→ 1078

	<b>1.0 i</b>	09.96-09.00	40	0986 594 025 <sup>4</sup>	
				0986 594 028 <sup>3</sup>	
	<b>1.2 i</b>	09.94-08.00	33/48	0986 594 025 <sup>4</sup>	
				0986 594 028 <sup>3</sup>	
	<b>1.4 i</b>	09.94-08.00	44/60/63/66	0986 594 025 <sup>4</sup>	
				0986 594 028 <sup>3</sup>	
	<b>1.5 D, TD, XTD</b>	09.94-08.00	37/49	0986 594 025 <sup>4</sup>	
				0986 594 028 <sup>3</sup>	
	<b>1.6 GSi</b>	09.94-08.00	74/78/80	0986 594 025 <sup>4</sup>	
	<b>1.6 i</b>			0986 594 028 <sup>3</sup>	
	<b>1.7 D</b>	09.94-08.00	44	0986 594 025 <sup>4</sup>	
				0986 594 028 <sup>3</sup>	

Corsa [C]



	<b>1.0 i 12V</b>	ABO	09.00-08.05	43/44	0986 473 271	↔ 48	
					0986 474 271	↔ 48	
	<b>1.0 Twinport</b>	ABS	09.00-08.05	43/44	0986 473 257	↔ 48	
					0986 474 257	↔ 48	
	<b>1.2 i 16V</b>	ABO	09.00-09.06	55/59	0986 473 271	↔ 48	
					0986 474 271	↔ 48	
	<b>1.2 Twinport</b>	ABS	09.00-09.06	55/59	0986 473 257	↔ 48	
					0986 474 257	↔ 48	
	<b>1.2 16V Dualfuel</b>					0986 473 991	↔ 54
	<b>1.3 CDTI</b>		09.03-09.06	51		0986 474 991	↔ 54
					TW	0986 473 062	↔ 57
						0986 473 991	↔ 54
						0986 474 062	↔ 57
						0986 474 991	↔ 54
			09.05-09.06	55		0986 473 991	↔ 54
						0986 474 991	↔ 54
	<b>1.4 i 16V</b>		09.00-08.05	66		0986 473 991	↔ 54
	<b>1.4 Twinport</b>					0986 474 991	↔ 54
	<b>1.7 CDTI</b>		09.03-08.05	74		0986 473 062	↔ 57
						0986 474 062	↔ 57
	<b>1.7 DI</b>		09.00-08.03	48		0986 473 257	↔ 48
						0986 474 257	↔ 48

		S							
1.7 DTI		09.00-08.03	55				0 986 473 991		← 54
							0 986 474 991		→ 54
1.8 i 16V		09.01-08.05	92				0 986 473 991		← 54
							0 986 474 991		→ 54
									
	1.0 i 12V, Twinport	09.00-08.05	43/44				0 986 475 143		↔ 19,05
	1.2 i 16V, Twinport, Twinport Dualfuel 16V Dualfuel	09.00-09.06	55/59				0 986 475 143		↔ 19,05
	1.3 CDTI	09.03-09.06	51				0 986 475 143		↔ 19,05
	1.4 i 16V, Twinport	09.00-08.05	66				0 986 475 143		↔ 19,05
	1.6 i	09.01-08.03	62				0 986 475 143		↔ 19,05
	1.7 CDTI	09.03-08.05	74				0 986 475 869		↔ 20,64
	1.7 DI, DTI	09.00-08.03	48/55				0 986 475 143		↔ 19,05
	1.8 i 16V	09.01-08.05	92				0 986 475 143		↔ 19,05
	1.0 i 12V	09.00-08.05	43/44				0 986 473 256		←
	1.0 Twinport						0 986 474 256		→
	1.2 i 16V	09.00-08.04	55				0 986 473 256		←
	1.2 16V Dualfuel						0 986 474 256		→
	1.3 CDTI	09.03-09.06	51				0 986 473 256		←
							0 986 474 256		→
	1.4 i 16V	09.00-08.05	66				0 986 473 256		←
	1.4 Twinport						0 986 474 256		→
	1.6 i	09.01-08.03	62				0 986 473 256		←
							0 986 474 256		→
	1.7 CDTI, DI, DTI	09.00-08.05	48/55/74				0 986 473 256		←
							0 986 474 256		→
	1.8 i 16V	09.01-08.05	92				0 986 473 256		←
							0 986 474 256		→
									
	1.0 i 12V	09.00-08.03	43			SPN	1 987 477 667		330
						STB	1 987 477 661		→ 832
						4SB	1 987 477 669		→ 1143
							1 987 477 670		← 1426
						Fg.-Nr. →14195342	STB	1 987 477 660	← 1095
						Fg.-Nr. 14195343→	SSZ,STB	1 987 477 529	← 1106
	1.0 Twinport	09.03-08.05	44			SPN	1 987 477 667		330
						STB	1 987 477 529		← 1106
							1 987 477 661		→ 832
						4SB	1 987 477 669		→ 1143
							1 987 477 670		← 1426
	1.2 i 16V	09.00-08.04	55			SPN	1 987 477 667		330
	1.2 16V Dualfuel					STB	1 987 477 661		→ 832
						4SB	1 987 477 669		→ 1143
							1 987 477 670		← 1426
						Fg.-Nr. →14195342	STB	1 987 477 660	← 1095
						Fg.-Nr. 14195343→	SSZ,STB	1 987 477 529	← 1106
	1.2 Twinport	09.04-09.06	59				1 987 477 529		← 1106
	1.2 Twinport Dualfuel						1 987 477 661		→ 832
						SPN	1 987 477 667		330
	1.3 CDTI	09.03-09.06	51			SSZ,STB	1 987 477 660		← 1095
						SPN	1 987 477 667		330
						SSZ,STB	1 987 477 529		← 1106
						STB	1 987 477 529		← 1106
							1 987 477 661		→ 832
						4SB	1 987 477 669		→ 1143
							1 987 477 670		← 1426
							1 987 482 449		182
		ABO 09.03-09.06	51			MI	1 987 477 869		1235
						STB	1 987 482 251		→ 217

































◀ VAUXHALL Corsa [C]

<b>1.3 CDTI</b>	ABO	09.05-09.06	55			1987 482 251	↔ 217
	ABS	09.03-09.06	51		MI	1987 482 138	1582
					STB	1987 482 461	→ 217
						1987 482 461	↔ 217
<b>1.4 i 16V</b>		09.00-08.05	66		SPN	1987 477 667	330
<b>1.4 Twinport</b>					STB	1987 477 529	← 1106
						1987 477 661	→ 832
					4SB	1987 477 669	→ 1143
						1987 477 670	← 1426
<b>1.6 i</b>		09.01-08.03	62		SPN	1987 477 667	330
					STB	1987 477 660	← 1095
						1987 477 661	→ 832
					4SB	1987 477 669	→ 1143
						1987 477 670	← 1426
<b>1.7 CDTI</b>		09.03-08.05	74		STB	1987 477 529	← 1106
						1987 477 661	→ 832
					4SB	1987 477 669	→ 1143
						1987 477 670	← 1426
<b>1.7 DI</b>		09.00-08.03	48		SPN	1987 477 667	330
					STB	1987 477 661	→ 832
					4SB	1987 477 669	→ 1143
						1987 477 670	← 1426
				Fg.-Nr. →14195342	STB	1987 477 660	← 1095
				Fg.-Nr. 14195343→	SSZ,STB	1987 477 529	← 1106
<b>1.7 DTI</b>		09.00-08.03	55		SPN	1987 477 667	330
					STB	1987 477 529	← 1106
						1987 477 661	→ 832
					4SB	1987 477 669	→ 1143
						1987 477 670	← 1426
<b>1.8 i 16V</b>		09.01-08.05	92		SPN	1987 477 667	330
					4SB	1987 477 669	→ 1143
						1987 477 670	← 1426

	<b>1.0 i 12V, Twinport</b>	09.00-08.05	43/44			0986 594 027 <sup>3</sup>	
	<b>1.2 i 16V, Twinport, Twinport Dualfuel 16V Dualfuel</b>	09.00-09.06	55/59			0986 594 027 <sup>3</sup>	
	<b>1.3 CDTI</b>	09.03-09.06	51/55			0986 594 027 <sup>3</sup>	
	<b>1.4 i 16V, Twinport</b>	09.00-08.05	66			0986 594 027 <sup>3</sup>	
	<b>1.6 i</b>	09.01-08.03	62			0986 594 027 <sup>3</sup>	
	<b>1.7 DI, DTI</b>	09.00-08.03	48/55			0986 594 027 <sup>3</sup>	
	<b>1.8 i 16V</b>	09.01-08.05	92			0986 594 027 <sup>3</sup>	

**Corsa [D]**

	<b>1.0 Twinport</b>	07.06-10.09	44		INB	0 204 902 032	← 54
						0986 473 487	↻
						0 204 902 033	→ 54
						0986 474 487	↻
					INB	0 204 902 030	←
						0 204 902 031	→
		12.09→	48			0 204 902 032	← 54
						0986 473 487	↻
						0 204 902 033	→ 54
						0986 474 487	↻
	<b>1.2 i LPG</b>	07.06→	51/55-59/			0 204 902 032	← 54
	<b>1.2 i Twinport</b>		63			0986 473 487	↻
	<b>1.2 Twinport</b>					0 204 902 033	→ 54
						0986 474 487	↻
<b>1.3 CDTI</b>		07.06-03.09	55		D84	0 204 004 566	← 54
						0986 134 077	↻
						0 204 004 567	→ 54
						0986 135 077	↻

		S													
<b>1.3</b> CDTI		07.06-03.09	55			257	0 204 902 032	← 54							
							0 986 473 487								
							0 204 902 033	→ 54							
							0 986 474 487								
							07.06-07.10	66	0 204 004 566	← 54					
									0 986 134 077						
									0 204 004 567	→ 54					
							12.09-09.10	70	D84	0 204 004 566	← 54				
										0 986 134 077					
										0 204 004 567	→ 54				
												257	0 204 902 032	← 54	
													0 986 473 487		
0 204 902 033	→ 54														
0 986 474 487															
01.11→	55	0 204 902 032	← 54												
		0 986 473 487													
					70	D84	0 204 004 566	← 54							
							0 986 134 077								
							0 204 004 567	→ 54							
										257	0 204 902 032	← 54			
											0 986 473 487				
											0 204 902 033	→ 54			
<b>1.4</b> LPG <b>1.4</b> Twinport		07.06-11.10	65-66	Fg.-Nr. →74098700, →76034354		0 204 004 564	→ 54								
						0 986 473 487									
						Fg.-Nr. 74098701→, 76034355→	0 204 004 565	← 54							
							0 986 474 487								
						0 204 902 032	← 54								
						0 986 473 487									
<b>1.4</b> Twinport		12.09→	64			0 204 902 032	← 54								
						0 986 473 487									
						74	0 204 902 033	→ 54							
							0 986 474 487								
												0 204 902 032	← 54		
												0 986 473 487			
<b>1.6</b> i OPC Turbo		02.07-06.10	141						1 987 470 005 <sup>7</sup>						
							01.11→	141	Fg.-Nr. →B4157375, →B6047744	KZB	1 987 470 005 <sup>7</sup>				
									Fg.-Nr. B4157376→, B6047745→	KZU	1 987 470 005 <sup>7</sup>				
<b>1.6</b> i Turbo		10.07→	110				0 986 473 062		← 57	1 987 470 005 <sup>7</sup>					
							0 986 474 062		→ 57	1 987 470 005 <sup>7</sup>					
		07.06-10.09	44				0 986 475 949	↔	19,05						
							12.09→	48			0 986 475 949	↔	19,05		
	<b>1.2</b> i LPG, i Twinport, Twinport	07.06→	51/55-59/63				0 986 475 949	↔	19,05						
<b>1.3</b> CDTI		07.06-03.09	55				0 986 475 949	↔	19,05						
							07.06-07.10	66	0 986 475 949	↔	19,05				
							12.09-09.10	70	0 986 475 949	↔	19,05				
							01.11→	55	0 986 475 949	↔	19,05				
								70	0 986 475 949	↔	19,05				





	<b>S</b>							
1.7 CDTi	12.09→	96			Fg.-Nr. →B4999999, →B6999999	0 265 007 769 <sup>4</sup>		
<b>Corsa [E]</b>								
	1.0	10.14→	66/85		308,SBJ			1 987 470 005 <sup>7</sup>
						308,SBJ	0 986 473 062	57
						0 986 474 062	57	1 987 470 005 <sup>7</sup>
	1.2	10.14→	51		308,SBJ			1 987 470 005 <sup>7</sup>
						308,SBJ	0 986 473 062	57
						0 986 474 062	57	1 987 470 005 <sup>7</sup>
	1.3	10.14→	55/70		308,SBJ			1 987 470 005 <sup>7</sup>
						308,SBJ	0 986 473 062	57
						0 986 474 062	57	1 987 470 005 <sup>7</sup>
	1.4	10.14→	66/74		308,SBJ			1 987 470 005 <sup>7</sup>
						308,SBJ	0 986 473 062	57
						0 986 474 062	57	1 987 470 005 <sup>7</sup>
	1.6	05.15→	148-152		308,SBJ			1 987 470 005 <sup>7</sup>
						308,SBJ	0 986 473 062	57
						0 986 474 062	57	1 987 470 005 <sup>7</sup>
	1.0	10.14→	66/85					0 986 475 949
								19,05
	1.2	10.14→	51			0 986 475 949		19,05
	1.3	10.14→	55/70			0 986 475 949		19,05
	1.4	10.14→	66/74			0 986 475 949		19,05
	1.6	05.15→	148-152			0 986 475 949		19,05
	1.0	10.14→	66/85					0 265 008 089 <sup>3</sup>
								0 265 008 089 <sup>3</sup>
	1.2	10.14→	51			0 265 008 089 <sup>3</sup>		0 265 008 089 <sup>3</sup>
	1.3	10.14→	55/70			0 265 008 089 <sup>3</sup>		0 265 008 089 <sup>3</sup>
	1.4	10.14→	66/74			0 265 008 089 <sup>3</sup>		0 265 008 089 <sup>3</sup>
	1.6	05.15→	148-152			0 265 008 089 <sup>3</sup>		0 265 008 089 <sup>3</sup>
<b>Frontera [A]</b>								
	2.0i	01.92-08.98	85		Fg.-Nr. →SV720102			0 986 473 306
								60
						0 986 474 306		60
					Fg.-Nr. SV720103→	0 986 473 060		60,2
						0 986 474 060		60,2
	2.2i	02.95-08.98	100		Fg.-Nr. →SV720102			0 986 473 306
								60
						0 986 474 306		60
					Fg.-Nr. SV720103→	0 986 473 060		60,2
						0 986 474 060		60,2
	2.3TD	01.92-08.95	74		Fg.-Nr. →SV720102			0 986 473 306
								60
						0 986 474 306		60
					Fg.-Nr. SV720103→	0 986 473 060		60,2
						0 986 474 060		60,2
	2.4i	01.92-08.95	92		Fg.-Nr. →SV720102			0 986 473 306
								60
						0 986 474 306		60
					Fg.-Nr. SV720103→	0 986 473 060		60,2
						0 986 474 060		60,2
	2.5TDS Turbo	06.96-08.98	85		Fg.-Nr. →SV720102			0 986 473 306
								60
						0 986 474 306		60
					Fg.-Nr. SV720103→	0 986 473 060		60,2
						0 986 474 060		60,2
	2.8TDI Turbo	02.95-08.98	83		Fg.-Nr. →SV720102			0 986 473 306
								60
						0 986 474 306		60
					Fg.-Nr. SV720103→	0 986 473 060		60,2
						0 986 474 060		60,2



		S				?			
<b>◀ VAUXHALL Frontera [A]</b>									
	2.0 i	01.92-08.98	85				0986 475 807	↔ 25,4	
	2.2 i	02.95-08.98	100				0986 475 807	↔ 25,4	
	2.3 TD	01.92-08.95	74				0986 475 807	↔ 25,4	
	2.4 i	01.92-08.95	92				0986 475 807	↔ 25,4	
	2.5 TDS Turbo	06.96-08.98	85				0986 475 807	↔ 25,4	
	2.8 TDI Turbo	02.95-08.98	83				0986 475 807	↔ 25,4	
	2.0 i	02.95-08.98	85				0986 473 059	↔ 41,2	1987 470 518 <sup>7</sup>
							0986 474 059	↔ 41,2	1987 470 518 <sup>7</sup>
	2.2 i	02.95-08.98	100				0986 473 059	↔ 41,2	1987 470 518 <sup>7</sup>
							0986 474 059	↔ 41,2	1987 470 518 <sup>7</sup>
	2.5 TDS Turbo	06.96-08.98	85				0986 473 059	↔ 41,2	1987 470 518 <sup>7</sup>
							0986 474 059	↔ 41,2	1987 470 518 <sup>7</sup>
	2.0 i	02.95-08.98	85	Fg.-Nr. WV605055→			1987 482 110	→ 1936	
							1987 482 111	← 1936	
				Fg.-Nr. WV615055→			1987 482 170	→ 1500	
							1987 482 171	← 1500	
	2.2 i	02.95-08.98	100	Fg.-Nr. WV605055→			1987 482 110	→ 1936	
							1987 482 111	← 1936	
			Fg.-Nr. WV615055→			1987 482 170	→ 1500		
						1987 482 171	← 1500		
	2.5 TDS Turbo	06.96-08.98	85	Fg.-Nr. WV605055→			1987 482 110	→ 1936	
							1987 482 111	← 1936	
				Fg.-Nr. WV615055→			1987 482 170	→ 1500	
							1987 482 171	← 1500	
	2.8 TDI Turbo	02.95-08.98	83	Fg.-Nr. WV605055→			1987 482 110	→ 1936	
							1987 482 111	← 1936	
			Fg.-Nr. WV615055→			1987 482 170	→ 1500		
						1987 482 171	← 1500		
<b>Frontera [B]</b>									
	2.2 DTI	09.98-09.04	85/88/100				0986 473 060	↔ 60,2	
	2.2 i						0986 474 060	↔ 60,2	
	3.2 i	09.98-09.04	151				0986 473 060	↔ 60,2	
							0986 474 060	↔ 60,2	
	2.2 DTI	09.98-09.04	85/88/100				0986 473 059	↔ 41,2	1987 470 518 <sup>7</sup>
	2.2 i						0986 474 059	↔ 41,2	1987 470 518 <sup>7</sup>
	3.2 i	09.98-09.04	151				0986 473 059	↔ 41,2	1987 470 518 <sup>7</sup>
							0986 474 059	↔ 41,2	1987 470 518 <sup>7</sup>
<b>Insignia Sports Tourer [35]</b>									
	1.4	09.11→	103		D32		0986 134 319	↔ 60	
							0986 135 319	↔ 60	
	1.6	02.09→	85/125/		D32		0986 134 319	↔ 60	
			132				0986 135 319	↔ 60	
	1.8	02.09→	103		D32		0986 134 319	↔ 60	
							0986 135 319	↔ 60	
	2.0 CDTI, CDTI 4x4, Turbo, 4x4	02.09→	81/88/96/103/118/125/		D32		0986 134 319	↔ 60	
			140-143/162/184				0986 135 319	↔ 60	

	S							
<hr/>								
	2.8 Turbo 4x4	02.09→	191		D32	0 986 134 319		← 60
						0 986 135 319		→ 60
<hr/>								
	1.4	09.11→	103		31D,FEB, TW	0 986 134 337		← 41
						0 986 135 337		→ 41
	1.6	02.09→	85/125		31D,FEB, TW	0 986 134 337		← 41
						0 986 135 337		→ 41
			132		31D,FEB	0 986 134 337		← 41
						0 986 135 337		→ 41
	1.8	02.09→	103		31D,FEB	0 986 134 337		← 41
						0 986 135 337		→ 41
	2.0 CDTI, CDTI 4x4, Turbo, 4x4	02.09→	81/88/96/103/118/ 140-143/162/184		31D,FEB, TW	0 986 134 337		← 41
						0 986 135 337		→ 41
	2.8 Turbo 4x4	02.09→	191/239		FEB,TW	0 986 134 337		← 41
						0 986 135 337		→ 41
<hr/>								
	2.0 CDTI 4x4	07.09→	140-143/ 162	Fg.-Nr. →A1006683	FEB	1 987 482 333		↔ 2005
	2.0 4x4	02.09→	140-143/ 162	Fg.-Nr. →A1006683	FEB	1 987 482 333		↔ 2005
	2.8 Turbo 4x4	02.09→	191/239	Fg.-Nr. →A1006683	FEB	1 987 482 333		↔ 2005
<hr/>								
<b>Insignia [68]</b>								
<hr/>								
	1.4 Turbo	09.11→	103		D32	0 986 134 319		← 60
						0 986 135 319		→ 60
	1.6	11.08→	85/125/ 132		D32	0 986 134 319		← 60
						0 986 135 319		→ 60
	1.8	11.08→	103		D32	0 986 134 319		← 60
						0 986 135 319		→ 60
	2.0 CDTI, CDTI 4x4, Turbo, Turbo 4x4	11.08→	81/96/103/118/125/ 140-143/162/184		D32	0 986 134 319		← 60
						0 986 135 319		→ 60
	2.8 Turbo 4x4	11.08→	191		D32	0 986 134 319		← 60
						0 986 135 319		→ 60
<hr/>								
	1.4 Turbo	09.11→	103		31D,FEB, TW	0 986 134 337		← 41
						0 986 135 337		→ 41
	1.6	11.08→	85/125		31D,FEB, TW	0 986 134 337		← 41
						0 986 135 337		→ 41
			132		31D,FEB	0 986 134 337		← 41
						0 986 135 337		→ 41
	1.8	11.08→	103		31D,FEB	0 986 134 337		← 41
						0 986 135 337		→ 41
	2.0 CDTI, CDTI 4x4, Turbo, Turbo 4x4	11.08→	81/96/103/118/ 140-143/162/184		31D,FEB, TW	0 986 134 337		← 41
						0 986 135 337		→ 41
	2.8 Turbo 4x4	11.08→	191/239		FEB,TW	0 986 134 337		← 41
						0 986 135 337		→ 41
<hr/>								
	2.0 CDTI 4x4	07.09→	140-143/ 162	Fg.-Nr. →A1006683	FEB	1 987 482 333		↔ 2005
	2.0 Turbo 4x4	11.08→	140-143/ 162	Fg.-Nr. →A1006683	FEB	1 987 482 333		↔ 2005
	2.8 Turbo 4x4	11.08→	191/239	Fg.-Nr. →A1006683	FEB	1 987 482 333		↔ 2005





◀ VAUXHALL

Insignia [69]















































	1.4 Turbo	09.11→	103		D32	0986 134 319	← 60
						0986 135 319	→ 60
	1.6	11.08→	85/125/ 132		D32	0986 134 319	← 60
						0986 135 319	→ 60
	1.8	11.08→	103		D32	0986 134 319	← 60
						0986 135 319	→ 60
	2.0 CDTI, CDTI 4x4, Turbo, Turbo 4x4	11.08→	81/88/96/118/ 140-143/162/184		D32	0986 134 319	← 60
						0986 135 319	→ 60
	2.8 Turbo 4x4	11.08→	191		D32	0986 134 319	← 60
						0986 135 319	→ 60

	1.4 Turbo	09.11→	103		31D,FEB, TW	0986 134 337	← 41
						0986 135 337	→ 41
	1.6	11.08→	85/125		31D,FEB, TW	0986 134 337	← 41
			132		31D,FEB	0986 134 337	← 41
						0986 135 337	→ 41
	1.8	11.08→	103		31D,FEB	0986 134 337	← 41
						0986 135 337	→ 41
	2.0 CDTI, CDTI 4x4, Turbo, Turbo 4x4	11.08→	81/88/96/118/ 140-143/162/184		31D,FEB, TW	0986 134 337	← 41
						0986 135 337	→ 41
	2.8 Turbo 4x4	11.08→	191/239		FEB,TW	0986 134 337	← 41
						0986 135 337	→ 41

	2.0 CDTI 4x4	07.09→	140-143/ 162	Fg.-Nr. →A1006683	FEB	1987 482 333	↔ 2005
	2.0 Turbo 4x4	11.08→	140-143/ 162	Fg.-Nr. →A1006683	FEB	1987 482 333	↔ 2005
	2.8 Turbo 4x4	11.08→	191/239	Fg.-Nr. →A1006683	FEB	1987 482 333	↔ 2005

Meriva [A]

	1.3 CDTI	09.03-03.10	51/55			0986 473 062	← 57	
						0986 474 062	→ 57	
	1.4 16V Twinport	07.04-03.10	66		4L0	0986 473 991	← 54	
						0986 474 991	→ 54	
					5L0	0986 473 062	← 57	
						0986 474 062	→ 57	
	1.6 i	03.03-09.05	64			0986 473 991	← 54	
						0986 474 991	→ 54	
	1.6 i OPC Turbo	09.05-03.10	132				1987 470 005 <sup>7</sup>	
	1.6 i 16V	03.03-02.06	74			0986 473 062	← 57	
							0986 474 062	→ 57
						01.06-03.10	77	0986 473 062
						0986 474 062	→ 57	
	1.7 CDTI	09.03-09.09	74			0986 473 062	← 57	
						0986 474 062	→ 57	
	1.7 DTI	03.03-09.05	55			0986 473 062	← 57	
						0986 474 062	→ 57	
	1.8 i 16V	03.03-03.10	92			0986 473 062	← 57	
							0986 474 062	→ 57

		<b>S</b>														
																
	<b>1.3 CDTI</b>	09.03-03.10	55	Fg.-Nr. →34999999						0 986 <b>473 223</b>		← 38,1				
										0 986 <b>474 223</b>		→ 38,1				
					Fg.-Nr. 44000001→						0 986 <b>473 258</b>		← 38			
											0 986 <b>474 258</b>		→ 38			
			09.05-03.10	51						0 986 <b>473 258</b>		← 38				
					Fg.-Nr. →34999999						0 986 <b>474 258</b>		→ 38			
	<b>1.4 16V Twinport</b>		07.04-03.10	66						0 986 <b>473 474</b>		← 36				
										0 986 <b>474 474</b>		→ 36				
	<b>1.6 i</b>	03.03-09.05	64	Fg.-Nr. →34999999						0 986 <b>473 261</b>		← 36				
									Fg.-Nr. 44000001→						0 986 <b>474 261</b>	
										0 986 <b>473 474</b>		← 36				
										0 986 <b>474 474</b>		→ 36				
<b>1.6 i 16V</b>	03.03-02.06	74	Fg.-Nr. →34999999						0 986 <b>473 223</b>		← 38,1					
								Fg.-Nr. 44000001→						0 986 <b>474 223</b>		→ 38,1
													0 986 <b>473 258</b>		← 38	
									0 986 <b>474 258</b>		→ 38					
<b>1.7 CDTI</b> <b>1.7 DTI</b>	03.03-03.10	55/74/92	Fg.-Nr. →34999999						0 986 <b>473 223</b>		← 38,1					
								Fg.-Nr. 44000001→						0 986 <b>474 223</b>		→ 38,1
									0 986 <b>473 258</b>		← 38					
									0 986 <b>474 258</b>		→ 38					
<b>1.8 i 16V</b>	03.03-03.10	92	Fg.-Nr. →34999999						0 986 <b>473 223</b>		← 38,1					
								Fg.-Nr. 44000001→						0 986 <b>474 223</b>		→ 38,1
													0 986 <b>473 258</b>		← 38	
									0 986 <b>474 258</b>		→ 38					
																
	<b>1.3 CDTI</b>	09.03-03.10	51/55	Fg.-Nr. →34999999						1 987 <b>477 936</b>		1610				
				Fg.-Nr. 44000001→						1 987 <b>477 935</b>		1615				
	<b>1.4 16V Twinport</b>		07.04-03.10	66	Fg.-Nr. →34999999						1 987 <b>477 936</b>		1610			
					Fg.-Nr. 44000001→						1 987 <b>477 935</b>		1615			
	<b>1.6 i, i OPC Turbo, i 16V</b>	03.03-03.10	64/74/77/ 132	Fg.-Nr. →34999999						1 987 <b>477 936</b>		1610				
									Fg.-Nr. 44000001→						1 987 <b>477 935</b>	
	<b>1.7 CDTI</b>		03.03-03.10	55/74/92	Fg.-Nr. →34999999						1 987 <b>477 936</b>		1610			
					Fg.-Nr. 44000001→						1 987 <b>477 935</b>		1615			
	<b>1.8 i 16V</b>		03.03-03.10	92	Fg.-Nr. →34999999						1 987 <b>477 936</b>		1610			
					Fg.-Nr. 44000001→						1 987 <b>477 935</b>		1615			
																
<b>1.3 CDTI</b>		09.03-03.10	51/55						0 986 <b>594 027</b> <sup>3</sup>							
<b>1.4 16V Twinport</b>		07.04-03.10	66						0 986 <b>594 027</b> <sup>3</sup>							
<b>1.6 i, i OPC Turbo, i 16V</b>		03.03-03.10	64/74/77/132						0 986 <b>594 027</b> <sup>3</sup>							
<b>1.7 CDTI, DTI</b>		03.03-09.09	55/74						0 986 <b>594 027</b> <sup>3</sup>							
<b>1.8 i 16V</b>		03.03-03.10	92						0 986 <b>594 027</b> <sup>3</sup>							
<b>Meriva [B]</b>																
																
	<b>1.3 CDTI</b>	06.10→	55/70						0 986 <b>473 062</b>		← 57	1 987 <b>470 005</b> <sup>7</sup>				
													0 986 <b>474 062</b>		→ 57	1 987 <b>470 005</b> <sup>7</sup>
	<b>1.4 ecoFLEX, Ecotec, Turbo</b>		04.10→	74/88/103						0 986 <b>473 062</b>		← 57	1 987 <b>470 005</b> <sup>7</sup>			
										0 986 <b>474 062</b>		→ 57	1 987 <b>470 005</b> <sup>7</sup>			
	<b>1.6 CDTI</b>		10.13→	70/81/100						0 986 <b>473 062</b>		← 57	1 987 <b>470 005</b> <sup>7</sup>			
										0 986 <b>474 062</b>		→ 57	1 987 <b>470 005</b> <sup>7</sup>			
	<b>1.7 CDTI</b>		04.10→	74/81/96						0 986 <b>473 062</b>		← 57	1 987 <b>470 005</b> <sup>7</sup>			
										0 986 <b>474 062</b>		→ 57	1 987 <b>470 005</b> <sup>7</sup>			





		S							
◀ VAUXHALL Meriva [B]									
	1.3 CDTI	06.10→	55/70	Fg.-Nr. →C4094247			0 265 008 331 <sup>3</sup>		
				Fg.-Nr. C4094248→			0 265 008 331 <sup>3</sup>		
	1.4 ecoFLEX, Ecotec, Turbo	04.10→	88/103	Fg.-Nr. →C4094247			0 265 008 331 <sup>3</sup>		
				Fg.-Nr. C4094248→			0 265 008 331 <sup>3</sup>		
	1.4 Ecotec	04.10→	74				0 265 008 331 <sup>3</sup>		
	1.6 CDTI	10.13→	70/81/100				0 265 008 331 <sup>3</sup>		
	1.7 CDTI	04.10→	74/81/96	Fg.-Nr. →C4094247			0 265 008 331 <sup>3</sup>		
				Fg.-Nr. C4094248→			0 265 008 331 <sup>3</sup>		
Monterey [A]									
	3.1 TD	09.91-08.98	84				0 986 473 060		← 60,2
							0 986 474 060		→ 60,2
	3.2 i	06.92-08.98	130				0 986 473 060		← 60,2
							0 986 474 060		→ 60,2
	3.1 TD	09.91-08.98	84				0 986 473 059		← 41,2
							0 986 474 059		→ 41,2
	3.2 i	06.92-08.98	130				0 986 473 059		← 41,2
							0 986 474 059		→ 41,2
Monterey [B]									
	3.0 DTI	02.98-12.99	117				0 986 473 060		← 60,2
							0 986 474 060		→ 60,2
	3.5 iV6	02.98-12.99	158				0 986 473 060		← 60,2
							0 986 474 060		→ 60,2
	3.0 DTI	02.98-12.99	117				0 986 473 059		← 41,2
							0 986 474 059		→ 41,2
	3.5 iV6	02.98-12.99	158				0 986 473 059		← 41,2
							0 986 474 059		→ 41,2
Movano [A]									
	1.9 D	01.99-10.05	59/60		15Z		0 204 102 730		← 45
	1.9 DTI						0 204 103 730		
							0 204 102 731		→ 45
							0 204 103 731		
					16Z		0 986 473 328		← 45
							0 986 474 328		→ 45
	2.2 DTI	01.01-10.05	66		15Z		0 204 102 730		← 45
							0 204 103 730		
							0 204 102 731		→ 45
							0 204 103 731		
					16Z		0 986 473 328		← 45
							0 986 474 328		→ 45
	2.5 D	10.98-03.10	59/74-88/		15Z		0 204 102 730		← 45
	2.5 DTI		107				0 204 103 730		
							0 204 102 731		→ 45
							0 204 103 731		
					16Z		0 986 473 328		← 45
							0 986 474 328		→ 45



















	S							
2.8 DTI	06.98-10.05	84			15Z	0 204 102 730 0 204 103 730 0 204 102 731 0 204 103 731	← 45 → 45 → 45 → 45	
					16Z	0 986 473 328 0 986 474 328	← 45 → 45	
3.0 DTI	10.03-10.05	100			15Z	0 204 102 730 0 204 103 730 0 204 102 731 0 204 103 731	← 45 → 45 → 45 → 45	
					16Z	0 986 473 328 0 986 474 328	← 45 → 45	
	1.9 D	01.99-10.05	59/60			F 026 002 532	← 23,8	
	1.9 DTI					F 026 002 533	→ 23,8	
	2.2 DTI	01.01-10.05	66			F 026 002 532 F 026 002 533	← 23,8 → 23,8	
	2.5 D	10.98-03.10	59/74-84			F 026 002 532	← 23,8	
	2.5 DTI					F 026 002 533	→ 23,8	
	2.8 DTI	06.98-10.05	84			F 026 002 532 F 026 002 533	← 23,8 → 23,8	
	3.0 DTI	10.03-10.05	100			F 026 002 532 F 026 002 533	← 23,8 → 23,8	
	1.9 D	01.99-10.01	59			0 204 004 320 0 986 473 260 0 204 004 321 0 986 474 260	← 42 → 42 → 42 → 42	
	1.9 DTI	10.01-10.05	60			0 204 004 320 0 986 473 260 0 204 004 321 0 986 474 260	← 42 → 42 → 42 → 42	
	2.2 DTI	01.01-10.05	66			0 204 004 320 0 986 473 260 0 204 004 321 0 986 474 260	← 42 → 42 → 42 → 42	
	2.5 D	10.98-03.10	59/74-88/			0 204 004 320	← 42	
	2.5 DTI		107			0 986 473 260 0 204 004 321 0 986 474 260	→ 42 → 42 → 42	
	2.8 DTI	06.98-10.05	84			0 204 004 320 0 986 473 260 0 204 004 321 0 986 474 260	← 42 → 42 → 42 → 42	
	3.0 DTI	10.03-10.05	100			0 204 004 320 0 986 473 260 0 204 004 321 0 986 474 260	← 42 → 42 → 42 → 42	
	1.9 D	01.99-10.01	59/60			1 987 482 012	↔ 1175	
					ABM	1 987 482 013	↔ 1420	
	1.9 D, DTI	01.99-10.05	59/60		ABM	1 987 477 261	1737	
	1.9 DTI	10.01-10.05	59/60			1 987 482 012 1 987 482 013	↔ 1175 ↔ 1420	
	2.2 DTI	01.01-10.05	66			1 987 482 012 1 987 477 261 1 987 482 013	↔ 1175 1737 ↔ 1420	
	2.5 D	10.98-10.05	59/74-88/			1 987 482 012	↔ 1175	
			107		ABM	1 987 482 013	↔ 1420	
	2.5 D, DTI	10.98-03.10	59/74-88/107		ABM	1 987 477 261	1737	



			S							
<b>VAUXHALL Movano [A]</b>										
2.5 DTI	10.01-03.10	59/74-88/107						1987 482 012	↔	1175
						ABM		1987 482 013	↔	1420
2.8 DTI	06.98-10.05	84						1987 482 012	↔	1175
						ABM		1987 477 261		1737
								1987 482 013	↔	1420
3.0 DTI	10.03-10.05	100						1987 482 012	↔	1175
						ABM		1987 477 261		1737
								1987 482 013	↔	1420
<b>Nova</b>										
	1.0	05.83-08.94	33	Fg.-Nr. →M4999999		DMO		0986 471 462	←	48
								0986 473 462		1987 470 496 <sup>7</sup>
								0986 472 462	→	48
								0986 474 462		1987 470 496 <sup>7</sup>
				Fg.-Nr. N4000001→		ATE		0986 473 895		← 48
								0986 473 896		→ 48
	1.2	05.83-08.94	33-39	Fg.-Nr. →M4999999		DMO		0986 471 462	←	48
								0986 473 462		1987 470 498 <sup>8</sup>
								0986 472 462	→	48
								0986 474 462		1987 470 496 <sup>7</sup>
	1.2	05.83-08.94	33	Fg.-Nr. →M4999999		DMO		0986 471 462	←	48
	1.2 i							0986 473 462		1987 470 498 <sup>8</sup>
								0986 472 462	→	48
								0986 474 462		1987 470 496 <sup>7</sup>
	1.2 i	09.90-08.94	33	Fg.-Nr. N4000001→		ATE		0986 473 895		← 48
								0986 473 896		→ 48
	1.2 i	05.83-08.94	40-43	Fg.-Nr. →M4999999		DMO		0986 471 462	←	48
	1.2 S							0986 473 462		1987 470 498 <sup>8</sup>
								0986 472 462	→	48
								0986 474 462		1987 470 496 <sup>7</sup>
				Fg.-Nr. N4000001→		ATE		0986 473 895		← 48
								0986 473 896		→ 48
	1.3	05.83-08.94	51	Fg.-Nr. →M4999999		DMO		0986 471 462	←	48
								0986 473 462		1987 470 498 <sup>8</sup>
								0986 472 462	→	48
								0986 474 462		1987 470 496 <sup>7</sup>
	1.4	01.90-08.94	44/55	Fg.-Nr. →M4999999		DMO		0986 471 462	←	48
	1.4 i							0986 473 462		1987 470 498 <sup>8</sup>
								0986 472 462	→	48
								0986 474 462		1987 470 496 <sup>7</sup>
				Fg.-Nr. N4000001→		ATE		0986 473 895		← 48
								0986 473 896		→ 48
	1.4 i	09.91-08.94	60	Fg.-Nr. N4000001→		ATE		0986 471 899	←	48
								0986 473 899		
								0986 473 901		
								0986 471 900	→	48
								0986 473 900		
								0986 473 902		
	1.5 D	09.87-08.94	37/49	Fg.-Nr. →M4999999		DMO		0986 471 463	←	48
	1.5 TD							0986 473 463		1987 470 498 <sup>8</sup>
								0986 472 463	→	48
								0986 474 463		1987 470 496 <sup>7</sup>
				Fg.-Nr. N4000001→		ATE		0986 473 895		← 48
								0986 473 896		→ 48
	1.6 i	05.88-08.94	55/74	Fg.-Nr. →M4999999		DMO		0986 471 464	←	52
								0986 473 464		1987 470 498 <sup>8</sup>
								0986 472 464	→	52
								0986 474 464		1987 470 498 <sup>8</sup>



		S							
1.6i		05.88-08.94	55/74		Fg.-Nr. N4000001→	ATE	0 986 471 899 0 986 473 899 0 986 473 901	← 48  	
							0 986 471 900 0 986 473 900 0 986 473 902	→ 48  	
									
	1.0	05.83-08.94	33		Fg.-Nr. →F4999999 Fg.-Nr. G4000001→M4999999 Fg.-Nr. N4000001→		0 986 475 453 0 986 475 022 0 986 475 032	↔ 14,29 ↔ 14,29 ↔ 17,46	
	1.2, i, S	05.83-08.94	33-39/ 40-43		Fg.-Nr. →F4999999 Fg.-Nr. G4000001→		F 026 002 123 0 986 475 032	↔ 17,5 ↔ 17,46	
	1.3	05.83-08.94	51		Fg.-Nr. →F4999999 Fg.-Nr. G4000001→		F 026 002 123 0 986 475 032	↔ 17,5 ↔ 17,46	
	1.4	01.90-08.94	44/55		Fg.-Nr. →F4999999 Fg.-Nr. G4000001→		F 026 002 123 0 986 475 032	↔ 17,5 ↔ 17,46	
	1.4i				Fg.-Nr. G4000001→		0 986 475 032	↔ 17,46	
	1.4i	09.91-08.94	60		Fg.-Nr. G4000001→		0 986 475 032	↔ 17,46	
	1.5D	09.87-08.94	37/49		Fg.-Nr. →F4999999 Fg.-Nr. G4000001→		F 026 002 123 0 986 475 032	↔ 17,5 ↔ 17,46	
	1.5TD				Fg.-Nr. G4000001→		0 986 475 032	↔ 17,46	
	1.6i	05.88-08.94	55/74		Fg.-Nr. →F4999999 Fg.-Nr. G4000001→		F 026 002 123 0 986 475 032	↔ 17,5 ↔ 17,46	
									
	1.0	05.83-08.94	33		Fg.-Nr. →F4999999 Fg.-Nr. G4000001→N4052760 Fg.-Nr. N4052761→		1 987 477 131 1 987 477 132 1 987 477 133 1 987 477 134 1 987 477 307 1 987 477 308	← 822 → 1435 ← 960 → 1400 → 1035 ← 1260	
	1.2	05.83-08.94	33-39/ 40-43		Fg.-Nr. →F4999999 Fg.-Nr. G4000001→N4052760 Fg.-Nr. N4052761→		1 987 477 131 1 987 477 132 1 987 477 133 1 987 477 134 1 987 477 307 1 987 477 308	← 822 → 1435 ← 960 → 1400 → 1035 ← 1260	
	1.2i				Fg.-Nr. G4000001→N4052760 Fg.-Nr. N4052761→		1 987 477 133 1 987 477 134 1 987 477 307 1 987 477 308	← 960 → 1400 → 1035 ← 1260	
	1.2S				Fg.-Nr. G4000001→N4052760 Fg.-Nr. N4052761→		1 987 477 133 1 987 477 134 1 987 477 307 1 987 477 308	← 960 → 1400 → 1035 ← 1260	
	1.3	05.83-08.94	51		Fg.-Nr. →F4999999 Fg.-Nr. G4000001→N4052760 Fg.-Nr. N4052761→		1 987 477 131 1 987 477 132 1 987 477 133 1 987 477 134 1 987 477 307 1 987 477 308	← 822 → 1435 ← 960 → 1400 → 1035 ← 1260	
	1.4	01.90-08.94	44/55		Fg.-Nr. →F4999999 Fg.-Nr. G4000001→N4052760 Fg.-Nr. N4052761→		1 987 477 131 1 987 477 132 1 987 477 133 1 987 477 134 1 987 477 307 1 987 477 308	← 822 → 1435 ← 960 → 1400 → 1035 ← 1260	
	1.4i				Fg.-Nr. G4000001→N4052760 Fg.-Nr. N4052761→		1 987 477 133 1 987 477 134 1 987 477 307 1 987 477 308	← 960 → 1400 → 1035 ← 1260	
	1.4i	09.91-08.94	60		Fg.-Nr. G4000001→N4052760 Fg.-Nr. N4052761→		1 987 477 133 1 987 477 134 1 987 477 307 1 987 477 308	← 960 → 1400 → 1035 ← 1260	
	1.5D	09.87-08.94	37/49		Fg.-Nr. →F4999999 Fg.-Nr. G4000001→N4052760 Fg.-Nr. N4052761→		1 987 477 131 1 987 477 132 1 987 477 133 1 987 477 134 1 987 477 307 1 987 477 308	← 822 → 1435 ← 960 → 1400 → 1035 ← 1260	
	1.5TD				Fg.-Nr. G4000001→N4052760 Fg.-Nr. N4052761→		1 987 477 133 1 987 477 134 1 987 477 307 1 987 477 308	← 960 → 1400 → 1035 ← 1260	
	1.6i	05.88-08.94	55/74		Fg.-Nr. →F4999999 Fg.-Nr. G4000001→N4052760		1 987 477 131 1 987 477 132 1 987 477 133 1 987 477 134	← 822 → 1435 ← 960 → 1400	



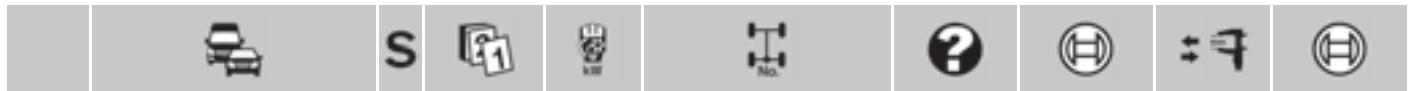

	◀ VAUXHALL Nova							
1.6 i	05.88-08.94	55/74	Fg.-Nr. N4052761→		1987 477 307	→ 1035		
					1987 477 308	← 1260		

**Omega [B]**

	2.0 DTI	09.97-08.00	74		0986 473 820	← 57		
					0986 473 821	→ 57		
	2.0 i	09.93-12.00	85/100		0986 473 820	← 57		
					0986 473 821	→ 57		
				Fg.-Nr. →V1999999	0986 473 297	← 54		
					0986 474 297	→ 54		
	2.2 DTI	09.99-09.04	88/103-106		0986 473 820	← 57		
	2.2 i				0986 473 821	→ 57		
	2.5 i, TD, TDI	04.94-09.04	96/110/ 125		0986 473 820	← 57		
					0986 473 821	→ 57		
	2.6 i	09.00-09.04	132		0986 473 820	← 57		
					0986 473 821	→ 57		
	3.0 i	04.94-02.01	155		0986 473 820	← 57		
					0986 473 821	→ 57		
	3.2 i	09.00-09.04	160		0986 473 820	← 57		
					0986 473 821	→ 57		

	2.0 DTI	09.93-12.00	74/85/100	Fg.-Nr. →W1069516	0986 473 119	← 39,93		
	2.0 i				0986 474 119	→ 39,93		
				Fg.-Nr. W1069517→Y1999999	0986 473 119	← 39,93		
					0986 474 119	→ 39,93		
				Fg.-Nr. 11000001→11999999	0986 134 041	← 42		
					0986 135 041	→ 42		
	2.2 DTI	09.99-09.04	88/103-106	Fg.-Nr. →W1069516	0986 473 119	← 39,93		
	2.2 i				0986 474 119	→ 39,93		
				Fg.-Nr. W1069517→Y1999999	0986 473 119	← 39,93		
					0986 474 119	→ 39,93		
				Fg.-Nr. 11000001→	0986 134 041	← 42		
					0986 135 041	→ 42		
	2.5 i	04.94-09.04	125	Fg.-Nr. →W1069516	0986 473 119	← 39,93		
					0986 474 119	→ 39,93		
				Fg.-Nr. W1069517→Y1999999	0986 473 119	← 39,93		
					0986 474 119	→ 39,93		
				Fg.-Nr. 11000001→	0986 134 041	← 42		
					0986 135 041	→ 42		
	2.5 TD	04.94-02.01	96	Fg.-Nr. 11000001→11999999	0986 134 041	← 42		
					0986 135 041	→ 42		
	2.5 TD	04.94-09.04	96	Fg.-Nr. →W1069516	0986 473 119	← 39,93		
	2.5 TDI				0986 474 119	→ 39,93		
				Fg.-Nr. W1069517→Y1999999	0986 473 119	← 39,93		
					0986 474 119	→ 39,93		
	2.5 TDI	04.96-09.04	96	Fg.-Nr. 11000001→	0986 134 041	← 42		
					0986 135 041	→ 42		
		09.01-09.04	110	Fg.-Nr. 21000001→	0986 134 041	← 42		
					0986 135 041	→ 42		
	2.6 i	09.00-09.04	132	Fg.-Nr. 21000001→	0986 134 041	← 42		
					0986 135 041	→ 42		
	3.0 i	04.94-02.01	155	Fg.-Nr. →W1069516	0986 473 119	← 39,93		
					0986 474 119	→ 39,93		
				Fg.-Nr. W1069517→Y1999999	0986 473 119	← 39,93		
					0986 474 119	→ 39,93		
				Fg.-Nr. 11000001→11999999	0986 134 041	← 42		
					0986 135 041	→ 42		
	3.2 i	09.00-09.04	160	Fg.-Nr. 21000001→	0986 134 041	← 42		
					0986 135 041	→ 42		

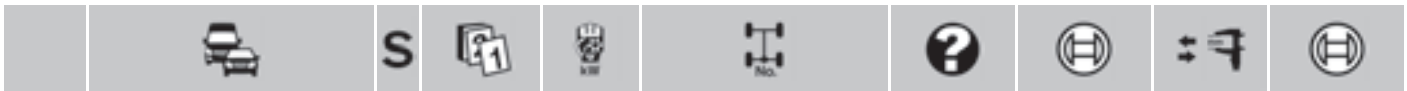

	2.0 DTI, i	09.93-12.00	74/85/100				1 987 477 250	1550
	2.2 DTI, i	09.99-09.04	88/103-106				1 987 477 250	1550
	2.5 i, TD, TDI	04.94-09.04	96/110/125				1 987 477 250	1550
	2.6 i	09.00-09.04	132				1 987 477 250	1550
	3.0 i	04.94-02.01	155				1 987 477 250	1550
	3.2 i	09.00-09.04	160				1 987 477 250	1550

**Signum**

	1.8 i	05.03-02.05	90	Fg.-Nr. →51064146			0 986 473 294	← 57
				Fg.-Nr. 51064147→			0 986 474 294	→ 57
							0 986 134 018	← 57
							0 986 135 018	→ 57
		03.06-09.08	103		BHO		0 986 134 081	← 57
							0 986 135 081	→ 57
					BHO		0 986 134 018	← 57
							0 986 135 018	→ 57
	1.9 CDTI	04.04-09.08	88/110	Fg.-Nr. →51064146			0 986 473 294	← 57
				Fg.-Nr. 51064147→			0 986 474 294	→ 57
							0 986 134 018	← 57
							0 986 135 018	→ 57
		09.05-09.08	74				0 986 473 294	← 57
							0 986 474 294	→ 57
							0 986 134 018	← 57
							0 986 135 018	→ 57
	2.0 DTI	05.03-09.05	74	Fg.-Nr. →51064146			0 986 473 294	← 57
				Fg.-Nr. 51064147→			0 986 474 294	→ 57
							0 986 134 018	← 57
							0 986 135 018	→ 57
	2.0 Turbo	05.03-09.08	129				0 986 473 308	← 60
							0 986 474 308	→ 60
	2.2 Direct	05.03-09.08	86-92/114	Fg.-Nr. →51064146			0 986 473 294	← 57
	2.2 DTI			Fg.-Nr. 51064147→			0 986 474 294	→ 57
							0 986 134 018	← 57
							0 986 135 018	→ 57
	2.8 V6 Turbo	08.05-09.07	169		31D		0 986 135 056	← 60
							0 986 134 056	→ 60
	3.0 CDTI	05.03-09.08	130-135	Fg.-Nr. →31068239→			0 986 135 056	← 60
							0 986 134 056	→ 60
		09.05-09.08	130-135	Fg.-Nr. →31068238			0 986 473 308	← 60
							0 986 474 308	→ 60
	3.2 i	05.03-09.05	155	Fg.-Nr. 31068239→			0 986 135 056	← 60
							0 986 134 056	→ 60

	1.8 i	05.03-02.05	90		SPN		0 986 473 172	← 37,93
							0 986 474 172	→ 37,93
		03.06-09.08	103		BHO		0 986 134 070	← 40
							0 986 135 070	→ 40
	1.9 CDTI	04.04-09.08	88/110		SPN		0 986 473 172	← 37,93
							0 986 474 172	→ 37,93
	2.0 DTI	05.03-09.05	74		SPN		0 986 473 172	← 37,93
							0 986 474 172	→ 37,93
	2.2 Direct	05.03-09.08	86-92/114		SPN		0 986 473 172	← 37,93
	2.2 DTI						0 986 474 172	→ 37,93



		S							
◀ VAUXHALL Signum									
	1.8 i	05.03-02.05	90			1987 477 907	↔	1805	
		03.06-09.08	103			1987 477 907	↔	1805	
	1.9 CDTI	04.04-09.08	74/88/110			1987 477 907	↔	1805	
	2.0 DTI	05.03-09.05	74/129			1987 477 907	↔	1805	
	2.0 Turbo	05.03-09.08	74/129			1987 477 907	↔	1805	
	2.2 Direct	05.03-09.08	86-92/114			1987 477 907	↔	1805	
	2.2 DTI	05.03-09.08	86-92/114			1987 477 907	↔	1805	
	2.8 V6 Turbo	08.05-09.07	169			1987 477 907		1805	
		09.05-09.08	184			1987 477 907	↔	1805	
	3.0 CDTI	05.03-09.08	130-135			1987 477 907	↔	1805	
3.2 i	05.03-09.05	155			1987 477 907	↔	1805		
<b>Sintra</b>									
	2.2 i 16V	09.96-09.99	85/104			1987 477 762	↔	2583	
	2.2 i 16V, TD	09.96-09.99	85/104			1987 477 761	←	799	
	2.2 TD	09.97-09.99	85/104			1987 477 762	↔	2583	
	3.0 i V6 24V	09.96-09.99	148			1987 477 761	←	799	
						1987 477 762	↔	2583	
<b>Tigra [A]</b>									
	1.4 i	09.94-08.99	66			0986 471 901	←	48	
						0986 473 901			
						0986 471 902	→	48	
						0986 473 902			
	1.6 i	09.94-08.99	78			0986 471 901	←	48	
						0986 473 901			
					0986 471 902	→	48		
					0986 473 902				
	1.4 i	09.94-08.99	66			0986 475 143	↔	19,05	
	1.6 i	09.94-08.99	78			0986 475 143	↔	19,05	
	1.4 i	09.94-08.99	66			1987 477 309	←	1373	
						1987 477 310	→	1078	
	1.6 i	09.94-08.99	78			1987 477 309	←	1373	
						1987 477 310	→	1078	
	1.4 i	09.94-08.99	66			0986 594 025 <sup>4</sup>			
						0986 594 028 <sup>3</sup>			
1.6 i	09.94-08.99	78			0986 594 025 <sup>4</sup>				
					0986 594 028 <sup>3</sup>				
<b>Tigra TwinTop [B]</b>									
	1.3 CDTI	06.04-03.09	51			0986 473 991	↔	54	
						0986 474 991	↔	54	
	1.4 i	06.04-12.09	66			0986 473 991	↔	54	
						0986 474 991	↔	54	
	1.8 i	06.04-12.09	92			0986 473 991	↔	54	
						0986 474 991	↔	54	

		S							
	1.3 CDTI	06.04-03.09	51				0 986 475 143	↔ 19,05	
	1.4 i	06.04-12.09	66				0 986 475 143	↔ 19,05	
	1.8 i	06.04-12.09	92				0 986 475 143	↔ 19,05	
	1.3 CDTI	06.04-03.09	51				0 986 473 256	↔ ←	
							0 986 474 256	↔ →	
	1.4 i	06.04-12.09	66				0 986 473 256	↔ ←	
							0 986 474 256	↔ →	
	1.8 i	06.04-12.09	92				0 986 473 256	↔ ←	
							0 986 474 256	↔ →	
	1.3 CDTI	ABO 06.04-03.09	51				1 987 482 139	→ 1143	
							1 987 482 140	← 1426	
		ABS 06.04-03.09	51				1 987 477 660	← 1095	
							1 987 477 661	→ 832	
	1.4 i	ABO 06.04-12.09	66				1 987 482 139	→ 1143	
							1 987 482 140	← 1426	
		ABS 06.04-12.09	66				1 987 477 660	← 1095	
							1 987 477 661	→ 832	
	1.8 i	ABO 06.04-12.09	92				1 987 482 139	→ 1143	
							1 987 482 140	← 1426	
		ABS 06.04-12.09	92				1 987 477 660	← 1095	
							1 987 477 661	→ 832	
	1.3 CDTI	06.04-03.09	51				0 986 594 027 <sup>3</sup>		
	1.4 i	06.04-12.09	66				0 986 594 027 <sup>3</sup>		
	1.8 i	06.04-12.09	92				0 986 594 027 <sup>3</sup>		
<b>Vectra [B]</b>									
	1.6 i	09.95-08.00	55/74	Fg.-Nr. →W7999999			0 986 473 905	↔ ← 52	
	1.6 i 16V						0 986 473 906	↔ → 52	
		09.95-08.01	55/74	Fg.-Nr. X1000001→			0 986 473 056	↔ ← 57	1 987 470 005 <sup>7</sup>
							0 986 474 056	↔ → 57	1 987 470 005 <sup>7</sup>
	1.7 TD	09.95-08.01	60	Fg.-Nr. →W7999999			0 986 473 905	↔ ← 52	
							0 986 473 906	↔ → 52	
				Fg.-Nr. X1000001→			0 986 473 056	↔ ← 57	1 987 470 005 <sup>7</sup>
							0 986 474 056	↔ → 57	1 987 470 005 <sup>7</sup>
	1.8 i 16V	09.95-08.99	85	Fg.-Nr. →W7999999			0 986 473 905	↔ ← 52	
							0 986 473 906	↔ → 52	
				Fg.-Nr. X1000001→			0 986 473 056	↔ ← 57	1 987 470 005 <sup>7</sup>
							0 986 474 056	↔ → 57	1 987 470 005 <sup>7</sup>
		09.98-08.99	85				0 986 473 056	↔ ← 57	1 987 470 005 <sup>7</sup>
							0 986 474 056	↔ → 57	1 987 470 005 <sup>7</sup>
		09.00-08.01	92	Fg.-Nr. X1000001→			0 986 473 056	↔ ← 57	1 987 470 005 <sup>7</sup>
							0 986 474 056	↔ → 57	1 987 470 005 <sup>7</sup>
		03.01-08.01	81	Fg.-Nr. X1000001→			0 986 473 056	↔ ← 57	1 987 470 005 <sup>7</sup>
							0 986 474 056	↔ → 57	1 987 470 005 <sup>7</sup>
	2.0 DI	09.95-08.01	60/74/82	Fg.-Nr. →W7999999			0 986 473 905	↔ ← 52	
	2.0 DTI						0 986 473 906	↔ → 52	
	2.0 i			Fg.-Nr. X1000001→			0 986 473 056	↔ ← 57	1 987 470 005 <sup>7</sup>
							0 986 474 056	↔ → 57	1 987 470 005 <sup>7</sup>
	2.0 i	09.95-09.02	100				0 986 473 056	↔ ← 57	1 987 470 005 <sup>7</sup>
	2.0 i 16V						0 986 474 056	↔ → 57	1 987 470 005 <sup>7</sup>
	2.2 DTI, i, i 16V	10.99-08.01	92/106/ 108				0 986 473 056	↔ ← 57	1 987 470 005 <sup>7</sup>
							0 986 474 056	↔ → 57	1 987 470 005 <sup>7</sup>
	2.5 i V6	09.95-08.01	125-143				0 986 473 056	↔ ← 57	1 987 470 005 <sup>7</sup>
							0 986 474 056	↔ → 57	1 987 470 005 <sup>7</sup>



























			S							
	◀VAUXHALL Vectra [C]									
2.0 Turbo	03.03-10.08	129	Fg.-Nr. 51066207→	0986 134 081		← 57				
				0986 135 081		→ 57				
2.2 Direct	04.02-10.08	86-92/	Fg.-Nr. →51064146	0986 473 294		← 57				
2.2 DTI		100-114		0986 474 294		→ 57				
			Fg.-Nr. 51064147→	0986 134 018		← 57				
				0986 135 018		→ 57				
2.2 i	09.01-09.05	108		0986 473 308		← 60				
				0986 474 308		→ 60				
				0986 473 294		← 57				
				0986 474 294		→ 57				
2.8 GTS Turbo	09.06-10.08	206	Fg.-Nr. 61000001→	0986 135 056		← 60				
				0986 134 056		→ 60				
3.0 CDTI	03.03-10.08	130-135	Fg.-Nr. →31070293, →38047797	0986 473 308		← 60				
			Fg.-Nr. 31070294→, 38047798→	0986 474 308		→ 60				
				0986 135 056		← 60				
				0986 134 056		→ 60				
3.2 i	08.02-09.05	155		0986 473 308		← 60				
				0986 474 308		→ 60				
<hr/>										
	1.6 i	09.01-07.05	74	INB	0986 473 172		← 37,93			
					0986 474 172		→ 37,93			
	1.6 i GTS	01.06-10.08	74-77	INB	0986 473 172		← 37,93			
					0986 474 172		→ 37,93			
	1.8 Dualfuel	04.02-08.06	87-93	INB	0986 473 992		← 38			
					0986 474 992		→ 38			
	1.8 i	09.01-08.05	81-85	INB	0986 473 172		← 37,93			
					0986 474 172		→ 37,93			
			90	INB	0986 473 172		← 37,93			
					0986 474 172		→ 37,93			
		01.06-10.08	103	INB	0986 473 992		← 38			
					0986 474 992		→ 38			
	1.9 CDTI	04.04-10.08	88/110	INB	0986 473 992		← 38			
					0986 474 992		→ 38			
		09.05-10.08	74	INB	0986 473 172		← 37,93			
					0986 474 172		→ 37,93			
	2.0 DTI	04.02-09.05	74	INB	0986 473 172		← 37,93			
					0986 474 172		→ 37,93			
	2.0 Turbo	03.03-10.08	129	INB	0986 473 992		← 38			
					0986 474 992		→ 38			
				INB	0986 473 172		← 37,93			
					0986 474 172		→ 37,93			
	2.2 Direct	09.03-10.08	100-114	INB	0986 473 992		← 38			
					0986 474 992		→ 38			
				INB	0986 473 172		← 37,93			
					0986 474 172		→ 37,93			
	2.2 DTI	04.02-09.05	86-92	INB	0986 473 172		← 37,93			
					0986 474 172		→ 37,93			
	2.2 i	09.01-09.05	108	INB	0986 473 172		← 37,93			
					0986 474 172		→ 37,93			
	2.8 GTS Turbo	09.05-10.08	169/184-188/	INB	0986 473 172		← 37,93			
	2.8 Turbo		206		0986 474 172		→ 37,93			
	3.0 CDTI	03.03-10.08	130-135	INB	0986 473 992		← 38			
					0986 474 992		→ 38			
	3.2 i	08.02-09.05	155		0986 473 992		← 38			
					0986 474 992		→ 38			
<hr/>										
	1.6 i	09.01-07.05	74		1987 477 763		1630			
	1.6 i GTS	01.06-10.08	74-77	Fg.-Nr. →31151222, →38119629	SSZ	1987 477 763	1630			



	◀ VAUXHALL Vectra Estate [B]								
1.8 i 16V	09.95-08.99	85	Fg.-Nr. →V7999999	0986 473 379		←	34,94		
				0986 474 379		→	34,94		
1.8 i 16V	09.98-08.99	85	Fg.-Nr. →11021473, →17003609	0986 134 058		←	1987 470 086 <sup>7</sup>		
				0986 473 061		←			
				0986 135 058		→	1987 470 086 <sup>7</sup>		
	09.00-08.01	92	Fg.-Nr. →11021473, →17003609	0986 474 061		→			
				0986 134 058		←	1987 470 086 <sup>7</sup>		
		03.01-08.01	81	Fg.-Nr. 11021474→, 17003610→	0986 473 061		←		
0986 135 058						→	1987 470 086 <sup>7</sup>		
2.0 DI	09.96-08.00	60	Fg.-Nr. →V7999999 KOB	0986 134 058		←	1987 470 086 <sup>7</sup>		
				0986 473 061		←			
2.0 DI	09.96-08.00	60	Fg.-Nr. →V7999999 KOB	0986 474 379		→	34,94		
				0986 135 058		→	1987 470 086 <sup>7</sup>		
2.0 DTI	09.97-08.00	74	Fg.-Nr. →V7999999	0986 473 061		→			
				0986 474 379		→	34,94		
2.0 DTI	09.97-08.01	74	Fg.-Nr. W1000001→11021473, W5000001→W5999999, W7000001→17003609, XL000001→YL633894	0986 134 058		←	1987 470 086 <sup>7</sup>		
				0986 473 061		←			
2.0 DTI	04.01-08.01	74	Fg.-Nr. 11021474→, 17003610→	0986 135 058		→	1987 470 086 <sup>7</sup>		
				0986 474 061		→			
2.0 i 16V	09.95-08.01	100	Fg.-Nr. →V7999999	0986 134 058		←	1987 470 086 <sup>7</sup>		
				0986 473 061		←			
2.0 i 16V	09.95-08.01	100	Fg.-Nr. →V7999999	0986 135 058		→	1987 470 086 <sup>7</sup>		
				0986 474 379		→	34,94		
2.2 DTI	09.00-08.01	92/108	Fg.-Nr. →11021473, →17003609	0986 473 061		←			
				0986 134 058		←	1987 470 086 <sup>7</sup>		
2.2 i 16V	09.00-08.01	92/108	Fg.-Nr. →11021473, →17003609	0986 135 058		→	1987 470 086 <sup>7</sup>		
				0986 474 061		→			
2.2 DTI	09.00-08.01	92/108	Fg.-Nr. →11021473, →17003609	0986 134 058		←	1987 470 086 <sup>7</sup>		
				0986 135 058		→	1987 470 086 <sup>7</sup>		
2.5 i V6	09.95-08.01	125-143	Fg.-Nr. W1000001→11021473, W5000001→W5999999, W7000001→17003609, XL000001→YL633894	0986 473 061		←			
				0986 134 058		←	1987 470 086 <sup>7</sup>		
2.5 i V6	09.95-08.01	125-143	Fg.-Nr. W1000001→11021473, W5000001→W5999999, W7000001→17003609, XL000001→YL633894	0986 135 058		→	1987 470 086 <sup>7</sup>		
				0986 474 061		→			
2.6 V6	09.00-08.01	130	Fg.-Nr. →11021473, →17003609	0986 134 058		←	1987 470 086 <sup>7</sup>		
				0986 473 061		←			
2.6 V6	09.00-08.01	130	Fg.-Nr. →11021473, →17003609	0986 135 058		→	1987 470 086 <sup>7</sup>		
				0986 474 061		→			
2.6 V6	09.00-08.01	130	Fg.-Nr. 11021474→, 17003610→	0986 134 058		←	1987 470 086 <sup>7</sup>		
				0986 135 058		→	1987 470 086 <sup>7</sup>		
	1.6 i 16V	09.95-08.01	55/74				1987 477 391	1455	
	1.7 TD	09.95-08.01	60				1987 477 391	1455	
	1.8 i 16V	09.95-08.99	85				1987 477 391	1455	
		09.00-08.01	92				1987 477 391	1455	
		03.01-08.01	81				1987 477 391	1455	
	2.0 DI, DTI, i 16V	09.95-08.01	60/74/100				1987 477 391	1455	



































		S							
									
	<b>1.9 DI</b>	03.01-08.06	59-60/74	Fg.-Nr. →2V607598, →2V607581			0 986 <b>473 480</b>	 ← 41	
	<b>1.9 DTI</b>						0 986 <b>474 480</b>	 → 41	
	<b>2.0 16V</b>	03.01→	86-88	Fg.-Nr. →2V607598, →2V607581			0 986 <b>473 480</b>	 ← 41	
							0 986 <b>474 480</b>	 → 41	
	<b>2.5 DTI</b>	04.04-08.06	99	Fg.-Nr. →2V607598, →2V607581			0 986 <b>473 480</b>	 ← 41	
							0 986 <b>474 480</b>	 → 41	
									
	<b>1.9 DI</b>	03.01-08.06	59-60/74				1 987 <b>477 116</b>	→ 1603	
	<b>1.9 DTI</b>						1 987 <b>477 137</b>	← 1503	
					FKR,MI		1 987 <b>482 043</b>	1190	
					FLR,MI		1 987 <b>482 145</b>	1585	
					FLR,TW		1 987 <b>482 292</b>	1887	
					LLE		1 987 <b>482 042</b>	508	
					RLE		1 987 <b>482 146</b>	600	
	<b>2.0 CDTI</b>	03.01→	66/84/				1 987 <b>477 116</b>	→ 1603	
	<b>2.0 16V</b>		86-88				1 987 <b>477 137</b>	← 1503	
				Fg.-Nr. →AV606709	FKR,LLE		1 987 <b>482 524</b>	1245	
					FLR,MI,TW		1 987 <b>482 145</b>	1585	
					FLR,TW		1 987 <b>482 525</b>	1643	
	<b>2.5 CDTI</b>	08.06→	107				1 987 <b>477 116</b>	→ 1603	
							1 987 <b>477 137</b>	← 1503	
				Fg.-Nr. →AV606709	FKR,LLE		1 987 <b>482 524</b>	1245	
					FLR,MI,TW		1 987 <b>482 145</b>	1585	
					FLR,TW		1 987 <b>482 525</b>	1643	
		09.06-06.08	84				1 987 <b>477 116</b>	→ 1603	
							1 987 <b>477 137</b>	← 1503	
				Fg.-Nr. →AV606709	FKR,LLE		1 987 <b>482 524</b>	1245	
					FLR,TW		1 987 <b>482 525</b>	1643	
	<b>2.5 DTI</b>	04.04-08.06	99				1 987 <b>477 116</b>	→ 1603	
							1 987 <b>477 137</b>	← 1503	
					FKR,MI		1 987 <b>482 043</b>	1190	
					FLR,MI		1 987 <b>482 145</b>	1585	
					FLR,TW		1 987 <b>482 292</b>	1887	
					LLE		1 987 <b>482 042</b>	508	
					RLE		1 987 <b>482 146</b>	600	
	<b>1.9 DI, DTI</b>	03.01-08.06	59-60/74	Fg.-Nr. 7V600001→, 7Y000001→			0 265 <b>008 077<sup>3</sup></b>		
	<b>2.0 CDTI</b>	08.06→	66/84	Fg.-Nr. →9V620473, TW →9Y708998			0 265 <b>008 077<sup>3</sup></b>		
				Fg.-Nr. 7V655888→8V699999, 7Y000001→8Y799999			0 265 <b>008 078<sup>4</sup></b>		
				Fg.-Nr. 9V600001→, TW 9Y000001→			0 265 <b>008 916<sup>4</sup></b>		
				Fg.-Nr. 9V620474→, TW 9Y798999→			0 265 <b>008 041<sup>3</sup></b>		
		12.10→	66/84		TW		0 265 <b>008 041<sup>3</sup></b>		
							0 265 <b>008 916<sup>4</sup></b>		
	<b>2.0 16V</b>	03.01→	86-88	Fg.-Nr. →9V620473, TW →9Y708998			0 265 <b>008 077<sup>3</sup></b>		
				Fg.-Nr. 7V655888→8V699999, 7Y000001→8Y799999			0 265 <b>008 078<sup>4</sup></b>		
				Fg.-Nr. 9V600001→, TW 9Y000001→			0 265 <b>008 916<sup>4</sup></b>		
				Fg.-Nr. 9V620474→, TW 9Y798999→			0 265 <b>008 041<sup>3</sup></b>		
	<b>2.5 CDTI</b>	08.06→	107	Fg.-Nr. →9V620473, TW →9Y708998			0 265 <b>008 077<sup>3</sup></b>		
				Fg.-Nr. 7V655888→8V699999, 7Y000001→8Y799999			0 265 <b>008 078<sup>4</sup></b>		



<b>VAUXHALL Vivaro</b>								
2.5 CDTI	08.06→	107	Fg.-Nr. 9V600001→, 9Y000001→	TW		0 265 008 916 <sup>4</sup>		
			Fg.-Nr. 9V620474→, 9Y798999→	TW		0 265 008 041 <sup>3</sup>		
	09.06-06.08	84	Fg.-Nr. →9V620473, →9Y708998	TW		0 265 008 077 <sup>3</sup>		
			Fg.-Nr. 7V600001→, 7Y000001→			0 265 008 077 <sup>3</sup>		
			Fg.-Nr. 7V655888→8V699999, 7Y000001→8Y799999			0 265 008 078 <sup>4</sup>		
			Fg.-Nr. 9V600001→, 9Y000001→			0 265 008 916 <sup>4</sup>		
			Fg.-Nr. 9V620474→, 9Y798999→			0 265 008 041 <sup>3</sup>		
2.5 DTI	04.04-08.06	99	Fg.-Nr. 7V600001→, 7Y000001→			0 265 008 077 <sup>3</sup>		
						0 265 008 078 <sup>4</sup>		
<b>Zafira [A]</b>								
	1.6 i, i CNG, i Dualfuel	09.98-06.05	69-73/74			0 986 473 062	← 57	1 987 470 005 <sup>7</sup>
						0 986 474 062	→ 57	1 987 470 005 <sup>7</sup>
	1.8 i	03.99-06.05	85/92			0 986 473 062	← 57	1 987 470 005 <sup>7</sup>
	1.8 i Dualfuel					0 986 474 062	→ 57	1 987 470 005 <sup>7</sup>
	2.0 DI, DTI, Turbo	03.99-06.05	60/74/141			0 986 473 062	← 57	1 987 470 005 <sup>7</sup>
						0 986 474 062	→ 57	1 987 470 005 <sup>7</sup>
	2.2	09.00-06.05	108			0 986 473 062	← 57	1 987 470 005 <sup>7</sup>
						0 986 474 062	→ 57	1 987 470 005 <sup>7</sup>
	1.6 i, i Dualfuel	09.98-06.05	74			0 986 475 869	↔ 20,64	
	1.8 i Dualfuel	09.00-06.05	92			0 986 475 869	↔ 20,64	
	2.0 Turbo	09.01-06.05	141			0 986 475 869	↔ 20,64	
	1.6 i	09.98-06.05	74		LUC	0 986 474 223	→ 38,1	
				Fg.-Nr. →Y2147599	4SB	0 986 473 326	← 38	
						0 986 474 326	→ 38	
	1.6 i CNG	09.01-06.05	69-73		LUC	0 986 473 223	← 38,1	
						0 986 474 223	→ 38,1	
	1.6 i Dualfuel	09.99-06.05	74		LUC	0 986 474 223	→ 38,1	
	1.6 i, i Dualfuel	09.98-06.05	74		LUC	0 986 473 223	← 38,1	
	1.8 i	03.99-06.05	85/92		LUC	0 986 474 223	→ 38,1	
				Fg.-Nr. →Y2147599	4SB	0 986 473 326	← 38	
						0 986 474 326	→ 38	
	1.8 i Dualfuel	09.00-06.05	85/92		LUC	0 986 474 223	→ 38,1	
	1.8 i, i Dualfuel	03.99-06.05	85/92		LUC	0 986 473 223	← 38,1	
	2.0 DI	03.99-06.05	60/74		LUC	0 986 473 223	← 38,1	
	2.0 DTI					0 986 474 223	→ 38,1	
				Fg.-Nr. →Y2147599	4SB	0 986 473 326	← 38	
						0 986 474 326	→ 38	
	2.0 Turbo	09.01-06.05	141		LUC	0 986 473 223	← 38,1	
						0 986 474 223	→ 38,1	
	2.2	09.00-06.05	108		LUC	0 986 473 223	← 38,1	
						0 986 474 223	→ 38,1	
				Fg.-Nr. →Y2147599	4SB	0 986 473 326	← 38	
						0 986 474 326	→ 38	
	2.2 DTI	03.02-06.05	92		LUC	0 986 473 223	← 38,1	
						0 986 474 223	→ 38,1	
	1.6 i	09.98-08.99	74		4SB	1 987 477 528		1680
		09.98-06.05	74		STB	1 987 477 868		1355
		09.99-06.05	74	Fg.-Nr. Y2247424→	4SB	1 987 477 528		1680

		S								
<b>1.6i</b> CNG		09.01-06.05	69-73				STB	1 987 477 868	1355	
							Fg.-Nr. →220006460, →1H9999999	4SB	1 987 477 528	1680
							Fg.-Nr. 22006461→32999999, 2H000001→3H999999	4SB	1 987 482 107	1680
							Fg.-Nr. 42000001→, 4H000001→	4SB	1 987 482 141	1677
<b>1.6i</b> Dualfuel		09.99-06.05	74				STB	1 987 477 868	1355	
<b>1.8i</b>		03.99-09.00	85					1 987 477 528	1680	
		09.00-06.05	92					1 987 477 528	1680	
<b>1.8i</b> Dualfuel		09.00-06.05	92				SSZ,STB	1 987 477 868	1355	
							Fg.-Nr. →Y2247423	4SB	1 987 477 528	1680
							Fg.-Nr. →220006460, →1H9999999	4SB	1 987 477 528	1680
							Fg.-Nr. 22006461→32999999, 2H000001→3H999999	4SB	1 987 482 107	1680
							Fg.-Nr. 42000001→, 4H000001→	4SB	1 987 482 141	1677
<b>2.0i</b> , DTI		03.99-06.05	60/74					1 987 477 528	1680	
<b>2.0</b> Turbo		09.01-06.05	141				STB	1 987 477 868	1355	
							Fg.-Nr. →220006460, →1H9999999	4SB	1 987 477 528	1680
							Fg.-Nr. 22006461→32999999, 2H000001→3H999999	4SB	1 987 482 107	1680
							Fg.-Nr. 42000001→, 4H000001→	4SB	1 987 482 141	1677
<b>2.2</b>		09.00-06.05	108					1 987 477 528	1680	
<b>2.2</b> DTI		03.02-06.05	92				STB	1 987 477 868	1355	
							Fg.-Nr. →220006460, →1H9999999	4SB	1 987 477 528	1680
							Fg.-Nr. 22006461→32999999, 2H000001→3H999999	4SB	1 987 482 107	1680
							Fg.-Nr. 42000001→, 4H000001→	4SB	1 987 482 141	1677

## Zafira [B]

									
 <b>1.6</b> CNG		09.05-03.10	69-71			SBJ	0 986 473 062	 ← 57	1 987 470 005 <sup>7</sup>
							0 986 474 062	 → 57	1 987 470 005 <sup>7</sup>
<b>1.6</b> CNG Turbo		03.07-01.15	83/85/110			SBJ	0 986 473 062	 ← 57	1 987 470 005 <sup>7</sup>
<b>1.6i</b>		07.05-02.09	77				0 986 474 062	 → 57	1 987 470 005 <sup>7</sup>
							0 986 473 062	 ← 57	1 987 470 005 <sup>7</sup>
<b>1.7</b> CDTI		03.08-01.15	81/92			SBJ	0 986 473 062	 ← 57	1 987 470 005 <sup>7</sup>
							0 986 474 062	 → 57	1 987 470 005 <sup>7</sup>
<b>1.8i</b>		07.05-02.10	103			SBJ	0 986 473 062	 ← 57	1 987 470 005 <sup>7</sup>
		01.11-01.15	103			SBJ	0 986 474 062	 → 57	1 987 470 005 <sup>7</sup>
							0 986 473 062	 ← 57	1 987 470 005 <sup>7</sup>
<b>1.8</b> LPG		03.10-12.10	101-103				0 986 473 062	 ← 57	1 987 470 005 <sup>7</sup>
							0 986 474 062	 → 57	1 987 470 005 <sup>7</sup>
<b>1.9</b> CDTI		07.05-03.08	74				0 986 473 062	 ← 57	1 987 470 005 <sup>7</sup>
							0 986 474 062	 → 57	1 987 470 005 <sup>7</sup>
<b>2.0i</b> Turbo		07.05-12.10	88/110			SBJ	0 986 473 062	 ← 57	1 987 470 005 <sup>7</sup>
							0 986 474 062	 → 57	1 987 470 005 <sup>7</sup>
<b>2.0i</b> Turbo		07.05-12.10	147/177			SBJ	0 986 473 062	 ← 57	1 987 470 005 <sup>7</sup>
							0 986 474 062	 → 57	1 987 470 005 <sup>7</sup>
<b>2.2i</b> Direkt		07.05-12.10	110			SBJ	0 986 473 062	 ← 57	1 987 470 005 <sup>7</sup>
							0 986 474 062	 → 57	1 987 470 005 <sup>7</sup>

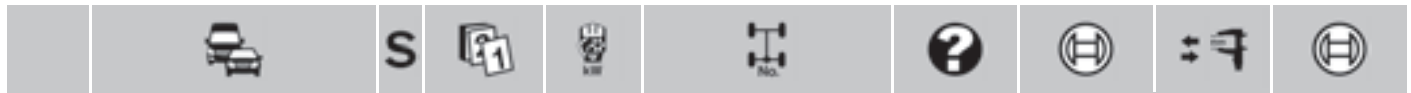

◀ VAUXHALL Zafira [B]



	1.6 CNG	09.05-03.10	69-71		SBJ	0986 134 050	← 41
						0986 135 050	→ 41
	1.6 CNG Turbo	03.07-01.15	83/85/110		SBJ	0986 134 050	← 41
	1.6 i					0986 135 050	→ 41
	1.6 i	07.05-02.09	77			0986 134 050	← 41
						0986 135 050	→ 41
	1.7 CDTI	03.08-01.15	81/92		SBJ	0986 134 050	← 41
						0986 135 050	→ 41
	1.8 i	07.05-02.10	103		SBJ	0986 134 050	← 41
						0986 135 050	→ 41
		01.11-01.15	103		SBJ	0986 134 050	← 41
						0986 135 050	→ 41
		06.13-01.15	88		SBJ	0986 134 050	← 41
						0986 135 050	→ 41
	1.8 LPG	03.10-12.10	101-103			0986 134 050	← 41
						0986 135 050	→ 41
	1.9 CDTI	07.05-03.08	74			0986 134 050	← 41
						0986 135 050	→ 41
		07.05-12.10	88/110		SBJ	0986 134 050	← 41
						0986 135 050	→ 41
	2.0 i Turbo	07.05-12.10	147/177		SBJ	0986 134 050	← 41
						0986 135 050	→ 41
	2.2 i Direkt	07.05-12.10	110		SBJ	0986 134 050	← 41
						0986 135 050	→ 41



	1.6 CNG	09.05-03.10	69-71	Fg.-Nr. →52999999		1987 477 163	1774
	1.6 i	07.05-02.09	77			1987 477 163	↔ 1774
		03.07-12.12	83		TW	1987 477 163	1774
		01.11-01.15	85			1987 477 163	1774
	1.7 CDTI	03.08-12.12	81/92		TW	1987 477 163	1774
		03.08-01.15	81/92			1987 477 163	1774
	1.8 i	07.05-02.10	103			1987 477 163	↔ 1774
		01.11-01.15	103			1987 477 163	1774
		06.13-01.15	88			1987 477 163	1774
	1.8 LPG	03.10-12.10	101-103			1987 477 163	1774
	1.9 CDTI	07.05-03.08	74			1987 477 163	↔ 1774
		07.05-12.10	88/110		TW	1987 477 163	1774
	2.0 i Turbo	07.05-12.10	147/177		TW	1987 477 163	1774
	2.2 i Direkt	07.05-12.10	110		TW	1987 477 163	1774

Zafira [C]



	1.4 Turbo	01.12→	88/103		D32	0986 134 319	← 60
						0986 135 319	→ 60
	1.6 CDTI	01.12→	100/110		D32	0986 134 319	← 60
	1.6 CNG					0986 135 319	→ 60
	1.8	01.12→	85/103		D32	0986 134 319	← 60
						0986 135 319	→ 60
	2.0 CDTI	01.12→	81/96/121/ 125/143		D32	0986 134 319	← 60
						0986 135 319	→ 60



## VOLVO

## C30 [P14]



	<b>Electric</b>	08.11→	82		0 986 473 385		←	56,95
					0 986 474 385		→	56,95
	<b>1.6</b> 1.6 D DRIVe	10.06-07.12	74/80	Fg.-Nr. →3429	0 986 473 385		←	56,95
					0 986 474 385		→	56,95
				Fg.-Nr. 3430→	0 986 473 385		←	56,95
					0 986 474 385		→	56,95
	<b>1.6 D2 DRIVe</b>	08.10→	84		0 986 473 385		←	56,95
					0 986 474 385		→	56,95
	<b>1.8</b> 1.8 F Flexifuel	10.06-07.10	92	Fg.-Nr. →3429	0 986 473 385		←	56,95
					0 986 474 385		→	56,95
				Fg.-Nr. 3430→	0 986 473 385		←	56,95
					0 986 474 385		→	56,95
	<b>2.0</b>	10.06→	107	Fg.-Nr. →3429	0 986 473 385		←	56,95
					0 986 474 385		→	56,95
				Fg.-Nr. 3430→	0 986 473 385		←	56,95
					0 986 474 385		→	56,95
	<b>2.0 D</b>	10.06-09.10	96/100	Fg.-Nr. →3429	0 986 473 385		←	56,95
					0 986 474 385		→	56,95
				Fg.-Nr. 3430→	0 986 473 385		←	56,95
					0 986 474 385		→	56,95
	<b>2.0 D3</b>	08.10→	110/130		0 986 473 385		←	56,95
	<b>2.0 D4</b>				0 986 474 385		→	56,95
	<b>2.0 F Flexifuel</b>	08.09→	107		0 986 473 385		←	56,95
					0 986 474 385		→	56,95
	<b>2.4 D5</b> 2.4 i	10.06-07.10	120/125/ 132	Fg.-Nr. →3429	0 986 473 385		←	56,95
					0 986 474 385		→	56,95
				Fg.-Nr. 3430→	0 986 473 385		←	56,95
					0 986 474 385		→	56,95
	<b>2.5 T5</b>	10.06→	162/169	Fg.-Nr. →3429	0 986 473 385		←	56,95
					0 986 474 385		→	56,95
				Fg.-Nr. 3430→	0 986 473 385		←	56,95
					0 986 474 385		→	56,95



	<b>Electric</b>	08.11→	82		1 987 482 019		1816
					1 987 482 188		337
	<b>1.6</b> 1.6 D DRIVe	10.06-07.12	74/80		1 987 482 188		337
				RLE	1 987 482 019		1816
	<b>1.6 D2 DRIVe</b>	08.10→	84		1 987 482 019	RLE	1816
	<b>1.8</b> 1.8 F Flexifuel	10.06-07.10	92		1 987 482 188		337
				RLE	1 987 482 019		1816
	<b>2.0, D, F Flexifuel</b>	10.06→	96/100/ 107		1 987 482 188		337
				RLE	1 987 482 019		1816
	<b>2.0 D3, D4</b>	08.10→	110/130		1 987 482 019	RLE	1816
	<b>2.4 D5</b>	10.06-07.10	120/125/		1 987 482 188		337
	<b>2.4 i</b>		132		1 987 482 019	RLE	1816
				RLE	1 987 482 188		337
	<b>2.5 T5</b>	10.06→	162/169		1 987 482 188		337
				RLE	1 987 482 019		1816

























































## C70 Coupé



	<b>2.0 T</b>	01.97-07.02	120/132/ 166		0 986 474 877		←	57
					0 986 474 878		→	57
	<b>2.3 T5</b>	09.97-07.02	176		0 986 474 877		←	57
					0 986 474 878		→	57

		S							
	<b>◀ VOLVO C70 Coupé</b>								
	2.4T	03.99-07.02	121/				0986 474 877		← 57
	2.420V		142-177				0986 474 878		→ 57
	2.5LPT	01.98-07.00	125/142				0986 474 877		← 57
	2.5 20V						0986 474 878		→ 57
	2.0T	01.97-07.02	120/132/166	Fg.-Nr. →2020			0986 474 885		← 38
							0986 474 886		→ 38
	2.3T5	09.97-07.02	176	Fg.-Nr. →2020			0986 474 885		← 38
							0986 474 886		→ 38
	2.4T	03.99-07.02	121/	Fg.-Nr. →2020			0986 474 885		← 38
	2.420V		142-177				0986 474 886		→ 38
	2.5LPT	01.98-07.00	125/142	Fg.-Nr. →2020			0986 474 885		← 38
	2.5 20V						0986 474 886		→ 38
	2.0T	01.97-07.02	120/132/166				1987 482 262		↔ 1695
	2.3T5	09.97-07.02	176				1987 482 262		↔ 1695
	2.4T	08.99-07.02	121/142-177				1987 482 262		↔ 1695
	2.420V	03.99-07.00	121/142-177				1987 482 262		↔ 1695
	2.5LPT	01.98-07.99	125/142				1987 482 262		↔ 1695
	2.5 20V	03.99-07.00	125/142				1987 482 262		↔ 1695
<b>C70 I Cabrio</b>									
	2.0T	03.98-03.06	120/132/166				0986 474 877		← 57
							0986 474 878		→ 57
	2.3T5	02.98-03.06	176/180				0986 474 877		← 57
							0986 474 878		→ 57
	2.4, T, T5	08.98-03.06	103-125/142/147				0986 474 877		← 57
							0986 474 878		→ 57
	2.0T	03.98-03.06	120/132/166	Fg.-Nr. →2020			0986 474 885		← 38
							0986 474 886		→ 38
	2.3T5	02.98-03.06	176/180	Fg.-Nr. →2020			0986 474 885		← 38
							0986 474 886		→ 38
	2.4, T, T5	08.98-03.06	103-125/142/147	Fg.-Nr. →2020			0986 474 885		← 38
							0986 474 886		→ 38
	2.0T	03.98-03.06	120/132/166				1987 482 262		↔ 1695
	2.3T5	02.98-03.06	176/180				1987 482 262		↔ 1695
	2.4	03.99-07.00	103-125/142/147				1987 482 262		↔ 1695
	2.4T	08.98-07.02	103-125/142/147				1987 482 262		↔ 1695
	2.4T5	08.02-03.06	103-125/142/147				1987 482 262		↔ 1695
<b>C70 II Cabrio</b>									
	2.0D	01.08-07.10	100				0986 134 002		← 57
							0986 135 002		→ 57
					278		0986 473 385		← 56,95
							0986 474 385		→ 56,95
	2.0D3	10.10-07.13	110/130				0986 134 002		← 57
	2.0D4						0986 135 002		→ 57
					278		0986 473 385		← 56,95
							0986 474 385		→ 56,95



	S				?			
2.4	03.06-07.10	103/120/				0 986 134 002	 ← 57	
2.4D		125/132				0 986 135 002	 → 57	
2.4D5				278		0 986 473 385	 ← 56,95	
2.4i						0 986 474 385	 → 56,95	
2.5T5	03.06-12.13	162/169				0 986 134 002	 ← 57	
						0 986 135 002	 → 57	
								
	2.0D	01.08-07.10	100			1 987 482 019	1816	
	2.0D3	10.10-07.13	110/130			1 987 482 188	337	
	2.0D4				RLE	1 987 482 019	1816	
	2.4, D, D5, i	03.06-07.10	103/120/ 125/132			1 987 482 019	1816	
						1 987 482 188	337	
	2.5T5	03.06-07.07	162			1 987 482 019	1816	
						1 987 482 188	337	
		08.07-12.13	169			1 987 482 188	337	
					RLE	1 987 482 019	1816	
<b>S40 I</b>								
								
	1.6 16V	01.97-07.97	77			0 986 473 183	 ← 53,96	
						0 986 474 183	 → 53,96	
		08.97-07.99	77			0 986 473 176	 ← 53,93	
						0 986 474 176	 → 54	
		08.99-07.03	80			0 986 473 176	 ← 53,93	
						0 986 474 176	 → 54	
	1.8 16V	09.95-07.97	85			0 986 473 183	 ← 53,96	
						0 986 474 183	 → 53,96	
		08.97-07.99	85			0 986 473 176	 ← 53,93	
						0 986 474 176	 → 54	
		09.97-07.03	90/92			0 986 473 176	 ← 53,93	
						0 986 474 176	 → 54	
	1.9D	05.96-07.97	66			0 986 473 183	 ← 53,96	
						0 986 474 183	 → 53,96	
		08.97-07.99	66			0 986 473 176	 ← 53,93	
						0 986 474 176	 → 54	
		03.98-07.03	70/75/85			0 986 473 176	 ← 53,93	
						0 986 474 176	 → 54	
	1.9T4	05.97-07.97	147			0 986 473 183	 ← 53,96	
						0 986 474 183	 → 53,96	
		08.97-07.00	147			0 986 473 176	 ← 53,93	
						0 986 474 176	 → 54	
	2.0T, T 16V, T4	04.98-07.03	118/120/ 121/147			0 986 473 176	 ← 53,93	
						0 986 474 176	 → 54	
	2.0 16V	09.95-07.97	103			0 986 473 183	 ← 53,96	
						0 986 474 183	 → 53,96	
		08.97-07.99	103			0 986 473 176	 ← 53,93	
						0 986 474 176	 → 54	
		08.99-07.03	100			0 986 473 176	 ← 53,93	
						0 986 474 176	 → 54	
								
	1.6 16V	01.97-01.04	77/80	Fg.-Nr. →426760		0 986 473 068	 ← 38	1 987 470 040 <sup>7</sup>
						0 986 474 068	 → 38	1 987 470 040 <sup>7</sup>
				Fg.-Nr. 426761→850976		0 986 473 354	 ← 38,1	1 987 470 040 <sup>7</sup>
						0 986 474 354	 → 38,1	1 987 470 040 <sup>7</sup>
	1.8 16V	09.95-01.04	85/90/92	Fg.-Nr. →426760		0 986 473 068	 ← 38	1 987 470 040 <sup>7</sup>
						0 986 474 068	 → 38	1 987 470 040 <sup>7</sup>
				Fg.-Nr. 426761→850976		0 986 473 354	 ← 38,1	1 987 470 040 <sup>7</sup>
						0 986 474 354	 → 38,1	1 987 470 040 <sup>7</sup>



		S							
<b>VOLVO S40 I</b>									
1.9 D	05.96-01.04	66/70/75/	Fg.-Nr. →426760	0986 473 068		← 38	1987 470 040 <sup>7</sup>		
1.9 T4		85/147	Fg.-Nr. 426761→850976	0986 474 068		→ 38	1987 470 040 <sup>7</sup>		
				0986 473 354		← 38,1	1987 470 040 <sup>7</sup>		
				0986 474 354		→ 38,1	1987 470 040 <sup>7</sup>		
2.0 T	09.95-01.04	100/103/	Fg.-Nr. →426760	0986 473 068		← 38	1987 470 040 <sup>7</sup>		
2.0 T 16V		118/120/		0986 474 068		→ 38	1987 470 040 <sup>7</sup>		
2.0 T4		121/147	Fg.-Nr. 426761→850976	0986 473 354		← 38,1	1987 470 040 <sup>7</sup>		
2.0 16V				0986 474 354		→ 38,1	1987 470 040 <sup>7</sup>		
1.6 16V	01.97-07.99	77		1987 477 530		← 1590			
				1987 477 878		→ 1590			
	08.99-07.00	80		1987 477 530		← 1590			
				1987 477 878		→ 1590			
1.8 16V	09.95-07.99	85		1987 477 530		← 1590			
	09.97-07.00	92		1987 477 878		→ 1590			
1.9 D	05.96-07.00	66/70		1987 477 893		← 1620			
				1987 477 894		→ 1620			
	08.00-01.04	80		1987 477 893		← 1620			
				1987 477 894		→ 1620			
1.9 T4	09.95-07.99	85		1987 477 530		← 1590			
	09.97-07.00	92		1987 477 878		→ 1590			
	08.99-01.04	90		1987 477 893		← 1620			
1.9 D	05.96-07.00	66/70		1987 477 894		→ 1620			
	08.00-01.04	75/85		1987 477 530		← 1590			
1.9 T4	05.97-07.00	147		1987 477 878		→ 1590			
				1987 477 894		→ 1620			
2.0 T	08.00-01.04	120/121/		1987 477 893		← 1620			
2.0 T4		147		1987 477 894		→ 1620			
2.0 T 16V	09.95-07.00	103/118		1987 477 530		← 1590			
2.0 16V				1987 477 878		→ 1590			
2.0 16V	08.99-01.04	100		1987 477 893		← 1620			
				1987 477 894		→ 1620			
1.6 16V	01.97-08.97	77		LAB	0265 006 224 <sup>3</sup>				
				RAB	0265 006 223 <sup>3</sup>				
	01.97-07.99	77			0265 006 366 <sup>4</sup>				
	09.97-07.99	77			0265 006 425 <sup>3</sup>				
1.8 16V	08.99-01.04	80			0265 006 425 <sup>3</sup>				
				Fg.-Nr. →985261	0265 006 366 <sup>4</sup>				
				Fg.-Nr. 985262→	0265 006 698 <sup>4</sup>				
	09.95-08.97	85		LAB	0265 006 224 <sup>3</sup>				
1.9 D				RAB	0265 006 223 <sup>3</sup>				
	09.95-07.99	85			0265 006 366 <sup>4</sup>				
	09.97-07.99	85			0265 006 425 <sup>3</sup>				
	09.97-07.00	92			0265 006 366 <sup>4</sup>				
1.9 T4					0265 006 425 <sup>3</sup>				
	08.99-01.04	90			0265 006 425 <sup>3</sup>				
				Fg.-Nr. →985261	0265 006 366 <sup>4</sup>				
				Fg.-Nr. 985262→	0265 006 698 <sup>4</sup>				
1.9 D	05.96-08.97	66		LAB	0265 006 224 <sup>3</sup>				
				RAB	0265 006 223 <sup>3</sup>				
	05.96-07.99	66			0265 006 366 <sup>4</sup>				
	09.97-07.99	66			0265 006 425 <sup>3</sup>				
1.9 T4	03.98-07.00	70			0265 006 366 <sup>4</sup>				
					0265 006 425 <sup>3</sup>				
	08.00-01.04	75/85			0265 006 425 <sup>3</sup>				
				Fg.-Nr. →985261	0265 006 366 <sup>4</sup>				
			Fg.-Nr. 985262→	0265 006 698 <sup>4</sup>					
1.9 T4	05.97-08.97	147		LAB	0265 006 224 <sup>3</sup>				
				RAB	0265 006 223 <sup>3</sup>				

	S							
1.9 T4	05.97-07.00	147				0 265 006 366 <sup>4</sup>		
	09.97-07.00	147				0 265 006 425 <sup>3</sup>		
2.0 T	08.00-01.04	120/121/				0 265 006 425 <sup>3</sup>		
2.0 T4		147			Fg.-Nr. →985261	0 265 006 366 <sup>4</sup>		
					Fg.-Nr. 985262→	0 265 006 698 <sup>4</sup>		
2.0 T 16V	04.98-07.00	118				0 265 006 366 <sup>4</sup>		
						0 265 006 425 <sup>3</sup>		
2.0 16V	09.95-08.97	103			LAB	0 265 006 224 <sup>3</sup>		
					RAB	0 265 006 223 <sup>3</sup>		
	09.95-07.99	103				0 265 006 366 <sup>4</sup>		
	09.97-07.99	103				0 265 006 425 <sup>3</sup>		
	08.99-01.04	100				0 265 006 425 <sup>3</sup>		
					Fg.-Nr. →985261	0 265 006 366 <sup>4</sup>		
					Fg.-Nr. 985262→	0 265 006 698 <sup>4</sup>		
<b>S40 II [P11]</b>								
	1.6	11.04-08.12	74/80-81/			0 986 134 002		← 57
	1.6 D DRiVe		84			0 986 135 002		→ 57
	1.6 D2			278		0 986 473 385		← 56,95
						0 986 474 385		→ 56,95
	1.8	04.04-07.10	92			0 986 134 002		← 57
	1.8 F Flexifuel			278		0 986 135 002		→ 57
						0 986 473 385		← 56,95
						0 986 474 385		→ 56,95
	2.0, D, D3, D4, F Flexifuel	01.04-08.12	96/100/ 107/110/ 130	278		0 986 134 002		← 57
						0 986 135 002		→ 57
						0 986 473 385		← 56,95
						0 986 474 385		→ 56,95
	2.4	12.03-07.10	125			0 986 134 002		← 57
				278		0 986 135 002		→ 57
						0 986 473 385		← 56,95
						0 986 474 385		→ 56,95
		12.03→	125	15Z,16Z		0 986 473 385		← 56,95
						0 986 474 385		→ 56,95
	2.4	12.03-07.10	103/120			0 986 134 002		← 57
	2.4 D5			278		0 986 135 002		→ 57
						0 986 473 385		← 56,95
						0 986 474 385		→ 56,95
	2.4 D5	03.06-07.10	132			0 986 134 002		← 57
				278		0 986 135 002		→ 57
						0 986 473 385		← 56,95
						0 986 474 385		→ 56,95
	2.5 T5	12.03-07.07	162	278		0 986 473 385		← 56,95
						0 986 474 385		→ 56,95
		12.03→	162	15Z,16Z		0 986 473 385		← 56,95
						0 986 474 385		→ 56,95
	2.5 T5 AWD	04.04-07.07	162	278		0 986 473 385		← 56,95
						0 986 474 385		→ 56,95
	2.5 T5	12.03-07.07	162			0 986 134 002		← 57
	2.5 T5 AWD					0 986 135 002		→ 57
		08.07-12.12	169			0 986 134 002		← 57
				278		0 986 135 002		→ 57
						0 986 473 385		← 56,95
						0 986 474 385		→ 56,95
	2.4	12.03→	125			0 986 473 173		← 37,93
						0 986 474 173		→ 37,93
	2.5 T5	12.03→	162			0 986 473 173		← 37,93
						0 986 474 173		→ 37,93





◀ VOLVO S40 II [P11]









































































	<b>1.6</b>	11.04-08.12	74/80-81/		1987 <b>482 188</b>	337
	<b>1.6 D DRiVe</b>		84	Fg.-Nr. →190189	1987 <b>477 202</b>	1876
	<b>1.6 D2</b>			Fg.-Nr. 190190→	1987 <b>482 019</b>	1816
	<b>1.8</b>	04.04-07.10	92		1987 <b>482 188</b>	337
	<b>1.8 F Flexifuel</b>			Fg.-Nr. →190189	1987 <b>477 202</b>	1876
				Fg.-Nr. 190190→	1987 <b>482 019</b>	1816
	<b>2.0, D, D3, D4, F Flexifuel</b>	01.04-08.12	96/100/		1987 <b>482 188</b>	337
			107/110/	Fg.-Nr. →190189	1987 <b>477 202</b>	1876
			130	Fg.-Nr. 190190→	1987 <b>482 019</b>	1816
	<b>2.4</b>	12.03-07.10	125		1987 <b>482 188</b>	337
				Fg.-Nr. 190190→	1987 <b>482 019</b>	1816
		12.03→	125		1987 <b>477 202</b>	1876
	<b>2.4</b>	12.03-07.10	103/120		1987 <b>482 188</b>	337
	<b>2.4 D5</b>			Fg.-Nr. →190189	1987 <b>477 202</b>	1876
				Fg.-Nr. 190190→	1987 <b>482 019</b>	1816
	<b>2.4 D5</b>	03.06-07.10	132		1987 <b>482 188</b>	337
				Fg.-Nr. →190189	1987 <b>477 202</b>	1876
				Fg.-Nr. 190190→	1987 <b>482 019</b>	1816
	<b>2.5 T5</b>	12.03→	162		1987 <b>477 202</b>	1876
	<b>2.5 T5 AWD</b>	04.04-07.07	162	Fg.-Nr. →190189	1987 <b>477 202</b>	1876
	<b>2.5 T5</b>	12.03-07.07	162		1987 <b>482 188</b>	337
	<b>2.5 T5 AWD</b>			Fg.-Nr. 190190→	1987 <b>482 019</b>	1816
		08.07-12.12	169		1987 <b>482 188</b>	337
				Fg.-Nr. →190189	1987 <b>477 202</b>	1876
				Fg.-Nr. 190190→	1987 <b>482 019</b>	1816
	<b>2.5 T5 AWD</b>	04.04-07.10	162/169		0986 <b>594 569</b> <sup>4</sup>	

**S60 I**



	<b>2.0 T</b>	11.00-07.09	132		0986 <b>134 260</b>	←
					0986 <b>134 320</b>	← 57
					0986 <b>473 114</b>	← 59,95
					0986 <b>135 260</b>	→
					0986 <b>135 320</b>	→ 57
					0986 <b>474 114</b>	→ 59,95
				305	0986 <b>473 114</b>	← 59,95
					0986 <b>474 114</b>	→ 59,95
					0986 <b>134 260</b>	←
					0986 <b>134 320</b>	← 57
					0986 <b>473 114</b>	← 59,95
					0986 <b>135 260</b>	→
	0986 <b>135 320</b>	→ 57				
	0986 <b>474 114</b>	→ 59,95				
305	0986 <b>473 114</b>	← 59,95				
	0986 <b>474 114</b>	→ 59,95				
	<b>2.3 T5</b>	11.00-03.04	147-195		0986 <b>134 260</b>	←
					0986 <b>134 320</b>	← 57
					0986 <b>473 114</b>	← 59,95
					0986 <b>135 260</b>	→
					0986 <b>135 320</b>	→ 57
					0986 <b>474 114</b>	→ 59,95
					0986 <b>473 114</b>	← 59,95
					0986 <b>474 114</b>	→ 59,95
	<b>2.4</b>	11.00-07.09	85/90/93/		0986 <b>134 260</b>	←
	<b>2.4 Bi-Fuel CNG</b>		96/103/		0986 <b>134 320</b>	← 57
	<b>2.4 Bi-Fuel LPG</b>		120/123/		0986 <b>473 114</b>	← 59,95
	<b>2.4 D</b>		125		0986 <b>135 260</b>	→
					0986 <b>135 320</b>	→ 57
					0986 <b>474 114</b>	→ 59,95
					0986 <b>473 114</b>	← 59,95
					0986 <b>474 114</b>	→ 59,95

								
2.4 D5	08.05-07.09	136						
						0 986 134 260		
						0 986 134 320		57
						0 986 473 114		59,95
						0 986 135 260		
						0 986 135 320		57
						0 986 474 114		59,95
				305		0 986 473 114		59,95
						0 986 474 114		59,95
2.4 T	08.03-07.06	132-162				0 986 134 260		
						0 986 135 260		
2.4 T AWD	08.03-07.06	162				0 986 134 260		
						0 986 135 260		
2.4 T	11.00-07.03	147				0 986 134 260		
2.4 T AWD						0 986 134 320		57
						0 986 473 114		59,95
						0 986 135 260		
						0 986 135 320		57
						0 986 474 114		59,95
				305		0 986 473 114		59,95
						0 986 474 114		59,95
2.4 T5	04.04-07.09	191				0 986 134 260		
						0 986 134 320		57
						0 986 473 114		59,95
						0 986 135 260		
						0 986 135 320		57
						0 986 474 114		59,95
				305		0 986 473 114		59,95
						0 986 474 114		59,95
2.5 T	04.04-07.09	154				0 986 134 260		
2.5 T AWD						0 986 134 320		57
						0 986 473 114		59,95
						0 986 135 260		
						0 986 135 320		57
						0 986 474 114		59,95
				305		0 986 473 114		59,95
						0 986 474 114		59,95
								
	2.0 T	11.00-07.09	132			0 986 473 113		41,95
						0 986 474 113		41,95
	2.3 T5	11.00-03.04	147-195			0 986 473 113		41,95
						0 986 474 113		41,95
	2.4	11.00-07.09	103			0 986 473 113		41,95
						0 986 474 113		41,95
			125			0 986 473 113		41,95
						0 986 474 113		41,95
		11.02-08.06	123			0 986 473 113		41,95
						0 986 474 113		41,95
	2.4 Bi-Fuel CNG	06.02-07.08	103			0 986 473 113		41,95
						0 986 474 113		41,95
	2.4 Bi-Fuel LPG	06.02-07.08	103			0 986 473 113		41,95
						0 986 474 113		41,95
	2.4 D	08.01-07.09	120			0 986 473 113		41,95
						0 986 474 113		41,95
		12.01-07.06	96			0 986 473 113		41,95
						0 986 474 113		41,95
		08.03-07.09	85/90/93			0 986 473 113		41,95
						0 986 474 113		41,95
	2.4 D5	08.03-07.09	132-162			0 986 473 113		41,95
	2.4 T					0 986 474 113		41,95
	2.4 T	11.00-07.03	147			0 986 473 113		41,95
						0 986 474 113		41,95



















		S							
	<b>◀ VOLVO S60 I</b>								
	2.4 T AWD	11.01-07.03	147				0986 473 113		41,95
							0986 474 113		41,95
	2.4 T AWD	08.03-07.09	162/191				0986 473 113		41,95
	2.4 T5						0986 474 113		41,95
	2.5 RAWD, T, T AWD	03.03-07.09	154/ 220-224				0986 473 113		41,95
							0986 474 113		41,95
	2.0 T	11.00-07.09	132				1 987 477 999		1923
	2.3 T5	11.00-03.04	147-195				1 987 477 999		1923
	2.4	11.00-07.09	103				1 987 477 999		1923
			123/125				1 987 477 999		1923
	2.4 D	08.01-07.09	120				1 987 477 999		1923
		12.01-07.06	96				1 987 477 999		1923
		08.03-07.05	85				1 987 477 999		1923
		08.05-07.09	90/93				1 987 477 999		1923
	2.4 D5	08.05-07.09	136				1 987 477 999		1923
	2.4 T	11.00-07.03	147				1 987 477 999		1923
		08.03-07.04	132-162				1 987 477 999		1923
	2.4 T5	04.04-07.09	191				1 987 477 999		1923
	2.5 T	04.04-07.09	154				1 987 477 999		1923
<b>S60 II</b>									
	1.6 Drive, T3, T4, T4F	11.10→	85/110/ 132				0986 134 047		60
							0986 135 047		60
	2.0 D3, D4, T, T4, T5	08.10→	100/120/132/ 149/157/177				0986 134 047		60
							0986 135 047		60
	2.4 D5	08.10→	151/158				0986 134 047		60
	2.4 D5 AWD						0986 135 047		60
	2.5 T5	08.11→	187				0986 134 047		60
							0986 135 047		60
	3.0 T6 AWD	08.10→	224				0986 134 047		60
							0986 135 047		60
<b>S70</b>									
	R2.3 T	01.97-07.98	177-184				0986 474 877		57
	R2.3 T AWD						0986 474 878		57
	2.0, T, T AWD, T 20V	01.97-07.00	93/105/120/ 132/155/166				0986 474 877		57
							0986 474 878		57
	2.3	01.97-07.00	160/				0986 474 877		57
	2.3 T-5		176-177				0986 474 878		57
	2.4	01.99-07.00	103/125/				0986 474 877		57
	2.4 AWD		142				0986 474 878		57
	2.5, Bifuel, T, T AWD, TDI, 20V	01.97-07.00	103/106/ 121/142				0986 474 877		57
							0986 474 878		57
	R2.3 T	01.97-07.98	177-184	Fg.-Nr. →511811 FC1, →508094 FC2			0986 474 885		38
							0986 474 886		38
	R2.3 T AWD	01.97-07.98	184				0986 473 189		
							0986 474 189		
	2.0	01.97-07.00	93/105/ 120/132/	Fg.-Nr. →511811 FC1, →508094 FC2			0986 474 885		38
	2.0 T		155				0986 474 886		38
	2.0 T 20V								
	2.0 T	08.98-07.00	166	Fg.-Nr. →511811 FC1, →508094 FC2			0986 474 885		38
							0986 474 886		38
	2.0 T AWD	08.98-07.99	166				0986 473 189		
							0986 474 189		

		S							
2.0 T AWD		08.99-07.00	166				0 986 134 067		← 40
							0 986 135 067		→ 40
2.3		01.97-07.00	160/	Fg.-Nr. →511811 FC1, →508094 FC2			0 986 474 885		← 38
2.3 T-5			176-177				0 986 474 886		→ 38
2.4		08.99-07.00	103	Fg.-Nr. →511811 FC1, →508094 FC2			0 986 474 885		← 38
			125	Fg.-Nr. →511811 FC1, →508094 FC2			0 986 474 886		→ 38
							0 986 474 885		← 38
							0 986 474 886		→ 38
2.4		01.99-07.00	142	Fg.-Nr. →511811 FC1, →508094 FC2			0 986 474 885		← 38
2.4 AWD							0 986 474 886		→ 38
2.4 AWD		08.99-07.00	125				0 986 134 067		← 40
							0 986 135 067		→ 40
2.5, Bifuel, TDI, 20V		01.97-07.00	103/106/121	Fg.-Nr. →511811 FC1, →508094 FC2			0 986 474 885		← 38
							0 986 474 886		→ 38
2.5 T		01.97-07.99	142	Fg.-Nr. →511811 FC1, →508094 FC2			0 986 474 885		← 38
							0 986 474 886		→ 38
2.5 T AWD		08.98-07.99	142				0 986 473 189		↔
							0 986 474 189		↔
	R 2.3 T	01.97-07.98	177-184				1 987 477 357		↔ 1670
	R 2.3 T AWD	01.97-07.98	184				1 987 482 105		↔ 2165
	2.0	01.97-07.99	93/105/120/132/155				1 987 477 357		↔ 1670
	2.0 T	01.97-07.98	93/105/120/132/155				1 987 477 357		↔ 1670
		08.98-07.00	166				1 987 477 357		↔ 1670
	2.0 T AWD	08.98-07.00	166				1 987 482 105		↔ 2165
	2.0 T 20V	08.98-07.00	93/105/120/132/155				1 987 477 357		↔ 1670
	2.3	01.97-07.98	160/176-177				1 987 477 357		↔ 1670
	2.3 T-5	01.97-07.00	160/176-177				1 987 477 357		↔ 1670
	2.4	01.99-07.00	142				1 987 477 357		↔ 1670
		08.99-07.00	103				1 987 477 357		↔ 1670
			125				1 987 477 357		↔ 1670
	2.4 AWD	01.99-07.00	142				1 987 477 357		↔ 1670
		08.99-07.00	125				1 987 482 105		↔ 2165
	2.5	01.97-07.99	103/106/121				1 987 477 357		↔ 1670
	2.5 Bifuel	08.98-07.00	103/106/121				1 987 477 357		↔ 1670
	2.5 T	01.97-07.99	142				1 987 477 357		↔ 1670
	2.5 T AWD	08.98-07.99	142				1 987 482 105		↔ 2165
	2.5 TDI	01.97-07.00	103/106/121				1 987 477 357		↔ 1670
	2.5 20V	01.97-07.99	103/106/121				1 987 477 357		↔ 1670
<b>S80 I</b>									
	2.0 T	08.98-07.06	120/132/				0 986 134 320		← 57
	2.0 T5		165/166				0 986 473 114		← 59,95
							0 986 135 320		→ 57
							0 986 474 114		→ 59,95
					305		0 986 473 114		← 59,95
							0 986 474 114		→ 59,95
	2.3 R	04.00-07.05	147-195				0 986 134 320		← 57
							0 986 473 114		← 59,95
							0 986 135 320		→ 57
							0 986 474 114		→ 59,95
					305		0 986 473 114		← 59,95
							0 986 474 114		→ 59,95
	2.4, Bi-Fuel LPG, D, D5, T, T AWD, T4 Bi-Fuel CNG	08.98-07.06	96/103/120/125/132-162				0 986 134 320		← 57
							0 986 473 114		← 59,95
							0 986 135 320		→ 57
							0 986 474 114		→ 59,95
					305		0 986 473 114		← 59,95
							0 986 474 114		→ 59,95



		S							
	VOLVO S80 I								
2.5	08.03-07.06	154			305	0986 473 114		59,95	
						0986 474 114		59,95	
2.5	08.03-07.06	154				0986 134 320		57	
2.5 AWD						0986 135 320		57	
2.5 AWD	08.03-07.06	154				0986 473 114		59,95	
						0986 474 114		59,95	
					305	0986 473 114		59,95	
						0986 474 114		59,95	
2.5 TDI	08.98-07.01	103				0986 134 320		57	
						0986 473 114		59,95	
						0986 135 320		57	
						0986 474 114		59,95	
					305	0986 473 114		59,95	
						0986 474 114		59,95	
2.8 T6	05.98-07.01	200				0986 134 320		57	
						0986 135 320		57	
					305	0986 473 114		59,95	
						0986 474 114		59,95	
2.9	06.98-07.01	147/150				0986 134 320		57	
						0986 473 114		59,95	
						0986 135 320		57	
						0986 474 114		59,95	
					305	0986 473 114		59,95	
						0986 474 114		59,95	
3.0	08.01-07.06	144				0986 134 320		57	
						0986 473 114		59,95	
						0986 135 320		57	
						0986 474 114		59,95	
					305	0986 473 114		59,95	
						0986 474 114		59,95	
3.0 T6	08.01-07.06	200				0986 134 320		57	
						0986 135 320		57	
					305	0986 473 114		59,95	
						0986 474 114		59,95	
2.0 T	08.98-07.06	120/132/				0986 473 113		41,95	
2.0 T5		165/166				0986 474 113		41,95	
2.3 R	04.00-07.05	147-195				0986 473 113		41,95	
						0986 474 113		41,95	
2.4, Bi-Fuel LPG, D, D5, T, T AWD, T4 Bi-Fuel CNG	08.98-07.06	96/103/120/125/132-162				0986 473 113		41,95	
						0986 474 113		41,95	
2.5	08.03-07.06	154				0986 473 113		41,95	
2.5 AWD						0986 474 113		41,95	
2.5 TDI	08.98-07.01	103				0986 473 113		41,95	
						0986 474 113		41,95	
2.8 T6	05.98-07.01	200				0986 473 113		41,95	
						0986 474 113		41,95	
2.9	06.98-07.01	147/150				0986 473 113		41,95	
						0986 474 113		41,95	
3.0	08.01-07.06	144/200				0986 473 113		41,95	
3.0 T6						0986 474 113		41,95	
2.0 T	08.98-07.06	120/132/165/166				1987 477 819		1993	
2.0 T5	08.98-07.00	120/132/165/166				1987 477 819		1993	
2.3 R	04.00-07.05	147-195				1987 477 819		1993	
2.4	08.98-07.06	96/103/120/125/132-162				1987 477 819		1993	
2.4 D	10.01-07.06	96/103/120/125/132-162				1987 477 819		1993	
2.4 D5	08.01-07.06	96/103/120/125/132-162				1987 477 819		1993	
2.4 T	08.00-07.06	96/103/120/125/132-162				1987 477 819		1993	
2.5	08.03-07.06	154				1987 477 819		1993	

		S							
2.5 TDI		08.98-07.01	103				1 987 477 819	↔	1993
2.8 T6		05.98-07.01	200				1 987 477 819	↔	1993
2.9		06.98-07.01	147/150				1 987 477 819	↔	1993
3.0		08.01-07.06	144/200				1 987 477 819	↔	1993
3.0 T6		08.01-07.06	144/200				1 987 477 819	↔	1993
<b>S80 II</b>									
									
	1.6 D DRIVe, DRIVe, T4, T4F	08.09→	80/84/132				0 986 134 047	↔	60
							0 986 135 047	↔	60
	2.0 B, D, D3, D4, TF Flexifuel, T5	08.07→	100/107/120/133/ 149/162/177/180				0 986 134 047	↔	60
							0 986 135 047	↔	60
	2.4 D, D5, D5 AWD	03.06→	120/129/136/ 151/158				0 986 134 047	↔	60
							0 986 135 047	↔	60
	2.5 FT Flexifuel, T	03.06-07.12	147/170				0 986 134 047	↔	60
	2.5 T	09.12→	183/187				0 986 134 047	↔	60
							0 986 135 047	↔	60
	3.0 T6 AWD	01.07-07.10	210				0 986 134 047	↔	60
							0 986 135 047	↔	60
	3.2	08.06→	175/179				0 986 134 047	↔	60
	3.2 AWD						0 986 135 047	↔	60
<b>S90</b>									
									
	2.5	11.96-12.99	120-132			GIR	0 986 473 800	↔	57
							0 986 473 801	↔	57
	2.9, Exekutive, Exekutive Plus	01.97-05.98	132/150			GIR	0 986 473 800	↔	57
							0 986 473 801	↔	57
<b>V40 Cross Country</b>									
									
	1.6 D2	01.13→	84/132				0 986 134 002	↔	57
	1.6 T4						0 986 473 385	↔	56,95
							0 986 135 002	↔	57
							0 986 474 385	↔	56,95
	2.0 D3, D4, T4, T4 AWD, T5, T5 AWD	01.13→	110/130/ 132/157/ 180				0 986 134 002	↔	57
							0 986 473 385	↔	56,95
							0 986 135 002	↔	57
							0 986 474 385	↔	56,95
	2.5 T5	01.13→	187				0 986 134 002	↔	57
	2.5 T5 AWD						0 986 473 385	↔	56,95
							0 986 135 002	↔	57
							0 986 474 385	↔	56,95
<b>V40 I</b>									
									
	1.6 16V	01.97-07.97	77				0 986 473 183	↔	53,96
							0 986 474 183	↔	53,96
		08.97-07.99	77				0 986 473 176	↔	53,93
							0 986 474 176	↔	54
		08.99-07.03	80				0 986 473 176	↔	53,93
							0 986 474 176	↔	54
	1.8 16V	01.95-07.97	85				0 986 473 183	↔	53,96
							0 986 474 183	↔	53,96
		08.97-07.99	85				0 986 473 176	↔	53,93
							0 986 474 176	↔	54
		08.97-07.03	90/92				0 986 473 176	↔	53,93
							0 986 474 176	↔	54







































































		S								
	<b>◀ VOLVO V40 I</b>									
1.9 D	01.96-07.97	66			0986 473 183		←	53,96		
					0986 474 183		→	53,96		
	08.97-07.99	66			0986 473 176		←	53,93		
					0986 474 176		→	54		
	08.98-07.03	70/75/85			0986 473 176		←	53,93		
					0986 474 176		→	54		
1.9 T4	05.97-07.97	147			0986 473 183		←	53,96		
					0986 474 183		→	53,96		
	08.97-07.00	147			0986 473 176		←	53,93		
					0986 474 176		→	54		
2.0	01.96-07.97	103			0986 473 183		←	53,96		
					0986 474 183		→	53,96		
	08.97-07.99	103			0986 473 176		←	53,93		
					0986 474 176		→	54		
2.0 T, T4 T, 16V T	04.98-07.03	118/120/ 121/147			0986 473 176		←	53,93		
					0986 474 176		→	54		
2.0 16V	08.99-07.03	100			0986 473 176		←	53,93		
					0986 474 176		→	54		
	1.6 16V	01.97-04.04	77/80	Fg.-Nr. →426760	0986 473 068		←	38	1987 470 0407	
					0986 474 068		→	38	1987 470 0407	
				Fg.-Nr. 426761→850976	0986 473 354		←	38,1	1987 470 0407	
					0986 474 354		→	38,1	1987 470 0407	
1.8 16V	01.95-06.04	85/90/92	Fg.-Nr. →426760		0986 473 068		←	38	1987 470 0407	
					0986 474 068		→	38	1987 470 0407	
			Fg.-Nr. 426761→850976		0986 473 354		←	38,1	1987 470 0407	
					0986 474 354		→	38,1	1987 470 0407	
1.9 D	01.96-04.04	66/70/75/ 85/147	Fg.-Nr. →426760		0986 473 068		←	38	1987 470 0407	
					0986 474 068		→	38	1987 470 0407	
1.9 T4			Fg.-Nr. 426761→850976		0986 473 354		←	38,1	1987 470 0407	
					0986 474 354		→	38,1	1987 470 0407	
2.0, T, T4 T, 16V, 16V T	01.96-04.04	100/103/ 118/120/ 121/147	Fg.-Nr. →426760		0986 473 068		←	38	1987 470 0407	
					0986 474 068		→	38	1987 470 0407	
			Fg.-Nr. 426761→850976		0986 473 354		←	38,1	1987 470 0407	
					0986 474 354		→	38,1	1987 470 0407	
	1.6 16V	01.97-07.99	77			1987 477 530		←	1590	
						1987 477 878		→	1590	
		08.99-07.00	80			1987 477 530		←	1590	
						1987 477 878		→	1590	
		08.00-04.04	80			1987 477 893		←	1620	
						1987 477 894		→	1620	
1.8 16V	01.95-07.99	85			1987 477 530		←	1590		
					1987 477 878		→	1590		
	08.97-07.00	92			1987 477 530		←	1590		
					1987 477 878		→	1590		
	04.99-07.00	90			1987 477 530		←	1590		
					1987 477 878		→	1590		
	08.00-06.04	90			1987 477 893		←	1620		
					1987 477 894		→	1620		
1.9 D	01.96-07.00	66/70			1987 477 530		←	1590		
					1987 477 878		→	1590		
	03.00-07.00	75/85			1987 477 530		←	1590		
					1987 477 878		→	1590		
	08.00-04.04	75/85			1987 477 893		←	1620		
					1987 477 894		→	1620		
1.9 T4	05.97-07.00	147			1987 477 530		←	1590		
					1987 477 878		→	1590		
2.0	01.96-07.00	103/118			1987 477 530		←	1590		
					1987 477 878		→	1590		
2.0 16V T					1987 477 878		→	1590		

	S							
2.0T	08.00-04.04	120/121/				1 987 477 893	←	1620
2.0T4T		147				1 987 477 894	→	1620
2.0 16V	08.99-07.00	100				1 987 477 530	←	1590
						1 987 477 878	→	1590
	08.00-04.04	100				1 987 477 893	←	1620
						1 987 477 894	→	1620
1.6 16V	01.97-08.97	77			LAB	0 265 006 224 <sup>3</sup>		
					RAB	0 265 006 223 <sup>3</sup>		
	01.97-07.99	77				0 265 006 366 <sup>4</sup>		
	09.97-07.99	77				0 265 006 425 <sup>3</sup>		
	08.99-04.04	80				0 265 006 425 <sup>3</sup>		
					Fg.-Nr. →985261	0 265 006 366 <sup>4</sup>		
					Fg.-Nr. 985262→	0 265 006 698 <sup>4</sup>		
1.8 16V	01.95-07.99	85				0 265 006 366 <sup>4</sup>		
	09.95-08.97	85			LAB	0 265 006 224 <sup>3</sup>		
					RAB	0 265 006 223 <sup>3</sup>		
	08.97-06.04	90/92			Fg.-Nr. →985261	0 265 006 366 <sup>4</sup>		
					Fg.-Nr. 985262→	0 265 006 698 <sup>4</sup>		
	09.97-07.99	85				0 265 006 425 <sup>3</sup>		
	09.97-06.04	90/92				0 265 006 425 <sup>3</sup>		
1.9 D	01.96-08.97	66			LAB	0 265 006 224 <sup>3</sup>		
					RAB	0 265 006 223 <sup>3</sup>		
	01.96-07.99	66				0 265 006 366 <sup>4</sup>		
	09.97-07.99	66				0 265 006 425 <sup>3</sup>		
	08.98-04.04	70/75/85				0 265 006 425 <sup>3</sup>		
					Fg.-Nr. →985261	0 265 006 366 <sup>4</sup>		
					Fg.-Nr. 985262→	0 265 006 698 <sup>4</sup>		
1.9 T4	05.97-08.97	147			LAB	0 265 006 224 <sup>3</sup>		
					RAB	0 265 006 223 <sup>3</sup>		
	05.97-07.99	147				0 265 006 366 <sup>4</sup>		
	09.97-07.00	147				0 265 006 425 <sup>3</sup>		
	08.99-07.00	147			Fg.-Nr. →985261	0 265 006 366 <sup>4</sup>		
					Fg.-Nr. 985262→	0 265 006 698 <sup>4</sup>		
2.0	01.96-08.97	103			LAB	0 265 006 224 <sup>3</sup>		
					RAB	0 265 006 223 <sup>3</sup>		
	01.96-07.99	103				0 265 006 366 <sup>4</sup>		
	09.97-07.99	103				0 265 006 425 <sup>3</sup>		
2.0 T	08.00-04.04	120/121/				0 265 006 425 <sup>3</sup>		
2.0 T4T		147			Fg.-Nr. →985261	0 265 006 366 <sup>4</sup>		
					Fg.-Nr. 985262→	0 265 006 698 <sup>4</sup>		
2.0 16V	08.99-04.04	100				0 265 006 425 <sup>3</sup>		
					Fg.-Nr. →985261	0 265 006 366 <sup>4</sup>		
					Fg.-Nr. 985262→	0 265 006 698 <sup>4</sup>		
2.0 16VT	04.98-07.99	118				0 265 006 366 <sup>4</sup>		
	04.98-07.00	118				0 265 006 425 <sup>3</sup>		
	08.99-07.00	118			Fg.-Nr. 985262→	0 265 006 698 <sup>4</sup>		
<b>V40 II</b>								
D4	09.14→	140				0 986 134 002		← 57
						0 986 135 002		→ 57
					278	0 986 473 385		← 56,95
						0 986 474 385		→ 56,95
T2	09.12→	88				0 986 134 002		← 57
						0 986 135 002		→ 57
					278	0 986 473 385		← 56,95
						0 986 474 385		→ 56,95
T5	09.14→	180				0 986 134 002		← 57
						0 986 135 002		→ 57
					278	0 986 473 385		← 56,95
						0 986 474 385		→ 56,95















































		S							
	<b>◀ VOLVO V40 II</b>								
1.6 D2		09.12→	84/110/				0986 134 002		← 57
1.6 T3			132				0986 135 002		→ 57
1.6 T4					278		0986 473 385		← 56,95
							0986 474 385		→ 56,95
2.0 D3		09.12→	110/130/				0986 134 002		← 57
2.0 D4			132/157				0986 135 002		→ 57
2.0 T4					278		0986 473 385		← 56,95
2.0 T5							0986 474 385		→ 56,95
2.5 T5		09.13-08.14	187				0986 134 002		← 57
							0986 135 002		→ 57
					278		0986 473 385		← 56,95
							0986 474 385		→ 56,95
<b>V50 [P12]</b>									
	1.6	11.04-12.12	74/80-81/				0986 134 002		← 57
	1.6 D DRiVe		84				0986 135 002		→ 57
	1.6 D2 DRiVe				278		0986 473 385		← 56,95
							0986 474 385		→ 56,95
	1.8	04.04-07.10	92				0986 134 002		← 57
	1.8 F Flexifuel						0986 135 002		→ 57
					278		0986 473 385		← 56,95
							0986 474 385		→ 56,95
	2.0, D, D3, D4, F Flexifuel	04.04-12.12	96/100/ 107/110/ 130				0986 134 002		← 57
							0986 135 002		→ 57
					278		0986 473 385		← 56,95
							0986 474 385		→ 56,95
	2.4	04.04-07.10	103/120/				0986 134 002		← 57
	2.4 D5		125-125/				0986 135 002		→ 57
	2.4 i		132		278		0986 473 385		← 56,95
							0986 474 385		→ 56,95
	2.5 T5	04.04-12.12	162/169				0986 134 002		← 57
	2.5 T5 AWD						0986 135 002		→ 57
					278		0986 473 385		← 56,95
							0986 474 385		→ 56,95
	1.6	11.04-12.12	74/80-81/				1987 482 188		337
	1.6 D DRiVe		84			Fg.-Nr. →194407	1987 477 202		1876
	1.6 D2 DRiVe					Fg.-Nr. 194408→	1987 482 019		1816
	1.8	04.04-07.10	92				1987 482 188		337
	1.8 F Flexifuel					Fg.-Nr. →194407	1987 477 202		1876
						Fg.-Nr. 194408→	1987 482 019		1816
	2.0, D, D3, D4, F Flexifuel	04.04-12.12	96/100/ 107/110/ 130				1987 482 188		337
						Fg.-Nr. →194407	1987 477 202		1876
						Fg.-Nr. 194408→	1987 482 019		1816
	2.4	04.04-07.10	103/120/				1987 482 188		337
	2.4 D5		125-125/			Fg.-Nr. →194407	1987 477 202		1876
	2.4 i		132			Fg.-Nr. 194408→	1987 482 019		1816
	2.5 T5	04.04-12.12	162/169				1987 482 188		337
	2.5 T5 AWD					Fg.-Nr. →194407	1987 477 202		1876
						Fg.-Nr. 194408→	1987 482 019		1816
	2.5 T5 AWD	04.04-08.10	162/169				0986 594 569 <sup>4</sup>		
<b>V60</b>									
	1.6 D2 DRiVe, T3, T4, T4F	09.10→	85/110/ 132				0986 134 047		← 60
							0986 135 047		→ 60

								
2.0 D3, D4, T, T5, T6	09.10→	100/120/132/133/149/ 157/161/177/180/225				0 986 134 047	 ← 60	
						0 986 135 047	 → 60	
2.4 D4 AWD, D5, D5 AWD	09.10→	120/133/ 151/158				0 986 134 047	 ← 60	
						0 986 135 047	 → 60	
2.5 D4 AWD	09.13→	133				0 986 134 047	 ← 60	
						0 986 135 047	 → 60	
3.0 T6 AWD	09.10→	224/242				0 986 134 047	 ← 60	
						0 986 135 047	 → 60	
<b>V70 I</b>								
								
 2.0, AWD Turbo, T 20V, Turbo	01.97-03.00	93/105/120/132/ 155/166				0 986 474 877	 ← 57	
						0 986 474 878	 → 57	
2.3, AWD, T-5, T-5 AWD	01.97-03.00	160/174-176/ 184-195				0 986 474 877	 ← 57	
						0 986 474 878	 → 57	
2.4	03.99-03.00	103/125/				0 986 474 877	 ← 57	
2.4 XC AWD		142				0 986 474 878	 → 57	
2.5, AWD, BI-FUEL, T, T AWD, T XC T XC AWD, TDI, 20V	01.97-03.00	103/106/121/ 142/195				0 986 474 877	 ← 57	
						0 986 474 878	 → 57	
								
 2.0, T 20V, Turbo	01.97-03.00	93/105/120/ 132/155				0 986 474 885	 ← 38	
						0 986 474 886	 → 38	
2.0 AWD Turbo	01.97-07.99	166				0 986 473 189	 ↔	
						0 986 474 189	 ↔	
2.0 Turbo	01.97-07.99	166				0 986 474 885	 ← 38	
						0 986 474 886	 → 38	
2.3	01.97-07.98	160				0 986 474 885	 ← 38	
						0 986 474 886	 → 38	
2.3 AWD	12.98-07.99	184-195				0 986 473 189	 ↔	
	08.99-03.00	184-195				0 986 474 189	 ↔	
						0 986 134 067	 ← 40	
						0 986 135 067	 → 40	
2.3 R	01.97-07.98	184				0 986 473 189	 ←	
						0 986 474 189	 ←	
						0 986 474 885	 ← 38	
						0 986 473 189	 →	
						0 986 474 189	 →	
						0 986 474 886	 ↔ 38	
2.3 R AWD	08.97-07.98	184				0 986 473 189	 ↔	
						0 986 474 189	 ↔	
2.3 T-5	01.97-03.00	176				0 986 474 885	 ← 38	
						0 986 474 886	 → 38	
2.3 T-5 AWD	01.97-07.99	174-176				0 986 473 189	 ↔	
	08.99-03.00	174-176				0 986 474 189	 ↔	
						0 986 134 067	 ← 40	
						0 986 135 067	 → 40	
2.4	05.99-03.00	103/125				0 986 474 885	 ← 38	
						0 986 474 886	 → 38	
2.4 XC AWD	03.99-07.99	142				0 986 473 189	 ↔	
						0 986 474 189	 ↔	
2.5, BI-FUEL, TDI, 20V	01.97-03.00	103/106/ 121				0 986 474 885	 ← 38	
						0 986 474 886	 → 38	
2.5 AWD	03.99-07.99	195				0 986 473 189	 ↔	
						0 986 474 189	 ↔	
2.5 T	01.97-03.00	142				0 986 474 885	 ← 38	
	03.99-07.99	142				0 986 474 886	 → 38	
						0 986 473 189	 ↔	
						0 986 474 189	 ↔	
2.5 T AWD	01.97-03.00	142				0 986 473 189	 ↔	
						0 986 474 189	↔	































































								
<b>VOLVO V70 I</b>								
	2.5 TXC	01.97-07.99	142			0986 473 189	 ↔	
						0986 474 189	 ↔	
	2.5 TXC AWD	01.97-07.99	142			0986 473 189	 ↔	
						0986 474 189	 ↔	
	2.5 TXC	08.99-03.00	142			0986 134 067	 ← 40	
	2.5 TXC AWD					0986 135 067	 → 40	
								
	2.0	01.97-03.00	93/105/120/132/155/166			1987 477 357	↔ 1670	
	2.0 T 20V	08.98-03.00	93/105/120/132/155/166			1987 477 357	↔ 1670	
	2.0 Turbo	01.97-03.00	93/105/120/132/155/166			1987 477 357	↔ 1670	
	2.3	01.97-07.98	160			1987 477 357	↔ 1670	
	2.3 AWD	12.98-03.00	184-195			1987 477 357	↔ 1670	
						1987 482 105	↔ 2165	
	2.3 R	01.97-07.98	184			1987 477 357	↔ 1670	
	2.3 RAWD	08.97-07.98	184			1987 482 105	↔ 2165	
	2.3 T-5	01.97-03.00	176			1987 477 357	↔ 1670	
	2.3 T-5 AWD	01.97-03.00	174-176			1987 477 357	↔ 1670	
						1987 482 105	↔ 2165	
	2.4	05.99-03.00	103/125			1987 477 357	↔ 1670	
	2.4 XC AWD	03.99-03.00	142			1987 482 105	↔ 2165	
	2.5	01.97-03.00	103/106/121			1987 477 357	↔ 1670	
	2.5 AWD	03.99-03.00	195			1987 482 105	↔ 2165	
	2.5 BI-FUEL	08.97-03.00	103/106/121			1987 477 357	↔ 1670	
	2.5 T	01.97-03.00	142			1987 477 357	↔ 1670	
		03.99-03.00	142			1987 482 105	↔ 2165	
	2.5 T AWD	01.97-03.00	142			1987 482 105	↔ 2165	
	2.5 T XC	01.97-03.00	142			1987 482 105	↔ 2165	
	2.5 T XC AWD	01.97-03.00	142			1987 482 105	↔ 2165	
	2.5 TDI	01.97-03.00	103/106/121			1987 477 357	↔ 1670	
	2.5 20V	01.97-03.00	103/106/121			1987 477 357	↔ 1670	
<b>V70 II</b>								
								
	2.0 T	03.00-07.07	132			0986 134 260	 ←	
						0986 134 320	 ← 57	
						0986 473 114	 ← 59,95	
						0986 135 260	 →	
						0986 135 320	 → 57	
						0986 474 114	 → 59,95	
				305		0986 473 114	 ← 59,95	
						0986 474 114	 → 59,95	
	2.3	03.00-07.04	184/195			0986 134 260	 ←	
	2.3 T5					0986 134 320	 ← 57	
						0986 473 114	 ← 59,95	
						0986 135 260	 →	
						0986 135 320	 → 57	
						0986 474 114	 → 59,95	
				305		0986 473 114	 ← 59,95	
						0986 474 114	 → 59,95	
	2.4, D, D AWD, D5, D5 AWD, T, T AWD T5, XC AWD	03.00-07.07	90/93/96/ 103/120/ 125/136/ 147/191			0986 134 320	 ← 57	
						0986 473 114	 ← 59,95	
						0986 135 320	 → 57	
						0986 474 114	 → 59,95	
				305		0986 473 114	 ← 59,95	
						0986 474 114	 → 59,95	
	2.4, D, D AWD, D5, D5 AWD, T, T5	03.00-07.07	90/93/96/103/120/ 125/136/147/191			0986 134 260	 ←	
						0986 135 260	 →	

			S								
2.5 BI-FUEL CNG	09.01-07.07	103							0 986 134 260		←
2.5 BI-FUEL LPG									0 986 134 320		← 57
									0 986 473 114		← 59,95
									0 986 135 260		→
									0 986 135 320		→ 57
									0 986 474 114		→ 59,95
							305		0 986 473 114		← 59,95
									0 986 474 114		→ 59,95
2.5 D	03.00-07.01	103							0 986 134 260		←
									0 986 134 320		← 57
									0 986 473 114		← 59,95
									0 986 135 260		→
									0 986 135 320		→ 57
									0 986 474 114		→ 59,95
							305		0 986 473 114		← 59,95
									0 986 474 114		→ 59,95
2.5 T	08.02-07.07	154							0 986 134 260		←
2.5 T AWD									0 986 134 320		← 57
									0 986 473 114		← 59,95
									0 986 135 260		→
									0 986 135 320		→ 57
									0 986 474 114		→ 59,95
							305		0 986 473 114		← 59,95
									0 986 474 114		→ 59,95
<hr/>											
	2.0 T	03.00-07.07	132						0 986 473 113		← 41,95
									0 986 474 113		→ 41,95
	2.3	03.00-07.04	184/195						0 986 473 113		← 41,95
	2.3 T5								0 986 474 113		→ 41,95
	2.4, D, D AWD, D5, D5 AWD, T, T AWD	03.00-07.07	90/93/96/103/120/ T5, XC AWD						0 986 473 113		← 41,95
			125/136/147/191						0 986 474 113		→ 41,95
	2.5 BI-FUEL CNG	09.01-07.07	103						0 986 473 113		← 41,95
	2.5 BI-FUEL LPG								0 986 474 113		→ 41,95
	2.5 D	03.00-07.01	103						0 986 473 113		← 41,95
									0 986 474 113		→ 41,95
	2.5 T	08.02-07.07	154						0 986 473 113		← 41,95
	2.5 T AWD								0 986 474 113		→ 41,95
<hr/>											
	2.0 T	03.00-07.07	132						1 987 477 941		↔ 1962
									1 987 477 941		↔ 1962
	2.3	03.00-07.04	184/195						1 987 477 941		↔ 1962
	2.3 T5	03.00-07.04	184/195						1 987 477 941		↔ 1962
	2.4	03.00-07.07	103 125						1 987 477 941		↔ 1962
									1 987 477 941		↔ 1962
	2.4 D	08.01-07.07	120						1 987 477 941		↔ 1962
		12.01-07.06	96						1 987 477 941		↔ 1962
		08.06-07.07	90/93						1 987 477 941		↔ 1962
	2.4 D AWD	08.02-07.06	120						1 987 477 999		↔ 1923
	2.4 D5	12.05-07.07	136						1 987 477 941		↔ 1962
	2.4 D5 AWD	12.05-07.07	136						1 987 477 999		↔ 1923
	2.4 T	03.00-07.03	147						1 987 477 941		↔ 1962
	2.4 T AWD	09.00-07.03	147						1 987 477 941		↔ 1962
	2.4 T5	04.04-07.07	191						1 987 477 941		↔ 1962
	2.4 XC AWD	09.00-07.02	147						1 987 477 819		↔ 1993
	2.5 D	03.00-07.01	103						1 987 477 941		↔ 1962
	2.5 T	04.04-07.07	154						1 987 477 941		↔ 1962
	2.5 T AWD	08.02-07.07	154						1 987 477 999		↔ 1923
	2.5 T AWD R	03.03-07.07	220						1 987 477 999		↔ 1923









































◀ VOLVO									
<b>V70 III</b>									
	1.6 D DRIVe, T4, T4F	01.10→	80/84/132				0986 134 047		← 60
							0986 135 047		→ 60
	2.0 B, D, D3, D3/D4, D4, F Flexifuel, T, T5	10.07→	100/107/120/133/ 149/157/177				0986 134 047		← 60
							0986 135 047		→ 60
	2.4 D, D5, D5 AWD	08.07-07.11	120/129/ 132-136/151				0986 134 047		← 60
							0986 135 047		→ 60
	2.5 FT Flexifuel	08.07-07.12	147/170				0986 134 047		← 60
	2.5 T						0986 135 047		→ 60
	3.0 T6 AWD	08.07-07.10	210				0986 134 047		← 60
							0986 135 047		→ 60
	3.2	08.07→	175-175/				0986 134 047		← 60
	3.2 AWD		179				0986 135 047		→ 60
<b>V90</b>									
	2.9	01.97-07.98	132/150		GIR		0986 473 800		← 57
							0986 473 801		→ 57
<b>XC70 I</b>									
	2.3 T	08.02-07.04	140				0986 134 320		← 57
							0986 135 320		→ 57
	2.4 D	08.02-07.06	120				0986 134 320		← 57
							0986 135 320		→ 57
	2.4 D5	08.04-07.07	136/				0986 134 320		← 57
	2.4 T		147-147				0986 135 320		→ 57
		08.06-07.07	136/	305			0986 473 114		← 59,95
			147-147				0986 474 114		→ 59,95
	2.5 T	08.02-07.07	154				0986 134 320		← 57
							0986 135 320		→ 57
		08.06-07.07	154	305			0986 473 114		← 59,95
							0986 474 114		→ 59,95
	2.3 T	08.02-07.04	140				0986 473 113		← 41,95
							0986 474 113		→ 41,95
	2.4 D, D5, T	08.02-07.07	120/136/ 147-147				0986 473 113		← 41,95
							0986 474 113		→ 41,95
	2.5 T	08.02-07.07	154				0986 473 113		← 41,95
							0986 474 113		→ 41,95
	2.3 T	08.02-07.04	140				1987 477 819		↔ 1993
	2.4 D	08.02-07.06	120/136/147-147				1987 477 819		↔ 1993
	2.4 D5	12.05-07.07	120/136/147-147				1987 477 819		↔ 1993
	2.4 T	08.04-07.07	120/136/147-147				1987 477 819		↔ 1993
	2.5 T	08.02-07.07	154				1987 477 819		↔ 1993
<b>XC70 II</b>									
	2.0 D3 DRIVe, D4, T5	08.10→	120/133/ 180				0986 134 047		← 60
							0986 135 047		→ 60
	2.4 D AWD, D DRIVe, D3 AWD	08.07→	120/129/133/ 136/151/158				0986 134 047		← 60
	D4 AWD, D5 AWD						0986 135 047		→ 60



		S							
3.0 T6 AWD		08.08→	210/224				0 986 134 047		60
							0 986 135 047		60
3.2		08.07→	175/179				0 986 134 047		60
3.2 AWD							0 986 135 047		60
<b>XC90</b>									
									
 2.4 D5 AWD		01.03-07.15	120/136/ 147				0 986 134 260		
							0 986 135 260		
					336		0 986 134 037		60
							0 986 135 037		60
2.5 T AWD		10.02-07.16	154				0 986 134 260		
2.5 T5 AWD					336		0 986 135 260		
							0 986 134 037		60
							0 986 135 037		60
2.9 T6 AWD		01.03-07.06	200				0 986 134 260		
					336		0 986 135 260		
							0 986 134 037		60
							0 986 135 037		60
3.2 AWD		08.06-07.15	175/179				0 986 134 260		
					336		0 986 135 260		
							0 986 134 037		60
							0 986 135 037		60
									
 2.4 D5 AWD		01.03-07.15	120/136/ 147				0 986 473 437		44
							0 986 474 437		44
2.5 T AWD		10.02-07.16	154				0 986 473 437		44
2.5 T5 AWD							0 986 474 437		44
2.9 T6 AWD		01.03-07.06	200				0 986 473 437		44
							0 986 474 437		44
3.2 AWD		08.06-07.15	175/179				0 986 473 437		44
							0 986 474 437		44
									
 2.4 D5 AWD		01.03-07.15	120/136/ 147				1 987 477 248		2180
					MI		1 987 482 128		1985
2.5 T AWD		10.02-07.16	154				1 987 477 248		2180
2.5 T5 AWD							1 987 482 284		2160
					MI		1 987 482 128		1985
2.9 T6 AWD		01.03-07.06	200				1 987 477 248		2180
							1 987 482 284		2160
					MI		1 987 482 128		1985
3.2 AWD		08.06-07.15	175/179				1 987 477 248		2180
							1 987 482 284		2160
					MI		1 987 482 128		1985
<b>XC90 I</b>									
									
 2.4 D3 FWD		08.10-07.15	120				0 986 134 260		
							0 986 135 260		
					336		0 986 134 037		60
							0 986 135 037		60
2.5 T FWD		01.03-07.07	154				0 986 134 260		
					336		0 986 135 260		
							0 986 134 037		60
							0 986 135 037		60
3.2 FWD		08.06-07.15	175/179				0 986 134 260		
							0 986 135 260		





















		S								
	VOLVO XC90 I									
3.2 FWD		08.06-07.15	175/179		336		0986 134 037		← 60	
							0986 135 037		→ 60	
4.4 V8 AWD		03.05-12.10	232				0986 134 260		←	
							0986 135 260		→	
					336		0986 134 037		← 60	
							0986 135 037		→ 60	
2.4 D3 FWD		08.10-07.15	120				0986 473 437		← 44	
							0986 474 437		→ 44	
2.5 T FWD		01.03-07.07	154				0986 473 437		← 44	
							0986 474 437		→ 44	
3.2 FWD		08.06-07.15	175/179				0986 473 437		← 44	
							0986 474 437		→ 44	
4.4 V8 AWD		03.05-12.10	232				0986 473 437		← 44	
							0986 474 437		→ 44	
2.4 D3 FWD		08.10-07.15	120				1987 477 248		↔ 2180	
					MI		1987 482 128		1985	
2.5 T FWD		01.03-07.07	154				1987 477 248		→ 2180	
							1987 482 284		← 2160	
					MI		1987 482 128		1985	
3.2 FWD		08.06-07.15	175/179				1987 477 248		→ 2180	
							1987 482 284		← 2160	
					MI		1987 482 128		1985	
4.4 V8 AWD		03.05-12.10	232				1987 477 248		→ 2180	
							1987 482 284		← 2160	
					MI		1987 482 128		1985	
<b>440</b>										
1.6 i		09.88-07.96	61-69			INB	0986 473 141		← 53,95	
							0986 474 141		→ 53,95	
						Fg.-Nr. →6386	INB	0986 473 143		← 53,94 1987 470 287 <sup>7</sup>
								0986 474 143		→ 53,94 1987 470 287 <sup>7</sup>
						Fg.-Nr. 6387→	INB	0986 473 122		← 53,95 1987 470 287 <sup>7</sup>
								0986 474 122		→ 53,95 1987 470 287 <sup>7</sup>
		09.93-07.97	61			INB	0986 473 141		← 53,95	
							0986 474 141		→ 53,95	
						Fg.-Nr. 6387→	INB	0986 473 122		← 53,95 1987 470 287 <sup>7</sup>
								0986 474 122		→ 53,95 1987 470 287 <sup>7</sup>
1.7 i		09.88-07.94	78-80			INB	0986 473 141		← 53,95	
							0986 474 141		→ 53,95	
						Fg.-Nr. →6386	INB	0986 473 143		← 53,94 1987 470 287 <sup>7</sup>
								0986 474 143		→ 53,94 1987 470 287 <sup>7</sup>
						Fg.-Nr. 6387→	INB	0986 473 122		← 53,95 1987 470 287 <sup>7</sup>
								0986 474 122		→ 53,95 1987 470 287 <sup>7</sup>
1.8 i		09.91-07.97	66			INB	0986 473 141		← 53,95	
							0986 474 141		→ 53,95	
						Fg.-Nr. 6387→	INB	0986 473 122		← 53,95 1987 470 287 <sup>7</sup>
								0986 474 122		→ 53,95 1987 470 287 <sup>7</sup>
1.8 T		09.88-07.96	88			INB	0986 473 141		← 53,95	
							0986 474 141		→ 53,95	
						Fg.-Nr. →6386	INB	0986 473 143		← 53,94 1987 470 287 <sup>7</sup>
								0986 474 143		→ 53,94 1987 470 287 <sup>7</sup>
						Fg.-Nr. 6387→	INB	0986 473 122		← 53,95 1987 470 287 <sup>7</sup>
								0986 474 122		→ 53,95 1987 470 287 <sup>7</sup>
1.9 DT		09.93-07.97	66			INB	0986 473 141		← 53,95	
							0986 474 141		→ 53,95	

		S							
1.9DT		09.93-07.97	66	Fg.-Nr. 6387→	INB	0 986 473 122	 ← 53,95	1 987 470 287 <sup>7</sup>	
						0 986 474 122	 → 53,95	1 987 470 287 <sup>7</sup>	
2.0i		09.92-12.96	80		INB	0 986 473 141	 ← 53,95		
						0 986 474 141	 → 53,95		
				Fg.-Nr. 6387→	INB	0 986 473 122	 ← 53,95	1 987 470 287 <sup>7</sup>	
						0 986 474 122	 → 53,95	1 987 470 287 <sup>7</sup>	
									
	1.6i	09.88-07.97	61-69			0 986 475 732	← 20,6		
						0 986 475 733	→ 20,6		
	1.7i	09.88-07.94	78-80			0 986 475 732	← 20,6		
						0 986 475 733	→ 20,6		
	1.8i	09.88-07.97	66/88			0 986 475 732	← 20,6		
	1.8T					0 986 475 733	→ 20,6		
	1.9DT	09.93-07.97	66			0 986 475 732	← 20,6		
						0 986 475 733	→ 20,6		
	2.0i	09.92-12.96	80			0 986 475 732	← 20,6		
						0 986 475 733	→ 20,6		
	1.6i	09.88-07.97	61-69			0 986 474 853	 ← 33		
						0 986 474 854	 → 33		
	1.7i	09.88-07.94	78-80			0 986 474 853	 ← 33		
						0 986 474 854	 → 33		
	1.8i	09.88-07.97	66/88			0 986 474 853	 ← 33		
	1.8T					0 986 474 854	 → 33		
	1.9DT	09.93-07.97	66			0 986 474 853	 ← 33		
						0 986 474 854	 → 33		
	2.0i	09.92-12.96	80			0 986 474 853	 ← 33		
						0 986 474 854	 → 33		
									
	1.6i	09.88-07.97	61-69			1 987 477 353	↔ 1428		
				Fg.-Nr. →165500	TBR	1 987 477 354	↔ 1365		
				Fg.-Nr. 165501→	TBR	1 987 477 356	↔ 1338		
	1.7i	09.88-07.94	78-80			1 987 477 353	↔ 1428		
				Fg.-Nr. →165500	TBR	1 987 477 354	↔ 1365		
				Fg.-Nr. 165501→	TBR	1 987 477 356	↔ 1338		
	1.8i	09.91-07.97	66/88			1 987 477 353	↔ 1428		
				Fg.-Nr. →165500	TBR	1 987 477 354	↔ 1365		
				Fg.-Nr. 165501→	TBR	1 987 477 356	↔ 1338		
	1.8T	09.88-07.96	66/88			1 987 477 353	↔ 1428		
				Fg.-Nr. →165500	TBR	1 987 477 354	↔ 1365		
				Fg.-Nr. 165501→	TBR	1 987 477 356	↔ 1338		
	1.9DT	09.93-07.97	66			1 987 477 353	↔ 1428		
				Fg.-Nr. →165500	TBR	1 987 477 354	↔ 1365		
				Fg.-Nr. 165501→	TBR	1 987 477 356	↔ 1338		
	2.0i	09.92-12.96	80			1 987 477 353	↔ 1428		
				Fg.-Nr. →165500	TBR	1 987 477 354	↔ 1365		
				Fg.-Nr. 165501→	TBR	1 987 477 356	↔ 1338		
<b>460</b>									
									
	1.6i	03.90-07.97	61		INB	0 986 473 141	 ← 53,95		
						0 986 474 141	 → 53,95		
				Fg.-Nr. →6386	INB	0 986 473 143	 ← 53,94	1 987 470 287 <sup>7</sup>	
						0 986 474 143	 → 53,94	1 987 470 287 <sup>7</sup>	
				Fg.-Nr. 6387→	INB	0 986 473 122	 ← 53,95	1 987 470 287 <sup>7</sup>	
						0 986 474 122	 → 53,95	1 987 470 287 <sup>7</sup>	
	1.7, i, iT	03.90-07.97	66/78/88		INB	0 986 473 141	 ← 53,95		
						0 986 474 141	 → 53,95		

















		S							
	<b>◀ VOLVO 460</b>								
	1.7, i, iT	03.90-07.97	66/78/88	Fg.-Nr. →6386	INB		0986 473 143	← 53,94	1987 470 287 <sup>7</sup>
							0986 474 143	→ 53,94	1987 470 287 <sup>7</sup>
				Fg.-Nr. 6387→	INB		0986 473 122	← 53,95	1987 470 287 <sup>7</sup>
							0986 474 122	→ 53,95	1987 470 287 <sup>7</sup>
	1.8 i	09.91-07.97	66		INB		0986 473 141	← 53,95	
							0986 474 141	→ 53,95	
				Fg.-Nr. →6386	INB		0986 473 143	← 53,94	1987 470 287 <sup>7</sup>
							0986 474 143	→ 53,94	1987 470 287 <sup>7</sup>
				Fg.-Nr. 6387→	INB		0986 473 122	← 53,95	1987 470 287 <sup>7</sup>
							0986 474 122	→ 53,95	1987 470 287 <sup>7</sup>
	1.9 D	09.93-07.97	66		INB		0986 473 141	← 53,95	
							0986 474 141	→ 53,95	
				Fg.-Nr. 6387→	INB		0986 473 122	← 53,95	1987 470 287 <sup>7</sup>
							0986 474 122	→ 53,95	1987 470 287 <sup>7</sup>
	2.0 i	09.92-12.96	80		INB		0986 473 141	← 53,95	
							0986 474 141	→ 53,95	
				Fg.-Nr. 6387→	INB		0986 473 122	← 53,95	1987 470 287 <sup>7</sup>
							0986 474 122	→ 53,95	1987 470 287 <sup>7</sup>
	1.6 i	03.90-07.97	61				0986 475 732	← 20,6	
							0986 475 733	→ 20,6	
	1.7, i, iT	03.90-07.97	66/78/88				0986 475 732	← 20,6	
							0986 475 733	→ 20,6	
	1.8 i	09.91-07.97	66				0986 475 732	← 20,6	
							0986 475 733	→ 20,6	
	1.9 D	09.93-07.97	66				0986 475 732	← 20,6	
							0986 475 733	→ 20,6	
	2.0 i	09.92-12.96	80				0986 475 732	← 20,6	
							0986 475 733	→ 20,6	
	1.6 i	03.90-07.97	61				0986 474 853	← 33	
							0986 474 854	→ 33	
	1.7, i, iT	03.90-07.97	66/78/88				0986 474 853	← 33	
							0986 474 854	→ 33	
	1.8 i	09.91-07.97	66				0986 474 853	← 33	
							0986 474 854	→ 33	
	1.9 D	09.93-07.97	66				0986 474 853	← 33	
							0986 474 854	→ 33	
	2.0 i	09.92-12.96	80				0986 474 853	← 33	
							0986 474 854	→ 33	
	1.6 i	03.90-07.97	61				1987 477 353	↔ 1428	
				Fg.-Nr. →165500	TBR		1987 477 354	↔ 1365	
				Fg.-Nr. 165501→	TBR		1987 477 356	↔ 1338	
	1.7	03.90-07.97	66/78/88				1987 477 353	↔ 1428	
				Fg.-Nr. →165500	TBR		1987 477 354	↔ 1365	
				Fg.-Nr. 165501→	TBR		1987 477 356	↔ 1338	
	1.7 i	03.90-07.97	66/78/88				1987 477 353	↔ 1428	
				Fg.-Nr. →165500	TBR		1987 477 354	↔ 1365	
				Fg.-Nr. 165501→	TBR		1987 477 356	↔ 1338	
	1.7 i T	03.90-07.96	66/78/88				1987 477 353	↔ 1428	
				Fg.-Nr. →165500	TBR		1987 477 354	↔ 1365	
				Fg.-Nr. 165501→	TBR		1987 477 356	↔ 1338	
	1.8 i	09.91-07.97	66				1987 477 353	↔ 1428	
				Fg.-Nr. →165500	TBR		1987 477 354	↔ 1365	
				Fg.-Nr. 165501→	TBR		1987 477 356	↔ 1338	
	1.9 D	09.93-07.97	66				1987 477 353	↔ 1428	
				Fg.-Nr. →165500	TBR		1987 477 354	↔ 1365	
				Fg.-Nr. 165501→	TBR		1987 477 356	↔ 1338	















		S							
2.0i		09.92-12.96	80				1 987 477 353	↔ 1428	
						Fg.-Nr. →165500	TBR	1 987 477 354	↔ 1365
						Fg.-Nr. 165501→	TBR	1 987 477 356	↔ 1338
<b>480</b>									
									
 1.7iT		08.88-07.95	88-90			INB	0 986 473 141	↔ 53,95	
							0 986 474 141	↔ 53,95	
						Fg.-Nr. →538519	INB	0 986 473 143	↔ 53,94 1 987 470 287 <sup>7</sup>
							0 986 474 143	↔ 53,94	1 987 470 287 <sup>7</sup>
						Fg.-Nr. 538520→	INB	0 986 473 122	↔ 53,95 1 987 470 287 <sup>7</sup>
							0 986 474 122	↔ 53,95	1 987 470 287 <sup>7</sup>
2.0i		09.92-12.96	81				0 986 473 122	↔ 53,95	1 987 470 287 <sup>7</sup>
						INB	0 986 474 122	↔ 53,95	1 987 470 287 <sup>7</sup>
							0 986 473 141	↔ 53,95	
							0 986 474 141	↔ 53,95	
									
 1.7iT		08.88-07.95	88-90				0 986 474 853	↔ 33	
							0 986 474 854	↔ 33	
2.0i		09.92-12.96	81				0 986 474 853	↔ 33	
							0 986 474 854	↔ 33	
									
 1.7iT		08.88-07.95	88-90				1 987 477 353	↔ 1428	
2.0i		09.92-12.96	81				1 987 477 353	↔ 1428	
<b>740</b>									
									
 2.0i		08.91-07.94	80-89			GIM	0 986 473 293	↔ 40	
							0 986 474 293	↔ 40	
						14Z,GIM	0 986 473 069	↔ 40,45	
							0 986 474 069	↔ 40,45	
						15Z,GIM	0 986 473 069	↔ 40,45	
							0 986 474 069	↔ 40,45	
		ABO 08.91-07.94	80-89			14Z BSY			0 204 104 041
						15Z BSY	0 986 474 762	↔ 40	0 204 104 041
							0 986 474 763	↔ 40	0 204 104 041
		ABS 08.91-07.94	80-89			14Z BSY	0 986 473 238	↔ 40	
							0 986 474 238	↔ 40	
						15Z BSY	0 986 473 238	↔ 40	
							0 986 474 238	↔ 40	
2.3i		08.88-07.95	83-85/94/ 96			GIM	0 986 473 293	↔ 40	
							0 986 474 293	↔ 40	
						14Z,GIM	0 986 473 069	↔ 40,45	
							0 986 474 069	↔ 40,45	
						15Z,GIM	0 986 473 069	↔ 40,45	
							0 986 474 069	↔ 40,45	
		ABO 08.88-07.95	83-85/94/ 96			14Z BSY			0 204 104 041
						15Z BSY	0 986 474 762	↔ 40	0 204 104 041
							0 986 474 763	↔ 40	0 204 104 041
		ABS 08.88-07.95	83-85/94/ 96			14Z BSY	0 986 473 238	↔ 40	
							0 986 474 238	↔ 40	
						15Z BSY	0 986 473 238	↔ 40	
							0 986 474 238	↔ 40	
									
 2.0i		08.91-07.94	80-89				0 986 473 468	↔ 40	
							0 986 474 468	↔ 40	



		S							
	VOLVO 740								
2.3 i		09.90-07.95	83-85/94				0986 473 468		← 40
							0986 474 468		→ 40
	2.0 i	08.91-07.94	80-89	Fg.-Nr. →169238	KOB		1987 477 347		↔ 830
							1987 482 127		2198
				Fg.-Nr. →283699	LIM		1987 477 347		↔ 830
							1987 482 127		2198
				Fg.-Nr. 283700→	LIM		1987 477 349		→ 902
							1987 477 879		← 2188
				Fg.-Nr. 169239→	KOB		1987 477 349		→ 902
							1987 477 879		← 2188
	2.3 i	08.88-07.95	83-85/94/ 96	Fg.-Nr. →169238	KOB		1987 477 347		↔ 830
							1987 482 127		2198
				Fg.-Nr. →283699	LIM		1987 477 347		↔ 830
							1987 482 127		2198
				Fg.-Nr. 283700→	LIM		1987 477 349		→ 902
							1987 477 879		← 2188
				Fg.-Nr. 169239→	KOB		1987 477 349		→ 902
							1987 477 879		← 2188
	2.0 i	08.91-07.94	80-89	Fg.-Nr. →176799	KOB		0265 001 184 <sup>3</sup>		
				Fg.-Nr. →294099	LIM		0265 001 184 <sup>3</sup>		
				Fg.-Nr. 176800→	KOB		0265 001 231 <sup>3</sup>		
				Fg.-Nr. 294100→	LIM		0265 001 231 <sup>3</sup>		
	2.3 i	08.88-07.95	83-85/94/ 96	Fg.-Nr. →176799	KOB		0265 001 184 <sup>3</sup>		
				Fg.-Nr. →294099	LIM		0265 001 184 <sup>3</sup>		
				Fg.-Nr. 176800→	KOB		0265 001 231 <sup>3</sup>		
				Fg.-Nr. 294100→	LIM		0265 001 231 <sup>3</sup>		
<b>V</b>	<b>850</b>								
	2.0, GLT, Turbo	09.91-07.97	93/105/ 129-132/155				0986 474 877		← 57
							0986 474 878		→ 57
	2.3	09.97-07.98	120				0986 474 877		← 57
							0986 474 878		→ 57
	2.3 R, Turbo, T-5, T-5R	09.93-07.97	155/ 166-184				0986 474 877		← 57
							0986 474 878		→ 57
	2.5 AWD, GLE, GLT, TDI, Turbo	09.91-07.97	103-106/125/ 140-142				0986 474 877		← 57
							0986 474 878		→ 57
	2.0, GLT, Turbo	09.91-07.97	93/105/ 129-132/155				0986 474 885		← 38
							0986 474 886		→ 38
	2.3	09.97-07.98	120				0986 474 885		← 38
							0986 474 886		→ 38
	2.3 R, Turbo, T-5, T-5R	09.93-07.97	155/ 166-184				0986 474 885		← 38
							0986 474 886		→ 38
	2.5 AWD	09.96-07.97	140				0986 473 189		↔
							0986 474 189		↔
	2.5 GLE, GLT, TDI	09.91-07.97	103-106/ 125				0986 474 885		← 38
							0986 474 886		→ 38
	2.5 Turbo	09.96-07.97	140				0986 474 885		← 38
							0986 474 886		→ 38
			140-142				0986 474 885		← 38
							0986 474 886		→ 38

		S								
										
	<b>2.0</b>	09.91-12.96	93/105/ 129-132/ 155	Fg.-Nr. →47065 Fg.-Nr. 47066→			1 987 477 358	↔ 1607		
							1 987 477 357	↔ 1670		
	<b>2.0 GLT</b>	01.96-07.97	93/105/ 129-132/ 155	Fg.-Nr. →47065 Fg.-Nr. 47066→			1 987 477 358	↔ 1607		
							1 987 477 357	↔ 1670		
	<b>2.0 Turbo</b>	01.95-07.97	93/105/ 129-132/ 155	Fg.-Nr. →47065 Fg.-Nr. 47066→			1 987 477 358	↔ 1607		
							1 987 477 357	↔ 1670		
	<b>2.3</b>	09.97-07.98	120	Fg.-Nr. →47065 Fg.-Nr. 47066→			1 987 477 358	↔ 1607		
							1 987 477 357	↔ 1670		
	<b>2.3 R</b>	08.95-07.97	155/ 166-184	Fg.-Nr. →47065 Fg.-Nr. 47066→			1 987 477 358	↔ 1607		
							1 987 477 357	↔ 1670		
	<b>2.3 Turbo</b>	09.94-07.95	155/ 166-184	Fg.-Nr. →47065 Fg.-Nr. 47066→			1 987 477 358	↔ 1607		
							1 987 477 357	↔ 1670		
	<b>2.3 T-5</b>	09.93-07.97	155/ 166-184	Fg.-Nr. →47065 Fg.-Nr. 47066→			1 987 477 358	↔ 1607		
							1 987 477 357	↔ 1670		
<b>2.3 T-5R</b>	09.94-07.97	155/ 166-184	Fg.-Nr. →47065 Fg.-Nr. 47066→			1 987 477 358	↔ 1607			
						1 987 477 357	↔ 1670			
<b>2.5 GLE</b>	09.92-07.97	103-106/ 125/ 140-142	Fg.-Nr. →47065 Fg.-Nr. 47066→			1 987 477 358	↔ 1607			
						1 987 477 357	↔ 1670			
<b>2.5 GLT</b>	09.91-07.97	103-106/ 125/ 140-142	Fg.-Nr. →47065 Fg.-Nr. 47066→			1 987 477 358	↔ 1607			
						1 987 477 357	↔ 1670			
<b>2.5 TDI</b>	05.96-07.97	103-106/ 125/ 140-142	Fg.-Nr. →47065 Fg.-Nr. 47066→			1 987 477 358	↔ 1607			
						1 987 477 357	↔ 1670			
<b>2.5 Turbo</b>	09.96-07.97	103-106/ 125/ 140-142	Fg.-Nr. →47065 Fg.-Nr. 47066→			1 987 477 358	↔ 1607			
						1 987 477 357	↔ 1670			
<b>850 Kombi</b>										
										
	<b>2.0, GLT, Turbo</b>	03.92-07.97	93/105/ 129-132/155				0 986 474 877	↔ 57		
							0 986 474 878	↔ 57		
	<b>2.3</b>	09.97-07.98	120				0 986 474 877	↔ 57		
							0 986 474 878	↔ 57		
	<b>2.3 R, T-5, T-5R</b>	09.93-07.97	155/160/166/ 176-184				0 986 474 877	↔ 57		
							0 986 474 878	↔ 57		
	<b>2.5 AWD, GLE, GLT, TDI, Turbo</b>	09.91-07.97	103-106/125/ 140-142				0 986 474 877	↔ 57		
							0 986 474 878	↔ 57		
										
		<b>2.0, GLT, Turbo</b>	03.92-07.97	93/105/ 129-132/155				0 986 474 885	↔ 38	
							0 986 474 886	↔ 38		
<b>2.3</b>		09.97-07.98	120				0 986 474 885	↔ 38		
							0 986 474 886	↔ 38		
<b>2.3 R, T-5, T-5R</b>		09.93-07.97	155/160/166/ 176-184				0 986 474 885	↔ 38		
							0 986 474 886	↔ 38		
<b>2.5 AWD</b>		09.96-07.97	140				0 986 473 189	↔		
							0 986 474 189	↔		
<b>2.5 GLE, GLT, TDI</b>		09.91-07.97	103-106/ 125				0 986 474 885	↔ 38		
							0 986 474 886	↔ 38		
<b>2.5 Turbo</b>	09.96-07.97	140-142				0 986 474 885	↔ 38			
						0 986 474 886	↔ 38			

		S							
◀ VOLVO 850 Kombi									
	2.0	03.92-12.96	93/105/ 129-132/ 155	Fg.-Nr. →47065 Fg.-Nr. 47066→		1987 <b>477 358</b>	↔ 1607		
						1987 <b>477 357</b>	↔ 1670		
	2.0 GLT	01.96-07.97	93/105/ 129-132/ 155	Fg.-Nr. →47065 Fg.-Nr. 47066→		1987 <b>477 358</b>	↔ 1607		
						1987 <b>477 357</b>	↔ 1670		
	2.0 Turbo	01.95-07.97	93/105/ 129-132/ 155	Fg.-Nr. →47065 Fg.-Nr. 47066→		1987 <b>477 358</b>	↔ 1607		
						1987 <b>477 357</b>	↔ 1670		
	2.3	09.97-07.98	120	Fg.-Nr. →47065 Fg.-Nr. 47066→		1987 <b>477 358</b>	↔ 1607		
						1987 <b>477 357</b>	↔ 1670		
	2.3 R	08.95-07.97	155/160/ 166/ 176-184	Fg.-Nr. →47065 Fg.-Nr. 47066→		1987 <b>477 358</b>	↔ 1607		
						1987 <b>477 357</b>	↔ 1670		
	2.3 T-5	09.93-07.97	155/160/ 166/ 176-184	Fg.-Nr. →47065 Fg.-Nr. 47066→		1987 <b>477 358</b>	↔ 1607		
						1987 <b>477 357</b>	↔ 1670		
	2.3 T-5R	09.94-07.97	155/160/ 166/ 176-184	Fg.-Nr. →47065 Fg.-Nr. 47066→		1987 <b>477 358</b>	↔ 1607		
						1987 <b>477 357</b>	↔ 1670		
	2.5 GLE	09.92-07.97	103-106/ 125/ 140-142	Fg.-Nr. →47065 Fg.-Nr. 47066→		1987 <b>477 358</b>	↔ 1607		
					1987 <b>477 357</b>	↔ 1670			
2.5 GLT	09.91-07.97	103-106/ 125/ 140-142	Fg.-Nr. →47065 Fg.-Nr. 47066→		1987 <b>477 358</b>	↔ 1607			
					1987 <b>477 357</b>	↔ 1670			
2.5 TDI	05.96-07.97	103-106/ 125/ 140-142	Fg.-Nr. →47065 Fg.-Nr. 47066→		1987 <b>477 358</b>	↔ 1607			
					1987 <b>477 357</b>	↔ 1670			
2.5 Turbo	09.96-07.97	103-106/ 125/ 140-142	Fg.-Nr. →47065 Fg.-Nr. 47066→		1987 <b>477 358</b>	↔ 1607			
					1987 <b>477 357</b>	↔ 1670			
<b>940</b>									
	2.0	09.91-09.98	80-89/114		BSY	0986 <b>474 762</b>	← 40	0 204 <b>104 041</b>	
	2.0 Turbo					0986 <b>474 763</b>	→ 40	0 204 <b>104 041</b>	
	2.0 Turbo Interc.				GIR	0986 <b>473 800</b>	← 57		
						0986 <b>473 801</b>	→ 57		
	2.3	09.90-10.98	84/96-99/104/ 113-151		BSY	0986 <b>474 762</b>	← 40	0 204 <b>104 041</b>	
	2.3 Turbo					0986 <b>474 763</b>	→ 40	0 204 <b>104 041</b>	
	2.3 Turbo Interc.	08.91-10.98	84/96-99/104/ 113-151		GIR	0986 <b>473 800</b>	← 57		
						0986 <b>473 801</b>	→ 57		
	2.4 TD	09.90-07.97	90		BSY	0986 <b>474 762</b>	← 40	0 204 <b>104 041</b>	
						0986 <b>474 763</b>	→ 40	0 204 <b>104 041</b>	
		08.91-07.97	90		GIR	0986 <b>473 800</b>	← 57		
						0986 <b>473 801</b>	→ 57		
	2.0, Turbo, Turbo Interc.	09.91-09.98	80-89/114			0986 <b>473 468</b>	← 40		
						0986 <b>474 468</b>	→ 40		
	2.3, Turbo, Turbo Interc.	09.91-10.98	84/96-99/104/ 113-151			0986 <b>473 468</b>	← 40		
						0986 <b>474 468</b>	→ 40		
	2.4 TD	09.91-07.97	90			0986 <b>473 468</b>	← 40		
						0986 <b>474 468</b>	→ 40		

		S								
										
	2.0, Turbo, Turbo Interc.	09.91-09.98	80-89/114				1 987 477 349	→ 902		
							1 987 477 879	← 2188		
	2.3, Turbo, Turbo Interc.	09.90-10.98	84/96-99/104/ 113-151				1 987 477 349	→ 902		
							1 987 477 879	← 2188		
	2.4 TD	09.90-07.97	90				1 987 477 349	→ 902		
							1 987 477 879	← 2188		
	2.0, Turbo, Turbo Interc.	09.91-09.98	80-89/114				0 265 001 231 <sup>3</sup>			
	2.3, Turbo, Turbo Interc.	09.90-10.98	84/96-99/104/113-151				0 265 001 231 <sup>3</sup>			
	2.4 TD	09.90-07.97	90				0 265 001 231 <sup>3</sup>			
<b>960</b>										
										
	2.0 T	09.91-07.94	103/140			BSY	0 986 474 762	↔ 40	0 204 104 041	
	2.0 T 16V						0 986 474 763	↔ 40	0 204 104 041	
							GIR	0 986 473 800	↔ 57	
							0 986 473 801	↔ 57		
	2.3 T	09.91-07.97	125			BSY	0 986 474 762	↔ 40	0 204 104 041	
							0 986 474 763	↔ 40	0 204 104 041	
						GIR	0 986 473 800	↔ 57		
							0 986 473 801	↔ 57		
	2.4	08.90-07.97	85/120			BSY	0 986 474 762	↔ 40	0 204 104 041	
	2.4 TD							0 986 474 763	↔ 40	0 204 104 041
			08.91-07.97	85/120			GIR	0 986 473 800	↔ 57	
							0 986 473 801	↔ 57		
2.5		09.94-07.97	125			BSY	0 986 474 762	↔ 40	0 204 104 041	
							0 986 474 763	↔ 40	0 204 104 041	
						GIR	0 986 473 800	↔ 57		
						0 986 473 801	↔ 57			
3.0		09.90-07.98	150			BSY	0 986 474 762	↔ 40	0 204 104 041	
							0 986 474 763	↔ 40	0 204 104 041	
		08.91-07.98	150			GIR	0 986 473 800	↔ 57		
						0 986 473 801	↔ 57			
										
	2.0 T	09.91-07.94	103/140			GIR	0 986 473 189	↔ ↔		
							0 986 474 189	↔ ↔		
	2.0 T 2.0 T 16V		09.91-07.94	103/140			ATE	0 986 473 145	↔ ← 39,94	
								0 986 473 239	↔ ← 38	
								0 986 474 145	↔ → 39,94	
								0 986 474 239	↔ → 38	
	2.0 T 16V	09.91-07.94	103/140			GIR	0 986 473 189	↔ ↔		
							0 986 474 189	↔ ↔		
	2.3 T		09.91-07.97	125			ATE	0 986 473 145	↔ ← 39,94	
								0 986 473 239	↔ ← 38	
								0 986 474 145	↔ → 39,94	
								0 986 474 239	↔ → 38	
						GIR	0 986 473 189	↔ ↔		
							0 986 474 189	↔ ↔		
	2.4	09.94-07.97	120				0 986 473 189	↔ ↔		
							0 986 474 189	↔ ↔		
	2.4 TD		08.90-07.97	85			ATE	0 986 473 145	↔ ← 39,94	
								0 986 473 239	↔ ← 38	
								0 986 474 145	↔ → 39,94	
								0 986 474 239	↔ → 38	
		09.91-07.97	85			GIR	0 986 473 189	↔ ↔		
						0 986 474 189	↔ ↔			



<b>VOLVO 960</b>								
2.5	09.94-07.97	125	ATE	0986 473 145		39,94		
				0986 473 239		38		
				0986 474 145		39,94		
				0986 474 239		38		
3.0	09.90-07.98	150	ATE	0986 473 145		39,94		
				0986 473 239		38		
3.0	09.91-07.98	150	GIR	0986 473 189				
				0986 474 189				
				0986 473 189				
				0986 474 189				

	<b>2.0 T, T 16V</b>	09.91-07.94	103/140			0265 001 231 <sup>3</sup>		
	2.3T	09.91-08.94	125			0265 001 231 <sup>3</sup>		
		09.94-07.97	125			0265 001 380 <sup>3</sup>		
	2.4	09.94-07.97	120			0265 001 380 <sup>3</sup>		
	2.4TD	08.90-08.94	85			0265 001 231 <sup>3</sup>		
		09.94-07.97	85			0265 001 380 <sup>3</sup>		
	2.5	09.94-07.97	125			0265 001 380 <sup>3</sup>		
3.0	09.90-08.94	150				0265 001 231 <sup>3</sup>		
			09.94-07.97	150			0265 001 380 <sup>3</sup>	

**VW (VOLKSWAGEN)**

**Amarok [2H, S1]**

	<b>2.0 BiTDI, BiTDI 4Motion</b>	09.10-05.12	120					0204 706 111 <sup>7</sup>
	2.0 TDI, TDI 4Motion	11.11-04.12	132					0204 706 111 <sup>7</sup>
		09.10-04.12	90/118					0204 706 111 <sup>7</sup>
	2.0 BiTDI, BiTDI 4Motion, TDI, TDI 4Motion, TSI	09.10→	90/103/118/ 120/132	LAB		0986 594 504 <sup>3</sup>		
				RAB		0986 594 505 <sup>3</sup>		































**Beetle Cabriolet [5C7]**

	<b>1.2 TSI</b>	01.13→	77	PR-Code 1LV, PR-Code 1ZB	312	0986 473 384		53,94	F 026 A06 106 <sup>7</sup>
						0986 473 384		53,94	1987 470 506 <sup>8</sup>
						0986 474 384		53,94	F 026 A06 106 <sup>7</sup>
						0986 473 384		53,94	F 026 A06 106 <sup>7</sup>
						0986 473 384		53,94	1987 470 506 <sup>8</sup>
						0986 474 384		53,94	F 026 A06 106 <sup>7</sup>
						0986 473 071		54	1987 470 506 <sup>8</sup>
						0986 474 071		54	1987 470 506 <sup>8</sup>
						0986 473 071		54	1987 470 506 <sup>8</sup>
1.4 TSI	01.13→	110/118	PR-Code 1LV, PR-Code 1ZB	312		0986 473 384		53,94	F 026 A06 106 <sup>7</sup>
						0986 473 384		53,94	1987 470 506 <sup>8</sup>
						0986 474 384		53,94	F 026 A06 106 <sup>7</sup>
						0986 473 384		53,94	F 026 A06 106 <sup>7</sup>
						0986 473 384		53,94	1987 470 506 <sup>8</sup>
						0986 474 384		53,94	F 026 A06 106 <sup>7</sup>
						0986 473 071		54	1987 470 506 <sup>8</sup>
						0986 474 071		54	1987 470 506 <sup>8</sup>
1.6 TDI	01.13→	77	PR-Code 1LV, PR-Code 1ZB	312		0986 473 384		53,94	F 026 A06 106 <sup>7</sup>
						0986 473 384		53,94	1987 470 506 <sup>8</sup>
						0986 474 384		53,94	F 026 A06 106 <sup>7</sup>
						0986 473 384		53,94	F 026 A06 106 <sup>7</sup>

	S									
	1.6 TDI	01.13→	77	PR-Code 1ZA, PR-Code 1ZE, PR-Code 1ZP	288,312	0 986 473 384		53,94	F 026 A06 106 <sup>7</sup>	
				0 986 473 384			53,94	1 987 470 506 <sup>8</sup>		
				0 986 474 384			53,94	F 026 A06 106 <sup>7</sup>		
				PR-Code 1ZP, PR-Code 1ZM		228	0 986 473 071		54	1 987 470 506 <sup>8</sup>
				0 986 474 071				54	1 987 470 506 <sup>8</sup>	
				2.0 TDI			01.13→	81/103/ 110/147/ 155/162	PR-Code 1LV, PR-Code 1ZB	312
2.0 TSI	0 986 473 384		53,94	1 987 470 506 <sup>8</sup>						
0 986 474 384		53,94	F 026 A06 106 <sup>7</sup>							
PR-Code 1ZA, PR-Code 1ZE, PR-Code 1ZP	288,312	0 986 473 384		53,94	F 026 A06 106 <sup>7</sup>					
0 986 473 384			53,94	1 987 470 506 <sup>8</sup>						
0 986 474 384			53,94	F 026 A06 106 <sup>7</sup>						
PR-Code 1ZP, PR-Code 1ZM	228	0 986 473 071		54	1 987 470 506 <sup>8</sup>					
0 986 474 071			54	1 987 470 506 <sup>8</sup>						
	1.2 TSI	01.13→	77	PR-Code 1KD	D53	0 986 473 381		38,1	1 987 470 040 <sup>7</sup>	
				0 986 473 381			38,1	1 987 474 496 <sup>8</sup>		
				0 986 474 381			38,1	1 987 470 040 <sup>7</sup>		
				PR-Code 1KS		D53	0 986 134 203		38	
				0 986 135 203				38		
				PR-Code 1KU						1 987 470 040 <sup>7</sup>
	1.4 TSI	01.13→	110/118	PR-Code 1KD	D53	0 986 473 381		38,1	1 987 470 040 <sup>7</sup>	
	0 986 473 381					38,1	1 987 474 496 <sup>8</sup>			
	0 986 474 381					38,1	1 987 470 040 <sup>7</sup>			
	PR-Code 1KS			D53		0 986 134 203		38		
	0 986 135 203						38			
	PR-Code 1KU								1 987 470 040 <sup>7</sup>	
	1.6 TDI	01.13→	77	PR-Code 1KD	D53	0 986 473 381		38,1	1 987 470 040 <sup>7</sup>	
	0 986 473 381					38,1	1 987 474 496 <sup>8</sup>			
	0 986 474 381					38,1	1 987 470 040 <sup>7</sup>			
	PR-Code 1KS			D53		0 986 134 203		38		
	0 986 135 203						38			
	PR-Code 1KU								1 987 470 040 <sup>7</sup>	
	2.0 TDI	01.13→	81/103/ 110/147/ 155/162	PR-Code 1KD	D53	0 986 473 381		38,1	1 987 470 040 <sup>7</sup>	
	2.0 TSI			0 986 473 381			38,1	1 987 474 496 <sup>8</sup>		
	0 986 474 381					38,1	1 987 470 040 <sup>7</sup>			
	PR-Code 1KS			D53		0 986 134 203		38		
	0 986 135 203						38			
	PR-Code 1KU								1 987 470 040 <sup>7</sup>	
								1 987 474 496 <sup>8</sup>		
	1.2 TSI	01.13→	77			1 987 482 455		1498		
	1.4 TSI	01.13→	110/118			1 987 482 455		1498		
	1.6 TDI	01.13→	77			1 987 482 455		1498		
	2.0 TDI	01.13→	81/103/110/147/155/162			1 987 482 455		1498		
	2.0 TSI	01.13→	81/103/110/147/155/162			1 987 482 455		1498		
	1.2 TSI	01.13→	77		LAB	0 986 594 504 <sup>3</sup>				
					RAB	0 986 594 506 <sup>4</sup>				
					RAB	0 986 594 505 <sup>3</sup>				
	1.4 TSI	01.13→	110/118		LAB	0 986 594 504 <sup>3</sup>				
					RAB	0 986 594 506 <sup>4</sup>				
					RAB	0 986 594 505 <sup>3</sup>				
	1.6 TDI	01.13→	77		LAB	0 986 594 504 <sup>3</sup>				
						0 986 594 506 <sup>4</sup>				



































































<b>◀ VW Beetle Cabriolet [5C7]</b>								
1.6 TDI	01.13→	77			RAB	0986 594 505 <sup>3</sup>		
						0986 594 507 <sup>4</sup>		
2.0 TDI	01.13→	81/103/			LAB	0986 594 504 <sup>3</sup>		
2.0 TSI		110/147/				0986 594 506 <sup>4</sup>		
		155/162			RAB	0986 594 505 <sup>3</sup>		
						0986 594 507 <sup>4</sup>		
<b>Beetle [5C1]</b>								
	1.2 TSI	07.11→	77	PR-Code 1LV, PR-Code 1ZB	312	0986 473 384	← 53,94	F 026 A06 106 <sup>7</sup>
						0986 473 384	← 53,94	1987 470 506 <sup>8</sup>
						0986 474 384	→ 53,94	F 026 A06 106 <sup>7</sup>
				PR-Code 1ZA, PR-Code 1ZE, PR-Code 1ZD, PR-Code 1ZP	288,312	0986 473 384	← 53,94	F 026 A06 106 <sup>7</sup>
						0986 473 384	← 53,94	1987 470 506 <sup>8</sup>
						0986 474 384	→ 53,94	F 026 A06 106 <sup>7</sup>
				PR-Code 1ZM, PR-Code 1ZQ	228	0986 473 071	← 54	1987 470 506 <sup>8</sup>
						0986 474 071	→ 54	1987 470 506 <sup>8</sup>
	1.4 TSI	10.11→	110/118	PR-Code 1LV, PR-Code 1ZB	312	0986 473 384	← 53,94	F 026 A06 106 <sup>7</sup>
						0986 473 384	← 53,94	1987 470 506 <sup>8</sup>
						0986 474 384	→ 53,94	F 026 A06 106 <sup>7</sup>
				PR-Code 1ZA, PR-Code 1ZE, PR-Code 1ZD, PR-Code 1ZP	288,312	0986 473 384	← 53,94	F 026 A06 106 <sup>7</sup>
						0986 473 384	← 53,94	1987 470 506 <sup>8</sup>
						0986 474 384	→ 53,94	F 026 A06 106 <sup>7</sup>
				PR-Code 1ZM, PR-Code 1ZQ	228	0986 473 071	← 54	1987 470 506 <sup>8</sup>
						0986 474 071	→ 54	1987 470 506 <sup>8</sup>
	1.6 TDI	10.11→	77	PR-Code 1LV, PR-Code 1ZB	312	0986 473 384	← 53,94	F 026 A06 106 <sup>7</sup>
						0986 473 384	← 53,94	1987 470 506 <sup>8</sup>
						0986 474 384	→ 53,94	F 026 A06 106 <sup>7</sup>
				PR-Code 1ZA, PR-Code 1ZE, PR-Code 1ZD, PR-Code 1ZP	288,312	0986 473 384	← 53,94	F 026 A06 106 <sup>7</sup>
						0986 473 384	← 53,94	1987 470 506 <sup>8</sup>
						0986 474 384	→ 53,94	F 026 A06 106 <sup>7</sup>
				PR-Code 1ZM, PR-Code 1ZQ	228	0986 473 071	← 54	1987 470 506 <sup>8</sup>
						0986 474 071	→ 54	1987 470 506 <sup>8</sup>
	2.0 TDI	04.11→	81/103/	PR-Code 1LV, PR-Code 1ZB	312	0986 473 384	← 53,94	F 026 A06 106 <sup>7</sup>
	2.0 TSI		110/147/			0986 473 384	← 53,94	1987 470 506 <sup>8</sup>
			155/162			0986 474 384	→ 53,94	F 026 A06 106 <sup>7</sup>
				PR-Code 1ZA, PR-Code 1ZE, PR-Code 1ZD, PR-Code 1ZP	288,312	0986 473 384	← 53,94	F 026 A06 106 <sup>7</sup>
						0986 473 384	← 53,94	1987 470 506 <sup>8</sup>
						0986 474 384	→ 53,94	F 026 A06 106 <sup>7</sup>
				PR-Code 1ZM, PR-Code 1ZQ	228	0986 473 071	← 54	1987 470 506 <sup>8</sup>
						0986 474 071	→ 54	1987 470 506 <sup>8</sup>
	1.2 TSI	07.11→	77	PR-Code 1KD, PR-Code 1KQ, PR-Code 1KX	D53	0986 473 381	← 38,1	1987 470 040 <sup>7</sup>
						0986 473 381	← 38,1	1987 474 496 <sup>8</sup>
						0986 474 381	→ 38,1	1987 470 040 <sup>7</sup>
				PR-Code 1KS		0986 134 203	← 38	
						0986 135 203	→ 38	
				PR-Code 1KU, PR-Code 1KY, PR-Code 1KW	D53			1987 470 040 <sup>7</sup>
								1987 474 496 <sup>8</sup>
	1.4 TSI	10.11→	110/118	PR-Code 1KD, PR-Code 1KQ, PR-Code 1KX	D53	0986 473 381	← 38,1	1987 470 040 <sup>7</sup>
						0986 473 381	← 38,1	1987 474 496 <sup>8</sup>
						0986 474 381	→ 38,1	1987 470 040 <sup>7</sup>
				PR-Code 1KS		0986 134 203	← 38	
						0986 135 203	→ 38	
				PR-Code 1KU, PR-Code 1KY, PR-Code 1KW	D53			1987 470 040 <sup>7</sup>
								1987 474 496 <sup>8</sup>
	1.6 TDI	10.11→	77	PR-Code 1KD, PR-Code 1KQ, PR-Code 1KX	D53	0986 473 381	← 38,1	1987 470 040 <sup>7</sup>
						0986 473 381	← 38,1	1987 474 496 <sup>8</sup>
						0986 474 381	→ 38,1	1987 470 040 <sup>7</sup>

		S							
1.6 TDI		10.11→	77	PR-Code 1KS			0 986 134 203	 ← 38	
							0 986 135 203	 → 38	
				PR-Code 1KU, PR-Code 1KY, PR-Code 1KW	D53				1 987 470 040 <sup>7</sup> 1 987 474 496 <sup>8</sup>
2.0 TDI		04.11→	81/103/	PR-Code 1KD, PR-Code 1KQ,	D53		0 986 473 381	 ← 38,1	1 987 470 040 <sup>7</sup>
2.0 TSI			110/147/ 155/162	PR-Code 1KX			0 986 473 381	 ← 38,1	1 987 474 496 <sup>8</sup>
							0 986 474 381	 → 38,1	1 987 470 040 <sup>7</sup>
				PR-Code 1KS			0 986 134 203	 ← 38	
							0 986 135 203	 → 38	
				PR-Code 1KU, PR-Code 1KY, PR-Code 1KW	D53				1 987 470 040 <sup>7</sup> 1 987 474 496 <sup>8</sup>
									
1.2 TSI		07.11→	77				1 987 482 454	← 1482	
		12.14→	77				1 987 482 455	↔ 1498	
1.4 TSI		10.11→	118				1 987 482 454	← 1482	
		12.14→	110				1 987 482 455	↔ 1498	
1.6 TDI		10.11→	77	PR-Code ON4			1 987 482 455	↔ 1498	
2.0 TDI		04.12→	103	PR-Code ON4			1 987 482 455	↔ 1498	
		12.14→	81				1 987 482 455	↔ 1498	
			110				1 987 482 455	↔ 1498	
2.0 TSI		04.11→	147/155	PR-Code 1SB			1 987 482 455	↔ 1498	
		12.11→	147/155	PR-Code 1SA			1 987 482 455	← 1498	
		12.14→	162				1 987 482 455	↔ 1498	
									
1.2 TSI		07.11→	77		LAB		0 986 594 504 <sup>3</sup>		
					RAB		0 986 594 506 <sup>4</sup>		
							0 986 594 505 <sup>3</sup>		
1.4 TSI		10.11→	110/118		LAB		0 986 594 504 <sup>3</sup>		
					RAB		0 986 594 506 <sup>4</sup>		
							0 986 594 505 <sup>3</sup>		
1.6 TDI		10.11→	77		LAB		0 986 594 504 <sup>3</sup>		
					RAB		0 986 594 506 <sup>4</sup>		
							0 986 594 505 <sup>3</sup>		
2.0 TDI		04.11→	81/103/		LAB		0 986 594 504 <sup>3</sup>		
2.0 TSI			110/147/ 155/162		RAB		0 986 594 506 <sup>4</sup>		
							0 986 594 505 <sup>3</sup>		
							0 986 594 507 <sup>4</sup>		
<b>Bora Variant [1J6]</b>									
									
1.4		05.00-05.05	55			228,252	0 986 473 071	 ← 54	1 987 470 506 <sup>8</sup>
							0 986 474 071	 → 54	1 987 470 506 <sup>8</sup>
						288,312	0 986 471 923	← 54	1 987 470 506 <sup>8</sup>
							0 986 473 923		
							0 986 471 924	→ 54	1 987 470 506 <sup>8</sup>
							0 986 473 924		
1.6		05.99-05.05	74/75/77/			228,252	0 986 473 071	 ← 54	1 987 470 506 <sup>8</sup>
1.6 FSI			81			288,312	0 986 474 071	 → 54	1 987 470 506 <sup>8</sup>
							0 986 471 923	← 54	1 987 470 506 <sup>8</sup>
							0 986 473 923		
							0 986 471 924	→ 54	1 987 470 506 <sup>8</sup>
							0 986 473 924		
1.8 T		05.99-05.05	92/110/			228,252	0 986 473 071	 ← 54	1 987 470 506 <sup>8</sup>
1.8 4Motion			132				0 986 474 071	 → 54	1 987 470 506 <sup>8</sup>











		S							
	◀ VW Bora Variant [1J6]								
1.8 T	05.99-05.05	92/110/		288,312	0986 471 923	← 54	1987 470 506 <sup>8</sup>		
1.8 4Motion		132			0986 473 923				
					0986 471 924	→ 54	1987 470 506 <sup>8</sup>		
					0986 473 924				
1.9 TDI	09.98-05.05	66/74/81/		228,252	0986 473 071	← 54	1987 470 506 <sup>8</sup>		
1.9 TDI 4Motion		85/96/110			0986 474 071	→ 54	1987 470 506 <sup>8</sup>		
				288,312	0986 471 923	← 54	1987 470 506 <sup>8</sup>		
					0986 473 923				
					0986 471 924	→ 54	1987 470 506 <sup>8</sup>		
					0986 473 924				
2.0	05.99-05.05	85		228,252	0986 473 071	← 54	1987 470 506 <sup>8</sup>		
2.0 4Motion					0986 474 071	→ 54	1987 470 506 <sup>8</sup>		
				288,312	0986 471 923	← 54	1987 470 506 <sup>8</sup>		
					0986 473 923				
					0986 471 924	→ 54	1987 470 506 <sup>8</sup>		
					0986 473 924				
2.3	05.99-05.05	110/125		228,252	0986 473 071	← 54	1987 470 506 <sup>8</sup>		
2.3 4Motion					0986 474 071	→ 54	1987 470 506 <sup>8</sup>		
				288,312	0986 471 923	← 54	1987 470 506 <sup>8</sup>		
					0986 473 923				
					0986 471 924	→ 54	1987 470 506 <sup>8</sup>		
					0986 473 924				
2.8 4Motion	05.99-05.05	150			0986 471 923	← 54	1987 470 506 <sup>8</sup>		
					0986 473 923				
					0986 471 924	→ 54	1987 470 506 <sup>8</sup>		
					0986 473 924				
	1.4	05.00-05.05	55	232	0986 473 029	← 41	1987 474 496 <sup>8</sup>		
					0986 474 029	→ 41	1987 474 496 <sup>8</sup>		
				252	0986 473 139	← 38,1	1987 470 040 <sup>7</sup>		
					0986 473 139	← 38,1	1987 474 496 <sup>8</sup>		
					0986 474 139	→ 38,1	1987 470 040 <sup>7</sup>		
1.6	05.99-06.99	74	Fg.-Nr. →1J..YW238 580, →1J..YD128 801, →1J..YP061 677, →1J..YU008 822, →1J..YB019 361	232	0986 473 106	← 41	1987 474 496 <sup>8</sup>		
					0986 474 106	→ 41	1987 474 496 <sup>8</sup>		
	05.99-05.05	74		252	0986 473 139	← 38,1	1987 470 040 <sup>7</sup>		
					0986 473 139	← 38,1	1987 474 496 <sup>8</sup>		
					0986 474 139	→ 38,1	1987 470 040 <sup>7</sup>		
	07.99-05.05	74	Fg.-Nr. 1J..YW238 581→, 1J..YD128 802→, 1J..YP061 678→, 1J..YU008 823→, 1J..YB019 363→	232	0986 473 029	← 41	1987 474 496 <sup>8</sup>		
					0986 474 029	→ 41	1987 474 496 <sup>8</sup>		
1.6	08.99-05.05	75/77/81		232	0986 473 029	← 41	1987 474 496 <sup>8</sup>		
1.6 FSI					0986 474 029	→ 41	1987 474 496 <sup>8</sup>		
				252	0986 473 139	← 38,1	1987 470 040 <sup>7</sup>		
					0986 473 139	← 38,1	1987 474 496 <sup>8</sup>		
					0986 474 139	→ 38,1	1987 470 040 <sup>7</sup>		
1.8 T	05.00-05.05	110/132		232	0986 473 029	← 41	1987 474 496 <sup>8</sup>		
					0986 474 029	→ 41	1987 474 496 <sup>8</sup>		
				252	0986 473 139	← 38,1	1987 470 040 <sup>7</sup>		
					0986 473 139	← 38,1	1987 474 496 <sup>8</sup>		
					0986 474 139	→ 38,1	1987 470 040 <sup>7</sup>		
1.8 4Motion	05.99-05.99	92	Fg.-Nr. →1J..YB115 040, →1J..YD618 885, →1J..YP490 064, →1J..YU260 831, →1J..YW671 283	252	0986 473 139	← 38,1	1987 470 040 <sup>7</sup>		
					0986 473 139	← 38,1	1987 474 496 <sup>8</sup>		
					0986 474 139	→ 38,1	1987 470 040 <sup>7</sup>		
	05.99-10.00	92			0986 473 029	← 41	1987 474 496 <sup>8</sup>		
					0986 474 029	→ 41	1987 474 496 <sup>8</sup>		
	06.99-10.00	92	Fg.-Nr. 1J..YB115 041→, 1J..YD618 886→, 1J..YP490 065→, 1J..YU260 832→, 1J..YW671 284→	252	0986 473 139	← 38,1	1987 470 040 <sup>7</sup>		
					0986 473 139	← 38,1	1987 474 496 <sup>8</sup>		
					0986 474 139	→ 38,1	1987 470 040 <sup>7</sup>		

		S							
<b>1.9 TDI</b>	09.98-06.99	66	Fg.-Nr. →1J..YW238 580, →1J..YD128 801, →1J..YP061 677, →1J..YU008 822, →1J..YB019 361	232	0986 473 106		← 41	1987 474 496 <sup>B</sup>	
					0986 474 106		→ 41	1987 474 496 <sup>B</sup>	
09.98-05.05	66	252		0986 473 139		← 38,1	1987 470 040 <sup>7</sup>		
				0986 473 139		← 38,1	1987 474 496 <sup>B</sup>		
				0986 474 139		→ 38,1	1987 470 040 <sup>7</sup>		
05.99-06.99	81	Fg.-Nr. →1J..YW238 580, →1J..YD128 801, →1J..YP061 677, →1J..YU008 822, →1J..YB019 361	232	0986 473 106		← 41	1987 474 496 <sup>B</sup>		
				0986 474 106		→ 41	1987 474 496 <sup>B</sup>		
85	Fg.-Nr. →1J..YW238 580, →1J..YD128 801, →1J..YP061 677, →1J..YU008 822, →1J..YB019 361	232	0986 473 106		← 41	1987 474 496 <sup>B</sup>			
			0986 474 106		→ 41	1987 474 496 <sup>B</sup>			
05.99-04.01	85	252		0986 473 139		← 38,1	1987 470 040 <sup>7</sup>		
				0986 473 139		← 38,1	1987 474 496 <sup>B</sup>		
				0986 474 139		→ 38,1	1987 470 040 <sup>7</sup>		
05.99-05.05	81	252		0986 473 139		← 38,1	1987 470 040 <sup>7</sup>		
				0986 473 139		← 38,1	1987 474 496 <sup>B</sup>		
				0986 474 139		→ 38,1	1987 470 040 <sup>7</sup>		
07.99-05.00	85	Fg.-Nr. 1J..YW238 581→, 1J..YD128 802→, 1J..YP061 678→, 1J..YU008 823→, 1J..YB019 363→	232	0986 473 029		← 41	1987 474 496 <sup>B</sup>		
				0986 474 029		→ 41	1987 474 496 <sup>B</sup>		
07.99-05.05	66	Fg.-Nr. 1J..YW238 581→, 1J..YD128 802→, 1J..YP061 678→, 1J..YU008 823→, 1J..YB019 363→	232	0986 473 029		← 41	1987 474 496 <sup>B</sup>		
				0986 474 029		→ 41	1987 474 496 <sup>B</sup>		
81	Fg.-Nr. 1J..YW238 581→, 1J..YD128 802→, 1J..YP061 678→, 1J..YU008 823→, 1J..YB019 363→	232	0986 473 029		← 41	1987 474 496 <sup>B</sup>			
			0986 474 029		→ 41	1987 474 496 <sup>B</sup>			
01.00-04.01	85	232		0986 473 029		← 41	1987 474 496 <sup>B</sup>		
				0986 474 029		→ 41	1987 474 496 <sup>B</sup>		
05.00-05.05	74	232		0986 473 029		← 41	1987 474 496 <sup>B</sup>		
				0986 474 029		→ 41	1987 474 496 <sup>B</sup>		
				0986 473 029		← 41	1987 474 496 <sup>B</sup>		
81	232		0986 473 029		← 41	1987 474 496 <sup>B</sup>			
			0986 474 029		→ 41	1987 474 496 <sup>B</sup>			
			0986 473 029		← 41	1987 474 496 <sup>B</sup>			
01.01-05.05	96/110	232		0986 473 029		← 41	1987 474 496 <sup>B</sup>		
				0986 474 029		→ 41	1987 474 496 <sup>B</sup>		
<b>1.9 TDI</b>	05.00-05.05	74		0986 473 139		← 38,1	1987 470 040 <sup>7</sup>		
				0986 474 139		← 38,1	1987 474 496 <sup>B</sup>		
<b>1.9 TDI 4Motion</b>	01.01-05.05	96/110		0986 473 139		← 38,1	1987 470 040 <sup>7</sup>		
				0986 473 139		← 38,1	1987 474 496 <sup>B</sup>		
<b>1.9 TDI 4Motion</b>	05.99-05.99	85	Fg.-Nr. →1J..YB115 040, →1J..YD618 885, →1J..YP490 064, →1J..YU260 831, →1J..YW671 283	0986 473 139		← 38,1	1987 470 040 <sup>7</sup>		
				0986 473 139		← 38,1	1987 474 496 <sup>B</sup>		
				0986 474 139		→ 38,1	1987 470 040 <sup>7</sup>		
05.99-04.01	85			0986 473 029		← 41	1987 474 496 <sup>B</sup>		
				0986 474 029		→ 41	1987 474 496 <sup>B</sup>		
				0986 473 139		← 38,1	1987 470 040 <sup>7</sup>		
06.99-05.00	85	Fg.-Nr. 1J..YB115 041→, 1J..YD618 886→, 1J..YP490 065→, 1J..YU260 832→, 1J..YW671 284→	252	0986 473 139		← 38,1	1987 470 040 <sup>7</sup>		
				0986 473 139		← 38,1	1987 474 496 <sup>B</sup>		
				0986 474 139		→ 38,1	1987 470 040 <sup>7</sup>		
05.00-04.01	85	252		0986 473 139		← 38,1	1987 470 040 <sup>7</sup>		
				0986 473 139		← 38,1	1987 474 496 <sup>B</sup>		
				0986 474 139		→ 38,1	1987 470 040 <sup>7</sup>		
05.00-05.05	74			0986 473 029		← 41	1987 474 496 <sup>B</sup>		
				0986 474 029		→ 41	1987 474 496 <sup>B</sup>		
01.01-05.05	96/110			0986 473 029		← 41	1987 474 496 <sup>B</sup>		
				0986 474 029		→ 41	1987 474 496 <sup>B</sup>		
<b>2.0</b>	05.99-06.99	85	Fg.-Nr. →1J..YW238 580, →1J..YD128 801, →1J..YP061 677, →1J..YU008 822, →1J..YB019 361	232	0986 473 106		← 41	1987 474 496 <sup>B</sup>	
					0986 474 106		→ 41	1987 474 496 <sup>B</sup>	
05.99-05.05	85	252		0986 473 139		← 38,1	1987 470 040 <sup>7</sup>		
				0986 474 139		→ 38,1	1987 470 040 <sup>7</sup>		
				0986 474 139		→ 38,1	1987 474 496 <sup>B</sup>		



		S								
	◀ VW Bora Variant [1J6]									
2.0		07.99-05.05	85	Fg.-Nr. 1J..YW238 581→,	232	1J..YD128 802→, 1J..YP061 678→,	0986 473 029		← 41	1987 474 496 <sup>8</sup>
							0986 474 029		→ 41	1987 474 496 <sup>8</sup>
		04.00-05.05	85		232		0986 473 029		← 41	1987 474 496 <sup>8</sup>
							0986 474 029		→ 41	1987 474 496 <sup>8</sup>
2.0 4Motion		04.00-05.05	85				0986 473 029		← 41	1987 474 496 <sup>8</sup>
							0986 474 029		→ 41	1987 474 496 <sup>8</sup>
					252		0986 473 139		← 38,1	1987 470 040 <sup>7</sup>
							0986 473 139		← 38,1	1987 474 496 <sup>8</sup>
							0986 474 139		→ 38,1	1987 474 496 <sup>8</sup>
2.3		05.99-06.99	110	Fg.-Nr. →1J..YW238 580,	232	→1J..YD128 801, →1J..YP061 677,	0986 473 106		← 41	1987 474 496 <sup>8</sup>
							0986 474 106		→ 41	1987 474 496 <sup>8</sup>
		05.99-02.01	110		252		0986 473 139		← 38,1	1987 470 040 <sup>7</sup>
							0986 474 139		→ 38,1	1987 470 040 <sup>7</sup>
							0986 474 139		→ 38,1	1987 474 496 <sup>8</sup>
		07.99-02.01	110	Fg.-Nr. 1J..YW238 581→,	232	1J..YD128 802→, 1J..YP061 678→,	0986 473 029		← 41	1987 474 496 <sup>8</sup>
							0986 474 029		→ 41	1987 474 496 <sup>8</sup>
		09.00-05.05	125		232		0986 473 029		← 41	1987 474 496 <sup>8</sup>
							0986 474 029		→ 41	1987 474 496 <sup>8</sup>
2.3		09.00-05.05	125		252		0986 473 139		← 38,1	1987 470 040 <sup>7</sup>
2.3 4Motion							0986 473 139		← 38,1	1987 474 496 <sup>8</sup>
							0986 474 139		→ 38,1	1987 470 040 <sup>7</sup>
2.3 4Motion		05.00-02.01	110				0986 473 029		← 41	1987 474 496 <sup>8</sup>
							0986 474 029		→ 41	1987 474 496 <sup>8</sup>
					252		0986 473 139		← 38,1	1987 470 040 <sup>7</sup>
							0986 473 139		← 38,1	1987 474 496 <sup>8</sup>
							0986 474 139		→ 38,1	1987 474 496 <sup>8</sup>
		09.00-05.05	125				0986 473 029		← 41	1987 474 496 <sup>8</sup>
							0986 474 029		→ 41	1987 474 496 <sup>8</sup>
2.8 4Motion		05.99-05.99	150	Fg.-Nr. →1J..YB115 040,		→1J..YD618 885, →1J..YP490 064,	0986 473 139		← 38,1	1987 470 040 <sup>7</sup>
							0986 473 139		← 38,1	1987 474 496 <sup>8</sup>
							0986 474 139		→ 38,1	1987 470 040 <sup>7</sup>
		06.99-05.00	150	Fg.-Nr. 1J..YB115 041→,		1J..YD618 886→, 1J..YP490 065→,	0986 473 139		← 38,1	1987 470 040 <sup>7</sup>
							0986 473 139		← 38,1	1987 474 496 <sup>8</sup>
							0986 474 139		→ 38,1	1987 470 040 <sup>7</sup>
		01.00-05.05	150				0986 473 139		← 38,1	1987 470 040 <sup>7</sup>
							0986 473 139		← 38,1	1987 474 496 <sup>8</sup>
							0986 474 139		→ 38,1	1987 470 040 <sup>7</sup>
	1.4	05.00-05.05	55				1987 477 698		↔ 1693	
				1.6	05.99-06.99	74	Fg.-Nr. →1J..YW238 580,	232	1987 477 696	
→1J..YD128 801, →1J..YP061 677,	→1J..YU008 822, →1J..YB019 361									
				05.99-05.05	74		252	1987 477 698		↔ 1693
							1987 477 698		↔ 1693	
		08.99-05.05	75/77/81				1987 477 698		↔ 1693	
	1.6 FSI	08.01-05.05	75/77/81				1987 477 698		↔ 1693	
	1.8 T	05.00-05.05	110/132				1987 477 698		↔ 1693	
	1.8 4Motion	05.99-10.00	92				1987 477 686		↔ 1723	
	1.9 TDI	09.98-06.99	66	Fg.-Nr. →1J..YW238 580,		→1J..YD128 801, →1J..YP061 677,	1987 477 696		↔ 1688	
		05.99-06.99	81	Fg.-Nr. →1J..YW238 580,	232	→1J..YD128 801, →1J..YP061 677,	1987 477 696		↔ 1688	

		S							
<b>1.9 TDI</b>	05.99-06.99	85	Fg.-Nr. →1J..YW238 580, 232 →1J..YD128 801, →1J..YP061 677, →1J..YU008 822, →1J..YB019 361				1 987 477 696	↔ 1688	
	05.99-05.00	85		252			1 987 477 698	↔ 1693	
			Fg.-Nr. 1J..YW238 581→, 232 1J..YD128 802→, 1J..YP061 678→, 1J..YU008 823→, 1J..YB019 362→				1 987 477 698	↔ 1693	
	05.99-05.05	81		252			1 987 477 698	↔ 1693	
			Fg.-Nr. 1J..YW238 581→, 232 1J..YD128 802→, 1J..YP061 678→, 1J..YU008 823→, 1J..YB019 362→				1 987 477 698	↔ 1693	
	07.99-05.05	66	Fg.-Nr. 1J..YW238 581→, 1J..YD128 802→, 1J..YP061 678→, 1J..YU008 823→, 1J..YB019 362→				1 987 477 698	↔ 1693	
	01.00-04.01	85					1 987 477 698	↔ 1693	
	05.00-05.05	74					1 987 477 698	↔ 1693	
		81					1 987 477 698	↔ 1693	
		01.01-05.05	96/110					1 987 477 698	↔ 1693
<b>1.9 TDI 4Motion</b>	05.99-04.01	85					1 987 477 686	↔ 1723	
	05.00-05.05	74					1 987 477 686	↔ 1723	
	01.01-05.05	96/110					1 987 477 686	↔ 1723	
<b>2.0</b>	05.99-06.99	85	Fg.-Nr. →1J..YW238 580, 232 →1J..YD128 801, →1J..YP061 677, →1J..YU008 822, →1J..YB019 361				1 987 477 696	↔ 1688	
	05.99-05.05	85		252			1 987 477 698	↔ 1693	
			Fg.-Nr. 1J..YW238 581→, 232 1J..YD128 802→, 1J..YP061 678→, 1J..YU008 823→, 1J..YB019 362→				1 987 477 698	↔ 1693	
	04.00-05.05	85					1 987 477 698	↔ 1693	
<b>2.0 4Motion</b>	04.00-05.05	85					1 987 477 686	↔ 1723	
<b>2.3</b>	05.99-06.99	110	Fg.-Nr. →1J..YW238 580, 232 →1J..YD128 801, →1J..YP061 677, →1J..YU008 822, →1J..YB019 361				1 987 477 696	↔ 1688	
	05.99-02.01	110		252			1 987 477 698	↔ 1693	
			Fg.-Nr. 1J..YW238 581→, 232 1J..YD128 802→, 1J..YP061 678→, 1J..YU008 823→, 1J..YB019 362→				1 987 477 698	↔ 1693	
	09.00-05.05	125					1 987 477 698	↔ 1693	
<b>2.3 4Motion</b>	05.00-02.01	110					1 987 477 686	↔ 1723	
	09.00-05.05	125					1 987 477 686	↔ 1723	
	05.99-05.05	150					1 987 477 686	↔ 1723	
<b>2.8 4Motion</b>	05.99-05.05	150					1 987 477 686	↔ 1723	
 <b>1.4</b>	05.00-05.05	55					0 986 594 004 <sup>4</sup>		
					LAB		0 986 594 001 <sup>3</sup>		
					RAB		0 986 594 000 <sup>3</sup>		
<b>1.6</b>	05.99-05.05	74/75/77/					0 986 594 004 <sup>4</sup>		
<b>1.6 FSI</b>		81					0 986 594 001 <sup>3</sup>		
					LAB		0 986 594 001 <sup>3</sup>		
					RAB		0 986 594 000 <sup>3</sup>		
<b>1.8 T</b>	05.00-05.05	110/132					0 986 594 004 <sup>4</sup>		
					LAB		0 986 594 001 <sup>3</sup>		
					RAB		0 986 594 000 <sup>3</sup>		
<b>1.8 4Motion</b>	05.99-10.00	92					0 986 594 004 <sup>4</sup>		
					LAB		0 986 594 001 <sup>3</sup>		
					RAB		0 986 594 000 <sup>3</sup>		
<b>1.9 TDI</b>	09.98-05.05	66					0 986 594 004 <sup>4</sup>		
					LAB		0 986 594 001 <sup>3</sup>		
					RAB		0 986 594 000 <sup>3</sup>		
	05.99-05.05	81					0 986 594 004 <sup>4</sup>		
					LAB		0 986 594 001 <sup>3</sup>		
					RAB		0 986 594 000 <sup>3</sup>		
		85/96/110					0 986 594 004 <sup>4</sup>		
	05.00-05.05	74					0 986 594 004 <sup>4</sup>		



		S							
<b>VW Bora Variant [1J6]</b>									
1.9 TDI		05.99-05.05	85/96/110			LAB	0986 594 001 <sup>3</sup>		
1.9 TDI 4Motion						RAB	0986 594 000 <sup>3</sup>		
		05.00-05.05	74			LAB	0986 594 001 <sup>3</sup>		
						RAB	0986 594 000 <sup>3</sup>		
1.9 TDI 4Motion		05.99-05.05	85/96/110				0986 594 008 <sup>4</sup>		
		05.00-05.05	74				0986 594 008 <sup>4</sup>		
2.0		05.99-05.05	85				0986 594 004 <sup>4</sup>		
2.0		05.99-05.05	85			LAB	0986 594 001 <sup>3</sup>		
2.0 4Motion						RAB	0986 594 000 <sup>3</sup>		
2.0 4Motion		04.00-05.05	85				0986 594 008 <sup>4</sup>		
2.3		05.99-05.05	110/125				0986 594 004 <sup>4</sup>		
2.3		05.99-05.05	110/125			LAB	0986 594 001 <sup>3</sup>		
2.3 4Motion						RAB	0986 594 000 <sup>3</sup>		
2.3 4Motion		05.00-05.05	110/125				0986 594 008 <sup>4</sup>		
2.8 4Motion		05.99-05.05	150				0986 594 008 <sup>4</sup>		
						LAB	0986 594 001 <sup>3</sup>		
						RAB	0986 594 000 <sup>3</sup>		
<b>Bora [1J2]</b>									
	1.4	09.98-05.05	55			228,252	0986 473 071	← 54	1987 470 506 <sup>8</sup>
							0986 474 071	→ 54	1987 470 506 <sup>8</sup>
						288,312	0986 471 923	← 54	1987 470 506 <sup>8</sup>
							0986 473 923		
							0986 471 924	→ 54	1987 470 506 <sup>8</sup>
							0986 473 924		
	1.6	09.98-05.05	74			228,252	0986 473 071	← 54	1987 470 506 <sup>8</sup>
							0986 474 071	→ 54	1987 470 506 <sup>8</sup>
						288,312	0986 471 923	← 54	1987 470 506 <sup>8</sup>
							0986 473 923		
							0986 471 924	→ 54	1987 470 506 <sup>8</sup>
							0986 473 924		
		09.00-05.05	75			228,252	0986 473 071	← 54	1987 470 506 <sup>8</sup>
							0986 474 071	→ 54	1987 470 506 <sup>8</sup>
						288,312	0986 471 923	← 54	1987 470 506 <sup>8</sup>
							0986 473 923		
							0986 471 924	→ 54	1987 470 506 <sup>8</sup>
							0986 473 924		
	1.6	08.99-05.05	77/81			228,252	0986 473 071	← 54	1987 470 506 <sup>8</sup>
	1.6 FSI						0986 474 071	→ 54	1987 470 506 <sup>8</sup>
						288,312	0986 471 923	← 54	1987 470 506 <sup>8</sup>
							0986 473 923		
							0986 471 924	→ 54	1987 470 506 <sup>8</sup>
							0986 473 924		
	1.8	09.98-05.05	92/110/			228,252	0986 473 071	← 54	1987 470 506 <sup>8</sup>
	1.8 T		132				0986 474 071	→ 54	1987 470 506 <sup>8</sup>
	1.8 4Motion					288,312	0986 471 923	← 54	1987 470 506 <sup>8</sup>
							0986 473 923		
							0986 471 924	→ 54	1987 470 506 <sup>8</sup>
							0986 473 924		
	1.9 SDI	09.98-05.05	50/66/74/			228,252	0986 473 071	← 54	1987 470 506 <sup>8</sup>
	1.9 TDI		81/85/96/				0986 474 071	→ 54	1987 470 506 <sup>8</sup>
	1.9 TDI 4Motion		110			288,312	0986 471 923	← 54	1987 470 506 <sup>8</sup>
							0986 473 923		
							0986 471 924	→ 54	1987 470 506 <sup>8</sup>
							0986 473 924		
	2.0	09.98-05.05	85			228,252	0986 473 071	← 54	1987 470 506 <sup>8</sup>
							0986 474 071	→ 54	1987 470 506 <sup>8</sup>
						288,312	0986 471 923	← 54	1987 470 506 <sup>8</sup>
							0986 473 923		
							0986 471 924	→ 54	1987 470 506 <sup>8</sup>
							0986 473 924		

		S							
<b>2.0 4Motion</b>		04.00-05.05	85			228,252	0 986 473 071	← 54	1 987 470 506 <sup>B</sup>
							0 986 474 071	→ 54	1 987 470 506 <sup>B</sup>
						288,312	0 986 471 923	← 54	1 987 470 506 <sup>B</sup>
							0 986 473 923		
							0 986 471 924	→ 54	1 987 470 506 <sup>B</sup>
							0 986 473 924		
<b>2.3</b>		09.98-05.05	110/125			228,252	0 986 473 071	← 54	1 987 470 506 <sup>B</sup>
<b>2.3 4Motion</b>							0 986 474 071	→ 54	1 987 470 506 <sup>B</sup>
						288,312	0 986 471 923	← 54	1 987 470 506 <sup>B</sup>
							0 986 473 923		
							0 986 471 924	→ 54	1 987 470 506 <sup>B</sup>
							0 986 473 924		
<b>2.8 4Motion</b>		05.99-05.05	150			228,252	0 986 473 071	← 54	1 987 470 506 <sup>B</sup>
							0 986 474 071	→ 54	1 987 470 506 <sup>B</sup>
						288,312	0 986 471 923	← 54	1 987 470 506 <sup>B</sup>
							0 986 473 923		
							0 986 471 924	→ 54	1 987 470 506 <sup>B</sup>
							0 986 473 924		
<b>1.4</b>		09.98-06.99	55	Fg.-Nr. →1J..YW238 580, →1J..YD128 801, →1J..YP061 677, →1J..YU008 822, →1J..YB019 361		232	0 986 473 106	← 41	1 987 474 496 <sup>B</sup>
							0 986 474 106	→ 41	1 987 474 496 <sup>B</sup>
		09.98-05.05	55			252	0 986 473 139	← 38,1	1 987 470 040 <sup>7</sup>
							0 986 473 139	← 38,1	1 987 474 496 <sup>B</sup>
							0 986 474 139	→ 38,1	1 987 470 040 <sup>7</sup>
		07.99-05.05	55	Fg.-Nr. 1J..YW238 581→, 1J..YD128 802→, 1J..YP061 678→, 1J..YU008 823→, 1J..YB019 363→		232	0 986 473 029	← 41	1 987 474 496 <sup>B</sup>
							0 986 474 029	→ 41	1 987 474 496 <sup>B</sup>
		05.00-05.05	55			232	0 986 473 029	← 41	1 987 474 496 <sup>B</sup>
							0 986 474 029	→ 41	1 987 474 496 <sup>B</sup>
<b>1.6</b>		09.98-06.99	74	Fg.-Nr. →1J..YW238 580, →1J..YD128 801, →1J..YP061 677, →1J..YU008 822, →1J..YB019 361		232	0 986 473 106	← 41	1 987 474 496 <sup>B</sup>
							0 986 474 106	→ 41	1 987 474 496 <sup>B</sup>
		09.98-05.05	74			252	0 986 473 139	← 38,1	1 987 470 040 <sup>7</sup>
							0 986 473 139	← 38,1	1 987 474 496 <sup>B</sup>
							0 986 474 139	→ 38,1	1 987 470 040 <sup>7</sup>
		07.99-05.05	74	Fg.-Nr. 1J..YW238 581→, 1J..YD128 802→, 1J..YP061 678→, 1J..YU008 823→, 1J..YB019 363→		232	0 986 473 029	← 41	1 987 474 496 <sup>B</sup>
							0 986 474 029	→ 41	1 987 474 496 <sup>B</sup>
		09.00-05.05	75			232	0 986 473 029	← 41	1 987 474 496 <sup>B</sup>
							0 986 474 029	→ 41	1 987 474 496 <sup>B</sup>
						252	0 986 473 139	← 38,1	1 987 470 040 <sup>7</sup>
							0 986 473 139	← 38,1	1 987 474 496 <sup>B</sup>
							0 986 474 139	→ 38,1	1 987 470 040 <sup>7</sup>
<b>1.6</b>		08.99-05.05	77/81			232	0 986 473 029	← 41	1 987 474 496 <sup>B</sup>
<b>1.6 FSI</b>							0 986 474 029	→ 41	1 987 474 496 <sup>B</sup>
						252	0 986 473 139	← 38,1	1 987 470 040 <sup>7</sup>
							0 986 473 139	← 38,1	1 987 474 496 <sup>B</sup>
							0 986 474 139	→ 38,1	1 987 470 040 <sup>7</sup>
<b>1.8</b>		09.98-06.99	92	Fg.-Nr. →1J..YW238 580, →1J..YD128 801, →1J..YP061 677, →1J..YU008 822, →1J..YB019 361		232	0 986 473 106	← 41	1 987 474 496 <sup>B</sup>
							0 986 474 106	→ 41	1 987 474 496 <sup>B</sup>
		09.98-10.00	92			252	0 986 473 139	← 38,1	1 987 470 040 <sup>7</sup>
							0 986 473 139	← 38,1	1 987 474 496 <sup>B</sup>
							0 986 474 139	→ 38,1	1 987 470 040 <sup>7</sup>
		07.99-10.00	92	Fg.-Nr. 1J..YW238 581→, 1J..YD128 802→, 1J..YP061 678→, 1J..YU008 823→, 1J..YB019 363→		232	0 986 473 029	← 41	1 987 474 496 <sup>B</sup>
							0 986 474 029	→ 41	1 987 474 496 <sup>B</sup>
<b>1.8 T</b>		05.00-05.05	110/132			232	0 986 473 029	← 41	1 987 474 496 <sup>B</sup>
							0 986 474 029	→ 41	1 987 474 496 <sup>B</sup>





<b>◀ VW Bora [1J2]</b>									
<b>1.8 T</b>	05.00-05.05	110/132	252	0986 <b>473 139</b>	38,1	1987 <b>470 040</b> <sup>7</sup>			
				0986 <b>473 139</b>	38,1	1987 <b>474 496</b> <sup>8</sup>			
				0986 <b>474 139</b>	38,1	1987 <b>470 040</b> <sup>7</sup>			
<b>1.8 4Motion</b>	02.99-05.99	92	Fg.-Nr. →1J..YB115 040, →1J..YD618 885, →1J..YP490 064, →1J..YU260 831, →1J..YW671 283	0986 <b>473 139</b>	38,1	1987 <b>470 040</b> <sup>7</sup>			
				0986 <b>473 139</b>	38,1	1987 <b>474 496</b> <sup>8</sup>			
				0986 <b>474 139</b>	38,1	1987 <b>470 040</b> <sup>7</sup>			
	02.99-10.00	92		0986 <b>473 029</b>	41	1987 <b>474 496</b> <sup>8</sup>			
				0986 <b>474 029</b>	41	1987 <b>474 496</b> <sup>8</sup>			
	06.99-10.00	92	Fg.-Nr. 1J..YB115 041→, 1J..YD618 886→, 1J..YP490 065→, 1J..YU260 832→, 1J..YW671 284→	0986 <b>473 139</b>	38,1	1987 <b>470 040</b> <sup>7</sup>			
0986 <b>473 139</b>				38,1	1987 <b>474 496</b> <sup>8</sup>				
0986 <b>474 139</b>				38,1	1987 <b>470 040</b> <sup>7</sup>				
<b>1.9 SDI</b>	09.98-06.99	50	Fg.-Nr. →1J..YW238 580, →1J..YD128 801, →1J..YP061 677, →1J..YU008 822, →1J..YB019 361	0986 <b>473 106</b>	41	1987 <b>474 496</b> <sup>8</sup>			
				0986 <b>474 106</b>	41	1987 <b>474 496</b> <sup>8</sup>			
				0986 <b>473 139</b>	38,1	1987 <b>470 040</b> <sup>7</sup>			
	09.98-05.05	50	252	0986 <b>473 139</b>	38,1	1987 <b>470 040</b> <sup>7</sup>			
				0986 <b>473 139</b>	38,1	1987 <b>474 496</b> <sup>8</sup>			
				0986 <b>474 139</b>	38,1	1987 <b>470 040</b> <sup>7</sup>			
	07.99-05.05	50	Fg.-Nr. 1J..YW238 581→, 1J..YD128 802→, 1J..YP061 678→, 1J..YU008 823→, 1J..YB019 363→	0986 <b>473 029</b>	41	1987 <b>474 496</b> <sup>8</sup>			
				0986 <b>474 029</b>	41	1987 <b>474 496</b> <sup>8</sup>			
	<b>1.9 TDI</b>	09.98-06.99	66	Fg.-Nr. →1J..YW238 580, →1J..YD128 801, →1J..YP061 677, →1J..YU008 822, →1J..YB019 361	0986 <b>473 106</b>	41	1987 <b>474 496</b> <sup>8</sup>		
0986 <b>474 106</b>					41	1987 <b>474 496</b> <sup>8</sup>			
0986 <b>473 106</b>					41	1987 <b>474 496</b> <sup>8</sup>			
81			Fg.-Nr. →1J..YW238 580, →1J..YD128 801, →1J..YP061 677, →1J..YU008 822, →1J..YB019 361	0986 <b>473 106</b>	41	1987 <b>474 496</b> <sup>8</sup>			
				0986 <b>474 106</b>	41	1987 <b>474 496</b> <sup>8</sup>			
85			Fg.-Nr. →1J..YW238 580, →1J..YD128 801, →1J..YP061 677, →1J..YU008 822, →1J..YB019 361	0986 <b>473 106</b>	41	1987 <b>474 496</b> <sup>8</sup>			
				0986 <b>474 106</b>	41	1987 <b>474 496</b> <sup>8</sup>			
09.98-05.01		85	252	0986 <b>473 139</b>	38,1	1987 <b>470 040</b> <sup>7</sup>			
				0986 <b>473 139</b>	38,1	1987 <b>474 496</b> <sup>8</sup>			
				0986 <b>474 139</b>	38,1	1987 <b>470 040</b> <sup>7</sup>			
09.98-05.05		66	252	0986 <b>473 139</b>	38,1	1987 <b>470 040</b> <sup>7</sup>			
				0986 <b>473 139</b>	38,1	1987 <b>474 496</b> <sup>8</sup>			
				0986 <b>474 139</b>	38,1	1987 <b>470 040</b> <sup>7</sup>			
		81		252	0986 <b>473 139</b>	38,1	1987 <b>470 040</b> <sup>7</sup>		
					0986 <b>473 139</b>	38,1	1987 <b>474 496</b> <sup>8</sup>		
					0986 <b>474 139</b>	38,1	1987 <b>470 040</b> <sup>7</sup>		
07.99-05.01		85	Fg.-Nr. 1J..YW238 581→, 1J..YD128 802→, 1J..YP061 678→, 1J..YU008 823→, 1J..YB019 363→	0986 <b>473 029</b>	41	1987 <b>474 496</b> <sup>8</sup>			
				0986 <b>474 029</b>	41	1987 <b>474 496</b> <sup>8</sup>			
07.99-05.05		66	Fg.-Nr. 1J..YW238 581→, 1J..YD128 802→, 1J..YP061 678→, 1J..YU008 823→, 1J..YB019 363→	0986 <b>473 029</b>	41	1987 <b>474 496</b> <sup>8</sup>			
				0986 <b>474 029</b>	41	1987 <b>474 496</b> <sup>8</sup>			
				0986 <b>473 029</b>	41	1987 <b>474 496</b> <sup>8</sup>			
81			Fg.-Nr. 1J..YW238 581→, 1J..YD128 802→, 1J..YP061 678→, 1J..YU008 823→, 1J..YB019 363→	0986 <b>473 029</b>	41	1987 <b>474 496</b> <sup>8</sup>			
				0986 <b>474 029</b>	41	1987 <b>474 496</b> <sup>8</sup>			
01.00-04.01		85	232	0986 <b>473 029</b>	41	1987 <b>474 496</b> <sup>8</sup>			
	0986 <b>474 029</b>			41	1987 <b>474 496</b> <sup>8</sup>				
01.00-05.05	74	232	0986 <b>473 029</b>	41	1987 <b>474 496</b> <sup>8</sup>				
			0986 <b>474 029</b>	41	1987 <b>474 496</b> <sup>8</sup>				
			0986 <b>473 029</b>	41	1987 <b>474 496</b> <sup>8</sup>				
96/110		232	0986 <b>473 029</b>	41	1987 <b>474 496</b> <sup>8</sup>				
			0986 <b>474 029</b>	41	1987 <b>474 496</b> <sup>8</sup>				
			0986 <b>473 029</b>	41	1987 <b>474 496</b> <sup>8</sup>				
05.00-05.05	81	232	0986 <b>473 029</b>	41	1987 <b>474 496</b> <sup>8</sup>				
			0986 <b>474 029</b>	41	1987 <b>474 496</b> <sup>8</sup>				
<b>1.9 TDI</b>	01.00-05.05	74	252	0986 <b>473 139</b>	38,1	1987 <b>470 040</b> <sup>7</sup>			
<b>1.9 TDI 4Motion</b>		96/110	252	0986 <b>473 139</b>	38,1	1987 <b>474 496</b> <sup>8</sup>			
				0986 <b>474 139</b>	38,1	1987 <b>470 040</b> <sup>7</sup>			
				0986 <b>473 139</b>	38,1	1987 <b>470 040</b> <sup>7</sup>			
			96/110	252	0986 <b>473 139</b>	38,1	1987 <b>470 040</b> <sup>7</sup>		
					0986 <b>473 139</b>	38,1	1987 <b>474 496</b> <sup>8</sup>		
				0986 <b>474 139</b>	38,1	1987 <b>470 040</b> <sup>7</sup>			



		S							
<b>1.9 TDI 4Motion</b>	01.99-05.99	66	Fg.-Nr. →1J..YB115 040, →1J..YD618 885, →1J..YP490 064, →1J..YU260 831, →1J..YW671 283	252	0 986 473 139		← 38,1	1 987 470 040 <sup>7</sup>	
					0 986 473 139		← 38,1	1 987 474 496 <sup>8</sup>	
					0 986 474 139		→ 38,1	1 987 470 040 <sup>7</sup>	
	01.99-05.05	66			0 986 473 029		← 41	1 987 474 496 <sup>8</sup>	
					0 986 474 029		→ 41	1 987 474 496 <sup>8</sup>	
	02.99-05.99	85	Fg.-Nr. →1J..YB115 040, →1J..YD618 885, →1J..YP490 064, →1J..YU260 831, →1J..YW671 283	252	0 986 473 139		← 38,1	1 987 470 040 <sup>7</sup>	
					0 986 473 139		← 38,1	1 987 474 496 <sup>8</sup>	
					0 986 474 139		→ 38,1	1 987 470 040 <sup>7</sup>	
	02.99-04.01	85			0 986 473 029		← 41	1 987 474 496 <sup>8</sup>	
					0 986 474 029		→ 41	1 987 474 496 <sup>8</sup>	
	06.99-05.00	85	Fg.-Nr. 1J..YB115 041→, 1J..YD618 886→, 1J..YP490 065→, 1J..YU260 832→, 1J..YW671 284→	252	0 986 473 139		← 38,1	1 987 470 040 <sup>7</sup>	
					0 986 473 139		← 38,1	1 987 474 496 <sup>8</sup>	
0 986 474 139						→ 38,1	1 987 470 040 <sup>7</sup>		
06.99-05.05	66	Fg.-Nr. 1J..YB115 041→, 1J..YD618 886→, 1J..YP490 065→, 1J..YU260 832→, 1J..YW671 284→	252	0 986 473 139		← 38,1	1 987 470 040 <sup>7</sup>		
				0 986 473 139		← 38,1	1 987 474 496 <sup>8</sup>		
				0 986 474 139		→ 38,1	1 987 470 040 <sup>7</sup>		
01.00-05.05	74			0 986 473 029		← 41	1 987 474 496 <sup>8</sup>		
				0 986 474 029		→ 41	1 987 474 496 <sup>8</sup>		
05.00-04.01	85		252	0 986 473 139		← 38,1	1 987 470 040 <sup>7</sup>		
				0 986 473 139		← 38,1	1 987 474 496 <sup>8</sup>		
				0 986 474 139		→ 38,1	1 987 470 040 <sup>7</sup>		
09.00-05.05	96/110			0 986 473 029		← 41	1 987 474 496 <sup>8</sup>		
				0 986 474 029		→ 41	1 987 474 496 <sup>8</sup>		
<b>2.0</b>	09.98-06.99	85	Fg.-Nr. →1J..YW238 580, →1J..YD128 801, →1J..YP061 677, →1J..YU008 822, →1J..YB019 361	232	0 986 473 106		← 41	1 987 474 496 <sup>8</sup>	
					0 986 474 106		→ 41	1 987 474 496 <sup>8</sup>	
	09.98-05.05	85		252	0 986 473 139		← 38,1	1 987 470 040 <sup>7</sup>	
					0 986 473 139		← 38,1	1 987 474 496 <sup>8</sup>	
					0 986 474 139		→ 38,1	1 987 470 040 <sup>7</sup>	
	07.99-05.05	85	Fg.-Nr. 1J..YW238 581→, 1J..YD128 802→, 1J..YP061 678→, 1J..YU008 823→, 1J..YB019 363→	232	0 986 473 029		← 41	1 987 474 496 <sup>8</sup>	
					0 986 474 029		→ 41	1 987 474 496 <sup>8</sup>	
			Fg.-Nr. 1J..YW238 581→, 1J..YD128 802→, 1J..YP061 678→, 1J..YU008 823→, 1J..YB019 363→, PR-Code 1KP, PR-Code 1KT, PR-Code 1KX	232	0 986 473 029		← 41	1 987 474 496 <sup>8</sup>	
					0 986 474 029		→ 41	1 987 474 496 <sup>8</sup>	
	04.00-05.05	85		232	0 986 473 029		← 41	1 987 474 496 <sup>8</sup>	
					0 986 474 029		→ 41	1 987 474 496 <sup>8</sup>	
<b>2.0 4Motion</b>	04.00-05.05	85		252	0 986 473 029		← 41	1 987 474 496 <sup>8</sup>	
					0 986 474 029		→ 41	1 987 474 496 <sup>8</sup>	
					0 986 473 139		← 38,1	1 987 470 040 <sup>7</sup>	
					0 986 473 139		← 38,1	1 987 474 496 <sup>8</sup>	
<b>2.3</b>	09.98-06.99	110	Fg.-Nr. →1J..YW238 580, →1J..YD128 801, →1J..YP061 677, →1J..YU008 822, →1J..YB019 361	232	0 986 473 106		← 41	1 987 474 496 <sup>8</sup>	
					0 986 474 106		→ 41	1 987 474 496 <sup>8</sup>	
	09.98-02.01	110		252	0 986 473 139		← 38,1	1 987 470 040 <sup>7</sup>	
					0 986 473 139		← 38,1	1 987 474 496 <sup>8</sup>	
					0 986 474 139		→ 38,1	1 987 470 040 <sup>7</sup>	
	07.99-02.01	110	Fg.-Nr. 1J..YW238 581→, 1J..YD128 802→, 1J..YP061 678→, 1J..YU008 823→, 1J..YB019 363→	232	0 986 473 029		← 41	1 987 474 496 <sup>8</sup>	
					0 986 474 029		→ 41	1 987 474 496 <sup>8</sup>	
	09.00-05.05	125		232	0 986 473 029		← 41	1 987 474 496 <sup>8</sup>	
					0 986 474 029		→ 41	1 987 474 496 <sup>8</sup>	
<b>2.3 4Motion</b>	09.00-05.05	125		252	0 986 473 139		← 38,1	1 987 470 040 <sup>7</sup>	
					0 986 473 139		← 38,1	1 987 474 496 <sup>8</sup>	
					0 986 474 139		→ 38,1	1 987 470 040 <sup>7</sup>	



		S								
◀ VW Bora [1J2]										
2.3 4Motion	01.99-05.99	110	Fg.-Nr. →1J..YB115 040,	252	0986 473 139		← 38,1	1987 470 040 <sup>7</sup>		
					0986 473 139				→1J..YD618 885, →1J..YP490 064,	1987 474 496 <sup>8</sup>
					0986 474 139				→1J..YU260 831, →1J..YW671 283	1987 470 040 <sup>7</sup>
	01.99-02.01	110			0986 473 029		← 41	1987 474 496 <sup>8</sup>		
					0986 474 029				→1J..YU260 831, →1J..YW671 283	1987 474 496 <sup>8</sup>
					0986 473 139				→1J..YD618 886→, 1J..YP490 065→,	1987 470 040 <sup>7</sup>
	06.99-02.01	110	Fg.-Nr. 1J..YB115 041→,	252	0986 473 139		← 38,1	1987 470 040 <sup>7</sup>		
					0986 473 139				1J..YD618 886→, 1J..YP490 065→,	1987 474 496 <sup>8</sup>
					0986 474 139				1J..YU260 832→, 1J..YW671 284→	1987 470 040 <sup>7</sup>
	09.00-05.05	125			0986 473 029		← 41	1987 474 496 <sup>8</sup>		
					0986 474 029				→1J..YU260 831, →1J..YW671 283	1987 474 496 <sup>8</sup>
					0986 473 139				→1J..YD618 885, →1J..YP490 064,	1987 470 040 <sup>7</sup>
2.8 4Motion	05.99-05.99	150	Fg.-Nr. →1J..YB115 040,	252	0986 473 139		← 38,1	1987 470 040 <sup>7</sup>		
					0986 473 139				→1J..YD618 885, →1J..YP490 064,	1987 474 496 <sup>8</sup>
					0986 474 139				→1J..YU260 831, →1J..YW671 283	1987 470 040 <sup>7</sup>
	05.99-05.05	150			0986 473 029		← 41	1987 474 496 <sup>8</sup>		
					0986 474 029				→1J..YU260 831, →1J..YW671 283	1987 474 496 <sup>8</sup>
					0986 473 139				→1J..YD618 886→, 1J..YP490 065→,	1987 470 040 <sup>7</sup>
	06.99-05.00	150	Fg.-Nr. 1J..YB115 041→,	252	0986 473 139		← 38,1	1987 470 040 <sup>7</sup>		
					0986 473 139				1J..YD618 886→, 1J..YP490 065→,	1987 474 496 <sup>8</sup>
					0986 474 139				1J..YU260 832→, 1J..YW671 284→	1987 470 040 <sup>7</sup>
	01.00-05.05	150			0986 473 139		← 38,1	1987 470 040 <sup>7</sup>		
					0986 473 139				→1J..YD618 885, →1J..YP490 064,	1987 474 496 <sup>8</sup>
					0986 474 139				→1J..YU260 831, →1J..YW671 283	1987 470 040 <sup>7</sup>
1.4	09.98-06.99	55	Fg.-Nr. →1J..YW238 580,	232	1987 477 696		↔ 1688			
					→1J..YD128 801, →1J..YP061 677,					
	09.98-05.05	55			252		↔ 1693			
					Fg.-Nr. 1J..YW238 581→,					
	05.00-05.05	55			1987 477 698		↔ 1693			
1J..YD128 802→, 1J..YP061 678→,										
				1J..YU008 823→, 1J..YB019 362→						
1.6	09.98-06.99	74	Fg.-Nr. →1J..YW238 580,	232	1987 477 696		↔ 1688			
					→1J..YD128 801, →1J..YP061 677,					
	09.98-05.05	74			252		↔ 1693			
					Fg.-Nr. 1J..YW238 581→,					
	08.99-05.05	75/77/81			1987 477 698		↔ 1693			
1J..YD128 802→, 1J..YP061 678→,										
				1J..YU008 823→, 1J..YB019 362→						
1.6 FSI	08.01-05.05	75/77/81			1987 477 698		↔ 1693			
1.8	09.98-06.99	92	Fg.-Nr. →1J..YW238 580,	232	1987 477 696		↔ 1688			
					→1J..YD128 801, →1J..YP061 677,					
	09.98-10.00	92			252		↔ 1693			
Fg.-Nr. 1J..YW238 581→,										
				1J..YD128 802→, 1J..YP061 678→,						
				1J..YU008 823→, 1J..YB019 362→						
1.8 T	05.00-05.05	110/132			1987 477 698		↔ 1693			
1.8 4Motion	02.99-10.00	92			1987 477 686		↔ 1723			
1.9 SDI	09.98-06.99	50	Fg.-Nr. →1J..YW238 580,	232	1987 477 696		↔ 1688			
					→1J..YD128 801, →1J..YP061 677,					
	09.98-05.05	50			252		↔ 1693			
Fg.-Nr. 1J..YW238 581→,										
				1J..YD128 802→, 1J..YP061 678→,						
				1J..YU008 823→, 1J..YB019 362→						
1.9 TDI	09.98-06.99	66	Fg.-Nr. →1J..YW238 580,	232	1987 477 696		↔ 1688			
					→1J..YD128 801, →1J..YP061 677,					
		81			1987 477 696		↔ 1688			
					Fg.-Nr. →1J..YW238 580,					
				→1J..YD128 801, →1J..YP061 677,						
				→1J..YU008 822, →1J..YB019 361						

		S								
<b>1.9 TDI</b>	09.98-06.99	85		Fg.-Nr. →1J..YW238 580, 232 →1J..YD128 801, →1J..YP061 677, →1J..YU008 822, →1J..YB019 361			1 987 477 696	↔ 1688		
	09.98-05.01	85		252 Fg.-Nr. 1J..YW238 581→, 232 1J..YD128 802→, 1J..YP061 678→, 1J..YU008 823→, 1J..YB019 362→			1 987 477 698	↔ 1693		
	09.98-05.05	66		252 Fg.-Nr. 1J..YW238 581→, 232 1J..YD128 802→, 1J..YP061 678→, 1J..YU008 823→, 1J..YB019 362→			1 987 477 698	↔ 1693		
		81		252 Fg.-Nr. 1J..YW238 581→, 232 1J..YD128 802→, 1J..YP061 678→, 1J..YU008 823→, 1J..YB019 362→			1 987 477 698	↔ 1693		
	01.00-04.01	85					1 987 477 698	↔ 1693		
	01.00-05.05	74						1 987 477 698	↔ 1693	
		96/110						1 987 477 698	↔ 1693	
	05.00-05.05	81						1 987 477 698	↔ 1693	
	<b>1.9 TDI 4Motion</b>	01.99-05.05	66					1 987 477 686	↔ 1723	
		02.99-04.01	85					1 987 477 686	↔ 1723	
01.00-05.05		74					1 987 477 686	↔ 1723		
09.00-05.05		96/110					1 987 477 686	↔ 1723		
<b>2.0</b>	09.98-06.99	85		Fg.-Nr. →1J..YW238 580, 232 →1J..YD128 801, →1J..YP061 677, →1J..YU008 822, →1J..YB019 361			1 987 477 696	↔ 1688		
	09.98-05.05	85		252 Fg.-Nr. 1J..YW238 581→, 232 1J..YD128 802→, 1J..YP061 678→, 1J..YU008 823→, 1J..YB019 362→			1 987 477 698	↔ 1693		
		04.00-05.05	85					1 987 477 698	↔ 1693	
<b>2.0 4Motion</b>	04.00-05.05	85					1 987 477 686	↔ 1723		
<b>2.3</b>	09.98-06.99	110		Fg.-Nr. →1J..YW238 580, 232 →1J..YD128 801, →1J..YP061 677, →1J..YU008 822, →1J..YB019 361			1 987 477 696	↔ 1688		
	09.98-02.01	110		252 Fg.-Nr. 1J..YW238 581→, 232 1J..YD128 802→, 1J..YP061 678→, 1J..YU008 823→, 1J..YB019 362→			1 987 477 698	↔ 1693		
		09.00-05.05	125					1 987 477 698	↔ 1693	
	<b>2.3 4Motion</b>	01.99-02.01	110					1 987 477 686	↔ 1723	
09.00-05.05		125					1 987 477 686	↔ 1723		
<b>2.8 4Motion</b>	05.99-05.05	150					1 987 477 686	↔ 1723		
<b>1.4</b>	09.98-05.05	55					0 986 594 004 <sup>4</sup>			
						LAB	0 986 594 001 <sup>3</sup>			
<b>1.6</b>	09.98-05.05	74/75/77/					0 986 594 000 <sup>3</sup>			
		81					0 986 594 004 <sup>4</sup>			
<b>1.6 FSI</b>						LAB	0 986 594 001 <sup>3</sup>			
						RAB	0 986 594 000 <sup>3</sup>			
<b>1.8</b>	09.98-10.00	92					0 986 594 004 <sup>4</sup>			
<b>1.8</b>	09.98-10.00	92				LAB	0 986 594 001 <sup>3</sup>			
						RAB	0 986 594 000 <sup>3</sup>			
<b>1.8 4Motion</b>							0 986 594 000 <sup>3</sup>			
<b>1.8 T</b>	05.00-05.05	110/132					0 986 594 004 <sup>4</sup>			
						LAB	0 986 594 001 <sup>3</sup>			
						RAB	0 986 594 000 <sup>3</sup>			
<b>1.8 4Motion</b>	02.99-10.00	92					0 986 594 008 <sup>4</sup>			
<b>1.9 SDI</b>	09.98-05.05	50					0 986 594 004 <sup>4</sup>			
						LAB	0 986 594 001 <sup>3</sup>			
						RAB	0 986 594 000 <sup>3</sup>			
<b>1.9 TDI</b>	09.98-05.05	66/74					0 986 594 004 <sup>4</sup>			
		81					0 986 594 004 <sup>4</sup>			
					LAB	0 986 594 001 <sup>3</sup>				











































		S							
	◀ VW Bora [1J2]								
1.9 TDI		09.98-05.05	81			RAB	0986 594 000 <sup>3</sup>		
			85/96/110				0986 594 004 <sup>4</sup>		
1.9 TDI		09.98-05.05	66/74			LAB	0986 594 001 <sup>3</sup>		
1.9 TDI 4Motion						RAB	0986 594 000 <sup>3</sup>		
			85/96/110			LAB	0986 594 001 <sup>3</sup>		
						RAB	0986 594 000 <sup>3</sup>		
1.9 TDI 4Motion		01.99-05.05	66/74				0986 594 008 <sup>4</sup>		
		02.99-05.05	85/96/110				0986 594 008 <sup>4</sup>		
2.0		09.98-05.05	85				0986 594 004 <sup>4</sup>		
2.0		09.98-05.05	85			LAB	0986 594 001 <sup>3</sup>		
2.0 4Motion						RAB	0986 594 000 <sup>3</sup>		
2.0 4Motion		04.00-05.05	85				0986 594 008 <sup>4</sup>		
2.3		09.98-05.05	110/125				0986 594 004 <sup>4</sup>		
2.3		09.98-05.05	110/125			LAB	0986 594 001 <sup>3</sup>		
2.3 4Motion						RAB	0986 594 000 <sup>3</sup>		
2.3 4Motion		01.99-05.05	110/125				0986 594 008 <sup>4</sup>		
2.8 4Motion		05.99-05.05	150				0986 594 008 <sup>4</sup>		
						LAB	0986 594 001 <sup>3</sup>		
						RAB	0986 594 000 <sup>3</sup>		
<b>Bora [9D, 152]</b>									
	1.8 i	08.01-11.06	92/110			228	0986 473 071	← 54	1987 470 506 <sup>8</sup>
	1.8 i Turbo						0986 474 071	→ 54	1987 470 506 <sup>8</sup>
						288	0986 471 923	← 54	1987 470 506 <sup>8</sup>
							0986 473 923		
							0986 471 924	→ 54	1987 470 506 <sup>8</sup>
							0986 473 924		
	1.8 i	08.01-11.06	92/110				0986 473 029	← 41	1987 474 496 <sup>8</sup>
	1.8 i Turbo						0986 474 029	→ 41	1987 474 496 <sup>8</sup>
	1.8 i	08.01-11.06	92/110				1987 477 698	↔ 1693	
	1.8 i Turbo	08.01-01.06	92/110				1987 477 698	↔ 1693	
	1.8 i	08.01-11.06	92/110				0986 594 004 <sup>4</sup>		
	1.8 i Turbo					LAB	0986 594 001 <sup>3</sup>		
						RAB	0986 594 000 <sup>3</sup>		
<b>Bora [9M2]</b>									
	2.0	09.02-09.12	85				0986 473 071	← 54	1987 470 506 <sup>8</sup>
							0986 474 071	→ 54	1987 470 506 <sup>8</sup>
	2.0	09.02-09.12	85				0986 473 029	← 41	1987 474 496 <sup>8</sup>
							0986 474 029	→ 41	1987 474 496 <sup>8</sup>
	2.0	09.02-09.12	85				1987 477 698	↔ 1693	
	2.0	09.02-09.12	85				0986 594 004 <sup>4</sup>		
						LAB	0986 594 001 <sup>3</sup>		
						RAB	0986 594 000 <sup>3</sup>		

		S							
<b>Caddy Panel Van [2K]</b>									
	1.6	06.04→	75				0 986 473 384		← 53,94 F 026 A06 106 <sup>7</sup>
							0 986 473 384		← 53,94 1 987 470 506 <sup>8</sup>
							0 986 474 384		→ 53,94 F 026 A06 106 <sup>7</sup>
	1.9 TDI	06.04→	77	PR-Code 1ZE, PR-Code 1LJ	288,312		0 986 473 384		← 53,94 F 026 A06 106 <sup>7</sup>
							0 986 473 384		← 53,94 1 987 470 506 <sup>8</sup>
							0 986 474 384		→ 53,94 F 026 A06 106 <sup>7</sup>
				PR-Code 1ZM, PR-Code 1ZF	228		0 986 473 071		← 54 1 987 470 506 <sup>8</sup>
							0 986 474 071		→ 54 1 987 470 506 <sup>8</sup>
	1.6	06.04→	75	Fg.-Nr. > 2K-8-060 000→			0 986 134 049		← 41 1 987 474 496 <sup>8</sup>
							0 986 135 049		→ 41 1 987 474 496 <sup>8</sup>
	1.9 TDI	06.04-11.07	77				0 986 134 049		← 41 1 987 474 496 <sup>8</sup>
							0 986 135 049		→ 41 1 987 474 496 <sup>8</sup>
		12.07→	77	PR-Code 1ZE, PR-Code 1LJ	256		0 986 134 049		← 41 1 987 474 496 <sup>8</sup>
							0 986 135 049		→ 41 1 987 474 496 <sup>8</sup>
				PR-Code 1ZF, PR-Code 1ZM	D53		0 986 134 217		← 1 987 470 040 <sup>7</sup>
							0 986 134 217		← 1 987 474 496 <sup>8</sup>
							0 986 135 217		→ 1 987 470 040 <sup>7</sup>
	1.9 TDI	06.04-04.08	77		FKR		1 987 482 378		↔ 1718
		05.08→	77	PR-Code 2MK	FKR		1 987 482 378		↔ 1718
	1.6	06.04→	75				0 986 594 526 <sup>4</sup>		
						LAB	0 986 594 504 <sup>3</sup>		
						RAB	0 986 594 505 <sup>3</sup>		
	1.9 TDI	06.04→	77				0 986 594 526 <sup>4</sup>		
						LAB	0 986 594 504 <sup>3</sup>		
						RAB	0 986 594 505 <sup>3</sup>		
<b>Caddy Pickup [9U7]</b>									
	1.6	06.96-12.00	55				0 986 473 112		← 53,95 1 987 470 507 <sup>8</sup>
							0 986 474 112		→ 53,95 1 987 470 507 <sup>8</sup>
	1.9 D	06.96-12.00	47				0 986 473 112		← 53,95 1 987 470 507 <sup>8</sup>
							0 986 474 112		→ 53,95 1 987 470 507 <sup>8</sup>
	1.6	ABO 06.96-12.00	55				0 986 475 865		↔ 22,2
	1.9 D	ABO 06.96-12.00	47				0 986 475 865		↔ 22,2
	1.6	06.96-12.00	55				1 987 477 690		1752
	1.9 D	06.96-12.00	47				1 987 477 690		1752
	1.6	06.96-12.00	55				0 986 594 004 <sup>4</sup>		
	1.9 D	06.96-12.00	47				0 986 594 004 <sup>4</sup>		
<b>Caddy [SA]</b>									
	1.2 TSI	05.15→	62						1 987 470 040 <sup>7</sup>
	1.4 TGI, TSI	05.15→	81/92						1 987 470 040 <sup>7</sup>
	1.6 TDI	05.15→	55/75						1 987 470 040 <sup>7</sup>



<b>VW Caddy [SA]</b>								
	2.0 TDI, TDI 4Motion	05.15→	55/75/81/90/103/110					1987 470 040 <sup>7</sup>
	1.2 TSI	05.15→	62		LAB	0986 594 504 <sup>3</sup>		
					RAB	0986 594 505 <sup>3</sup>		
					TW	0986 594 526 <sup>4</sup>		
	1.4 TGI	05.15→	81/92		LAB	0986 594 504 <sup>3</sup>		
	1.4 TSI				RAB	0986 594 505 <sup>3</sup>		
					TW	0986 594 526 <sup>4</sup>		
	1.6 TDI	05.15→	55/75		LAB	0986 594 504 <sup>3</sup>		
					RAB	0986 594 505 <sup>3</sup>		
					TW	0986 594 526 <sup>4</sup>		
	2.0 TDI	05.15→	55/75		LAB	0986 594 504 <sup>3</sup>		
					RAB	0986 594 505 <sup>3</sup>		
					TW	0986 594 526 <sup>4</sup>		
			103		RAB	0986 594 505 <sup>3</sup>		
					TW	0986 594 526 <sup>4</sup>		
			110		LAB	0986 594 504 <sup>3</sup>		
					RAB	0986 594 505 <sup>3</sup>		
					TW	0986 594 526 <sup>4</sup>		
	2.0 TDI, TDI 4Motion	05.15→	103		LAB	0986 594 504 <sup>3</sup>		
	2.0 TDI 4Motion	05.15→	81/90		LAB	0986 594 504 <sup>3</sup>		
						0986 594 524 <sup>4</sup>		
					RAB	0986 594 505 <sup>3</sup>		
						0986 594 525 <sup>4</sup>		
			103		LAB	0986 594 524 <sup>4</sup>		
					RAB	0986 594 505 <sup>3</sup>		
						0986 594 525 <sup>4</sup>		
<b>Caddy [2C]</b>								
	1.2 TSI	09.10→	63/77	PR-Code 1ZA, PR-Code 1ZE	288,312	0986 473 384	← 53,94	F 026 A06 106 <sup>7</sup>
						0986 473 384	← 53,94	1987 470 506 <sup>8</sup>
						0986 474 384	→ 53,94	F 026 A06 106 <sup>7</sup>
				PR-Code 1ZF	228	0986 473 071	← 54	1987 470 506 <sup>8</sup>
						0986 474 071	→ 54	1987 470 506 <sup>8</sup>
	1.6	08.10→	55/72-75	PR-Code 1ZA, PR-Code 1ZE	288,312	0986 473 384	← 53,94	F 026 A06 106 <sup>7</sup>
	1.6 BiFuel					0986 473 384	← 53,94	1987 470 506 <sup>8</sup>
	1.6 TDI					0986 474 384	→ 53,94	F 026 A06 106 <sup>7</sup>
				PR-Code 1ZF	228	0986 473 071	← 54	1987 470 506 <sup>8</sup>
						0986 474 071	→ 54	1987 470 506 <sup>8</sup>
	2.0 EcoFuel	08.10→	80/81/103/125	PR-Code 1ZA, PR-Code 1ZE	288,312	0986 473 384	← 53,94	F 026 A06 106 <sup>7</sup>
	2.0 TDI					0986 473 384	← 53,94	1987 470 506 <sup>8</sup>
	2.0 TDI 4Motion					0986 474 384	→ 53,94	F 026 A06 106 <sup>7</sup>
				PR-Code 1ZF	228	0986 473 071	← 54	1987 470 506 <sup>8</sup>
						0986 474 071	→ 54	1987 470 506 <sup>8</sup>
	1.2 TSI	09.10→	63/77	PR-Code 1ZA, PR-Code 1ZE, PR-Code 1ZF, PR-Code 2E3		0986 134 204	← 38	
						0986 135 204	→ 38	
				PR-Code 1ZF, PR-Code 2E2	D53	0986 134 217	←	1987 470 040 <sup>7</sup>
						0986 134 217	←	1987 474 496 <sup>8</sup>
						0986 135 217	→	1987 470 040 <sup>7</sup>
	1.6	08.10→	55/72-75	PR-Code 1ZA, PR-Code 1ZE, PR-Code 1ZF, PR-Code 2E3		0986 134 204	← 38	
	1.6 BiFuel					0986 135 204	→ 38	
	1.6 TDI			PR-Code 1ZF, PR-Code 2E2	D53	0986 134 217	←	1987 470 040 <sup>7</sup>
						0986 134 217	←	1987 474 496 <sup>8</sup>
						0986 135 217	→	1987 470 040 <sup>7</sup>
	2.0 EcoFuel, TDI, TDI 4Motion	08.10→	80/81	PR-Code 1ZA, PR-Code 1ZE, PR-Code 1ZF, PR-Code 2E3		0986 134 204	← 38	
						0986 135 204	→ 38	

								
2.0 EcoFuel, TDI, TDI 4Motion	08.10→	80/81	PR-Code 1ZF, PR-Code 2E2	D53		0 986 134 217		1 987 470 040 <sup>7</sup>
						0 986 134 217		1 987 474 496 <sup>8</sup>
						0 986 135 217		1 987 470 040 <sup>7</sup>
2.0 TDI	11.10→	103	PR-Code 1ZF, PR-Code 2E2	D53		0 986 134 217		1 987 470 040 <sup>7</sup>
						0 986 135 217		1 987 474 496 <sup>8</sup>
	05.12→	125	PR-Code 1ZA, PR-Code 1ZE, PR-Code 1ZF, PR-Code 2E3 PR-Code 1ZF, PR-Code 2E2	D53		0 986 134 204		38
						0 986 135 204		38
						0 986 134 217		1 987 470 040 <sup>7</sup>
0 986 134 217		1 987 474 496 <sup>8</sup>						
0 986 135 217		1 987 470 040 <sup>7</sup>						
2.0 TDI 2.0 TDI 4Motion	11.10→	103	PR-Code 1ZA, PR-Code 1ZE, PR-Code 1ZF, PR-Code 2E3 PR-Code 1ZF, PR-Code 2E2	D53		0 986 134 204		38
						0 986 135 204		38
2.0 TDI 4Motion	11.10→	103	PR-Code 1ZF, PR-Code 2E2	D53		0 986 134 217		1 987 470 040 <sup>7</sup>
						0 986 134 217		1 987 474 496 <sup>8</sup>
								
	1.2 TSI	09.10→	63/77	PR-Code 2MH	FKR	1 987 482 377		1705
				PR-Code 2MK, PR-Code 1BJ, PR-Code 1BH, PR-Code 1BA	FKR	1 987 482 378		1718
1.6	10.10→	55/72-75	PR-Code 2MH	FKR	1 987 482 377		1705	
			PR-Code 2MK, PR-Code 1BJ, PR-Code 1BH, PR-Code 1BA	FKR	1 987 482 378		1718	
1.6 BiFuel	05.11→	55/72-75	PR-Code 2MH	FKR	1 987 482 377		1705	
			PR-Code 2MK, PR-Code 1BJ, PR-Code 1BH, PR-Code 1BA	FKR	1 987 482 378		1718	
1.6 TDI	08.10→	55/72-75	PR-Code 2MH	FKR	1 987 482 377		1705	
			PR-Code 2MK, PR-Code 1BJ, PR-Code 1BH, PR-Code 1BA	FKR	1 987 482 378		1718	
2.0 EcoFuel	10.10→	80	PR-Code 2MH	FKR	1 987 482 377		1705	
			PR-Code 2MK, PR-Code 1BJ, PR-Code 1BH, PR-Code 1BA	FKR	1 987 482 378		1718	
2.0 TDI	08.10→	81/103	PR-Code 2MH	FKR	1 987 482 377		1705	
			PR-Code 2MK, PR-Code 1BJ, PR-Code 1BH, PR-Code 1BA	FKR	1 987 482 378		1718	
	05.12→	125	PR-Code 2MH	FKR	1 987 482 377		1705	
			PR-Code 2MK, PR-Code 1BJ, PR-Code 1BH, PR-Code 1BA	FKR	1 987 482 378		1718	
2.0 TDI 4Motion	08.10-03.13	81/103		FKR	1 987 482 328		1615	
	1.2 TSI	09.10→	63/77		FPA	0 986 594 526 <sup>4</sup>		
					LAB	0 986 594 504 <sup>3</sup>		
					RAB	0 986 594 505 <sup>3</sup>		
1.6 1.6 BiFuel 1.6 TDI	08.10→	55/72-75		FPA	0 986 594 526 <sup>4</sup>			
				LAB	0 986 594 504 <sup>3</sup>			
				RAB	0 986 594 505 <sup>3</sup>			
2.0 EcoFuel	10.10→	80		FPA	0 986 594 526 <sup>4</sup>			
				LAB	0 986 594 504 <sup>3</sup>			
				RAB	0 986 594 505 <sup>3</sup>			
2.0 TDI	08.10→	81/103		FPA	0 986 594 526 <sup>4</sup>			
				LAB	0 986 594 504 <sup>3</sup>			
				RAB	0 986 594 505 <sup>3</sup>			
	05.12→	125		FPA	0 986 594 526 <sup>4</sup>			
				LAB	0 986 594 504 <sup>3</sup>			
				RAB	0 986 594 505 <sup>3</sup>			
2.0 TDI 4Motion	08.10→	81/103		FPA,LAB	0 986 594 524 <sup>4</sup>			
				FPA,RAB	0 986 594 525 <sup>4</sup>			
				FPA,LAB	0 986 594 504 <sup>4</sup>			
				FPA,RAB	0 986 594 505 <sup>4</sup>			
				LAB	0 986 594 504 <sup>3</sup>			
				RAB	0 986 594 505 <sup>3</sup>			





		S									
◀ VW											
<b>Caddy [2K]</b>											
	1.4	02.04-05.06	55			228	0986 473 071		← 54	1987 470 506 <sup>8</sup>	
							0986 474 071		→ 54	1987 470 506 <sup>8</sup>	
							288	0986 473 384		← 53,94	F 026 A06 106 <sup>7</sup>
								0986 473 384		← 53,94	1987 470 506 <sup>8</sup>
								0986 474 384		→ 53,94	F 026 A06 106 <sup>7</sup>
								0986 473 384		← 53,94	F 026 A06 106 <sup>7</sup>
			05.06-08.10	59	PR-Code 1ZE, PR-Code 1LJ	288,312	0986 473 384		← 53,94	F 026 A06 106 <sup>7</sup>	1987 470 506 <sup>8</sup>
							0986 473 384		← 53,94	1987 470 506 <sup>8</sup>	
					PR-Code 1ZM, PR-Code 1ZF	228	0986 473 071		← 54	1987 470 506 <sup>8</sup>	
							0986 474 071		→ 54	1987 470 506 <sup>8</sup>	
			1.6	04.04-05.05	75		288	0986 474 384		→ 53,94	1987 470 506 <sup>8</sup>
								0986 473 071		← 54	1987 470 506 <sup>8</sup>
				04.04→	75		228	0986 473 071		← 54	1987 470 506 <sup>8</sup>
							288	0986 474 071		→ 54	1987 470 506 <sup>8</sup>
							288	0986 473 384		← 53,94	F 026 A06 106 <sup>7</sup>
							288	0986 474 384		→ 53,94	F 026 A06 106 <sup>7</sup>
		06.04→	75		288	0986 473 384		← 53,94	1987 470 506 <sup>8</sup>		
		06.05-08.10	75	PR-Code 1ZE, PR-Code 1LJ	288,312	0986 473 384		← 53,94	F 026 A06 106 <sup>7</sup>		
							0986 473 384		← 53,94	1987 470 506 <sup>8</sup>	
					288	0986 474 384		→ 53,94	F 026 A06 106 <sup>7</sup>		
	1.9 TDI 1.9 TDI 4Motion	02.04-08.10	55/77	PR-Code 1ZE, PR-Code 1LJ	288,312	0986 473 384		← 53,94	F 026 A06 106 <sup>7</sup>		
							0986 473 384		← 53,94	1987 470 506 <sup>8</sup>	
							0986 474 384		→ 53,94	F 026 A06 106 <sup>7</sup>	
							PR-Code 1ZM, PR-Code 1ZF	228	0986 473 071		← 54
					228	0986 474 071		→ 54	1987 470 506 <sup>8</sup>		
	2.0 EcoFuel 2.0 SDI 2.0 TDI	02.04-08.10	51/80/103	PR-Code 1ZE, PR-Code 1LJ	288,312	0986 473 384		← 53,94	F 026 A06 106 <sup>7</sup>		
							0986 473 384		← 53,94	1987 470 506 <sup>8</sup>	
							0986 474 384		→ 53,94	F 026 A06 106 <sup>7</sup>	
							PR-Code 1ZM, PR-Code 1ZF	228	0986 473 071		← 54
					228	0986 474 071		→ 54	1987 470 506 <sup>8</sup>		

	1.4	02.04-05.06	55			256	0986 134 049		← 41	1987 474 496 <sup>8</sup>			
									0986 135 049		→ 41	1987 474 496 <sup>8</sup>	
								05.06-11.07	59			256	0986 134 049
				0986 135 049		→ 41	1987 474 496 <sup>8</sup>						
				12.07-08.10	59	PR-Code 1ZE, PR-Code 1LJ	256	0986 134 049		← 41	1987 474 496 <sup>8</sup>		
									0986 135 049		→ 41	1987 474 496 <sup>8</sup>	
						PR-Code 1ZF, PR-Code 1ZM	D53	0986 134 217		←	1987 470 040 <sup>7</sup>		
							D53	0986 134 217		←	1987 474 496 <sup>8</sup>		
							D53	0986 135 217		→	1987 470 040 <sup>7</sup>		
			1.6	04.04-11.07	75			256	0986 134 049		← 41	1987 474 496 <sup>8</sup>	
										0986 135 049		→ 41	1987 474 496 <sup>8</sup>
					06.04→	75	Fg.-Nr. > 2K-8-060 000→		256	0986 134 049		← 41	1987 474 496 <sup>8</sup>
											0986 135 049		→ 41
							Fg.-Nr. 2K..5..000 001→		256	0986 134 049		← 41	1987 474 496 <sup>8</sup>
									256	0986 135 049		→ 41	1987 474 496 <sup>8</sup>
				12.07-08.10	75	PR-Code 1ZE, PR-Code 1LJ	256	0986 134 049		← 41	1987 474 496 <sup>8</sup>		
			0986 135 049						→ 41	1987 474 496 <sup>8</sup>			
				PR-Code 1ZF, PR-Code 1ZM	D53	0986 134 217		←	1987 470 040 <sup>7</sup>				
					D53	0986 134 217		←	1987 474 496 <sup>8</sup>				
					D53	0986 135 217		→	1987 470 040 <sup>7</sup>				
	1.9 TDI	02.04-11.07	55/77			256	0986 134 049		← 41	1987 474 496 <sup>8</sup>			
									0986 135 049		→ 41	1987 474 496 <sup>8</sup>	
		12.07-08.10	55/77	PR-Code 1ZE, PR-Code 1LJ	256	0986 134 049		← 41	1987 474 496 <sup>8</sup>				
								0986 135 049		→ 41	1987 474 496 <sup>8</sup>		
	1.9 TDI 1.9 TDI 4Motion	12.07-08.10	55/77	PR-Code 1ZF, PR-Code 1ZM	D53	0986 134 217		←	1987 470 040 <sup>7</sup>				
								0986 134 217		←	1987 474 496 <sup>8</sup>		
					D53	0986 135 217		→	1987 470 040 <sup>7</sup>				

	<b>S</b>								
<b>1.9 TDI 4Motion</b>	11.08-08.10	55/77	PR-Code 1ZE, PR-Code 1LJ	256	0 986 <b>134 049</b>		41	1 987 <b>474 496<sup>B</sup></b>	
					0 986 <b>135 049</b>		41	1 987 <b>474 496<sup>B</sup></b>	
<b>2.0 EcoFuel</b>	02.04-11.07	51/80/103			0 986 <b>134 049</b>		41	1 987 <b>474 496<sup>B</sup></b>	
<b>2.0 SDI</b>					0 986 <b>135 049</b>		41	1 987 <b>474 496<sup>B</sup></b>	
<b>2.0 TDI</b>	12.07-08.10	51/80/103	PR-Code 1ZE, PR-Code 1LJ	256	0 986 <b>134 049</b>		41	1 987 <b>474 496<sup>B</sup></b>	
					0 986 <b>135 049</b>		41	1 987 <b>474 496<sup>B</sup></b>	
			PR-Code 1ZF, PR-Code 1ZM	D53	0 986 <b>134 217</b>			1 987 <b>470 040<sup>7</sup></b>	
					0 986 <b>134 217</b>			1 987 <b>474 496<sup>B</sup></b>	
					0 986 <b>135 217</b>			1 987 <b>470 040<sup>7</sup></b>	

	<b>1.4</b>	02.04-05.06	55		FKR	1 987 <b>482 378</b>		1718
		05.06-04.08	59		FKR	1 987 <b>482 378</b>		1718
		05.08-08.10	59	PR-Code 2MK	FKR	1 987 <b>482 378</b>		1718
	<b>1.6</b>	04.04→	75		FKR	1 987 <b>482 378</b>		1718
	<b>1.9 TDI</b>	02.04-04.08	77		FKR	1 987 <b>482 378</b>		1718
		09.05-04.08	55		FKR	1 987 <b>482 378</b>		1718
		05.08-08.10	55	PR-Code 2MK	FKR	1 987 <b>482 378</b>		1718
			77	PR-Code 2MK	FKR	1 987 <b>482 378</b>		1718
	<b>1.9 TDI 4Motion</b>	11.08-08.10	77			1 987 <b>482 328</b>		1615
	<b>2.0 EcoFuel</b>	04.06-04.08	51/80/103		FKR	1 987 <b>482 378</b>		1718
		05.08-08.10	51/80/103	PR-Code 2MK	FKR	1 987 <b>482 378</b>		1718
	<b>2.0 SDI</b>	02.04-04.08	51/80/103		FKR	1 987 <b>482 378</b>		1718
		05.08-08.10	51/80/103	PR-Code 2MK	FKR	1 987 <b>482 378</b>		1718
	<b>2.0 TDI</b>	09.07-04.08	51/80/103		FKR	1 987 <b>482 378</b>		1718
		05.08-08.10	51/80/103	PR-Code 2MK	FKR	1 987 <b>482 378</b>		1718

	<b>1.4</b>	02.04-08.10	55/59			0 986 <b>594 526<sup>4</sup></b>		
					LAB	0 986 <b>594 504<sup>3</sup></b>		
					RAB	0 986 <b>594 505<sup>3</sup></b>		
	<b>1.6</b>	04.04→	75			0 986 <b>594 526<sup>4</sup></b>		
					LAB	0 986 <b>594 504<sup>3</sup></b>		
					RAB	0 986 <b>594 505<sup>3</sup></b>		
	<b>1.9 TDI</b>	02.04-08.10	77			0 986 <b>594 526<sup>4</sup></b>		
					LAB	0 986 <b>594 504<sup>3</sup></b>		
					RAB	0 986 <b>594 505<sup>3</sup></b>		
		09.05-08.10	55			0 986 <b>594 526<sup>4</sup></b>		
					LAB	0 986 <b>594 504<sup>3</sup></b>		
					RAB	0 986 <b>594 505<sup>3</sup></b>		
	<b>1.9 TDI 4Motion</b>	11.08-08.10	77		LAB	0 986 <b>594 504</b>		
					RAB	0 986 <b>594 505</b>		
	<b>2.0 EcoFuel</b>	02.04-08.10	51/80/103			0 986 <b>594 526<sup>4</sup></b>		
	<b>2.0 SDI</b>				LAB	0 986 <b>594 504<sup>3</sup></b>		
	<b>2.0 TDI</b>				RAB	0 986 <b>594 505<sup>3</sup></b>		

**Caddy [9K9]**

	<b>1.4</b>	11.95-06.03	44/55			0 986 <b>471 669</b>		54
						0 986 <b>473 669</b>		54
						0 986 <b>472 669</b>		54
						0 986 <b>474 669</b>		54
	<b>1.6</b>	11.95-09.00	55			0 986 <b>471 669</b>		54
						0 986 <b>473 669</b>		54
						0 986 <b>472 669</b>		54
						0 986 <b>474 669</b>		54
	<b>1.7 SDI</b>	07.96-09.00	42			0 986 <b>471 669</b>		54
						0 986 <b>473 669</b>		54
						0 986 <b>472 669</b>		54
						0 986 <b>474 669</b>		54



		S							
<b>VW Caddy [9K9]</b>									
	1.8	09.02-09.05	66				0986 471 669	← 54	1987 470 287 <sup>7</sup>
							0986 473 669		1987 474 496 <sup>8</sup>
							0986 472 669	→ 54	1987 470 287 <sup>7</sup>
							0986 474 669		
	1.9 D	11.95-06.03	47-66				0986 471 669	← 54	1987 470 287 <sup>7</sup>
	1.9 SDI						0986 473 669		1987 474 496 <sup>8</sup>
	1.9 TDI						0986 472 669	→ 54	1987 470 287 <sup>7</sup>
							0986 474 669		
	1.4	11.95-06.03	44/55				0986 475 039	↔ 20,64	
	1.6	11.95-09.00	55				0986 475 039	↔ 20,64	
	1.7 SDI	07.96-09.00	42				0986 475 039	↔ 20,64	
	1.8	09.02-09.05	66				0986 475 039	↔ 20,64	
	1.9 D, SDI, TDI	11.95-06.03	47-66				0986 475 039	↔ 20,64	
	1.4	11.95-06.03	44/55				1987 477 626	↔ 1671	
	1.6	11.95-09.00	55				1987 477 626	↔ 1671	
	1.7 SDI	07.96-09.00	42				1987 477 626	↔ 1671	
	1.8	09.02-09.05	66				1987 477 626	↔ 1671	
	1.9 D	11.95-06.03	47-66				1987 477 626	↔ 1671	
	1.9 SDI	11.95-06.03	47-66				1987 477 626	↔ 1671	
	1.9 TDI	10.96-06.03	47-66				1987 477 626	↔ 1671	
	1.4	11.95-06.03	44/55			LAB	0986 594 001 <sup>3</sup>		
						RAB	0986 594 000 <sup>3</sup>		
	1.6	11.95-09.00	55			LAB	0986 594 001 <sup>3</sup>		
						RAB	0986 594 000 <sup>3</sup>		
	1.7 SDI	07.96-09.00	42			LAB	0986 594 001 <sup>3</sup>		
						RAB	0986 594 000 <sup>3</sup>		
	1.9 D, SDI, TDI	11.95-06.03	47-66			LAB	0986 594 001 <sup>3</sup>		
						RAB	0986 594 000 <sup>3</sup>		
<b>California T4 [70, 7D]</b>									
	1.9 D	09.90-06.03	45/50			281	0986 473 177		← 53,94 1987 474 496 <sup>8</sup>
	1.9 D Turbo						0986 474 177		→ 53,94 1987 474 496 <sup>8</sup>
		01.96-06.03	45/50	Fg.-Nr. 70..T..200 001→, PR-Code LU		284 ATE	0986 473 361		← 56,93 1987 470 005 <sup>7</sup>
							0986 473 361		← 56,93 1987 470 506 <sup>8</sup>
							0986 474 361		→ 56,93 1987 470 005 <sup>7</sup>
				Fg.-Nr. 70..T..200 001→, PR-Code 1LE		284 LUC	0986 473 806		← 54
							0986 473 807		→ 54
	2.0	09.90-06.03	62			281	0986 473 177		← 53,94 1987 474 496 <sup>8</sup>
							0986 474 177		→ 53,94 1987 474 496 <sup>8</sup>
		01.96-06.03	62	Fg.-Nr. 70..T..200 001→, PR-Code LU		284 ATE	0986 473 361		← 56,93 1987 470 005 <sup>7</sup>
							0986 473 361		← 56,93 1987 470 506 <sup>8</sup>
							0986 474 361		→ 56,93 1987 470 005 <sup>7</sup>
				Fg.-Nr. 70..T..200 001→, PR-Code 1LE		284 LUC	0986 473 806		← 54
							0986 473 807		→ 54
	2.4 D	09.90-05.98	57			281	0986 473 177		← 53,94 1987 474 496 <sup>8</sup>
							0986 474 177		→ 53,94 1987 474 496 <sup>8</sup>
		01.96-05.98	57	Fg.-Nr. 70..T..200 001→, PR-Code LU		284 ATE	0986 473 361		← 56,93 1987 470 005 <sup>7</sup>
							0986 473 361		← 56,93 1987 470 506 <sup>8</sup>
							0986 474 361		→ 56,93 1987 470 005 <sup>7</sup>
				Fg.-Nr. 70..T..200 001→, PR-Code 1LE		284 LUC	0986 473 806		← 54
							0986 473 807		→ 54
		05.97-06.03	55			281	0986 473 177		← 53,94 1987 474 496 <sup>8</sup>
							0986 474 177		→ 53,94 1987 474 496 <sup>8</sup>
				PR-Code 1LE		284 LUC	0986 473 806		← 54
							0986 473 807		→ 54

		S											
2.4D	05.97-06.03	55	PR-Code 1LU	284	ATE	0 986 473 361		← 56,93	1 987 470 005 <sup>7</sup>				
						0 986 473 361		← 56,93	1 987 470 506 <sup>8</sup>				
						0 986 474 361		→ 56,93	1 987 470 005 <sup>7</sup>				
2.4D Syncro	11.92-12.95	57	Fg.-Nr. →70..T..199 000			0 986 473 177		← 53,94	1 987 474 496 <sup>8</sup>				
	01.96-09.98	57	Fg.-Nr. 70..T..200 001→			0 986 474 177		→ 53,94	1 987 474 496 <sup>8</sup>				
2.5	07.94-10.96	81				0 986 473 806		← 54					
						0 986 473 807		→ 54					
	08.96-06.03	81			281		0 986 473 177		← 53,94	1 987 474 496 <sup>8</sup>			
							0 986 474 177		→ 53,94	1 987 474 496 <sup>8</sup>			
							PR-Code 1LE			0 986 473 806		← 54	
										0 986 473 807		→ 54	
					284	ATE	0 986 473 361		← 56,93	1 987 470 005 <sup>7</sup>			
							0 986 473 361		← 56,93	1 987 470 506 <sup>8</sup>			
							0 986 474 361		→ 56,93	1 987 470 005 <sup>7</sup>			
							PR-Code 1LE			0 986 473 806		← 54	
										0 986 473 807		→ 54	
										0 986 473 361		← 56,93	1 987 470 005 <sup>7</sup>
							0 986 473 361		← 56,93	1 987 470 506 <sup>8</sup>			
							0 986 474 361		→ 56,93	1 987 470 005 <sup>7</sup>			
	05.99-12.99	85	PR-Code 1LU	284			0 986 474 361		→ 56,93	1 987 470 506 <sup>8</sup>			
	05.99-06.03	85	PR-Code 1LB	1KX			0 986 473 184		← 57				
							0 986 474 184		→ 57				
										0 986 473 259		← 57	1 987 470 005 <sup>7</sup>
										0 986 474 259		→ 57	1 987 470 005 <sup>7</sup>
					284	PR-Code 1LE	0 986 473 806		← 54				
										0 986 473 807		→ 54	
									0 986 473 361		← 56,93	1 987 470 005 <sup>7</sup>	
									0 986 473 361		← 56,93	1 987 470 506 <sup>8</sup>	
12.99-06.03	85	PR-Code 1LU	284			0 986 474 361		→ 56,93	1 987 470 005 <sup>7</sup>				
2.5, Syncro	08.96-06.03	85	PR-Code 1LP	281					1 987 474 496 <sup>8</sup>				
2.5 Syncro	01.94-12.95	81	Fg.-Nr. →70..T..199 000			0 986 473 177		← 53,94	1 987 474 496 <sup>8</sup>				
						0 986 474 177		→ 53,94	1 987 474 496 <sup>8</sup>				
	01.96-10.96	81	Fg.-Nr. 70..T..200 001→						1 987 474 496 <sup>8</sup>				
	08.96-05.00	85	Fg.-Nr. →70..1..000 954, PR-Code 1LB	326		0 986 473 259		← 57	1 987 470 005 <sup>7</sup>				
						0 986 474 259		→ 57	1 987 470 005 <sup>7</sup>				
	08.96-06.03	85	PR-Code 1LE	284	LUC	0 986 473 806		← 54					
									0 986 473 807		→ 54		
									0 986 473 361		← 56,93	1 987 470 005 <sup>7</sup>	
									0 986 473 361		← 56,93	1 987 470 506 <sup>8</sup>	
						0 986 474 361		→ 56,93	1 987 470 005 <sup>7</sup>				
	06.97-11.01	81	PR-Code 1LE		LUC	0 986 473 806		← 54					
									0 986 473 807		→ 54		
									0 986 473 361		← 56,93	1 987 470 005 <sup>7</sup>	
									0 986 473 361		← 56,93	1 987 470 506 <sup>8</sup>	
						0 986 474 361		→ 56,93	1 987 470 005 <sup>7</sup>				
	05.99-12.99	85	PR-Code 1LB	326		0 986 473 259		← 57	1 987 470 005 <sup>7</sup>				
						0 986 474 259		→ 57	1 987 470 005 <sup>7</sup>				
									0 986 473 184		← 57		
									0 986 474 184		→ 57		
2.5 TDI	01.95-06.03	75		281		0 986 473 177		← 53,94	1 987 474 496 <sup>8</sup>				
						0 986 474 177		→ 53,94	1 987 474 496 <sup>8</sup>				
	05.98-05.00	111	Fg.-Nr. →70..1..000 954, PR-Code 1LB	326			0 986 473 259		← 57	1 987 470 005 <sup>7</sup>			
							0 986 474 259		→ 57	1 987 470 005 <sup>7</sup>			
	05.98-06.03	65			281		0 986 473 177		← 53,94	1 987 474 496 <sup>8</sup>			
							0 986 474 177		→ 53,94	1 987 474 496 <sup>8</sup>			
							PR-Code 1LE			0 986 473 806		← 54	
										0 986 473 807		→ 54	
					284	ATE	0 986 473 361		← 56,93	1 987 470 005 <sup>7</sup>			
							0 986 473 361		← 56,93	1 987 470 506 <sup>8</sup>			
							0 986 474 361		→ 56,93	1 987 470 005 <sup>7</sup>			
							PR-Code 1LE			0 986 473 806		← 54	
						0 986 473 807		→ 54					
111	PR-Code 1LE	284	LUC	0 986 473 806		← 54							
				0 986 473 807		→ 54							



		S							
<b>VW California T4 [70, 7D]</b>									
2.5 TDI	05.98-06.03	111	PR-Code 1LU	284	ATE	0986 473 361		← 56,93	1987 470 005 <sup>7</sup>
						0986 473 361		← 56,93	1987 470 506 <sup>8</sup>
						0986 474 361		→ 56,93	1987 470 005 <sup>7</sup>
2.5 TDI Syncro	03.98-06.03	75	PR-Code 1LB	1KX	0986 473 184		← 57		
					0986 474 184		→ 57		
2.5 TDI	01.95-06.03	75	PR-Code 1LE	284	LUC	0986 473 806		← 54	
						0986 473 807		→ 54	
2.5 TDI Syncro	01.95-06.03	75	PR-Code 1LU	284	ATE	0986 473 361		← 56,93	1987 470 005 <sup>7</sup>
						0986 473 361		← 56,93	1987 470 506 <sup>8</sup>
						0986 474 361		→ 56,93	1987 470 005 <sup>7</sup>
2.8	05.96-05.00	103	PR-Code 1LB	326	LUC	0986 473 259		← 57	1987 470 005 <sup>7</sup>
						0986 474 259		→ 57	1987 470 005 <sup>7</sup>
						0986 473 806		← 54	
2.8	05.00-06.03	150	PR-Code 1LU	284	ATE	0986 473 361		← 56,93	1987 470 005 <sup>7</sup>
						0986 473 361		← 56,93	1987 470 506 <sup>8</sup>
						0986 474 361		→ 56,93	1987 470 005 <sup>7</sup>
1.9 D	09.90-04.97	45	Fg.-Nr. →70..T..199 000			0986 475 935		↔ 20,64	
						0986 475 935		↔ 20,64	
						0986 475 935		↔ 20,64	
2.0	09.90-12.95	62	Fg.-Nr. →70..T..199 000			0986 475 935		↔ 20,64	
						0986 475 935		↔ 20,64	
						0986 475 935		↔ 20,64	
2.5	07.94-12.95	81	Fg.-Nr. →70..T..199 000			0986 475 935		↔ 20,64	
						0986 475 935		↔ 20,64	
						0986 475 935		↔ 20,64	
2.5 Syncro	01.94-12.95	81	Fg.-Nr. →70..T..199 000			0986 475 935		↔ 20,64	
						0986 475 935		↔ 20,64	
						0986 475 935		↔ 20,64	
2.5 TDI	01.95-12.95	75	Fg.-Nr. →70..T..199 000			0986 475 935		↔ 20,64	
						0986 475 935		↔ 20,64	
						0986 475 935		↔ 20,64	
1.9 D Turbo	01.96-06.03	50	Fg.-Nr. 70..T..200 001→			0986 473 073		← 38	1987 470 040 <sup>7</sup>
						0986 473 073		← 38	1987 474 496 <sup>8</sup>
						0986 474 073		→ 38	1987 470 040 <sup>7</sup>
2.0	01.96-06.03	62	Fg.-Nr. 70..T..200 001→			0986 473 073		← 38	1987 470 040 <sup>7</sup>
						0986 473 073		← 38	1987 474 496 <sup>8</sup>
						0986 474 073		→ 38	1987 470 040 <sup>7</sup>
2.4 D	05.97-06.03	55				0986 473 073		← 38	1987 470 040 <sup>7</sup>
						0986 473 073		← 38	1987 474 496 <sup>8</sup>
						0986 474 073		→ 38	1987 470 040 <sup>7</sup>
2.4 D Syncro	01.96-09.98	57	Fg.-Nr. 70..T..200 001→			0986 473 073		← 38	1987 470 040 <sup>7</sup>
						0986 473 073		← 38	1987 474 496 <sup>8</sup>
						0986 474 073		→ 38	1987 470 040 <sup>7</sup>
2.5	01.96-10.96	81	Fg.-Nr. 70..T..200 001→			0986 473 073		← 38	1987 470 040 <sup>7</sup>
						0986 473 073		← 38	1987 474 496 <sup>8</sup>
						0986 474 073		→ 38	1987 474 496 <sup>8</sup>
2.5	08.96-06.03	81				0986 473 073		← 38	1987 470 040 <sup>7</sup>
						0986 473 073		← 38	1987 474 496 <sup>8</sup>
						0986 474 073		→ 38	1987 474 496 <sup>8</sup>
2.5 Syncro	08.96-06.03	85/111				0986 473 073		← 38	1987 470 040 <sup>7</sup>
						0986 473 073		← 38	1987 474 496 <sup>8</sup>
						0986 474 073		→ 38	1987 470 040 <sup>7</sup>
2.5 TDI	01.96-10.96	81	Fg.-Nr. 70..T..200 001→			0986 473 073		← 38	1987 470 040 <sup>7</sup>
						0986 473 073		← 38	1987 474 496 <sup>8</sup>
						0986 474 073		→ 38	1987 470 040 <sup>7</sup>
2.5 Syncro	06.97-11.01	81				0986 473 073		← 38	1987 470 040 <sup>7</sup>
						0986 473 073		← 38	1987 474 496 <sup>8</sup>
						0986 474 073		→ 38	1987 474 496 <sup>8</sup>

			S								
2.5 TDI	01.96-06.03	75	Fg.-Nr. 70..T..200 001→	0 986 473 073		← 38	1 987 470 040 <sup>7</sup>				
				0 986 473 073		← 38	1 987 474 496 <sup>8</sup>				
				0 986 474 073		→ 38	1 987 470 040 <sup>7</sup>				
	05.98-06.03	65		0 986 473 073		← 38	1 987 470 040 <sup>7</sup>				
				0 986 473 073		← 38	1 987 474 496 <sup>8</sup>				
				0 986 474 073		→ 38	1 987 470 040 <sup>7</sup>				
	05.99-06.03	75		0 986 473 073		← 38	1 987 470 040 <sup>7</sup>				
				0 986 473 073		← 38	1 987 474 496 <sup>8</sup>				
				0 986 474 073		→ 38	1 987 470 040 <sup>7</sup>				
2.5 TDI Syncro	03.98-06.03	75		0 986 473 073		← 38	1 987 470 040 <sup>7</sup>				
				0 986 473 073		← 38	1 987 474 496 <sup>8</sup>				
				0 986 474 073		→ 38	1 987 470 040 <sup>7</sup>				
2.8	05.96-06.03	103/150		0 986 473 073		← 38	1 987 470 040 <sup>7</sup>				
				0 986 473 073		← 38	1 987 474 496 <sup>8</sup>				
				0 986 474 073		→ 38	1 987 470 040 <sup>7</sup>				
<hr/>											
	1.9 D	09.90-04.97	45						1 987 477 171		↔ 844
	1.9 D Turbo	10.92-12.95	50	Fg.-Nr. →70..T..199 000	TBR				1 987 477 171		↔ 844
		01.96-02.97	50	Fg.-Nr. 70..T..200 001→	SBR				1 987 477 706		↔ 949
				70..V..120 000							
2.0		03.97-06.03	50	Fg.-Nr. 70..V..120 001→	SBR				1 987 477 707		↔ 953
		09.90-12.95	62	Fg.-Nr. →70..T..199 000	TBR				1 987 477 171		↔ 844
		01.96-02.97	62	Fg.-Nr. 70..T..200 001→	SBR				1 987 477 706		↔ 949
				70..V..120 000							
2.4 D		03.97-06.03	62	Fg.-Nr. 70..V..120 001→	SBR				1 987 477 707		↔ 953
		09.90-12.95	57	Fg.-Nr. →70..T..199 000	TBR				1 987 477 171		↔ 844
		01.96-02.97	57	Fg.-Nr. 70..T..200 001→	SBR				1 987 477 706		↔ 949
				70..V..120 000							
2.4 D Syncro		03.97-05.98	57	Fg.-Nr. 70..V..120 001→	SBR				1 987 477 707		↔ 953
		05.97-06.03	55						1 987 477 707		↔ 953
		11.92-12.95	57	Fg.-Nr. →70..T..199 000	TBR				1 987 477 171		↔ 844
2.5		01.96-09.98	57	Fg.-Nr. 70..T..200 001→	SBR				1 987 477 706		↔ 949
		07.94-12.95	81	Fg.-Nr. →70..T..199 000	TBR				1 987 477 171		↔ 844
		09.95-12.95	81						1 987 477 171		↔ 844
2.5 Syncro		01.96-10.96	81	Fg.-Nr. 70..T..200 001→	SBR				1 987 477 706		↔ 949
		08.96-02.97	85	Fg.-Nr. →70..V..120 000					1 987 477 706		↔ 949
		03.97-06.03	85	Fg.-Nr. →70..V..120 000	SBR				1 987 477 706		↔ 949
		03.97-06.03	81	Fg.-Nr. 70..V..120 001→					1 987 477 707		↔ 953
			85	Fg.-Nr. 70..V..120 001→	SBR				1 987 477 707		↔ 953
		05.99-12.99	85						1 987 477 707		↔ 953
		12.99-06.03	85		SBR				1 987 477 707		↔ 953
					TBR				1 987 477 171		↔ 844
		01.94-12.95	81	Fg.-Nr. →70..T..199 000	TBR				1 987 477 171		↔ 844
		01.96-10.96	81	Fg.-Nr. 70..T..200 001→	SBR				1 987 477 706		↔ 949
		08.96-02.97	85	Fg.-Nr. →70..V..120 000					1 987 477 706		↔ 949
2.5 TDI		03.97-06.03	85	Fg.-Nr. 70..V..120 001→					1 987 477 707		↔ 953
		06.97-11.01	81						1 987 477 706		↔ 949
		05.99-06.03	85						1 987 477 707		↔ 953
		01.95-02.97	75	Fg.-Nr. →70..V..120 000	SBR				1 987 477 706		↔ 949
		01.95-06.03	75		TBR				1 987 477 171		↔ 844
		03.97-06.03	75	Fg.-Nr. 70..V..120 001→	SBR				1 987 477 707		↔ 953
		05.98-06.03	65		SBR				1 987 477 707		↔ 953
					TBR				1 987 477 171		↔ 844
			111		SBR				1 987 477 707		↔ 953
					TBR				1 987 477 171		↔ 844
		05.99-06.03	75		SBR				1 987 477 707		↔ 953
2.5 TDI Syncro	03.98-06.03	75						1 987 477 707		↔ 953	
2.8	05.96-02.97	103	Fg.-Nr. →70..V..120 000	SBR					1 987 477 706		↔ 949
	05.96-05.00	103		TBR					1 987 477 171		↔ 844
	03.97-05.00	103	Fg.-Nr. 70..V..120 001→	SBR					1 987 477 707		↔ 953
	05.00-06.03	150							1 987 477 707		↔ 953





◀ VW California T4 [70, 7D]

	1.9 D	09.90-12.95	45/50	Fg.-Nr. →70..T..199 000	MVB	0 986 594 013 <sup>4</sup>	
	1.9 D Turbo	09.90-06.03	45/50			0 265 006 407 <sup>3</sup>	
					LAB,MVB	0 265 006 508 <sup>4</sup>	
					MVB,RAB	0 265 006 510 <sup>4</sup>	
		01.96-06.03	45/50	Fg.-Nr. 70..T..200 001→	LAB,MVB	0 265 006 408 <sup>4</sup>	
					MVB,RAB	0 265 006 409 <sup>4</sup>	
	2.0	09.90-12.95	62	Fg.-Nr. →70..T..199 000	MVB	0 986 594 013 <sup>4</sup>	
		09.90-06.03	62			0 265 006 407 <sup>3</sup>	
					LAB,MVB	0 265 006 508 <sup>4</sup>	
					MVB,RAB	0 265 006 510 <sup>4</sup>	
		01.96-06.03	62	Fg.-Nr. 70..T..200 001→	LAB,MVB	0 265 006 408 <sup>4</sup>	
					MVB,RAB	0 265 006 409 <sup>4</sup>	
	2.4 D	05.97-06.03	55			0 265 006 407 <sup>3</sup>	
					LAB,MVB	0 265 006 508 <sup>4</sup>	
					LAB,MVB	0 265 006 408 <sup>4</sup>	
					MVB,RAB	0 265 006 510 <sup>4</sup>	
					MVB,RAB	0 265 006 409 <sup>4</sup>	
	2.4 D	09.90-12.95	57	Fg.-Nr. →70..T..199 000	MVB	0 986 594 013 <sup>4</sup>	
	2.4 D Syncro	09.90-09.98	57			0 265 006 407 <sup>3</sup>	
					LAB,MVB	0 265 006 508 <sup>4</sup>	
					MVB,RAB	0 265 006 510 <sup>4</sup>	
		01.96-09.98	57	Fg.-Nr. 70..T..200 001→	LAB,MVB	0 265 006 408 <sup>4</sup>	
					MVB,RAB	0 265 006 409 <sup>4</sup>	
	2.5	07.94-12.95	81	Fg.-Nr. →70..T..199 000	MVB	0 986 594 013 <sup>4</sup>	
		09.95-12.95	81		MVB	0 986 594 013 <sup>4</sup>	
	2.5	01.94-06.03	81			0 265 006 407 <sup>3</sup>	
	2.5 Syncro				LAB,MVB	0 265 006 508 <sup>4</sup>	
					MVB,RAB	0 265 006 510 <sup>4</sup>	
		01.96-10.96	81	Fg.-Nr. 70..T..200 001→	LAB,MVB	0 265 006 408 <sup>4</sup>	
					MVB,RAB	0 265 006 409 <sup>4</sup>	
		08.96-06.03	81		LAB,MVB	0 265 006 408 <sup>4</sup>	
					MVB,RAB	0 265 006 409 <sup>4</sup>	
	2.5	08.96-06.03	85/111			0 265 006 407 <sup>3</sup>	
	2.5 Syncro				LAB,MVB	0 265 006 508 <sup>4</sup>	
	2.5 TDI				LAB,MVB	0 265 006 408 <sup>4</sup>	
					MVB,RAB	0 265 006 510 <sup>4</sup>	
					MVB,RAB	0 265 006 409 <sup>4</sup>	
	2.5 Syncro	01.94-12.95	81	Fg.-Nr. →70..T..199 000	MVB	0 986 594 013 <sup>4</sup>	
	2.5 TDI	01.95-12.95	75	Fg.-Nr. →70..T..199 000	MVB	0 986 594 013 <sup>4</sup>	
		01.96-06.03	75	Fg.-Nr. 70..T..200 001→	LAB,MVB	0 265 006 408 <sup>4</sup>	
					MVB,RAB	0 265 006 409 <sup>4</sup>	
		05.98-06.03	65			0 265 006 407 <sup>3</sup>	
					LAB,MVB	0 265 006 508 <sup>4</sup>	
					LAB,MVB	0 265 006 408 <sup>4</sup>	
					MVB,RAB	0 265 006 510 <sup>4</sup>	
					MVB,RAB	0 265 006 409 <sup>4</sup>	
		05.99-06.03	75		LAB,MVB	0 265 006 408 <sup>4</sup>	
					MVB,RAB	0 265 006 409 <sup>4</sup>	
	2.5 TDI Syncro	03.98-06.03	75		LAB,MVB	0 265 006 408 <sup>4</sup>	
					MVB,RAB	0 265 006 409 <sup>4</sup>	
	2.5 TDI	01.95-06.03	75			0 265 006 407 <sup>3</sup>	
	2.5 TDI Syncro				LAB,MVB	0 265 006 508 <sup>4</sup>	
					MVB,RAB	0 265 006 510 <sup>4</sup>	
	2.8	05.96-06.03	103/150			0 265 006 407 <sup>3</sup>	
					LAB,MVB	0 265 006 508 <sup>4</sup>	
					LAB,MVB	0 265 006 408 <sup>4</sup>	
					MVB,RAB	0 265 006 510 <sup>4</sup>	
					MVB,RAB	0 265 006 409 <sup>4</sup>	



		S							
<b>California T5 [7E]</b>									
	2.0 TDI, TDI 4Motion, TSI, TSI 4Motion	09.09→	62/75/84/100/103/ 110/132/150				0 986 134 004 0 986 135 004	← 41 → 41	
	2.0 TDI	09.09→	62/75/84 100/103 132/150				1 987 477 260 1 987 477 260 1 987 477 260	↔ 1303 ↔ 1303 ↔ 1303	
	2.0 TDI 4Motion	11.09→	100/103		FKR		1 987 482 376	↔ 1631	
					FLR		1 987 482 017	↔ 2015	
		03.10→	132/150		FKR		1 987 482 376	↔ 1631	
					FLR		1 987 482 017	↔ 2015	
	2.0 TSI	05.11→	132/150				1 987 477 260	↔ 1303	
		07.12→	110				1 987 477 260	↔ 1303	
	2.0 TSI 4Motion	07.11→	132/150		FKR		1 987 482 376	↔ 1631	
					FLR		1 987 482 017	↔ 2015	
		2.0 TDI, TDI 4Motion, TSI, TSI 4Motion	09.09→	62/75/84/100/103/ 110/132/150		LAB RAB	0 986 594 504 0 986 594 505		
<b>California T5 [7H]</b>									
	1.9 TDI	04.03-11.09	62/63/75/ 77		294		0 986 134 004 0 986 135 004	← 41 → 41	
					322		0 986 473 188 0 986 474 188	← 44 → 44	1 987 470 506 <sup>B</sup> 1 987 470 506 <sup>B</sup>
	2.0	06.03-11.09	85		294		0 986 134 004 0 986 135 004	← 41 → 41	
					322		0 986 473 188 0 986 474 188	← 44 → 44	1 987 470 506 <sup>B</sup> 1 987 470 506 <sup>B</sup>
	2.5 TDI	02.03-11.09	96/120/ 128		294		0 986 134 004 0 986 135 004	← 41 → 41	
	2.5 TDI 4Motion				322		0 986 473 188 0 986 474 188	← 44 → 44	1 987 470 506 <sup>B</sup> 1 987 470 506 <sup>B</sup>
	3.2	02.03-11.09	170/173		294		0 986 134 004 0 986 135 004	← 41 → 41	
	3.2 4Motion				322		0 986 473 188 0 986 474 188	← 44 → 44	1 987 470 506 <sup>B</sup> 1 987 470 506 <sup>B</sup>
	1.9 TDI	04.03-11.09	62/63/75/ 77	PR-Code OWN, PR-Code OWP, PR-Code OWQ, PR-Code OWL, PR-Code OWM PR-Code OWR			1 987 477 260 1 987 482 014	↔ 1303 ↔ 1270	
	2.0	06.03-11.09	85	PR-Code OWN, PR-Code OWP, PR-Code OWQ, PR-Code OWL, PR-Code OWM PR-Code OWR			1 987 477 260 1 987 482 014	↔ 1303 ↔ 1270	
	2.5 TDI	02.03-11.09	96	PR-Code OWN, PR-Code OWP, PR-Code OWQ, PR-Code OWL, PR-Code OWM PR-Code OWR			1 987 477 260 1 987 482 014	↔ 1303 ↔ 1270	
			128	PR-Code OWN, PR-Code OWP, PR-Code OWQ, PR-Code OWL, PR-Code OWM PR-Code OWR			1 987 477 260 1 987 482 014	↔ 1303 ↔ 1270	
		11.03-11.09	120	PR-Code OWN, PR-Code OWP, PR-Code OWQ, PR-Code OWL, PR-Code OWM PR-Code OWR			1 987 477 260 1 987 482 014	↔ 1303 ↔ 1270	
	2.5 TDI 4Motion	07.04-11.09	96		FKR		1 987 482 016	↔ 1650	
					FLR		1 987 482 017	↔ 2015	







	◀ VW California T5 [7H]									
	2.5 TDI 4Motion	07.04-11.09	128		FKR	1987 482 016	↔ 1650			
					FLR	1987 482 017	↔ 2015			
	3.2	02.03-06.04	170	PR-Code OWN, PR-Code OWP, PR-Code OWQ, PR-Code OWL, PR-Code OWM		1987 477 260	↔ 1303			
				PR-Code OWR		1987 482 014	↔ 1270			
		05.03-11.09	173	PR-Code OWN, PR-Code OWP, PR-Code OWQ, PR-Code OWL, PR-Code OWM		1987 477 260	↔ 1303			
				PR-Code OWR		1987 482 014	↔ 1270			
	3.2 4Motion	07.04-11.09	173		FKR	1987 482 016	↔ 1650			
					FLR	1987 482 017	↔ 2015			
	1.9 TDI	04.03-11.09	62/63/75/ 77		LAB	0986 594 504 <sup>3</sup>				
						0986 594 504 <sup>4</sup>				
					RAB	0986 594 505 <sup>3</sup>				
						0986 594 505 <sup>4</sup>				
	2.0	06.03-11.09	85		LAB	0986 594 504 <sup>3</sup>				
						0986 594 504 <sup>4</sup>				
					RAB	0986 594 505 <sup>3</sup>				
						0986 594 505 <sup>4</sup>				
	2.5 TDI	02.03-11.09	96		LAB	0986 594 504 <sup>3</sup>				
						0986 594 504 <sup>4</sup>				
					RAB	0986 594 505 <sup>3</sup>				
						0986 594 505 <sup>4</sup>				
			128		LAB	0986 594 504 <sup>3</sup>				
						0986 594 504 <sup>4</sup>				
					RAB	0986 594 505 <sup>3</sup>				
						0986 594 505 <sup>4</sup>				
		11.03-11.09	120		LAB	0986 594 504 <sup>3</sup>				
						0986 594 504 <sup>4</sup>				
					RAB	0986 594 505 <sup>3</sup>				
						0986 594 505 <sup>4</sup>				
	2.5 TDI 4Motion	07.04-11.09	96		LAB	0986 594 504				
					RAB	0986 594 505				
			128		LAB	0986 594 504				
					RAB	0986 594 505				
	3.2	02.03-06.04	170		LAB	0986 594 504 <sup>3</sup>				
						0986 594 504 <sup>4</sup>				
					RAB	0986 594 505 <sup>3</sup>				
						0986 594 505 <sup>4</sup>				
		05.03-11.09	173		LAB	0986 594 504 <sup>3</sup>				
						0986 594 504 <sup>4</sup>				
					RAB	0986 594 505 <sup>3</sup>				
						0986 594 505 <sup>4</sup>				
	3.2 4Motion	07.04-11.09	173		LAB	0986 594 504				
					RAB	0986 594 505				







































































**California T6 [SG]**

	2.0 TDI, TDI 4Motion, TFSI, TFSI 4Motion	04.15→	62/75/103/110/ 132/150			0986 134 004	👁️ ← 41		
						0986 135 004	👁️ → 41		
	2.0 TDI	04.15→	62/75/110/132/150			1987 477 260	↔ 1303		
	2.0 TFSI	04.15→	62/75/110/132/150			1987 477 260	↔ 1303		
	2.0 TDI, TDI 4Motion, TFSI, TFSI 4Motion	04.15→	62/75/103/110/ 132/150		LAB	0986 594 504			
					RAB	0986 594 505			

		S								
<b>Caravelle T4 [70, 7D]</b>										
	<b>1.9D</b>	10.90-06.03	45/50		281		0 986 473 177		← 53,94	1 987 474 496 <sup>B</sup>
	<b>1.9D Turbo</b>						0 986 474 177		→ 53,94	1 987 474 496 <sup>B</sup>
		01.96-06.03	45/50	Fg.-Nr. 70..T..200 001→, PR-Code LU	284	ATE	0 986 473 361		← 56,93	1 987 470 005 <sup>7</sup>
							0 986 473 361		← 56,93	1 987 470 506 <sup>B</sup>
							0 986 474 361		→ 56,93	1 987 470 005 <sup>7</sup>
				Fg.-Nr. 70..T..200 001→, PR-Code 1LE	284	LUC	0 986 473 806		← 54	
							0 986 473 807		→ 54	
<b>2.0</b>		09.90-06.03	62		281		0 986 473 177		← 53,94	1 987 474 496 <sup>B</sup>
							0 986 474 177		→ 53,94	1 987 474 496 <sup>B</sup>
		01.96-06.03	62	Fg.-Nr. 70..T..200 001→, PR-Code LU	284	ATE	0 986 473 361		← 56,93	1 987 470 005 <sup>7</sup>
							0 986 473 361		← 56,93	1 987 470 506 <sup>B</sup>
							0 986 474 361		→ 56,93	1 987 470 005 <sup>7</sup>
				Fg.-Nr. 70..T..200 001→, PR-Code 1LE	284	LUC	0 986 473 806		← 54	
							0 986 473 807		→ 54	
<b>2.4D</b>		09.90-05.98	57		281		0 986 473 177		← 53,94	1 987 474 496 <sup>B</sup>
							0 986 474 177		→ 53,94	1 987 474 496 <sup>B</sup>
		01.96-05.98	57	Fg.-Nr. 70..T..200 001→, PR-Code LU	284	ATE	0 986 473 361		← 56,93	1 987 470 005 <sup>7</sup>
							0 986 473 361		← 56,93	1 987 470 506 <sup>B</sup>
							0 986 474 361		→ 56,93	1 987 470 005 <sup>7</sup>
				Fg.-Nr. 70..T..200 001→, PR-Code 1LE	284	LUC	0 986 473 806		← 54	
							0 986 473 807		→ 54	
		05.97-06.03	55		281		0 986 473 177		← 53,94	1 987 474 496 <sup>B</sup>
							0 986 474 177		→ 53,94	1 987 474 496 <sup>B</sup>
				PR-Code 1LE	284	LUC	0 986 473 806		← 54	
							0 986 473 807		→ 54	
				PR-Code 1LU	284	ATE	0 986 473 361		← 56,93	1 987 470 005 <sup>7</sup>
							0 986 473 361		← 56,93	1 987 470 506 <sup>B</sup>
							0 986 474 361		→ 56,93	1 987 470 005 <sup>7</sup>
<b>2.4D Syncro</b>		11.92-12.95	57	Fg.-Nr. →70..T..199 000			0 986 473 177		← 53,94	1 987 474 496 <sup>B</sup>
							0 986 474 177		→ 53,94	1 987 474 496 <sup>B</sup>
		01.96-09.98	57	Fg.-Nr. 70..T..200 001→						1 987 474 496 <sup>B</sup>
<b>2.5</b>		07.94-10.96	81				0 986 473 806		← 54	
							0 986 473 807		→ 54	
		08.96-06.03	81		281		0 986 473 177		← 53,94	1 987 474 496 <sup>B</sup>
							0 986 474 177		→ 53,94	1 987 474 496 <sup>B</sup>
				PR-Code 1LE	284	LUC	0 986 473 806		← 54	
							0 986 473 807		→ 54	
				PR-Code 1LU	284	ATE	0 986 473 361		← 56,93	1 987 470 005 <sup>7</sup>
							0 986 473 361		← 56,93	1 987 470 506 <sup>B</sup>
							0 986 474 361		→ 56,93	1 987 470 005 <sup>7</sup>
			85	PR-Code 1LB	1KX		0 986 473 184		← 57	
							0 986 474 184		→ 57	
					326		0 986 473 259		← 57	1 987 470 005 <sup>7</sup>
							0 986 474 259		→ 57	1 987 470 005 <sup>7</sup>
				PR-Code 1LE	284		0 986 473 806		← 54	
							0 986 473 807		→ 54	
				PR-Code 1LU	284		0 986 473 361		← 56,93	1 987 470 005 <sup>7</sup>
							0 986 473 361		← 56,93	1 987 470 506 <sup>B</sup>
							0 986 474 361		→ 56,93	1 987 470 005 <sup>7</sup>
<b>2.5, Syncro</b>		08.96-06.03	85	PR-Code 1LP	281					1 987 474 496 <sup>B</sup>
<b>2.5 Syncro</b>		01.94-12.95	81	Fg.-Nr. →70..T..199 000			0 986 473 177		← 53,94	1 987 474 496 <sup>B</sup>
							0 986 474 177		→ 53,94	1 987 474 496 <sup>B</sup>
		01.96-10.96	81	Fg.-Nr. 70..T..200 001→						1 987 474 496 <sup>B</sup>
		08.96-05.00	85	Fg.-Nr. →70..1..000 954, PR-Code 1LB	326		0 986 473 259		← 57	1 987 470 005 <sup>7</sup>
							0 986 474 259		→ 57	1 987 470 005 <sup>7</sup>
		08.96-06.03	85	PR-Code 1LE	284	LUC	0 986 473 806		← 54	
							0 986 473 807		→ 54	



◀ VW Caravelle T4 [70, 7D]												
2.5 Syncro	08.96-06.03	85	PR-Code 1LU	284	ATE	0986 473 361		56,93	1987 470 005 <sup>7</sup>			
						0986 473 361		56,93	1987 470 506 <sup>8</sup>			
						0986 474 361		56,93	1987 470 005 <sup>7</sup>			
	06.97-11.01	81	PR-Code 1LE			LUC	0986 473 806		54			
							0986 473 807		54			
							PR-Code 1LU	ATE	0986 473 361		56,93	1987 470 005 <sup>7</sup>
	05.99-06.03	85					0986 473 361		56,93	1987 470 506 <sup>8</sup>		
							0986 474 361		56,93	1987 470 005 <sup>7</sup>		
							0986 473 184		57			
	06.00-06.03	85	Fg.-Nr. 70..1..000 955→,	PR-Code 1LB	1KX		0986 473 184		57			
							0986 474 184		57			
	2.5 TDI	01.95-06.03	75				0986 473 177		53,94	1987 474 496 <sup>8</sup>		
							0986 474 177		53,94	1987 474 496 <sup>8</sup>		
		05.98-05.00	111	Fg.-Nr. →70..1..000 954,	PR-Code 1LB	326		0986 473 259		57	1987 470 005 <sup>7</sup>	
								0986 474 259		57	1987 470 005 <sup>7</sup>	
05.98-06.03		65					0986 473 177		53,94	1987 474 496 <sup>8</sup>		
							0986 474 177		53,94	1987 474 496 <sup>8</sup>		
							PR-Code 1LE	LUC	0986 473 806		54	
							0986 473 807		54			
							PR-Code 1LU	ATE	0986 473 361		56,93	1987 470 005 <sup>7</sup>
							0986 473 361		56,93	1987 470 506 <sup>8</sup>		
							0986 474 361		56,93	1987 470 005 <sup>7</sup>		
							111	PR-Code 1LE	LUC	0986 473 806		54
							0986 473 807		54			
							PR-Code 1LU	ATE	0986 473 361		56,93	1987 470 005 <sup>7</sup>
							0986 473 361		56,93	1987 470 506 <sup>8</sup>		
	0986 474 361							56,93	1987 470 005 <sup>7</sup>			
06.00-09.00	111	Fg.-Nr. 70..1..000 955→,	PR-Code 1LB	1KX		0986 473 184		57				
						0986 474 184		57				
09.00-06.03	111	PR-Code 1LB				0986 473 184		57				
						0986 474 184		57				
2.5 TDI Syncro	03.98-06.03	75	PR-Code 1LB	1KX		0986 473 184		57				
						0986 474 184		57				
2.5 TDI	01.95-06.03	75	PR-Code 1LP	281					1987 474 496 <sup>8</sup>			
						PR-Code 1LE	LUC	0986 473 806		54		
2.5 TDI Syncro						0986 473 807		54				
						PR-Code 1LU	ATE	0986 473 361		56,93	1987 470 005 <sup>7</sup>	
						0986 473 361		56,93	1987 470 506 <sup>8</sup>			
						0986 474 361		56,93	1987 470 005 <sup>7</sup>			
2.8	01.96-05.00	103	PR-Code 1LB	326		0986 473 259		57	1987 470 005 <sup>7</sup>			
						0986 474 259		57	1987 470 005 <sup>7</sup>			
						PR-Code 1LE	LUC	0986 473 806		54		
						0986 473 807		54				
						PR-Code 1LU	ATE	0986 473 361		56,93	1987 470 005 <sup>7</sup>	
						0986 473 361		56,93	1987 470 506 <sup>8</sup>			
	05.00-06.03	150				0986 474 361		56,93	1987 470 005 <sup>7</sup>			
						0986 473 184		57				
						0986 474 184		57				
	1.9 D	10.90-04.97	45			0986 475 935		20,64				
	1.9 D Turbo	10.92-12.95	50	Fg.-Nr. →70..T..199 000		0986 475 935		20,64				
	2.0	09.90-12.95	62	Fg.-Nr. →70..T..199 000		0986 475 935		20,64				
	2.4 D	05.97-06.03	55			0986 475 935		20,64				
	2.4 D, D Syncro	09.90-12.95	57	Fg.-Nr. →70..T..199 000		0986 475 935		20,64				
	2.5	07.94-12.95	81	Fg.-Nr. →70..T..199 000			0986 475 935		20,64			
							09.95-12.95	81			0986 475 935	
	2.5 Syncro	01.94-12.95	81	Fg.-Nr. →70..T..199 000			0986 475 935		20,64			
	2.5 TDI	01.95-12.95	75	Fg.-Nr. →70..T..199 000			0986 475 935		20,64			

		S										
	<b>1.9D Turbo</b>	01.96-06.03	50	Fg.-Nr. 70..T..200 001→			0 986 <b>473 073</b>	 ← 38	1 987 <b>470 040</b> <sup>7</sup>			
							0 986 <b>473 073</b>	 ← 38	1 987 <b>474 496</b> <sup>8</sup>			
							0 986 <b>474 073</b>	 → 38	1 987 <b>470 040</b> <sup>7</sup>			
	<b>2.0</b>	01.96-06.03	62	Fg.-Nr. 70..T..200 001→				0 986 <b>473 073</b>	 ← 38	1 987 <b>470 040</b> <sup>7</sup>		
								0 986 <b>473 073</b>	 ← 38	1 987 <b>474 496</b> <sup>8</sup>		
								0 986 <b>474 073</b>	 → 38	1 987 <b>470 040</b> <sup>7</sup>		
	<b>2.4D</b>	05.97-06.03	55					0 986 <b>473 073</b>	 ← 38	1 987 <b>470 040</b> <sup>7</sup>		
								0 986 <b>473 073</b>	 ← 38	1 987 <b>474 496</b> <sup>8</sup>		
								0 986 <b>474 073</b>	 → 38	1 987 <b>470 040</b> <sup>7</sup>		
	<b>2.4D</b> <b>2.4D Syncro</b>	01.96-09.98	57	Fg.-Nr. 70..T..200 001→				0 986 <b>473 073</b>	 ← 38	1 987 <b>470 040</b> <sup>7</sup>		
								0 986 <b>473 073</b>	 ← 38	1 987 <b>474 496</b> <sup>8</sup>		
								0 986 <b>474 073</b>	 → 38	1 987 <b>470 040</b> <sup>7</sup>		
	<b>2.5</b>	01.96-10.96	81	Fg.-Nr. 70..T..200 001→				0 986 <b>473 073</b>	 ← 38	1 987 <b>470 040</b> <sup>7</sup>		
								0 986 <b>474 073</b>	 → 38	1 987 <b>474 496</b> <sup>8</sup>		
		08.96-06.03	81					0 986 <b>473 073</b>	 ← 38	1 987 <b>470 040</b> <sup>7</sup>		
								0 986 <b>474 073</b>	 → 38	1 987 <b>474 496</b> <sup>8</sup>		
	<b>2.5</b> <b>2.5 Syncro</b>	01.96-10.96	81	Fg.-Nr. 70..T..200 001→				0 986 <b>474 073</b>	 → 38	1 987 <b>470 040</b> <sup>7</sup>		
		08.96-06.03	81					0 986 <b>474 073</b>	 → 38	1 987 <b>470 040</b> <sup>7</sup>		
	<b>2.5</b> <b>2.5 Syncro</b>	08.96-06.03	85/111					0 986 <b>473 073</b>	 ← 38	1 987 <b>470 040</b> <sup>7</sup>		
								0 986 <b>473 073</b>	 ← 38	1 987 <b>474 496</b> <sup>8</sup>		
	<b>2.5 TDI</b> <b>2.5 Syncro</b>	01.96-10.96	81	Fg.-Nr. 70..T..200 001→				0 986 <b>474 073</b>	 → 38	1 987 <b>470 040</b> <sup>7</sup>		
								0 986 <b>473 073</b>	 ← 38	1 987 <b>470 040</b> <sup>7</sup>		
								0 986 <b>473 073</b>	 ← 38	1 987 <b>474 496</b> <sup>8</sup>		
								0 986 <b>474 073</b>	 → 38	1 987 <b>470 040</b> <sup>7</sup>		
<b>2.5 TDI</b>	01.96-06.03	75	Fg.-Nr. 70..T..200 001→				0 986 <b>473 073</b>	 ← 38	1 987 <b>470 040</b> <sup>7</sup>			
							0 986 <b>473 073</b>	 ← 38	1 987 <b>474 496</b> <sup>8</sup>			
							0 986 <b>474 073</b>	 → 38	1 987 <b>470 040</b> <sup>7</sup>			
	05.98-06.03	65					0 986 <b>473 073</b>	 ← 38	1 987 <b>470 040</b> <sup>7</sup>			
							0 986 <b>473 073</b>	 ← 38	1 987 <b>474 496</b> <sup>8</sup>			
							0 986 <b>474 073</b>	 → 38	1 987 <b>470 040</b> <sup>7</sup>			
<b>2.5 TDI Syncro</b>	01.96-06.03	75	Fg.-Nr. 70..T..200 001→				0 986 <b>473 073</b>	 ← 38	1 987 <b>470 040</b> <sup>7</sup>			
							0 986 <b>473 073</b>	 ← 38	1 987 <b>474 496</b> <sup>8</sup>			
							0 986 <b>474 073</b>	 → 38	1 987 <b>470 040</b> <sup>7</sup>			
	05.99-06.03	75					0 986 <b>473 073</b>	 ← 38	1 987 <b>470 040</b> <sup>7</sup>			
							0 986 <b>473 073</b>	 ← 38	1 987 <b>474 496</b> <sup>8</sup>			
							0 986 <b>474 073</b>	 → 38	1 987 <b>470 040</b> <sup>7</sup>			
<b>2.5 TDI Syncro</b>	03.98-06.03	75					0 986 <b>473 073</b>	 ← 38	1 987 <b>470 040</b> <sup>7</sup>			
							0 986 <b>473 073</b>	 ← 38	1 987 <b>474 496</b> <sup>8</sup>			
							0 986 <b>474 073</b>	 → 38	1 987 <b>470 040</b> <sup>7</sup>			
							0 986 <b>473 073</b>	 ← 38	1 987 <b>470 040</b> <sup>7</sup>			
<b>2.8</b>	01.96-06.03	103/150					0 986 <b>473 073</b>	 ← 38	1 987 <b>470 040</b> <sup>7</sup>			
							0 986 <b>473 073</b>	 ← 38	1 987 <b>474 496</b> <sup>8</sup>			
							0 986 <b>474 073</b>	 → 38	1 987 <b>470 040</b> <sup>7</sup>			
		<b>1.9D</b>	10.90-04.97	45					1 987 <b>477 171</b>	 ↔ 844		
		<b>1.9D Turbo</b>	10.92-12.95	50	Fg.-Nr. →70..T..199 000	TBR				1 987 <b>477 171</b>	 ↔ 844	
			01.96-02.97	50	Fg.-Nr. 70..T..200 001→	SBR				1 987 <b>477 706</b>	 ↔ 949	
					70..V..120 000							
		<b>2.0</b>	03.97-06.03	50	Fg.-Nr. 70..V..120 001→	SBR				1 987 <b>477 707</b>	 ↔ 953	
			09.90-12.95	62	Fg.-Nr. →70..T..199 000	TBR				1 987 <b>477 171</b>	 ↔ 844	
			01.96-02.97	62	Fg.-Nr. 70..T..200 001→	SBR				1 987 <b>477 706</b>	 ↔ 949	
		<b>2.4D</b>			70..V..120 000							
			03.97-06.03	62	Fg.-Nr. 70..V..120 001→	SBR				1 987 <b>477 707</b>	 ↔ 953	
			09.90-12.95	57	Fg.-Nr. →70..T..199 000	TBR				1 987 <b>477 171</b>	 ↔ 844	
		<b>2.4D Syncro</b>	01.96-02.97	57	Fg.-Nr. 70..T..200 001→	SBR				1 987 <b>477 706</b>	 ↔ 949	
					70..V..120 000							
			03.97-05.98	57	Fg.-Nr. 70..V..120 001→	SBR				1 987 <b>477 707</b>	 ↔ 953	
		<b>2.5</b>	05.97-06.03	55						1 987 <b>477 707</b>	 ↔ 953	
			11.92-12.95	57	Fg.-Nr. →70..T..199 000	TBR				1 987 <b>477 171</b>	 ↔ 844	
			01.96-09.98	57	Fg.-Nr. 70..T..200 001→	SBR				1 987 <b>477 706</b>	 ↔ 949	
		<b>2.5</b>	07.94-12.95	81	Fg.-Nr. →70..T..199 000	TBR				1 987 <b>477 171</b>	 ↔ 844	
			09.95-12.95	81						1 987 <b>477 171</b>	 ↔ 844	
			01.96-10.96	81	Fg.-Nr. 70..T..200 001→	SBR				1 987 <b>477 706</b>	 ↔ 949	
			08.96-02.97	81	Fg.-Nr. →70..V..120 000					1 987 <b>477 706</b>	 ↔ 949	





◀ VW Caravelle T4 [70, 7D]

<b>2.5</b>	08.96-02.97	85	Fg.-Nr. →70..V..120 000	SBR	1987 <b>477 706</b>	↔ 949
	03.97-06.03	81	Fg.-Nr. 70..V..120 001→		1987 <b>477 707</b>	↔ 953
		85	Fg.-Nr. 70..V..120 001→	SBR	1987 <b>477 707</b>	↔ 953
	05.99-12.99	85			1987 <b>477 707</b>	↔ 953
	12.99-06.03	85		SBR	1987 <b>477 707</b>	↔ 953
				TBR	1987 <b>477 171</b>	↔ 844
<b>2.5 Syncro</b>	01.94-12.95	81	Fg.-Nr. →70..T..199 000	TBR	1987 <b>477 171</b>	↔ 844
	01.96-10.96	81	Fg.-Nr. 70..T..200 001→	SBR	1987 <b>477 706</b>	↔ 949
	08.96-02.97	85	Fg.-Nr. →70..V..120 000		1987 <b>477 706</b>	↔ 949
	03.97-06.03	85	Fg.-Nr. 70..V..120 001→		1987 <b>477 707</b>	↔ 953
	06.97-11.01	81			1987 <b>477 706</b>	↔ 949
	05.99-06.03	85			1987 <b>477 707</b>	↔ 953
<b>2.5 TDI</b>	01.95-02.97	75	Fg.-Nr. →70..V..120 000	SBR	1987 <b>477 706</b>	↔ 949
	01.95-06.03	75		TBR	1987 <b>477 171</b>	↔ 844
	03.97-06.03	75	Fg.-Nr. 70..V..120 001→	SBR	1987 <b>477 707</b>	↔ 953
	05.98-06.03	65		SBR	1987 <b>477 707</b>	↔ 953
				TBR	1987 <b>477 171</b>	↔ 844
		111		SBR	1987 <b>477 707</b>	↔ 953
				TBR	1987 <b>477 171</b>	↔ 844
	05.99-06.03	75		SBR	1987 <b>477 707</b>	↔ 953
<b>2.5 TDI Syncro</b>	03.98-06.03	75			1987 <b>477 707</b>	↔ 953
<b>2.8</b>	01.96-02.97	103	Fg.-Nr. →70..V..120 000	SBR	1987 <b>477 706</b>	↔ 949
	01.96-05.00	103		TBR	1987 <b>477 171</b>	↔ 844
	03.97-05.00	103	Fg.-Nr. 70..V..120 001→	SBR	1987 <b>477 707</b>	↔ 953
	05.00-06.03	150			1987 <b>477 707</b>	↔ 953



<b>1.9 D</b>	10.90-12.95	45/50	Fg.-Nr. →70..T..199 000	<b>MVB</b>	0986 <b>594 013</b> <sup>4</sup>	
	<b>1.9 D Turbo</b>	10.90-06.03	45/50		0265 <b>006 407</b> <sup>3</sup>	
				LAB,MVB	0265 <b>006 508</b> <sup>4</sup>	
				MVB,RAB	0265 <b>006 510</b> <sup>4</sup>	
	01.96-06.03	45/50	Fg.-Nr. 70..T..200 001→	LAB, <b>MVB</b>	0265 <b>006 408</b> <sup>4</sup>	
				<b>MVB</b> ,RAB	0265 <b>006 409</b> <sup>4</sup>	
<b>2.0</b>	09.90-12.95	62	Fg.-Nr. →70..T..199 000	<b>MVB</b>	0986 <b>594 013</b> <sup>4</sup>	
	09.90-06.03	62			0265 <b>006 407</b> <sup>3</sup>	
				LAB,MVB	0265 <b>006 508</b> <sup>4</sup>	
				MVB,RAB	0265 <b>006 510</b> <sup>4</sup>	
	01.96-06.03	62	Fg.-Nr. 70..T..200 001→	LAB, <b>MVB</b>	0265 <b>006 408</b> <sup>4</sup>	
				<b>MVB</b> ,RAB	0265 <b>006 409</b> <sup>4</sup>	
<b>2.4 D</b>	05.97-06.03	55			0265 <b>006 407</b> <sup>3</sup>	
				LAB,MVB	0265 <b>006 508</b> <sup>4</sup>	
				LAB, <b>MVB</b>	0265 <b>006 408</b> <sup>4</sup>	
				MVB,RAB	0265 <b>006 510</b> <sup>4</sup>	
			<b>MVB</b> ,RAB	0265 <b>006 409</b> <sup>4</sup>		
<b>2.4 D</b>	09.90-12.95	57	Fg.-Nr. →70..T..199 000	<b>MVB</b>	0986 <b>594 013</b> <sup>4</sup>	
<b>2.4 D Syncro</b>	09.90-09.98	57			0265 <b>006 407</b> <sup>3</sup>	
				LAB,MVB	0265 <b>006 508</b> <sup>4</sup>	
				MVB,RAB	0265 <b>006 510</b> <sup>4</sup>	
	01.96-09.98	57	Fg.-Nr. 70..T..200 001→	LAB, <b>MVB</b>	0265 <b>006 408</b> <sup>4</sup>	
				<b>MVB</b> ,RAB	0265 <b>006 409</b> <sup>4</sup>	
<b>2.5</b>	07.94-12.95	81	Fg.-Nr. →70..T..199 000	<b>MVB</b>	0986 <b>594 013</b> <sup>4</sup>	
	09.95-12.95	81		<b>MVB</b>	0986 <b>594 013</b> <sup>4</sup>	
<b>2.5 Syncro</b>	01.94-06.03	81			0265 <b>006 407</b> <sup>3</sup>	
				LAB,MVB	0265 <b>006 508</b> <sup>4</sup>	
				MVB,RAB	0265 <b>006 510</b> <sup>4</sup>	
	01.96-10.96	81	Fg.-Nr. 70..T..200 001→	LAB, <b>MVB</b>	0265 <b>006 408</b> <sup>4</sup>	
				<b>MVB</b> ,RAB	0265 <b>006 409</b> <sup>4</sup>	
	08.96-06.03	81		LAB, <b>MVB</b>	0265 <b>006 408</b> <sup>4</sup>	
				<b>MVB</b> ,RAB	0265 <b>006 409</b> <sup>4</sup>	
<b>2.5</b>	08.96-06.03	85/111			0265 <b>006 407</b> <sup>3</sup>	
<b>2.5 Syncro</b>				LAB,MVB	0265 <b>006 508</b> <sup>4</sup>	
<b>2.5 TDI</b>				LAB, <b>MVB</b>	0265 <b>006 408</b> <sup>4</sup>	
				MVB,RAB	0265 <b>006 510</b> <sup>4</sup>	
				<b>MVB</b> ,RAB	0265 <b>006 409</b> <sup>4</sup>	

	S							
2.5 Syncro	01.94-12.95	81	Fg.-Nr. →70..T..199 000	MVB	0 986 594 013 <sup>4</sup>			
2.5 TDI	01.95-12.95	75	Fg.-Nr. →70..T..199 000	MVB	0 986 594 013 <sup>4</sup>			
	01.96-06.03	75	Fg.-Nr. 70..T..200 001→	LAB,MVB MVB,RAB	0 265 006 408 <sup>4</sup> 0 265 006 409 <sup>4</sup>			
	05.98-06.03	65			0 265 006 407 <sup>3</sup>			
				LAB,MVB	0 265 006 508 <sup>4</sup>			
				LAB,MVB	0 265 006 408 <sup>4</sup>			
				MVB,RAB	0 265 006 510 <sup>4</sup>			
				MVB,RAB	0 265 006 409 <sup>4</sup>			
	05.99-06.03	75		LAB,MVB	0 265 006 408 <sup>4</sup>			
				MVB,RAB	0 265 006 409 <sup>4</sup>			
2.5 TDI Syncro	03.98-06.03	75		LAB,MVB	0 265 006 408 <sup>4</sup>			
				MVB,RAB	0 265 006 409 <sup>4</sup>			
2.5 TDI	01.95-06.03	75			0 265 006 407 <sup>3</sup>			
				LAB,MVB	0 265 006 508 <sup>4</sup>			
2.5 TDI Syncro				MVB,RAB	0 265 006 510 <sup>4</sup>			
2.8	01.96-06.03	103/150			0 265 006 407 <sup>3</sup>			
				LAB,MVB	0 265 006 508 <sup>4</sup>			
				LAB,MVB	0 265 006 408 <sup>4</sup>			
				MVB,RAB	0 265 006 510 <sup>4</sup>			
				MVB,RAB	0 265 006 409 <sup>4</sup>			

**Caravelle T5 [7E]**

	2.0, TDI, TDI 4Motion, TSI, TSI 4Motion	09.09→	62/75/84/85/100/ 103/110/132/150		0 986 134 004	← 41
					0 986 135 004	→ 41

	2.0	09.09→	62/75/84/85		1 987 477 260	↔ 1303
					2.0 TDI	09.09→
	2.0 TDI 4Motion	09.09→	100/103 132/150	FKR	1 987 482 376	↔ 1631
				FLR	1 987 482 017	↔ 2015
				FKR	1 987 482 376	↔ 1631
				FLR	1 987 482 017	↔ 2015
	2.0 TSI	05.11→ 07.12→	132/150 110		1 987 477 260	↔ 1303
					1 987 477 260	↔ 1303
	2.0 TSI 4Motion	07.11→	132/150	FKR	1 987 482 376	↔ 1631
				FLR	1 987 482 017	↔ 2015

	2.0, TDI, TDI 4Motion, TSI, TSI 4Motion	09.09→	62/75/84/85/100/ 103/110/132/150	LAB	0 986 594 504	
				RAB	0 986 594 505	

**Caravelle T5 [7H]**

	1.9 TDI	04.03-11.09	62/63/75/ 77	294	0 986 134 004	← 41
					0 986 135 004	→ 41
	2.0	06.03-11.09	85	322	0 986 473 188	← 44 1 987 470 506 <sup>B</sup>
					0 986 474 188	→ 44 1 987 470 506 <sup>B</sup>
	2.0	06.03-11.09	85	294	0 986 134 004	← 41
					0 986 135 004	→ 41
	2.0	06.03-11.09	85	322	0 986 473 188	← 44 1 987 470 506 <sup>B</sup>
					0 986 474 188	→ 44 1 987 470 506 <sup>B</sup>
	2.5 TDI	02.03-11.09	96/120/ 128	294	0 986 134 004	← 41
					0 986 135 004	→ 41
	2.5 TDI 4Motion	02.03-11.09	96/120/ 128	322	0 986 473 188	← 44 1 987 470 506 <sup>B</sup>
					0 986 474 188	→ 44 1 987 470 506 <sup>B</sup>
	3.2	02.03-11.09	170/173	294	0 986 134 004	← 41
					0 986 135 004	→ 41
	3.2 4Motion	02.03-11.09	170/173			



		S							
	◀ VW Caravelle T5 [7H]								
3.2		02.03-11.09	170/173			322	0986 473 188	← 44	1987 470 506 <sup>8</sup>
3.2 4Motion							0986 474 188	→ 44	1987 470 506 <sup>8</sup>
	1.9 TDI	04.03-11.09	62/63/75/ 77	PR-Code OWN, PR-Code OWP, PR-Code OWQ, PR-Code OWL, PR-Code OWM			1987 477 260	↔ 1303	
				PR-Code OWR			1987 482 014	↔ 1270	
	2.0	06.03-11.09	85	PR-Code OWN, PR-Code OWP, PR-Code OWQ, PR-Code OWL, PR-Code OWM			1987 477 260	↔ 1303	
				PR-Code OWR			1987 482 014	↔ 1270	
	2.5 TDI	02.03-11.09	96	PR-Code OWN, PR-Code OWP, PR-Code OWQ, PR-Code OWL, PR-Code OWM			1987 477 260	↔ 1303	
				PR-Code OWR			1987 482 014	↔ 1270	
			128	PR-Code OWN, PR-Code OWP, PR-Code OWQ, PR-Code OWL, PR-Code OWM			1987 477 260	↔ 1303	
				PR-Code OWR			1987 482 014	↔ 1270	
		11.03-11.09	120	PR-Code OWN, PR-Code OWP, PR-Code OWQ, PR-Code OWL, PR-Code OWM			1987 477 260	↔ 1303	
				PR-Code OWR			1987 482 014	↔ 1270	
	2.5 TDI 4Motion	07.04-11.09	96		FKR		1987 482 016	↔ 1650	
					FLR		1987 482 017	↔ 2015	
			128		FKR		1987 482 016	↔ 1650	
					FLR		1987 482 017	↔ 2015	
	3.2	02.03-06.04	170	PR-Code OWN, PR-Code OWP, PR-Code OWQ, PR-Code OWL, PR-Code OWM			1987 477 260	↔ 1303	
				PR-Code OWR			1987 482 014	↔ 1270	
		05.03-11.09	173	PR-Code OWN, PR-Code OWP, PR-Code OWQ, PR-Code OWL, PR-Code OWM			1987 477 260	↔ 1303	
				PR-Code OWR			1987 482 014	↔ 1270	
	3.2 4Motion	07.04-11.09	173		FKR		1987 482 016	↔ 1650	
					FLR		1987 482 017	↔ 2015	
	1.9 TDI	04.03-11.09	62/63/75/ 77		LAB		0986 594 504 <sup>3</sup>		
					RAB		0986 594 504 <sup>4</sup>		
							0986 594 505 <sup>3</sup>		
							0986 594 505 <sup>4</sup>		
	2.0	06.03-11.09	85		LAB		0986 594 504 <sup>3</sup>		
					RAB		0986 594 504 <sup>4</sup>		
							0986 594 505 <sup>3</sup>		
							0986 594 505 <sup>4</sup>		
	2.5 TDI	02.03-11.09	96		LAB		0986 594 504 <sup>3</sup>		
					RAB		0986 594 504 <sup>4</sup>		
							0986 594 505 <sup>3</sup>		
			128		LAB		0986 594 504 <sup>3</sup>		
					RAB		0986 594 504 <sup>4</sup>		
							0986 594 505 <sup>3</sup>		
							0986 594 505 <sup>4</sup>		
		11.03-11.09	120		LAB		0986 594 504 <sup>3</sup>		
					RAB		0986 594 504 <sup>4</sup>		
							0986 594 505 <sup>3</sup>		
							0986 594 505 <sup>4</sup>		
	2.5 TDI 4Motion	07.04-11.09	96		LAB		0986 594 504		
					RAB		0986 594 505		
			128		LAB		0986 594 504		
					RAB		0986 594 505		
	3.2	02.03-06.04	170		LAB		0986 594 504 <sup>3</sup>		
							0986 594 504 <sup>4</sup>		
					RAB		0986 594 505 <sup>3</sup>		
							0986 594 505 <sup>4</sup>		
		05.03-11.09	173		LAB		0986 594 504 <sup>3</sup>		
							0986 594 504 <sup>4</sup>		



3.2	05.03-11.09	173			RAB	0 986 594 505 <sup>3</sup>		
						0 986 594 505 <sup>4</sup>		
3.2 4Motion	07.04-11.09	173			LAB	0 986 594 504		
					RAB	0 986 594 505		
<b>Caravelle T6 [SG]</b>								
	2.0 TDI, TDI 4Motion, TFSI, TFSI 4Motion	04.15→	62/75/103/110/ 132/150			0 986 134 004	← 41	
						0 986 135 004	→ 41	
	2.0 TDI	04.15→	62/75/103/110/132/150			1 987 477 260	↔ 1303	
	2.0 TFSI	04.15→	62/75/103/110/132/150			1 987 477 260	↔ 1303	
	2.0 TDI, TDI 4Motion, TFSI, TFSI 4Motion	04.15→	62/75/103/110/ 132/150		LAB	0 986 594 504		
					RAB	0 986 594 505		
<b>CC [358]</b>								
	1.4 TSI	11.11→	110/118	PR-Code 1ZM, PR-Code 1ZG	312	0 986 473 384	← 53,94	F 026 A06 106 <sup>7</sup>
						0 986 473 384	← 53,94	1 987 470 506 <sup>8</sup>
						0 986 474 384	→ 53,94	F 026 A06 106 <sup>7</sup>
	1.8 TSI	11.11→	112/118	PR-Code 1ZM, PR-Code 1ZG	312	0 986 473 384	← 53,94	F 026 A06 106 <sup>7</sup>
						0 986 473 384	← 53,94	1 987 470 506 <sup>8</sup>
						0 986 474 384	→ 53,94	F 026 A06 106 <sup>7</sup>
	2.0 TDI, TDI 4Motion, TSI	11.11→	100/103/ 110/125/ 130/135/155	PR-Code 1ZM, PR-Code 1ZG	312	0 986 473 384	← 53,94	F 026 A06 106 <sup>7</sup>
						0 986 473 384	← 53,94	1 987 470 506 <sup>8</sup>
						0 986 474 384	→ 53,94	F 026 A06 106 <sup>7</sup>
	3.6 FSI 4Motion	11.11→	220	PR-Code 1ZM, PR-Code 1ZG	312	0 986 473 384	← 53,94	F 026 A06 106 <sup>7</sup>
						0 986 473 384	← 53,94	1 987 470 506 <sup>8</sup>
						0 986 474 384	→ 53,94	F 026 A06 106 <sup>7</sup>
	1.4 TSI	11.11→	110/118	PR-Code 2EA	B31			1 987 474 496 <sup>8</sup>
	1.8 TSI	11.11→	112/118	PR-Code 2EA	B31			1 987 474 496 <sup>8</sup>
	2.0 TDI	11.11→	100/103/ 110/125/ 130/135/155	PR-Code 2EA	B31			1 987 474 496 <sup>8</sup>
	2.0 TDI 4Motion							
	2.0 TSI							
	3.6 FSI 4Motion	11.11→	220	PR-Code 2EA	B31			1 987 474 496 <sup>8</sup>
	1.4 TSI	11.11→	110/118		LAB	0 986 594 504 <sup>3</sup>		
					RAB	0 986 594 561 <sup>4</sup>		
						0 986 594 505 <sup>3</sup>		
						0 986 594 560 <sup>4</sup>		
	1.8 TSI	11.11→	112/118		LAB	0 986 594 504 <sup>3</sup>		
					RAB	0 986 594 561 <sup>4</sup>		
						0 986 594 505 <sup>3</sup>		
						0 986 594 560 <sup>4</sup>		
	2.0 TDI	11.11→	100		LAB	0 986 594 504 <sup>3</sup>		
					RAB	0 986 594 561 <sup>4</sup>		
						0 986 594 505 <sup>3</sup>		
						0 986 594 560 <sup>4</sup>		
			103		LAB	0 986 594 561 <sup>4</sup>		
					RAB	0 986 594 505 <sup>3</sup>		
						0 986 594 560 <sup>4</sup>		
			125		LAB	0 986 594 561 <sup>4</sup>		
					RAB	0 986 594 560 <sup>4</sup>		





		S							
<b>VW CC [358]</b>									
2.0 TDI		12.12→	130	LAB			0986 594 561 <sup>4</sup>		
							RAB		
							0986 594 560 <sup>4</sup>		
		05.15→	110	LAB			0986 594 504 <sup>3</sup>		
							RAB		
							0986 594 560 <sup>4</sup>		
2.0 TDI		11.11→	103	LAB			0986 594 504 <sup>3</sup>		
2.0 TDI 4Motion			125	LAB			0986 594 504 <sup>3</sup>		
							RAB		
							0986 594 505 <sup>3</sup>		
							0986 594 525 <sup>4</sup>		
		12.12→	130	LAB			0986 594 504 <sup>3</sup>		
2.0 TDI		11.11→	135/155	LAB			0986 594 504 <sup>3</sup>		
2.0 TSI				LAB			0986 594 561 <sup>4</sup>		
							RAB		
							0986 594 560 <sup>4</sup>		
2.0 TDI 4Motion		11.11→	103	LAB			0986 594 524 <sup>4</sup>		
							RAB		
							0986 594 525 <sup>4</sup>		
		12.12→	130	LAB			0986 594 524 <sup>4</sup>		
							0986 594 505 <sup>3</sup>		
							0986 594 525 <sup>4</sup>		
3.6 FSI 4Motion		11.11→	220	LAB			0986 594 504 <sup>3</sup>		
							RAB		
							0986 594 505 <sup>3</sup>		
							0986 594 525 <sup>4</sup>		
<b>Corrado [50]</b>									
2.0		04.93-09.94	85	1LY			0986 472 669	→ 54	1987 474 496 <sup>8</sup>
							0986 474 669		
		04.93-07.95	85	1LY			0986 471 669	← 54	1987 470 287 <sup>7</sup>
							0986 473 669		
							0986 472 669	→ 54	1987 470 287 <sup>7</sup>
							0986 474 669		
				228			0986 473 687	← 54	1987 470 287 <sup>7</sup>
							0986 473 687	← 54	1987 474 496 <sup>8</sup>
							0986 474 687	→ 54	1987 470 287 <sup>7</sup>
		10.94-07.95	85	1LY			0986 471 669	← 54	1987 474 496 <sup>8</sup>
							0986 473 669		
2.0 16V		08.91-07.95	100	1LY			0986 471 669	← 54	1987 470 287 <sup>7</sup>
							RAB	0986 473 669	
							0986 472 669	→ 54	1987 470 287 <sup>7</sup>
							0986 474 669		
				228			0986 473 687	← 54	1987 470 287 <sup>7</sup>
							0986 473 687	← 54	1987 474 496 <sup>8</sup>
							0986 474 687	→ 54	1987 470 287 <sup>7</sup>
2.8		08.91-07.95	128	1LY			0986 471 669	← 54	1987 470 287 <sup>7</sup>
							RAB	0986 473 669	
							0986 472 669	→ 54	1987 470 287 <sup>7</sup>
							0986 474 669		
				228			0986 473 687	← 54	1987 470 287 <sup>7</sup>
							0986 473 687	← 54	1987 474 496 <sup>8</sup>
							0986 474 687	→ 54	1987 470 287 <sup>7</sup>
2.9		08.91-07.95	140	1LY			0986 471 669	← 54	1987 470 287 <sup>7</sup>
							RAB	0986 473 669	
							0986 472 669	→ 54	1987 470 287 <sup>7</sup>
							0986 474 669		
				228			0986 473 687	← 54	1987 470 287 <sup>7</sup>
							0986 473 687	← 54	1987 474 496 <sup>8</sup>
							0986 474 687	→ 54	1987 470 287 <sup>7</sup>





































































		S							
	2.0 2.0 16V	08.91-07.95	85/100				0 986 474 875	← 38	1 987 470 040 <sup>7</sup>
							0 986 474 875	← 38	1 987 474 496 <sup>8</sup>
							0 986 474 876	→ 38	1 987 470 040 <sup>7</sup>
	2.8	08.91-07.95	128				0 986 474 875	← 38	1 987 470 040 <sup>7</sup>
							0 986 474 875	← 38	1 987 474 496 <sup>8</sup>
							0 986 474 876	→ 38	1 987 470 040 <sup>7</sup>
	2.9	08.91-07.95	140				0 986 474 875	← 38	1 987 470 040 <sup>7</sup>
							0 986 474 875	← 38	1 987 474 496 <sup>8</sup>
							0 986 474 876	→ 38	1 987 470 040 <sup>7</sup>
	2.0, 16V	08.91-07.95	85/100				1 987 477 162		1613
	2.9	08.91-07.95	140				1 987 477 162		↔ 1613
<b>Crafter 30 [2E, 2F]</b>									
	2.0 BiTDI	05.11→	80/100/				0 204 004 519	← 51	
	2.0 TDI		105/120				0 986 134 046		
							0 204 004 520	→ 51	
							0 986 135 046		
	2.5 TDI	04.06→	65/80/100/				0 204 004 519	← 51	
			120				0 986 134 046		
							0 204 004 520	→ 51	
							0 986 135 046		
	2.5 TDI	04.06-05.11	65/80/100/				1 987 482 032		↔ 1666
			120	PR-Code UH0	FLR		1 987 482 029		2522
				PR-Code UH1	FLR		1 987 482 031		2425
					FMR		1 987 482 030		1771
				PR-Code UH1	FKR		1 987 482 027		1468
					FMR		1 987 482 028		1867
	2.0 BiTDI, TDI	05.11-12.11	80/100/105/120				0 265 009 588 <sup>3</sup>		
	2.5 TDI	04.06-12.11	65/80/100/120				0 265 009 588 <sup>3</sup>		
<b>Crafter 30 [2E,2F]</b>									
	2.0 BiTDI	10.13→	120				0 204 004 519	← 51	
							0 986 134 046		
							0 204 004 520	→ 51	
							0 986 135 046		
<b>Crafter 35 [2E, 2F]</b>									
	2.0 BiTDI	05.11→	80/100/				0 204 004 519	← 51	
	2.0 TDI		105/120				0 986 134 046		
							0 204 004 520	→ 51	
							0 986 135 046		
	2.5 TDI	04.06→	65/80/100/				0 204 004 519	← 51	
			120				0 986 134 046		
							0 204 004 520	→ 51	
							0 986 135 046		



		S							
◀ VW Crafter 35 [2E, 2F]									
	2.5 TDI	04.06-05.11	65/80/100/120				1987 482 032	↔	1666
				PR-Code UH0	FLR		1987 482 029		2522
				PR-Code UH1	FLR		1987 482 031		2425
					FMR		1987 482 030		1771
				PR-Code UH1	FKR		1987 482 027		1468
					FMR		1987 482 028		1867
	2.0 BitDI, TDI	05.11-12.11	80/100/105/120				0 265 009 588 <sup>3</sup>		
	2.5 TDI	04.06-12.11	65/80/100/120				0 265 009 588 <sup>3</sup>		
<b>Crafter 35 [2E,2F]</b>									
	2.0 BitDI	05.11→	84/120				0 204 004 519	←	51
	2.0 TDI						0 986 134 046	↻	
							0 204 004 520	→	51
							0 986 135 046	↻	
<b>Crafter 50 [2E, 2F]</b>									
	2.0 BitDI	05.11→	80/100/105/120				0 986 134 035	↻ ←	52
	2.0 TDI						0 986 135 035	↻ →	52
	2.5 TDI	04.06→	80/100/120				0 986 134 035	↻ ←	52
							0 986 135 035	↻ →	52
	2.5 TDI	04.06-03.07	80/100/120	Fg.-Nr. →2F..7..016 102, →2E..7..032 951	TW		1987 482 034	↔	1432
		04.06-05.11	80/100/120		TW		1987 482 033	↔	1394
				PR-Code UH0	FLR		1987 482 029		2522
				PR-Code UH1	FLR		1987 482 031		2425
					FMR		1987 482 030		1771
				PR-Code UH1	FKR		1987 482 027		1468
					FMR		1987 482 028		1867
	2.0 BitDI, TDI	05.11-12.11	80/100/105/120				0 265 009 588 <sup>3</sup>		
	2.5 TDI	04.06-12.11	80/100/120				0 265 009 588 <sup>3</sup>		
<b>Crafter 50 [2E,2F]</b>									
	2.0 BitDI	10.13→	84/120				0 986 134 035	↻ ←	52
	2.0 TDI						0 986 135 035	↻ →	52
<b>e-Golf [BE1]</b>									
		03.14→	85		LAB		0 986 594 500 <sup>3</sup>		
					RAB		0 986 594 501 <sup>3</sup>		
				PR-Code 8T0, PR-Code 8T2, PR-Code 8T6	FPA		0 986 594 526 <sup>4</sup>		
<b>Eos [1F7]</b>									
	1.4 TSI	11.07-11.10	90/118				0 986 134 257	↻ ←	F 026 A03 545 <sup>7</sup>
							0 986 134 257	↻ ←	1 987 470 506 <sup>8</sup>
							0 986 135 257	↻ →	F 026 A03 545 <sup>7</sup>

		S								
<b>1.4 TSI</b>	11.07-11.10	90/118	228	0986 473 071		54	1987 470 506 <sup>B</sup>			
				0986 474 071		54	1987 470 506 <sup>B</sup>			
				288,312	0986 473 384		53,94	F 026 A06 106 <sup>7</sup>		
				0986 473 384		53,94	1987 470 506 <sup>B</sup>			
				0986 474 384		53,94	F 026 A06 106 <sup>7</sup>			
<b>1.6 FSI</b>	05.06-05.08	85	0986 473 384		53,94	F 026 A06 106 <sup>7</sup>				
			0986 473 384		53,94	1987 470 506 <sup>B</sup>				
			0986 474 384		53,94	F 026 A06 106 <sup>7</sup>				
<b>2.0 FSI</b>	05.06-05.08	110	0986 473 384		53,94	F 026 A06 106 <sup>7</sup>				
			0986 473 384		53,94	1987 470 506 <sup>B</sup>				
			0986 474 384		53,94	F 026 A06 106 <sup>7</sup>				
			09.06-11.09	147	0986 135 257			1987 470 506 <sup>B</sup>		
	09.06→	147	0986 134 257			F 026 A03 545 <sup>7</sup>				
				0986 135 257			F 026 A03 545 <sup>7</sup>			
				228	0986 473 071		54	1987 470 506 <sup>B</sup>		
				288,312	0986 473 384		53,94	F 026 A06 106 <sup>7</sup>		
					0986 473 384		53,94	1987 470 506 <sup>B</sup>		
					0986 474 384		53,94	F 026 A06 106 <sup>7</sup>		
		09.07→	147		0986 134 257			1987 470 506 <sup>B</sup>		
	<b>2.0 FSI, TSI</b>	09.06→	147	228	0986 474 071		54	1987 470 506 <sup>B</sup>		
<b>2.0 TDI</b>	05.06-05.08	103	0986 473 384		53,94	F 026 A06 106 <sup>7</sup>				
			0986 473 384		53,94	1987 470 506 <sup>B</sup>				
			0986 474 384		53,94	F 026 A06 106 <sup>7</sup>				
			05.08-11.10	103	0986 134 257			F 026 A03 545 <sup>7</sup>		
				0986 134 257			1987 470 506 <sup>B</sup>			
					0986 135 257		F 026 A03 545 <sup>7</sup>			
				228	0986 473 071		54	1987 470 506 <sup>B</sup>		
				288,312	0986 474 071		54	1987 470 506 <sup>B</sup>		
					0986 473 384		53,94	F 026 A06 106 <sup>7</sup>		
					0986 473 384		53,94	1987 470 506 <sup>B</sup>		
					0986 474 384		53,94	F 026 A06 106 <sup>7</sup>		
	<b>2.0 TSI</b>	05.06-11.10	147	PR-Code 1LK	0986 134 257			F 026 A03 545 <sup>7</sup>		
0986 134 257							1987 470 506 <sup>B</sup>			
0986 135 257							F 026 A03 545 <sup>7</sup>			
288,312					0986 473 384		53,94	F 026 A06 106 <sup>7</sup>		
				PR-Code 1ZA, PR-Code 1ZE, PR-Code 1ZD, PR-Code 1LJ	0986 473 384		53,94	1987 470 506 <sup>B</sup>		
					0986 473 384		53,94	F 026 A06 106 <sup>7</sup>		
					0986 474 384		53,94	F 026 A06 106 <sup>7</sup>		
		05.08-11.10	147		0986 134 257			F 026 A03 545 <sup>7</sup>		
					0986 134 257			1987 470 506 <sup>B</sup>		
					0986 135 257			F 026 A03 545 <sup>7</sup>		
				228	0986 473 071		54	1987 470 506 <sup>B</sup>		
				288,312	0986 473 384		53,94	F 026 A06 106 <sup>7</sup>		
				0986 473 384		53,94	1987 470 506 <sup>B</sup>			
				0986 474 384		53,94	1987 470 506 <sup>B</sup>			
	11.09-11.10	155		0986 134 257			F 026 A03 545 <sup>7</sup>			
				0986 134 257			1987 470 506 <sup>B</sup>			
				0986 135 257			F 026 A03 545 <sup>7</sup>			
			228	0986 473 071		54	1987 470 506 <sup>B</sup>			
			288,312	0986 474 071		54	1987 470 506 <sup>B</sup>			
				0986 473 384		53,94	F 026 A06 106 <sup>7</sup>			
				0986 473 384		53,94	1987 470 506 <sup>B</sup>			
				0986 474 384		53,94	F 026 A06 106 <sup>7</sup>			
<b>3.2</b>	05.06-11.10	184	0986 134 257			F 026 A03 545 <sup>7</sup>				
			0986 134 257			1987 470 506 <sup>B</sup>				
			0986 135 257			F 026 A03 545 <sup>7</sup>				
			228	0986 473 071		54	1987 470 506 <sup>B</sup>			
				0986 474 071		54	1987 470 506 <sup>B</sup>			
			288,312	0986 473 384		53,94	F 026 A06 106 <sup>7</sup>			
				0986 473 384		53,94	1987 470 506 <sup>B</sup>			
				0986 474 384		53,94	F 026 A06 106 <sup>7</sup>			
<b>3.2 FSI</b>	05.07-05.08	184	0986 473 384		53,94	F 026 A06 106 <sup>7</sup>				
			0986 473 384		53,94	1987 470 506 <sup>B</sup>				
			0986 474 384		53,94	F 026 A06 106 <sup>7</sup>				



		S							
	◀ VW Eos [1F7]								
<b>3.6</b>		05.09-11.10	191				0986 <b>134 257</b>	 ←	F 026 <b>A03 545</b> <sup>7</sup>
							0986 <b>134 257</b>	 ←	1 987 <b>470 506</b> <sup>8</sup>
							0986 <b>135 257</b>	 →	F 026 <b>A03 545</b> <sup>7</sup>
						228	0986 <b>473 071</b>	 ← 54	1 987 <b>470 506</b> <sup>8</sup>
							0986 <b>474 071</b>	 → 54	1 987 <b>470 506</b> <sup>8</sup>
						288,312	0986 <b>473 384</b>	 ← 53,94	F 026 <b>A06 106</b> <sup>7</sup>
							0986 <b>473 384</b>	 ← 53,94	1 987 <b>470 506</b> <sup>8</sup>
							0986 <b>474 384</b>	 → 53,94	F 026 <b>A06 106</b> <sup>7</sup>
									
	<b>1.4 TSI</b>	11.07-11.10	90/118	PR-Code 1KD	D53		0986 <b>473 381</b>	 ← 38,1	1 987 <b>470 040</b> <sup>7</sup>
							0986 <b>473 381</b>	 ← 38,1	1 987 <b>474 496</b> <sup>8</sup>
							0986 <b>474 381</b>	 → 38,1	1 987 <b>470 040</b> <sup>7</sup>
				PR-Code 1KJ			0986 <b>473 448</b>	 ← 41	1 987 <b>474 496</b> <sup>8</sup>
							0986 <b>474 448</b>	 → 41	1 987 <b>474 496</b> <sup>8</sup>
				PR-Code 1KS			0986 <b>134 203</b>	 ← 38	
							0986 <b>135 203</b>	 → 38	
				PR-Code 1KZ			0986 <b>134 048</b>	 ← 38	1 987 <b>474 496</b> <sup>8</sup>
							0986 <b>135 048</b>	 → 38	1 987 <b>474 496</b> <sup>8</sup>
				PR-Code 2EA	B31		0986 <b>134 297</b>	 ←	1 987 <b>474 496</b> <sup>8</sup>
							0986 <b>135 297</b>	 →	1 987 <b>474 496</b> <sup>8</sup>
<b>1.6 FSI</b>		05.06-05.08	85	PR-Code 1KD	D53		0986 <b>473 381</b>	 ← 38,1	1 987 <b>470 040</b> <sup>7</sup>
							0986 <b>473 381</b>	 ← 38,1	1 987 <b>474 496</b> <sup>8</sup>
							0986 <b>474 381</b>	 → 38,1	1 987 <b>470 040</b> <sup>7</sup>
				PR-Code 1KJ			0986 <b>473 448</b>	 ← 41	1 987 <b>474 496</b> <sup>8</sup>
							0986 <b>474 448</b>	 → 41	1 987 <b>474 496</b> <sup>8</sup>
				PR-Code 1KZ			0986 <b>134 048</b>	 ← 38	1 987 <b>474 496</b> <sup>8</sup>
							0986 <b>135 048</b>	 → 38	1 987 <b>474 496</b> <sup>8</sup>
<b>2.0 FSI</b>		05.06-05.08	110	PR-Code 1KD	D53		0986 <b>473 381</b>	 ← 38,1	1 987 <b>470 040</b> <sup>7</sup>
							0986 <b>473 381</b>	 ← 38,1	1 987 <b>474 496</b> <sup>8</sup>
							0986 <b>474 381</b>	 → 38,1	1 987 <b>470 040</b> <sup>7</sup>
				PR-Code 1KJ			0986 <b>473 448</b>	 ← 41	1 987 <b>474 496</b> <sup>8</sup>
							0986 <b>474 448</b>	 → 41	1 987 <b>474 496</b> <sup>8</sup>
				PR-Code 1KZ			0986 <b>134 048</b>	 ← 38	1 987 <b>474 496</b> <sup>8</sup>
							0986 <b>135 048</b>	 → 38	1 987 <b>474 496</b> <sup>8</sup>
				PR-Code 1KD	D53		0986 <b>473 381</b>	 ← 38,1	1 987 <b>470 040</b> <sup>7</sup>
							0986 <b>474 381</b>	 → 38,1	1 987 <b>474 496</b> <sup>8</sup>
				PR-Code 1KJ			0986 <b>473 448</b>	 ← 41	1 987 <b>474 496</b> <sup>8</sup>
							0986 <b>474 448</b>	 → 41	1 987 <b>474 496</b> <sup>8</sup>
							0986 <b>134 203</b>	 ← 38	
							0986 <b>473 381</b>	 ← 38,1	1 987 <b>470 040</b> <sup>7</sup>
							0986 <b>135 203</b>	 → 38	
							0986 <b>474 381</b>	 → 38,1	1 987 <b>474 496</b> <sup>8</sup>
							0986 <b>473 448</b>	 ← 41	1 987 <b>474 496</b> <sup>8</sup>
							0986 <b>474 448</b>	 → 41	1 987 <b>474 496</b> <sup>8</sup>
<b>2.0 FSI</b>		05.06-11.10	147	PR-Code 1KD	D53		0986 <b>474 381</b>	 → 38,1	1 987 <b>470 040</b> <sup>7</sup>
<b>2.0 TSI</b>				PR-Code 1KZ			0986 <b>134 048</b>	 ← 38	1 987 <b>474 496</b> <sup>8</sup>
							0986 <b>135 048</b>	 → 38	1 987 <b>474 496</b> <sup>8</sup>
				PR-Code 2EA	B31		0986 <b>134 297</b>	 ←	1 987 <b>474 496</b> <sup>8</sup>
							0986 <b>135 297</b>	 →	1 987 <b>474 496</b> <sup>8</sup>
							0986 <b>474 381</b>	 → 38,1	1 987 <b>470 040</b> <sup>7</sup>
<b>2.0 TDI</b>		05.06-11.10	103	PR-Code 1KD	D53		0986 <b>473 381</b>	 ← 38,1	1 987 <b>470 040</b> <sup>7</sup>
							0986 <b>473 381</b>	 ← 38,1	1 987 <b>474 496</b> <sup>8</sup>
							0986 <b>474 381</b>	 → 38,1	1 987 <b>470 040</b> <sup>7</sup>
				PR-Code 1KJ			0986 <b>473 448</b>	 ← 41	1 987 <b>474 496</b> <sup>8</sup>
							0986 <b>474 448</b>	 → 41	1 987 <b>474 496</b> <sup>8</sup>
				PR-Code 1KZ			0986 <b>134 048</b>	 ← 38	1 987 <b>474 496</b> <sup>8</sup>
							0986 <b>135 048</b>	 → 38	1 987 <b>474 496</b> <sup>8</sup>
				PR-Code 1KS			0986 <b>134 203</b>	 ← 38	
							0986 <b>135 203</b>	→ 38	
				PR-Code 2EA	B31		0986 <b>134 297</b>	←	1 987 <b>474 496</b> <sup>8</sup>
							0986 <b>135 297</b>	→	1 987 <b>474 496</b> <sup>8</sup>

	S										
2.0 TSI	05.06-11.10	147	PR-Code 1KD	D53	0 986 473 381		38,1	1 987 470 040 <sup>7</sup>			
					0 986 473 381		38,1	1 987 474 496 <sup>B</sup>			
					PR-Code 1KJ	0 986 473 448		41	1 987 474 496 <sup>B</sup>		
					0 986 474 448		41	1 987 474 496 <sup>B</sup>			
					PR-Code 1KS	0 986 134 203		38			
	05.08-11.09	147				0 986 135 203		38			
						0 986 134 203		38			
						0 986 473 381		38,1	1 987 470 040 <sup>7</sup>		
						0 986 135 203		38			
						0 986 474 381		38,1	1 987 474 496 <sup>B</sup>		
	11.09-11.10	155				0 986 134 203		38			
						0 986 473 381		38,1	1 987 470 040 <sup>7</sup>		
						0 986 473 381		38,1	1 987 474 496 <sup>B</sup>		
						0 986 135 203		38			
						0 986 474 381		38,1	1 987 470 040 <sup>7</sup>		
PR-Code 1KD						D53	0 986 473 381		38,1	1 987 470 040 <sup>7</sup>	
0 986 473 381							38,1	1 987 474 496 <sup>B</sup>			
0 986 474 381							38,1	1 987 470 040 <sup>7</sup>			
PR-Code 2EA						B31	0 986 134 297			1 987 474 496 <sup>B</sup>	
0 986 135 297								1 987 474 496 <sup>B</sup>			
3.2	05.06-11.10	184	PR-Code 1KD	D53	0 986 473 381		38,1	1 987 470 040 <sup>7</sup>			
					0 986 473 381		38,1	1 987 474 496 <sup>B</sup>			
					0 986 474 381		38,1	1 987 470 040 <sup>7</sup>			
					PR-Code 1KJ	0 986 473 448		41	1 987 474 496 <sup>B</sup>		
					0 986 474 448		41	1 987 474 496 <sup>B</sup>			
					PR-Code 1KS	0 986 134 203		38			
					0 986 135 203		38				
					PR-Code 1KZ	0 986 134 048		38	1 987 474 496 <sup>B</sup>		
					0 986 135 048		38	1 987 474 496 <sup>B</sup>			
					PR-Code 2EA	B31	0 986 134 297			1 987 474 496 <sup>B</sup>	
0 986 135 297			1 987 474 496 <sup>B</sup>								
3.2 FSI	05.07-05.08	184	PR-Code 1KD		0 986 473 381		38,1	1 987 470 040 <sup>7</sup>			
					0 986 473 381		38,1	1 987 474 496 <sup>B</sup>			
					0 986 474 381		38,1	1 987 470 040 <sup>7</sup>			
3.6	05.09-11.10	191	PR-Code 1KD	D53	0 986 473 381		38,1	1 987 470 040 <sup>7</sup>			
					0 986 473 381		38,1	1 987 474 496 <sup>B</sup>			
					0 986 474 381		38,1	1 987 470 040 <sup>7</sup>			
					PR-Code 1KJ	0 986 473 448		41	1 987 474 496 <sup>B</sup>		
					0 986 474 448		41	1 987 474 496 <sup>B</sup>			
					PR-Code 1KS	0 986 134 203		38			
					0 986 135 203		38				
					PR-Code 1KZ	0 986 134 048		38	1 987 474 496 <sup>B</sup>		
					0 986 135 048		38	1 987 474 496 <sup>B</sup>			
					PR-Code 2EA	B31	0 986 134 297			1 987 474 496 <sup>B</sup>	
0 986 135 297			1 987 474 496 <sup>B</sup>								
					1 987 477 958		1447				
					1.4 TSI	11.07-11.10	90/118	1 987 477 958		1447	
					1.6 FSI	05.06-05.08	85	1 987 477 958		1447	
					2.0 FSI	05.06→	103/110/147/155	1 987 477 958		1447	
					2.0 TDI	05.06-11.10	103/110/147/155	1 987 477 958		1447	
					2.0 TSI	05.06-11.10	103/110/147/155	1 987 477 958		1447	
					3.2	05.06-11.10	184	1 987 477 958		1447	
					3.2 FSI	05.07-05.08	184	1 987 477 958		1447	
3.6	05.09-11.10	191	1 987 477 958		1447						
	1.4 TSI	11.07-11.10	90/118	LAB	0 986 594 504						
					0 986 594 506 <sup>4</sup>						
					RAB	0 986 594 505					
					0 986 594 507 <sup>4</sup>						



		S							
	◀ VW Eos [1F7]								
1.6 FSI		05.06-05.08	85			LAB	0986 594 504		
							0986 594 504 <sup>3</sup>		
							0986 594 506 <sup>4</sup>		
						RAB	0986 594 505		
							0986 594 505 <sup>3</sup>		
							0986 594 507 <sup>4</sup>		
2.0 FSI		05.06-05.08	103/110			LAB	0986 594 504		
							0986 594 504 <sup>3</sup>		
						RAB	0986 594 505		
							0986 594 505 <sup>3</sup>		
2.0 FSI		05.06-11.10	103/110			LAB	0986 594 506 <sup>4</sup>		
2.0 TDI						RAB	0986 594 507 <sup>4</sup>		
2.0 FSI		05.06→	147/155			LAB	0986 594 504		
2.0 TSI							0986 594 506 <sup>4</sup>		
						RAB	0986 594 505		
							0986 594 507 <sup>4</sup>		
2.0 TDI		05.06-05.08	103/110			LAB	0986 594 504 <sup>3</sup>		
						RAB	0986 594 505 <sup>3</sup>		
		05.06-11.10	103/110			LAB	0986 594 504		
						RAB	0986 594 505		
3.2		05.06-11.10	184			LAB	0986 594 504		
3.2 FSI							0986 594 506 <sup>4</sup>		
						RAB	0986 594 505		
							0986 594 507 <sup>4</sup>		
3.6		05.09-11.10	191			LAB	0986 594 504		
							0986 594 506 <sup>4</sup>		
						RAB	0986 594 505		
							0986 594 507 <sup>4</sup>		
<b>Eos [1F8]</b>									
	1.4 TSI	11.10→	90/118				0986 473 384		← 53,94 F 026 A06 106 <sup>7</sup>
							0986 473 384		← 53,94 1987 470 506 <sup>8</sup>
							0986 474 384		→ 53,94 F 026 A06 106 <sup>7</sup>
	2.0 TDI	11.10→	100/103/				0986 473 384		← 53,94 F 026 A06 106 <sup>7</sup>
	2.0 TSI		147/155				0986 473 384		← 53,94 1987 470 506 <sup>8</sup>
							0986 474 384		→ 53,94 F 026 A06 106 <sup>7</sup>
	1.4 TSI	11.10→	90/118	PR-Code 1KD	D53		0986 473 381		← 38,1 1987 470 040 <sup>7</sup>
							0986 473 381		← 38,1 1987 474 496 <sup>8</sup>
							0986 474 381		→ 38,1 1987 470 040 <sup>7</sup>
				PR-Code 1KS			0986 134 203		← 38
							0986 135 203		→ 38
	2.0 TDI	11.10→	100/103/	PR-Code 1KD	D53		0986 473 381		← 38,1 1987 470 040 <sup>7</sup>
	2.0 TSI		147/155				0986 473 381		← 38,1 1987 474 496 <sup>8</sup>
							0986 474 381		→ 38,1 1987 470 040 <sup>7</sup>
				PR-Code 1KS			0986 134 203		← 38
							0986 135 203		→ 38
	1.4 TSI	11.10→	90/118				1987 477 958		↔ 1447
	2.0 TDI	11.10→	100/103/147/155				1987 477 958		↔ 1447
	2.0 TSI	11.10→	100/103/147/155				1987 477 958		↔ 1447
	1.4 TSI	11.10→	90/118			FPA,LAB	0986 594 561 <sup>4</sup>		
						FPA,RAB	0986 594 560 <sup>4</sup>		
						FPA,LAB	0986 594 506 <sup>4</sup>		
						FPA,RAB	0986 594 507 <sup>4</sup>		
						LAB	0986 594 504 <sup>3</sup>		
						RAB	0986 594 505 <sup>3</sup>		































2.0 TDI	11.10→	100/103/			FPA,LAB	0 986 594 561 <sup>4</sup>		
2.0 TSI		147/155			FPA,RAB	0 986 594 560 <sup>4</sup>		
					FPA,LAB	0 986 594 506 <sup>4</sup>		
					FPA,RAB	0 986 594 507 <sup>4</sup>		
					LAB	0 986 594 504 <sup>3</sup>		
					RAB	0 986 594 505 <sup>3</sup>		
<b>e-up! [BL1]</b>								
	07.13→	60				0 986 473 071	← 54	1 987 470 506 <sup>8</sup>
						0 986 474 071	→ 54	1 987 470 506 <sup>8</sup>
	07.13→	60				0 986 475 433	↔ 19,05	
	07.13→	60			LAB	0 986 594 500 <sup>3</sup>		
						0 986 594 502 <sup>4</sup>		
					RAB	0 986 594 501 <sup>3</sup>		
						0 986 594 503 <sup>4</sup>		
<b>Eurovan [70]</b>								
	2.4D	07.93-08.98	57	Fg.-Nr. 70-P-160 001→	281	0 986 473 177	← 53,94	
						0 986 474 177	→ 53,94	
	2.8	05.00-06.03	150		284,FSB ATE	0 986 473 361	← 56,93	1 987 470 005 <sup>7</sup>
						0 986 473 361	← 56,93	1 987 470 506 <sup>8</sup>
						0 986 474 361	→ 56,93	1 987 470 005 <sup>7</sup>
				Fg.-Nr. 70-Y-000 001→	284,RSB LUC	0 986 473 806	← 54	
						0 986 473 807	→ 54	
		06.00-06.03	150	Fg.-Nr. 70-1-000 955→	326,FSB	0 986 473 184	← 57	1 987 470 005 <sup>7</sup>
						0 986 474 184	→ 57	1 987 470 005 <sup>7</sup>
		01.01-06.03	150		281,FSB			1 987 474 496 <sup>8</sup>
	2.4D	10.92-12.95	57			0 986 475 935	↔ 20,64	
	2.4D	01.96-08.98	57			0 986 473 073	← 38	1 987 470 040 <sup>7</sup>
						0 986 473 073	← 38	1 987 474 496 <sup>8</sup>
						0 986 474 073	→ 38	1 987 470 040 <sup>7</sup>
	2.8	05.00-06.03	150			0 986 473 073	← 38	1 987 470 040 <sup>7</sup>
						0 986 473 073	← 38	1 987 474 496 <sup>8</sup>
						0 986 474 073	→ 38	1 987 470 040 <sup>7</sup>
	2.8	05.00-06.03	150		294	1 987 477 707	↔ 953	
	2.4D	10.92-12.95	57	Fg.-Nr. →70-T 199 999		0 986 594 013 <sup>4</sup>		
		10.92-08.98	57			0 265 006 407 <sup>3</sup>		
		01.96-08.98	57	Fg.-Nr. 70-T-200 001→	LAB	0 265 006 408 <sup>4</sup>		
					RAB	0 265 006 409 <sup>4</sup>		
	2.8	05.96-08.01	103	Fg.-Nr. 70-T-200 001→	RAB	0 265 006 409 <sup>4</sup>		
		05.00-06.03	150			0 265 006 407 <sup>3</sup>		
					LAB,MVB	0 265 006 508 <sup>4</sup>		
					LAB,MVB	0 265 006 408 <sup>4</sup>		





		S								
	◀ VW Eurovan [70]									
2.8		05.00-06.03	150			MVB,RAB	0 265 006 510 <sup>4</sup>			
						MVB,RAB	0 265 006 409 <sup>4</sup>			
<b>Fox</b>										
	1.3	07.87-12.95	48			ATE	0 986 475 290	↔ 14,29		
	1.6	10.03→	69				0 986 BB3 035	↔		
							0 986 475 260	↔ 17,46		
	1.6	10.03→	69			LAB	0 986 594 500 <sup>3</sup>			
<b>Fox [Fase I]</b>										
	1.0	10.03-04.05	53				0 986 BB3 035	↔		
							0 986 475 260	↔ 17,46		
	1.0	10.03-04.05	53			LAB	0 986 594 500 <sup>3</sup>			
							0 986 594 502 <sup>4</sup>			
						RAB	0 986 594 501 <sup>3</sup>			
							0 986 594 503 <sup>4</sup>			
<b>Fox [5Z1]</b>										
	1.2	04.05-12.12	40/44	PR-Code 1ZF	252		0 986 473 071	← 54	1 987 470 506 <sup>8</sup>	
							0 986 474 071	→ 54	1 987 470 506 <sup>8</sup>	
				PR-Code 1ZN			0 204 102 580	← 48	0 204 104 144 <sup>7</sup>	
							0 986 134 020			
							0 204 102 581	→ 48	0 204 104 144 <sup>7</sup>	
							0 204 103 581			
							0 986 135 020			
	1.4	04.05-12.12	51/55	PR-Code 1ZF	252		0 986 473 071	← 54	1 987 470 506 <sup>8</sup>	
	1.4 TDI						0 986 474 071	→ 54	1 987 470 506 <sup>8</sup>	
				PR-Code 1ZN			0 204 102 580	← 48	0 204 104 144 <sup>7</sup>	
							0 986 134 020			
							0 204 102 581	→ 48	0 204 104 144 <sup>7</sup>	
							0 204 103 581			
							0 986 135 020			
	1.2	04.05-12.12	40/44				0 986 475 260	↔ 17,46		
	1.4, TDI	04.05-12.12	51/55				0 986 475 260	↔ 17,46		
	1.2	04.05-12.12	40/44				1 987 482 446	↔ 1580		
	1.4	04.05-12.12	51/55				1 987 482 446	↔ 1580		
	1.4 TDI	04.05-12.12	51/55				1 987 482 446	↔ 1580		
		1.2	04.05-12.12	40/44		LAB	0 986 594 500 <sup>3</sup>			
							0 986 594 502 <sup>4</sup>			
						RAB	0 986 594 501 <sup>3</sup>			
							0 986 594 503 <sup>4</sup>			
	1.4	04.05-12.12	51/55			LAB	0 986 594 500 <sup>3</sup>			
	1.4 TDI						0 986 594 502 <sup>4</sup>			



		S							
1.4		04.05-12.12	51/55			RAB	0 986 594 501 <sup>3</sup>		
1.4 TDI							0 986 594 503 <sup>4</sup>		
<b>Gol III [5X]</b>									
									
 1.6 Mi		09.99-08.05	65				0 265 006 218 <sup>3</sup>		
						LAB	0 265 006 222 <sup>4</sup>		
							0 265 006 410 <sup>4</sup>		
						RAB	0 265 006 221 <sup>4</sup>		
							0 265 006 411 <sup>4</sup>		
<b>Golf</b>									
									
 2.0		03.95-10.99	85	PR-Code 1LJ, PR-Code 1ZQ	312		0 986 471 923	← 54	1 987 470 506 <sup>B</sup>
							0 986 473 923		
							0 986 471 924	→ 54	1 987 470 506 <sup>B</sup>
							0 986 473 924		
				PR-Code 1LN, PR-Code 1LE, PR-Code 1ZE, PR-Code 1ZD, PR-Code 1ZH	288		0 986 471 923	← 54	1 987 470 506 <sup>B</sup>
							0 986 473 923		
							0 986 471 924	→ 54	1 987 470 506 <sup>B</sup>
							0 986 473 924		
				PR-Code 1LQ, PR-Code 1ZF, PR-Code 1LR, PR-Code 1LS, PR-Code 1ZM, PR-Code 1ZP	228,252		0 986 473 071	 ← 54	1 987 470 506 <sup>B</sup>
							0 986 474 071	 → 54	1 987 470 506 <sup>B</sup>
									
 2.0		03.95-10.99	85	PR-Code 1KK, PR-Code 1KS, PR-Code 1KV	232		0 986 473 099	 ← 38,1	1 987 470 040 <sup>7</sup>
							0 986 473 099	 ← 38,1	1 987 474 496 <sup>B</sup>
							0 986 474 099	 → 38,1	1 987 470 040 <sup>7</sup>
				PR-Code 1KY	252		0 986 473 139	 ← 38,1	1 987 470 040 <sup>7</sup>
							0 986 473 139	 ← 38,1	1 987 474 496 <sup>B</sup>
							0 986 474 139	 → 38,1	1 987 470 040 <sup>7</sup>
									
 2.0		03.95-10.99	85				1 987 477 698	↔ 1693	
 2.0		03.95-10.99	85				0 986 594 004 <sup>4</sup>		
						LAB	0 986 594 001 <sup>3</sup>		
						RAB	0 986 594 000 <sup>3</sup>		
<b>Golf Alltrack [BA5]</b>									
									
 1.6 TDI 4Motion		11.14→	81			FPA,LAB	0 986 594 524 <sup>4</sup>		
						FPA,RAB	0 986 594 525 <sup>4</sup>		
						LAB	0 986 594 500 <sup>3</sup>		
						RAB	0 986 594 501 <sup>3</sup>		
				PR-Code 8T0, PR-Code 8T2, PR-Code 8T6		FPA,LAB	0 986 594 504 <sup>4</sup>		
						FPA,RAB	0 986 594 505 <sup>4</sup>		
				PR-Code 8T3, PR-Code 8T5, PR-Code 8T7, PR-Code 8T8		FPA,LAB	0 986 594 524 <sup>4</sup>		
						FPA,RAB	0 986 594 525 <sup>4</sup>		
1.8 TFSI		12.14→	132			LAB	0 986 594 500 <sup>3</sup>		
						RAB	0 986 594 501 <sup>3</sup>		
				PR-Code 8T0, PR-Code 8T2, PR-Code 8T6		FPA	0 986 594 526 <sup>4</sup>		
2.0 GTD 4Motion		12.14→	135			LAB	0 986 594 500 <sup>3</sup>		
						RAB	0 986 594 501 <sup>3</sup>		



<b>◀ VW Golf Alltrack [BA5]</b>								
	2.0 GTD 4Motion	12.14→	135	PR-Code 8T0, PR-Code 8T2, PR-Code 8T6	FPA	0986 594 526 <sup>4</sup>		
	2.0 TDI 4Motion	12.14→	110		FPA,LAB	0986 594 524 <sup>4</sup>		
					FPA,RAB	0986 594 525 <sup>4</sup>		
					LAB	0986 594 500 <sup>3</sup>		
					RAB	0986 594 501 <sup>3</sup>		
				PR-Code 8T0, PR-Code 8T2, PR-Code 8T6	FPA,LAB	0986 594 504 <sup>4</sup>		
					FPA,RAB	0986 594 505 <sup>4</sup>		
				PR-Code 8T3, PR-Code 8T5, PR-Code 8T7, PR-Code 8T8	FPA,LAB	0986 594 524 <sup>4</sup>		
					FPA,RAB	0986 594 525 <sup>4</sup>		
<b>Golf Cabriolet [1E, 1V]</b>								
	2.0	08.95-06.02	85			0986 471 669	← 54	1987 470 287 <sup>7</sup>
						0986 473 669		1987 474 496 <sup>8</sup>
						0986 472 669	→ 54	1987 470 287 <sup>7</sup>
						0986 474 669		
	2.0	08.95-06.02	85			0986 475 433	↔ 19,05	
	2.0	08.95-06.02	85			0986 473 072		1987 470 040 <sup>7</sup>
						0986 473 072		1987 474 496 <sup>8</sup>
						0986 474 072		1987 470 040 <sup>7</sup>
	2.0	08.95-06.02	85		SBR	1987 477 393	↔ 1616	
					TBR	1987 477 338	↔ 1498	
	2.0	08.95-06.02	85			0986 594 003 <sup>4</sup>		
					LAB	0986 594 001 <sup>3</sup>		
					RAB	0986 594 000 <sup>3</sup>		
<b>Golf I Bakkie [15, 16]</b>								
	1.6	06.96-08.07	60					0 204 104 144 <sup>7</sup>
				PR-Code 1ZE, PR-Code 1LJ, PR-Code 1ZP, PR-Code 1ZD	288,312	0986 473 384		F 026 A06 106 <sup>7</sup>
						0986 473 384		1987 470 506 <sup>8</sup>
						0986 474 384		F 026 A06 106 <sup>7</sup>
	1.6	06.81-12.96	60/63			0986 475 260	↔ 17,46	
	1.8	12.88-12.95	70			0986 475 260	↔ 17,46	
<b>Golf I [15, 16]</b>								
	1.3	06.96-06.99	48					0 204 104 144 <sup>7</sup>
	1.6 i	09.98→	74					0 204 104 144 <sup>7</sup>
	1.3	11.79-12.95	44		ATE	0986 475 290	↔ 14,29	
		06.96-06.99	48			0986 475 290	↔ 14,29	
	1.6	07.85-12.94	60		ATE	0986 475 290	↔ 14,29	
	1.6 i	09.98→	74			0986 475 260	↔ 17,46	
						0986 475 290	↔ 14,29	































		S							
1.8		01.88-12.97	70				0 986 475 260	↔ 17,46	
							ATE 0 986 475 290	↔ 14,29	
<b>Golf I [17]</b>									
	1.4	05.98-12.09	54						0 204 104 144 <sup>7</sup>
	1.4	05.98-12.09	54				0 986 475 290	↔ 14,29	
<b>Golf III</b>									
	2.0 Mi	01.94-07.98	85				0 986 471 669	← 54	1 987 470 287 <sup>7</sup>
							0 986 473 669		
							0 986 472 669	→ 54	1 987 470 287 <sup>7</sup>
							0 986 474 669		
	2.8 i VR6	07.94-12.97	120		1LM				0 204 104 144 <sup>7</sup>
					1LY		0 986 471 669	← 54	1 987 470 287 <sup>7</sup>
							0 986 473 669		1 987 474 496 <sup>8</sup>
							0 986 472 669	→ 54	1 987 470 287 <sup>7</sup>
							0 986 474 669		
					228		0 986 473 687	← 54	1 987 470 287 <sup>7</sup>
							0 986 473 687	← 54	1 987 474 496 <sup>8</sup>
							0 986 474 687	→ 54	1 987 470 287 <sup>7</sup>
					239				0 204 104 144 <sup>7</sup>
					256		0 986 474 880	← 54	1 987 470 287 <sup>7</sup>
							0 986 474 879	→ 54	1 987 470 287 <sup>7</sup>
							0 986 474 879	→ 54	1 987 474 496 <sup>8</sup>
					288,BSR		0 986 471 923	← 54	1 987 470 506 <sup>8</sup>
							0 986 473 923		
							0 986 471 924	→ 54	1 987 470 506 <sup>8</sup>
							0 986 473 924		
					288,BSR				1 987 470 506 <sup>8</sup>
	2.0 Mi	ABS 01.94-07.98	85		STB		F 026 009 433	↔ 19,05	
	2.8 i VR6	07.94-12.97	120				0 986 475 260	↔ 17,46	
							0 986 475 433	↔ 19,05	
							0 986 475 438	↔ 15,87	
	2.0 Mi	01.94-07.98	85		4SB		0 986 474 875	← 38	1 987 470 040 <sup>7</sup>
							0 986 474 876	→ 38	1 987 470 040 <sup>7</sup>
	2.8 i VR6	07.94-12.97	120		BSR,MTG		0 986 474 875	← 38	1 987 470 040 <sup>7</sup>
							0 986 474 875	← 38	1 987 474 496 <sup>8</sup>
							0 986 474 876	→ 38	1 987 470 040 <sup>7</sup>
					BSR,MTG		0 986 474 875	← 38	1 987 470 040 <sup>7</sup>
							0 986 474 875	← 38	1 987 474 496 <sup>8</sup>
							0 986 474 876	→ 38	1 987 470 040 <sup>7</sup>
					BSR				1 987 470 040 <sup>7</sup>
									1 987 474 496 <sup>8</sup>
	2.0 Mi	01.94-07.98	85		TBR		1 987 477 338	↔ 1498	
		05.95-07.98	85		4SB		1 987 477 393	↔ 1616	
	2.8 i VR6	07.94-10.94	120			Fg.-Nr. →1H..S..037 799	1 987 477 162	↔ 1613	
		11.94-12.97	120			Fg.-Nr. 1H..S..037 528→	1 987 477 393	↔ 1616	



◀ VW Golf III								
	2.8 iVR6	07.94-12.97	120		LAB	0986 594 001 <sup>3</sup>		
					RAB	0986 594 000 <sup>3</sup>		
		03.95-12.97	120	Fg.-Nr. 1H..SW385 335→, 1H..SW352 190→, 1H..SB088 705→			0986 594 003 <sup>4</sup>	
<b>Golf III Cabriolet [1E7]</b>								
	1.6	10.94-12.95	74			0986 474 880	← 54	1987 470 287 <sup>7</sup>
						0986 474 879	→ 54	1987 470 287 <sup>7</sup>
						0986 474 879	→ 54	1987 474 496 <sup>8</sup>
		12.95-04.96	74	Fg.-Nr. →1E..T..030 000		0986 474 880	← 54	1987 470 287 <sup>7</sup>
						0986 474 879	→ 54	1987 470 287 <sup>7</sup>
						0986 474 879	→ 54	1987 474 496 <sup>8</sup>
		05.96-04.98	74	Fg.-Nr. 1E..V..000 001→		0986 471 669	← 54	1987 470 287 <sup>7</sup>
						0986 473 669		1987 474 496 <sup>8</sup>
						0986 472 669	→ 54	1987 470 287 <sup>7</sup>
						0986 474 669		
		07.97-04.98	74			0986 471 669	← 54	1987 470 287 <sup>7</sup>
						0986 473 669		1987 474 496 <sup>8</sup>
						0986 472 669	→ 54	1987 470 287 <sup>7</sup>
						0986 474 669		
		1.8	1.8	09.93-07.95	66			0986 474 880
						0986 474 879	→ 54	1987 470 287 <sup>7</sup>
						0986 474 879	→ 54	1987 474 496 <sup>8</sup>
09.93-04.96	55			Fg.-Nr. →1E..T..030 000		0986 474 880	← 54	1987 470 287 <sup>7</sup>
						0986 474 879	→ 54	1987 470 287 <sup>7</sup>
						0986 474 879	→ 54	1987 474 496 <sup>8</sup>
10.94-04.96	66			Fg.-Nr. →1E..T..030 000		0986 474 880	← 54	1987 470 287 <sup>7</sup>
						0986 474 879	→ 54	1987 470 287 <sup>7</sup>
						0986 474 879	→ 54	1987 474 496 <sup>8</sup>
05.96-04.97	66			Fg.-Nr. 1E..V..000 001→		0986 471 669	← 54	1987 470 287 <sup>7</sup>
						0986 473 669		1987 474 496 <sup>8</sup>
						0986 472 669	→ 54	1987 470 287 <sup>7</sup>
						0986 474 669		
05.96-04.98	55			Fg.-Nr. 1E..V..000 001→		0986 471 669	← 54	1987 470 287 <sup>7</sup>
						0986 473 669		1987 474 496 <sup>8</sup>
				0986 472 669	→ 54	1987 470 287 <sup>7</sup>		
				0986 474 669				
1.9 TDI	1.9 TDI	08.95-04.96	66	Fg.-Nr. →1E..T..030 000		0986 474 880	← 54	1987 470 287 <sup>7</sup>
						0986 474 879	→ 54	1987 470 287 <sup>7</sup>
						0986 474 879	→ 54	1987 474 496 <sup>8</sup>
		05.96-07.96	66	Fg.-Nr. 1E..V..000 001→		0986 471 669	← 54	1987 470 287 <sup>7</sup>
						0986 473 669		1987 474 496 <sup>8</sup>
						0986 472 669	→ 54	1987 470 287 <sup>7</sup>
						0986 474 669		
		08.96-04.98	66			0986 471 669	← 54	1987 470 287 <sup>7</sup>
						0986 473 669		1987 474 496 <sup>8</sup>
						0986 472 669	→ 54	1987 470 287 <sup>7</sup>
						0986 474 669		
		09.96-04.98	81			0986 471 669	← 54	1987 470 287 <sup>7</sup>
						0986 473 669		1987 474 496 <sup>8</sup>
						0986 472 669	→ 54	1987 470 287 <sup>7</sup>
						0986 474 669		



		S												
2.0	09.93-07.95	85					0 986 471 669	← 54	1 987 470 287 <sup>7</sup>					
							0 986 473 669		1 987 474 496 <sup>8</sup>					
							0 986 472 669	→ 54	1 987 470 287 <sup>7</sup>					
							0 986 474 669							
	07.95-04.96	85		Fg.-Nr. →1E..T..030 000				0 986 474 880	 ← 54	1 987 470 287 <sup>7</sup>				
								0 986 474 879	 → 54	1 987 470 287 <sup>7</sup>				
								0 986 474 879		1 987 474 496 <sup>8</sup>				
	05.96-04.98	85		Fg.-Nr. 1E..V..000 001→				0 986 471 669	← 54	1 987 470 287 <sup>7</sup>				
								0 986 473 669		1 987 474 496 <sup>8</sup>				
								0 986 472 669	→ 54	1 987 470 287 <sup>7</sup>				
								0 986 474 669						
	04.97-04.98	85						0 986 471 669	← 54	1 987 470 287 <sup>7</sup>				
0 986 473 669									1 987 474 496 <sup>8</sup>					
0 986 472 669								→ 54	1 987 470 287 <sup>7</sup>					
0 986 474 669														
		1.6	10.94-12.94	74	Fg.-Nr. →1E..SK016 363		0 986 475 260	↔ 17,46						
										01.95-12.95	74	Fg.-Nr. 1E..SK016 364→	0 986 475 433	↔ 19,05
										12.95-04.98	74		0 986 475 433	↔ 19,05
	1.8	09.93-12.94	55/66	Fg.-Nr. →1E..SK016 363			0 986 475 260	↔ 17,46						
										01.95-04.98	55/66	Fg.-Nr. 1E..SK016 364→	0 986 475 433	↔ 19,05
										01.98-03.98	55/66		0 986 475 433	↔ 19,05
	1.9 TDI	08.95-04.98	66				0 986 475 433	↔ 19,05						
	2.0	09.93-12.94	85				0 986 475 260	↔ 17,46						
		01.95-07.95	85	Fg.-Nr. 1E..SK016 364→			0 986 475 433	↔ 19,05						
		1.9 TDI	09.96-04.98	81			0 986 474 875	 ← 38	1 987 470 040 <sup>7</sup>					
										0 986 474 875	 ← 38	1 987 474 496 <sup>8</sup>		
										0 986 474 876	 → 38	1 987 470 040 <sup>7</sup>		
2.0		07.95-04.98	85				0 986 474 875	 ← 38	1 987 470 040 <sup>7</sup>					
										0 986 474 875	 ← 38	1 987 474 496 <sup>8</sup>		
						0 986 474 876	 → 38	1 987 470 040 <sup>7</sup>						
		1.6	10.94-04.98	74			1 987 477 338	↔ 1498						
										1.8	09.93-07.94	55	Fg.-Nr. →1E..S..005 031	1 987 477 168
			66	Fg.-Nr. →1E..S..005 031	1 987 477 168	↔ 1500								
		08.94-07.95	66	Fg.-Nr. 1E..S..005 032→	1 987 477 338	↔ 1498								
		08.94-04.98	55	Fg.-Nr. 1E..S..005 032→	1 987 477 338	↔ 1498								
		10.94-04.97	66		1 987 477 338	↔ 1498								
		01.98-03.98	55		1 987 477 338	↔ 1498								
			66		1 987 477 338	↔ 1498								
		1.9 TDI	08.95-04.98	66		1 987 477 338	↔ 1498							
			09.96-04.98	81		1 987 477 393	↔ 1616							
		2.0	09.93-07.94	85	Fg.-Nr. →1E..S..005 031	1 987 477 168	↔ 1500							
			08.94-12.94	85	Fg.-Nr. 1E..S..005 032→	1 987 477 338	↔ 1498							
	10.94-07.95		85		1 987 477 338	↔ 1498								
	07.95-04.98		85		1 987 477 393	↔ 1616								
		1.6	10.94-04.98	74			LAB	0 986 594 001 <sup>3</sup>						
							RAB	0 986 594 000 <sup>3</sup>						
			03.95-12.95	74	Fg.-Nr. 1E..S..021 848→	0 986 594 003 <sup>4</sup>								
12.95-04.98			74		0 986 594 003 <sup>4</sup>									
1.8		09.93-04.98	55/66		LAB	0 986 594 001 <sup>3</sup>								
					RAB	0 986 594 000 <sup>3</sup>								
		03.95-04.98	55/66	Fg.-Nr. 1E..S..021 848→	0 986 594 003 <sup>4</sup>									
1.9 TDI		01.98-03.98	55/66			0 986 594 003 <sup>4</sup>								
		08.95-04.98	66/81			0 986 594 003 <sup>4</sup>								
					LAB	0 986 594 001 <sup>3</sup>								
				RAB	0 986 594 000 <sup>3</sup>									



			S							
<b>VW Golf III Cabriolet [1E7]</b>										
2.0	09.93-04.98	85						LAB	0986 594 001 <sup>3</sup>	
								RAB	0986 594 000 <sup>3</sup>	
	03.95-07.95	85			Fg.-Nr. 1E..S..021 848→				0986 594 003 <sup>4</sup>	
	07.95-04.98	85							0986 594 003 <sup>4</sup>	
<b>Golf III Variant [1H5]</b>										
1.4	07.93-07.95	40-44							0 204 104 144 <sup>7</sup>	
	07.95-08.95	44			Fg.-Nr. →1H..TW028 354, →1H..TB005 836, →1H..TP008 586	1LM			0 204 104 144 <sup>7</sup>	
	09.95-02.99	44			Fg.-Nr. 1H..TW028 356→, 1H..TB005 837→, 1H..TP008 587→	1LM,239			0 204 104 144 <sup>7</sup>	
	12.97-05.98	44			PR-Code 1LK, PR-Code 1LM, PR-Code 1LG				0 204 104 144 <sup>7</sup>	
1.6	10.94-02.99	74				1LY			0986 471 669 ← 54 1987 470 287 <sup>7</sup>	
								0986 473 669  1987 474 496 <sup>8</sup>		
								0986 472 669 → 54 1987 470 287 <sup>7</sup>		
								0986 474 669		
						256			0986 474 880  ← 54 1987 470 287 <sup>7</sup>	
									0986 474 879  → 54 1987 470 287 <sup>7</sup>	
1.8	07.93-09.94	66				1LM			0 204 104 144 <sup>7</sup>	
						1LY		0986 472 669 → 54 1987 474 496 <sup>8</sup>		
1.8	07.93-02.95	55			Fg.-Nr. →1H..SP246 940, →1H..SW430 000, →1H..SB110 000	1LM			0 204 104 144 <sup>7</sup>	
			07.93-02.99	55			1LY		0986 471 669 ← 54 1987 470 287 <sup>7</sup>	
						0986 473 669  1987 474 496 <sup>8</sup>				
						0986 472 669 → 54 1987 470 287 <sup>7</sup>				
						0986 474 669				
1.8	07.93-02.99	55				239			0 204 104 144 <sup>7</sup>	
			66			1LY		0986 471 669 ← 54 1987 470 287 <sup>7</sup>		
								0986 473 669  1987 474 496 <sup>8</sup>		
1.8	10.94-02.95	66			Fg.-Nr. →1H..SP246 940, →1H..SW430 000, →1H..SB110 000	1LM			0 204 104 144 <sup>7</sup>	
			10.94-02.99	66			1LY		0986 472 669 → 54 1987 470 287 <sup>7</sup>	
								0986 474 669		
1.8	03.95-02.99	55			Fg.-Nr. 1H..SP246 941→, 1H..SW430 001→, 1H..SB110 001→	256			0986 474 880  ← 54 1987 470 287 <sup>7</sup>	
							0986 474 879  → 54 1987 470 287 <sup>7</sup>			
							0986 474 879  → 54 1987 474 496 <sup>8</sup>			
			66			Fg.-Nr. 1H..SP246 941→, 1H..SW430 001→, 1H..SB110 001→	256		0986 474 880  ← 54 1987 470 287 <sup>7</sup>	
								0986 474 879  → 54 1987 470 287 <sup>7</sup>		
									0986 474 879  → 54 1987 474 496 <sup>8</sup>	
1.8	12.97-02.99	55			PR-Code 1LL, PR-Code 1LV	256			0986 474 880  ← 54 1987 470 287 <sup>7</sup>	
							0986 474 879  → 54 1987 470 287 <sup>7</sup>			
							0986 474 879  → 54 1987 474 496 <sup>8</sup>			
			66			PR-Code 1LL, PR-Code 1LV	256		0986 474 880  ← 54 1987 470 287 <sup>7</sup>	
								0986 474 879  → 54 1987 470 287 <sup>7</sup>		
									0986 474 879  → 54 1987 474 496 <sup>8</sup>	
1.8 syncro	10.94-01.95	66			Fg.-Nr. →1H..SW369 000				0 204 104 144 <sup>7</sup>	
			02.95-03.96	66			Fg.-Nr. 1H..SW369 001→ 1H..TD365 209			0986 474 880  ← 54 1987 470 287 <sup>7</sup>
									0986 474 879  → 54 1987 470 287 <sup>7</sup>	
04.96-12.97	66			Fg.-Nr. 1H..TD000 001→, 1H..TD365 200→				0986 471 669 ← 54 1987 470 287 <sup>7</sup>		
						0986 473 669  1987 474 496 <sup>8</sup>				
						0986 472 669 → 54 1987 470 287 <sup>7</sup>				
1.9 D	07.93-02.95	47			Fg.-Nr. →1H..SP246 940, →1H..SW430 000, →1H..SB110 000	1LM			0 204 104 144 <sup>7</sup>	
			07.93-02.99	47			239			0 204 104 144 <sup>7</sup>



		S							
<b>1.9 D</b>		07.93-02.99	47			1LY	0 986 471 669	← 54	1 987 470 287 <sup>7</sup>
<b>1.9 SDI</b>							0 986 473 669		1 987 474 496 <sup>8</sup>
							0 986 472 669	→ 54	1 987 470 287 <sup>7</sup>
							0 986 474 669		
<b>1.9 SDI</b>		01.95-02.99	47			1LM			0 204 104 144 <sup>7</sup>
						239			0 204 104 144 <sup>7</sup>
<b>1.9 TD</b>		07.93-02.99	55			1LM			0 204 104 144 <sup>7</sup>
						1LY	0 986 471 669	← 54	1 987 470 287 <sup>7</sup>
							0 986 473 669		1 987 474 496 <sup>8</sup>
							0 986 472 669	→ 54	1 987 470 287 <sup>7</sup>
							0 986 474 669		
						239			0 204 104 144 <sup>7</sup>
						256	0 986 474 880	← 54	1 987 470 287 <sup>7</sup>
							0 986 474 879	→ 54	1 987 470 287 <sup>7</sup>
							0 986 474 879	→ 54	1 987 474 496 <sup>8</sup>
<b>1.9 TDI</b>		07.93-02.99	66			1LY	0 986 471 669	← 54	1 987 470 287 <sup>7</sup>
							0 986 473 669		1 987 474 496 <sup>8</sup>
							0 986 472 669	→ 54	1 987 470 287 <sup>7</sup>
							0 986 474 669		
						256	0 986 474 880	← 54	1 987 470 287 <sup>7</sup>
							0 986 474 879	→ 54	1 987 470 287 <sup>7</sup>
							0 986 474 879	→ 54	1 987 474 496 <sup>8</sup>
		02.96-02.99	81			1LY	0 986 471 669	← 54	1 987 470 287 <sup>7</sup>
							0 986 473 669		1 987 474 496 <sup>8</sup>
							0 986 472 669	→ 54	1 987 470 287 <sup>7</sup>
							0 986 474 669		
						256	0 986 474 880	← 54	1 987 470 287 <sup>7</sup>
							0 986 474 879	→ 54	1 987 470 287 <sup>7</sup>
							0 986 474 879	→ 54	1 987 474 496 <sup>8</sup>
<b>1.9 TDI syncro</b>		10.94-03.96	66	Fg.-Nr. →1H..TD365 209			0 986 474 880	← 54	1 987 470 287 <sup>7</sup>
							0 986 474 879	→ 54	1 987 470 287 <sup>7</sup>
							0 986 474 879	→ 54	1 987 474 496 <sup>8</sup>
		04.96-07.96	66	Fg.-Nr. 1H..TD000 001→, 1H..TD365 200→			0 986 471 669	← 54	1 987 470 287 <sup>7</sup>
							0 986 473 669		1 987 474 496 <sup>8</sup>
							0 986 472 669	→ 54	1 987 470 287 <sup>7</sup>
							0 986 474 669		
		05.96-12.97	66				0 986 471 669	← 54	1 987 470 287 <sup>7</sup>
							0 986 473 669		1 987 474 496 <sup>8</sup>
							0 986 472 669	→ 54	1 987 470 287 <sup>7</sup>
							0 986 474 669		
<b>2.0</b>		07.93-09.94	85			1LY	0 986 472 669	→ 54	1 987 474 496 <sup>8</sup>
							0 986 474 669		
		07.93-02.99	85			1LY	0 986 471 669	← 54	1 987 470 287 <sup>7</sup>
							0 986 473 669		
							0 986 472 669	→ 54	1 987 470 287 <sup>7</sup>
							0 986 474 669		
						228	0 986 473 687	← 54	1 987 470 287 <sup>7</sup>
							0 986 473 687	← 54	1 987 474 496 <sup>8</sup>
							0 986 474 687	→ 54	1 987 470 287 <sup>7</sup>
						288	0 986 471 923	← 54	1 987 470 506 <sup>8</sup>
							0 986 473 923		
							0 986 471 924	→ 54	1 987 470 506 <sup>8</sup>
							0 986 473 924		
		10.94-02.99	85			1LY	0 986 471 669	← 54	1 987 474 496 <sup>8</sup>
							0 986 473 669		
<b>2.0 syncro</b>		07.95-12.97	85				0 986 471 669	← 54	1 987 470 287 <sup>7</sup>
							0 986 473 669		1 987 474 496 <sup>8</sup>
							0 986 472 669	→ 54	1 987 470 287 <sup>7</sup>
							0 986 474 669		
<b>2.9 syncro</b>		07.95-12.97	140				0 986 471 923	← 54	1 987 470 506 <sup>8</sup>
							0 986 473 923		
							0 986 471 924	→ 54	1 987 470 506 <sup>8</sup>
							0 986 473 924		





		S								
◀ VW Golf III Variant [1H5]										
	1.4	07.93-02.99	40-44				0986 475 260	↔	17,46	
							0986 475 433	↔	19,05	
	1.6	10.94-02.99	74				0986 475 260	↔	17,46	
							0986 475 433	↔	19,05	
	1.8	07.93-02.99	55				0986 475 260	↔	17,46	
							0986 475 433	↔	19,05	
			66				0986 475 260	↔	17,46	
							0986 475 433	↔	19,05	
	1.8 syncro	10.94-01.95	66	Fg.-Nr. →1H..SW369 003			0986 475 039	↔	20,64	
		02.95-12.97	66	Fg.-Nr. 1H..SW400 001→			0986 475 865	↔	22,2	
	1.9 D, SDI, TD	07.93-02.99	47/55				0986 475 433	↔	19,05	
1.9 TDI	07.93-07.96	66				0986 475 433	↔	19,05		
1.9 TDI syncro	10.94-12.97	66				0986 475 865	↔	22,2		
	1.6	10.94-02.99	74				0986 474 875		← 38	1987 470 040 <sup>7</sup>
							0986 474 875		← 38	1987 474 496 <sup>8</sup>
							0986 474 876		→ 38	1987 470 040 <sup>7</sup>
	1.8	07.93-02.99	66				0986 474 875		← 38	1987 470 040 <sup>7</sup>
				1.8 syncro				0986 474 875		← 38
							0986 474 876		→ 38	1987 470 040 <sup>7</sup>
	1.9 TDI	10.94-02.99	66/81				0986 474 875		← 38	1987 470 040 <sup>7</sup>
	1.9 TDI syncro						0986 474 875		← 38	1987 474 496 <sup>8</sup>
							0986 474 876		→ 38	1987 470 040 <sup>7</sup>
	2.0	07.93-02.99	85				0986 474 875		← 38	1987 470 040 <sup>7</sup>
				2.0 syncro				0986 474 875		← 38
							0986 474 876		→ 38	1987 470 040 <sup>7</sup>
	2.9 syncro	07.95-12.97	140				0986 474 875		← 38	1987 470 040 <sup>7</sup>
							0986 474 875		← 38	1987 474 496 <sup>8</sup>
							0986 474 876		→ 38	1987 470 040 <sup>7</sup>
	1.4	07.93-10.94	40-44	Fg.-Nr. →1H..S..037 799			1987 477 168	↔	1500	
		11.94-07.95	40-44	Fg.-Nr. 1H..S..037 800→			1987 477 338	↔	1498	
		07.95-02.99	44				1987 477 338	↔	1498	
	1.6	10.94-02.99	74			SBR	1987 477 393	↔	1616	
						TBR	1987 477 338	↔	1498	
	1.8	07.93-09.94	66			SBR	1987 477 162	↔	1613	
						TBR	1987 477 168	↔	1500	
			07.93-10.94	55	Fg.-Nr. →1H..S..037 799			1987 477 168	↔	1500
			10.94-02.99	66			SBR	1987 477 393	↔	1616
							TBR	1987 477 338	↔	1498
			11.94-02.99	55	Fg.-Nr. 1H..S..037 800→			1987 477 338	↔	1498
			12.97-02.99	55				1987 477 338	↔	1498
		1.8 syncro	10.94-12.97	66				1987 482 124	↔	1582
	1.9 D	07.93-10.94	47	Fg.-Nr. →1H..S..037 799			1987 477 168	↔	1500	
		11.94-02.99	47	Fg.-Nr. 1H..S..037 800→			1987 477 338	↔	1498	
	1.9 SDI	01.95-02.99	47				1987 477 338	↔	1498	
	1.9 TD	07.93-10.94	55	Fg.-Nr. →1H..S..037 799			1987 477 168	↔	1500	
11.94-02.99		55	Fg.-Nr. 1H..S..037 800→			1987 477 338	↔	1498		
1.9 TDI	07.93-10.94	66	Fg.-Nr. →1H..S..037 799			1987 477 168	↔	1500		
	11.94-07.96	66	Fg.-Nr. 1H..S..037 800→			1987 477 338	↔	1498		
	02.96-02.99	81			SBR	1987 477 393	↔	1616		
					TBR	1987 477 338	↔	1498		
		08.96-02.99	66			SBR	1987 477 393	↔	1616	
					TBR	1987 477 338	↔	1498		
1.9 TDI syncro	10.94-12.97	66				1987 482 124	↔	1582		
2.0	07.93-09.94	85			SBR	1987 477 162	↔	1613		
					TBR	1987 477 168	↔	1500		
						10.94-02.99	85	SBR	1987 477 393	↔
					TBR	1987 477 338	↔	1498		

		S									
2.0		05.97-02.99	85					1 987 477 393	↔ 1616		
2.0 syncro		07.95-12.97	85					1 987 482 124	↔ 1582		
	1.4	07.93-07.95	40-44					0 986 594 001 <sup>3</sup>			
								RAB	0 986 594 000 <sup>3</sup>		
		03.95-07.95	40-44	Fg.-Nr. 1H..SW385 335→, 1H..SW352 190→, 1H..SB088 705→					0 986 594 003 <sup>4</sup>		
		07.95-02.99	44						0 986 594 003 <sup>4</sup>		
									LAB	0 986 594 001 <sup>3</sup>	
									RAB	0 986 594 000 <sup>3</sup>	
1.6		10.94-02.99	74					LAB	0 986 594 001 <sup>3</sup>		
								RAB	0 986 594 000 <sup>3</sup>		
		03.95-12.95	74	Fg.-Nr. 1H..SW385 335→, 1H..SW352 190→, 1H..SB088 705→					0 986 594 003 <sup>4</sup>		
		12.95-02.99	74					0 986 594 003 <sup>4</sup>			
1.8		03.95-02.99	55/66	Fg.-Nr. 1H..SW385 335→, 1H..SW352 190→, 1H..SB088 705→					0 986 594 003 <sup>4</sup>		
				12.97-02.99	55/66				0 986 594 003 <sup>4</sup>		
1.8		07.93-02.99	55/66					LAB	0 986 594 001 <sup>3</sup>		
1.8 syncro								RAB	0 986 594 000 <sup>3</sup>		
1.9D		07.93-02.99	47/55					LAB	0 986 594 001 <sup>3</sup>		
1.9SDI								RAB	0 986 594 000 <sup>3</sup>		
1.9TD		03.95-02.99	47/55	Fg.-Nr. 1H..SW385 335→, 1H..SW352 190→, 1H..SB088 705→					0 986 594 003 <sup>4</sup>		
1.9TDI		03.95-07.96	66	Fg.-Nr. 1H..SW385 335→, 1H..SW352 190→, 1H..SB088 705→					0 986 594 003 <sup>4</sup>		
		02.96-02.99	81						0 986 594 003 <sup>4</sup>		
									LAB	0 986 594 001 <sup>3</sup>	
									RAB	0 986 594 000 <sup>3</sup>	
		08.96-02.99	66					0 986 594 003 <sup>4</sup>			
1.9TDI		07.93-02.99	66					LAB	0 986 594 001 <sup>3</sup>		
1.9TDI syncro								RAB	0 986 594 000 <sup>3</sup>		
2.0		03.95-05.96	85	Fg.-Nr. 1H..SW385 335→, 1H..SW352 190→, 1H..SB088 705→					0 986 594 003 <sup>4</sup>		
				07.95-02.99	85				0 986 594 003 <sup>4</sup>		
2.0		07.93-02.99	85					LAB	0 986 594 001 <sup>3</sup>		
2.0 syncro								RAB	0 986 594 000 <sup>3</sup>		
2.9 syncro		07.95-12.97	140					LAB	0 986 594 001 <sup>3</sup>		
								RAB	0 986 594 000 <sup>3</sup>		

**Golf III [1H1]**

	1.4	11.91-07.95	40-44						0 204 104 144 <sup>7</sup>
		07.95-12.97	44					1LM	0 204 104 144 <sup>7</sup>
1.6		09.92-12.97	55					1LM	0 204 104 144 <sup>7</sup>
								256	0 986 474 880  ← 54 1 987 470 287 <sup>7</sup>
									0 986 474 879  → 54 1 987 470 287 <sup>7</sup>
									0 986 474 879  → 54 1 987 474 496 <sup>8</sup>
		10.94-12.97	74					1LY	0 986 471 669 ← 54 1 987 470 287 <sup>7</sup>
									0 986 473 669  1 987 474 496 <sup>8</sup>
									0 986 472 669 → 54 1 987 470 287 <sup>7</sup>
									0 986 474 669
								256	0 986 474 880  ← 54 1 987 470 287 <sup>7</sup>
									0 986 474 879  → 54 1 987 470 287 <sup>7</sup>
							0 986 474 879  → 54 1 987 474 496 <sup>8</sup>		
1.8		11.91-09.94	66					1LY	0 986 472 669 → 54 1 987 474 496 <sup>8</sup>
									0 986 474 669
		11.91-12.97	55					1LM	0 204 104 144 <sup>7</sup>
								1LY	0 986 471 669 ← 54 1 987 470 287 <sup>7</sup>
									0 986 473 669  1 987 474 496 <sup>8</sup>
							0 986 472 669 → 54 1 987 470 287 <sup>7</sup>		
								0 986 474 669	



		S							
◀ VW Golf III [1H1]									
<b>1.8</b>	11.91-12.97	66		1LM				0 204 104 144 <sup>7</sup>	
				1LY	0 986 471 669	← 54	1 987 470 287 <sup>7</sup>		
							0 986 473 669		
							0 986 472 669	→ 54	1 987 470 287 <sup>7</sup>
							0 986 474 669		
	10.94-12.97	66		1LY	0 986 471 669	← 54	1 987 474 496 <sup>8</sup>		
							0 986 473 669		
	03.95-12.97	55		Fg.-Nr. 1H..SP246 941→, 1H..SW430 001→, 1H..SB110 001→	256	0 986 474 880		← 54	1 987 470 287 <sup>7</sup>
						0 986 474 879		→ 54	1 987 470 287 <sup>7</sup>
						0 986 474 879		→ 54	1 987 474 496 <sup>8</sup>
	66			Fg.-Nr. 1H..SP246 941→, 1H..SW430 001→, 1H..SB110 001→	256	0 986 474 880		← 54	1 987 470 287 <sup>7</sup>
						0 986 474 879		→ 54	1 987 470 287 <sup>7</sup>
						0 986 474 879		→ 54	1 987 474 496 <sup>8</sup>
<b>1.8 syncro</b>	01.93-09.94	66						0 204 104 144 <sup>7</sup>	
	10.94-01.95	66		Fg.-Nr. →1H..SW369 000				0 204 104 144 <sup>7</sup>	
	02.95-12.97	66		Fg.-Nr. 1H..SW369 001→	0 986 474 880		← 54	1 987 470 287 <sup>7</sup>	
					0 986 474 879		→ 54	1 987 470 287 <sup>7</sup>	
					0 986 474 879		→ 54	1 987 474 496 <sup>8</sup>	
<b>1.9 D, SDI</b>	11.91-12.97	47			1LM			0 204 104 144 <sup>7</sup>	
<b>1.9 TD</b>	11.91-12.97	55			1LM			0 204 104 144 <sup>7</sup>	
					1LY	0 986 471 669	← 54	1 987 470 287 <sup>7</sup>	
						0 986 473 669		1 987 474 496 <sup>8</sup>	
						0 986 472 669	→ 54	1 987 470 287 <sup>7</sup>	
					0 986 474 669				
<b>1.9 TDI</b>	09.93-12.97	66			1LY	0 986 471 669	← 54	1 987 470 287 <sup>7</sup>	
						0 986 473 669		1 987 474 496 <sup>8</sup>	
						0 986 472 669	→ 54	1 987 470 287 <sup>7</sup>	
						0 986 474 669			
	256					0 986 474 880		← 54	1 987 470 287 <sup>7</sup>
						0 986 474 879		→ 54	1 987 470 287 <sup>7</sup>
						0 986 474 879		→ 54	1 987 474 496 <sup>8</sup>
03.96-12.97	81				1LY	0 986 471 669	← 54	1 987 470 287 <sup>7</sup>	
						0 986 473 669		1 987 474 496 <sup>8</sup>	
						0 986 472 669	→ 54	1 987 470 287 <sup>7</sup>	
						0 986 474 669			
<b>1.9 TDI syncro</b>	03.95-03.96	66		Fg.-Nr. →1H..TD365 209		0 986 474 880		← 54	1 987 470 287 <sup>7</sup>
						0 986 474 879		→ 54	1 987 470 287 <sup>7</sup>
						0 986 474 879		→ 54	1 987 474 496 <sup>8</sup>
	04.96-07.96	66		Fg.-Nr. 1H..TD000 001→, 1H..TD365 200→		0 986 471 669	← 54	1 987 470 287 <sup>7</sup>	
						0 986 473 669		1 987 474 496 <sup>8</sup>	
						0 986 472 669	→ 54	1 987 470 287 <sup>7</sup>	
						0 986 474 669			
	05.96-12.97	66				0 986 471 669	← 54	1 987 470 287 <sup>7</sup>	
						0 986 473 669		1 987 474 496 <sup>8</sup>	
						0 986 472 669	→ 54	1 987 470 287 <sup>7</sup>	
						0 986 474 669			
	08.96-12.97	66				0 986 472 669	→ 54	1 987 474 496 <sup>8</sup>	
						0 986 474 669			
	<b>2.0</b>	11.91-09.94	85			1LY	0 986 471 669	← 54	1 987 470 287 <sup>7</sup>
						0 986 473 669		1 987 474 496 <sup>8</sup>	
						0 986 472 669	→ 54	1 987 470 287 <sup>7</sup>	
						0 986 474 669			
228						0 986 473 687		← 54	1 987 470 287 <sup>7</sup>
						0 986 473 687		← 54	1 987 474 496 <sup>8</sup>
						0 986 474 687		→ 54	1 987 470 287 <sup>7</sup>
08.92-12.97	110				228	0 986 473 687		← 54	1 987 470 287 <sup>7</sup>
						0 986 473 687		← 54	1 987 474 496 <sup>8</sup>
						0 986 474 687		→ 54	1 987 470 287 <sup>7</sup>



<b>2.0</b>	08.92-12.97	110			288,BSR	0 986 471 923	← 54	1 987 470 506 <sup>B</sup>	
						0 986 473 923			
						0 986 471 924	→ 54	1 987 470 506 <sup>B</sup>	
						0 986 473 924			
						288,BSR			1 987 470 506 <sup>B</sup>
	10.94-12.97	85					0 986 473 687	← 54	1 987 470 287 <sup>7</sup>
							0 986 473 687	← 54	1 987 474 496 <sup>B</sup>
							0 986 474 687	→ 54	1 987 470 287 <sup>7</sup>
	01.95-12.97	79					0 986 471 669	← 54	1 987 470 287 <sup>7</sup>
							0 986 473 669		1 987 474 496 <sup>B</sup>
							0 986 472 669	→ 54	1 987 470 287 <sup>7</sup>
							0 986 474 669		
07.95-12.97	85				228	0 986 473 687	← 54	1 987 470 287 <sup>7</sup>	
						0 986 473 687	← 54	1 987 474 496 <sup>B</sup>	
						0 986 474 687	→ 54	1 987 470 287 <sup>7</sup>	
					288	0 986 471 923	← 54	1 987 470 506 <sup>B</sup>	
						0 986 473 923			
						0 986 471 924	→ 54	1 987 470 506 <sup>B</sup>	
						0 986 473 924			
<b>2.0 syncro</b>	07.95-12.97	85				0 986 471 669	← 54	1 987 470 287 <sup>7</sup>	
						0 986 473 669		1 987 474 496 <sup>B</sup>	
						0 986 472 669	→ 54	1 987 470 287 <sup>7</sup>	
						0 986 474 669			
<b>2.8</b>	01.92-02.95	120/128		Fg.-Nr. →1H..SW399 999, →1H..SB090 146		0 986 473 687	← 54	1 987 470 287 <sup>7</sup>	
						0 986 473 687	← 54	1 987 474 496 <sup>B</sup>	
						0 986 474 687	→ 54	1 987 470 287 <sup>7</sup>	
	03.95-12.97	120/128		Fg.-Nr. 1H..SW400 001→, 1H..SB090 147→		288	0 986 471 923	← 54	1 987 470 506 <sup>B</sup>
							0 986 473 923		
							0 986 471 924	→ 54	1 987 470 506 <sup>B</sup>
						0 986 473 924			
<b>2.9 syncro</b>	01.94-12.97	140				0 986 471 923	← 54	1 987 470 506 <sup>B</sup>	
						0 986 473 923			
						0 986 471 924	→ 54	1 987 470 506 <sup>B</sup>	
						0 986 473 924			
	<b>1.4</b>	ABO	11.91-12.97	40-44		0 986 475 438	↔ 15,87		
		ABS	11.91-12.97	40-44		0 986 475 260	↔ 17,46		
	<b>1.6</b>	09.92-09.94	55		AG	0 986 475 438	↔ 15,87		
						GS,TR2	0 986 475 260	↔ 17,46	
		05.94-12.97	55				0 986 475 260	↔ 17,46	
							0 986 475 260	↔ 17,46	
							0 986 475 433	↔ 19,05	
<b>1.8</b>	11.91-12.97	55			AG	0 986 475 438	↔ 15,87		
						GS,TR2	0 986 475 260	↔ 17,46	
	10.94-12.97	66				0 986 475 260	↔ 17,46		
						0 986 475 433	↔ 19,05		
	ABO	11.91-09.94	66			0 986 475 438	↔ 15,87		
	ABS	11.91-09.94	66			0 986 475 260	↔ 17,46		
<b>1.8 syncro</b>	01.93-09.94	66				0 986 475 039	↔ 20,64		
						0 986 475 039	↔ 20,64		
						0 986 475 865	↔ 22,2		
					Fg.-Nr. →1H..SW369 003				
					Fg.-Nr. 1H..SW400 001→				
<b>1.9 D, SDI</b>	11.91-12.97	47				0 986 475 260	↔ 17,46		
<b>1.9 TD</b>	ABO	11.91-12.97	55			0 986 475 438	↔ 15,87		
	ABS	11.91-12.97	55			0 986 475 260	↔ 17,46		
<b>1.9 TDI</b>	09.93-12.97	66				0 986 475 260	↔ 17,46		
<b>1.9 TDI syncro</b>	03.95-12.97	66				0 986 475 865	↔ 22,2		
<b>2.0 syncro</b>	07.95-12.97	85				0 986 475 865	↔ 22,2		
	<b>1.6</b>	10.94-12.97	74			0 986 474 875	← 38	1 987 470 040 <sup>7</sup>	
						0 986 474 875	← 38	1 987 474 496 <sup>B</sup>	
						0 986 474 876	→ 38	1 987 470 040 <sup>7</sup>	



		S										
◀ VW Golf III [1H1]												
1.8		11.91-12.97	66				0986 474 875		38	1987 470 040 <sup>7</sup>		
							0986 474 875		38	1987 474 496 <sup>8</sup>		
							0986 474 876		38	1987 470 040 <sup>7</sup>		
1.9 TDI		03.96-12.97	66/81				0986 474 875		38	1987 470 040 <sup>7</sup>		
							0986 474 875		38	1987 474 496 <sup>8</sup>		
							0986 474 876		38	1987 470 040 <sup>7</sup>		
2.0		11.92-09.94	85	Fg.-Nr. 1H..PW240 001→, 1H..PB030 001→			0986 474 875		38	1987 470 040 <sup>7</sup>		
							0986 474 875		38	1987 474 496 <sup>8</sup>		
							0986 474 876		38	1987 470 040 <sup>7</sup>		
		11.92-12.97	110	Fg.-Nr. 1H..PW240 001→, 1H..PB030 001→			0986 474 875		38	1987 470 040 <sup>7</sup>		
							0986 474 875		38	1987 474 496 <sup>8</sup>		
							0986 474 876		38	1987 470 040 <sup>7</sup>		
		10.94-12.97	85				0986 474 875		38	1987 470 040 <sup>7</sup>		
							0986 474 875		38	1987 474 496 <sup>8</sup>		
							0986 474 876		38	1987 470 040 <sup>7</sup>		
		01.95-12.97	79				0986 474 875		38	1987 470 040 <sup>7</sup>		
							0986 474 875		38	1987 474 496 <sup>8</sup>		
							0986 474 876		38	1987 470 040 <sup>7</sup>		
2.8		11.92-12.97	128	Fg.-Nr. 1H..PW240 001→, 1H..PB030 001→			0986 474 875		38	1987 470 040 <sup>7</sup>		
							0986 474 875		38	1987 474 496 <sup>8</sup>		
							0986 474 876		38	1987 470 040 <sup>7</sup>		
		07.94-12.97	120				0986 474 875		38	1987 470 040 <sup>7</sup>		
							0986 474 875		38	1987 474 496 <sup>8</sup>		
0986 474 876		38	1987 470 040 <sup>7</sup>									
2.9 syncro		01.94-12.97	140				0986 474 875		38	1987 470 040 <sup>7</sup>		
							0986 474 875		38	1987 474 496 <sup>8</sup>		
							0986 474 876		38	1987 470 040 <sup>7</sup>		
1.4		11.91-10.94	40-44	Fg.-Nr. →1H..S..037 799			1987 477 168		1500			
							11.94-07.95	40-44	Fg.-Nr. 1H..S..037 800→	1987 477 338		1498
							07.95-12.97	44		1987 477 338		1498
1.6		09.92-09.94	55				1987 477 168		1500			
							05.94-12.97	55		1987 477 338		1498
							10.94-12.97	74		SBR	1987 477 393	
							TBR	1987 477 338		1498		
1.8		11.91-09.94	66				SBR	1987 477 162		1613		
							TBR	1987 477 168		1500		
		11.91-10.94	55	Fg.-Nr. →1H..S..037 799			1987 477 168		1500			
							10.94-12.97	66		SBR	1987 477 393	
									TBR	1987 477 338		1498
		11.94-12.97	55	Fg.-Nr. 1H..S..037 800→			1987 477 338		1498			
12.94-12.97	66				1987 477 338		1498					
1.8 syncro		01.93-12.97	66				1987 482 124		1582			
1.9 D		11.91-10.94	47	Fg.-Nr. →1H..S..037 799			1987 477 168		1500			
							11.94-12.97	47	Fg.-Nr. 1H..S..037 800→	1987 477 338		1498
1.9 SDI		01.95-12.97	47				1987 477 338		1498			
1.9 TD		11.91-10.94	55	Fg.-Nr. →1H..S..037 799			1987 477 168		1500			
							11.94-12.97	55	Fg.-Nr. 1H..S..037 800→	1987 477 338		1498
1.9 TDI		09.93-10.94	66	Fg.-Nr. →1H..S..037 799			1987 477 168		1500			
							11.94-07.96	66	Fg.-Nr. 1H..S..037 800→	1987 477 338		1498
		03.96-12.97	81				1987 477 393		1616			
							08.96-12.97	66		SBR	1987 477 393	
							TBR	1987 477 338		1498		
1.9 TDI syncro		03.95-12.97	66				1987 482 124		1582			
2.0		11.91-09.94	85				1987 477 162		1613			
							08.92-10.94	110	Fg.-Nr. →1H..S..037 799	1987 477 162		1613
		10.94-12.97	85				1987 477 393		1616			
		11.94-12.97	110	Fg.-Nr. 1H..S..037 800→			1987 477 393		1616			
		01.95-12.97	79				1987 477 393		1616			
2.0 syncro		07.95-12.97	85				1987 482 124		1582			

		S								
2.8		01.92-10.94	120/128	Fg.-Nr. →1H..S..037 799			1 987 477 162	↔ 1613		
		11.94-12.97	120/128	Fg.-Nr. 1H..S..037 800→			1 987 477 393	↔ 1616		
	1.4	11.91-07.95	40-44		LAB		0 986 594 001 <sup>3</sup>			
					RAB		0 986 594 000 <sup>3</sup>			
		03.95-07.95	40-44	Fg.-Nr. 1H..SW385 335→, 1H..SW352 190→, 1H..SB088 705→			0 986 594 003 <sup>4</sup>			
		07.95-12.97	44				0 986 594 003 <sup>4</sup>			
					LAB		0 986 594 001 <sup>3</sup>			
					RAB		0 986 594 000 <sup>3</sup>			
1.6		09.92-12.97	55/74		LAB		0 986 594 001 <sup>3</sup>			
					RAB		0 986 594 000 <sup>3</sup>			
	03.95-12.95	55/74	Fg.-Nr. 1H..SW385 335→, 1H..SW352 190→, 1H..SB088 705→			0 986 594 003 <sup>4</sup>				
		07.95-12.97	55/74			0 986 594 003 <sup>4</sup>				
1.8		03.95-12.97	55/66	Fg.-Nr. 1H..SW385 335→, 1H..SW352 190→, 1H..SB088 705→			0 986 594 003 <sup>4</sup>			
1.8	1.8 syncro	11.91-12.97	55/66		LAB		0 986 594 001 <sup>3</sup>			
					RAB		0 986 594 000 <sup>3</sup>			
1.9D		11.91-12.97	47/55		LAB		0 986 594 001 <sup>3</sup>			
1.9SDI					RAB		0 986 594 000 <sup>3</sup>			
1.9TD		03.95-12.97	47/55	Fg.-Nr. 1H..SW385 335→, 1H..SW352 190→, 1H..SB088 705→			0 986 594 003 <sup>4</sup>			
1.9TDI		03.95-07.96	66	Fg.-Nr. 1H..SW385 335→, 1H..SW352 190→, 1H..SB088 705→			0 986 594 003 <sup>4</sup>			
		03.96-12.97	81				0 986 594 003 <sup>4</sup>			
					LAB		0 986 594 001 <sup>3</sup>			
					RAB		0 986 594 000 <sup>3</sup>			
		08.96-12.97	66				0 986 594 003 <sup>4</sup>			
1.9TDI		09.93-12.97	66		LAB		0 986 594 001 <sup>3</sup>			
1.9TDI syncro					RAB		0 986 594 000 <sup>3</sup>			
2.0		08.92-12.97	110		LAB		0 986 594 001 <sup>3</sup>			
					RAB		0 986 594 000 <sup>3</sup>			
		01.95-12.97	79		LAB		0 986 594 001 <sup>3</sup>			
					RAB		0 986 594 000 <sup>3</sup>			
		03.95-12.97	79	Fg.-Nr. 1H..SW385 335→, 1H..SW352 190→, 1H..SB088 705→			0 986 594 003 <sup>4</sup>			
			85	Fg.-Nr. 1H..SW385 335→, 1H..SW352 190→, 1H..SB088 705→			0 986 594 003 <sup>4</sup>			
		110	Fg.-Nr. 1H..SW385 335→, 1H..SW352 190→, 1H..SB088 705→			0 986 594 003 <sup>4</sup>				
		07.95-12.97	85				0 986 594 003 <sup>4</sup>			
2.0		11.91-12.97	85		LAB		0 986 594 001 <sup>3</sup>			
2.0 syncro					RAB		0 986 594 000 <sup>3</sup>			
2.8		01.92-12.97	120/128		LAB		0 986 594 001 <sup>3</sup>			
					RAB		0 986 594 000 <sup>3</sup>			
		03.95-12.97	120/128	Fg.-Nr. 1H..SW385 335→, 1H..SW352 190→, 1H..SB088 705→			0 986 594 003 <sup>4</sup>			
2.9 syncro		01.94-12.97	140		LAB		0 986 594 001 <sup>3</sup>			
					RAB		0 986 594 000 <sup>3</sup>			
<b>Golf III [1H1/1W1]</b>										
	1.8	08.92-07.99	66						0 204 104 144 <sup>7</sup>	
		1.9TD	08.92-07.98	55					0 204 104 144 <sup>7</sup>	
		2.0	08.92-07.99	85		INB		0 986 471 669	← 54	1 987 470 287 <sup>7</sup>
							0 986 473 669	↻	1 987 474 496 <sup>8</sup>	
							0 986 472 669	→ 54	1 987 470 287 <sup>7</sup>	
					0 986 474 669	↻				
2.8	09.94-07.95	128	Fg.-Nr. →1H-S-999 000	BEL,INB		0 986 473 687	↻ ← 54	1 987 470 287 <sup>7</sup>		
						0 986 473 687	↻ ← 54	1 987 474 496 <sup>8</sup>		
						0 986 474 687	↻ → 54	1 987 470 287 <sup>7</sup>		



		S							
	◀ VW Golf III [1H1/1W1]								
	2.8	08.95-08.99	128			BEL,INB	0986 471 923	← 54	
							0986 473 923		
							0986 471 924	→ 54	
							0986 473 924		
	1.8	08.92-07.99	66				0986 475 260	↔ 17,46	
						AG	0986 475 438	↔ 15,87	
	1.9 TD	08.92-07.98	55				0986 475 438	↔ 15,87	
	2.0	08.92-07.99	85				0986 475 433	↔ 19,05	
	2.8	09.94-08.99	128				0986 474 875	← 38	1987 470 040 <sup>7</sup>
							0986 474 875	← 38	1987 474 496 <sup>8</sup>
							0986 474 876	→ 38	1987 470 040 <sup>7</sup>
	1.9 TD	03.94-07.98	55			Fg.-Nr. 1H..S..033 995→	1987 477 338	↔ 1498	
	1.8	08.92-07.99	66				0986 594 003 <sup>4</sup>		
						LAB	0986 594 001 <sup>3</sup>		
						RAB	0986 594 000 <sup>3</sup>		
	1.9 TD	08.92-07.98	55				0986 594 003 <sup>4</sup>		
						LAB	0986 594 001 <sup>3</sup>		
						RAB	0986 594 000 <sup>3</sup>		
	2.8	09.94-08.99	128				0986 594 003 <sup>4</sup>		
						LAB	0986 594 001 <sup>3</sup>		
						RAB	0986 594 000 <sup>3</sup>		
<b>Golf III [1H4]</b>									
	1.8	11.92-12.99	70						0204 104 144 <sup>7</sup>
	2.8 iVR6	10.93-12.99	128			228	0986 473 687	← 54	1987 470 287 <sup>7</sup>
							0986 473 687	← 54	1987 474 496 <sup>8</sup>
							0986 474 687	→ 54	1987 470 287 <sup>7</sup>
	1.8	11.92-12.99	70				0986 475 260	↔ 17,46	
	2.8 iVR6	10.93-12.99	128						1987 470 040 <sup>7</sup>
									1987 474 496 <sup>8</sup>
	2.8 iVR6	10.93-12.99	128			LAB	0986 594 001 <sup>3</sup>		
						RAB	0986 594 000 <sup>3</sup>		
<b>Golf IV</b>									
	1.8 i	08.03-07.08	92				0986 473 071	← 54	1987 470 506 <sup>8</sup>
							0986 474 071	→ 54	1987 470 506 <sup>8</sup>
	1.9 TDI 4Motion	04.01-06.05	96			228	0986 473 071	← 54	1987 470 506 <sup>8</sup>
							0986 474 071	→ 54	1987 470 506 <sup>8</sup>
						288	0986 471 923	← 54	1987 470 506 <sup>8</sup>
							0986 473 923		
							0986 471 924	→ 54	1987 470 506 <sup>8</sup>
							0986 473 924		



		S								
	1.8 i	08.03-07.08	92				0 986 473 099		← 38,1	1 987 470 040 <sup>7</sup>
							0 986 473 099		← 38,1	1 987 474 496 <sup>B</sup>
							0 986 474 099		→ 38,1	1 987 470 040 <sup>7</sup>
	1.9 TDI 4Motion	04.01-06.05	96	PR-Code 1KE, PR-Code 2EG			0 986 473 029		← 41	1 987 474 496 <sup>B</sup>
							0 986 474 029		→ 41	1 987 474 496 <sup>B</sup>
				PR-Code 1KU, PR-Code 2EE	252		0 986 473 139		← 38,1	1 987 470 040 <sup>7</sup>
							0 986 473 139		← 38,1	1 987 474 496 <sup>B</sup>
							0 986 474 139		→ 38,1	1 987 470 040 <sup>7</sup>
	1.8 i	08.03-07.08	92				1 987 477 698		↔ 1693	
	1.9 TDI 4Motion	04.01-06.05	96				1 987 477 686		↔ 1723	
	1.8 i	08.03-07.08	92				0 986 594 004 <sup>4</sup>			
						LAB	0 986 594 001 <sup>3</sup>			
						RAB	0 986 594 000 <sup>3</sup>			
	1.9 TDI 4Motion	04.01-06.05	96				0 986 594 008 <sup>4</sup>			
						LAB	0 986 594 001 <sup>3</sup>			
						RAB	0 986 594 000 <sup>3</sup>			
<b>Golf IV Cabriolet [1E7]</b>										
	1.6	04.98-10.00	74	PR-Code 1LL	256		0 986 474 880		← 54	1 987 470 287 <sup>7</sup>
							0 986 474 879		→ 54	1 987 470 287 <sup>7</sup>
							0 986 474 879		→ 54	1 987 474 496 <sup>B</sup>
				PR-Code 1LY, PR-Code 1ZJ, PR-Code 1ZK	1LY		0 986 471 669		← 54	1 987 470 287 <sup>7</sup>
							0 986 473 669			1 987 474 496 <sup>B</sup>
							0 986 472 669		→ 54	1 987 470 287 <sup>7</sup>
							0 986 474 669			
	1.8	04.98-10.00	55/66	PR-Code 1LL	256		0 986 474 880		← 54	1 987 470 287 <sup>7</sup>
							0 986 474 879		→ 54	1 987 470 287 <sup>7</sup>
							0 986 474 879		→ 54	1 987 474 496 <sup>B</sup>
				PR-Code 1LY, PR-Code 1ZJ, PR-Code 1ZK	1LY		0 986 471 669		← 54	1 987 470 287 <sup>7</sup>
							0 986 473 669			1 987 474 496 <sup>B</sup>
							0 986 472 669		→ 54	1 987 470 287 <sup>7</sup>
							0 986 474 669			
	1.9 TDI	04.98-08.99	81	PR-Code 1LL	256		0 986 474 879		→ 54	1 987 474 496 <sup>B</sup>
		04.98-10.00	81	PR-Code 1LL	256		0 986 474 880		← 54	1 987 470 287 <sup>7</sup>
							0 986 474 879		→ 54	1 987 470 287 <sup>7</sup>
				PR-Code 1LY, PR-Code 1ZJ, PR-Code 1ZK	1LY		0 986 471 669		← 54	1 987 470 287 <sup>7</sup>
							0 986 473 669			1 987 474 496 <sup>B</sup>
							0 986 472 669		→ 54	1 987 470 287 <sup>7</sup>
							0 986 474 669			
		04.98-12.01	66	PR-Code 1LL	256		0 986 474 880		← 54	1 987 470 287 <sup>7</sup>
							0 986 474 879		→ 54	1 987 470 287 <sup>7</sup>
							0 986 474 879		→ 54	1 987 474 496 <sup>B</sup>
				PR-Code 1LY, PR-Code 1ZJ, PR-Code 1ZK	1LY		0 986 471 669		← 54	1 987 470 287 <sup>7</sup>
							0 986 473 669			1 987 474 496 <sup>B</sup>
							0 986 472 669		→ 54	1 987 470 287 <sup>7</sup>
							0 986 474 669			
		08.99-10.00	81	PR-Code 1LL	256		0 986 474 880		← 54	1 987 474 496 <sup>B</sup>
	2.0	04.98-12.01	85	PR-Code 1LY, PR-Code 1ZJ, PR-Code 1ZK	1LY		0 986 472 669		→ 54	1 987 474 496 <sup>B</sup>
							0 986 474 669			
		04.98-06.02	85	PR-Code 1LL	256		0 986 474 880		← 54	1 987 470 287 <sup>7</sup>
							0 986 474 879		→ 54	1 987 470 287 <sup>7</sup>
							0 986 474 879		→ 54	1 987 474 496 <sup>B</sup>
				PR-Code 1LY, PR-Code 1ZJ, PR-Code 1ZK	1LY		0 986 471 669		← 54	1 987 470 287 <sup>7</sup>
							0 986 473 669			1 987 474 496 <sup>B</sup>













		S							
	◀ VW Golf IV Cabriolet [1E7]								
<b>2.0</b>		06.99-06.02	85	PR-Code 1LY, PR-Code 1ZJ, PR-Code 1ZK	1LY		0986 472 669 0986 474 669	→ 54	1987 470 287 <sup>7</sup>
	<b>1.6</b>	04.98-07.98	74	Fg.-Nr. →1E..X..014 000, PR-Code 1KK			0986 474 875 0986 474 875 0986 474 876	← 38 ← 38 → 38	1987 470 040 <sup>7</sup> 1987 474 496 <sup>8</sup> 1987 470 040 <sup>7</sup>
		08.98-10.00	74	Fg.-Nr. 1E..X..014 001→, PR-Code 1KD, PR-Code 1KK, PR-Code 2EH			0986 473 072 0986 473 072 0986 474 072	← 38 ← 38 → 38	1987 470 040 <sup>7</sup> 1987 474 496 <sup>8</sup> 1987 470 040 <sup>7</sup>
	<b>1.8</b>	04.98-07.98	55/66	Fg.-Nr. →1E..X..014 000, PR-Code 1KK			0986 474 875 0986 474 875 0986 474 876	← 38 ← 38 → 38	1987 470 040 <sup>7</sup> 1987 474 496 <sup>8</sup> 1987 470 040 <sup>7</sup>
		08.98-10.00	55/66	Fg.-Nr. 1E..X..014 001→, PR-Code 1KD, PR-Code 1KK, PR-Code 2EH			0986 473 072 0986 473 072 0986 474 072	← 38 ← 38 → 38	1987 470 040 <sup>7</sup> 1987 474 496 <sup>8</sup> 1987 470 040 <sup>7</sup>
	<b>1.9 TDI</b>	04.98-07.98	66	Fg.-Nr. →1E..X..014 000, PR-Code 1KK			0986 474 875 0986 474 875 0986 474 876	← 38 ← 38 → 38	1987 470 040 <sup>7</sup> 1987 474 496 <sup>8</sup> 1987 470 040 <sup>7</sup>
			81	Fg.-Nr. →1E..X..014 000, PR-Code 1KK			0986 474 875 0986 474 875 0986 474 876	← 38 ← 38 → 38	1987 470 040 <sup>7</sup> 1987 474 496 <sup>8</sup> 1987 470 040 <sup>7</sup>
		08.98-08.99	81	Fg.-Nr. 1E..X..014 001→, PR-Code 1KD, PR-Code 1KK, PR-Code 2EH			0986 473 072 0986 473 072 0986 474 072	← 38 ← 38 → 38	1987 470 040 <sup>7</sup> 1987 474 496 <sup>8</sup> 1987 470 040 <sup>7</sup>
		08.98-12.01	66	Fg.-Nr. 1E..X..014 001→, PR-Code 1KD, PR-Code 1KK, PR-Code 2EH			0986 473 072 0986 473 072 0986 474 072	← 38 ← 38 → 38	1987 470 040 <sup>7</sup> 1987 474 496 <sup>8</sup> 1987 470 040 <sup>7</sup>
		08.99-10.00	81				0986 473 072 0986 473 072 0986 474 072	← 38 ← 38 → 38	1987 470 040 <sup>7</sup> 1987 474 496 <sup>8</sup> 1987 470 040 <sup>7</sup>
	<b>2.0</b>	04.98-07.98	85	Fg.-Nr. →1E..X..014 000, PR-Code 1KK			0986 474 875 0986 474 875 0986 474 876	← 38 ← 38 → 38	1987 470 040 <sup>7</sup> 1987 474 496 <sup>8</sup> 1987 470 040 <sup>7</sup>
		08.98-04.00	85	Fg.-Nr. 1E..X..014 001→, PR-Code 1KD, PR-Code 1KK, PR-Code 2EH			0986 474 072	→ 38	1987 474 496 <sup>8</sup>
		08.98-12.01	85	Fg.-Nr. 1E..X..014 001→, PR-Code 1KD, PR-Code 1KK, PR-Code 2EH			0986 473 072 0986 473 072 0986 474 072	← 38 ← 38 → 38	1987 470 040 <sup>7</sup> 1987 474 496 <sup>8</sup> 1987 470 040 <sup>7</sup>
		06.99-06.02	85				0986 473 072 0986 473 072 0986 474 072	← 38 ← 38 → 38	1987 470 040 <sup>7</sup> 1987 474 496 <sup>8</sup> 1987 470 040 <sup>7</sup>
	<b>1.6</b>	04.98-10.00	74				1987 477 393	↔ 1616	
	<b>1.8</b>	04.98-10.00	55/66				1987 477 393	↔ 1616	
	<b>1.9 TDI</b>	04.98-12.01	66/81				1987 477 393	↔ 1616	
	<b>2.0</b>	04.98-06.02	85				1987 477 393	↔ 1616	
	<b>1.6</b>	04.98-10.00	74				0986 594 003 <sup>4</sup>		
					LAB		0986 594 001 <sup>3</sup>		
					RAB		0986 594 000 <sup>3</sup>		
	<b>1.8</b>	04.98-10.00	55/66				0986 594 003 <sup>4</sup>		
					LAB		0986 594 001 <sup>3</sup>		
					RAB		0986 594 000 <sup>3</sup>		
	<b>1.9 TDI</b>	04.98-12.01	66/81				0986 594 003 <sup>4</sup>		
					LAB		0986 594 001 <sup>3</sup>		
					RAB		0986 594 000 <sup>3</sup>		
	<b>2.0</b>	04.98-06.02	85				0986 594 003 <sup>4</sup>		
					LAB		0986 594 001 <sup>3</sup>		
					RAB		0986 594 000 <sup>3</sup>		

		S								
<b>Golf IV Station Wagon [1J5]</b>										
	1.6 i	01.01-12.05	74			228,252		0 986 473 071	← 54	1 987 470 506 <sup>B</sup>
								0 986 474 071	→ 54	1 987 470 506 <sup>B</sup>
						288		0 986 471 923	← 54	1 987 470 506 <sup>B</sup>
								0 986 473 923		
								0 986 471 924	→ 54	1 987 470 506 <sup>B</sup>
								0 986 473 924		
	1.6 i	01.01-12.05	74	Fg.-Nr. 1J-YU008 822→,	232,B38			0 986 473 099	← 38,1	1 987 470 040 <sup>7</sup>
				1J-YB019 462→, 1J-YW238 581→,				0 986 473 099	← 38,1	1 987 474 496 <sup>B</sup>
				1J-YD128 802→, 1J-YP061 677→				0 986 474 099	→ 38,1	1 987 470 040 <sup>7</sup>
	1.6 i	01.01-12.05	74					1 987 477 698	↔ 1693	
	1.6 i	01.01-12.05	74					0 986 594 004 <sup>4</sup>		
						LAB		0 986 594 001 <sup>3</sup>		
						RAB		0 986 594 000 <sup>3</sup>		
<b>Golf IV Variant [1J5]</b>										
	1.4	05.99-06.06	55					0 986 473 071	← 54	1 987 470 506 <sup>B</sup>
								0 986 474 071	→ 54	1 987 470 506 <sup>B</sup>
	1.6	05.99-06.06	74/75/77/			228		0 986 473 071	← 54	1 987 470 506 <sup>B</sup>
	1.6 FSI		81					0 986 474 071	→ 54	1 987 470 506 <sup>B</sup>
						288		0 986 471 923	← 54	1 987 470 506 <sup>B</sup>
								0 986 473 923		
								0 986 471 924	→ 54	1 987 470 506 <sup>B</sup>
								0 986 473 924		
	1.8 T	05.99-05.03	92/110			228		0 986 473 071	← 54	1 987 470 506 <sup>B</sup>
	1.8 4Motion							0 986 474 071	→ 54	1 987 470 506 <sup>B</sup>
						288		0 986 471 923	← 54	1 987 470 506 <sup>B</sup>
								0 986 473 923		
								0 986 471 924	→ 54	1 987 470 506 <sup>B</sup>
								0 986 473 924		
	1.9 SDI	05.99-06.06	50/66/74/			228		0 986 473 071	← 54	1 987 470 506 <sup>B</sup>
	1.9 TDI		81/85/96					0 986 474 071	→ 54	1 987 470 506 <sup>B</sup>
	1.9 TDI 4Motion					288		0 986 471 923	← 54	1 987 470 506 <sup>B</sup>
								0 986 473 923		
								0 986 471 924	→ 54	1 987 470 506 <sup>B</sup>
								0 986 473 924		
	2.0	05.99-06.06	85			228		0 986 473 071	← 54	1 987 470 506 <sup>B</sup>
	2.0 BiFuel							0 986 474 071	→ 54	1 987 470 506 <sup>B</sup>
	2.0 4Motion					288		0 986 471 923	← 54	1 987 470 506 <sup>B</sup>
								0 986 473 923		
								0 986 471 924	→ 54	1 987 470 506 <sup>B</sup>
								0 986 473 924		
	2.3	05.99-02.01	110					0 986 471 923	← 54	1 987 470 506 <sup>B</sup>
	2.3 4Motion							0 986 473 923		
								0 986 471 924	→ 54	1 987 470 506 <sup>B</sup>
								0 986 473 924		
		09.00-06.06	125			288,312		0 986 471 923	← 54	1 987 470 506 <sup>B</sup>
								0 986 473 923		
								0 986 471 924	→ 54	1 987 470 506 <sup>B</sup>
								0 986 473 924		



	<b>2.8 4Motion</b>	05.99-04.01	150			0986 471 923	← 54	1987 470 506 <sup>8</sup>
						0986 473 923	↻	
						0986 471 924	→ 54	1987 470 506 <sup>8</sup>
						0986 473 924	↻	
		05.01-06.06	150		288,312	0986 471 923	← 54	1987 470 506 <sup>8</sup>
						0986 473 923	↻	
						0986 471 924	→ 54	1987 470 506 <sup>8</sup>
						0986 473 924	↻	
	<b>1.4</b>	05.99-07.99	55	PR-Code 1KP, PR-Code 1KT	232	0986 473 106	↻ ← 41	1987 474 496 <sup>8</sup>
						0986 474 106	↻ → 41	1987 474 496 <sup>8</sup>
		05.99-06.06	55	PR-Code 1KY	252,BSR	0986 473 139	↻ ← 38,1	1987 470 040 <sup>7</sup>
						0986 473 139	↻ ← 38,1	1987 474 496 <sup>8</sup>
						0986 474 139	↻ → 38,1	1987 470 040 <sup>7</sup>
					252,BSR	0986 473 147	↻ ← 38	1987 470 040 <sup>7</sup>
						0986 474 147	↻ → 38	1987 470 040 <sup>7</sup>
		08.99-06.06	55	PR-Code 1KP, PR-Code 1KT, PR-Code 1KX	232	0986 473 029	↻ ← 41	1987 474 496 <sup>8</sup>
						0986 474 029	↻ → 41	1987 474 496 <sup>8</sup>
		05.01-06.06	55	PR-Code 1KK, PR-Code 1KS, PR-Code 1KV	232	0986 473 099	↻ ← 38,1	1987 470 040 <sup>7</sup>
						0986 473 099	↻ ← 38,1	1987 474 496 <sup>8</sup>
						0986 474 099	↻ → 38,1	1987 470 040 <sup>7</sup>
	<b>1.6</b>	05.99-07.99	74	PR-Code 1KP, PR-Code 1KT	232	0986 473 106	↻ ← 41	1987 474 496 <sup>8</sup>
						0986 474 106	↻ → 41	1987 474 496 <sup>8</sup>
			77	PR-Code 1KP, PR-Code 1KT	232	0986 473 106	↻ ← 41	1987 474 496 <sup>8</sup>
						0986 474 106	↻ → 41	1987 474 496 <sup>8</sup>
		05.99-06.06	74	PR-Code 1KY	252,BSR	0986 473 139	↻ ← 38,1	1987 470 040 <sup>7</sup>
						0986 473 139	↻ ← 38,1	1987 474 496 <sup>8</sup>
						0986 474 139	↻ → 38,1	1987 470 040 <sup>7</sup>
					252,BSR	0986 473 147	↻ ← 38	1987 470 040 <sup>7</sup>
						0986 474 147	↻ → 38	1987 470 040 <sup>7</sup>
			77	PR-Code 1KY	252,BSR	0986 473 139	↻ ← 38,1	1987 470 040 <sup>7</sup>
						0986 473 139	↻ ← 38,1	1987 474 496 <sup>8</sup>
						0986 474 139	↻ → 38,1	1987 470 040 <sup>7</sup>
					252,BSR	0986 473 147	↻ ← 38	1987 470 040 <sup>7</sup>
						0986 474 147	↻ → 38	1987 470 040 <sup>7</sup>
		08.99-06.06	74	PR-Code 1KP, PR-Code 1KT, PR-Code 1KX	232	0986 473 029	↻ ← 41	1987 474 496 <sup>8</sup>
						0986 474 029	↻ → 41	1987 474 496 <sup>8</sup>
			77	PR-Code 1KP, PR-Code 1KT, PR-Code 1KX	232	0986 473 029	↻ ← 41	1987 474 496 <sup>8</sup>
						0986 474 029	↻ → 41	1987 474 496 <sup>8</sup>
		09.00-06.06	75	PR-Code 1KP, PR-Code 1KT, PR-Code 1KX	232	0986 473 029	↻ ← 41	1987 474 496 <sup>8</sup>
				PR-Code 1KY	252,BSR	0986 473 139	↻ ← 38,1	1987 470 040 <sup>7</sup>
						0986 473 139	↻ ← 38,1	1987 474 496 <sup>8</sup>
						0986 474 139	↻ → 38,1	1987 470 040 <sup>7</sup>
					252,BSR	0986 473 147	↻ ← 38	1987 470 040 <sup>7</sup>
						0986 474 147	↻ → 38	1987 470 040 <sup>7</sup>
		05.01-06.06	74	PR-Code 1KK, PR-Code 1KS, PR-Code 1KV	232	0986 473 099	↻ ← 38,1	1987 470 040 <sup>7</sup>
						0986 473 099	↻ ← 38,1	1987 474 496 <sup>8</sup>
						0986 474 099	↻ → 38,1	1987 470 040 <sup>7</sup>
			75	PR-Code 1KK, PR-Code 1KS, PR-Code 1KV	232	0986 473 099	↻ ← 38,1	1987 470 040 <sup>7</sup>
						0986 473 099	↻ ← 38,1	1987 474 496 <sup>8</sup>
						0986 474 099	↻ → 38,1	1987 470 040 <sup>7</sup>
			77	PR-Code 1KK, PR-Code 1KS, PR-Code 1KV	232	0986 473 099	↻ ← 38,1	1987 470 040 <sup>7</sup>
						0986 473 099	↻ ← 38,1	1987 474 496 <sup>8</sup>
						0986 474 099	↻ → 38,1	1987 470 040 <sup>7</sup>
	<b>1.6 FSI</b>	08.01-06.06	81	PR-Code 1KK, PR-Code 1KS, PR-Code 1KV	232	0986 473 099	↻ ← 38,1	1987 470 040 <sup>7</sup>
						0986 473 099	↻ ← 38,1	1987 474 496 <sup>8</sup>
						0986 474 099	↻ → 38,1	1987 470 040 <sup>7</sup>
				PR-Code 1KP, PR-Code 1KT, PR-Code 1KX	232	0986 473 029	↻ ← 41	1987 474 496 <sup>8</sup>
						0986 474 029	↻ → 41	1987 474 496 <sup>8</sup>



		<b>S</b>							
<b>1.6FSI</b>	08.01-06.06	81	PR-Code 1KY	252,BSR	0 986 473 139	← 38,1	1 987 470 040 <sup>7</sup>		
					0 986 473 139	← 38,1	1 987 474 496 <sup>8</sup>		
					0 986 474 139	→ 38,1	1 987 470 040 <sup>7</sup>		
					252,BSR	0 986 473 147	← 38	1 987 470 040 <sup>7</sup>	
					0 986 474 147	→ 38	1 987 470 040 <sup>7</sup>		
					<b>1.8T</b>	05.99-07.99	110	PR-Code 1KP, PR-Code 1KT	232
0 986 474 106	→ 41	1 987 474 496 <sup>8</sup>							
05.99-05.03	110	PR-Code 1KY	252,BSR	0 986 473 139		← 38,1	1 987 470 040 <sup>7</sup>		
				0 986 473 139		← 38,1	1 987 474 496 <sup>8</sup>		
				0 986 474 139		→ 38,1	1 987 470 040 <sup>7</sup>		
				252,BSR		0 986 473 147	← 38	1 987 470 040 <sup>7</sup>	
0 986 474 147	→ 38	1 987 470 040 <sup>7</sup>							
08.99-05.03	110	PR-Code 1KP, PR-Code 1KT, PR-Code 1KX	232	0 986 473 029		← 41	1 987 474 496 <sup>8</sup>		
				0 986 474 029		→ 41	1 987 474 496 <sup>8</sup>		
05.01-05.03	110	PR-Code 1KK, PR-Code 1KS, PR-Code 1KV	232	0 986 473 099		← 38,1	1 987 470 040 <sup>7</sup>		
				0 986 473 099		← 38,1	1 987 474 496 <sup>8</sup>		
				0 986 474 099		→ 38,1	1 987 470 040 <sup>7</sup>		
<b>1.84Motion</b>	05.99-10.00	92	PR-Code 1KE, PR-Code 2EG	252	0 986 473 029	← 41	1 987 474 496 <sup>8</sup>		
					0 986 474 029	→ 41	1 987 474 496 <sup>8</sup>		
			PR-Code 1KU, PR-Code 2EE	0 986 473 139	← 38,1	1 987 470 040 <sup>7</sup>			
				0 986 473 139	← 38,1	1 987 474 496 <sup>8</sup>			
				0 986 474 139	→ 38,1	1 987 470 040 <sup>7</sup>			
<b>1.9SDI</b>	05.99-07.99	50	PR-Code 1KP, PR-Code 1KT	232	0 986 473 106	← 41	1 987 474 496 <sup>8</sup>		
					0 986 474 106	→ 41	1 987 474 496 <sup>8</sup>		
	05.99-06.06	50	PR-Code 1KY	252,BSR	0 986 473 139	← 38,1	1 987 470 040 <sup>7</sup>		
					0 986 473 139	← 38,1	1 987 474 496 <sup>8</sup>		
					0 986 474 139	→ 38,1	1 987 470 040 <sup>7</sup>		
					252,BSR	0 986 473 147	← 38	1 987 470 040 <sup>7</sup>	
	0 986 474 147	→ 38	1 987 470 040 <sup>7</sup>						
	08.99-06.06	50	PR-Code 1KP, PR-Code 1KT, PR-Code 1KX	232	0 986 473 029	← 41	1 987 474 496 <sup>8</sup>		
					0 986 474 029	→ 41	1 987 474 496 <sup>8</sup>		
	05.01-06.06	50	PR-Code 1KK, PR-Code 1KS, PR-Code 1KV	232	0 986 473 099	← 38,1	1 987 470 040 <sup>7</sup>		
					0 986 473 099	← 38,1	1 987 474 496 <sup>8</sup>		
					0 986 474 099	→ 38,1	1 987 470 040 <sup>7</sup>		
<b>1.9TDI</b>	05.99-07.99	66	PR-Code 1KP, PR-Code 1KT	232	0 986 473 106	← 41	1 987 474 496 <sup>8</sup>		
					0 986 474 106	→ 41	1 987 474 496 <sup>8</sup>		
		81	PR-Code 1KP, PR-Code 1KT	232	0 986 473 106	← 41	1 987 474 496 <sup>8</sup>		
					0 986 474 106	→ 41	1 987 474 496 <sup>8</sup>		
		85	PR-Code 1KP, PR-Code 1KT	232	0 986 473 106	← 41	1 987 474 496 <sup>8</sup>		
					0 986 474 106	→ 41	1 987 474 496 <sup>8</sup>		
	05.99-07.01	85	PR-Code 1KY	252,BSR	0 986 473 139	← 38,1	1 987 470 040 <sup>7</sup>		
					0 986 473 139	← 38,1	1 987 474 496 <sup>8</sup>		
					0 986 474 139	→ 38,1	1 987 470 040 <sup>7</sup>		
				252,BSR	0 986 473 147	← 38	1 987 470 040 <sup>7</sup>		
					0 986 474 147	→ 38	1 987 470 040 <sup>7</sup>		
					0 986 473 139	← 38,1	1 987 470 040 <sup>7</sup>		
	05.99-06.06	66	PR-Code 1KY	252,BSR	0 986 473 139	← 38,1	1 987 470 040 <sup>7</sup>		
					0 986 473 139	← 38,1	1 987 474 496 <sup>8</sup>		
					0 986 474 139	→ 38,1	1 987 470 040 <sup>7</sup>		
				252,BSR	0 986 473 147	← 38	1 987 470 040 <sup>7</sup>		
					0 986 474 147	→ 38	1 987 470 040 <sup>7</sup>		
					0 986 473 139	← 38,1	1 987 470 040 <sup>7</sup>		
	81	PR-Code 1KY	252,BSR	0 986 473 139	← 38,1	1 987 470 040 <sup>7</sup>			
				0 986 473 139	← 38,1	1 987 474 496 <sup>8</sup>			
				0 986 474 139	→ 38,1	1 987 470 040 <sup>7</sup>			
			252,BSR	0 986 473 147	← 38	1 987 470 040 <sup>7</sup>			
				0 986 474 147	→ 38	1 987 470 040 <sup>7</sup>			
				0 986 473 139	← 38,1	1 987 474 496 <sup>8</sup>			
08.99-07.01	85	PR-Code 1KP, PR-Code 1KT, PR-Code 1KX	232	0 986 473 029	← 41	1 987 474 496 <sup>8</sup>			
				0 986 474 029	→ 41	1 987 474 496 <sup>8</sup>			
08.99-06.06	66	PR-Code 1KP, PR-Code 1KT, PR-Code 1KX	232	0 986 473 029	← 41	1 987 474 496 <sup>8</sup>			
				0 986 474 029	→ 41	1 987 474 496 <sup>8</sup>			
81	PR-Code 1KP, PR-Code 1KT, PR-Code 1KX	232	0 986 473 029	← 41	1 987 474 496 <sup>8</sup>				
			0 986 474 029	→ 41	1 987 474 496 <sup>8</sup>				
01.00-06.06	74	PR-Code 1KP, PR-Code 1KT, PR-Code 1KX	232	0 986 473 029	← 41	1 987 474 496 <sup>8</sup>			
				0 986 474 029	→ 41	1 987 474 496 <sup>8</sup>			

<b>VW Golf IV Variant [1J5]</b>								
<b>1.9 TDI</b>	01.00-06.06	74	PR-Code 1KY	252,BSR	0986 473 139		← 38,1	1987 470 0407
					0986 473 139		← 38,1	1987 474 4968
					0986 474 139		→ 38,1	1987 470 0407
				252,BSR	0986 473 147		← 38	1987 470 0407
					0986 474 147		→ 38	1987 470 0407
	04.01-06.06	96	PR-Code 1KP, PR-Code 1KT, PR-Code 1KX	232	0986 473 029		← 41	1987 474 4968
					0986 474 029		→ 41	1987 474 4968
			PR-Code 1KY	252,BSR	0986 473 139		← 38,1	1987 470 0407
					0986 473 139		← 38,1	1987 474 4968
					0986 474 139		→ 38,1	1987 470 0407
				252,BSR	0986 473 147		← 38	1987 470 0407
					0986 474 147		→ 38	1987 470 0407
	05.01-07.01	85	PR-Code 1KK, PR-Code 1KS, PR-Code 1KV	232	0986 473 099		← 38,1	1987 470 0407
					0986 473 099		← 38,1	1987 474 4968
					0986 474 099		→ 38,1	1987 470 0407
	05.01-06.06	66	PR-Code 1KK, PR-Code 1KS, PR-Code 1KV	232	0986 473 099		← 38,1	1987 470 0407
					0986 473 099		← 38,1	1987 474 4968
					0986 474 099		→ 38,1	1987 470 0407
		74	PR-Code 1KK, PR-Code 1KS, PR-Code 1KV	232	0986 473 099		← 38,1	1987 470 0407
					0986 473 099		← 38,1	1987 474 4968
					0986 474 099		→ 38,1	1987 470 0407
		81	PR-Code 1KK, PR-Code 1KS, PR-Code 1KV	232	0986 473 099		← 38,1	1987 470 0407
					0986 473 099		← 38,1	1987 474 4968
					0986 474 099		→ 38,1	1987 470 0407
		96	PR-Code 1KK, PR-Code 1KS, PR-Code 1KV	232	0986 473 099		← 38,1	1987 470 0407
					0986 473 099		← 38,1	1987 474 4968
					0986 474 099		→ 38,1	1987 470 0407
<b>1.9 TDI 4Motion</b>	05.99-07.01	85	PR-Code 1KE, PR-Code 2EG	252	0986 473 029		← 41	1987 474 4968
					0986 474 029		→ 41	1987 474 4968
			PR-Code 1KU, PR-Code 2EE	252	0986 473 139		← 38,1	1987 470 0407
					0986 473 139		← 38,1	1987 474 4968
					0986 474 139		→ 38,1	1987 470 0407
	05.99-04.02	66	PR-Code 1KE, PR-Code 2EG	252	0986 473 029		← 41	1987 474 4968
					0986 474 029		→ 41	1987 474 4968
			PR-Code 1KU, PR-Code 2EE	252	0986 473 139		← 38,1	1987 470 0407
					0986 473 139		← 38,1	1987 474 4968
					0986 474 139		→ 38,1	1987 470 0407
	02.00-06.06	74	PR-Code 1KE, PR-Code 2EG	252	0986 473 029		← 41	1987 474 4968
					0986 474 029		→ 41	1987 474 4968
			PR-Code 1KU, PR-Code 2EE	252	0986 473 139		← 38,1	1987 470 0407
					0986 473 139		← 38,1	1987 474 4968
					0986 474 139		→ 38,1	1987 470 0407
	04.01-06.06	96	PR-Code 1KE, PR-Code 2EG	252	0986 473 029		← 41	1987 474 4968
					0986 474 029		→ 41	1987 474 4968
			PR-Code 1KU, PR-Code 2EE	252	0986 473 139		← 38,1	1987 470 0407
					0986 473 139		← 38,1	1987 474 4968
					0986 474 139		→ 38,1	1987 470 0407
<b>2.0</b>	05.99-07.99	85	PR-Code 1KP, PR-Code 1KT	232	0986 473 106		← 41	1987 474 4968
					0986 474 106		→ 41	1987 474 4968
	05.99-06.06	85	PR-Code 1KY	252,BSR	0986 473 139		← 38,1	1987 470 0407
					0986 474 139		→ 38,1	1987 470 0407
<b>2.0 BiFuel</b>	05.99-06.06	85	PR-Code 1KY	252,BSR	0986 474 139		→ 38,1	1987 474 4968
					0986 473 147		← 38	1987 470 0407
					0986 474 147		→ 38	1987 470 0407
	08.99-06.06	85	PR-Code 1KP, PR-Code 1KT, PR-Code 1KX	232	0986 473 029		← 41	1987 474 4968
					0986 474 029		→ 41	1987 474 4968
	05.01-06.06	85	PR-Code 1KK, PR-Code 1KS, PR-Code 1KV	232	0986 473 099		← 38,1	1987 470 0407
					0986 473 099		← 38,1	1987 474 4968
					0986 474 099		→ 38,1	1987 470 0407
<b>2.0 BiFuel</b>	05.02-06.06	85	PR-Code 1KY	252,BSR	0986 473 139		← 38,1	1987 470 0407
					0986 473 139		← 38,1	1987 474 4968
<b>2.0 4Motion</b>	04.00-06.06	85	PR-Code 1KE, PR-Code 2EG	252	0986 473 029		← 41	1987 474 4968
					0986 474 029		→ 41	1987 474 4968



		S								
<b>2.0 4Motion</b>		04.00-06.06	85	PR-Code 1KU, PR-Code 2EE	252		0 986 473 139		← 38,1	1 987 470 040 <sup>7</sup>
							0 986 473 139		← 38,1	1 987 474 496 <sup>8</sup>
							0 986 474 139		→ 38,1	1 987 470 040 <sup>7</sup>
<b>2.3</b>		05.99-07.99	110	PR-Code 1KP, PR-Code 1KT	232		0 986 473 106		← 41	1 987 474 496 <sup>8</sup>
							0 986 474 106		→ 41	1 987 474 496 <sup>8</sup>
		05.99-02.01	110	PR-Code 1KY	252,BSR		0 986 473 139		← 38,1	1 987 470 040 <sup>7</sup>
							0 986 473 139		← 38,1	1 987 474 496 <sup>8</sup>
							0 986 474 139		→ 38,1	1 987 470 040 <sup>7</sup>
					252,BSR		0 986 473 147		← 38	1 987 470 040 <sup>7</sup>
							0 986 474 147		→ 38	1 987 470 040 <sup>7</sup>
		08.99-02.01	110	PR-Code 1KP, PR-Code 1KT, PR-Code 1KX	232		0 986 473 029		← 41	1 987 474 496 <sup>8</sup>
							0 986 474 029		→ 41	1 987 474 496 <sup>8</sup>
		09.00-06.06	125	PR-Code 1KP, PR-Code 1KT, PR-Code 1KX	232		0 986 473 029		← 41	1 987 474 496 <sup>8</sup>
							0 986 474 029		→ 41	1 987 474 496 <sup>8</sup>
				PR-Code 1KY	252,BSR		0 986 473 139		← 38,1	1 987 470 040 <sup>7</sup>
							0 986 473 139		← 38,1	1 987 474 496 <sup>8</sup>
							0 986 474 139		→ 38,1	1 987 470 040 <sup>7</sup>
					252,BSR		0 986 473 147		← 38	1 987 470 040 <sup>7</sup>
							0 986 474 147		→ 38	1 987 470 040 <sup>7</sup>
		05.01-06.06	125	PR-Code 1KK, PR-Code 1KS, PR-Code 1KV	232		0 986 473 099		← 38,1	1 987 470 040 <sup>7</sup>
							0 986 473 099		← 38,1	1 987 474 496 <sup>8</sup>
							0 986 474 099		→ 38,1	1 987 470 040 <sup>7</sup>
<b>2.3 4Motion</b>		05.99-02.01	110	PR-Code 1KE, PR-Code 2EG			0 986 473 029		← 41	1 987 474 496 <sup>8</sup>
							0 986 474 029		→ 41	1 987 474 496 <sup>8</sup>
				PR-Code 1KU, PR-Code 2EE	252		0 986 473 139		← 38,1	1 987 470 040 <sup>7</sup>
							0 986 473 139		← 38,1	1 987 474 496 <sup>8</sup>
							0 986 474 139		→ 38,1	1 987 470 040 <sup>7</sup>
		09.00-06.06	125	PR-Code 1KE, PR-Code 2EG			0 986 473 029		← 41	1 987 474 496 <sup>8</sup>
							0 986 474 029		→ 41	1 987 474 496 <sup>8</sup>
				PR-Code 1KU, PR-Code 2EE	252		0 986 473 139		← 38,1	1 987 470 040 <sup>7</sup>
							0 986 473 139		← 38,1	1 987 474 496 <sup>8</sup>
							0 986 474 139		→ 38,1	1 987 470 040 <sup>7</sup>
<b>2.8 4Motion</b>		05.99-06.06	150	PR-Code 1KE, PR-Code 2EG			0 986 473 029		← 41	1 987 474 496 <sup>8</sup>
							0 986 474 029		→ 41	1 987 474 496 <sup>8</sup>
				PR-Code 1KU, PR-Code 2EE	252		0 986 473 139		← 38,1	1 987 470 040 <sup>7</sup>
							0 986 473 139		← 38,1	1 987 474 496 <sup>8</sup>
							0 986 474 139		→ 38,1	1 987 470 040 <sup>7</sup>
							0 986 474 139		→ 38,1	1 987 470 040 <sup>7</sup>
							0 986 473 029		← 41	1 987 474 496 <sup>8</sup>
							0 986 474 029		→ 41	1 987 474 496 <sup>8</sup>
							0 986 473 139		← 38,1	1 987 470 040 <sup>7</sup>
							0 986 473 139		← 38,1	1 987 474 496 <sup>8</sup>
							0 986 474 139		→ 38,1	1 987 470 040 <sup>7</sup>
							0 986 474 139		→ 38,1	1 987 470 040 <sup>7</sup>
<b>1.4</b>		05.99-07.99	55				1 987 477 696		↔ 1688	
		08.99-06.06	55				1 987 477 698		↔ 1693	
<b>1.6</b>		05.99-07.99	74				1 987 477 696		↔ 1688	
			77				1 987 477 696		↔ 1688	
		08.99-06.06	74				1 987 477 698		↔ 1693	
			77				1 987 477 698		↔ 1693	
		09.00-06.06	75				1 987 477 698		↔ 1693	
<b>1.6 FSI</b>		08.01-06.06	81				1 987 477 698		↔ 1693	
<b>1.8 T</b>		05.99-07.99	110				1 987 477 696		↔ 1688	
		08.99-05.03	110				1 987 477 698		↔ 1693	
<b>1.8 4Motion</b>		05.99-10.00	92				1 987 477 686		↔ 1723	
<b>1.9 SDI</b>		05.99-07.99	50				1 987 477 696		↔ 1688	
		08.99-06.06	50				1 987 477 698		↔ 1693	
<b>1.9 TDI</b>		05.99-07.99	66				1 987 477 696		↔ 1688	
			81				1 987 477 696		↔ 1688	
			85				1 987 477 696		↔ 1688	
		08.99-07.01	85				1 987 477 698		↔ 1693	
		08.99-06.06	66				1 987 477 698		↔ 1693	
			81				1 987 477 698		↔ 1693	
		01.00-06.06	74				1 987 477 698		↔ 1693	
		04.01-06.06	96				1 987 477 698		↔ 1693	
<b>1.9 TDI 4Motion</b>		05.99-07.01	85				1 987 477 686		↔ 1723	
		05.99-04.02	66				1 987 477 686		↔ 1723	



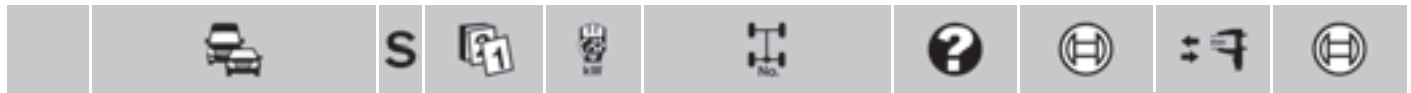



















































◀ VW Golf IV Variant [1J5]

1.9 TDI 4Motion	02.00-06.06	74		1987 477 686	↔ 1723
	04.01-06.06	96		1987 477 686	↔ 1723
2.0	05.99-07.99	85		1987 477 696	↔ 1688
	08.99-06.06	85		1987 477 698	↔ 1693
2.0 BiFuel	05.02-06.06	85		1987 477 698	↔ 1693
2.0 4Motion	04.00-06.06	85		1987 477 686	↔ 1723
2.3	05.99-07.99	110		1987 477 696	↔ 1688
	08.99-02.01	110		1987 477 698	↔ 1693
	09.00-06.06	125		1987 477 698	↔ 1693
2.3 4Motion	05.99-02.01	110		1987 477 686	↔ 1723
	09.00-06.06	125		1987 477 686	↔ 1723
2.8 4Motion	05.99-06.06	150		1987 477 686	↔ 1723

1.4	05.99-06.06	55		0986 594 004 <sup>4</sup>	
			LAB	0986 594 001 <sup>3</sup>	
			RAB	0986 594 000 <sup>3</sup>	
1.6	05.99-06.06	74/75/77/		0986 594 004 <sup>4</sup>	
1.6 FSI		81		0986 594 001 <sup>3</sup>	
			LAB	0986 594 001 <sup>3</sup>	
			RAB	0986 594 000 <sup>3</sup>	
1.8 T	05.99-05.03	110		0986 594 004 <sup>4</sup>	
			LAB	0986 594 001 <sup>3</sup>	
			RAB	0986 594 000 <sup>3</sup>	
1.8 4Motion	05.99-10.00	92		0986 594 008 <sup>4</sup>	
			LAB	0986 594 001 <sup>3</sup>	
			RAB	0986 594 000 <sup>3</sup>	
1.9 SDI	05.99-06.06	50		0986 594 004 <sup>4</sup>	
			LAB	0986 594 001 <sup>3</sup>	
			RAB	0986 594 000 <sup>3</sup>	
1.9 TDI	05.99-06.06	66/74		0986 594 004 <sup>4</sup>	
		81		0986 594 004 <sup>4</sup>	
			LAB	0986 594 001 <sup>3</sup>	
			RAB	0986 594 000 <sup>3</sup>	
		85/96		0986 594 004 <sup>4</sup>	
1.9 TDI	05.99-06.06	66/74		0986 594 001 <sup>3</sup>	
			LAB	0986 594 001 <sup>3</sup>	
1.9 TDI 4Motion				0986 594 000 <sup>3</sup>	
			LAB	0986 594 001 <sup>3</sup>	
		85/96		0986 594 000 <sup>3</sup>	
			RAB	0986 594 000 <sup>3</sup>	
1.9 TDI 4Motion	05.99-06.06	66/74		0986 594 008 <sup>4</sup>	
		85/96		0986 594 008 <sup>4</sup>	
2.0, BiFuel	05.99-06.06	85		0986 594 004 <sup>4</sup>	
2.0, BiFuel, 4Motion	05.99-06.06	85		0986 594 001 <sup>3</sup>	
			LAB	0986 594 001 <sup>3</sup>	
			RAB	0986 594 000 <sup>3</sup>	
2.0 4Motion	04.00-06.06	85		0986 594 008 <sup>4</sup>	
2.3	05.99-06.06	110/125		0986 594 004 <sup>4</sup>	
2.3	05.99-06.06	110/125		0986 594 001 <sup>3</sup>	
			LAB	0986 594 001 <sup>3</sup>	
2.3 4Motion			RAB	0986 594 000 <sup>3</sup>	
2.3 4Motion	05.99-06.06	110/125		0986 594 008 <sup>4</sup>	
2.8 4Motion	05.99-06.06	150		0986 594 008 <sup>4</sup>	
			LAB	0986 594 001 <sup>3</sup>	
			RAB	0986 594 000 <sup>3</sup>	

**Golf IV [1J1]**

1.4	10.97-05.04	55		0986 473 071	← 54	1987 470 506 <sup>8</sup>
				0986 474 071	→ 54	1987 470 506 <sup>8</sup>
1.6	10.97-05.04	74	228	0986 473 071	← 54	1987 470 506 <sup>8</sup>
				0986 474 071	→ 54	1987 470 506 <sup>8</sup>
			252	0986 473 071	← 54	1987 470 506 <sup>8</sup>
				0986 474 071	→ 54	1987 470 506 <sup>8</sup>





































































		S									
1.6	10.97-05.04	74				288	0 986 471 923	← 54	1 987 470 506 <sup>B</sup>		
							0 986 473 923				
							0 986 471 924	→ 54	1 987 470 506 <sup>B</sup>		
	11.99-05.00	77				228	0 986 473 071		← 54	1 987 470 506 <sup>B</sup>	
							0 986 474 071		→ 54	1 987 470 506 <sup>B</sup>	
							0 986 473 071		← 54	1 987 470 506 <sup>B</sup>	
							0 986 474 071		→ 54	1 987 470 506 <sup>B</sup>	
	05.00-05.04	77				228,252	0 986 473 071		← 54	1 987 470 506 <sup>B</sup>	
							0 986 474 071		→ 54	1 987 470 506 <sup>B</sup>	
	09.00-05.04	75				228,252	0 986 473 071		← 54	1 987 470 506 <sup>B</sup>	
							0 986 474 071		→ 54	1 987 470 506 <sup>B</sup>	
						288	0 986 471 923	← 54	1 987 470 506 <sup>B</sup>		
							0 986 473 923				
							0 986 471 924	→ 54	1 987 470 506 <sup>B</sup>		
							0 986 473 924				
05.02-05.04	75		PR-Code 1ZF			0 986 473 071		← 54	1 987 470 506 <sup>B</sup>		
						0 986 474 071		→ 54	1 987 470 506 <sup>B</sup>		
1.6 FSI	08.01-05.04	81				228,252	0 986 473 071		← 54	1 987 470 506 <sup>B</sup>	
							0 986 474 071		→ 54	1 987 470 506 <sup>B</sup>	
1.6 i	10.97-12.05	74				228,252	0 986 473 071		← 54	1 987 470 506 <sup>B</sup>	
							0 986 474 071		→ 54	1 987 470 506 <sup>B</sup>	
							0 986 471 923	← 54	1 987 470 506 <sup>B</sup>		
	288	0 986 473 923									
		0 986 471 924	→ 54	1 987 470 506 <sup>B</sup>							
		0 986 473 924									
	312,BSR	0 986 471 923	← 54	1 987 470 506 <sup>B</sup>							
		0 986 473 923									
		0 986 471 924	→ 54	1 987 470 506 <sup>B</sup>							
		0 986 473 924									
	312,BSR	0 986 473 923		← 54	1 987 470 506 <sup>B</sup>						
		0 986 473 924		→ 54	1 987 470 506 <sup>B</sup>						
	1.8	10.97-10.00	92				228	0 986 473 071		← 54	1 987 470 506 <sup>B</sup>
								0 986 474 071		→ 54	1 987 470 506 <sup>B</sup>
							288	0 986 471 923	← 54	1 987 470 506 <sup>B</sup>	
0 986 473 923											
0 986 471 924								→ 54	1 987 470 506 <sup>B</sup>		
0 986 473 924											
1.8 i	02.99-08.00	92				228,252	0 986 473 071		← 54	1 987 470 506 <sup>B</sup>	
							0 986 474 071		→ 54	1 987 470 506 <sup>B</sup>	
						288	0 986 471 923	← 54	1 987 470 506 <sup>B</sup>		
							0 986 473 923				
							0 986 471 924	→ 54	1 987 470 506 <sup>B</sup>		
							0 986 473 924				
	312,BSR	0 986 471 923	← 54	1 987 470 506 <sup>B</sup>							
		0 986 473 923									
	312,BSR	0 986 471 924	→ 54	1 987 470 506 <sup>B</sup>							
		0 986 473 924									
		0 986 473 923		← 54	1 987 470 506 <sup>B</sup>						
		0 986 473 924		→ 54	1 987 470 506 <sup>B</sup>						
1.8 T	10.97-05.03	110				228	0 986 473 071		← 54	1 987 470 506 <sup>B</sup>	
							0 986 474 071		→ 54	1 987 470 506 <sup>B</sup>	
						288	0 986 471 923	← 54	1 987 470 506 <sup>B</sup>		
							0 986 473 923				
							0 986 471 924	→ 54	1 987 470 506 <sup>B</sup>		
							0 986 473 924				
02.99-12.05	110				228,252	0 986 473 071		← 54	1 987 470 506 <sup>B</sup>		
						0 986 474 071		→ 54	1 987 470 506 <sup>B</sup>		
					288,312	0 986 471 923	← 54	1 987 470 506 <sup>B</sup>			
						0 986 473 923					
						0 986 471 924	→ 54	1 987 470 506 <sup>B</sup>			
						0 986 473 924					





◀ VW Golf IV [1J1]								
1.8 T	02.99-12.05	110		312,BSR	0986 471 923	← 54	1987 470 506 <sup>8</sup>	
					0986 473 923			
					0986 471 924	→ 54		
					0986 473 924			
	06.01-05.04	132			312,BSR	← 54	1987 470 506 <sup>8</sup>	
					0986 473 923			
					0986 473 924	→ 54		
					0986 473 924			
	05.03-12.05	132		312	0986 471 923	← 54	1987 470 506 <sup>8</sup>	
					0986 473 923			
					0986 471 924	→ 54		
					0986 473 924			
1.8 4Motion	07.98-10.00	92		228	← 54	1987 470 506 <sup>8</sup>		
				0986 473 071				
				0986 474 071	→ 54			
	288	0986 471 923	← 54	1987 470 506 <sup>8</sup>				
		0986 473 923						
		0986 471 924	→ 54					
1.9 SDI	10.97-05.04	50	PR-Code 1LN, PR-Code 1LE, PR-Code 1ZH, PR-Code 1ZE, PR-Code 1ZD	288	← 54	1987 470 506 <sup>8</sup>		
				0986 471 923				
				0986 471 924	→ 54			
	228,252	PR-Code 1LQ, PR-Code 1ZF, PR-Code 1LR, PR-Code 1LS, PR-Code 1ZM, PR-Code 1ZP	← 54	1987 470 506 <sup>8</sup>				
		0986 473 071						
		0986 474 071	→ 54					
1.9 TDI	10.97-05.04	66/74		228,252	← 54	1987 470 506 <sup>8</sup>		
				0986 473 071				
	81	228	← 54	1987 470 506 <sup>8</sup>				
		0986 473 071						
	10.97-12.05	81		288	0986 471 923	← 54	1987 470 506 <sup>8</sup>	
					0986 473 923			
	0986 471 924	→ 54	1987 470 506 <sup>8</sup>					
		0986 473 924						
	05.00-12.05	81		228,252	0986 473 071	← 54	1987 470 506 <sup>8</sup>	
					0986 474 071	→ 54		
					312,BSR	← 54		1987 470 506 <sup>8</sup>
					0986 471 923			
0986 473 923	→ 54	1987 470 506 <sup>8</sup>						
	0986 473 924							
312,BSR	← 54	1987 470 506 <sup>8</sup>						
	0986 473 924		→ 54					
1.9 TDI 1.9 TDI 4Motion	10.97-06.05	66/74		288	← 54	1987 470 506 <sup>8</sup>		
				0986 471 923				
				0986 471 924	→ 54			
	0986 473 924	→ 54	1987 470 506 <sup>8</sup>					
		0986 473 924						
		0986 473 071		← 54	1987 470 506 <sup>8</sup>			
0986 474 071	→ 54							
1.9 TDI 4Motion	05.99-06.05	85/96/110		228	← 54	1987 470 506 <sup>8</sup>		
				0986 473 071				
				0986 474 071	→ 54			
	288	0986 471 923	← 54	1987 470 506 <sup>8</sup>				
		0986 473 923						
		0986 471 924	→ 54					
0986 473 924								
1.9 TDI 4Motion	07.98-06.05	66/74		228	← 54	1987 470 506 <sup>8</sup>		
				0986 473 071				
				0986 474 071	→ 54			
2.0	08.98-05.04	85		228	← 54	1987 470 506 <sup>8</sup>		
				0986 473 071				
				0986 474 071	→ 54			
PR-Code 1ZF	0986 473 071	← 54	1987 470 506 <sup>8</sup>					
	0986 474 071	→ 54						
	0986 474 071	→ 54						
2.0 2.0 BiFuel	08.98-05.04	85		288	← 54	1987 470 506 <sup>8</sup>		
				0986 471 923				
				0986 473 923				
0986 471 924	→ 54	1987 470 506 <sup>8</sup>						
	0986 473 924							
	0986 473 924							
2.0 BiFuel	05.02-05.03	85		228	← 54	1987 470 506 <sup>8</sup>		
				0986 473 071				
0986 474 071	→ 54	1987 470 506 <sup>8</sup>						



	<b>S</b>							
<b>2.0i</b>	02.99-12.05	85			228,252	0 986 473 071	 ← 54	1 987 470 506 <sup>B</sup>
						0 986 474 071	 → 54	1 987 470 506 <sup>B</sup>
					288	0 986 471 923	 ← 54	1 987 470 506 <sup>B</sup>
						0 986 473 923		
						0 986 471 924	 → 54	1 987 470 506 <sup>B</sup>
						0 986 473 924		
					312,BSR	0 986 471 923	 ← 54	1 987 470 506 <sup>B</sup>
						0 986 473 923		
						0 986 471 924	 → 54	1 987 470 506 <sup>B</sup>
						0 986 473 924		
					312,BSR	0 986 473 923	 ← 54	1 987 470 506 <sup>B</sup>
						0 986 473 924	 → 54	1 987 470 506 <sup>B</sup>
<b>2.0 4Motion</b>	04.00-06.05	85			228	0 986 473 071	 ← 54	1 987 470 506 <sup>B</sup>
						0 986 474 071	 → 54	1 987 470 506 <sup>B</sup>
					288	0 986 471 923	 ← 54	1 987 470 506 <sup>B</sup>
						0 986 473 923		
						0 986 471 924	 → 54	1 987 470 506 <sup>B</sup>
						0 986 473 924		
<b>2.3</b>	10.97-02.01	110			288,312	0 986 471 923	 ← 54	1 987 470 506 <sup>B</sup>
						0 986 473 923		
						0 986 471 924	 → 54	1 987 470 506 <sup>B</sup>
						0 986 473 924		
	09.00-05.04	125	PR-Code 1ZF			0 986 473 071	 ← 54	1 987 470 506 <sup>B</sup>
						0 986 474 071	 → 54	1 987 470 506 <sup>B</sup>
<b>2.3 4Motion</b>	07.98-02.01	110				0 986 471 923	 ← 54	1 987 470 506 <sup>B</sup>
						0 986 473 923		
						0 986 471 924	 → 54	1 987 470 506 <sup>B</sup>
						0 986 473 924		
	09.00-06.05	125			288,312	0 986 471 923	 ← 54	1 987 470 506 <sup>B</sup>
						0 986 473 923		
						0 986 471 924	 → 54	1 987 470 506 <sup>B</sup>
						0 986 473 924		
<b>2.8</b>	12.98-08.02	130			288,312	0 986 471 923	 ← 54	1 987 470 506 <sup>B</sup>
						0 986 473 923		
						0 986 471 924	 → 54	1 987 470 506 <sup>B</sup>
						0 986 473 924		
<b>2.8 4Motion</b>	05.99-04.01	150				0 986 471 923	 ← 54	1 987 470 506 <sup>B</sup>
						0 986 473 923		
						0 986 471 924	 → 54	1 987 470 506 <sup>B</sup>
						0 986 473 924		
	05.01-06.05	150			288,312	0 986 471 923	 ← 54	1 987 470 506 <sup>B</sup>
						0 986 473 923		
						0 986 471 924	 → 54	1 987 470 506 <sup>B</sup>
						0 986 473 924		
						0 986 473 071	 ← 54	1 987 470 506 <sup>B</sup>
						0 986 474 071	 → 54	1 987 470 506 <sup>B</sup>
<b>3.2 4Motion R32</b>	06.02-05.04	177	PR-Code 1ZF			0 986 473 071	 ← 54	1 987 470 506 <sup>B</sup>
						0 986 474 071	 → 54	1 987 470 506 <sup>B</sup>
						0 986 473 071	 ← 54	1 987 470 506 <sup>B</sup>
						0 986 474 071	 → 54	1 987 470 506 <sup>B</sup>
								
	<b>1.4</b>	10.97-06.99	55	PR-Code 1KK, PR-Code 1KS, PR-Code 1KV	232	0 986 473 072	 ← 38	1 987 470 040 <sup>7</sup>
						0 986 473 072	 ← 38	1 987 474 496 <sup>B</sup>
						0 986 474 072	 → 38	1 987 470 040 <sup>7</sup>
		10.97-05.04	55	PR-Code 1KY	252,BSR	0 986 473 139	 ← 38,1	1 987 470 040 <sup>7</sup>
						0 986 473 139	 ← 38,1	1 987 474 496 <sup>B</sup>
						0 986 474 139	 → 38,1	1 987 470 040 <sup>7</sup>
					252,BSR	0 986 473 147	 ← 38	1 987 470 040 <sup>7</sup>
						0 986 474 147	 → 38	1 987 470 040 <sup>7</sup>
		07.99-05.04	55	PR-Code 1KK, PR-Code 1KS, PR-Code 1KV	232	0 986 473 099	← 38,1	1 987 470 040 <sup>7</sup>
						0 986 473 099	← 38,1	1 987 474 496 <sup>B</sup>
						0 986 474 099	→ 38,1	1 987 470 040 <sup>7</sup>



		S							
	◀ VW Golf IV [1J1]								
1.4	05.01-05.04	55	PR-Code 1KP, PR-Code 1KT, PR-Code 1KX	232	0986 473 029		← 41	1987 474 496 <sup>8</sup>	
					0986 474 029		→ 41	1987 474 496 <sup>8</sup>	
1.6	10.97-06.99	74	PR-Code 1KK, PR-Code 1KS, PR-Code 1KV	232	0986 473 072		← 38	1987 470 040 <sup>7</sup>	
					0986 473 072		← 38	1987 474 496 <sup>8</sup>	
					0986 474 072		→ 38	1987 470 040 <sup>7</sup>	
					0986 474 072		→ 38	1987 474 496 <sup>8</sup>	
	10.97-05.04	74	PR-Code 1KY	252,BSR	0986 473 139		← 38,1	1987 470 040 <sup>7</sup>	
					0986 473 139		← 38,1	1987 474 496 <sup>8</sup>	
					0986 474 139		→ 38,1	1987 470 040 <sup>7</sup>	
					0986 473 147		← 38	1987 470 040 <sup>7</sup>	
					0986 474 147		→ 38	1987 470 040 <sup>7</sup>	
					0986 473 147		→ 38	1987 474 496 <sup>8</sup>	
	07.99-05.04	74	PR-Code 1KK, PR-Code 1KS, PR-Code 1KV	232	0986 473 099		← 38,1	1987 470 040 <sup>7</sup>	
					0986 473 099		← 38,1	1987 474 496 <sup>8</sup>	
					0986 474 099		→ 38,1	1987 470 040 <sup>7</sup>	
	11.99-05.00	77	PR-Code 1KK, PR-Code 1KS, PR-Code 1KV	232	0986 474 099		→ 38,1	1987 470 040 <sup>7</sup>	
					0986 474 099		→ 38,1	1987 474 496 <sup>8</sup>	
	11.99-10.00	77	PR-Code 1KK, PR-Code 1KS, PR-Code 1KV	232	0986 474 099		→ 38,1	1987 474 496 <sup>8</sup>	
0986 474 099						→ 38,1	1987 470 040 <sup>7</sup>		
11.99-05.04	77	PR-Code 1KK, PR-Code 1KS, PR-Code 1KV	232	0986 473 099		← 38,1	1987 474 496 <sup>8</sup>		
				0986 473 139		← 38,1	1987 470 040 <sup>7</sup>		
				0986 473 139		← 38,1	1987 474 496 <sup>8</sup>		
				0986 474 139		→ 38,1	1987 470 040 <sup>7</sup>		
				0986 473 147		← 38	1987 470 040 <sup>7</sup>		
				0986 474 147		→ 38	1987 470 040 <sup>7</sup>		
05.00-05.04	77	PR-Code 1KK, PR-Code 1KS, PR-Code 1KV	232	0986 473 099		← 38,1	1987 470 040 <sup>7</sup>		
				0986 473 099		← 38,1	1987 474 496 <sup>8</sup>		
09.00-05.04	75	PR-Code 1KK, PR-Code 1KS, PR-Code 1KV	232	0986 473 099		← 38,1	1987 470 040 <sup>7</sup>		
				0986 473 099		← 38,1	1987 474 496 <sup>8</sup>		
				0986 474 099		→ 38,1	1987 470 040 <sup>7</sup>		
				0986 473 139		← 38,1	1987 470 040 <sup>7</sup>		
				0986 473 139		← 38,1	1987 474 496 <sup>8</sup>		
				0986 474 139		→ 38,1	1987 470 040 <sup>7</sup>		
				0986 473 147		← 38	1987 470 040 <sup>7</sup>		
				0986 474 147		→ 38	1987 470 040 <sup>7</sup>		
				0986 473 099		→ 38,1	1987 470 040 <sup>7</sup>		
				0986 474 099		→ 38,1	1987 474 496 <sup>8</sup>		
05.01-05.04	74	PR-Code 1KP, PR-Code 1KT, PR-Code 1KX	232	0986 473 029		← 41	1987 474 496 <sup>8</sup>		
				0986 474 029		→ 41	1987 474 496 <sup>8</sup>		
				0986 473 029		← 41	1987 474 496 <sup>8</sup>		
				0986 474 029		→ 41	1987 474 496 <sup>8</sup>		
				0986 473 029		← 41	1987 474 496 <sup>8</sup>		
				0986 474 029		→ 41	1987 474 496 <sup>8</sup>		
05.02-05.04	75	PR-Code 1KY	252	0986 473 139		← 38,1	1987 470 040 <sup>7</sup>		
				0986 473 139		← 38,1	1987 474 496 <sup>8</sup>		
				0986 474 139		→ 38,1	1987 470 040 <sup>7</sup>		
				0986 474 139		→ 38,1	1987 474 496 <sup>8</sup>		
1.6 FSI	08.01-05.04	81	PR-Code 1KK, PR-Code 1KS, PR-Code 1KV	232	0986 473 099		← 38,1	1987 470 040 <sup>7</sup>	
					0986 473 099		← 38,1	1987 474 496 <sup>8</sup>	
					0986 474 099		→ 38,1	1987 470 040 <sup>7</sup>	
					0986 473 029		← 41	1987 474 496 <sup>8</sup>	
					0986 474 029		→ 41	1987 474 496 <sup>8</sup>	
					0986 473 139		← 38,1	1987 470 040 <sup>7</sup>	
					0986 473 139		← 38,1	1987 474 496 <sup>8</sup>	
					0986 474 139		→ 38,1	1987 470 040 <sup>7</sup>	
					0986 473 147		← 38	1987 470 040 <sup>7</sup>	
					0986 474 147		→ 38	1987 470 040 <sup>7</sup>	
1.6 i	10.97-12.05	74	PR-Code 1KP, PR-Code 1KT, PR-Code 1KX	252,BSR	0986 473 139		← 38,1	1987 470 040 <sup>7</sup>	
					0986 473 139		← 38,1	1987 474 496 <sup>8</sup>	
					0986 474 139		→ 38,1	1987 470 040 <sup>7</sup>	
					0986 474 147		← 38	1987 470 040 <sup>7</sup>	



		S							
<b>1.6i</b>	07.99-12.05	74	Fg.-Nr. 1J-YU008 822→, 1J-YB019 462→, 1J-YW238 581→, 1J-YD128 802→, 1J-YP061 677→	232,B38	0 986 473 099		← 38,1	1 987 470 040 <sup>7</sup>	
					0 986 473 099		← 38,1	1 987 474 496 <sup>8</sup>	
					0 986 474 099		→ 38,1	1 987 470 040 <sup>7</sup>	
<b>1.8</b>	10.97-06.99	92	PR-Code 1KK, PR-Code 1KS, PR-Code 1KV	232	0 986 473 072		← 38	1 987 470 040 <sup>7</sup>	
					0 986 473 072		← 38	1 987 474 496 <sup>8</sup>	
					0 986 474 072		→ 38	1 987 470 040 <sup>7</sup>	
	10.97-10.00	92	PR-Code 1KY	252,BSR	0 986 473 139		← 38,1	1 987 470 040 <sup>7</sup>	
					0 986 473 139		← 38,1	1 987 474 496 <sup>8</sup>	
					0 986 474 139		→ 38,1	1 987 470 040 <sup>7</sup>	
				252,BSR	0 986 473 147		← 38	1 987 470 040 <sup>7</sup>	
					0 986 474 147		→ 38	1 987 470 040 <sup>7</sup>	
					0 986 473 099		← 38,1	1 987 470 040 <sup>7</sup>	
	07.99-10.00	92	PR-Code 1KK, PR-Code 1KS, PR-Code 1KV	232	0 986 473 099		← 38,1	1 987 470 040 <sup>7</sup>	
					0 986 473 099		← 38,1	1 987 474 496 <sup>8</sup>	
					0 986 474 099		→ 38,1	1 987 470 040 <sup>7</sup>	
<b>1.8i</b>	02.99-08.00	92		252,BSR	0 986 473 139		← 38,1	1 987 470 040 <sup>7</sup>	
					0 986 473 139		← 38,1	1 987 474 496 <sup>8</sup>	
					0 986 474 139		→ 38,1	1 987 470 040 <sup>7</sup>	
				252,BSR	0 986 473 147		← 38	1 987 470 040 <sup>7</sup>	
					0 986 474 147		→ 38	1 987 470 040 <sup>7</sup>	
					0 986 473 099		← 38,1	1 987 470 040 <sup>7</sup>	
	07.99-08.00	92	Fg.-Nr. 1J-YU008 822→, 1J-YB019 462→, 1J-YW238 581→, 1J-YD128 802→, 1J-YP061 677→	232,B38	0 986 473 099		← 38,1	1 987 470 040 <sup>7</sup>	
					0 986 473 099		← 38,1	1 987 474 496 <sup>8</sup>	
					0 986 474 099		→ 38,1	1 987 470 040 <sup>7</sup>	
	<b>1.8 T</b>	10.97-06.99	110	PR-Code 1KK, PR-Code 1KS, PR-Code 1KV	232	0 986 473 072		← 38	1 987 470 040 <sup>7</sup>
						0 986 473 072		← 38	1 987 474 496 <sup>8</sup>
						0 986 474 072		→ 38	1 987 470 040 <sup>7</sup>
10.97-05.03		110	PR-Code 1KY	252,BSR	0 986 473 139		← 38,1	1 987 470 040 <sup>7</sup>	
					0 986 473 139		← 38,1	1 987 474 496 <sup>8</sup>	
					0 986 474 139		→ 38,1	1 987 470 040 <sup>7</sup>	
				252,BSR	0 986 473 147		← 38	1 987 470 040 <sup>7</sup>	
					0 986 474 147		→ 38	1 987 470 040 <sup>7</sup>	
					0 986 473 139		← 38,1	1 987 470 040 <sup>7</sup>	
02.99-12.05		110		252,BSR	0 986 473 139		← 38,1	1 987 470 040 <sup>7</sup>	
					0 986 473 139		← 38,1	1 987 474 496 <sup>8</sup>	
					0 986 474 139		→ 38,1	1 987 470 040 <sup>7</sup>	
				252,BSR	0 986 473 147		← 38	1 987 470 040 <sup>7</sup>	
					0 986 474 147		→ 38	1 987 470 040 <sup>7</sup>	
					0 986 473 099		← 38,1	1 987 470 040 <sup>7</sup>	
07.99-05.03		110	PR-Code 1KK, PR-Code 1KS, PR-Code 1KV	232	0 986 473 099		← 38,1	1 987 470 040 <sup>7</sup>	
					0 986 473 099		← 38,1	1 987 474 496 <sup>8</sup>	
					0 986 474 099		→ 38,1	1 987 470 040 <sup>7</sup>	
07.99-12.05	110	Fg.-Nr. 1J-YU008 822→, 1J-YB019 462→, 1J-YW238 581→, 1J-YD128 802→, 1J-YP061 677→	232,B38	0 986 473 099		← 38,1	1 987 470 040 <sup>7</sup>		
				0 986 473 099		← 38,1	1 987 474 496 <sup>8</sup>		
				0 986 474 099		→ 38,1	1 987 470 040 <sup>7</sup>		
05.01-05.03	110	PR-Code 1KP, PR-Code 1KT, PR-Code 1KX	232	0 986 473 029		← 41	1 987 474 496 <sup>8</sup>		
				0 986 474 029		→ 41	1 987 474 496 <sup>8</sup>		
06.01-05.04	132	PR-Code 1KK, PR-Code 1KS, PR-Code 1KV	232	0 986 473 099		← 38,1	1 987 470 040 <sup>7</sup>		
				0 986 473 099		← 38,1	1 987 474 496 <sup>8</sup>		
				0 986 474 099		→ 38,1	1 987 470 040 <sup>7</sup>		
			PR-Code 1KP, PR-Code 1KT, PR-Code 1KX	232	0 986 473 029		← 41	1 987 474 496 <sup>8</sup>	
					0 986 474 029		→ 41	1 987 474 496 <sup>8</sup>	
					0 986 473 139		← 38,1	1 987 470 040 <sup>7</sup>	
			PR-Code 1KY	252,BSR	0 986 473 139		← 38,1	1 987 470 040 <sup>7</sup>	
					0 986 473 139		← 38,1	1 987 474 496 <sup>8</sup>	
					0 986 474 139		→ 38,1	1 987 470 040 <sup>7</sup>	
				252,BSR	0 986 473 147		← 38	1 987 470 040 <sup>7</sup>	
					0 986 474 147		→ 38	1 987 470 040 <sup>7</sup>	
					0 986 473 029		← 41	1 987 474 496 <sup>8</sup>	
<b>1.8 4Motion</b>	07.98-10.00	92	PR-Code 1KE, PR-Code 2EG  PR-Code 1KU, PR-Code 2EE	252	0 986 473 029		← 41	1 987 474 496 <sup>8</sup>	
					0 986 474 029		→ 41	1 987 474 496 <sup>8</sup>	
					0 986 473 139		← 38,1	1 987 470 040 <sup>7</sup>	
					0 986 473 139		← 38,1	1 987 474 496 <sup>8</sup>	
					0 986 474 139		→ 38,1	1 987 470 040 <sup>7</sup>	
					0 986 473 072		← 38	1 987 470 040 <sup>7</sup>	
<b>1.9 SDI</b>	10.97-06.99	50	PR-Code 1KK, PR-Code 1KS, PR-Code 1KV	232	0 986 473 072		← 38	1 987 470 040 <sup>7</sup>	
					0 986 473 072		← 38	1 987 474 496 <sup>8</sup>	
					0 986 474 072		→ 38	1 987 470 040 <sup>7</sup>	



		S											
◀ VW Golf IV [1J1]													
1.9 SDI	10.97-05.04	50	PR-Code 1KY	252,BSR	0986 473 139		← 38,1	1987 470 0407					
					0986 473 139		← 38,1	1987 474 4968					
					0986 474 139		→ 38,1	1987 470 0407					
					252,BSR	0986 473 147		← 38	1987 470 0407				
					0986 474 147		→ 38	1987 470 0407					
					07.99-05.04	50	PR-Code 1KK, PR-Code 1KS, PR-Code 1KV	232	0986 473 099		← 38,1	1987 470 0407	
	05.01-05.04	50	PR-Code 1KP, PR-Code 1KT, PR-Code 1KX	232	0986 473 029		← 41	1987 474 4968					
					0986 474 029		→ 41	1987 474 4968					
					1.9 TDI	10.97-06.99	66	PR-Code 1KK, PR-Code 1KS, PR-Code 1KV	232	0986 473 072		← 38	1987 470 0407
										0986 473 072		← 38	1987 474 4968
										0986 474 072		→ 38	1987 470 0407
										81	PR-Code 1KK, PR-Code 1KS, PR-Code 1KV	232	0986 473 072
0986 473 072		← 38	1987 474 4968										
0986 474 072		→ 38	1987 470 0407										
10.97-05.04	66	PR-Code 1KY	252,BSR	0986 473 139		← 38,1	1987 470 0407						
				0986 473 139		← 38,1	1987 474 4968						
				0986 474 139		→ 38,1	1987 470 0407						
				252,BSR	0986 473 147		← 38	1987 470 0407					
				0986 474 147		→ 38	1987 470 0407						
				81	PR-Code 1KY	252,BSR	0986 473 139		← 38,1	1987 470 0407			
	05.99-06.99	85	PR-Code 1KK, PR-Code 1KS, PR-Code 1KV	232	0986 473 072		← 38	1987 470 0407					
					0986 473 072		← 38	1987 474 4968					
					0986 474 072		→ 38	1987 470 0407					
					05.99-07.01	85	PR-Code 1KY	252,BSR	0986 473 139		← 38,1	1987 470 0407	
									0986 473 139		← 38,1	1987 474 4968	
									0986 474 139		→ 38,1	1987 470 0407	
252,BSR	0986 473 147		← 38	1987 470 0407									
0986 474 147		→ 38	1987 470 0407										
07.99-07.01	85	PR-Code 1KK, PR-Code 1KS, PR-Code 1KV	232	0986 473 099		← 38,1	1987 470 0407						
				0986 473 099		← 38,1	1987 474 4968						
				0986 474 099		→ 38,1	1987 470 0407						
				07.99-05.04	66	PR-Code 1KK, PR-Code 1KS, PR-Code 1KV	232	0986 473 099		← 38,1	1987 470 0407		
0986 473 099		← 38,1	1987 474 4968										
0986 474 099		→ 38,1	1987 470 0407										
81	PR-Code 1KK, PR-Code 1KS, PR-Code 1KV	232	0986 473 099			← 38,1	1987 470 0407						
			0986 473 099			← 38,1	1987 474 4968						
			0986 474 099			→ 38,1	1987 470 0407						
02.00-05.04	74	PR-Code 1KK, PR-Code 1KS, PR-Code 1KV	232	0986 473 099		← 38,1	1987 470 0407						
				0986 473 099		← 38,1	1987 474 4968						
				0986 474 099		→ 38,1	1987 470 0407						
				PR-Code 1KY	252,BSR	0986 473 139		← 38,1	1987 470 0407				
						0986 473 139		← 38,1	1987 474 4968				
						0986 474 139		→ 38,1	1987 470 0407				
	252,BSR	0986 473 147				← 38	1987 470 0407						
	0986 474 147		→ 38			1987 470 0407							
	05.00-12.05	81	PR-Code 1KY			252,BSR	0986 473 139		← 38,1	1987 470 0407			
				0986 473 139			← 38,1	1987 474 4968					
				0986 474 139			→ 38,1	1987 470 0407					
				252,BSR	0986 473 147			← 38	1987 470 0407				
0986 474 147					→ 38		1987 470 0407						
0986 474 147					→ 38		1987 470 0407						
09.00-05.04	110	PR-Code 1KK, PR-Code 1KS, PR-Code 1KV	232	0986 473 099		← 38,1	1987 470 0407						
				0986 473 099		← 38,1	1987 474 4968						
				0986 474 099		→ 38,1	1987 470 0407						
				Fg.-Nr. 1J-YU008 822→, 1J-YB019 462→, 1J-YW238 581→, 1J-YD128 802→, 1J-YP061 677→	232,B38	0986 473 099		← 38,1	1987 470 0407				
						0986 473 099		← 38,1	1987 474 4968				
						0986 474 099		→ 38,1	1987 470 0407				
PR-Code 1KK, PR-Code 1KS, PR-Code 1KV	232	0986 473 099		← 38,1	1987 470 0407								
		0986 473 099		← 38,1	1987 474 4968								
		0986 474 099		→ 38,1	1987 470 0407								













		S												
<b>1.9 TDI</b>	09.00-05.04	110	PR-Code 1KY	252,BSR	0 986 473 139	← 38,1	1 987 470 040 <sup>7</sup>							
					0 986 473 139	← 38,1	1 987 474 496 <sup>8</sup>							
					0 986 474 139	→ 38,1	1 987 470 040 <sup>7</sup>							
					252,BSR	0 986 473 147	← 38	1 987 470 040 <sup>7</sup>						
					0 986 474 147	→ 38	1 987 470 040 <sup>7</sup>							
					04.01-05.04	96	PR-Code 1KK, PR-Code 1KS, PR-Code 1KV	232	0 986 473 099	← 38,1	1 987 470 040 <sup>7</sup>			
	0 986 473 099	← 38,1	1 987 474 496 <sup>8</sup>											
	0 986 474 099	→ 38,1	1 987 470 040 <sup>7</sup>											
	PR-Code 1KY	252,BSR	0 986 473 139	← 38,1	1 987 470 040 <sup>7</sup>									
	0 986 473 139	← 38,1	1 987 474 496 <sup>8</sup>											
	0 986 474 139	→ 38,1	1 987 470 040 <sup>7</sup>											
					252,BSR	0 986 473 147	← 38	1 987 470 040 <sup>7</sup>						
						0 986 474 147	→ 38	1 987 470 040 <sup>7</sup>						
	05.01-07.01	85	PR-Code 1KP, PR-Code 1KT, PR-Code 1KX	232	0 986 473 029	← 41	1 987 474 496 <sup>8</sup>							
					0 986 474 029	→ 41	1 987 474 496 <sup>8</sup>							
	05.01-05.04	66	PR-Code 1KP, PR-Code 1KT, PR-Code 1KX	232	0 986 473 029	← 41	1 987 474 496 <sup>8</sup>							
								0 986 474 029	→ 41	1 987 474 496 <sup>8</sup>				
					74	PR-Code 1KP, PR-Code 1KT, PR-Code 1KX	232	0 986 473 029	← 41	1 987 474 496 <sup>8</sup>				
								0 986 474 029	→ 41	1 987 474 496 <sup>8</sup>				
					81	PR-Code 1KP, PR-Code 1KT, PR-Code 1KX	232	0 986 473 029	← 41	1 987 474 496 <sup>8</sup>				
							0 986 474 029	→ 41	1 987 474 496 <sup>8</sup>					
	96	PR-Code 1KP, PR-Code 1KT, PR-Code 1KX	232	0 986 473 029	← 41	1 987 474 496 <sup>8</sup>								
				0 986 474 029	→ 41	1 987 474 496 <sup>8</sup>								
	110	PR-Code 1KP, PR-Code 1KT, PR-Code 1KX	232	0 986 473 029	← 41	1 987 474 496 <sup>8</sup>								
				0 986 474 029	→ 41	1 987 474 496 <sup>8</sup>								
<b>1.9 TDI 4Motion</b>	07.98-04.02	66	PR-Code 1KE, PR-Code 2EG	252	0 986 473 029	← 41	1 987 474 496 <sup>8</sup>							
					0 986 474 029	→ 41	1 987 474 496 <sup>8</sup>							
					PR-Code 1KU, PR-Code 2EE	252	0 986 473 139	← 38,1	1 987 470 040 <sup>7</sup>					
							0 986 473 139	← 38,1	1 987 474 496 <sup>8</sup>					
							0 986 474 139	→ 38,1	1 987 470 040 <sup>7</sup>					
					05.99-07.01	85	PR-Code 1KE, PR-Code 2EG	252	0 986 473 029	← 41	1 987 474 496 <sup>8</sup>			
					0 986 474 029				→ 41	1 987 474 496 <sup>8</sup>				
			PR-Code 1KU, PR-Code 2EE	252	0 986 473 139				← 38,1	1 987 470 040 <sup>7</sup>				
					0 986 473 139				← 38,1	1 987 474 496 <sup>8</sup>				
					0 986 474 139				→ 38,1	1 987 470 040 <sup>7</sup>				
			PR-Code 1KE, PR-Code 2EG	252	0 986 473 029				← 41	1 987 474 496 <sup>8</sup>				
					0 986 474 029	→ 41	1 987 474 496 <sup>8</sup>							
		02.00-06.05	74	PR-Code 1KE, PR-Code 2EG	252	0 986 473 139	← 38,1	1 987 470 040 <sup>7</sup>						
								0 986 473 139	← 38,1	1 987 474 496 <sup>8</sup>				
								0 986 474 139	→ 38,1	1 987 470 040 <sup>7</sup>				
						PR-Code 1KE, PR-Code 2EG	252	0 986 473 029	← 41	1 987 474 496 <sup>8</sup>				
								0 986 474 029	→ 41	1 987 474 496 <sup>8</sup>				
						PR-Code 1KU, PR-Code 2EE	252	0 986 473 139	← 38,1	1 987 470 040 <sup>7</sup>				
				0 986 473 139	← 38,1	1 987 474 496 <sup>8</sup>								
				0 986 474 139	→ 38,1	1 987 470 040 <sup>7</sup>								
	09.00-06.05	110	PR-Code 1KE, PR-Code 2EG	252	0 986 473 029	← 41	1 987 474 496 <sup>8</sup>							
							0 986 474 029	→ 41	1 987 474 496 <sup>8</sup>					
					PR-Code 1KU, PR-Code 2EE	252	0 986 473 139	← 38,1	1 987 470 040 <sup>7</sup>					
							0 986 473 139	← 38,1	1 987 474 496 <sup>8</sup>					
							0 986 474 139	→ 38,1	1 987 470 040 <sup>7</sup>					
							0 986 473 029	← 41	1 987 474 496 <sup>8</sup>					
				0 986 474 029	→ 41	1 987 474 496 <sup>8</sup>								
<b>2.0</b>	08.98-06.99	85	PR-Code 1KK, PR-Code 1KS, PR-Code 1KV	232	0 986 473 072	← 38	1 987 470 040 <sup>7</sup>							
					0 986 473 072	← 38	1 987 474 496 <sup>8</sup>							
					0 986 474 072	→ 38	1 987 470 040 <sup>7</sup>							
					08.98-05.04	85	PR-Code 1KY	252	0 986 473 139	← 38,1	1 987 470 040 <sup>7</sup>			
												0 986 473 139	← 38,1	1 987 474 496 <sup>8</sup>
												0 986 474 139	→ 38,1	1 987 470 040 <sup>7</sup>
					252,BSR				0 986 473 139	← 38,1	1 987 470 040 <sup>7</sup>			
					0 986 473 139				← 38,1	1 987 474 496 <sup>8</sup>				
					0 986 474 139				→ 38,1	1 987 470 040 <sup>7</sup>				
		07.99-05.04	85	PR-Code 1KK, PR-Code 1KS, PR-Code 1KV	232	0 986 473 099	← 38,1	1 987 470 040 <sup>7</sup>						
								0 986 474 099	→ 38,1	1 987 470 040 <sup>7</sup>				
	<b>2.0 BiFuel</b>	07.99-05.04				85	PR-Code 1KK, PR-Code 1KS, PR-Code 1KV	232	0 986 473 099	← 38,1	1 987 474 496 <sup>8</sup>			
0 986 474 099									→ 41	1 987 474 496 <sup>8</sup>				
<b>2.0 BiFuel</b>	05.01-05.04	85				PR-Code 1KP, PR-Code 1KT, PR-Code 1KX	232	0 986 473 029	← 41	1 987 474 496 <sup>8</sup>				
								0 986 474 029	→ 41	1 987 474 496 <sup>8</sup>				
<b>2.0 BiFuel</b>	05.02-05.03	85	PR-Code 1KK, PR-Code 1KS, PR-Code 1KV	232	0 986 473 099	← 38,1	1 987 470 040 <sup>7</sup>							
					0 986 474 099	→ 38,1	1 987 474 496 <sup>8</sup>							



		S							
	◀ VW Golf IV [1J1]								
2.0 BiFuel	05.02-05.03	85	PR-Code 1KY	252,BSR	0986 473 139		38,1	1987 470 040 <sup>7</sup>	
					0986 473 139		38,1	1987 474 496 <sup>8</sup>	
					0986 474 139		38,1	1987 470 040 <sup>7</sup>	
2.0 i	02.99-12.05	85		252,BSR	0986 473 139		38,1	1987 470 040 <sup>7</sup>	
					0986 473 139		38,1	1987 474 496 <sup>8</sup>	
					0986 474 139		38,1	1987 470 040 <sup>7</sup>	
	07.99-12.05	85	Fg.-Nr. 1J-YU008 822→, 1J-YB019 462→, 1J-YW238 581→, 1J-YD128 802→, 1J-YP061 677→	232,B38	0986 473 147		38	1987 470 040 <sup>7</sup>	
					0986 474 147		38	1987 470 040 <sup>7</sup>	
					0986 473 099		38,1	1987 470 040 <sup>7</sup>	
2.0 4Motion	04.00-06.05	85	PR-Code 1KE, PR-Code 2EG	252	0986 473 029		41	1987 474 496 <sup>8</sup>	
					0986 474 029		41	1987 474 496 <sup>8</sup>	
					0986 473 139		38,1	1987 470 040 <sup>7</sup>	
	10.97-06.99	110	PR-Code 1KK, PR-Code 1KS, PR-Code 1KV	232	0986 473 139		38,1	1987 474 496 <sup>8</sup>	
					0986 473 072		38	1987 470 040 <sup>7</sup>	
					0986 474 072		38	1987 470 040 <sup>7</sup>	
2.3	10.97-02.01	110	PR-Code 1KY	252,BSR	0986 473 139		38,1	1987 470 040 <sup>7</sup>	
					0986 473 139		38,1	1987 474 496 <sup>8</sup>	
					0986 474 139		38,1	1987 470 040 <sup>7</sup>	
	07.99-02.01	110	PR-Code 1KK, PR-Code 1KS, PR-Code 1KV	232	0986 473 099		38,1	1987 470 040 <sup>7</sup>	
					0986 473 099		38,1	1987 474 496 <sup>8</sup>	
					0986 474 099		38,1	1987 470 040 <sup>7</sup>	
2.3 4Motion	09.00-05.04	125	PR-Code 1KK, PR-Code 1KS, PR-Code 1KV	232	0986 473 099		38,1	1987 470 040 <sup>7</sup>	
					0986 473 099		38,1	1987 474 496 <sup>8</sup>	
					0986 474 099		38,1	1987 470 040 <sup>7</sup>	
	05.01-05.04	125	PR-Code 1KP, PR-Code 1KT, PR-Code 1KX	232	0986 473 139		38,1	1987 470 040 <sup>7</sup>	
					0986 473 139		38,1	1987 474 496 <sup>8</sup>	
					0986 474 139		38,1	1987 470 040 <sup>7</sup>	
2.3 4Motion	07.98-02.01	110	PR-Code 1KE, PR-Code 2EG	252	0986 473 029		41	1987 474 496 <sup>8</sup>	
					0986 474 029		41	1987 474 496 <sup>8</sup>	
					0986 473 139		38,1	1987 470 040 <sup>7</sup>	
	09.00-06.05	125	PR-Code 1KE, PR-Code 2EG	252	0986 473 139		38,1	1987 474 496 <sup>8</sup>	
					0986 474 139		38,1	1987 470 040 <sup>7</sup>	
					0986 473 029		41	1987 474 496 <sup>8</sup>	
2.8 4Motion	05.99-04.01	150	PR-Code 1KE, PR-Code 2EG	232	0986 473 029		41	1987 474 496 <sup>8</sup>	
					0986 474 029		41	1987 474 496 <sup>8</sup>	
					0986 473 139		38,1	1987 470 040 <sup>7</sup>	
	05.99-06.05	150	PR-Code 1KE, PR-Code 2EG	232	0986 473 139		38,1	1987 474 496 <sup>8</sup>	
					0986 474 139		38,1	1987 470 040 <sup>7</sup>	
					0986 473 029		41	1987 474 496 <sup>8</sup>	
3.2 4Motion R32	06.02-05.04	177	PR-Code 1KE, PR-Code 2EG	252	0986 473 029		41	1987 474 496 <sup>8</sup>	
					0986 474 029		41	1987 474 496 <sup>8</sup>	
					0986 473 139		38,1	1987 470 040 <sup>7</sup>	
	10.03-05.04	177	PR-Code 2EL	252	0986 473 139		38,1	1987 474 496 <sup>8</sup>	
					0986 474 139		38,1	1987 470 040 <sup>7</sup>	
					0986 473 029		41	1987 474 496 <sup>8</sup>	



		<b>S</b>							
									
	<b>1.4</b>	10.97-06.99	55				1 987 477 696	↔ 1688	
		07.99-05.04	55				1 987 477 698	↔ 1693	
	<b>1.6</b>	10.97-06.99	74				1 987 477 696	↔ 1688	
		07.99-05.04	74				1 987 477 698	↔ 1693	
		11.99-05.04	75/77/81				1 987 477 698	↔ 1693	
	<b>1.6 FSI</b>	08.01-05.04	75/77/81				1 987 477 698	↔ 1693	
	<b>1.6 i</b>	10.97-06.99	74	Fg.-Nr. →1J..YU..008 822, 232 →1J..YB..019 462, →1J..YW..238 580, →1J..YD..128 801, →1J..YP..061 677			1 987 477 696	↔ 1688	
		10.97-12.05	74		252		1 987 477 698	↔ 1693	
		07.99-12.05	74	Fg.-Nr. 1J..YU..008 822→, 232 1J..YB..019 462→, 1J..YW..238 581→, 1J..YD..128 802→, 1J..YP..061 678→			1 987 477 698	↔ 1693	
	<b>1.8</b>	10.97-06.99	92				1 987 477 696	↔ 1688	
		07.99-10.00	92				1 987 477 698	↔ 1693	
	<b>1.8 i</b>	02.99-06.99	92	Fg.-Nr. →1J..YU..008 822, 232 →1J..YB..019 462, →1J..YW..238 580, →1J..YD..128 801, →1J..YP..061 677			1 987 477 696	↔ 1688	
		02.99-08.00	92		252		1 987 477 698	↔ 1693	
		07.99-08.00	92	Fg.-Nr. 1J..YU..008 822→, 232 1J..YB..019 462→, 1J..YW..238 581→, 1J..YD..128 802→, 1J..YP..061 678→			1 987 477 698	↔ 1693	
	<b>1.8 T</b>	10.97-06.99	110				1 987 477 696	↔ 1688	
		02.99-06.99	110	Fg.-Nr. →1J..YU..008 822, 232 →1J..YB..019 462, →1J..YW..238 580, →1J..YD..128 801, →1J..YP..061 677			1 987 477 696	↔ 1688	
		02.99-12.05	110		252		1 987 477 698	↔ 1693	
		07.99-05.03	110				1 987 477 698	↔ 1693	
		07.99-12.05	110	Fg.-Nr. 1J..YU..008 822→, 232 1J..YB..019 462→, 1J..YW..238 581→, 1J..YD..128 802→, 1J..YP..061 678→			1 987 477 698	↔ 1693	
		06.01-05.04	132				1 987 477 698	↔ 1693	
	<b>1.8 4Motion</b>	07.98-10.00	92				1 987 477 686	↔ 1723	
	<b>1.9 SDI</b>	10.97-06.99	50				1 987 477 696	↔ 1688	
		07.99-05.04	50				1 987 477 698	↔ 1693	
	<b>1.9 TDI</b>	10.97-06.99	66				1 987 477 696	↔ 1688	
			81				1 987 477 696	↔ 1688	
		05.99-06.99	85				1 987 477 696	↔ 1688	
		07.99-07.01	85				1 987 477 698	↔ 1693	
		07.99-05.04	66				1 987 477 698	↔ 1693	
		07.99-12.05	81				1 987 477 698	↔ 1693	
		02.00-05.04	74				1 987 477 698	↔ 1693	
		09.00-05.04	110				1 987 477 698	↔ 1693	
		04.01-05.04	96				1 987 477 698	↔ 1693	
	<b>1.9 TDI 4Motion</b>	07.98-04.02	66				1 987 477 686	↔ 1723	
		05.99-07.01	85				1 987 477 686	↔ 1723	
		02.00-06.05	74				1 987 477 686	↔ 1723	
		09.00-06.05	110				1 987 477 686	↔ 1723	
	<b>2.0</b>	08.98-06.99	85				1 987 477 696	↔ 1688	
		07.99-05.04	85				1 987 477 698	↔ 1693	
	<b>2.0 BiFuel</b>	05.02-05.03	85				1 987 477 698	↔ 1693	
	<b>2.0 i</b>	02.99-06.99	85	Fg.-Nr. →1J..YU..008 822, 232 →1J..YB..019 462, →1J..YW..238 580, →1J..YD..128 801, →1J..YP..061 677			1 987 477 696	↔ 1688	
		02.99-12.05	85		252		1 987 477 698	↔ 1693	
		07.99-12.05	85	Fg.-Nr. 1J..YU..008 822→, 232 1J..YB..019 462→, 1J..YW..238 581→, 1J..YD..128 802→, 1J..YP..061 678→			1 987 477 698	↔ 1693	
	<b>2.0 4Motion</b>	04.00-06.05	85				1 987 477 686	↔ 1723	



		S							
<b>◀ VW Golf IV [1J1]</b>									
<b>2.3</b>	10.97-06.99	110					1987 477 696	↔ 1688	
	07.99-02.01	110					1987 477 698	↔ 1693	
	09.00-05.04	125					1987 477 698	↔ 1693	
<b>2.3 4Motion</b>	07.98-02.01	110					1987 477 686	↔ 1723	
	09.00-06.05	125					1987 477 686	↔ 1723	
<b>2.8</b>	12.98-06.99	130			Fg.-Nr. →1J..YW238 580, →1J..YD128 801, →1J..YP061 677, →1J..YU008 822, →1J..YB019 361		1987 477 696	↔ 1688	
	07.99-08.02	130			Fg.-Nr. 1J..YW238 581→, 1J..YD128 802→, 1J..YP061 678→, 1J..YU008 823→, 1J..YB019 362→		1987 477 698	↔ 1693	
<b>2.8 4Motion</b>	05.99-06.05	150					1987 477 686	↔ 1723	
<b>3.2 4Motion R32</b>	06.02-05.04	177					1987 477 686	↔ 1723	
	<b>1.4</b>	10.97-05.04	55				0986 594 004 <sup>4</sup>		
						LAB	0986 594 001 <sup>3</sup>		
						RAB	0986 594 000 <sup>3</sup>		
<b>1.6</b>	10.97-12.05	74/75/77/					0986 594 004 <sup>4</sup>		
		81			LAB	0986 594 001 <sup>3</sup>			
<b>1.6 i</b>						RAB	0986 594 000 <sup>3</sup>		
<b>1.8, i</b>	10.97-10.00	92					0986 594 004 <sup>4</sup>		
<b>1.8, i, 4Motion</b>	10.97-10.00	92				LAB	0986 594 001 <sup>3</sup>		
					RAB	0986 594 000 <sup>3</sup>			
<b>1.8 T</b>	10.97-12.05	110/132					0986 594 004 <sup>4</sup>		
					LAB	0986 594 001 <sup>3</sup>			
						RAB	0986 594 000 <sup>3</sup>		
<b>1.8 4Motion</b>	07.98-10.00	92					0986 594 008 <sup>4</sup>		
<b>1.9 SDI</b>	10.97-05.04	50					0986 594 004 <sup>4</sup>		
					LAB	0986 594 001 <sup>3</sup>			
						RAB	0986 594 000 <sup>3</sup>		
<b>1.9 TDI</b>	10.97-05.04	66/74					0986 594 004 <sup>4</sup>		
			10.97-12.05	81				0986 594 004 <sup>4</sup>	
						LAB	0986 594 001 <sup>3</sup>		
						RAB	0986 594 000 <sup>3</sup>		
	05.99-07.01	85					0986 594 004 <sup>4</sup>		
	09.00-05.04	110					0986 594 004 <sup>4</sup>		
	04.01-05.04	96					0986 594 004 <sup>4</sup>		
						LAB	0986 594 001 <sup>3</sup>		
						RAB	0986 594 000 <sup>3</sup>		
<b>1.9 TDI</b>	10.97-06.05	66/74				LAB	0986 594 001 <sup>3</sup>		
<b>1.9 TDI 4Motion</b>	05.99-07.01	85				LAB	0986 594 001 <sup>3</sup>		
					RAB	0986 594 000 <sup>3</sup>			
	09.00-06.05	110				LAB	0986 594 001 <sup>3</sup>		
						RAB	0986 594 000 <sup>3</sup>		
<b>1.9 TDI 4Motion</b>	07.98-06.05	66/74					0986 594 008 <sup>4</sup>		
	05.99-07.01	85					0986 594 008 <sup>4</sup>		
	09.00-06.05	110					0986 594 008 <sup>4</sup>		
<b>2.0, BiFuel, i</b>	08.98-12.05	85					0986 594 004 <sup>4</sup>		
<b>2.0, BiFuel, i, 4Motion</b>	08.98-12.05	85				LAB	0986 594 001 <sup>3</sup>		
					RAB	0986 594 000 <sup>3</sup>			
<b>2.0 4Motion</b>	04.00-06.05	85					0986 594 008 <sup>4</sup>		
<b>2.3</b>	10.97-05.04	110/125					0986 594 004 <sup>4</sup>		
					LAB	0986 594 001 <sup>3</sup>			
<b>2.3 4Motion</b>						RAB	0986 594 000 <sup>3</sup>		
<b>2.3 4Motion</b>	07.98-06.05	110/125					0986 594 008 <sup>4</sup>		
<b>2.8 4Motion</b>	05.99-06.05	150					0986 594 008 <sup>4</sup>		
					LAB	0986 594 001 <sup>3</sup>			
						RAB	0986 594 000 <sup>3</sup>		
<b>3.2 4Motion R32</b>	06.02-05.04	177					0986 594 008 <sup>4</sup>		
					LAB	0986 594 001 <sup>3</sup>			
					RAB	0986 594 000 <sup>3</sup>			



		S							
<b>Golf IV [9B1]</b>									
	1.6	08.99-06.01	74		228,252		0 986 473 071	← 54	1 987 470 506 <sup>B</sup>
							0 986 474 071	→ 54	1 987 470 506 <sup>B</sup>
	1.8 GTI Turbo	08.99-03.07	110/132				0 986 471 923	← 54	1 987 470 506 <sup>B</sup>
							0 986 473 923		
							0 986 471 924	→ 54	1 987 470 506 <sup>B</sup>
							0 986 473 924		
	2.0	08.99-06.02	85						1 987 470 506 <sup>B</sup>
	1.6	08.99-06.01	74				0 986 473 099	← 38,1	1 987 470 040 <sup>7</sup>
							0 986 473 099	← 38,1	1 987 474 496 <sup>B</sup>
							0 986 474 099	→ 38,1	1 987 470 040 <sup>7</sup>
	1.8 GTI Turbo	08.99-03.07	110/132				0 986 473 099	← 38,1	1 987 470 040 <sup>7</sup>
							0 986 473 099	← 38,1	1 987 474 496 <sup>B</sup>
							0 986 474 099	→ 38,1	1 987 470 040 <sup>7</sup>
	2.0	08.99-03.07	85				0 986 473 099	← 38,1	1 987 470 040 <sup>7</sup>
							0 986 473 099	← 38,1	1 987 474 496 <sup>B</sup>
							0 986 474 099	→ 38,1	1 987 470 040 <sup>7</sup>
	1.6	08.99-06.01	74				1 987 477 698	↔ 1693	
	1.8 GTI Turbo	08.99-03.07	110/132				1 987 477 698	↔ 1693	
	2.0	08.99-03.07	85				1 987 477 698	↔ 1693	
	1.6	08.99-06.01	74				0 986 594 004 <sup>4</sup>		
						LAB	0 986 594 001 <sup>3</sup>		
						RAB	0 986 594 000 <sup>3</sup>		
	1.8 GTI Turbo	08.99-03.07	110/132				0 986 594 004 <sup>4</sup>		
						LAB	0 986 594 001 <sup>3</sup>		
						RAB	0 986 594 000 <sup>3</sup>		
	2.0	08.99-06.02	85				0 986 594 004 <sup>3</sup>		
		08.99-03.07	85				0 986 594 004 <sup>4</sup>		
						LAB	0 986 594 001 <sup>3</sup>		
						RAB	0 986 594 000 <sup>3</sup>		
<b>Golf Plus [5M1]</b>									
	1.4	01.05-12.08	55/59/66/	PR-Code 1ZE, PR-Code 1LJ,	288,312		0 986 473 384	← 53,94	F 026 A06 106 <sup>7</sup>
	1.4 FSI		90/103/	PR-Code 1ZP			0 986 473 384	← 53,94	1 987 470 506 <sup>B</sup>
	1.4 TSI		118/125				0 986 474 384	→ 53,94	F 026 A06 106 <sup>7</sup>
				PR-Code 1ZM, PR-Code 1ZF	228		0 986 473 071	← 54	1 987 470 506 <sup>B</sup>
							0 986 474 071	→ 54	1 987 470 506 <sup>B</sup>
	1.6	01.05-01.09	75/85	PR-Code 1ZE, PR-Code 1LJ,	288,312		0 986 473 384	← 53,94	F 026 A06 106 <sup>7</sup>
	1.6 FSI			PR-Code 1ZP			0 986 473 384	← 53,94	1 987 470 506 <sup>B</sup>
	1.6 MultiFuel						0 986 474 384	→ 53,94	F 026 A06 106 <sup>7</sup>
				PR-Code 1ZM, PR-Code 1ZF	228		0 986 473 071	← 54	1 987 470 506 <sup>B</sup>
							0 986 474 071	→ 54	1 987 470 506 <sup>B</sup>
	1.9 TDI	01.05-01.09	66/77	PR-Code 1ZE, PR-Code 1LJ,	288,312		0 986 473 384	← 53,94	F 026 A06 106 <sup>7</sup>
				PR-Code 1ZP			0 986 473 384	← 53,94	1 987 470 506 <sup>B</sup>
							0 986 474 384	→ 53,94	F 026 A06 106 <sup>7</sup>
				PR-Code 1ZM, PR-Code 1ZF	228		0 986 473 071	← 54	1 987 470 506 <sup>B</sup>
							0 986 474 071	→ 54	1 987 470 506 <sup>B</sup>
	2.0 FSI	05.05-05.08	110	PR-Code 1ZE, PR-Code 1LJ,	288,312		0 986 474 384	→ 53,94	1 987 470 506 <sup>B</sup>
				PR-Code 1ZP					
		05.05-06.08	110	PR-Code 1ZE, PR-Code 1LJ,	288,312		0 986 473 384	← 53,94	F 026 A06 106 <sup>7</sup>
				PR-Code 1ZP			0 986 473 384	← 53,94	1 987 470 506 <sup>B</sup>
							0 986 474 384	→ 53,94	F 026 A06 106 <sup>7</sup>













<b>◀ VW Golf Plus [5M1]</b>									
<b>2.0 FSI</b>	05.05-06.08	110	PR-Code 1ZM, PR-Code 1ZF	228	0986 473 071		← 54	1987 470 506 <sup>8</sup>	
					0986 474 071		→ 54	1987 470 506 <sup>8</sup>	
<b>2.0 TDI</b>	01.05-05.09	96/100/ 103	PR-Code 1ZE, PR-Code 1LJ, PR-Code 1ZP	288,312	0986 473 384		← 53,94	F026 A06 106 <sup>7</sup>	
					0986 473 384		← 53,94	1987 470 506 <sup>8</sup>	
					0986 474 384		→ 53,94	F026 A06 106 <sup>7</sup>	
					0986 473 071		← 54	1987 470 506 <sup>8</sup>	
					0986 474 071		→ 54	1987 470 506 <sup>8</sup>	
<b>1.4</b>	01.05-05.06	55	PR-Code 1KD	D53	0986 473 381		← 38,1	1987 470 040 <sup>7</sup>	
					0986 473 381		← 38,1	1987 474 496 <sup>8</sup>	
<b>1.4 FSI</b>	05.06-04.07	59	PR-Code 1KE	256	0986 474 381		→ 38,1	1987 470 040 <sup>7</sup>	
					0986 473 448		← 41	1987 474 496 <sup>8</sup>	
					0986 474 448		→ 41	1987 474 496 <sup>8</sup>	
					PR-Code 1KZ	0986 134 048		← 38	1987 474 496 <sup>8</sup>
					0986 135 244		→	1987 474 496 <sup>8</sup>	
					PR-Code 1KZ	0986 135 244		→	1987 474 496 <sup>8</sup>
					PR-Code 1KD	0986 473 381		← 38,1	1987 470 040 <sup>7</sup>
					0986 473 381		← 38,1	1987 474 496 <sup>8</sup>	
					0986 474 381		→ 38,1	1987 470 040 <sup>7</sup>	
					PR-Code 1KE	0986 473 448		← 41	1987 474 496 <sup>8</sup>
0986 474 448		→ 41	1987 474 496 <sup>8</sup>						
PR-Code 1KZ	0986 134 048		← 38	1987 474 496 <sup>8</sup>					
PR-Code 1KZ	0986 135 048		→ 38	1987 474 496 <sup>8</sup>					
<b>1.4 TSI</b>	07.05-05.06	66	PR-Code 1KD	D53	0986 473 381		← 38,1	1987 470 040 <sup>7</sup>	
					0986 473 381		← 38,1	1987 474 496 <sup>8</sup>	
					0986 474 381		→ 38,1	1987 470 040 <sup>7</sup>	
					PR-Code 1KE	0986 473 448		← 41	1987 474 496 <sup>8</sup>
					0986 474 448		→ 41	1987 474 496 <sup>8</sup>	
					PR-Code 1KZ	0986 134 048		← 38	1987 474 496 <sup>8</sup>
					0986 135 244		→	1987 474 496 <sup>8</sup>	
					PR-Code 1KZ	0986 135 244		→	1987 474 496 <sup>8</sup>
					PR-Code 1KD	0986 473 381		← 38,1	1987 470 040 <sup>7</sup>
					0986 473 381		← 38,1	1987 474 496 <sup>8</sup>	
0986 474 381		→ 38,1	1987 470 040 <sup>7</sup>						
PR-Code 1KE	0986 473 448		← 41	1987 474 496 <sup>8</sup>					
0986 474 448		→ 41	1987 474 496 <sup>8</sup>						
PR-Code 1KZ	0986 134 048		← 38	1987 474 496 <sup>8</sup>					
PR-Code 1KD	0986 473 381		← 38,1	1987 470 040 <sup>7</sup>					
0986 473 381		← 38,1	1987 474 496 <sup>8</sup>						
0986 474 381		→ 38,1	1987 470 040 <sup>7</sup>						
PR-Code 1KE	0986 473 448		← 41	1987 474 496 <sup>8</sup>					
0986 474 448		→ 41	1987 474 496 <sup>8</sup>						
PR-Code 1KZ	0986 134 048		← 38	1987 474 496 <sup>8</sup>					
PR-Code 1KZ	0986 135 048		→ 38	1987 474 496 <sup>8</sup>					
PR-Code 1KZ	0986 135 048		→ 38	1987 474 496 <sup>8</sup>					
<b>1.4 TSI</b>	07.07-12.08	90	PR-Code 1KD	D53	0986 473 381		← 38,1	1987 470 040 <sup>7</sup>	
					0986 473 381		← 38,1	1987 474 496 <sup>8</sup>	
					0986 474 381		→ 38,1	1987 470 040 <sup>7</sup>	
					PR-Code 1KE	0986 473 448		← 41	1987 474 496 <sup>8</sup>
					0986 474 448		→ 41	1987 474 496 <sup>8</sup>	
					PR-Code 1KZ	0986 134 048		← 38	1987 474 496 <sup>8</sup>
					0986 135 048		→ 38	1987 474 496 <sup>8</sup>	
					PR-Code 1KD	0986 473 381		← 38,1	1987 470 040 <sup>7</sup>
					0986 473 381		← 38,1	1987 474 496 <sup>8</sup>	
					0986 474 381		→ 38,1	1987 470 040 <sup>7</sup>	
PR-Code 1KE	0986 473 448		← 41	1987 474 496 <sup>8</sup>					
0986 474 448		→ 41	1987 474 496 <sup>8</sup>						
PR-Code 1KZ	0986 134 048		← 38	1987 474 496 <sup>8</sup>					
PR-Code 1KZ	0986 135 048		→ 38	1987 474 496 <sup>8</sup>					
<b>1.4 TSI</b>	05.08-12.08	118	PR-Code 1KD	D53	0986 473 381		← 38,1	1987 470 040 <sup>7</sup>	
					0986 473 381		← 38,1	1987 474 496 <sup>8</sup>	
					0986 474 381		→ 38,1	1987 470 040 <sup>7</sup>	
					PR-Code 1KE	0986 473 448		← 41	1987 474 496 <sup>8</sup>
					0986 474 448		→ 41	1987 474 496 <sup>8</sup>	
					PR-Code 1KZ	0986 134 048		← 38	1987 474 496 <sup>8</sup>
					0986 135 048		→ 38	1987 474 496 <sup>8</sup>	
					PR-Code 1KD	0986 473 381		← 38,1	1987 470 040 <sup>7</sup>
					0986 473 381		← 38,1	1987 474 496 <sup>8</sup>	
					0986 474 381		→ 38,1	1987 470 040 <sup>7</sup>	
PR-Code 1KE	0986 473 448		← 41	1987 474 496 <sup>8</sup>					
0986 474 448		→ 41	1987 474 496 <sup>8</sup>						
PR-Code 1KZ	0986 134 048		← 38	1987 474 496 <sup>8</sup>					
0986 135 048		→ 38	1987 474 496 <sup>8</sup>						

		<b>S</b>									
<b>1.6</b>	05.05-04.07	75	PR-Code 1KZ				0 986 135 244		1 987 474 496 <sup>B</sup>		
	05.05-12.08	75	PR-Code 1KD	D53			0 986 473 381		38,1	1 987 470 040 <sup>7</sup>	
							0 986 473 381		38,1	1 987 474 496 <sup>B</sup>	
							0 986 474 381		38,1	1 987 470 040 <sup>7</sup>	
			PR-Code 1KZ				0 986 134 048		38	1 987 474 496 <sup>B</sup>	
<b>1.6</b>	05.05-12.08	75	PR-Code 1KE	256			0 986 473 448		41	1 987 474 496 <sup>B</sup>	
							0 986 474 448		41	1 987 474 496 <sup>B</sup>	
<b>1.6 MultiFuel</b>	05.07-12.08	75	PR-Code 1KZ				0 986 135 048		38	1 987 474 496 <sup>B</sup>	
<b>1.6 FSI</b>	01.05-04.07	85	PR-Code 1KZ				0 986 135 244			1 987 474 496 <sup>B</sup>	
							01.05-01.09	85	PR-Code 1KD	D53	
								0 986 473 381		38,1	1 987 474 496 <sup>B</sup>
				PR-Code 1KE	256			0 986 473 448		41	1 987 474 496 <sup>B</sup>
							0 986 474 448		41	1 987 474 496 <sup>B</sup>	
			PR-Code 1KZ				0 986 134 048		38	1 987 474 496 <sup>B</sup>	
<b>1.6 MultiFuel</b>	05.07-01.09	85	PR-Code 1KZ				0 986 135 048		38	1 987 474 496 <sup>B</sup>	
	11.07-12.08	75	PR-Code 1KD	D53			0 986 473 381		38,1	1 987 474 496 <sup>B</sup>	
							0 986 474 381		38,1	1 987 470 040 <sup>7</sup>	
							0 986 474 381		38,1	1 987 474 496 <sup>B</sup>	
			PR-Code 1KZ				0 986 134 048		38	1 987 474 496 <sup>B</sup>	
<b>1.9 TDI</b>	01.05-04.07	77	PR-Code 1KZ				0 986 135 244			1 987 474 496 <sup>B</sup>	
							01.05-01.09	77	PR-Code 1KD	D53	
								0 986 473 381		38,1	1 987 474 496 <sup>B</sup>
				PR-Code 1KE	256			0 986 473 448		41	1 987 474 496 <sup>B</sup>
							0 986 474 448		41	1 987 474 496 <sup>B</sup>	
			PR-Code 1KZ				0 986 134 048		38	1 987 474 496 <sup>B</sup>	
	05.05-04.07	66	PR-Code 1KZ				0 986 135 244			1 987 474 496 <sup>B</sup>	
	05.05-01.09	66	PR-Code 1KD	D53			0 986 473 381		38,1	1 987 470 040 <sup>7</sup>	
0 986 473 381								38,1	1 987 474 496 <sup>B</sup>		
0 986 474 381								38,1	1 987 470 040 <sup>7</sup>		
0 986 474 381								38,1	1 987 474 496 <sup>B</sup>		
			PR-Code 1KE	256			0 986 473 448		41	1 987 474 496 <sup>B</sup>	
							0 986 474 448		41	1 987 474 496 <sup>B</sup>	
			PR-Code 1KZ				0 986 134 048		38	1 987 474 496 <sup>B</sup>	
	05.07-01.09	66	PR-Code 1KZ				0 986 135 048		38	1 987 474 496 <sup>B</sup>	
		77	PR-Code 1KZ				0 986 135 048		38	1 987 474 496 <sup>B</sup>	
<b>2.0 FSI</b>	05.05-04.07	110	PR-Code 1KZ				0 986 135 244			1 987 474 496 <sup>B</sup>	
							05.05-06.08	110	PR-Code 1KD	D53	
								0 986 473 381		38,1	1 987 474 496 <sup>B</sup>
				PR-Code 1KE	256			0 986 473 448		41	1 987 474 496 <sup>B</sup>
							0 986 474 448		41	1 987 474 496 <sup>B</sup>	
			PR-Code 1KZ				0 986 134 048		38	1 987 474 496 <sup>B</sup>	
<b>2.0 TDI</b>	05.07-06.08	110	PR-Code 1KZ				0 986 135 048		38	1 987 474 496 <sup>B</sup>	
							01.05-04.07	100	PR-Code 1KZ		
			103	PR-Code 1KZ				0 986 135 244			1 987 474 496 <sup>B</sup>
	01.05-01.09	103	PR-Code 1KD	D53				0 986 473 381		38,1	1 987 470 040 <sup>7</sup>
0 986 473 381									38,1	1 987 474 496 <sup>B</sup>	
0 986 474 381									38,1	1 987 470 040 <sup>7</sup>	
			PR-Code 1KE	256			0 986 473 448		41	1 987 474 496 <sup>B</sup>	
							0 986 474 448		41	1 987 474 496 <sup>B</sup>	
			PR-Code 1KZ				0 986 134 048		38	1 987 474 496 <sup>B</sup>	
	01.05-05.09	100	PR-Code 1KD	D53			0 986 473 381		38,1	1 987 470 040 <sup>7</sup>	
0 986 473 381								38,1	1 987 474 496 <sup>B</sup>		
0 986 474 381								38,1	1 987 470 040 <sup>7</sup>		
0 986 474 381								38,1	1 987 474 496 <sup>B</sup>		
			PR-Code 1KE	256			0 986 473 448		41	1 987 474 496 <sup>B</sup>	
							0 986 474 448		41	1 987 474 496 <sup>B</sup>	
			PR-Code 1KZ				0 986 134 048		38	1 987 474 496 <sup>B</sup>	
	05.05-05.07	96	PR-Code 1KD	D53			0 986 473 381		38,1	1 987 470 040 <sup>7</sup>	
0 986 473 381								38,1	1 987 474 496 <sup>B</sup>		
0 986 474 381								38,1	1 987 470 040 <sup>7</sup>		
0 986 474 381								38,1	1 987 474 496 <sup>B</sup>		
			PR-Code 1KE	256			0 986 473 448		41	1 987 474 496 <sup>B</sup>	
							0 986 474 448		41	1 987 474 496 <sup>B</sup>	



<b>VW Golf Plus [5M1]</b>									
	2.0 TDI	05.05-05.07	96	PR-Code 1KZ		0986 134 048		38	1987 474 496 <sup>8</sup>
						0986 135 244			1987 474 496 <sup>8</sup>
		05.07-01.09	103	PR-Code 1KZ		0986 135 048		38	1987 474 496 <sup>8</sup>
		05.07-05.09	100	PR-Code 1KZ		0986 135 048		38	1987 474 496 <sup>8</sup>
	1.4	01.05-11.05	55	Fg.-Nr. →1K..6..570 000		1987 482 445		1447	
		12.05-05.06	55	Fg.-Nr. 1K..6..570 001→		1987 477 958		1447	
		05.06-12.08	59			1987 477 958		1447	
	1.4 FSI	07.05-11.05	66	Fg.-Nr. →1K..6..570 000		1987 482 445		1447	
		12.05-05.06	66	Fg.-Nr. 1K..6..570 001→		1987 477 958		1447	
	1.4 TSI	05.06-12.08	90/103/ 118/125			1987 477 958		1447	
	1.6	05.05-11.05	75	Fg.-Nr. →1K..6..570 000		1987 482 445		1447	
		12.05-12.08	75	Fg.-Nr. 1K..6..570 001→		1987 477 958		1447	
	1.6 FSI	01.05-11.05	85	Fg.-Nr. →1K..6..570 000		1987 482 445		1447	
		12.05-01.09	85	Fg.-Nr. 1K..6..570 001→		1987 477 958		1447	
	1.6 MultiFuel	11.07-12.08	75			1987 477 958		1447	
	1.9 TDI	01.05-05.06	77			1987 482 445		1447	
		05.05-11.05	66	Fg.-Nr. →1K..6..570 000		1987 482 445		1447	
		12.05-02.06	66	Fg.-Nr. 1K..6..570 001→		1987 477 958		1447	
		12.05-01.09	77	Fg.-Nr. 1K..6..570 001→		1987 477 958		1447	
		02.06-01.09	66			1987 477 958		1447	
		05.06-01.09	77			1987 477 958		1447	
	2.0 FSI	05.05-11.05	110			1987 482 445		1447	
		12.05-06.08	110	Fg.-Nr. 1K..6..570 001→		1987 477 958		1447	
	2.0 TDI	01.05-11.05	100	Fg.-Nr. →1K..6..570 000		1987 482 445		1447	
			103	Fg.-Nr. →1K..6..570 000		1987 482 445		1447	
		05.05-11.06	96	Fg.-Nr. →1K..6..570 000		1987 482 445		1447	
		12.05-05.07	96	Fg.-Nr. 1K..6..570 001→		1987 477 958		1447	
		12.05-01.09	103			1987 477 958		1447	
12.05-05.09		100	Fg.-Nr. 1K..6..570 001→		1987 477 958		1447		
	1.4	01.05-12.08	55/59/66/	LAB	0986 594 504 <sup>3</sup>				
			90/103/		0986 594 506 <sup>4</sup>				
			118/125	RAB	0986 594 505 <sup>3</sup>				
					0986 594 507 <sup>4</sup>				
	1.6	01.05-01.09	75/85	LAB	0986 594 504 <sup>3</sup>				
				RAB	0986 594 506 <sup>4</sup>				
	1.6 FSI			RAB	0986 594 505 <sup>3</sup>				
					0986 594 507 <sup>4</sup>				
	1.6 MultiFuel			RAB	0986 594 505 <sup>3</sup>				
					0986 594 507 <sup>4</sup>				
	1.9 TDI	01.05-01.09	66/77	LAB	0986 594 504 <sup>3</sup>				
RAB				0986 594 506 <sup>4</sup>					
				0986 594 505 <sup>3</sup>					
2.0 FSI	01.05-05.09	96/100/	LAB	0986 594 504 <sup>3</sup>					
			RAB	0986 594 506 <sup>4</sup>					
				0986 594 505 <sup>3</sup>					
2.0 TDI		103/110	RAB	0986 594 505 <sup>3</sup>					
				0986 594 507 <sup>4</sup>					
<b>Golf Plus [521]</b>									
	1.2 TSI	08.09-02.14	63/77	PR-Code 1ZA, PR-Code 1ZE	288,312	0986 473 384		53,94	F 026 A06 106 <sup>7</sup>
						0986 473 384		53,94	1987 470 506 <sup>8</sup>
						0986 474 384		53,94	F 026 A06 106 <sup>7</sup>
	1.4, FSI, TSI	01.09-02.14	59/66/90/ 118	PR-Code 1ZA, PR-Code 1ZE	288,312	0986 473 071		54	1987 470 506 <sup>8</sup>
						0986 474 071		54	1987 470 506 <sup>8</sup>
						0986 473 384		53,94	F 026 A06 106 <sup>7</sup>
						0986 474 384		53,94	F 026 A06 106 <sup>7</sup>

								
<b>1.4</b> , FSI, TSI	01.09-02.14	59/66/90/118	PR-Code 1ZF	228		0 986 473 071	↔ ← 54	1 987 470 506 <sup>B</sup>
						0 986 474 071	↔ → 54	1 987 470 506 <sup>B</sup>
<b>1.6</b> <b>1.6</b> BiFuel <b>1.6</b> MultiFuel <b>1.6</b> TDI	01.09-02.14	66/72-75/77	PR-Code 1ZA, PR-Code 1ZE	288,312		0 986 473 384	↔ ← 53,94	F 026 A06 106 <sup>7</sup>
						0 986 473 384	↔ ← 53,94	1 987 470 506 <sup>B</sup>
						0 986 474 384	↔ → 53,94	F 026 A06 106 <sup>7</sup>
			PR-Code 1ZF	228		0 986 473 071	↔ ← 54	1 987 470 506 <sup>B</sup>
						0 986 474 071	↔ → 54	1 987 470 506 <sup>B</sup>
<b>2.0</b> TDI	01.09-11.09	103	PR-Code 1ZA, PR-Code 1ZE	288,312		0 986 474 384	↔ → 53,94	1 987 470 506 <sup>B</sup>
	01.09-02.14	81/100	PR-Code 1ZA, PR-Code 1ZE	288,312		0 986 473 384	↔ ← 53,94	F 026 A06 106 <sup>7</sup>
						0 986 473 384	↔ ← 53,94	1 987 470 506 <sup>B</sup>
						0 986 474 384	↔ → 53,94	F 026 A06 106 <sup>7</sup>
			PR-Code 1ZF	228		0 986 473 071	↔ ← 54	1 987 470 506 <sup>B</sup>
						0 986 474 071	↔ → 54	1 987 470 506 <sup>B</sup>
		103	PR-Code 1ZA, PR-Code 1ZE	288,312		0 986 473 384	↔ ← 53,94	F 026 A06 106 <sup>7</sup>
						0 986 474 384	↔ → 53,94	F 026 A06 106 <sup>7</sup>
			PR-Code 1ZF	228		0 986 473 071	↔ ← 54	1 987 470 506 <sup>B</sup>
						0 986 474 071	↔ → 54	1 987 470 506 <sup>B</sup>
	11.09-02.14	103	PR-Code 1ZA, PR-Code 1ZE	288,312		0 986 473 384	↔ ← 53,94	1 987 470 506 <sup>B</sup>
								
 <b>1.2</b> TSI	08.09-05.11	63/77	PR-Code 1KD	D53		0 986 473 381	↔ ← 38,1	1 987 470 040 <sup>7</sup>
						0 986 473 381	↔ ← 38,1	1 987 474 496 <sup>B</sup>
						0 986 474 381	↔ → 38,1	1 987 470 040 <sup>7</sup>
			PR-Code 1KZ			0 986 134 048	↔ ← 38	1 987 474 496 <sup>B</sup>
						0 986 135 048	↔ → 38	1 987 474 496 <sup>B</sup>
	06.11-02.14	63/77				0 986 473 381	↔ ← 38,1	1 987 470 040 <sup>7</sup>
						0 986 473 381	↔ ← 38,1	1 987 474 496 <sup>B</sup>
						0 986 474 381	↔ → 38,1	1 987 470 040 <sup>7</sup>
<b>1.4</b>	01.09-05.11	59	PR-Code 1KD	D53		0 986 474 381	↔ → 38,1	1 987 474 496 <sup>B</sup>
	01.09-06.11	59	PR-Code 1KD	D53		0 986 473 381	↔ ← 38,1	1 987 470 040 <sup>7</sup>
						0 986 474 381	↔ → 38,1	1 987 470 040 <sup>7</sup>
			PR-Code 1KZ			0 986 134 048	↔ ← 38	1 987 474 496 <sup>B</sup>
						0 986 135 048	↔ → 38	1 987 474 496 <sup>B</sup>
	05.09-06.11	59	PR-Code 1KD	D53		0 986 473 381	↔ ← 38,1	1 987 474 496 <sup>B</sup>
	06.11-02.14	59				0 986 473 381	↔ ← 38,1	1 987 470 040 <sup>7</sup>
						0 986 473 381	↔ ← 38,1	1 987 474 496 <sup>B</sup>
						0 986 474 381	↔ → 38,1	1 987 470 040 <sup>7</sup>
<b>1.4</b> FSI	05.09-12.10	66	PR-Code 1KD	D53		0 986 473 381	↔ ← 38,1	1 987 470 040 <sup>7</sup>
						0 986 473 381	↔ ← 38,1	1 987 474 496 <sup>B</sup>
						0 986 474 381	↔ → 38,1	1 987 470 040 <sup>7</sup>
			PR-Code 1KZ			0 986 134 048	↔ ← 38	1 987 474 496 <sup>B</sup>
						0 986 135 048	↔ → 38	1 987 474 496 <sup>B</sup>
<b>1.4</b> TSI	01.09-05.11	90	PR-Code 1KD	D53		0 986 473 381	↔ ← 38,1	1 987 470 040 <sup>7</sup>
						0 986 473 381	↔ ← 38,1	1 987 474 496 <sup>B</sup>
						0 986 474 381	↔ → 38,1	1 987 470 040 <sup>7</sup>
			PR-Code 1KZ			0 986 134 048	↔ ← 38	1 987 474 496 <sup>B</sup>
						0 986 135 048	↔ → 38	1 987 474 496 <sup>B</sup>
		118	PR-Code 1KD	D53		0 986 473 381	↔ ← 38,1	1 987 470 040 <sup>7</sup>
						0 986 473 381	↔ ← 38,1	1 987 474 496 <sup>B</sup>
						0 986 474 381	↔ → 38,1	1 987 470 040 <sup>7</sup>
			PR-Code 1KZ			0 986 134 048	↔ ← 38	1 987 474 496 <sup>B</sup>
						0 986 135 048	↔ → 38	1 987 474 496 <sup>B</sup>
	06.11-09.12	118				0 986 474 381	↔ → 38,1	1 987 474 496 <sup>B</sup>
	06.11-02.14	90				0 986 473 381	↔ ← 38,1	1 987 470 040 <sup>7</sup>
						0 986 473 381	↔ ← 38,1	1 987 474 496 <sup>B</sup>
						0 986 474 381	↔ → 38,1	1 987 470 040 <sup>7</sup>
		118				0 986 473 381	↔ ← 38,1	1 987 470 040 <sup>7</sup>
						0 986 473 381	↔ ← 38,1	1 987 474 496 <sup>B</sup>
	05.12-02.14	118				0 986 474 381	↔ → 38,1	1 987 470 040 <sup>7</sup>
<b>1.6</b>	06.11-02.14	75				0 986 474 381	↔ → 38,1	1 987 474 496 <sup>B</sup>



		S													
	◀ VW Golf Plus [521]														
	1.6 1.6 MultiFuel	01.09-05.11	75	PR-Code 1KD	D53		0986 473 381		38,1	1987 470 040 <sup>7</sup>					
							0986 473 381		38,1	1987 474 496 <sup>8</sup>					
							0986 474 381		38,1	1987 470 040 <sup>7</sup>					
		06.11-02.14	75	PR-Code 1KZ		0986 134 048		38	1987 474 496 <sup>8</sup>						
						0986 135 048		38	1987 474 496 <sup>8</sup>						
						0986 473 381		38,1	1987 470 040 <sup>7</sup>						
	1.6 BiFuel 1.6 TDI	05.09-05.11	66/72-75	PR-Code 1KD	D53		0986 473 381		38,1	1987 470 040 <sup>7</sup>					
							0986 473 381		38,1	1987 474 496 <sup>8</sup>					
							0986 474 381		38,1	1987 470 040 <sup>7</sup>					
		06.11-02.14	66/72-75	PR-Code 1KZ		0986 134 048		38	1987 474 496 <sup>8</sup>						
						0986 135 048		38	1987 474 496 <sup>8</sup>						
						0986 473 381		38,1	1987 470 040 <sup>7</sup>						
	1.6 TDI	05.09-05.11	77	PR-Code 1KD	D53		0986 473 381		38,1	1987 470 040 <sup>7</sup>					
							0986 473 381		38,1	1987 474 496 <sup>8</sup>					
							0986 474 381		38,1	1987 470 040 <sup>7</sup>					
		06.11-02.14	77	PR-Code 1KZ		0986 134 048		38	1987 474 496 <sup>8</sup>						
						0986 135 048		38	1987 474 496 <sup>8</sup>						
						0986 473 381		38,1	1987 470 040 <sup>7</sup>						
	2.0 TDI	01.09-05.10	81/100/ 103	PR-Code 1KD	D53		0986 474 381		38,1	1987 474 496 <sup>8</sup>					
							01.09-05.11	81/100/ 103	PR-Code 1KD	D53		0986 473 381		38,1	1987 470 040 <sup>7</sup>
												0986 474 381		38,1	1987 470 040 <sup>7</sup>
		11.09-05.11	81/100/ 103	PR-Code 1KD	D53		0986 134 048		38	1987 474 496 <sup>8</sup>					
							0986 135 048		38	1987 474 496 <sup>8</sup>					
							0986 473 381		38,1	1987 474 496 <sup>8</sup>					
06.11-02.14	81/100/ 103			0986 474 381		38,1	1987 470 040 <sup>7</sup>								
				0986 473 381		38,1	1987 474 496 <sup>8</sup>								
				0986 474 381		38,1	1987 470 040 <sup>7</sup>								
	U	1.2 TSI	08.09-02.14	63/77			1987 477 958		1447						
		1.4	01.09-02.14	59/90/118				1987 477 958		1447					
		1.4 TSI	01.09-02.14	59/90/118				1987 477 958		1447					
		1.6	01.09-02.14	66/72-75/77				1987 477 958		1447					
		1.6 BiFuel	05.09-02.14	66/72-75/77				1987 477 958		1447					
		1.6 MultiFuel	01.09-02.14	66/72-75/77				1987 477 958		1447					
		1.6 TDI	05.09-02.14	66/72-75/77				1987 477 958		1447					
		2.0 TDI	01.09-02.14	81/100/103				1987 477 958		1447					
			T	1.2 TSI	08.09-02.14	63/77			0986 594 504 <sup>3</sup>						
									0986 594 506 <sup>4</sup>						
									RAB	0986 594 505 <sup>3</sup>					
										0986 594 507 <sup>4</sup>					
1.4	01.09-02.14			59/66/90/ 118					0986 594 504 <sup>3</sup>						
									0986 594 506 <sup>4</sup>						
1.4 FSI									RAB	0986 594 505 <sup>3</sup>					
										0986 594 507 <sup>4</sup>					
1.4 TSI									0986 594 504 <sup>3</sup>						
									0986 594 506 <sup>4</sup>						
1.6	01.09-02.14			66/72-75/ 77					RAB	0986 594 505 <sup>3</sup>					
										0986 594 507 <sup>4</sup>					
1.6 BiFuel							0986 594 504 <sup>3</sup>								
							0986 594 506 <sup>4</sup>								
1.6 MultiFuel							RAB	0986 594 505 <sup>3</sup>							
								0986 594 507 <sup>4</sup>							
1.6 TDI							0986 594 504 <sup>3</sup>								
							0986 594 506 <sup>4</sup>								
2.0 TDI	01.09-02.14	81/100/ 103					RAB	0986 594 505 <sup>3</sup>							
								0986 594 507 <sup>4</sup>							



**Golf Sportsvan [AM1]**

	1.2 TSI	04.14→	63/81		LAB	0 986 594 500 <sup>3</sup>		
					RAB	0 986 594 501 <sup>3</sup>		
					TW	0 986 594 526 <sup>4</sup>		
	1.4 TSI	02.14→	92/110		LAB	0 986 594 500 <sup>3</sup>		
					RAB	0 986 594 501 <sup>3</sup>		
					TW	0 986 594 526 <sup>4</sup>		
	1.6 1.6 TDI	02.14→	66/81		LAB	0 986 594 500 <sup>3</sup>		
					RAB	0 986 594 501 <sup>3</sup>		
					TW	0 986 594 526 <sup>4</sup>		
	2.0 TDI	02.14→	81/110		LAB	0 986 594 500 <sup>3</sup>		
					RAB	0 986 594 501 <sup>3</sup>		
					TW	0 986 594 526 <sup>4</sup>		

**Golf V Variant [1K5]**

	1.4	08.07-11.08	59			0 986 473 071		54	1 987 470 506 <sup>8</sup>
						0 986 474 071		54	1 987 470 506 <sup>8</sup>
	1.4 TSI	05.07-07.09	90/103/ 118/125	PR-Code 1ZE, PR-Code 1LJ, PR-Code 1ZP, PR-Code 1ZD	288,312	0 986 473 384		53,94	F 026 A06 106 <sup>7</sup>
						0 986 473 384		53,94	1 987 470 506 <sup>8</sup>
						0 986 474 384		53,94	F 026 A06 106 <sup>7</sup>
						0 986 474 384		53,94	1 987 470 506 <sup>8</sup>
	1.6 1.6 MultiFuel	05.07-11.08	75			0 986 473 071		54	1 987 470 506 <sup>8</sup>
						0 986 474 071		54	1 987 470 506 <sup>8</sup>
	1.9 TDI	05.07-11.08	77			0 986 473 071		54	1 987 470 506 <sup>8</sup>
						0 986 474 071		54	1 987 470 506 <sup>8</sup>
	1.9 TDI 4Motion	12.07-06.09	77		228	0 986 473 071		54	1 987 470 506 <sup>8</sup>
						0 986 474 071		54	1 987 470 506 <sup>8</sup>
					288,312	0 986 473 384		53,94	F 026 A06 106 <sup>7</sup>
						0 986 473 384		53,94	1 987 470 506 <sup>8</sup>
						0 986 474 384		53,94	F 026 A06 106 <sup>7</sup>
						0 986 474 384		53,94	1 987 470 506 <sup>8</sup>
	2.0 GTI	05.07-03.09	147	PR-Code 1LL, PR-Code 1LV	228	0 986 473 384		53,94	F 026 A06 106 <sup>7</sup>
						0 986 473 384		53,94	1 987 470 506 <sup>8</sup>
						0 986 474 384		53,94	F 026 A06 106 <sup>7</sup>
		04.08-06.09	147		228	0 986 473 071		54	1 987 470 506 <sup>8</sup>
						0 986 474 071		54	1 987 470 506 <sup>8</sup>
						288,312	0 986 473 384		53,94
	2.0 TDI 2.0 TDI 4Motion	05.07-07.09	96/100/ 103	PR-Code 1ZE, PR-Code 1LJ, PR-Code 1ZP, PR-Code 1ZD	288,312	0 986 473 384		53,94	F 026 A06 106 <sup>7</sup>
						0 986 473 384		53,94	1 987 470 506 <sup>8</sup>
						0 986 474 384		53,94	F 026 A06 106 <sup>7</sup>

	1.4	05.07-07.09	59/90/103/ 118/125	PR-Code 1KE, PR-Code 1KF, PR-Code 1KJ		0 986 473 448		41	1 987 474 496 <sup>8</sup>
						0 986 474 448		41	1 987 474 496 <sup>8</sup>
	1.6 1.6 MultiFuel	05.07-11.08	75	PR-Code 1KE, PR-Code 1KF, PR-Code 1KJ		0 986 473 448		41	1 987 474 496 <sup>8</sup>
						0 986 474 448		41	1 987 474 496 <sup>8</sup>
	1.9 TDI 1.9 TDI 4Motion	05.07-06.09	77	PR-Code 1KE, PR-Code 1KF, PR-Code 1KJ		0 986 473 448		41	1 987 474 496 <sup>8</sup>
						0 986 474 448		41	1 987 474 496 <sup>8</sup>
	2.0 GTI, TDI, TDI 4Motion	05.07-07.09	96/100/ 103/147	PR-Code 1KE, PR-Code 1KF, PR-Code 1KJ		0 986 473 448		41	1 987 474 496 <sup>8</sup>
						0 986 474 448		41	1 987 474 496 <sup>8</sup>

	1.4	08.07-11.08	59/90/103/118/125			1 987 477 958		1447	
	1.4 TSI	05.07-07.09	59/90/103/118/125			1 987 477 958		1447	
	1.6	05.07-11.08	75			1 987 477 958		1447	
	1.6 MultiFuel	01.08-11.08	75			1 987 477 958		1447	
	1.9 TDI	05.07-11.08	77			1 987 477 958		1447	





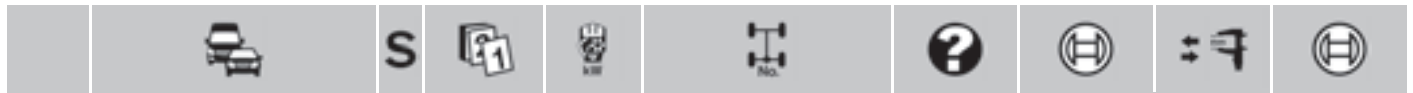

	◀ VW Golf V Variant [1K5]						
	1.9 TDI 4Motion	12.07-06.09	77			1987 477 958	↔ 1447
	2.0 GTI	05.07-06.09	96/100/103/147			1987 477 958	↔ 1447
	2.0 TDI	05.07-07.09	96/100/103/147			1987 477 958	↔ 1447
	2.0 TDI 4Motion	05.07-06.09	96/100/103/147			1987 477 958	↔ 1447

	1.4	05.07-07.09	59/90/103/		LAB	0986 594 504 <sup>3</sup>	
	1.4 TSI		118/125		RAB	0986 594 506 <sup>4</sup>	
						0986 594 505 <sup>3</sup>	
						0986 594 507 <sup>4</sup>	
	1.6	05.07-11.08	75		LAB	0986 594 504 <sup>3</sup>	
	1.6 MultiFuel				RAB	0986 594 506 <sup>4</sup>	
						0986 594 505 <sup>3</sup>	
						0986 594 507 <sup>4</sup>	
	1.9 TDI	05.07-06.09	77		LAB	0986 594 504 <sup>3</sup>	
	1.9 TDI 4Motion				RAB	0986 594 506 <sup>4</sup>	
						0986 594 505 <sup>3</sup>	
						0986 594 507 <sup>4</sup>	
	2.0 GTI	05.07-07.09	96/100/		LAB	0986 594 504 <sup>3</sup>	
	2.0 TDI		103/147			0986 594 506 <sup>4</sup>	
	2.0 TDI 4Motion				RAB	0986 594 505 <sup>3</sup>	
						0986 594 507 <sup>4</sup>	









**Golf V [1K1]**

	1.4	10.03-11.08	55/59/66			0986 473 071	👁️ ← 54 1987 470 506 <sup>8</sup>
	1.4 FSI					0986 474 071	👁️ → 54 1987 470 506 <sup>8</sup>
					288	0986 473 384	👁️ ← 53,94 F 026 A06 106 <sup>7</sup>
						0986 473 384	👁️ ← 53,94 1987 470 506 <sup>8</sup>
						0986 474 384	👁️ → 53,94 F 026 A06 106 <sup>7</sup>
	1.4 TSI	11.05-11.08	125	PR-Code 1LK, PR-Code 1LM		0986 134 257	👁️ ← F 026 A03 545 <sup>7</sup>
						0986 134 257	👁️ ← 1987 470 506 <sup>8</sup>
						0986 135 257	👁️ → F 026 A03 545 <sup>7</sup>
				PR-Code 1LL, PR-Code 1LV	312	0986 473 384	👁️ ← 53,94 F 026 A06 106 <sup>7</sup>
						0986 473 384	👁️ ← 53,94 1987 470 506 <sup>8</sup>
						0986 474 384	👁️ → 53,94 F 026 A06 106 <sup>7</sup>
				PR-Code 1ZC, PR-Code 1ZM, PR-Code 1ZF	228	0986 473 071	👁️ ← 54 1987 470 506 <sup>8</sup>
						0986 474 071	👁️ → 54 1987 470 506 <sup>8</sup>
				PR-Code 1ZE, PR-Code 1LJ, PR-Code 1ZP, PR-Code 1ZD	288,312	0986 473 384	👁️ ← 53,94 F 026 A06 106 <sup>7</sup>
						0986 473 384	👁️ ← 53,94 1987 470 506 <sup>8</sup>
						0986 474 384	👁️ → 53,94 F 026 A06 106 <sup>7</sup>
		05.06-11.08	90/103	PR-Code 1ZE, PR-Code 1LJ, PR-Code 1ZP, PR-Code 1ZD	288,312	0986 473 384	👁️ ← 53,94 F 026 A06 106 <sup>7</sup>
						0986 473 384	👁️ ← 53,94 1987 470 506 <sup>8</sup>
						0986 474 384	👁️ → 53,94 F 026 A06 106 <sup>7</sup>
	1.6	01.04-11.08	75			0986 473 071	👁️ ← 54 1987 470 506 <sup>8</sup>
						0986 474 071	👁️ → 54 1987 470 506 <sup>8</sup>
					288	0986 473 384	👁️ ← 53,94 F 026 A06 106 <sup>7</sup>
						0986 473 384	👁️ ← 53,94 1987 470 506 <sup>8</sup>
						0986 474 384	👁️ → 53,94 F 026 A06 106 <sup>7</sup>
		06.05-11.08	75	PR-Code 1LK, PR-Code 1LM		0986 134 257	👁️ ← F 026 A03 545 <sup>7</sup>
						0986 134 257	👁️ ← 1987 470 506 <sup>8</sup>
						0986 135 257	👁️ → F 026 A03 545 <sup>7</sup>
				PR-Code 1LL, PR-Code 1LV	312	0986 473 384	👁️ ← 53,94 F 026 A06 106 <sup>7</sup>
						0986 473 384	👁️ ← 53,94 1987 470 506 <sup>8</sup>
						0986 474 384	👁️ → 53,94 F 026 A06 106 <sup>7</sup>
				PR-Code 1ZC, PR-Code 1ZM, PR-Code 1ZF	228	0986 473 071	👁️ ← 54 1987 470 506 <sup>8</sup>
						0986 474 071	👁️ → 54 1987 470 506 <sup>8</sup>
				PR-Code 1ZE, PR-Code 1LJ, PR-Code 1ZP, PR-Code 1ZD	288,312	0986 473 384	👁️ ← 53,94 F 026 A06 106 <sup>7</sup>
						0986 473 384	👁️ ← 53,94 1987 470 506 <sup>8</sup>
						0986 474 384	👁️ → 53,94 F 026 A06 106 <sup>7</sup>
	1.6 FSI	10.03-07.08	85		228	0986 473 071	👁️ ← 54 1987 470 506 <sup>8</sup>
						0986 474 071	👁️ → 54 1987 470 506 <sup>8</sup>

		S							
<b>1.6 FSI</b>	10.03-07.08	85				288,312	0 986 473 384	← 53,94	F 026 A06 106 <sup>7</sup>
							0 986 473 384	← 53,94	1 987 470 506 <sup>8</sup>
							0 986 474 384	→ 53,94	F 026 A06 106 <sup>7</sup>
<b>1.6 MultiFuel</b>	11.07-11.08	75				288	0 986 473 071	← 54	1 987 470 506 <sup>8</sup>
							0 986 474 071	→ 54	1 987 470 506 <sup>8</sup>
							0 986 473 384	← 53,94	F 026 A06 106 <sup>7</sup>
<b>1.9 TDI</b>	05.04-11.08	66				288	0 986 473 384	← 53,94	1 987 470 506 <sup>8</sup>
							0 986 474 384	→ 53,94	F 026 A06 106 <sup>7</sup>
							0 986 473 071	← 54	1 987 470 506 <sup>8</sup>
<b>1.9 TDI</b> <b>1.9 TDI 4Motion</b>	10.03-11.08	77				228	0 986 473 071	← 54	1 987 470 506 <sup>8</sup>
							0 986 474 071	→ 54	1 987 470 506 <sup>8</sup>
							0 986 473 384	← 53,94	F 026 A06 106 <sup>7</sup>
<b>2.0 FSI</b>	01.04-11.08	110	PR-Code 1ZE, PR-Code 1LJ, PR-Code 1ZP, PR-Code 1ZD			288,312	0 986 473 384	← 53,94	F 026 A06 106 <sup>7</sup>
							0 986 473 384	← 53,94	1 987 470 506 <sup>8</sup>
							0 986 474 384	→ 53,94	F 026 A06 106 <sup>7</sup>
<b>2.0 FSI</b>	11.05-11.08	110	PR-Code 1LK, PR-Code 1LM			312	0 986 134 257	←	F 026 A03 545 <sup>7</sup>
							0 986 134 257	←	1 987 470 506 <sup>8</sup>
							0 986 135 257	→	F 026 A03 545 <sup>7</sup>
<b>2.0 FSI</b>			PR-Code 1LL, PR-Code 1LV			228	0 986 473 071	← 54	1 987 470 506 <sup>8</sup>
							0 986 474 071	→ 54	1 987 470 506 <sup>8</sup>
							0 986 473 384	← 53,94	F 026 A06 106 <sup>7</sup>
<b>2.0 FSI 4Motion</b>	08.04-10.08	110	PR-Code 1ZE, PR-Code 1LJ, PR-Code 1ZP, PR-Code 1ZD			288,312	0 986 473 384	← 53,94	F 026 A06 106 <sup>7</sup>
							0 986 473 384	← 53,94	1 987 470 506 <sup>8</sup>
							0 986 474 384	→ 53,94	F 026 A06 106 <sup>7</sup>
<b>2.0 GTI</b>	09.04-07.07	147	PR-Code 1LL, PR-Code 1LV			312	0 986 474 384	→ 53,94	1 987 470 506 <sup>8</sup>
							0 986 134 257	←	F 026 A03 545 <sup>7</sup>
							0 986 134 257	←	1 987 470 506 <sup>8</sup>
<b>2.0 GTI</b>	09.04-11.08	147	PR-Code 1LK, PR-Code 1LM			312	0 986 135 257	→	F 026 A03 545 <sup>7</sup>
							0 986 473 384	← 53,94	F 026 A06 106 <sup>7</sup>
							0 986 474 384	→ 53,94	F 026 A06 106 <sup>7</sup>
<b>2.0 GTI</b>			PR-Code 1ZC, PR-Code 1ZM, PR-Code 1ZF			228	0 986 473 071	← 54	1 987 470 506 <sup>8</sup>
							0 986 474 071	→ 54	1 987 470 506 <sup>8</sup>
							0 986 473 384	← 53,94	F 026 A06 106 <sup>7</sup>
<b>2.0 GTI</b>			PR-Code 1ZE, PR-Code 1LJ, PR-Code 1ZP, PR-Code 1ZD			288,312	0 986 473 384	← 53,94	1 987 470 506 <sup>8</sup>
							0 986 473 384	← 53,94	1 987 470 506 <sup>8</sup>
							0 986 474 384	→ 53,94	F 026 A06 106 <sup>7</sup>
<b>2.0 GTI</b>	11.05-11.08	147	PR-Code 1LL, PR-Code 1LV			312	0 986 473 384	← 53,94	1 987 470 506 <sup>8</sup>
							0 986 473 384	← 53,94	F 026 A06 106 <sup>7</sup>
							0 986 473 384	← 53,94	1 987 470 506 <sup>8</sup>
<b>2.0 GTI</b>			PR-Code 1LV			312	0 986 473 384	← 53,94	F 026 A06 106 <sup>7</sup>
							0 986 474 384	→ 53,94	F 026 A06 106 <sup>7</sup>
							0 986 473 384	← 53,94	1 987 470 506 <sup>8</sup>
<b>2.0 GTI</b>			PR-Code 1ZP, PR-Code 1ZD			288,312	0 986 473 384	← 53,94	F 026 A06 106 <sup>7</sup>
							0 986 473 384	← 53,94	1 987 470 506 <sup>8</sup>
							0 986 474 384	→ 53,94	F 026 A06 106 <sup>7</sup>
<b>2.0 GTI</b>	09.06-11.08	169	PR-Code 1LL, PR-Code 1LV			312	0 986 473 384	← 53,94	F 026 A06 106 <sup>7</sup>
							0 986 473 384	← 53,94	1 987 470 506 <sup>8</sup>
							0 986 474 384	→ 53,94	F 026 A06 106 <sup>7</sup>
<b>2.0 GTI</b>	03.08-11.08	147				228	0 986 134 257	←	F 026 A03 545 <sup>7</sup>
							0 986 134 257	←	1 987 470 506 <sup>8</sup>
							0 986 135 257	→	F 026 A03 545 <sup>7</sup>
<b>2.0 GTI</b>						288,312	0 986 473 071	← 54	1 987 470 506 <sup>8</sup>
							0 986 474 071	→ 54	1 987 470 506 <sup>8</sup>
							0 986 473 384	← 53,94	F 026 A06 106 <sup>7</sup>
<b>2.0 SDI</b>	01.04-11.08	55				288,312	0 986 473 384	← 53,94	1 987 470 506 <sup>8</sup>
							0 986 473 384	← 53,94	1 987 470 506 <sup>8</sup>
							0 986 474 384	→ 53,94	F 026 A06 106 <sup>7</sup>
<b>2.0 SDI</b>						288,312	0 986 473 071	← 54	1 987 470 506 <sup>8</sup>
							0 986 473 384	← 53,94	1 987 470 506 <sup>8</sup>
							0 986 474 071	→ 54	1 987 470 506 <sup>8</sup>













		S							
	◀ VW Golf V [1K1]								
2.0 SDI		01.04-11.08	55			288	0986 473 384	53,94	F 026 A06 106 <sup>7</sup>
							0986 473 384	53,94	1987 470 506 <sup>8</sup>
							0986 474 384	53,94	F 026 A06 106 <sup>7</sup>
2.0 TDI		11.05-11.08	125	PR-Code 1ZE, PR-Code 1LJ, PR-Code 1ZP, PR-Code 1ZD		288,312	0986 473 384	53,94	F 026 A06 106 <sup>7</sup>
							0986 473 384	53,94	1987 470 506 <sup>8</sup>
							0986 474 384	53,94	F 026 A06 106 <sup>7</sup>
2.0 TDI 2.0 TDI 4Motion		10.03-11.08	100/103	PR-Code 1ZE, PR-Code 1LJ, PR-Code 1ZP, PR-Code 1ZD		288,312	0986 473 384	53,94	F 026 A06 106 <sup>7</sup>
							0986 473 384	53,94	1987 470 506 <sup>8</sup>
							0986 474 384	53,94	F 026 A06 106 <sup>7</sup>
2.5		05.07-11.08	125	PR-Code 1ZE, PR-Code 1LJ, PR-Code 1ZP, PR-Code 1ZD		288,312	0986 473 384	53,94	F 026 A06 106 <sup>7</sup>
							0986 473 384	53,94	1987 470 506 <sup>8</sup>
							0986 474 384	53,94	F 026 A06 106 <sup>7</sup>
3.2 R32		05.05-07.07	184	PR-Code 1LK, PR-Code 1LM			0986 134 257		1987 470 506 <sup>8</sup>
							0986 135 257		1987 470 506 <sup>8</sup>
3.2 R32, R32 4Motion		05.05-11.08	184	PR-Code 1LK, PR-Code 1LM			0986 134 257		F 026 A03 545 <sup>7</sup>
3.2 R32 4Motion		11.05-11.08	184	PR-Code 1LK, PR-Code 1LM			0986 135 257		F 026 A03 545 <sup>7</sup>
							0986 135 257		1987 470 506 <sup>8</sup>
				PR-Code 1LL, PR-Code 1LV		312	0986 473 384	53,94	F 026 A06 106 <sup>7</sup>
							0986 473 384	53,94	1987 470 506 <sup>8</sup>
							0986 474 384	53,94	F 026 A06 106 <sup>7</sup>
				PR-Code 1ZC, PR-Code 1ZM, PR-Code 1ZF		228	0986 473 071	54	1987 470 506 <sup>8</sup>
							0986 474 071	54	1987 470 506 <sup>8</sup>
				PR-Code 1ZE, PR-Code 1LJ, PR-Code 1ZP, PR-Code 1ZD		288,312	0986 473 384	53,94	F 026 A06 106 <sup>7</sup>
							0986 473 384	53,94	1987 470 506 <sup>8</sup>
							0986 474 384	53,94	F 026 A06 106 <sup>7</sup>
		1.4	10.03-11.08	55/59/66/ 90			0986 473 381	38,1	1987 470 040 <sup>7</sup>
		1.4 FSI					0986 473 381	38,1	1987 474 496 <sup>8</sup>
		1.4 TSI					0986 474 381	38,1	1987 470 040 <sup>7</sup>
		1.4 TSI	11.05-11.08	125			0986 473 381	38,1	1987 470 040 <sup>7</sup>
							0986 473 381	38,1	1987 474 496 <sup>8</sup>
							0986 474 381	38,1	1987 470 040 <sup>7</sup>
						256	0986 473 448	41	1987 474 496 <sup>8</sup>
							0986 474 448	41	1987 474 496 <sup>8</sup>
				PR-Code 1KY, PR-Code 1KV			0986 134 244		1987 474 496 <sup>8</sup>
							0986 135 244		1987 474 496 <sup>8</sup>
				PR-Code 1KZ			0986 134 048	38	1987 474 496 <sup>8</sup>
							0986 135 048	38	1987 474 496 <sup>8</sup>
		05.06-11.08	103	PR-Code 1KD			0986 473 381	38,1	1987 470 040 <sup>7</sup>
							0986 473 381	38,1	1987 474 496 <sup>8</sup>
							0986 474 381	38,1	1987 470 040 <sup>7</sup>
				PR-Code 1KE, PR-Code 1KF, PR-Code 1KJ, PR-Code 1KV			0986 473 448	41	1987 474 496 <sup>8</sup>
							0986 474 448	41	1987 474 496 <sup>8</sup>
1.6		01.04-11.08	75				0986 473 381	38,1	1987 470 040 <sup>7</sup>
							0986 473 381	38,1	1987 474 496 <sup>8</sup>
							0986 474 381	38,1	1987 470 040 <sup>7</sup>
		06.05-11.08	75	PR-Code 1KD, PR-Code 1KQ		D53	0986 473 381	38,1	1987 470 040 <sup>7</sup>
							0986 473 381	38,1	1987 474 496 <sup>8</sup>
							0986 474 381	38,1	1987 470 040 <sup>7</sup>
				PR-Code 1KF, PR-Code 1KE, PR-Code 1KJ		256	0986 473 448	41	1987 474 496 <sup>8</sup>
							0986 474 448	41	1987 474 496 <sup>8</sup>
				PR-Code 1KZ			0986 134 048	38	1987 474 496 <sup>8</sup>
							0986 135 048	38	1987 474 496 <sup>8</sup>
1.6 FSI		10.03-07.08	85				0986 473 381	38,1	1987 470 040 <sup>7</sup>
							0986 473 381	38,1	1987 474 496 <sup>8</sup>
							0986 474 381	38,1	1987 470 040 <sup>7</sup>
1.6 MultiFuel		11.07-11.08	75				0986 473 381	38,1	1987 470 040 <sup>7</sup>
							0986 473 381	38,1	1987 474 496 <sup>8</sup>
							0986 474 381	38,1	1987 470 040 <sup>7</sup>

		S													
<b>1.9 TDI</b>	10.03-11.08	77					0 986 473 381	← 38,1	1 987 470 040 <sup>7</sup>						
							0 986 473 381	← 38,1	1 987 474 496 <sup>8</sup>						
							0 986 474 381	→ 38,1	1 987 470 040 <sup>7</sup>						
	05.04-11.08	66					0 986 473 381	← 38,1	1 987 470 040 <sup>7</sup>						
							0 986 473 381	← 38,1	1 987 474 496 <sup>8</sup>						
							0 986 474 381	→ 38,1	1 987 470 040 <sup>7</sup>						
<b>1.9 TDI 4Motion</b>	10.03-10.08	77					0 986 473 448	← 41	1 987 474 496 <sup>8</sup>						
							0 986 474 448	→ 41	1 987 474 496 <sup>8</sup>						
<b>2.0 FSI</b>	01.04-11.08	110					0 986 473 381	← 38,1	1 987 470 040 <sup>7</sup>						
							0 986 473 381	← 38,1	1 987 474 496 <sup>8</sup>						
							0 986 474 381	→ 38,1	1 987 470 040 <sup>7</sup>						
	11.05-11.08	110		PR-Code 1KD, PR-Code 1KQ	D53			0 986 473 381	← 38,1	1 987 470 040 <sup>7</sup>					
								0 986 473 381	← 38,1	1 987 474 496 <sup>8</sup>					
								0 986 474 381	→ 38,1	1 987 470 040 <sup>7</sup>					
								0 986 473 448	← 41	1 987 474 496 <sup>8</sup>					
								0 986 474 448	→ 41	1 987 474 496 <sup>8</sup>					
								0 986 134 048	← 38	1 987 474 496 <sup>8</sup>					
	08.04-10.08	110						0 986 135 048	→ 38	1 987 474 496 <sup>8</sup>					
								0 986 473 448	← 41	1 987 474 496 <sup>8</sup>					
								0 986 474 448	→ 41	1 987 474 496 <sup>8</sup>					
<b>2.0 GTI</b>	09.04-07.07	147	PR-Code 1KD, PR-Code 1KQ	D53			0 986 474 381	→ 38,1	1 987 474 496 <sup>8</sup>						
							09.04-11.08	147	PR-Code 1KD, PR-Code 1KQ	D53			0 986 473 381	← 38,1	1 987 470 040 <sup>7</sup>
							0 986 473 381						← 38,1	1 987 474 496 <sup>8</sup>	
	0 986 473 448	← 41	1 987 474 496 <sup>8</sup>												
	11.05-11.08	147		PR-Code 1KF, PR-Code 1KE,	256			0 986 474 448	→ 41	1 987 474 496 <sup>8</sup>					
								PR-Code 1KJ	0 986 474 448	→ 41	1 987 474 496 <sup>8</sup>				
								PR-Code 1KZ	0 986 134 048	← 38	1 987 474 496 <sup>8</sup>				
									0 986 135 048	→ 38	1 987 474 496 <sup>8</sup>				
									0 986 474 381	→ 38,1	1 987 470 040 <sup>7</sup>				
									0 986 473 448	← 41	1 987 474 496 <sup>8</sup>				
	09.06-11.08	169		PR-Code 1KD, PR-Code 1KQ	D53			0 986 474 448	→ 41	1 987 474 496 <sup>8</sup>					
								PR-Code 1KE	256	0 986 473 448	← 41	1 987 474 496 <sup>8</sup>			
									0 986 474 448	→ 41	1 987 474 496 <sup>8</sup>				
									0 986 134 244	←	1 987 474 496 <sup>8</sup>				
									0 986 135 244	→	1 987 474 496 <sup>8</sup>				
									0 986 134 244	←	1 987 474 496 <sup>8</sup>				
03.08-11.08	147		PR-Code 1KY, PR-Code 1KV				0 986 135 244	→	1 987 474 496 <sup>8</sup>						
							0 986 473 381	← 38,1	1 987 470 040 <sup>7</sup>						
							0 986 473 381	← 38,1	1 987 474 496 <sup>8</sup>						
							0 986 473 448	← 41	1 987 474 496 <sup>8</sup>						
							0 986 474 381	→ 38,1	1 987 470 040 <sup>7</sup>						
							0 986 474 448	→ 41	1 987 474 496 <sup>8</sup>						
<b>2.0 SDI</b>	01.04-11.08	55					0 986 473 381	← 38,1	1 987 470 040 <sup>7</sup>						
							0 986 473 381	← 38,1	1 987 474 496 <sup>8</sup>						
							0 986 474 381	→ 38,1	1 987 470 040 <sup>7</sup>						
<b>2.0 TDI</b>	10.03-11.08	100/103					0 986 473 448	← 41	1 987 474 496 <sup>8</sup>						
							0 986 474 448	→ 41	1 987 474 496 <sup>8</sup>						
							PR-Code 1KD	0 986 473 381	← 38,1	1 987 470 040 <sup>7</sup>					
	11.05-11.08	125						0 986 473 381	← 38,1	1 987 474 496 <sup>8</sup>					
								0 986 474 381	→ 38,1	1 987 470 040 <sup>7</sup>					
								0 986 473 448	← 41	1 987 474 496 <sup>8</sup>					
<b>2.0 TDI 4Motion</b>	10.03-10.08	100/103					0 986 474 448	← 41	1 987 474 496 <sup>8</sup>						
							0 986 474 448	→ 41	1 987 474 496 <sup>8</sup>						
<b>2.5</b>	05.07-11.08	125					0 986 134 048	← 38	1 987 474 496 <sup>8</sup>						
							0 986 135 048	→ 38	1 987 474 496 <sup>8</sup>						
<b>3.2 R32</b>	05.05-07.07	184	PR-Code 2EL						1 987 474 496 <sup>8</sup>						
<b>3.2 R32 4Motion</b>	11.05-11.08	184	PR-Code 1KF, PR-Code 1KE	256			0 986 473 448	← 41	1 987 474 496 <sup>8</sup>						
							0 986 474 448	→ 41	1 987 474 496 <sup>8</sup>						
	05.07-11.08	184	PR-Code 2EL	B31						1 987 474 496 <sup>8</sup>					
			PR-Code 2EL						1 987 474 496 <sup>8</sup>						
	<b>1.4</b>	10.03-06.06	55				FMU		↔ 1447						
							FMU		↔ 1447						

		S							
◀ VW Golf V [1K1]									
<b>1.4</b>	05.06-05.06	59		Fg.-Nr. →1K..6..620 000	FMU	1987 482 445	↔	1447	
	05.06-11.08	59			FMU	1987 477 958	↔	1447	
	06.06-11.08	59		Fg.-Nr. 1K..6.620 001→	FMU	1987 477 958	↔	1447	
<b>1.4 FSI</b>	10.03-05.06	66			FMU	1987 477 958	↔	1447	
					FMU	1987 482 445	↔	1447	
<b>1.4 TSI</b>	11.05-05.06	103/125		Fg.-Nr. →1K..6..620 000	FMU	1987 482 445	↔	1447	
	11.05-11.08	103/125			FMU	1987 477 958	↔	1447	
	06.06-11.08	103/125		Fg.-Nr. 1K..6.620 001→	FMU	1987 477 958	↔	1447	
	07.07-11.08	90				1987 477 958	↔	1447	
<b>1.6</b>	01.04-05.05	75			FMU	1987 482 445	↔	1447	
	01.04-11.08	75			FMU	1987 477 958	↔	1447	
	06.05-12.05	75		Fg.-Nr. →1K..6B105 621, →1K..6P019 868, →1K..6U025 123, →1K..6W113 525	FMU	1987 482 445	↔	1447	
	06.05-05.06	75		Fg.-Nr. →1K..6..620 000	FMU	1987 482 445	↔	1447	
	01.06-11.08	75		Fg.-Nr. 1K..6B105 622→, 1K..6P019 869→, 1K..6U025 124→, 1K..6W113 526→	FMU	1987 477 958	↔	1447	
	06.06-11.08	75		Fg.-Nr. 1K..6.620 001→	FMU	1987 477 958	↔	1447	
<b>1.6 FSI</b>	10.03-02.05	85			FMU	1987 482 445	↔	1447	
	10.03-07.08	85			FMU	1987 477 958	↔	1447	
	01.05-05.06	85		Fg.-Nr. →1K..6..620 000	FMU	1987 482 445	↔	1447	
	06.06-07.08	85		Fg.-Nr. 1K..6.620 001→	FMU	1987 477 958	↔	1447	
<b>1.6 MultiFuel</b>	11.07-11.08	75			1987 477 958	↔	1447		
<b>1.9 TDI</b>	10.03-02.06	77			FMU	1987 482 445	↔	1447	
	10.03-11.08	77			FMU	1987 477 958	↔	1447	
	05.04-02.06	66			FMU	1987 482 445	↔	1447	
	05.04-11.08	66			FMU	1987 477 958	↔	1447	
	08.05-05.06	77		Fg.-Nr. →1K..6..620 000	FMU	1987 482 445	↔	1447	
	02.06-05.06	66		Fg.-Nr. →1K..6..620 000	FMU	1987 482 445	↔	1447	
	06.06-11.08	66		Fg.-Nr. 1K..6.620 001→	FMU	1987 477 958	↔	1447	
		77		Fg.-Nr. 1K..6.620 001→	FMU	1987 477 958	↔	1447	
	05.07-11.08	66				1987 477 958	↔	1447	
<b>1.9 TDI 4Motion</b>	10.03-02.06	77			FMU	1987 482 445	↔	1447	
	10.03-10.08	77			FMU	1987 477 958	↔	1447	
	08.05-05.06	77		Fg.-Nr. →1K..6..620 000	FMU	1987 482 445	↔	1447	
	06.06-10.08	77		Fg.-Nr. 1K..6.620 001→	FMU	1987 477 958	↔	1447	
<b>2.0 FSI</b>	01.04-11.05	110			FMU	1987 482 445	↔	1447	
	01.04-11.08	110			FMU	1987 477 958	↔	1447	
	11.05-12.05	110		Fg.-Nr. →1K..6B105 621, →1K..6P019 868, →1K..6U025 123, →1K..6W113 525	FMU	1987 482 445	↔	1447	
	11.05-05.06	110		Fg.-Nr. →1K..6..620 000	FMU	1987 482 445	↔	1447	
	01.06-11.08	110		Fg.-Nr. 1K..6B105 622→, 1K..6P019 869→, 1K..6U025 124→, 1K..6W113 526→	FMU	1987 477 958	↔	1447	
<b>2.0 FSI 4Motion</b>	06.06-11.08	110		Fg.-Nr. 1K..6.620 001→	FMU	1987 477 958	↔	1447	
	08.04-11.05	110			FMU	1987 482 445	↔	1447	
	08.04-10.08	110			FMU	1987 477 958	↔	1447	
	11.05-05.06	110		Fg.-Nr. →1K..6..620 000	FMU	1987 482 445	↔	1447	
	06.06-10.08	110		Fg.-Nr. 1K..6.620 001→	FMU	1987 477 958	↔	1447	
<b>2.0 GTI</b>	09.04-12.05	147		Fg.-Nr. →1K..6B105 621, →1K..6P019 868, →1K..6U025 123, →1K..6W113 525	FMU	1987 482 445	↔	1447	
	09.04-11.08	147			FMU	1987 477 958	↔	1447	
	11.05-12.05	147		Fg.-Nr. →1K..6B105 621, →1K..6P019 868, →1K..6U025 123, →1K..6W113 525		1987 482 445	↔	1447	
	01.06-11.08	147		Fg.-Nr. 1K..6B105 622→, 1K..6P019 869→, 1K..6U025 124→, 1K..6W113 526→	FMU	1987 477 958	↔	1447	
		09.06-11.08	169				1987 477 958	↔	1447
	03.08-11.08	147				1987 477 958	↔	1447	



								
2.0 SDI	01.04-05.06	55/100/103	Fg.-Nr. →1K..6..620 000	FMU	1 987 482 445	↔ 1447		
	01.04-11.08	55/100/103		FMU	1 987 477 958	↔ 1447		
	06.06-11.08	55/100/103	Fg.-Nr. 1K..6.620 001→	FMU	1 987 477 958	↔ 1447		
2.0 TDI	10.03-05.06	55/100/103	Fg.-Nr. →1K..6..620 000	FMU	1 987 482 445	↔ 1447		
	10.03-11.08	55/100/103		FMU	1 987 477 958	↔ 1447		
	11.05-05.06	125	Fg.-Nr. →1K..6..620 000	FMU	1 987 482 445	↔ 1447		
	11.05-11.08	125		FMU	1 987 477 958	↔ 1447		
	06.06-11.08	55/100/103	Fg.-Nr. 1K..6.620 001→	FMU	1 987 477 958	↔ 1447		
			125	Fg.-Nr. 1K..6.620 001→	FMU	1 987 477 958	↔ 1447	
2.0 TDI 4Motion	10.03-05.06	55/100/103	Fg.-Nr. →1K..6..620 000	FMU	1 987 482 445	↔ 1447		
	10.03-10.08	55/100/103		FMU	1 987 477 958	↔ 1447		
	06.06-10.08	55/100/103	Fg.-Nr. 1K..6.620 001→	FMU	1 987 477 958	↔ 1447		
2.5	05.07-11.08	125			1 987 477 958	↔ 1447		
3.2 R32	05.05-05.06	184	Fg.-Nr. →1K..6..620 000	FMU	1 987 482 445	↔ 1447		
	05.05-07.07	184		FMU	1 987 477 958	↔ 1447		
	06.06-07.07	184	Fg.-Nr. 1K..6.620 001→	FMU	1 987 477 958	↔ 1447		
3.2 R32 4Motion	11.05-12.05	184	Fg.-Nr. →1K..6B105 621, →1K..6P019 868, →1K..6U025 123, →1K..6W113 525	FMU	1 987 482 445	↔ 1447		
	11.05-11.08	184		FMU	1 987 477 958	↔ 1447		
	01.06-11.08	184	Fg.-Nr. 1K..6B105 622→, 1K..6P019 869→, 1K..6U025 124→, 1K..6W113 526→	FMU	1 987 477 958	↔ 1447		
	05.07-11.08	184			1 987 477 958	↔ 1447		
 1.4	10.03-11.08	55/59/66/		LAB	0 986 594 504 <sup>3</sup>			
	1.4 FSI	90/103/			0 986 594 506 <sup>4</sup>			
	1.4 TSI	125		RAB	0 986 594 505 <sup>3</sup>			
					0 986 594 507 <sup>4</sup>			
1.6	10.03-11.08	75/85		LAB	0 986 594 504 <sup>3</sup>			
	1.6 FSI				0 986 594 506 <sup>4</sup>			
	1.6 MultiFuel			RAB	0 986 594 505 <sup>3</sup>			
					0 986 594 507 <sup>4</sup>			
1.9 TDI	10.03-11.08	66/77		LAB	0 986 594 504 <sup>3</sup>			
	1.9 TDI 4Motion				0 986 594 506 <sup>4</sup>			
				RAB	0 986 594 505 <sup>3</sup>			
					0 986 594 507 <sup>4</sup>			
2.0 FSI, FSI 4Motion, GTI, SDI, TDI TDI 4Motion	10.03-11.08	55/100/ 103/110/ 125/147/ 169		LAB	0 986 594 504 <sup>3</sup>			
					0 986 594 506 <sup>4</sup>			
				RAB	0 986 594 505 <sup>3</sup>			
					0 986 594 507 <sup>4</sup>			
2.5	05.07-11.08	125		LAB	0 986 594 504 <sup>3</sup>			
					0 986 594 506 <sup>4</sup>			
				RAB	0 986 594 505 <sup>3</sup>			
					0 986 594 507 <sup>4</sup>			
3.2 R32	05.05-07.07	184		LAB	0 986 594 504 <sup>3</sup>			
				RAB	0 986 594 505 <sup>3</sup>			
3.2 R32	05.05-11.08	184		LAB	0 986 594 506 <sup>4</sup>			
3.2 R32 4Motion				RAB	0 986 594 507 <sup>4</sup>			
3.2 R32 4Motion	11.05-11.08	184		LAB	0 986 594 504			
					0 986 594 505			
	05.07-11.08	184		LAB	0 986 594 504 <sup>3</sup>			
				RAB	0 986 594 505 <sup>3</sup>			





◀ VW

**Golf VI Cabriolet [517]**



	<b>1.2 TSI</b>	03.11-11.13	77	PR-Code 1ZA, PR-Code 1ZE, PR-Code 1ZD, PR-Code 1ZP	288,312	0986 <b>473 384</b>		← 53,94	F 026 <b>A06 106</b> <sup>7</sup>		
						0986 <b>473 384</b>		← 53,94	1987 <b>470 506</b> <sup>8</sup>		
						0986 <b>474 384</b>		→ 53,94	F 026 <b>A06 106</b> <sup>7</sup>		
						PR-Code 1ZB	312	0986 <b>473 384</b>		← 53,94	F 026 <b>A06 106</b> <sup>7</sup>
						0986 <b>473 384</b>			← 53,94	1987 <b>470 506</b> <sup>8</sup>	
						0986 <b>474 384</b>			→ 53,94	F 026 <b>A06 106</b> <sup>7</sup>	
		PR-Code 1ZK	312	0986 <b>134 287</b>		←	F 026 <b>A03 545</b> <sup>7</sup>				
		0986 <b>134 287</b>			←	1987 <b>470 506</b> <sup>8</sup>					
		0986 <b>135 287</b>			→	F 026 <b>A03 545</b> <sup>7</sup>					
		<b>1.4 TSI</b>		03.11-09.12	118	PR-Code 1ZK	288,312	0986 <b>135 287</b>		→	1987 <b>470 506</b> <sup>8</sup>
								0986 <b>135 287</b>		→	1987 <b>470 506</b> <sup>8</sup>
				03.11→	118	PR-Code 1ZA, PR-Code 1ZE, PR-Code 1ZD, PR-Code 1ZP	288,312	0986 <b>473 384</b>		← 53,94	F 026 <b>A06 106</b> <sup>7</sup>
0986 <b>473 384</b>			← 53,94					1987 <b>470 506</b> <sup>8</sup>			
PR-Code 1ZB	312		0986 <b>474 384</b>		→ 53,94	F 026 <b>A06 106</b> <sup>7</sup>					
			0986 <b>474 384</b>		→ 53,94	F 026 <b>A06 106</b> <sup>7</sup>					
PR-Code 1ZK	312	0986 <b>134 287</b>		←	F 026 <b>A03 545</b> <sup>7</sup>						
		0986 <b>134 287</b>		←	1987 <b>470 506</b> <sup>8</sup>						
<b>1.6 TDI</b>	03.11-11.13	77	PR-Code 1ZA, PR-Code 1ZE, PR-Code 1ZD, PR-Code 1ZP	288,312	0986 <b>473 384</b>		← 53,94	F 026 <b>A06 106</b> <sup>7</sup>			
					0986 <b>473 384</b>		← 53,94	1987 <b>470 506</b> <sup>8</sup>			
					0986 <b>474 384</b>		→ 53,94	F 026 <b>A06 106</b> <sup>7</sup>			
					PR-Code 1ZB	312	0986 <b>473 384</b>		← 53,94	F 026 <b>A06 106</b> <sup>7</sup>	
					0986 <b>473 384</b>			← 53,94	1987 <b>470 506</b> <sup>8</sup>		
					0986 <b>474 384</b>			→ 53,94	F 026 <b>A06 106</b> <sup>7</sup>		
	PR-Code 1ZK	312	0986 <b>134 287</b>		←	F 026 <b>A03 545</b> <sup>7</sup>					
	0986 <b>134 287</b>			←	1987 <b>470 506</b> <sup>8</sup>						
	0986 <b>135 287</b>			→	F 026 <b>A03 545</b> <sup>7</sup>						
	<b>2.0 TDI</b>		11.11-11.13	103/155	PR-Code 1ZA, PR-Code 1ZE, PR-Code 1ZD, PR-Code 1ZP	288,312	0986 <b>473 384</b>		← 53,94	F 026 <b>A06 106</b> <sup>7</sup>	
							0986 <b>473 384</b>		← 53,94	1987 <b>470 506</b> <sup>8</sup>	
			PR-Code 1ZB	312	0986 <b>474 384</b>		→ 53,94	F 026 <b>A06 106</b> <sup>7</sup>			
0986 <b>474 384</b>					→ 53,94	F 026 <b>A06 106</b> <sup>7</sup>					
PR-Code 1ZK		312	0986 <b>134 287</b>		←	F 026 <b>A03 545</b> <sup>7</sup>					
			0986 <b>134 287</b>		←	1987 <b>470 506</b> <sup>8</sup>					
<b>2.0 TSI</b>	01.13→	188/195	PR-Code 1ZB	312	0986 <b>135 287</b>		→	F 026 <b>A03 545</b> <sup>7</sup>			
					0986 <b>135 287</b>		→	F 026 <b>A03 545</b> <sup>7</sup>			
	PR-Code 1ZK	312	0986 <b>473 384</b>		← 53,94	F 026 <b>A06 106</b> <sup>7</sup>					
			0986 <b>473 384</b>		← 53,94	1987 <b>470 506</b> <sup>8</sup>					
	PR-Code 1ZK	312	0986 <b>474 384</b>		→ 53,94	F 026 <b>A06 106</b> <sup>7</sup>					
			0986 <b>474 384</b>		→ 53,94	F 026 <b>A06 106</b> <sup>7</sup>					



	<b>1.2 TSI</b>	03.11-11.13	77	PR-Code 1KD	D53	0986 <b>473 381</b>		← 38,1	1987 <b>470 040</b> <sup>7</sup>		
						0986 <b>473 381</b>		← 38,1	1987 <b>474 496</b> <sup>8</sup>		
						0986 <b>474 381</b>		→ 38,1	1987 <b>470 040</b> <sup>7</sup>		
						PR-Code 1KS	312	0986 <b>134 203</b>		← 38	
						0986 <b>135 203</b>			→ 38		

	S								
1.2 TSI	03.11-11.13	77	PR-Code 1KW	B31				1 987 474 496 <sup>B</sup>	
1.4 TSI	03.11→	90/118	PR-Code 1KD	D53	0 986 473 381		38,1	1 987 470 040 <sup>7</sup>	
					0 986 473 381		38,1	1 987 474 496 <sup>B</sup>	
					0 986 474 381		38,1	1 987 470 040 <sup>7</sup>	
			PR-Code 1KS		0 986 134 203		38		
			PR-Code 1KW		B31			1 987 474 496 <sup>B</sup>	
1.6 TDI	03.11-11.13	77	PR-Code 1KD	D53	0 986 473 381		38,1	1 987 470 040 <sup>7</sup>	
					0 986 473 381		38,1	1 987 474 496 <sup>B</sup>	
					0 986 474 381		38,1	1 987 470 040 <sup>7</sup>	
			PR-Code 1KS		0 986 134 203		38		
			PR-Code 1KW		B31			1 987 474 496 <sup>B</sup>	
2.0 TDI	11.11-11.13	103/155	PR-Code 1KD	D53	0 986 473 381		38,1	1 987 470 040 <sup>7</sup>	
					0 986 473 381		38,1	1 987 474 496 <sup>B</sup>	
					0 986 474 381		38,1	1 987 470 040 <sup>7</sup>	
PR-Code 1KS		0 986 134 203		38					
PR-Code 1KW		B31			1 987 474 496 <sup>B</sup>				
2.0 TSI	01.13→	188/195	PR-Code 1KW	B31				1 987 474 496 <sup>B</sup>	
	1.2 TSI	03.11-11.13	77			1 987 477 958		1447	
	1.4 TSI	03.11→	90/118			1 987 477 958		1447	
	1.6 TDI	03.11-11.13	77			1 987 477 958		1447	
	2.0 TDI	11.11-11.13	103/155/188/195			1 987 477 958		1447	
	2.0 TSI	05.12→	103/155/188/195			1 987 477 958		1447	
	1.2 TSI	03.11-10.11	77	LAB		0 986 594 506 <sup>4</sup>			
				RAB		0 986 594 507 <sup>4</sup>			
		03.11-11.13	77	LAB		0 986 594 504 <sup>3</sup>			
				RAB		0 986 594 505 <sup>3</sup>			
	11.11-11.13	77	LAB		0 986 594 561 <sup>4</sup>				
			RAB		0 986 594 560 <sup>4</sup>				
	1.4 TSI	03.11-10.11	118	LAB		0 986 594 506 <sup>4</sup>			
				RAB		0 986 594 507 <sup>4</sup>			
		03.11→	118	LAB		0 986 594 504 <sup>3</sup>			
				RAB		0 986 594 505 <sup>3</sup>			
		11.11-11.13	90	LAB		0 986 594 504 <sup>3</sup>			
				RAB		0 986 594 561 <sup>4</sup>			
	PR-Code 1KS				0 986 594 505 <sup>3</sup>				
	PR-Code 1KW				0 986 594 560 <sup>4</sup>				
	1.6 TDI	03.11-10.11	77	LAB		0 986 594 506 <sup>4</sup>			
				RAB		0 986 594 507 <sup>4</sup>			
		03.11-11.13	77	LAB		0 986 594 504 <sup>3</sup>			
				RAB		0 986 594 505 <sup>3</sup>			
		11.11-11.13	77	LAB		0 986 594 561 <sup>4</sup>			
				RAB		0 986 594 560 <sup>4</sup>			
2.0 TDI	11.11→	103/155/	LAB		0 986 594 504 <sup>3</sup>				
			RAB		0 986 594 561 <sup>4</sup>				
2.0 TSI	188/195		LAB		0 986 594 504 <sup>3</sup>				
			RAB		0 986 594 505 <sup>3</sup>				
PR-Code 1KS				0 986 594 560 <sup>4</sup>					
<b>Golf VI Variant [AJ5]</b>									
	1.2 TSI	08.09-04.13	63/77	PR-Code 1LJ, PR-Code 1ZA, PR-Code 1ZE, PR-Code 1ZD, PR-Code 1ZP	288,312	0 986 473 384		53,94	F 026 A06 106 <sup>7</sup>
						0 986 473 384		53,94	1 987 470 506 <sup>B</sup>
						0 986 474 384		53,94	F 026 A06 106 <sup>7</sup>



















































<b>◀ VW Golf VI Variant [AJ5]</b>									
	1.2 TSI	08.09-04.13	63/77	PR-Code 1ZM	228	0986 473 071		54	1987 470 506 <sup>8</sup>
						0986 474 071		54	1987 470 506 <sup>8</sup>
1.4	06.09-04.13	59/90/118	PR-Code 1LJ, PR-Code 1ZA, PR-Code 1ZE, PR-Code 1ZD, PR-Code 1ZP	288,312	0986 473 384		53,94	F 026 A06 106 <sup>7</sup>	
					0986 473 384		53,94	1987 470 506 <sup>8</sup>	
1.4 TSI			PR-Code 1ZM	228	0986 474 384		53,94	F 026 A06 106 <sup>7</sup>	
					0986 473 071		54	1987 470 506 <sup>8</sup>	
1.6	07.09-04.13	66/75/77	PR-Code 1LJ, PR-Code 1ZA, PR-Code 1ZE, PR-Code 1ZD, PR-Code 1ZP	288,312	0986 473 384		53,94	F 026 A06 106 <sup>7</sup>	
					0986 473 384		53,94	1987 470 506 <sup>8</sup>	
1.6 Multifuel					0986 474 384		53,94	F 026 A06 106 <sup>7</sup>	
1.6 MultiFuel					0986 473 071		54	1987 470 506 <sup>8</sup>	
1.6 TDI					0986 474 071		54	1987 470 506 <sup>8</sup>	
1.6 TDI 4Motion					0986 473 384		53,94	F 026 A06 106 <sup>7</sup>	
2.0 TDI	07.09-04.13	81/100/103/147	PR-Code 1LJ, PR-Code 1ZA, PR-Code 1ZE, PR-Code 1ZD, PR-Code 1ZP	288,312	0986 473 384		53,94	F 026 A06 106 <sup>7</sup>	
2.0 TSI					0986 473 384		53,94	1987 470 506 <sup>8</sup>	
					0986 474 384		53,94	F 026 A06 106 <sup>7</sup>	
					0986 473 071		54	1987 470 506 <sup>8</sup>	
					0986 474 071		54	1987 470 506 <sup>8</sup>	
	1.2 TSI	08.09-04.13	63/77	PR-Code 1KE, PR-Code 1KF, PR-Code 1KJ, PR-Code 1KS, PR-Code 1KT		0986 473 448		41	
						0986 474 448		41	
						0986 134 203		38	
						0986 135 203		38	
1.4	06.09-04.13	59/90	PR-Code 1KE, PR-Code 1KF, PR-Code 1KJ		0986 473 448		41		
					0986 474 448		41		
1.4 TSI			PR-Code 1KS, PR-Code 1KT		0986 134 203		38		
					0986 135 203		38		
1.4 TSI	07.09-04.13	118	PR-Code 1KE, PR-Code 1KF, PR-Code 1KJ, PR-Code 1KS, PR-Code 1KT		0986 473 448		41		
					0986 474 448		41		
					0986 134 203		38		
					0986 135 203		38		
	07.12-04.13	118	PR-Code 1KJ		0986 473 448		41	1987 474 496 <sup>8</sup>	
					0986 474 448		41	1987 474 496 <sup>8</sup>	
1.6, Multifuel, MultiFuel, TDI, TDI 4Motion	07.09-04.13	66/75/77	PR-Code 1KE, PR-Code 1KF, PR-Code 1KJ, PR-Code 1KS, PR-Code 1KT		0986 473 448		41		
					0986 474 448		41		
					0986 134 203		38		
					0986 135 203		38		
2.0 TDI	07.09-04.13	81/100/103/147	PR-Code 1KE, PR-Code 1KF, PR-Code 1KJ		0986 473 448		41		
2.0 TSI			PR-Code 1KS, PR-Code 1KT		0986 474 448		41		
					0986 134 203		38		
					0986 135 203		38		
	1.2 TSI	08.09-04.13	63/77		LAB	0986 594 504 <sup>3</sup>		1447	
						0986 594 506 <sup>4</sup>			
					RAB	0986 594 505 <sup>3</sup>			
						0986 594 507 <sup>4</sup>			
1.4	06.09-04.13	59/90/118			LAB	0986 594 504 <sup>3</sup>			
						0986 594 506 <sup>4</sup>			
1.4 TSI					RAB	0986 594 505 <sup>3</sup>			
						0986 594 507 <sup>4</sup>			

			S								
1.6, Multifuel, MultiFuel, TDI, TDI 4Motion	07.09-04.13	66/75/77									
					LAB			0 986 594 504 <sup>3</sup>			
								0 986 594 506 <sup>4</sup>			
					RAB			0 986 594 505 <sup>3</sup>			
								0 986 594 507 <sup>4</sup>			
2.0 TDI	07.09-04.13	81/100/									
2.0 TSI		103/147									
					LAB			0 986 594 504 <sup>3</sup>			
								0 986 594 506 <sup>4</sup>			
					RAB			0 986 594 505 <sup>3</sup>			
								0 986 594 507 <sup>4</sup>			
<b>Golf VI [5K1]</b>											
	1.2 TSI	05.09-11.12	63/77	PR-Code 1LJ, PR-Code 1ZA, PR-Code 1ZE, PR-Code 1ZD, PR-Code 1ZP	288,312			0 986 473 384		← 53,94	F 026 A06 106 <sup>7</sup>
								0 986 473 384		← 53,94	1 987 470 506 <sup>8</sup>
								0 986 474 384		→ 53,94	F 026 A06 106 <sup>7</sup>
				PR-Code 1LL, PR-Code 1LV, PR-Code 1ZB	312			0 986 473 384		← 53,94	F 026 A06 106 <sup>7</sup>
								0 986 473 384		← 53,94	1 987 470 506 <sup>8</sup>
								0 986 474 384		→ 53,94	F 026 A06 106 <sup>7</sup>
				PR-Code 1ZF	228			0 986 473 071		← 54	1 987 470 506 <sup>8</sup>
								0 986 474 071		→ 54	1 987 470 506 <sup>8</sup>
				PR-Code 1ZK				0 986 134 287		←	F 026 A03 545 <sup>7</sup>
								0 986 134 287		←	1 987 470 506 <sup>8</sup>
								0 986 135 287		→	F 026 A03 545 <sup>7</sup>
1.4	1.4 TSI	10.08-11.12	59/90/118	PR-Code 1LJ, PR-Code 1ZA, PR-Code 1ZE, PR-Code 1ZD, PR-Code 1ZP	288,312			0 986 473 384		← 53,94	F 026 A06 106 <sup>7</sup>
								0 986 473 384		← 53,94	1 987 470 506 <sup>8</sup>
								0 986 474 384		→ 53,94	F 026 A06 106 <sup>7</sup>
				PR-Code 1LL, PR-Code 1LV, PR-Code 1ZB	312			0 986 473 384		← 53,94	F 026 A06 106 <sup>7</sup>
								0 986 473 384		← 53,94	1 987 470 506 <sup>8</sup>
								0 986 474 384		→ 53,94	F 026 A06 106 <sup>7</sup>
				PR-Code 1ZF	228			0 986 473 071		← 54	1 987 470 506 <sup>8</sup>
								0 986 474 071		→ 54	1 987 470 506 <sup>8</sup>
				PR-Code 1ZK				0 986 134 287		←	F 026 A03 545 <sup>7</sup>
								0 986 134 287		←	1 987 470 506 <sup>8</sup>
								0 986 135 287		→	F 026 A03 545 <sup>7</sup>
1.6		10.08-11.12	75	PR-Code 1ZF	228			0 986 473 071		← 54	1 987 470 506 <sup>8</sup>
				PR-Code 1ZK				0 986 134 287		←	1 987 470 506 <sup>8</sup>
								0 986 135 287		→	1 987 470 506 <sup>8</sup>
1.6	1.6 MultiFuel	10.08-11.12	75	PR-Code 1LJ, PR-Code 1ZA, PR-Code 1ZE, PR-Code 1ZD, PR-Code 1ZP	288,312			0 986 473 384		← 53,94	F 026 A06 106 <sup>7</sup>
								0 986 473 384		← 53,94	1 987 470 506 <sup>8</sup>
								0 986 474 384		→ 53,94	F 026 A06 106 <sup>7</sup>
				PR-Code 1LL, PR-Code 1LV, PR-Code 1ZB	312			0 986 473 384		← 53,94	F 026 A06 106 <sup>7</sup>
								0 986 473 384		← 53,94	1 987 470 506 <sup>8</sup>
								0 986 474 384		→ 53,94	F 026 A06 106 <sup>7</sup>
				PR-Code 1ZF	228			0 986 474 071		→ 54	1 987 470 506 <sup>8</sup>
				PR-Code 1ZK				0 986 134 287		←	F 026 A03 545 <sup>7</sup>
1.6 BiFuel	1.6 TDI	11.08-11.12	66/72-75	PR-Code 1LJ, PR-Code 1ZA, PR-Code 1ZE, PR-Code 1ZD, PR-Code 1ZP	288,312			0 986 473 384		← 53,94	F 026 A06 106 <sup>7</sup>
								0 986 473 384		← 53,94	1 987 470 506 <sup>8</sup>
								0 986 474 384		→ 53,94	F 026 A06 106 <sup>7</sup>
				PR-Code 1LL, PR-Code 1LV, PR-Code 1ZB	312			0 986 473 384		← 53,94	F 026 A06 106 <sup>7</sup>
								0 986 473 384		← 53,94	1 987 470 506 <sup>8</sup>
								0 986 474 384		→ 53,94	F 026 A06 106 <sup>7</sup>
				PR-Code 1ZF	228			0 986 473 071		← 54	1 987 470 506 <sup>8</sup>
								0 986 474 071		→ 54	1 987 470 506 <sup>8</sup>
				PR-Code 1ZK				0 986 134 287		←	F 026 A03 545 <sup>7</sup>
								0 986 134 287		←	1 987 470 506 <sup>8</sup>
								0 986 135 287		→	F 026 A03 545 <sup>7</sup>
1.6 MultiFuel		10.08-05.10	75					0 986 134 257		←	F 026 A03 545 <sup>7</sup>
								0 986 134 257		←	1 987 470 506 <sup>8</sup>
								0 986 135 257		→	F 026 A03 545 <sup>7</sup>
		10.08-11.12	75	PR-Code 1ZF	228			0 986 473 071		← 54	1 987 470 506 <sup>8</sup>
				PR-Code 1ZK				0 986 134 287		←	1 987 470 506 <sup>8</sup>
								0 986 135 287		→	F 026 A03 545 <sup>7</sup>

			S									
◀ VW Golf VI [5K1]												
1.6 TDI 1.6 TDI 4Motion	12.08-11.12	77	PR-Code 1LJ, PR-Code 1ZA, PR-Code 1ZE, PR-Code 1ZD, PR-Code 1ZP	288,312	0986 473 384		←	53,94	F 026	A06 106 <sup>7</sup>		
					0986 473 384		←	53,94	1 987	470 506 <sup>8</sup>		
					0986 474 384		→	53,94	F 026	A06 106 <sup>7</sup>		
					PR-Code 1LL, PR-Code 1LV, PR-Code 1ZB	312	0986 473 384		←	53,94	F 026	A06 106 <sup>7</sup>
							0986 473 384		←	53,94	1 987	470 506 <sup>8</sup>
					PR-Code 1ZF	228	0986 474 384		→	53,94	F 026	A06 106 <sup>7</sup>
							0986 473 071		←	54	1 987	470 506 <sup>8</sup>
					PR-Code 1ZK		0986 474 071		→	54	1 987	470 506 <sup>8</sup>
							0986 134 287		←		F 026	A03 545 <sup>7</sup>
							0986 134 287		←		1 987	470 506 <sup>8</sup>
					0986 135 287		→		F 026	A03 545 <sup>7</sup>		
1.8 TSI	06.09-01.11	118	PR-Code 1LJ, PR-Code 1ZA, PR-Code 1ZE, PR-Code 1ZD, PR-Code 1ZP	288,312	0986 134 257		←		F 026	A03 545 <sup>7</sup>		
					0986 134 257		←		1 987	470 506 <sup>8</sup>		
					0986 135 257		→		F 026	A03 545 <sup>7</sup>		
					PR-Code 1LL, PR-Code 1LV, PR-Code 1ZB	312	0986 473 384		←	53,94	F 026	A06 106 <sup>7</sup>
							0986 473 384		←	53,94	1 987	470 506 <sup>8</sup>
					PR-Code 1ZF	228	0986 474 384		→	53,94	F 026	A06 106 <sup>7</sup>
							0986 473 071		←	54	1 987	470 506 <sup>8</sup>
					PR-Code 1ZK		0986 474 071		→	54	1 987	470 506 <sup>8</sup>
							0986 134 287		←		F 026	A03 545 <sup>7</sup>
							0986 134 287		←		1 987	470 506 <sup>8</sup>
					0986 135 287		→		F 026	A03 545 <sup>7</sup>		
2.0 GTI 2.0 TSI 4Motion	04.09-11.12	155/173/ 188	PR-Code 1LJ, PR-Code 1ZA, PR-Code 1ZE, PR-Code 1ZD, PR-Code 1ZP	288,312	0986 473 384		←	53,94	F 026	A06 106 <sup>7</sup>		
					0986 473 384		←	53,94	1 987	470 506 <sup>8</sup>		
					0986 474 384		→	53,94	F 026	A06 106 <sup>7</sup>		
					PR-Code 1LL, PR-Code 1LV, PR-Code 1ZB	312	0986 473 384		←	53,94	F 026	A06 106 <sup>7</sup>
							0986 473 384		←	53,94	1 987	470 506 <sup>8</sup>
					PR-Code 1ZF	228	0986 474 384		→	53,94	F 026	A06 106 <sup>7</sup>
							0986 473 071		←	54	1 987	470 506 <sup>8</sup>
					PR-Code 1ZK		0986 474 071		→	54	1 987	470 506 <sup>8</sup>
							0986 134 287		←		F 026	A03 545 <sup>7</sup>
							0986 134 287		←		1 987	470 506 <sup>8</sup>
					0986 135 287		→		F 026	A03 545 <sup>7</sup>		
2.0 TDI	10.08-11.09	100	PR-Code 1LL, PR-Code 1LV, PR-Code 1ZB	312	0986 134 257		←		F 026	A03 545 <sup>7</sup>		
					0986 134 257		←		1 987	470 506 <sup>8</sup>		
					0986 135 257		→		F 026	A03 545 <sup>7</sup>		
					0986 474 384		→	53,94	1 987	470 506 <sup>8</sup>		
					10.08-11.12	81	PR-Code 1LJ, PR-Code 1ZA, PR-Code 1ZE, PR-Code 1ZD, PR-Code 1ZP	288,312	0986 473 384		←	53,94
	0986 473 384		←	53,94					1 987	470 506 <sup>8</sup>		
	0986 474 384		→	53,94					F 026	A06 106 <sup>7</sup>		
	PR-Code 1LL, PR-Code 1LV, PR-Code 1ZB	312	0986 473 384						←	53,94	F 026	A06 106 <sup>7</sup>
			0986 473 384						←	53,94	1 987	470 506 <sup>8</sup>
	PR-Code 1ZF	228	0986 474 384		→	53,94	F 026	A06 106 <sup>7</sup>				
0986 473 071				←	54	1 987	470 506 <sup>8</sup>					
PR-Code 1ZK		0986 474 071		→	54	1 987	470 506 <sup>8</sup>					
		0986 134 287		←		F 026	A03 545 <sup>7</sup>					
		0986 134 287		←		1 987	470 506 <sup>8</sup>					
					0986 135 287		→		F 026	A03 545 <sup>7</sup>		
100		PR-Code 1LJ, PR-Code 1ZA, PR-Code 1ZE, PR-Code 1ZD, PR-Code 1ZP	288,312	0986 473 384		←	53,94	F 026	A06 106 <sup>7</sup>			
				0986 473 384		←	53,94	1 987	470 506 <sup>8</sup>			
				0986 474 384		→	53,94	F 026	A06 106 <sup>7</sup>			
				PR-Code 1LL, PR-Code 1LV, PR-Code 1ZB	312	0986 473 384		←	53,94	F 026	A06 106 <sup>7</sup>	
						0986 473 384		←	53,94	1 987	470 506 <sup>8</sup>	
				PR-Code 1ZF	228	0986 474 384		→	53,94	F 026	A06 106 <sup>7</sup>	
						0986 473 071		←	54	1 987	470 506 <sup>8</sup>	
				PR-Code 1ZK		0986 474 071		→	54	1 987	470 506 <sup>8</sup>	
						0986 134 287		←		F 026	A03 545 <sup>7</sup>	
						0986 134 287		←		1 987	470 506 <sup>8</sup>	
					0986 135 287		→		F 026	A03 545 <sup>7</sup>		











		S							
<b>2.0 TDI</b>		04.09-05.10	125	PR-Code 1LJ, PR-Code 1ZA, 288,312	0 986 474 384	 → 53,94	1 987 470 506 <sup>B</sup>		
				PR-Code 1ZE, PR-Code 1ZD, PR-Code 1ZP					
				PR-Code 1LL, PR-Code 1LV, 312	0 986 474 384	 → 53,94	1 987 470 506 <sup>B</sup>		
		04.09-11.12	125	PR-Code 1ZB					
				PR-Code 1LJ, PR-Code 1ZA, 288,312	0 986 473 384	 ← 53,94	F 026 A06 106 <sup>7</sup>		
				PR-Code 1ZE, PR-Code 1ZD, PR-Code 1ZP	0 986 474 384	 → 53,94	F 026 A06 106 <sup>7</sup>		
				PR-Code 1LL, PR-Code 1LV, 312	0 986 473 384	 ← 53,94	F 026 A06 106 <sup>7</sup>		
				PR-Code 1ZB	0 986 474 384	 → 53,94	F 026 A06 106 <sup>7</sup>		
				PR-Code 1ZF	228	0 986 473 071	 ← 54	1 987 470 506 <sup>B</sup>	
				PR-Code 1ZK		0 986 474 071	 → 54	1 987 470 506 <sup>B</sup>	
		11.09-11.12	100	PR-Code 1LL, PR-Code 1LV, 312	0 986 474 384	 → 53,94	F 026 A06 106 <sup>7</sup>		
				PR-Code 1ZB					
				125	PR-Code 1LJ, PR-Code 1ZA, 288,312	0 986 473 384	 ← 53,94	1 987 470 506 <sup>B</sup>	
		<b>2.0 TDI</b> <b>2.0 TDI 4Motion</b>		10.08-11.09	103	PR-Code 1ZE, PR-Code 1ZD, PR-Code 1ZP	0 986 473 384	 ← 53,94	1 987 470 506 <sup>B</sup>
						PR-Code 1LL, PR-Code 1LV, 312	0 986 473 384	 ← 53,94	1 987 470 506 <sup>B</sup>
PR-Code 1ZB									
10.08-11.12	103			PR-Code 1LJ, PR-Code 1ZA, 288,312	0 986 134 257	 ←	F 026 A03 545 <sup>7</sup>		
				PR-Code 1ZE, PR-Code 1ZD, PR-Code 1ZP	0 986 134 257	 ←	1 987 470 506 <sup>B</sup>		
				PR-Code 1LL, PR-Code 1LV, 312	0 986 135 257	 →	F 026 A03 545 <sup>7</sup>		
				PR-Code 1ZB					
				PR-Code 1ZF	228	0 986 473 384	 ← 53,94	F 026 A06 106 <sup>7</sup>	
				PR-Code 1ZK		0 986 473 384	 → 53,94	F 026 A06 106 <sup>7</sup>	
				PR-Code 1ZB		0 986 473 384	 ← 53,94	1 987 470 506 <sup>B</sup>	
				PR-Code 1ZB		0 986 473 384	 ← 53,94	1 987 470 506 <sup>B</sup>	
				PR-Code 1ZF	228	0 986 473 071	 ← 54	1 987 470 506 <sup>B</sup>	
				PR-Code 1ZK		0 986 474 071	 → 54	1 987 470 506 <sup>B</sup>	
				PR-Code 1ZK		0 986 134 287	 ←	F 026 A03 545 <sup>7</sup>	
				PR-Code 1ZK		0 986 134 287	 ←	1 987 470 506 <sup>B</sup>	
<b>2.0 TSI 4Motion</b>		11.09-05.11	195	PR-Code 1LJ, PR-Code 1ZA, 288,312	0 986 135 287	 →	F 026 A03 545 <sup>7</sup>		
				PR-Code 1ZE, PR-Code 1ZD, PR-Code 1ZP					
				PR-Code 1LL, PR-Code 1LV, 312	0 986 134 257	 ←	F 026 A03 545 <sup>7</sup>		
		11.09-11.12	199	PR-Code 1ZB	0 986 134 257	 ←	1 987 470 506 <sup>B</sup>		
				PR-Code 1ZB	0 986 135 257	 →	F 026 A03 545 <sup>7</sup>		
				PR-Code 1LJ, PR-Code 1ZA, 288,312	0 986 473 384	 ← 53,94	F 026 A06 106 <sup>7</sup>		
				PR-Code 1ZE, PR-Code 1ZD, PR-Code 1ZP	0 986 473 384	 ← 53,94	1 987 470 506 <sup>B</sup>		
				PR-Code 1LL, PR-Code 1LV, 312	0 986 474 384	 → 53,94	F 026 A06 106 <sup>7</sup>		
				PR-Code 1ZB		0 986 473 384	 ← 53,94	F 026 A06 106 <sup>7</sup>	
				PR-Code 1ZB		0 986 473 384	 ← 53,94	1 987 470 506 <sup>B</sup>	
				PR-Code 1ZB		0 986 474 384	 → 53,94	F 026 A06 106 <sup>7</sup>	
				PR-Code 1ZF	228	0 986 473 071	 ← 54	1 987 470 506 <sup>B</sup>	
				PR-Code 1ZK		0 986 474 071	 → 54	1 987 470 506 <sup>B</sup>	
				PR-Code 1ZK		0 986 134 287	 ←	F 026 A03 545 <sup>7</sup>	
				PR-Code 1ZK		0 986 134 287	 ←	1 987 470 506 <sup>B</sup>	
PR-Code 1ZK		0 986 135 287	 →	F 026 A03 545 <sup>7</sup>					
05.09-10.09	77	PR-Code 1KE, PR-Code 1KF	256	0 986 473 448	 ← 41	1 987 474 496 <sup>B</sup>			
				0 986 474 448	 → 41	1 987 474 496 <sup>B</sup>			



		S									
	◀ VW Golf VI [5K1]										
1.2 TSI	05.09-10.09	77	PR-Code 1KZ				0986 134 048		38	1987 474 496 <sup>8</sup>	
							0986 135 048		38	1987 474 496 <sup>8</sup>	
	05.09-11.12	77	PR-Code 1KD	D53				0986 473 381		38,1	1987 470 040 <sup>7</sup>
								0986 473 381		38,1	1987 474 496 <sup>8</sup>
								0986 474 381		38,1	1987 470 040 <sup>7</sup>
								0986 134 244			1987 474 496 <sup>8</sup>
			PR-Code 1KY, PR-Code 1KV					0986 135 244			1987 474 496 <sup>8</sup>
	11.09-11.12	77	PR-Code 1KS					0986 134 203		38	
								0986 135 203			
	05.10-11.12	63	PR-Code 1KD	D53				0986 473 381		38,1	1987 470 040 <sup>7</sup>
								0986 473 381		38,1	1987 474 496 <sup>8</sup>
0986 474 381									38,1	1987 470 040 <sup>7</sup>	
PR-Code 1KS			0986 134 203						38		
			0986 135 203								
PR-Code 1KY, PR-Code 1KV	0986 134 244			1987 474 496 <sup>8</sup>							
	0986 135 244			1987 474 496 <sup>8</sup>							
1.4 1.4 TSI	10.08-10.09	59/90/118	PR-Code 1KE, PR-Code 1KF	256			0986 473 448		41	1987 474 496 <sup>8</sup>	
							0986 474 448		41	1987 474 496 <sup>8</sup>	
							0986 134 048		38	1987 474 496 <sup>8</sup>	
	10.08-11.12	59/90/118	PR-Code 1KD	D53				0986 473 381		38,1	1987 470 040 <sup>7</sup>
								0986 473 381		38,1	1987 474 496 <sup>8</sup>
								0986 474 381		38,1	1987 470 040 <sup>7</sup>
			PR-Code 1KY, PR-Code 1KV					0986 134 244			1987 474 496 <sup>8</sup>
								0986 135 244			1987 474 496 <sup>8</sup>
	11.09-11.12	59/90/118	PR-Code 1KS					0986 134 203		38	
								0986 135 203			
	1.6	10.08-11.12	75	PR-Code 1KD	D53			0986 473 381		38,1	1987 470 040 <sup>7</sup>
0986 473 381									38,1	1987 474 496 <sup>8</sup>	
0986 474 381									38,1	1987 470 040 <sup>7</sup>	
PR-Code 1KY, PR-Code 1KV				0986 134 244						1987 474 496 <sup>8</sup>	
				0986 135 244						1987 474 496 <sup>8</sup>	
1.6 1.6 MultiFuel	10.08-10.09	75	PR-Code 1KE, PR-Code 1KF	256			0986 473 448		41	1987 474 496 <sup>8</sup>	
							0986 474 448		41	1987 474 496 <sup>8</sup>	
							0986 134 048		38	1987 474 496 <sup>8</sup>	
	11.09-11.12	75	PR-Code 1KZ					0986 135 048		38	1987 474 496 <sup>8</sup>
								0986 134 048		38	1987 474 496 <sup>8</sup>
								0986 135 048		38	1987 474 496 <sup>8</sup>
			PR-Code 1KS					0986 134 203		38	
								0986 135 203			
	1.6 BiFuel 1.6 TDI	11.08-10.09	66/72-75	PR-Code 1KE, PR-Code 1KF	256			0986 473 448		41	1987 474 496 <sup>8</sup>
								0986 474 448		41	1987 474 496 <sup>8</sup>
								0986 134 048		38	1987 474 496 <sup>8</sup>
11.08-11.12		66/72-75	PR-Code 1KD	D53				0986 135 048		38	1987 474 496 <sup>8</sup>
								0986 473 381		38,1	1987 470 040 <sup>7</sup>
								0986 474 381		38,1	1987 474 496 <sup>8</sup>
	PR-Code 1KY, PR-Code 1KV		0986 134 244							1987 474 496 <sup>8</sup>	
			0986 135 244							1987 474 496 <sup>8</sup>	
11.09-11.12	66/72-75	PR-Code 1KS					0986 134 203		38		
							0986 135 203				
1.6 MultiFuel	10.08-05.10	75	PR-Code 1KD				0986 473 381		38,1	1987 470 040 <sup>7</sup>	
							0986 473 381		38,1	1987 474 496 <sup>8</sup>	
							0986 474 381		38,1	1987 470 040 <sup>7</sup>	
	10.08-11.12	75	PR-Code 1KY, PR-Code 1KV					0986 134 244			1987 474 496 <sup>8</sup>
								0986 135 244			1987 474 496 <sup>8</sup>
	05.10-11.12	75	PR-Code 1KD	D53				0986 473 381		38,1	1987 470 040 <sup>7</sup>
								0986 473 381		38,1	1987 474 496 <sup>8</sup>
								0986 474 381		38,1	1987 470 040 <sup>7</sup>
1.6 TDI	12.08-10.09	77	PR-Code 1KE, PR-Code 1KF	256			0986 473 448		41	1987 474 496 <sup>8</sup>	
							0986 474 448		41	1987 474 496 <sup>8</sup>	
							0986 134 048		38	1987 474 496 <sup>8</sup>	
			PR-Code 1KZ				0986 135 048		38	1987 474 496 <sup>8</sup>	



		S							
<b>1.6 TDI</b>	12.08-11.12	77	PR-Code 1KD	D53	0 986 473 381	← 38,1	1 987 470 040 <sup>7</sup>		
					0 986 473 381	← 38,1	1 987 474 496 <sup>8</sup>		
					0 986 474 381	→ 38,1	1 987 470 040 <sup>7</sup>		
			PR-Code 1KY, PR-Code 1KV		0 986 134 244	←	1 987 474 496 <sup>8</sup>		
					0 986 135 244	→	1 987 474 496 <sup>8</sup>		
			11.09-11.12		77	PR-Code 1KS	0 986 134 203	← 38	
				0 986 135 203	→ 38				
<b>1.6 TDI 4Motion</b>	12.08-10.09	77	PR-Code 1KE, PR-Code 1KF	256	0 986 473 448	← 41	1 987 474 496 <sup>8</sup>		
					0 986 474 448	→ 41	1 987 474 496 <sup>8</sup>		
	12.08-11.12	77	PR-Code 1KW	B31			1 987 474 496 <sup>8</sup>		
	11.09-11.12	77	PR-Code 1KS		0 986 134 203	← 38			
				0 986 135 203	→ 38				
<b>1.8 TSI</b>	06.09-10.09	118	PR-Code 1KE, PR-Code 1KF	256	0 986 473 448	← 41	1 987 474 496 <sup>8</sup>		
					0 986 474 448	→ 41	1 987 474 496 <sup>8</sup>		
			PR-Code 1KZ		0 986 134 048	← 38	1 987 474 496 <sup>8</sup>		
					0 986 135 048	→ 38	1 987 474 496 <sup>8</sup>		
	06.09-01.11	118	PR-Code 1KD	D53	0 986 473 381	← 38,1	1 987 470 040 <sup>7</sup>		
					0 986 473 381	← 38,1	1 987 474 496 <sup>8</sup>		
					0 986 474 381	→ 38,1	1 987 470 040 <sup>7</sup>		
					PR-Code 1KY, PR-Code 1KV		0 986 134 244	←	1 987 474 496 <sup>8</sup>
					0 986 135 244	→	1 987 474 496 <sup>8</sup>		
	11.09-01.11		118	PR-Code 1KS		0 986 134 203	← 38		
					0 986 135 203	→ 38			
	<b>2.0 GTI</b>	04.09-10.09	155	PR-Code 1KE, PR-Code 1KF	256	0 986 473 448	← 41	1 987 474 496 <sup>8</sup>	
0 986 474 448						→ 41	1 987 474 496 <sup>8</sup>		
PR-Code 1KY, PR-Code 1KV				0 986 134 244		←	1 987 474 496 <sup>8</sup>		
				0 986 135 244		→	1 987 474 496 <sup>8</sup>		
PR-Code 1KZ		0 986 134 048	← 38	1 987 474 496 <sup>8</sup>					
		0 986 135 048	→ 38	1 987 474 496 <sup>8</sup>					
04.09-11.12		155	PR-Code 1KD	D53	0 986 473 381	← 38,1	1 987 470 040 <sup>7</sup>		
					0 986 473 381	← 38,1	1 987 474 496 <sup>8</sup>		
					0 986 474 381	→ 38,1	1 987 470 040 <sup>7</sup>		
					PR-Code 1KY, PR-Code 1KV		0 986 134 244	←	1 987 474 496 <sup>8</sup>
				0 986 135 244	→	1 987 474 496 <sup>8</sup>			
11.09-11.12		155	PR-Code 1KS		0 986 134 203	← 38			
				0 986 135 203	→ 38				
05.11-11.12	173	PR-Code 1KD	D53	0 986 473 381	← 38,1	1 987 470 040 <sup>7</sup>			
				0 986 473 381	← 38,1	1 987 474 496 <sup>8</sup>			
				0 986 474 381	→ 38,1	1 987 470 040 <sup>7</sup>			
				PR-Code 1KS		0 986 134 203	← 38		
						0 986 135 203	→ 38		
		PR-Code 1KY, PR-Code 1KV		0 986 134 244	←	1 987 474 496 <sup>8</sup>			
						0 986 135 244	→	1 987 474 496 <sup>8</sup>	
		PR-Code 1KZ		0 986 134 048	← 38	1 987 474 496 <sup>8</sup>			
				0 986 135 048	→ 38	1 987 474 496 <sup>8</sup>			
<b>2.0 TDI</b>	10.08-10.09	81/100	PR-Code 1KE, PR-Code 1KF	256	0 986 473 448	← 41	1 987 474 496 <sup>8</sup>		
					0 986 474 448	→ 41	1 987 474 496 <sup>8</sup>		
			PR-Code 1KZ		0 986 134 048	← 38	1 987 474 496 <sup>8</sup>		
					0 986 135 048	→ 38	1 987 474 496 <sup>8</sup>		
	103	PR-Code 1KE, PR-Code 1KF	256	0 986 473 448	← 41	1 987 474 496 <sup>8</sup>			
				0 986 474 448	→ 41	1 987 474 496 <sup>8</sup>			
				PR-Code 1KZ		0 986 134 048	← 38	1 987 474 496 <sup>8</sup>	
						0 986 135 048	→ 38	1 987 474 496 <sup>8</sup>	
	10.08-11.09	103	PR-Code 1KD	D53	0 986 473 381	← 38,1	1 987 470 040 <sup>7</sup>		
					0 986 473 381	← 38,1	1 987 474 496 <sup>8</sup>		
					0 986 474 381	→ 38,1	1 987 470 040 <sup>7</sup>		
	10.08-05.11	81/100	PR-Code 1KD	D53	0 986 473 381	← 38,1	1 987 470 040 <sup>7</sup>		
					0 986 473 381	← 38,1	1 987 474 496 <sup>8</sup>		
					0 986 474 381	→ 38,1	1 987 470 040 <sup>7</sup>		
	10.08-11.12	81/100	PR-Code 1KY, PR-Code 1KV		0 986 134 244	←	1 987 474 496 <sup>8</sup>		
					0 986 135 244	→	1 987 474 496 <sup>8</sup>		
103		PR-Code 1KY, PR-Code 1KV			0 986 134 244	←	1 987 474 496 <sup>8</sup>		
					0 986 135 244	→	1 987 474 496 <sup>8</sup>		
04.09-10.09	125	PR-Code 1KE, PR-Code 1KF	256	0 986 473 448	← 41	1 987 474 496 <sup>8</sup>			
				0 986 474 448	→ 41	1 987 474 496 <sup>8</sup>			
		PR-Code 1KZ		0 986 134 048	← 38	1 987 474 496 <sup>8</sup>			
				0 986 135 048	→ 38	1 987 474 496 <sup>8</sup>			



		S														
	◀ VW Golf VI [5K1]															
	2.0 TDI	04.09-05.10	125	PR-Code 1KD			0986 473 381		38,1	1987 470 040 <sup>7</sup>						
							0986 473 381		38,1	1987 474 496 <sup>8</sup>						
							0986 474 381		38,1	1987 470 040 <sup>7</sup>						
		04.09-11.12	125	PR-Code 1KY, PR-Code 1KV				0986 134 244			1987 474 496 <sup>8</sup>					
								0986 135 244			1987 474 496 <sup>8</sup>					
		09.09-11.12	103	PR-Code 1KD	D53			0986 473 381		38,1	1987 470 040 <sup>7</sup>					
								0986 473 381		38,1	1987 474 496 <sup>8</sup>					
								0986 474 381		38,1	1987 470 040 <sup>7</sup>					
		11.09-11.12	81/100	PR-Code 1KD	D53			0986 473 381		38,1	1987 470 040 <sup>7</sup>					
								0986 473 381		38,1	1987 474 496 <sup>8</sup>					
								0986 474 381		38,1	1987 470 040 <sup>7</sup>					
								PR-Code 1KS			0986 134 203		38			
								0986 135 203		38						
								103	PR-Code 1KS			0986 134 203		38		
		125	PR-Code 1KD	D53				0986 473 381		38,1	1987 470 040 <sup>7</sup>					
								0986 473 381		38,1	1987 474 496 <sup>8</sup>					
								0986 474 381		38,1	1987 470 040 <sup>7</sup>					
								PR-Code 1KS			0986 134 203		38			
								0986 135 203		38						
								PR-Code 1KS			0986 135 203		38			
		2.0 TDI 4Motion	10.08-10.09	103	PR-Code 1KE, PR-Code 1KF	256			0986 473 448		41	1987 474 496 <sup>8</sup>				
									0986 474 448		41	1987 474 496 <sup>8</sup>				
			10.08-11.09	103		B31						1987 474 496 <sup>8</sup>				
			11.09-11.12	103	PR-Code 1KS				0986 134 203		38					
2.0 TSI 4Motion	11.09-05.11	195	PR-Code 1KW	B31						1987 474 496 <sup>8</sup>						
							PR-Code 1KS			0986 134 203		38				
							0986 135 203		38							
							11.09-11.12	188	PR-Code 1KS			0986 134 203		38		
							0986 135 203		38							
							PR-Code 1KW	B31							1987 474 496 <sup>8</sup>	
199	PR-Code 1KS						0986 134 203		38							
							0986 135 203		38							
							PR-Code 1KW	B31							1987 474 496 <sup>8</sup>	
	1.2 TSI	05.09-11.12	63/77				1987 477 958		1447							
							1.4	10.08-11.12	59/90/118	1987 477 958		1447				
							1.4 TSI	10.08-11.12	59/90/118	1987 477 958		1447				
							1.6	10.08-11.12	66/72-75/77	1987 477 958		1447				
							1.6 BiFuel	11.08-11.12	66/72-75/77	1987 477 958		1447				
							1.6 MultiFuel	10.08-11.12	66/72-75/77	1987 477 958		1447				
							1.6 TDI	12.08-11.12	66/72-75/77	1987 477 958		1447				
							1.6 TDI 4Motion	12.08-11.12	66/72-75/	1987 477 958		1447				
							1.8 TSI	06.09-01.11	118	1987 477 958		1447				
							2.0 GTI	04.09-11.12	81/100/103/125/155/173/188/195/199	1987 477 958		1447				
							2.0 TDI	10.08-11.12	81/100/103/125/155/173/188/195/199	1987 477 958		1447				
							2.0 TDI 4Motion	10.08-11.12	81/100/103/125/155/173/188/195/199	1987 477 958		1447				
							2.0 TSI 4Motion	11.09-11.12	81/100/103/125/155/173/188/195/199	1987 477 958		1447				
								1.2 TSI	05.09-11.12	63/77		LAB	0986 594 504 <sup>3</sup>			
													0986 594 506 <sup>4</sup>			
													RAB	0986 594 505 <sup>3</sup>		
													0986 594 507 <sup>4</sup>			
													1.4	10.08-11.12	59/90/118	LAB
1.4 TSI			RAB	0986 594 505 <sup>3</sup>												
				0986 594 507 <sup>4</sup>												

<b>1.6</b>	10.08-11.12	66/72-75			LAB	0 986 594 504 <sup>3</sup>		
<b>1.6 BiFuel</b>						0 986 594 506 <sup>4</sup>		
<b>1.6 MultiFuel</b>					RAB	0 986 594 505 <sup>3</sup>		
<b>1.6 TDI</b>						0 986 594 507 <sup>4</sup>		
<b>1.6 TDI</b>	12.08-11.12	77			LAB	0 986 594 504 <sup>3</sup>		
						0 986 594 506 <sup>4</sup>		
					RAB	0 986 594 505 <sup>3</sup>		
						0 986 594 507 <sup>4</sup>		
<b>1.6 TDI 4Motion</b>	12.08-11.12	77			LAB	0 986 594 504		
					RAB	0 986 594 505		
<b>1.8 TSI</b>	06.09-01.11	118			LAB	0 986 594 504 <sup>3</sup>		
						0 986 594 506 <sup>4</sup>		
					RAB	0 986 594 505 <sup>3</sup>		
						0 986 594 507 <sup>4</sup>		
<b>2.0 GTI</b>	04.09-11.12	125/155/			LAB	0 986 594 504 <sup>3</sup>		
<b>2.0 TDI</b>		173				0 986 594 506 <sup>4</sup>		
					RAB	0 986 594 505 <sup>3</sup>		
						0 986 594 507 <sup>4</sup>		
<b>2.0 TDI</b>	10.08-11.09	103			LAB	0 986 594 504		
					RAB	0 986 594 505		
	10.08-11.12	81/100			LAB	0 986 594 504 <sup>3</sup>		
						0 986 594 506 <sup>4</sup>		
					RAB	0 986 594 505 <sup>3</sup>		
						0 986 594 507 <sup>4</sup>		
		103			LAB	0 986 594 504 <sup>3</sup>		
						0 986 594 506 <sup>4</sup>		
					RAB	0 986 594 505 <sup>3</sup>		
						0 986 594 507 <sup>4</sup>		
<b>2.0 TDI 4Motion</b>	10.08-11.12	103			LAB	0 986 594 504		
					RAB	0 986 594 505		
<b>2.0 TSI 4Motion</b>	11.09-11.12	188/195/			LAB	0 986 594 504		
		199			RAB	0 986 594 505		
<b>Golf VII Variant [BA5]</b>								
	<b>1.2 TSI</b>	05.13→	63/77/81		LAB	0 986 594 500 <sup>3</sup>		
	<b>1.2 TSI MultiFuel</b>				RAB	0 986 594 501 <sup>3</sup>		
				PR-Code 8T0, PR-Code 8T2, PR-Code 8T6	FPA	0 986 594 526 <sup>4</sup>		
	<b>1.4 TGI</b>	04.13→	81/90/92/		LAB	0 986 594 500 <sup>3</sup>		
	<b>1.4 TSI</b>		103/110		RAB	0 986 594 501 <sup>3</sup>		
	<b>1.4 TSI Multifuel</b>			PR-Code 8T0, PR-Code 8T2, PR-Code 8T6	FPA	0 986 594 526 <sup>4</sup>		
	<b>1.6</b>	05.13→	77/81		RAB	0 986 594 501 <sup>3</sup>		
	<b>1.6 TDI</b>			PR-Code 8T0, PR-Code 8T2, PR-Code 8T6	FPA	0 986 594 526 <sup>4</sup>		
	<b>1.6, TDI, TDI 4Motion</b>	05.13→	77/81		LAB	0 986 594 500 <sup>3</sup>		
	<b>1.6 TDI</b>	05.13→	66		LAB	0 986 594 500 <sup>3</sup>		
					RAB	0 986 594 501 <sup>3</sup>		
				PR-Code 8T0, PR-Code 8T2, PR-Code 8T6	FPA	0 986 594 526 <sup>4</sup>		
	<b>1.6 TDI 4Motion</b>	05.13→	77/81		FPA,LAB	0 986 594 524 <sup>4</sup>		
					FPA,RAB	0 986 594 525 <sup>4</sup>		
					RAB	0 986 594 501 <sup>3</sup>		
				PR-Code 8T0, PR-Code 8T2, PR-Code 8T6	FPA,LAB	0 986 594 504 <sup>4</sup>		
					FPA,RAB	0 986 594 505 <sup>4</sup>		
				PR-Code 8T3, PR-Code 8T5,	FPA,LAB	0 986 594 524 <sup>4</sup>		
				PR-Code 8T7, PR-Code 8T8	FPA,RAB	0 986 594 525 <sup>4</sup>		
	<b>2.0 R-Line 4Motion</b>	03.15→	208/221		FPA,LAB	0 986 594 524 <sup>4</sup>		
					FPA,RAB	0 986 594 525 <sup>4</sup>		
					LAB	0 986 594 500 <sup>3</sup>		
					RAB	0 986 594 501 <sup>3</sup>		





<b>VW Golf VII Variant [BA5]</b>									
<b>2.0 R-Line 4Motion</b>	03.15→	208/221	PR-Code 8T0, PR-Code 8T2, PR-Code 8T6	FPA,LAB	0 986 594 504 <sup>4</sup>				
				FPA,RAB	0 986 594 505 <sup>4</sup>				
				FPA,LAB	0 986 594 524 <sup>4</sup>				
				FPA,RAB	0 986 594 525 <sup>4</sup>				
<b>2.0 TDI</b>	04.13→	110	PR-Code 8T0, PR-Code 8T2, PR-Code 8T6	RAB	0 986 594 501 <sup>3</sup>				
				FPA	0 986 594 526 <sup>4</sup>				
	05.13→	81		LAB	0 986 594 500 <sup>3</sup>				
				RAB	0 986 594 501 <sup>3</sup>				
	11.14→	135		FPA	0 986 594 526 <sup>4</sup>				
				LAB	0 986 594 500 <sup>3</sup>				
					RAB	0 986 594 501 <sup>3</sup>			
					FPA	0 986 594 526 <sup>4</sup>			
<b>2.0 TDI, TDI 4Motion</b>	04.13→	110		LAB	0 986 594 500 <sup>3</sup>				
<b>2.0 TDI 4Motion</b>	04.13→	110		FPA,LAB	0 986 594 524 <sup>4</sup>				
				FPA,RAB	0 986 594 525 <sup>4</sup>				
				RAB	0 986 594 501 <sup>3</sup>				
				FPA,LAB	0 986 594 504 <sup>4</sup>				
				FPA,RAB	0 986 594 505 <sup>4</sup>				
				FPA,LAB	0 986 594 524 <sup>4</sup>				
				FPA,RAB	0 986 594 525 <sup>4</sup>				
				FPA,LAB	0 986 594 504 <sup>4</sup>				
				FPA,RAB	0 986 594 505 <sup>4</sup>				
				FPA,LAB	0 986 594 524 <sup>4</sup>				
				FPA,RAB	0 986 594 525 <sup>4</sup>				

**Golf VII [5G1]**

<b>Golf VII [5G1]</b>								
<b>1.2 TSI</b>	08.12→	63/77/81		LAB	0 986 594 500 <sup>3</sup>			
				RAB	0 986 594 501 <sup>3</sup>			
				FPA	0 986 594 526 <sup>4</sup>			
<b>1.4 GTE, TGI, TSI, TSI ACT, TSI MultiFuel</b>	08.12→	81/90/92/ 103/ 110-150	PR-Code 8T0, PR-Code 8T2, PR-Code 8T6	LAB	0 986 594 500 <sup>3</sup>			
				RAB	0 986 594 501 <sup>3</sup>			
				FPA	0 986 594 526 <sup>4</sup>			
<b>1.6</b>	08.12→	77/81		RAB	0 986 594 501 <sup>3</sup>			
<b>1.6 TDI</b>				FPA	0 986 594 526 <sup>4</sup>			
<b>1.6, TDI, TDI 4Motion</b>	08.12→	77/81		LAB	0 986 594 500 <sup>3</sup>			
<b>1.6 TDI</b>	04.13→	66		LAB	0 986 594 500 <sup>3</sup>			
				RAB	0 986 594 501 <sup>3</sup>			
				FPA	0 986 594 526 <sup>4</sup>			
<b>1.6 TDI 4Motion</b>	11.12→	77/81		FPA,LAB	0 986 594 524 <sup>4</sup>			
				RAB	0 986 594 501 <sup>3</sup>			
				FPA,LAB	0 986 594 504 <sup>4</sup>			
				FPA,RAB	0 986 594 505 <sup>4</sup>			
				FPA,LAB	0 986 594 524 <sup>4</sup>			
				FPA,RAB	0 986 594 525 <sup>4</sup>			
<b>2.0 GTD</b>	04.13→	135/162		LAB	0 986 594 500 <sup>3</sup>			
<b>2.0 GTI</b>				RAB	0 986 594 501 <sup>3</sup>			
				FPA	0 986 594 526 <sup>4</sup>			
<b>2.0 GTI 4Motion</b>	04.13→	169		FPA,LAB	0 986 594 524 <sup>4</sup>			
				RAB	0 986 594 501 <sup>3</sup>			
				LAB	0 986 594 500 <sup>3</sup>			
				FPA,LAB	0 986 594 504 <sup>4</sup>			
				FPA,RAB	0 986 594 505 <sup>4</sup>			
				FPA,LAB	0 986 594 524 <sup>4</sup>			
				FPA,RAB	0 986 594 525 <sup>4</sup>			
				FPA,LAB	0 986 594 504 <sup>4</sup>			
				FPA,RAB	0 986 594 505 <sup>4</sup>			
				FPA,LAB	0 986 594 524 <sup>4</sup>			
				FPA,RAB	0 986 594 525 <sup>4</sup>			

	S							
2.0 R-Line 4Motion	11.13→	206/221	FPA,LAB	0 986 594 524 <sup>4</sup>				
			FPA,RAB	0 986 594 525 <sup>4</sup>				
			LAB	0 986 594 500 <sup>3</sup>				
			RAB	0 986 594 501 <sup>3</sup>				
			PR-Code 8T0, PR-Code 8T2, PR-Code 8T6	FPA,LAB	0 986 594 504 <sup>4</sup>			
				FPA,RAB	0 986 594 505 <sup>4</sup>			
			PR-Code 8T3, PR-Code 8T5, PR-Code 8T7, PR-Code 8T8	FPA,LAB	0 986 594 524 <sup>4</sup>			
				FPA,RAB	0 986 594 525 <sup>4</sup>			
2.0 TDI	08.12→	81/105	LAB	0 986 594 500 <sup>3</sup>				
			RAB	0 986 594 501 <sup>3</sup>				
			PR-Code 8T0, PR-Code 8T2, PR-Code 8T6	FPA	0 986 594 526 <sup>4</sup>			
			110	RAB	0 986 594 501 <sup>3</sup>			
			PR-Code 8T0, PR-Code 8T2, PR-Code 8T6	FPA	0 986 594 526 <sup>4</sup>			
2.0 TDI, TDI 4Motion	08.12→	110	LAB	0 986 594 500 <sup>3</sup>				
2.0 TDI 4Motion	11.12→	110	FPA,LAB	0 986 594 524 <sup>4</sup>				
				0 986 594 525 <sup>4</sup>				
			RAB	0 986 594 501 <sup>3</sup>				
			PR-Code 8T0, PR-Code 8T2, PR-Code 8T6	FPA,LAB	0 986 594 504 <sup>4</sup>			
				FPA,RAB	0 986 594 505 <sup>4</sup>			
			PR-Code 8T3, PR-Code 8T5, PR-Code 8T7, PR-Code 8T8	FPA,LAB	0 986 594 524 <sup>4</sup>			
	FPA,RAB	0 986 594 525 <sup>4</sup>						

**Jetta**

	1.6 CEX, GEX	10.98-07.08	53/64			0 986 473 663		← 48
	1.6 i CI, GI, CIX, GIX					0 986 474 663		→ 48
	1.6 CEX, GEX	10.98-07.08	53/64			0 986 475 260		↔ 17,46
	1.6 i CI, GI, CIX, GIX					0 986 475 290		↔ 14,29
	1.6 CEX, GEX	10.98-07.08	53/64			0 986 594 003 <sup>4</sup>		
	1.6 i CI, GI, CIX, GIX			LAB	0 986 594 001 <sup>3</sup>			
				RAB	0 986 594 000 <sup>3</sup>			

**Jetta [AV2]**

	1.4 TSI	03.13→	90/110	PR-Code 1ZE	288	0 986 473 384		← 53,94	F 026 A06 106 <sup>7</sup>
						0 986 473 384		← 53,94	1 987 470 506 <sup>8</sup>
						0 986 474 384		→ 53,94	F 026 A06 106 <sup>7</sup>
		PR-Code 1ZM	228	0 986 473 071		← 54	1 987 470 506 <sup>8</sup>		
	0 986 474 071				→ 54	1 987 470 506 <sup>8</sup>			
1.6	03.13→	63/77	PR-Code 1ZE	288	0 986 473 384		← 53,94	F 026 A06 106 <sup>7</sup>	
					0 986 473 384		← 53,94	1 987 470 506 <sup>8</sup>	
					0 986 474 384		→ 53,94	F 026 A06 106 <sup>7</sup>	
		PR-Code 1ZM	228	0 986 473 071		← 54	1 987 470 506 <sup>8</sup>		
	0 986 474 071				→ 54	1 987 470 506 <sup>8</sup>			
	1.4 TSI	03.13→	90/110			0 986 473 381		← 38,1	1 987 470 040 <sup>7</sup>
						0 986 473 381		← 38,1	1 987 474 496 <sup>8</sup>
						0 986 474 381		→ 38,1	1 987 470 040 <sup>7</sup>
	1.6	03.13→	63/77			0 986 473 381		← 38,1	1 987 470 040 <sup>7</sup>
						0 986 473 381		← 38,1	1 987 474 496 <sup>8</sup>
						0 986 474 381		→ 38,1	1 987 470 040 <sup>7</sup>



◀ VW Jetta [AV2]								
	1.4 TSI	03.13→	90/110	LAB		0986 594 504 <sup>3</sup>		
						RAB	0986 594 506 <sup>4</sup>	
						0986 594 505 <sup>3</sup>		
						0986 594 507 <sup>4</sup>		
	1.6	03.13→	63/77	LAB		0986 594 504 <sup>3</sup>		
						RAB	0986 594 506 <sup>4</sup>	
						0986 594 505 <sup>3</sup>		
						0986 594 507 <sup>4</sup>		
<b>Jetta [AV3]</b>								
	1.4 TSI	10.14→	90/110	PR-Code 1ZE	288	0986 473 384	← 53,94	F 026 A06 106 <sup>7</sup>
						0986 473 384	← 53,94	1987 470 506 <sup>8</sup>
						0986 474 384	→ 53,94	F 026 A06 106 <sup>7</sup>
				PR-Code 1ZM	228	0986 473 071	← 54	1987 470 506 <sup>8</sup>
						0986 474 071	→ 54	1987 470 506 <sup>8</sup>
	1.6	10.14→	63/77	PR-Code 1ZE	288	0986 473 384	← 53,94	F 026 A06 106 <sup>7</sup>
						0986 473 384	← 53,94	1987 470 506 <sup>8</sup>
						0986 474 384	→ 53,94	F 026 A06 106 <sup>7</sup>
				PR-Code 1ZM	228	0986 473 071	← 54	1987 470 506 <sup>8</sup>
						0986 474 071	→ 54	1987 470 506 <sup>8</sup>
	1.4 TSI	10.14→	90/110			0986 473 381	← 38,1	1987 470 040 <sup>7</sup>
								0986 473 381
						0986 474 381	→ 38,1	1987 470 040 <sup>7</sup>
	1.6	10.14→	63/77			0986 473 381	← 38,1	1987 470 040 <sup>7</sup>
								0986 473 381
						0986 474 381	→ 38,1	1987 470 040 <sup>7</sup>
	1.4 TSI	10.14→	90/110	LAB		0986 594 504 <sup>3</sup>		
				RAB		0986 594 505 <sup>3</sup>		
				PR-Code 7Y0	LAB	0986 594 506 <sup>4</sup>		
					RAB	0986 594 507 <sup>4</sup>		
				PR-Code 7Y8	LAB	0986 594 561 <sup>4</sup>		
					RAB	0986 594 560 <sup>4</sup>		
	1.6	10.14→	63/77	LAB		0986 594 504 <sup>3</sup>		
				RAB		0986 594 505 <sup>3</sup>		
				PR-Code 7Y0	LAB	0986 594 506 <sup>4</sup>		
					RAB	0986 594 507 <sup>4</sup>		
				PR-Code 7Y8	LAB	0986 594 561 <sup>4</sup>		
					RAB	0986 594 560 <sup>4</sup>		
<b>Jetta I</b>								
	1.8 i	05.83-07.94	82		FSB	0986 473 663	← 48	
						0986 474 663	→ 48	
		07.94-12.95	82					0 204 104 144 <sup>7</sup>
	1.8 i	05.83-12.95	82			0986 475 260	↔ 17,46	
						0986 475 290	↔ 14,29	

		S								
<b>Jetta IV [1J2]</b>										
	1.6i	09.99-12.05	74	228	0986 473 071		←	54	1987 470 506 <sup>B</sup>	
					0986 474 071		→	54	1987 470 506 <sup>B</sup>	
					312	0986 471 923		←	54	1987 470 506 <sup>B</sup>
						0986 473 923				
						0986 471 924		→	54	1987 470 506 <sup>B</sup>
						0986 473 924				
	1.8T	09.03-12.05	110/132	228	0986 473 071		←	54	1987 470 506 <sup>B</sup>	
					0986 474 071		→	54	1987 470 506 <sup>B</sup>	
					312	0986 471 923		←	54	1987 470 506 <sup>B</sup>
						0986 473 923				
						0986 471 924		→	54	1987 470 506 <sup>B</sup>
						0986 473 924				
1.9TDI	09.99-12.05	81	228	0986 473 071		←	54	1987 470 506 <sup>B</sup>		
				0986 474 071		→	54	1987 470 506 <sup>B</sup>		
				312	0986 471 923		←	54	1987 470 506 <sup>B</sup>	
					0986 473 923					
					0986 471 924		→	54	1987 470 506 <sup>B</sup>	
					0986 473 924					
2.0i	09.99-12.05	85	228	0986 473 071		←	54	1987 470 506 <sup>B</sup>		
				0986 474 071		→	54	1987 470 506 <sup>B</sup>		
				312	0986 471 923		←	54	1987 470 506 <sup>B</sup>	
					0986 473 923					
					0986 471 924		→	54	1987 470 506 <sup>B</sup>	
					0986 473 924					
2.3i	09.99-12.05	110/125	228	0986 473 071		←	54	1987 470 506 <sup>B</sup>		
				0986 474 071		→	54	1987 470 506 <sup>B</sup>		
				312	0986 471 923		←	54	1987 470 506 <sup>B</sup>	
					0986 473 923					
					0986 471 924		→	54	1987 470 506 <sup>B</sup>	
					0986 473 924					
	1.6i	09.99-12.05	74	252	0986 473 139		←	38,1	1987 470 040 <sup>7</sup>	
					0986 473 139		←	38,1	1987 474 496 <sup>B</sup>	
					0986 474 139		→	38,1	1987 470 040 <sup>7</sup>	
	1.8T	09.03-12.05	110/132	252	0986 473 139		←	38,1	1987 470 040 <sup>7</sup>	
					0986 473 139		←	38,1	1987 474 496 <sup>B</sup>	
					0986 474 139		→	38,1	1987 470 040 <sup>7</sup>	
	1.9TDI	09.99-12.05	81	252	0986 473 139		←	38,1	1987 470 040 <sup>7</sup>	
					0986 473 139		←	38,1	1987 474 496 <sup>B</sup>	
					0986 474 139		→	38,1	1987 470 040 <sup>7</sup>	
	2.0i	09.99-12.05	85	252	0986 473 139		←	38,1	1987 470 040 <sup>7</sup>	
					0986 473 139		←	38,1	1987 474 496 <sup>B</sup>	
					0986 474 139		→	38,1	1987 470 040 <sup>7</sup>	
2.3i	09.99-12.05	110/125	252	0986 473 139		←	38,1	1987 470 040 <sup>7</sup>		
				0986 473 139		←	38,1	1987 474 496 <sup>B</sup>		
				0986 474 139		→	38,1	1987 470 040 <sup>7</sup>		
	1.6i	09.99-12.05	74	LAB	0986 594 004 <sup>4</sup>					
					0986 594 001 <sup>3</sup>					
					0986 594 000 <sup>3</sup>					
	1.8T	09.03-12.05	110/132	LAB	0986 594 004 <sup>4</sup>					
					0986 594 001 <sup>3</sup>					
					0986 594 000 <sup>3</sup>					
1.9TDI	09.99-12.05	81	LAB	0986 594 004 <sup>4</sup>						
				0986 594 001 <sup>3</sup>						
				0986 594 000 <sup>3</sup>						



		S							
	◀ VW Jetta IV [1J2]								
	2.0 i	09.99-12.05	85				0 986 594 004 <sup>4</sup>		
						LAB	0 986 594 001 <sup>3</sup>		
						RAB	0 986 594 000 <sup>3</sup>		
	2.3 i	09.99-12.05	110/125				0 986 594 004 <sup>4</sup>		
						LAB	0 986 594 001 <sup>3</sup>		
						RAB	0 986 594 000 <sup>3</sup>		
<b>Jetta V [1K6]</b>									
	2.0 TDI	03.06→	103		312		0 986 473 384	← 53,94	F 026 A06 106 <sup>7</sup>
							0 986 473 384	← 53,94	1 987 470 506 <sup>8</sup>
							0 986 474 384	→ 53,94	F 026 A06 106 <sup>7</sup>
	2.0 TDI	03.06→	103	PR-Code 1KJ			0 986 473 448	← 41	1 987 474 496 <sup>8</sup>
							0 986 474 448	→ 41	1 987 474 496 <sup>8</sup>
	2.0 TDI	03.06→	103			LAB	0 986 594 504 <sup>3</sup>		
							0 986 594 506 <sup>4</sup>		
						RAB	0 986 594 505 <sup>3</sup>		
							0 986 594 507 <sup>4</sup>		
<b>Jetta [1H2/1W2]</b>									
	1.9 TDI	08.95→	66		INB		0 986 471 669	← 54	1 987 470 287 <sup>7</sup>
							0 986 473 669		1 987 474 496 <sup>8</sup>
							0 986 472 669	→ 54	1 987 470 287 <sup>7</sup>
							0 986 474 669		
	2.0	08.92-09.98	85		INB		0 986 471 669	← 54	1 987 470 287 <sup>7</sup>
							0 986 473 669		1 987 474 496 <sup>8</sup>
							0 986 472 669	→ 54	1 987 470 287 <sup>7</sup>
							0 986 474 669		
	2.8	01.94-07.95	128	Fg.-Nr. →1H-S-990 000	BEL,INB		0 986 473 687	← 54	1 987 470 287 <sup>7</sup>
							0 986 473 687	← 54	1 987 474 496 <sup>8</sup>
							0 986 474 687	→ 54	1 987 470 287 <sup>7</sup>
		08.95-08.99	128	Fg.-Nr. 1H-T-000 001→	BEL,INB		0 986 471 923	← 54	
							0 986 473 923		
							0 986 471 924	→ 54	
							0 986 473 924		
	1.8	10.92-07.98	66		AG		0 986 475 438	↔ 15,87	
	1.9 TD	08.92-07.98	55				0 986 475 260	↔ 17,46	
	1.9 TDI	08.95→	66				0 986 475 433	↔ 19,05	
	2.0	08.92-09.98	85				0 986 475 433	↔ 19,05	
<b>Jetta [1K2]</b>									
	1.4 TSI	07.06-06.08	103		288,312		0 986 473 384	← 53,94	F 026 A06 106 <sup>7</sup>
							0 986 473 384	← 53,94	1 987 470 506 <sup>8</sup>
							0 986 474 384	→ 53,94	F 026 A06 106 <sup>7</sup>
			125		288,312		0 986 473 384	← 53,94	F 026 A06 106 <sup>7</sup>
							0 986 473 384	← 53,94	1 987 470 506 <sup>8</sup>
							0 986 474 384	→ 53,94	F 026 A06 106 <sup>7</sup>
		07.07-10.10	90	PR-Code 1LJ, PR-Code 1LL, PR-Code 1LV, PR-Code 1ZE, PR-Code 1ZD, PR-Code 1ZP	288,312		0 986 473 384	← 53,94	F 026 A06 106 <sup>7</sup>
							0 986 473 384	← 53,94	1 987 470 506 <sup>8</sup>
							0 986 474 384	→ 53,94	F 026 A06 106 <sup>7</sup>



		S							
<b>1.4 TSI</b>	07.07-10.10	90	PR-Code 1ZM	228	0986 473 071	← 54	1987 470 506 <sup>B</sup>		
					0986 474 071	→ 54	1987 470 506 <sup>B</sup>		
<b>1.6</b>	07.08-10.10	118	PR-Code 1LJ, PR-Code 1LL, PR-Code 1LV, PR-Code 1ZE, PR-Code 1ZD, PR-Code 1ZP	288,312	0986 473 384	← 53,94	F 026 A06 106 <sup>7</sup>		
					0986 473 384	← 53,94	1987 470 506 <sup>B</sup>		
			PR-Code 1ZM	228	0986 474 384	→ 53,94	F 026 A06 106 <sup>7</sup>		
					0986 473 071	← 54	1987 470 506 <sup>B</sup>		
<b>1.6</b>	10.05-10.10	75	PR-Code 1LJ, PR-Code 1LL, PR-Code 1LV, PR-Code 1ZE, PR-Code 1ZD, PR-Code 1ZP	288,312	0986 473 384	← 53,94	F 026 A06 106 <sup>7</sup>		
					0986 473 384	← 53,94	1987 470 506 <sup>B</sup>		
			PR-Code 1LJ, PR-Code 1ZA, PR-Code 1ZB, PR-Code 1ZD, PR-Code 1ZE, PR-Code 1ZP	288,312	0986 474 384	→ 53,94	F 026 A06 106 <sup>7</sup>		
					0986 473 384	← 53,94	1987 470 506 <sup>B</sup>		
<b>1.6 MultiFuel</b>	10.05-10.10	75	PR-Code 1ZM	228	0986 473 071	← 54	1987 470 506 <sup>B</sup>		
<b>1.6 FSI</b>	09.05-06.08	85	PR-Code 1LL, PR-Code 1LV	312	0986 473 384	← 53,94	F 026 A06 106 <sup>7</sup>		
					0986 473 384	← 53,94	1987 470 506 <sup>B</sup>		
			PR-Code 1ZE, PR-Code 1LJ, PR-Code 1ZP, PR-Code 1ZD	288,312	0986 474 384	→ 53,94	F 026 A06 106 <sup>7</sup>		
					0986 473 384	← 53,94	1987 470 506 <sup>B</sup>		
<b>1.6 MultiFuel</b>	01.08-10.10	75	PR-Code 1LJ, PR-Code 1LL, PR-Code 1LV, PR-Code 1ZE, PR-Code 1ZD, PR-Code 1ZP	288,312	0986 473 384	← 53,94	F 026 A06 106 <sup>7</sup>		
					0986 473 384	← 53,94	1987 470 506 <sup>B</sup>		
			PR-Code 1ZM	228	0986 474 384	→ 53,94	F 026 A06 106 <sup>7</sup>		
					0986 473 071	← 54	1987 470 506 <sup>B</sup>		
<b>1.6 TDI</b>	07.09-10.10	77	PR-Code 1LJ, PR-Code 1LL, PR-Code 1LV, PR-Code 1ZE, PR-Code 1ZD, PR-Code 1ZP	288,312	0986 473 384	← 53,94	F 026 A06 106 <sup>7</sup>		
					0986 473 384	← 53,94	1987 470 506 <sup>B</sup>		
			PR-Code 1ZM	228	0986 474 384	→ 53,94	F 026 A06 106 <sup>7</sup>		
					0986 473 071	← 54	1987 470 506 <sup>B</sup>		
<b>1.6 TDI</b>	12.09-10.10	66	PR-Code 1LJ, PR-Code 1LL, PR-Code 1LV, PR-Code 1ZE, PR-Code 1ZD, PR-Code 1ZP	288,312	0986 473 384	← 53,94	F 026 A06 106 <sup>7</sup>		
					0986 473 384	← 53,94	1987 470 506 <sup>B</sup>		
			PR-Code 1ZM	228	0986 474 384	→ 53,94	F 026 A06 106 <sup>7</sup>		
					0986 473 071	← 54	1987 470 506 <sup>B</sup>		
<b>1.9 TDI</b>	09.05-02.06	77	PR-Code 1LJ, PR-Code 1LL, PR-Code 1LV, PR-Code 1ZE, PR-Code 1ZD, PR-Code 1ZP	288,312	0986 473 384	← 53,94	F 026 A06 106 <sup>7</sup>		
					0986 473 384	← 53,94	1987 470 506 <sup>B</sup>		
			PR-Code 1ZM	228	0986 474 384	→ 53,94	F 026 A06 106 <sup>7</sup>		
					0986 473 071	← 54	1987 470 506 <sup>B</sup>		
<b>1.9 TDI</b>	03.06-10.10	77	PR-Code 1LJ, PR-Code 1ZA, PR-Code 1ZE, PR-Code 1ZD, PR-Code 1ZP	288,312	0986 473 384	← 53,94	F 026 A06 106 <sup>7</sup>		
					0986 473 384	← 53,94	1987 470 506 <sup>B</sup>		
			PR-Code 1LL, PR-Code 1LV	312	0986 474 384	→ 53,94	F 026 A06 106 <sup>7</sup>		
					0986 473 384	← 53,94	1987 470 506 <sup>B</sup>		
<b>2.0 FSI</b>	08.05-06.08	110	PR-Code 1LJ, PR-Code 1ZA, PR-Code 1ZE, PR-Code 1ZD, PR-Code 1ZP	288,312	0986 473 384	← 53,94	F 026 A06 106 <sup>7</sup>		
					0986 473 384	← 53,94	1987 470 506 <sup>B</sup>		
			PR-Code 1LL, PR-Code 1LV	312	0986 474 384	→ 53,94	F 026 A06 106 <sup>7</sup>		
					0986 473 384	← 53,94	1987 470 506 <sup>B</sup>		
<b>2.0 TDI</b>	08.05-06.08	103	PR-Code 1LJ, PR-Code 1ZA, PR-Code 1ZE, PR-Code 1ZD, PR-Code 1ZP	288,312	0986 473 384	← 53,94	F 026 A06 106 <sup>7</sup>		
					0986 473 384	← 53,94	1987 470 506 <sup>B</sup>		
			PR-Code 1LL, PR-Code 1LV	312	0986 474 384	→ 53,94	F 026 A06 106 <sup>7</sup>		
					0986 473 384	← 53,94	1987 470 506 <sup>B</sup>		
<b>2.0 TDI</b>	08.05-10.10	103	PR-Code 1ZM	228	0986 473 071	← 54	1987 470 506 <sup>B</sup>		
					0986 474 071	→ 54	1987 470 506 <sup>B</sup>		



			S							
	◀ VW Jetta [1K2]									
2.0 TDI	09.05-06.08	100	288,312	0986 473 384		53,94	F 026 A06 106 <sup>7</sup>			
				0986 473 384		53,94	1987 470 506 <sup>8</sup>			
				0986 474 384		53,94	F 026 A06 106 <sup>7</sup>			
	10.05-06.08	103	288,312	0986 473 384		53,94	F 026 A06 106 <sup>7</sup>			
				0986 473 384		53,94	1987 470 506 <sup>8</sup>			
	07.06-06.08	125	288,312	0986 473 384		53,94	F 026 A06 106 <sup>7</sup>			
				0986 473 384		53,94	1987 470 506 <sup>8</sup>			
				0986 474 384		53,94	F 026 A06 106 <sup>7</sup>			
	07.08-10.10	100	288,312	PR-Code 1LJ, PR-Code 1LL, PR-Code 1LV, PR-Code 1ZE, PR-Code 1ZD, PR-Code 1ZP	0986 473 384		53,94	F 026 A06 106 <sup>7</sup>		
					0986 473 384		53,94	1987 470 506 <sup>8</sup>		
					0986 474 384		53,94	F 026 A06 106 <sup>7</sup>		
		228	0986 473 071		54	1987 470 506 <sup>8</sup>				
			0986 474 071		54	1987 470 506 <sup>8</sup>				
		103	288,312	PR-Code 1LJ, PR-Code 1LL, PR-Code 1LV, PR-Code 1ZE, PR-Code 1ZD, PR-Code 1ZP	0986 473 384		53,94	F 026 A06 106 <sup>7</sup>		
					0986 473 384		53,94	1987 470 506 <sup>8</sup>		
					0986 474 384		53,94	F 026 A06 106 <sup>7</sup>		
		125	288,312	PR-Code 1LJ, PR-Code 1LL, PR-Code 1LV, PR-Code 1ZE, PR-Code 1ZD, PR-Code 1ZP	0986 473 384		53,94	F 026 A06 106 <sup>7</sup>		
					0986 473 384		53,94	1987 470 506 <sup>8</sup>		
					0986 474 384		53,94	F 026 A06 106 <sup>7</sup>		
		228	0986 473 071		54	1987 470 506 <sup>8</sup>				
	0986 474 071			54	1987 470 506 <sup>8</sup>					
	01.10-10.10	81	288,312	PR-Code 1LJ, PR-Code 1LL, PR-Code 1LV, PR-Code 1ZE, PR-Code 1ZD, PR-Code 1ZP	0986 473 384		53,94	F 026 A06 106 <sup>7</sup>		
					0986 473 384		53,94	1987 470 506 <sup>8</sup>		
					0986 474 384		53,94	F 026 A06 106 <sup>7</sup>		
228					0986 473 071		54	1987 470 506 <sup>8</sup>		
0986 474 071						54	1987 470 506 <sup>8</sup>			
2.0 TSI	06.05-03.08	147	BSR	0986 473 384		53,94	F 026 A06 106 <sup>7</sup>			
				0986 473 384		53,94	1987 470 506 <sup>8</sup>			
				0986 474 384		53,94	F 026 A06 106 <sup>7</sup>			
				BSR	0986 473 384		53,94	F 026 A06 106 <sup>7</sup>		
				0986 473 384		53,94	1987 470 506 <sup>8</sup>			
				0986 474 384		53,94	F 026 A06 106 <sup>7</sup>			
	09.05-10.10	147	288,312	PR-Code 1LJ, PR-Code 1LL, PR-Code 1LV, PR-Code 1ZE, PR-Code 1ZD, PR-Code 1ZP	0986 473 384		53,94	F 026 A06 106 <sup>7</sup>		
					0986 473 384		53,94	1987 470 506 <sup>8</sup>		
					0986 474 384		53,94	F 026 A06 106 <sup>7</sup>		
	228	0986 473 071		54	1987 470 506 <sup>8</sup>					
	0986 474 071		54	1987 470 506 <sup>8</sup>						
	04.08-10.10	147	288,312	PR-Code 1LJ, PR-Code 1ZA, PR-Code 1ZB, PR-Code 1ZD, PR-Code 1ZE, PR-Code 1ZP	0986 473 384		53,94	F 026 A06 106 <sup>7</sup>		
					0986 473 384		53,94	1987 470 506 <sup>8</sup>		
					0986 474 384		53,94	F 026 A06 106 <sup>7</sup>		
				312	PR-Code 1LL, PR-Code 1LV	0986 473 384		53,94	F 026 A06 106 <sup>7</sup>	
						0986 473 384		53,94	1987 470 506 <sup>8</sup>	
						0986 474 384		53,94	F 026 A06 106 <sup>7</sup>	
	2.5	01.05-06.08	110	288,312	0986 473 384		53,94	F 026 A06 106 <sup>7</sup>		
0986 473 384						53,94	1987 470 506 <sup>8</sup>			
0986 474 384						53,94	F 026 A06 106 <sup>7</sup>			
07.07-10.10		125	288,312	PR-Code 1LJ, PR-Code 1LL, PR-Code 1LV, PR-Code 1ZE, PR-Code 1ZD, PR-Code 1ZP	0986 473 384		53,94	F 026 A06 106 <sup>7</sup>		
					0986 473 384		53,94	1987 470 506 <sup>8</sup>		
					0986 474 384		53,94	F 026 A06 106 <sup>7</sup>		
		288,312	PR-Code 1LJ, PR-Code 1ZA, PR-Code 1ZB, PR-Code 1ZD, PR-Code 1ZE, PR-Code 1ZP	0986 473 384		53,94	F 026 A06 106 <sup>7</sup>			
				0986 473 384		53,94	1987 470 506 <sup>8</sup>			
				0986 474 384		53,94	F 026 A06 106 <sup>7</sup>			
		312	PR-Code 1LL, PR-Code 1LV	0986 473 384		53,94	F 026 A06 106 <sup>7</sup>			
				0986 473 384		53,94	1987 470 506 <sup>8</sup>			
				0986 474 384		53,94	F 026 A06 106 <sup>7</sup>			
228	PR-Code 1ZM	0986 473 071		54	1987 470 506 <sup>8</sup>					
0986 474 071		54	1987 470 506 <sup>8</sup>							
1.4 TSI	07.06-06.08	103	288,312	0986 473 448		41	1987 474 496 <sup>8</sup>			
				0986 474 448		41	1987 474 496 <sup>8</sup>			

	S								
<b>1.4 TSI</b>	07.06-06.08	125				0 986 473 448	↻ ← 41	1 987 474 496 <sup>B</sup>	
						0 986 474 448	↻ → 41	1 987 474 496 <sup>B</sup>	
	07.07-10.10	90		PR-Code 1KE, PR-Code 1KF, PR-Code 1KJ, PR-Code 1KV PR-Code 1KS			0 986 473 448	↻ ← 41	1 987 474 496 <sup>B</sup>
							0 986 474 448	↻ → 41	1 987 474 496 <sup>B</sup>
							0 986 134 203	↻ ← 38	
							0 986 135 203	↻ → 38	
	07.08-10.10	118		PR-Code 1KE, PR-Code 1KF, PR-Code 1KJ, PR-Code 1KV PR-Code 1KS			0 986 473 448	↻ ← 41	1 987 474 496 <sup>B</sup>
							0 986 474 448	↻ → 41	1 987 474 496 <sup>B</sup>
							0 986 134 203	↻ ← 38	
							0 986 135 203	↻ → 38	
	<b>1.6</b> <b>1.6 MultiFuel</b> <b>1.6 TDI</b>	10.05-10.10	66/75/77	PR-Code 1KE, PR-Code 1KF, PR-Code 1KJ, PR-Code 1KV PR-Code 1KS			0 986 473 448	↻ ← 41	1 987 474 496 <sup>B</sup>
							0 986 474 448	↻ → 41	1 987 474 496 <sup>B</sup>
0 986 134 203							↻ ← 38		
						0 986 135 203	↻ → 38		
<b>1.6 FSI</b>	09.05-06.08	85	PR-Code 1KE, PR-Code 1KF, PR-Code 1KJ, PR-Code 1KV			0 986 473 448	↻ ← 41	1 987 474 496 <sup>B</sup>	
						0 986 474 448	↻ → 41	1 987 474 496 <sup>B</sup>	
<b>1.9 TDI</b>	09.05-02.06	77				0 986 473 448	↻ ← 41	1 987 474 496 <sup>B</sup>	
						0 986 474 448	↻ → 41	1 987 474 496 <sup>B</sup>	
	09.05-10.10	77	PR-Code 1KE, PR-Code 1KF, PR-Code 1KJ, PR-Code 1KV PR-Code 1KS			0 986 473 448	↻ ← 41	1 987 474 496 <sup>B</sup>	
						0 986 474 448	↻ → 41	1 987 474 496 <sup>B</sup>	
						0 986 134 203	↻ ← 38		
						0 986 135 203	↻ → 38		
<b>2.0 FSI</b>	08.05-06.08	110				0 986 473 448	↻ ← 41	1 987 474 496 <sup>B</sup>	
						0 986 474 448	↻ → 41	1 987 474 496 <sup>B</sup>	
<b>2.0 TDI</b>	08.05-06.08	100/103				0 986 473 448	↻ ← 41	1 987 474 496 <sup>B</sup>	
						0 986 474 448	↻ → 41	1 987 474 496 <sup>B</sup>	
	07.06-06.08	125				0 986 473 448	↻ ← 41	1 987 474 496 <sup>B</sup>	
						0 986 474 448	↻ → 41	1 987 474 496 <sup>B</sup>	
	07.08-10.10	100/103	PR-Code 1KE, PR-Code 1KF, PR-Code 1KJ, PR-Code 1KV PR-Code 1KS			0 986 473 448	↻ ← 41	1 987 474 496 <sup>B</sup>	
						0 986 474 448	↻ → 41	1 987 474 496 <sup>B</sup>	
						0 986 134 203	↻ ← 38		
						0 986 135 203	↻ → 38		
		125	PR-Code 1KE, PR-Code 1KF, PR-Code 1KJ, PR-Code 1KV PR-Code 1KS			0 986 473 448	↻ ← 41	1 987 474 496 <sup>B</sup>	
						0 986 474 448	↻ → 41	1 987 474 496 <sup>B</sup>	
						0 986 134 203	↻ ← 38		
						0 986 135 203	↻ → 38		
	01.10-10.10	81	PR-Code 1KE, PR-Code 1KF, PR-Code 1KJ, PR-Code 1KV PR-Code 1KS			0 986 473 448	↻ ← 41	1 987 474 496 <sup>B</sup>	
						0 986 474 448	↻ → 41	1 987 474 496 <sup>B</sup>	
						0 986 134 203	↻ ← 38		
						0 986 135 203	↻ → 38		
<b>2.0 TSI</b>	06.05-03.08	147			BSR	0 986 473 448	↻ ← 41	1 987 474 496 <sup>B</sup>	
					BSR	0 986 474 448	↻ → 41	1 987 474 496 <sup>B</sup>	
						0 986 134 244	↻ ←	1 987 474 496 <sup>B</sup>	
						0 986 135 244	↻ →	1 987 474 496 <sup>B</sup>	
	09.05-10.10	147	PR-Code 1KE, PR-Code 1KF, PR-Code 1KJ, PR-Code 1KV PR-Code 1KS			0 986 473 448	↻ ← 41	1 987 474 496 <sup>B</sup>	
						0 986 474 448	↻ → 41	1 987 474 496 <sup>B</sup>	
						0 986 134 203	↻ ← 38		
						0 986 135 203	↻ → 38		
	04.08-10.10	147	PR-Code 1KY, PR-Code 1KV			0 986 134 244	↻ ←	1 987 474 496 <sup>B</sup>	
						0 986 135 244	↻ →	1 987 474 496 <sup>B</sup>	
<b>2.5</b>	01.05-06.08	110				0 986 473 448	↻ ← 41	1 987 474 496 <sup>B</sup>	
						0 986 474 448	↻ → 41	1 987 474 496 <sup>B</sup>	
	07.07-10.10	125	PR-Code 1KE, PR-Code 1KF, PR-Code 1KJ, PR-Code 1KV PR-Code 1KS			0 986 473 448	↻ ← 41	1 987 474 496 <sup>B</sup>	
						0 986 474 448	↻ → 41	1 987 474 496 <sup>B</sup>	
						0 986 134 203	↻ ← 38		
						0 986 135 203	↻ → 38		
			PR-Code 1KY, PR-Code 1KV			0 986 134 244	↻ ←	1 987 474 496 <sup>B</sup>	
						0 986 135 244	↻ →	1 987 474 496 <sup>B</sup>	
	<b>1.4 TSI</b>	07.06-10.10	90/103/ 118/125			1 987 477 958	↔ 1447		





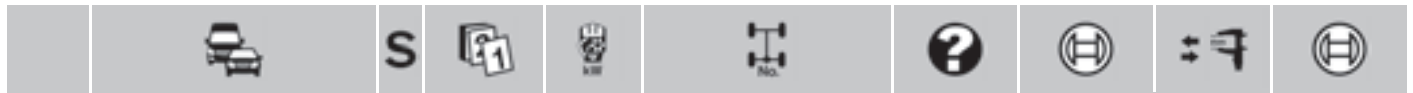

◀ VW Jetta [1K2]

1.6	10.05-06.06	75	Fg.-Nr. →1K..6..899 000	1987	<b>482 445</b>	↔ 1447
	07.06-10.10	75	Fg.-Nr. 1K..7..000 001→	1987	<b>477 958</b>	↔ 1447
1.6 FSI	09.05-06.06	85	Fg.-Nr. →1K..6..899 000	1987	<b>482 445</b>	↔ 1447
1.6 MultiFuel	01.08-10.10	75		1987	<b>477 958</b>	↔ 1447
1.6 TDI	07.09-10.10	77		1987	<b>477 958</b>	↔ 1447
	12.09-10.10	66		1987	<b>477 958</b>	↔ 1447
1.9 TDI	09.05-02.06	77		1987	<b>482 445</b>	↔ 1447
	09.05-06.06	77	Fg.-Nr. →1K..6..899 000	1987	<b>482 445</b>	↔ 1447
	07.06-10.10	77	Fg.-Nr. 1K..7..000 001→	1987	<b>477 958</b>	↔ 1447
2.0 FSI	08.05-11.05	110		1987	<b>482 445</b>	↔ 1447
	12.05-06.06	110	Fg.-Nr. →1K..6..899 000	1987	<b>482 445</b>	↔ 1447
	07.06-06.08	110	Fg.-Nr. 1K..7..000 001→	1987	<b>477 958</b>	↔ 1447
2.0 TDI	08.05-06.06	100/103	Fg.-Nr. →1K..6..899 000	1987	<b>482 445</b>	↔ 1447
	07.06-06.08	100/103	Fg.-Nr. 1K..7..000 001→	1987	<b>477 958</b>	↔ 1447
	07.06-10.10	125		1987	<b>477 958</b>	↔ 1447
	07.08-10.10	100/103		1987	<b>477 958</b>	↔ 1447
2.0 TSI	01.10-10.10	81		1987	<b>477 958</b>	↔ 1447
	06.05-06.06	147	Fg.-Nr. →1K..6..899 000	1987	<b>482 445</b>	↔ 1447
	07.06-10.10	147	Fg.-Nr. 1K..7..000 001→	1987	<b>477 958</b>	↔ 1447
2.5	04.08-10.10	147		1987	<b>477 958</b>	↔ 1447
	01.05-06.06	110	Fg.-Nr. →1K..6..899 000	1987	<b>482 445</b>	↔ 1447
	07.06-06.08	110	Fg.-Nr. 1K..7..000 001→	1987	<b>477 958</b>	↔ 1447
	07.07-10.10	125		1987	<b>477 958</b>	↔ 1447

1.4 TSI	07.06-10.10	90/103/ 118/125	LAB	0986	<b>594 504<sup>3</sup></b>	
					<b>594 506<sup>4</sup></b>	
			RAB	0986	<b>594 505<sup>3</sup></b>	
				0986	<b>594 507<sup>4</sup></b>	
1.6	09.05-10.10	66/75/77/ 85	LAB	0986	<b>594 504<sup>3</sup></b>	
1.6 FSI				<b>594 506<sup>4</sup></b>		
1.6 MultiFuel			RAB	0986	<b>594 505<sup>3</sup></b>	
1.6 TDI				0986	<b>594 507<sup>4</sup></b>	
1.9 TDI	09.05-10.10	77	LAB	0986	<b>594 504<sup>3</sup></b>	
				<b>594 506<sup>4</sup></b>		
			RAB	0986	<b>594 505<sup>3</sup></b>	
				0986	<b>594 507<sup>4</sup></b>	
2.0 FSI	06.05-10.10	81/100/ 103/110/	LAB	0986	<b>594 504<sup>3</sup></b>	
2.0 TDI				<b>594 506<sup>4</sup></b>		
2.0 TSI		125/147	RAB	0986	<b>594 505<sup>3</sup></b>	
				0986	<b>594 507<sup>4</sup></b>	
2.5	01.05-10.10	110/125	LAB	0986	<b>594 504<sup>3</sup></b>	
				<b>594 506<sup>4</sup></b>		
			RAB	0986	<b>594 505<sup>3</sup></b>	
				0986	<b>594 507<sup>4</sup></b>	

Jetta [9M2]



1.8	09.98→	110/132	228	0986	<b>473 071</b>	👁️ ← 54	1987	<b>470 506<sup>8</sup></b>
					<b>474 071</b>	👁️ → 54	1987	<b>470 506<sup>8</sup></b>
			288	0986	<b>471 923</b>	← 54	1987	<b>470 506<sup>8</sup></b>
				0986	<b>473 923</b>	👁️		
				0986	<b>471 924</b>	→ 54	1987	<b>470 506<sup>8</sup></b>
				0986	<b>473 924</b>	👁️		
2.0	12.98-06.04	85	228	0986	<b>473 071</b>	👁️ ← 54	1987	<b>470 506<sup>8</sup></b>
				0986	<b>474 071</b>	👁️ → 54	1987	<b>470 506<sup>8</sup></b>
			288	0986	<b>471 923</b>	← 54	1987	<b>470 506<sup>8</sup></b>
				0986	<b>473 923</b>	👁️		
				0986	<b>471 924</b>	→ 54	1987	<b>470 506<sup>8</sup></b>
				0986	<b>473 924</b>	👁️		
2.8	10.98-12.04	130/147	228	0986	<b>473 071</b>	👁️ ← 54	1987	<b>470 506<sup>8</sup></b>
				0986	<b>474 071</b>	👁️ → 54	1987	<b>470 506<sup>8</sup></b>

		S									
2.8		10.98-12.04	130/147		288	0 986 471 923 0 986 473 923	← 54		1 987 470 506 <sup>B</sup>		
						0 986 471 924 0 986 473 924	→ 54		1 987 470 506 <sup>B</sup>		
1.8		09.98-08.04	110			0 986 473 029	← 41		1 987 474 496 <sup>B</sup>		
						0 986 474 029	→ 41		1 987 474 496 <sup>B</sup>		
		05.99-07.99	110	Fg.-Nr. →9M..Y..012 499		0 986 473 106	← 41		1 987 474 496 <sup>B</sup>		
						0 986 474 106	→ 41		1 987 474 496 <sup>B</sup>		
		08.99→	110	Fg.-Nr. 9M..Y..012 500→		0 986 473 029	← 41		1 987 474 496 <sup>B</sup>		
						0 986 474 029	→ 41		1 987 474 496 <sup>B</sup>		
		06.00-08.08	132			0 986 473 029	← 41		1 987 474 496 <sup>B</sup>		
						0 986 474 029	→ 41		1 987 474 496 <sup>B</sup>		
2.0		12.98-07.99	85	Fg.-Nr. →9M..Y..012 499		0 986 473 106	← 41		1 987 474 496 <sup>B</sup>		
						0 986 474 106	→ 41		1 987 474 496 <sup>B</sup>		
		08.99-10.00	85	Fg.-Nr. 9M..Y..012 500→		0 986 473 029	← 41		1 987 474 496 <sup>B</sup>		
						0 986 474 029	→ 41		1 987 474 496 <sup>B</sup>		
2.8		09.00-06.04	85			0 986 473 029	← 41		1 987 474 496 <sup>B</sup>		
						0 986 474 029	→ 41		1 987 474 496 <sup>B</sup>		
		10.98-07.99	130	Fg.-Nr. →9M..Y..012 499		0 986 473 106	← 41		1 987 474 496 <sup>B</sup>		
						0 986 474 106	→ 41		1 987 474 496 <sup>B</sup>		
2.8		08.99-12.04	130	Fg.-Nr. 9M..Y..012 500→		0 986 473 029	← 41		1 987 474 496 <sup>B</sup>		
						0 986 474 029	→ 41		1 987 474 496 <sup>B</sup>		
		10.01-06.04	147			0 986 473 029	← 41		1 987 474 496 <sup>B</sup>		
						0 986 474 029	→ 41		1 987 474 496 <sup>B</sup>		
1.8		09.98-08.04	110			1 987 477 698	↔ 1693				
		05.99-01.00	110	Fg.-Nr. →9M..Y..012 499		1 987 477 696	↔ 1688				
		02.00→	110	Fg.-Nr. 9M..Y..012 500→		1 987 477 698	↔ 1693				
		06.00-08.08	132			1 987 477 698	↔ 1693				
		12.98-01.00	85	Fg.-Nr. →9M..Y..012 499		1 987 477 696	↔ 1688				
2.0		02.00-10.00	85	Fg.-Nr. 9M..Y..012 500→		1 987 477 698	↔ 1693				
		09.00-06.04	85			1 987 477 698	↔ 1693				
		10.98-01.00	130	Fg.-Nr. →9M..Y..012 499		1 987 477 696	↔ 1688				
2.8		02.00-12.04	130	Fg.-Nr. 9M..Y..012 500→		1 987 477 698	↔ 1693				
		10.01-06.04	147			1 987 477 698	↔ 1693				
1.8		09.98→	110/132			0 986 594 004 <sup>4</sup>					
						LAB	0 986 594 001 <sup>3</sup>				
		2.0	12.98-06.04	85				0 986 594 000 <sup>3</sup>			
								LAB	0 986 594 001 <sup>3</sup>		
		2.8	10.98-12.04	130/147				0 986 594 000 <sup>3</sup>			
								RAB	0 986 594 000 <sup>3</sup>		
<b>Jetta [162]</b>											
1.2 TSI		10.10-07.14	77	PR-Code 1LV	312	0 986 473 384	← 53,94	F 026 A06 106 <sup>7</sup>			
						0 986 473 384	← 53,94	1 987 470 506 <sup>B</sup>			
						0 986 474 384	→ 53,94	F 026 A06 106 <sup>7</sup>			
						0 986 473 384	← 53,94	F 026 A06 106 <sup>7</sup>			
						0 986 473 384	← 53,94	1 987 470 506 <sup>B</sup>			
				PR-Code 1LV, PR-Code 1ZB	312	0 986 474 384	→ 53,94	F 026 A06 106 <sup>7</sup>			
						0 986 473 384	← 53,94	F 026 A06 106 <sup>7</sup>			
				PR-Code 1ZA, PR-Code 1ZE, PR-Code 1ZP	288,312	0 986 473 384	← 53,94	F 026 A06 106 <sup>7</sup>			
						0 986 473 384	← 53,94	1 987 470 506 <sup>B</sup>			
						0 986 474 384	→ 53,94	F 026 A06 106 <sup>7</sup>			



			S							
◀ VW Jetta [162]										
1.2 TSI	10.10-07.14	77	PR-Code 1ZM, PR-Code 1ZQ	228	0986 473 071		←	54	1987 470 506 <sup>8</sup>	
					0986 474 071		→	54	1987 470 506 <sup>8</sup>	
1.4 Hybrid	04.11-07.14	90/110-125	PR-Code 1LV, PR-Code 1ZB	312	0986 473 384		←	53,94	F 026 A06 106 <sup>7</sup>	
					0986 473 384		←	53,94	1987 470 506 <sup>8</sup>	
1.4 TSI			PR-Code 1ZA, PR-Code 1ZE, PR-Code 1ZP	288,312	0986 474 384		→	53,94	F 026 A06 106 <sup>7</sup>	
					0986 473 384		←	53,94	1987 470 506 <sup>8</sup>	
			PR-Code 1ZM, PR-Code 1ZQ	228	0986 473 071		←	54	1987 470 506 <sup>8</sup>	
					0986 474 071		→	54	1987 470 506 <sup>8</sup>	
1.6	12.11-07.14	77	PR-Code 1LV, PR-Code 1ZB	312	0986 473 384		←	53,94	F 026 A06 106 <sup>7</sup>	
					0986 473 384		←	53,94	1987 470 506 <sup>8</sup>	
			PR-Code 1ZA, PR-Code 1ZE, PR-Code 1ZP	288,312	0986 473 384		←	53,94	F 026 A06 106 <sup>7</sup>	
					0986 473 384		←	53,94	1987 470 506 <sup>8</sup>	
			PR-Code 1ZM		0986 473 071		←	54	1987 470 506 <sup>8</sup>	
					0986 474 071		→	54	1987 470 506 <sup>8</sup>	
			PR-Code 1ZM, PR-Code 1ZQ	228	0986 473 071		←	54	1987 470 506 <sup>8</sup>	
					0986 474 071		→	54	1987 470 506 <sup>8</sup>	
1.6 TDI	10.10-07.14	77	PR-Code 1LV	312	0986 473 384		←	53,94	F 026 A06 106 <sup>7</sup>	
					0986 473 384		←	53,94	1987 470 506 <sup>8</sup>	
			PR-Code 1LV, PR-Code 1ZB	312	0986 474 384		→	53,94	F 026 A06 106 <sup>7</sup>	
					0986 473 384		←	53,94	F 026 A06 106 <sup>7</sup>	
			PR-Code 1LV, PR-Code 1ZB	312	0986 473 384		←	53,94	1987 470 506 <sup>8</sup>	
					0986 474 384		→	53,94	F 026 A06 106 <sup>7</sup>	
			PR-Code 1ZA, PR-Code 1ZE, PR-Code 1ZP	288,312	0986 473 384		←	53,94	F 026 A06 106 <sup>7</sup>	
					0986 473 384		←	53,94	1987 470 506 <sup>8</sup>	
			PR-Code 1ZM, PR-Code 1ZQ	228	0986 474 384		→	53,94	F 026 A06 106 <sup>7</sup>	
					0986 473 071		←	54	1987 470 506 <sup>8</sup>	
			PR-Code 1ZM, PR-Code 1ZQ	228	0986 474 071		→	54	1987 470 506 <sup>8</sup>	
					0986 473 384		←	53,94	F 026 A06 106 <sup>7</sup>	
2.0 TDI	10.10-07.11	103	PR-Code 1ZE, PR-Code 1ZP		0986 473 384		←	53,94	F 026 A06 106 <sup>7</sup>	
					0986 473 384		←	53,94	1987 470 506 <sup>8</sup>	
			PR-Code 1LV, PR-Code 1ZB		0986 474 384		→	53,94	F 026 A06 106 <sup>7</sup>	
					0986 473 384		←	53,94	F 026 A06 106 <sup>7</sup>	
			PR-Code 1LV, PR-Code 1ZB	312	0986 473 384		←	53,94	1987 470 506 <sup>8</sup>	
					0986 474 384		→	53,94	F 026 A06 106 <sup>7</sup>	
			PR-Code 1ZA, PR-Code 1ZE, PR-Code 1ZP	288,312	0986 473 384		←	53,94	F 026 A06 106 <sup>7</sup>	
					0986 473 384		←	53,94	1987 470 506 <sup>8</sup>	
			PR-Code 1ZM, PR-Code 1ZQ	228	0986 474 384		→	53,94	F 026 A06 106 <sup>7</sup>	
					0986 473 071		←	54	1987 470 506 <sup>8</sup>	
			PR-Code 1ZM, PR-Code 1ZQ	228	0986 474 071		→	54	1987 470 506 <sup>8</sup>	
					0986 473 384		←	53,94	F 026 A06 106 <sup>7</sup>	
2.0 TSI	10.10-07.14	147	PR-Code 1LV, PR-Code 1ZB	312	0986 473 384		←	53,94	F 026 A06 106 <sup>7</sup>	
					0986 473 384		←	53,94	1987 470 506 <sup>8</sup>	
			PR-Code 1LV, PR-Code 1ZB	312	0986 474 384		→	53,94	F 026 A06 106 <sup>7</sup>	
					0986 473 384		←	53,94	1987 470 506 <sup>8</sup>	
			PR-Code 1ZA, PR-Code 1ZE, PR-Code 1ZP	288,312	0986 474 384		→	53,94	F 026 A06 106 <sup>7</sup>	
					0986 473 384		←	53,94	1987 470 506 <sup>8</sup>	
			PR-Code 1ZM, PR-Code 1ZQ	228	0986 474 384		→	53,94	F 026 A06 106 <sup>7</sup>	
					0986 473 071		←	54	1987 470 506 <sup>8</sup>	
			PR-Code 1ZM, PR-Code 1ZQ	228	0986 474 071		→	54	1987 470 506 <sup>8</sup>	
					0986 473 384		←	53,94	F 026 A06 106 <sup>7</sup>	
	02.11-07.14	147	PR-Code 1LV, PR-Code 1ZB		0986 473 384		←	53,94	F 026 A06 106 <sup>7</sup>	
					0986 473 384		←	53,94	1987 470 506 <sup>8</sup>	
			PR-Code 1LV, PR-Code 1ZB	155	0986 474 384		→	53,94	F 026 A06 106 <sup>7</sup>	
					0986 473 384		←	53,94	1987 470 506 <sup>8</sup>	
			PR-Code 1LV, PR-Code 1ZB		0986 474 384		→	53,94	F 026 A06 106 <sup>7</sup>	
					0986 473 384		←	53,94	1987 470 506 <sup>8</sup>	



<b>2.0 TSI</b>	12.12-07.14	155	PR-Code 1LV, PR-Code 1ZB	312	0 986 473 384		← 53,94	F 026 A06 106 <sup>7</sup>	
					0 986 473 384		← 53,94	1 987 470 506 <sup>8</sup>	
					0 986 474 384		→ 53,94	F 026 A06 106 <sup>7</sup>	
				PR-Code 1ZA, PR-Code 1ZE, PR-Code 1ZP	288,312	0 986 473 384		← 53,94	F 026 A06 106 <sup>7</sup>
						0 986 473 384		← 53,94	1 987 470 506 <sup>8</sup>
				PR-Code 1ZM, PR-Code 1ZQ	228	0 986 473 071		← 54	1 987 470 506 <sup>8</sup>
					0 986 474 071		→ 54	1 987 470 506 <sup>8</sup>	
	<b>1.2 TSI</b>	10.10-05.11	77	PR-Code 1KG		0 986 475 865		↔ 22,2	
	<b>1.4 TSI</b>	04.11-05.11	110/118	PR-Code 1KG		0 986 475 865		↔ 22,2	
	<b>1.6 TDI</b>	10.10-05.11	77	PR-Code 1KG		0 986 475 865		↔ 22,2	
	<b>2.0 TDI, TSI</b>	10.10-05.11	103/147	PR-Code 1KG		0 986 475 865		↔ 22,2	
	<b>1.2 TSI</b>	10.10-07.14	77	PR-Code 1KD	D53	0 986 473 381		← 38,1	1 987 470 040 <sup>7</sup>
						0 986 473 381		← 38,1	1 987 474 496 <sup>8</sup>
						0 986 474 381		→ 38,1	1 987 470 040 <sup>7</sup>
				PR-Code 1KS		0 986 134 203		← 38	
						0 986 135 203		→ 38	
				PR-Code 1KU	D53				1 987 470 040 <sup>7</sup>
									1 987 474 496 <sup>8</sup>
	<b>1.4 Hybrid</b>	04.11-07.14	90/110-125	PR-Code 1KD	D53	0 986 473 381		← 38,1	1 987 470 040 <sup>7</sup>
	<b>1.4 TSI</b>					0 986 473 381		← 38,1	1 987 474 496 <sup>8</sup>
						0 986 474 381		→ 38,1	1 987 470 040 <sup>7</sup>
			PR-Code 1KS		0 986 134 203		← 38		
					0 986 135 203		→ 38		
			PR-Code 1KU	D53				1 987 470 040 <sup>7</sup>	
								1 987 474 496 <sup>8</sup>	
<b>1.6</b>	10.10-07.14	77	PR-Code 1KD	D53	0 986 473 381		← 38,1	1 987 470 040 <sup>7</sup>	
<b>1.6 TDI</b>					0 986 473 381		← 38,1	1 987 474 496 <sup>8</sup>	
					0 986 474 381		→ 38,1	1 987 470 040 <sup>7</sup>	
			PR-Code 1KS		0 986 134 203		← 38		
					0 986 135 203		→ 38		
			PR-Code 1KU	D53				1 987 470 040 <sup>7</sup>	
								1 987 474 496 <sup>8</sup>	
<b>2.0 TDI</b>	10.10-07.14	103/147/	PR-Code 1KD	D53	0 986 473 381		← 38,1	1 987 470 040 <sup>7</sup>	
<b>2.0 TSI</b>		155			0 986 473 381		← 38,1	1 987 474 496 <sup>8</sup>	
					0 986 474 381		→ 38,1	1 987 470 040 <sup>7</sup>	
			PR-Code 1KS		0 986 134 203		← 38		
					0 986 135 203		→ 38		
			PR-Code 1KU	D53				1 987 470 040 <sup>7</sup>	
								1 987 474 496 <sup>8</sup>	
	<b>1.2 TSI</b>	10.10-02.11	77	PR-Code 0N4	4SB,FMU	1 987 482 379		← 1598	
		10.10-06.13	77	PR-Code 0N4	4SB,FMU	1 987 482 379		→ 1598	
	<b>1.4 TSI</b>	04.11-06.13	90/110/118	PR-Code 0N4	4SB,FMU	1 987 482 379		→ 1598	
	<b>1.6 TDI</b>	10.10-07.14	77	PR-Code 0N4	4SB,FMU	1 987 482 379		↔ 1598	
	<b>2.0 TDI</b>	10.10-02.11	103	PR-Code 0N4	FMU	1 987 482 379		← 1598	
		10.10-07.14	103	PR-Code 0N4	FMU	1 987 482 379		→ 1598	
						4SB,FMU	1 987 482 379	↔ 1598	
	<b>2.0 TSI</b>	10.10-02.11	147	PR-Code 0N4	FMU	1 987 482 379		← 1598	
		10.10-07.14	147	PR-Code 0N4	FMU	1 987 482 379		→ 1598	
		02.11-07.14	147	PR-Code 0N4	4SB,FMU	1 987 482 379		↔ 1598	
12.12-07.14		155	PR-Code 0N4	FMU	1 987 482 379		→ 1598		
	<b>1.2 TSI</b>	10.10-07.14	77		LAB	0 986 594 504 <sup>3</sup>			
						0 986 594 506 <sup>4</sup>			
					RAB	0 986 594 505 <sup>3</sup>			
						0 986 594 507 <sup>4</sup>			



		S							
	◀ VW Jetta [162]								
1.4 Hybrid		04.11-07.14	90/110-125		LAB		0986 594 504 <sup>3</sup>		
1.4 TSI					RAB		0986 594 506 <sup>4</sup>		
							0986 594 505 <sup>3</sup>		
							0986 594 507 <sup>4</sup>		
1.6		10.10-07.14	77		LAB		0986 594 504 <sup>3</sup>		
1.6 TDI					RAB		0986 594 506 <sup>4</sup>		
							0986 594 505 <sup>3</sup>		
							0986 594 507 <sup>4</sup>		
2.0 TDI		10.10-07.14	103/147/		LAB		0986 594 504 <sup>3</sup>		
2.0 TSI			155		RAB		0986 594 506 <sup>4</sup>		
							0986 594 505 <sup>3</sup>		
							0986 594 507 <sup>4</sup>		
<b>Jetta [163]</b>									
	1.2 TSI	07.14→	77/81	PR-Code 1LV, PR-Code 1ZB	312		0986 473 384		◀ 53,94 F 026 A06 106 <sup>7</sup>
							0986 473 384		◀ 53,94 1987 470 506 <sup>8</sup>
							0986 474 384		→ 53,94 F 026 A06 106 <sup>7</sup>
				PR-Code 1ZA, PR-Code 1ZE, PR-Code 1ZP	288,312		0986 473 384		◀ 53,94 F 026 A06 106 <sup>7</sup>
							0986 473 384		◀ 53,94 1987 470 506 <sup>8</sup>
							0986 474 384		→ 53,94 F 026 A06 106 <sup>7</sup>
				PR-Code 1ZM, PR-Code 1ZQ	228		0986 473 071		◀ 54 1987 470 506 <sup>8</sup>
							0986 474 071		→ 54 1987 470 506 <sup>8</sup>
	1.4 TSI	08.14→	90/92/	PR-Code 1LV, PR-Code 1ZB	312		0986 473 384		◀ 53,94 F 026 A06 106 <sup>7</sup>
	1.4 TSI Hybrid		110-125				0986 473 384		◀ 53,94 1987 470 506 <sup>8</sup>
							0986 474 384		→ 53,94 F 026 A06 106 <sup>7</sup>
				PR-Code 1ZA, PR-Code 1ZE, PR-Code 1ZP	288,312		0986 473 384		◀ 53,94 F 026 A06 106 <sup>7</sup>
							0986 473 384		◀ 53,94 1987 470 506 <sup>8</sup>
							0986 474 384		→ 53,94 F 026 A06 106 <sup>7</sup>
				PR-Code 1ZM, PR-Code 1ZQ	228		0986 473 071		◀ 54 1987 470 506 <sup>8</sup>
							0986 474 071		→ 54 1987 470 506 <sup>8</sup>
	1.6 TDI	08.14→	77	PR-Code 1LV, PR-Code 1ZB	312		0986 473 384		◀ 53,94 F 026 A06 106 <sup>7</sup>
							0986 473 384		◀ 53,94 1987 470 506 <sup>8</sup>
							0986 474 384		→ 53,94 F 026 A06 106 <sup>7</sup>
				PR-Code 1ZA, PR-Code 1ZE, PR-Code 1ZP	288,312		0986 473 384		◀ 53,94 F 026 A06 106 <sup>7</sup>
							0986 473 384		◀ 53,94 1987 470 506 <sup>8</sup>
							0986 474 384		→ 53,94 F 026 A06 106 <sup>7</sup>
				PR-Code 1ZM, PR-Code 1ZQ	228		0986 473 071		◀ 54 1987 470 506 <sup>8</sup>
							0986 474 071		→ 54 1987 470 506 <sup>8</sup>
	2.0 TDI	07.14→	81/103/	PR-Code 1LV, PR-Code 1ZB	312		0986 473 384		◀ 53,94 F 026 A06 106 <sup>7</sup>
	2.0 TSI		110/155				0986 473 384		◀ 53,94 1987 470 506 <sup>8</sup>
							0986 474 384		→ 53,94 F 026 A06 106 <sup>7</sup>
				PR-Code 1ZA, PR-Code 1ZE, PR-Code 1ZP	288,312		0986 473 384		◀ 53,94 F 026 A06 106 <sup>7</sup>
							0986 473 384		◀ 53,94 1987 470 506 <sup>8</sup>
							0986 474 384		→ 53,94 F 026 A06 106 <sup>7</sup>
				PR-Code 1ZM, PR-Code 1ZQ	228		0986 473 071		◀ 54 1987 470 506 <sup>8</sup>
							0986 474 071		→ 54 1987 470 506 <sup>8</sup>
	1.2 TSI	07.14→	77/81	PR-Code 1KD, PR-Code 1KQ, PR-Code 1KX			0986 473 381		◀ 38,1 1987 470 040 <sup>7</sup>
							0986 473 381		◀ 38,1 1987 474 496 <sup>8</sup>
							0986 474 381		→ 38,1 1987 470 040 <sup>7</sup>
				PR-Code 1KU, PR-Code 1KY, PR-Code 1KW					1987 470 040 <sup>7</sup>
									1987 474 496 <sup>8</sup>
	1.4 TSI	08.14→	90/92/	PR-Code 1KD, PR-Code 1KQ, PR-Code 1KX			0986 473 381		◀ 38,1 1987 470 040 <sup>7</sup>
	1.4 TSI Hybrid		110-125				0986 473 381		◀ 38,1 1987 474 496 <sup>8</sup>
							0986 474 381		→ 38,1 1987 470 040 <sup>7</sup>
				PR-Code 1KU, PR-Code 1KY, PR-Code 1KW					1987 470 040 <sup>7</sup>
									1987 474 496 <sup>8</sup>

	S								
1.6 TDI	08.14→	77	PR-Code 1KD, PR-Code 1KQ, PR-Code 1KX			0 986 473 381		← 38,1	1 987 470 040 <sup>7</sup>
						0 986 473 381		← 38,1	1 987 474 496 <sup>8</sup>
						0 986 474 381		→ 38,1	1 987 470 040 <sup>7</sup>
2.0 TDI 2.0 TSI	07.14→	81/103/ 110/155	PR-Code 1KU, PR-Code 1KY, PR-Code 1KW			0 986 473 381		← 38,1	1 987 470 040 <sup>7</sup>
						0 986 473 381		← 38,1	1 987 474 496 <sup>8</sup>
						0 986 474 381		→ 38,1	1 987 470 040 <sup>7</sup>
1.2 TSI	07.14→	77/81	PR-Code 7Y0	LAB		0 986 594 504 <sup>3</sup>			
						0 986 594 505 <sup>3</sup>			
						0 986 594 506 <sup>4</sup>			
1.4 TSI 1.4 TSI Hybrid	08.14→	90/92/ 110-125	PR-Code 7Y8	LAB		0 986 594 506 <sup>4</sup>			
						0 986 594 507 <sup>4</sup>			
						0 986 594 561 <sup>4</sup>			
1.6 TDI	08.14→	77	PR-Code 7Y0	LAB		0 986 594 504 <sup>3</sup>			
						0 986 594 505 <sup>3</sup>			
						0 986 594 506 <sup>4</sup>			
2.0 TDI 2.0 TSI	07.14→	81/103/ 110/155	PR-Code 7Y8	LAB		0 986 594 506 <sup>4</sup>			
						0 986 594 507 <sup>4</sup>			
						0 986 594 561 <sup>4</sup>			
1.6 TDI	08.14→	77	PR-Code 7Y8	LAB		0 986 594 504 <sup>3</sup>			
						0 986 594 505 <sup>3</sup>			
						0 986 594 506 <sup>4</sup>			
2.0 TDI 2.0 TSI	07.14→	81/103/ 110/155	PR-Code 7Y0	LAB		0 986 594 504 <sup>3</sup>			
						0 986 594 505 <sup>3</sup>			
						0 986 594 506 <sup>4</sup>			
1.6 TDI	08.14→	77	PR-Code 7Y8	LAB		0 986 594 506 <sup>4</sup>			
						0 986 594 507 <sup>4</sup>			
						0 986 594 561 <sup>4</sup>			
2.0 TDI 2.0 TSI	07.14→	81/103/ 110/155	PR-Code 7Y8	LAB		0 986 594 506 <sup>4</sup>			
						0 986 594 507 <sup>4</sup>			
						0 986 594 561 <sup>4</sup>			
2.0 TDI 2.0 TSI	07.14→	81/103/ 110/155	PR-Code 7Y8	LAB		0 986 594 561 <sup>4</sup>			
						0 986 594 560 <sup>4</sup>			
						0 986 594 560 <sup>4</sup>			
<b>Käfer [1]</b>									
1600 i	10.92-08.04	34				0 986 475 265		↔ 22,2	
1600 i	10.92-08.04	34				0 986 475 264		↔ 17,46	
<b>Kombi</b>									
2.5 i	07.93-05.05	82-85	PR-Code 1LP	281		0 986 473 177		← 53,94	1 987 474 496 <sup>8</sup>
						0 986 474 177		→ 53,94	1 987 474 496 <sup>8</sup>
	01.96-05.05	82-85	Fg.-Nr. 70..T..200 001→, PR-Code LU	284	ATE	0 986 473 361		← 56,93	1 987 470 005 <sup>7</sup>
						0 986 473 361		← 56,93	1 987 470 506 <sup>8</sup>
	01.96-05.05	82-85	Fg.-Nr. 70..T..200 001→, PR-Code 1LE	284	LUC	0 986 474 361		→ 56,93	1 987 470 005 <sup>7</sup>
						0 986 473 806		← 54	
					0 986 473 807		→ 54		

		S							
◀ VW Kombi									
	2.5 i	01.96-05.05	82-85	Fg.-Nr. 70..T..200 001→			0986 473 073	← 38	1987 470 040 <sup>7</sup>
							0986 473 073	← 38	1987 474 496 <sup>8</sup>
							0986 474 073	→ 38	1987 470 040 <sup>7</sup>
	2.5 i	07.93-12.95	82-85	Fg.-Nr. →70..T..199 000			1987 477 171	↔ 844	
		01.96-05.05	82-85	Fg.-Nr. 70..T..200 001→			1987 477 707	↔ 953	
	2.5 i	07.93-12.95	82-85	Fg.-Nr. →70..T..199 000		MVB	0986 594 013 <sup>4</sup>		
		07.93-05.05	82-85				0265 006 407 <sup>3</sup>		
						LAB,MVB	0265 006 508 <sup>4</sup>		
						MVB,RAB	0265 006 510 <sup>4</sup>		
		01.96-05.05	82-85	Fg.-Nr. 70..T..200 001→		LAB,MVB	0265 006 408 <sup>4</sup>		
						MVB,RAB	0265 006 409 <sup>4</sup>		
LT [2D, 2H]									
	28 2.3, 2.5 SDI, 2.5 TDI, 2.8 D Turbo	05.96-04.06	55/61/66/70/75/80/				0986 473 249	← 60	
	2.8 TDI		92/96/105/116				0986 474 249	→ 60	
	35 2.3, 2.5 SDI, 2.5 TDI, 2.8 D Turbo	05.96-04.06	55/61/66/70/75/80/				0986 473 249	← 60	
	2.8 TDI		92/96/105/116				0986 474 249	→ 60	
	46 2.3	05.96-01.02	92/96/105				0986 473 250	← 44	
	46 2.8 D Turbo						0986 474 250	→ 44	
	46 2.5 SDI	05.96-04.01	55				0986 473 250	← 44	
							0986 474 250	→ 44	
	46 2.5 TDI	05.96-05.99	75				0986 473 250	← 44	
							0986 474 250	→ 44	
		05.96-05.02	80	Fg.-Nr. →2D..3H003 239			0986 473 250	← 44	
							0986 474 250	→ 44	
		05.99-04.01	66				0986 473 250	← 44	
							0986 474 250	→ 44	
		04.01-05.02	61	Fg.-Nr. →2D..3H003 239			0986 473 250	← 44	
							0986 474 250	→ 44	
			70	Fg.-Nr. →2D..3H003 239			0986 473 250	← 44	
							0986 474 250	→ 44	
		06.02-04.06	61	Fg.-Nr. 2D..3H003 240→			0986 473 231	← 45	
							0986 474 231	→ 45	
			70	Fg.-Nr. 2D..3H003 240→			0986 473 231	← 45	
							0986 474 231	→ 45	
			80	Fg.-Nr. 2D..3H003 240→			0986 473 231	← 45	
							0986 474 231	→ 45	
	46 2.8 TDI	02.02-05.02	116	Fg.-Nr. →2D..3H003 239			0986 473 250	← 44	
							0986 474 250	→ 44	
		06.02-04.06	116	Fg.-Nr. 2D..3H003 240→			0986 473 231	← 45	
							0986 474 231	→ 45	
	28 2.3, 2.5 SDI, 2.5 TDI, 2.8 D Turbo	05.96-04.06	55/61/66/70/75/80/				0986 473 363	← 44,93	1987 470 506 <sup>8</sup>
	2.8 TDI		92/96/105/116				0986 474 363	→ 44,93	1987 470 506 <sup>8</sup>
	35 2.3	05.96-04.06	55/61/66/		ATE	0986 473 353	← 51,92	1987 470 506 <sup>8</sup>	
	35 2.5 SDI		70/75/80/			0986 474 353	→ 51,92	1987 470 506 <sup>8</sup>	
	35 2.5 TDI		92/96/105/		BO	0204 102 918	← 52		
	35 2.8 D Turbo		116			0986 473 359			
	35 2.8 TDI					0204 102 919	→ 52		
						0986 474 359			
	46 2.3	05.96-10.01	96/105	Fg.-Nr. →2D..2H005 686		WAB	0986 473 250	← 44	
	46 2.8 D Turbo						0986 474 250	→ 44	
		06.01-01.02	96/105	Fg.-Nr. 2D..H005 000→		BO	0986 473 231	← 45	
							0986 474 231	→ 45	



	S								
46 2.5 SDI	05.96-04.01	55						0 986 473 250	↻ ← 44
								0 986 474 250	↻ → 44
46 2.5 TDI	05.96-05.99	75						0 986 473 250	↻ ← 44
								0 986 474 250	↻ → 44
	05.96-10.01	80	Fg.-Nr. →2D..2H016 000					0 986 473 250	↻ ← 44
								0 986 474 250	↻ → 44
	05.99-04.01	66						0 986 473 250	↻ ← 44
								0 986 474 250	↻ → 44
	05.99-10.01	80	Fg.-Nr. →2D..2H005 686			WAB		0 986 473 250	↻ ← 44
								0 986 474 250	↻ → 44
	04.01-10.01	61	Fg.-Nr. →2D..2H005 686			WAB		0 986 473 250	↻ ← 44
								0 986 474 250	↻ → 44
		70	Fg.-Nr. →2D..2H005 686			WAB		0 986 473 250	↻ ← 44
								0 986 474 250	↻ → 44
	06.01-12.03	61	Fg.-Nr. 2D..H005 000→ 2D..4..020 680			BO		0 986 473 231	↻ ← 45
								0 986 474 231	↻ → 45
		70	Fg.-Nr. 2D..H005 000→ 2D..4..020 680			BO		0 986 473 231	↻ ← 45
								0 986 474 231	↻ → 45
		80	Fg.-Nr. 2D..H005 000→ 2D..4..020 680			BO		0 986 473 231	↻ ← 45
								0 986 474 231	↻ → 45
	11.01-12.03	80	Fg.-Nr. 2D..2H016 001→ 2D..4..020 680					0 986 473 231	↻ ← 45
								0 986 474 231	↻ → 45
46 2.8 D Turbo	07.97-12.98	92						0 986 473 250	↻ ← 44
								0 986 474 250	↻ → 44
46 2.8 TDI	02.02-12.03	116	Fg.-Nr. →2D..4..020 680					0 986 473 231	↻ ← 45
								0 986 474 231	↻ → 45
	28 2.3, 2.5 SDI, 2.5 TDI, 2.8 D Turbo 2.8 TDI	05.96-04.06	55/61/66/70/ 75/80/92/ 96/105/116					1 987 477 852	1513
						R30		1 987 477 853	1435
						R35		1 987 477 854	1990
35 2.3	05.96-01.02	92/96/105						1 987 477 852	1513
35 2.8 D Turbo						R30		1 987 477 853	1435
						R35		1 987 477 854	1990
						R40		1 987 477 855	2460
35 2.5 SDI	05.96-04.06	55/61/66/ 70/75						1 987 477 852	1513
35 2.5 TDI						R30		1 987 477 853	1435
						R35		1 987 477 854	1990
						R40		1 987 477 855	2460
35 2.5 TDI	05.99-04.06	80						1 987 477 852	1513
						R30		1 987 477 853	1435
						R35		1 987 477 854	1990
						R40		1 987 477 855	2460
	12.02-04.06	80						1 987 477 852	↔ 1513
35 2.8 TDI	02.02-04.06	116						1 987 477 852	↔ 1513
						R30		1 987 477 853	1435
						R35		1 987 477 854	1990
						R40		1 987 477 855	2460
	06.03-04.06	116						1 987 477 852	1513
46 2.3	05.96-04.06	55/61/66/ 70/75/80/ 92/96/105/ 116						1 987 477 858	→ 1525
46 2.5 SDI								1 987 477 859	← 1526
46 2.5 TDI						R30		1 987 477 853	1435
46 2.8 D Turbo						R35		1 987 482 131	1970
46 2.8 TDI						R40		1 987 477 880	2440
	28 2.3, 2.5 SDI, 2.5 TDI, 2.8 D Turbo 2.8 TDI	05.96-04.06	55/61/66/70/75/80/92/96/105/116			H01		0 265 004 010 <sup>4</sup>	
		01.97-04.06	55/61/66/70/75/80/92/96/105/116			H01		0 265 004 009 <sup>3</sup>	
35 2.3, 2.5 SDI, 2.5 TDI, 2.8 D Turbo 2.8 TDI	05.96-04.06	55/61/66/70/75/80/92/96/105/116				H01		0 265 004 010 <sup>4</sup>	
	01.97-04.06	55/61/66/70/75/80/92/96/105/116				H01		0 265 004 009 <sup>3</sup>	
46 2.3, 2.5 SDI, 2.5 TDI, 2.8 D Turbo 2.8 TDI	05.96-04.06	55/61/66/70/75/80/92/96/105/116				H01		0 265 004 010 <sup>4</sup>	
	01.97-04.06	55/61/66/70/75/80/92/96/105/116				H01		0 265 004 009 <sup>3</sup>	



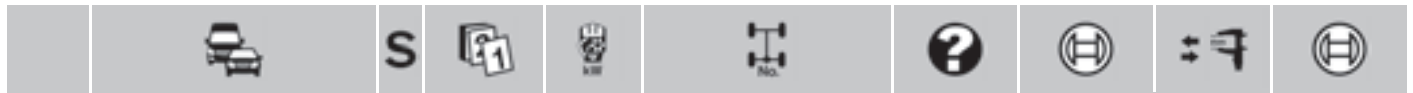

◀ VW

LT [28, 29, 21]



	28 2.4	ABO 10.88-04.96 70		0986 473 236	← 57	1987 470 487 <sup>7</sup>
		ABS 07.89-04.96 70		0986 474 236	→ 57	1987 470 487 <sup>7</sup>
				0986 473 236	← 57	1987 470 487 <sup>7</sup>
				0986 474 236	→ 57	1987 470 487 <sup>7</sup>
	28 2.4 D	ABO 08.92-04.96 51				1987 470 487 <sup>7</sup>
		ABS 08.92-04.96 51				1987 470 487 <sup>7</sup>
	28 2.4 D Turbo	ABO 09.92-04.96 70		0986 473 236	← 57	1987 470 487 <sup>7</sup>
		ABS 09.92-04.96 70		0986 474 236	→ 57	1987 470 487 <sup>7</sup>
				0986 473 236	← 57	1987 470 487 <sup>7</sup>
				0986 474 236	→ 57	1987 470 487 <sup>7</sup>
	31 2.4	ABO 10.88-04.96 70		0986 473 236	← 57	1987 470 487 <sup>7</sup>
		ABS 07.89-04.96 70		0986 474 236	→ 57	1987 470 487 <sup>7</sup>
				0986 473 236	← 57	1987 470 487 <sup>7</sup>
				0986 474 236	→ 57	1987 470 487 <sup>7</sup>
	31 2.4 D	ABO 08.92-04.96 51				1987 470 487 <sup>7</sup>
		ABS 08.92-04.96 51				1987 470 487 <sup>7</sup>
	31 2.4 D Turbo	ABO 09.92-04.96 70		0986 473 236	← 57	1987 470 487 <sup>7</sup>
		ABS 09.92-04.96 70		0986 474 236	→ 57	1987 470 487 <sup>7</sup>
				0986 473 236	← 57	1987 470 487 <sup>7</sup>
				0986 474 236	→ 57	1987 470 487 <sup>7</sup>
	35 2.4	ABO 10.88-04.96 70				1987 470 487 <sup>7</sup>
		ABS 07.89-04.96 70				1987 470 487 <sup>7</sup>
	35 2.4 D	ABO 08.92-04.96 51				1987 470 487 <sup>7</sup>
		ABS 08.92-04.96 51				1987 470 487 <sup>7</sup>
	35 2.4 D Turbo	ABO 09.92-04.96 70				1987 470 487 <sup>7</sup>
		ABS 09.92-04.96 70				1987 470 487 <sup>7</sup>
	40 2.4	ABO 10.88-04.96 70				1987 470 487 <sup>7</sup>
		ABS 07.89-04.96 70				1987 470 487 <sup>7</sup>
	40 2.4 D	ABO 08.92-04.96 51				1987 470 487 <sup>7</sup>
		ABS 08.92-04.96 51				1987 470 487 <sup>7</sup>
	40 2.4 D Turbo	ABO 09.92-04.96 70				1987 470 487 <sup>7</sup>
		ABS 09.92-04.96 70				1987 470 487 <sup>7</sup>
	45 2.4 D	ABO 08.92-04.96 51				1987 470 487 <sup>7</sup>
		ABS 08.92-04.96 51				1987 470 487 <sup>7</sup>
	45 2.4 D Turbo	ABO 09.92-04.96 70				1987 470 487 <sup>7</sup>
		ABS 09.92-04.96 70				1987 470 487 <sup>7</sup>
	50 2.4 D	ABO 08.92-04.96 51				1987 470 487 <sup>7</sup>
		ABS 08.92-04.96 51				1987 470 487 <sup>7</sup>
	50 2.4 D Turbo	ABO 09.92-04.96 70				1987 470 487 <sup>7</sup>
		ABS 09.92-04.96 70				1987 470 487 <sup>7</sup>
	55 2.4 D	ABO 08.92-04.96 51				1987 470 487 <sup>7</sup>
		ABS 08.92-04.96 51				1987 470 487 <sup>7</sup>
	55 2.4 D Turbo	ABO 09.92-04.96 70				1987 470 487 <sup>7</sup>
		ABS 09.92-04.96 70				1987 470 487 <sup>7</sup>



	28 2.4	10.88-04.96 70	ZWB	0986 475 614	↔ 26,99	
		11.90-04.96 70	Fg.-Nr. 29-M-009 907→	254	0986 475 476	↔ 25,4
	28 2.4 D	08.92-04.96 51	254	0986 475 476	↔ 25,4	
	28 2.4 D Turbo	09.92-04.96 70	254	0986 475 476	↔ 25,4	
	31 2.4	10.88-04.96 70	ZWB	0986 475 614	↔ 26,99	
		11.90-04.96 70	Fg.-Nr. 29-M-009 907→	254	0986 475 476	↔ 25,4
	31 2.4 D	08.92-04.96 51	254	0986 475 476	↔ 25,4	
	31 2.4 D Turbo	09.92-04.96 70	254	0986 475 476	↔ 25,4	
	35 2.4	10.88-04.96 70	ZWB	0986 475 614	↔ 26,99	
		11.90-04.96 70	Fg.-Nr. 29-M-009 907→	254	0986 475 476	↔ 25,4
	35 2.4 D	08.92-04.96 51	254	0986 475 476	↔ 25,4	
	35 2.4 D Turbo	09.92-04.96 70	254	0986 475 476	↔ 25,4	

		S							
40 2.4		10.88-04.96	70			ZWB	0 986 475 614	↔ 26,99	
		11.90-04.96	70		Fg.-Nr. 29-M-009 907→	254	0 986 475 476	↔ 25,4	
40 2.4 D		08.92-04.96	51			254	0 986 475 476	↔ 25,4	
40 2.4 D Turbo		09.92-04.96	70			254	0 986 475 476	↔ 25,4	
45 2.4 D, 2.4 D Turbo		08.92-04.96	51/70			254	0 986 475 476	↔ 25,4	
50 2.4 D, 2.4 D Turbo		08.92-04.96	51/70			254	0 986 475 476	↔ 25,4	
55 2.4 D, 2.4 D Turbo		08.92-04.96	51/70			254	0 986 475 476	↔ 25,4	
<b>Lupo [6X1]</b>									
	1.0	10.98-07.05	37				0 204 102 580	← 48	0 204 104 144 <sup>7</sup>
							0 986 134 020		
							0 204 102 581	→ 48	0 204 104 144 <sup>7</sup>
							0 204 103 581		
							0 986 135 020		
	1.2 TDI 3L	10.98-07.05	45						1 987 470 506 <sup>B</sup>
	1.4	10.98-07.05	74/77				0 986 473 149	← 54	1 987 470 287 <sup>7</sup>
	1.4 FSI						0 986 473 149	← 54	1 987 474 496 <sup>B</sup>
							0 986 474 149	→ 54	1 987 470 287 <sup>7</sup>
	1.4	06.98-07.05	44/55				0 204 102 580	← 48	0 204 104 144 <sup>7</sup>
	1.4 TDI						0 986 134 020		
							0 204 102 581	→ 48	0 204 104 144 <sup>7</sup>
							0 204 103 581		
						1LY	0 986 473 149	← 54	1 987 470 287 <sup>7</sup>
							0 986 473 149	← 54	1 987 474 496 <sup>B</sup>
							0 986 474 149	→ 54	1 987 470 287 <sup>7</sup>
	1.6 GTI	05.00-07.05	92				0 986 473 148	← 54	1 987 470 287 <sup>7</sup>
							0 986 473 148	← 54	1 987 474 496 <sup>B</sup>
							0 986 474 148	→ 54	1 987 470 287 <sup>7</sup>
	1.7 SDI	10.98-07.05	44				0 204 102 580	← 48	0 204 104 144 <sup>7</sup>
							0 986 134 020		
							0 204 102 581	→ 48	0 204 104 144 <sup>7</sup>
							0 204 103 581		
						1LY	0 986 473 149	← 54	1 987 470 287 <sup>7</sup>
							0 986 473 149	← 54	1 987 474 496 <sup>B</sup>
							0 986 474 149	→ 54	1 987 470 287 <sup>7</sup>
	1.0	10.98-07.05	37				0 986 475 260	↔ 17,46	
							0 986 475 438	↔ 15,87	
	1.2 TDI 3L	10.98-07.05	45				0 986 475 438	↔ 15,87	
	1.4, FSI, TDI	06.98-07.05	44/55/74/ 77				0 986 475 260	↔ 17,46	
							0 986 475 438	↔ 15,87	
	1.7 SDI	10.98-07.05	44				0 986 475 260	↔ 17,46	
							0 986 475 438	↔ 15,87	
	1.4 FSI	09.00-11.03	77				0 986 473 352	← 33,9	1 987 474 496 <sup>B</sup>
							0 986 474 352	→ 33,9	1 987 474 496 <sup>B</sup>
	1.6 GTI	05.00-07.05	92				0 986 473 352	← 33,9	1 987 474 496 <sup>B</sup>
							0 986 474 352	→ 33,9	1 987 474 496 <sup>B</sup>
	1.0	10.98-07.05	37				1 987 477 680	↔ 1392	
	1.2 TDI 3L	10.98-07.05	45				1 987 477 680	↔ 1392	
	1.4	10.98-07.05	44/55/74				1 987 477 680	↔ 1392	
	1.4 FSI	09.00-11.03	77			HTB	1 987 477 680	↔ 1392	
						4SB	1 987 477 705	↔ 1496	
	1.4 TDI	06.98-07.05	44/55/74				1 987 477 680	↔ 1392	
	1.6 GTI	05.00-07.05	92				1 987 477 705	↔ 1496	



			S							
<b>VW Lupo [6X1]</b>										
	1.7 SDI		10.98-07.05	44				1987 477 680	↔ 1392	
	1.0		10.98-07.05	37				0986 594 004 <sup>4</sup>		
		LAB						0986 594 001 <sup>3</sup>		
		RAB						0986 594 000 <sup>3</sup>		
	1.4		06.98-07.05	44/55/74/				0986 594 004 <sup>4</sup>		
	1.4 FSI			77				0986 594 001 <sup>3</sup>		
	1.4 TDI							0986 594 000 <sup>3</sup>		
	1.6 GTI		05.00-07.05	92				0986 594 004 <sup>4</sup>		
		LAB						0986 594 001 <sup>3</sup>		
		RAB						0986 594 000 <sup>3</sup>		
	1.7 SDI		10.98-07.05	44				0986 594 004 <sup>4</sup>		
		LAB						0986 594 001 <sup>3</sup>		
		RAB						0986 594 000 <sup>3</sup>		
<b>Multivan T4 [70, 7D]</b>										
	1.9 D		09.90-06.03	45/50		281		0986 473 177	← 53,94	1987 474 496 <sup>8</sup>
	1.9 D Turbo							0986 474 177	→ 53,94	1987 474 496 <sup>8</sup>
			01.96-06.03	45/50	Fg.-Nr. 70..T..200 001→, PR-Code LU	284	ATE	0986 473 361	← 56,93	1987 470 005 <sup>7</sup>
								0986 473 361	← 56,93	1987 470 506 <sup>8</sup>
								0986 474 361	→ 56,93	1987 470 005 <sup>7</sup>
					Fg.-Nr. 70..T..200 001→, PR-Code 1LE	284	LUC	0986 473 806	← 54	
								0986 473 807	→ 54	
	2.0		09.90-06.03	62		281		0986 473 177	← 53,94	1987 474 496 <sup>8</sup>
								0986 474 177	→ 53,94	1987 474 496 <sup>8</sup>
			01.96-06.03	62	Fg.-Nr. 70..T..200 001→, PR-Code LU	284	ATE	0986 473 361	← 56,93	1987 470 005 <sup>7</sup>
								0986 473 361	← 56,93	1987 470 506 <sup>8</sup>
								0986 474 361	→ 56,93	1987 470 005 <sup>7</sup>
					Fg.-Nr. 70..T..200 001→, PR-Code 1LE	284	LUC	0986 473 806	← 54	
								0986 473 807	→ 54	
	2.4 D		09.90-05.98	57		281		0986 473 177	← 53,94	1987 474 496 <sup>8</sup>
								0986 474 177	→ 53,94	1987 474 496 <sup>8</sup>
			01.96-05.98	57	Fg.-Nr. 70..T..200 001→, PR-Code LU	284	ATE	0986 473 361	← 56,93	1987 470 005 <sup>7</sup>
								0986 473 361	← 56,93	1987 470 506 <sup>8</sup>
								0986 474 361	→ 56,93	1987 470 005 <sup>7</sup>
					Fg.-Nr. 70..T..200 001→, PR-Code 1LE	284	LUC	0986 473 806	← 54	
								0986 473 807	→ 54	
			05.97-06.03	55		281		0986 473 177	← 53,94	1987 474 496 <sup>8</sup>
								0986 474 177	→ 53,94	1987 474 496 <sup>8</sup>
					PR-Code 1LE	284	LUC	0986 473 806	← 54	
								0986 473 807	→ 54	
					PR-Code 1LU	284	ATE	0986 473 361	← 56,93	1987 470 005 <sup>7</sup>
								0986 473 361	← 56,93	1987 470 506 <sup>8</sup>
								0986 474 361	→ 56,93	1987 470 005 <sup>7</sup>
	2.4 D Syncro		11.92-12.95	57	Fg.-Nr. →70..T..199 000			0986 473 177	← 53,94	1987 474 496 <sup>8</sup>
								0986 474 177	→ 53,94	1987 474 496 <sup>8</sup>
			01.96-09.98	57	Fg.-Nr. 70..T..200 001→					1987 474 496 <sup>8</sup>
	2.5		11.90-08.94	81		281		0986 473 177	← 53,94	1987 474 496 <sup>8</sup>
								0986 474 177	→ 53,94	1987 474 496 <sup>8</sup>
					PR-Code 1LE	284		0986 473 806	← 54	
								0986 473 807	→ 54	
			07.94-10.96	81				0986 473 806	← 54	
								0986 473 807	→ 54	
			08.96-06.03	81		281		0986 473 177	← 53,94	1987 474 496 <sup>8</sup>
								0986 474 177	→ 53,94	1987 474 496 <sup>8</sup>
					PR-Code 1LE	284	LUC	0986 473 806	← 54	
								0986 473 807	→ 54	
					PR-Code 1LU	284	ATE	0986 473 361	← 56,93	1987 470 005 <sup>7</sup>
								0986 473 361	← 56,93	1987 470 506 <sup>8</sup>
								0986 474 361	→ 56,93	1987 470 005 <sup>7</sup>

		S											
2.5	08.96-06.03	85	PR-Code 1LB	1KX			0 986 473 184		← 57				
							0 986 474 184		→ 57				
						326				0 986 473 259		← 57	1 987 470 005 <sup>7</sup>
										0 986 474 259		→ 57	1 987 470 005 <sup>7</sup>
						PR-Code 1LE	284			0 986 473 806		← 54	
										0 986 473 807		→ 54	
						PR-Code 1LU	284			0 986 473 361		← 56,93	1 987 470 005 <sup>7</sup>
										0 986 473 361		← 56,93	1 987 470 506 <sup>B</sup>
										0 986 474 361		→ 56,93	1 987 470 005 <sup>7</sup>
			2.5	08.96-06.03	85	PR-Code 1LP	281						1 987 474 496 <sup>B</sup>
2.5 Syncro	01.94-12.95	81	Fg.-Nr. →70..T..199 000				0 986 473 177		← 53,94	1 987 474 496 <sup>B</sup>			
							0 986 474 177		→ 53,94	1 987 474 496 <sup>B</sup>			
	01.96-10.96	81	Fg.-Nr. 70..T..200 001→							1 987 474 496 <sup>B</sup>			
	08.96-05.00	85	Fg.-Nr. →70..1..000 954,	326			0 986 473 259		← 57	1 987 470 005 <sup>7</sup>			
			PR-Code 1LB				0 986 474 259		→ 57	1 987 470 005 <sup>7</sup>			
	08.96-06.03	85	PR-Code 1LE	284	LUC		0 986 473 806		← 54				
							0 986 473 807		→ 54				
			PR-Code 1LU	284	ATE		0 986 473 361		← 56,93	1 987 470 005 <sup>7</sup>			
							0 986 473 361		← 56,93	1 987 470 506 <sup>B</sup>			
							0 986 474 361		→ 56,93	1 987 470 005 <sup>7</sup>			
	06.97-11.01	81	PR-Code 1LE		LUC		0 986 473 806		← 54				
							0 986 473 807		→ 54				
			PR-Code 1LU		ATE		0 986 473 361		← 56,93	1 987 470 005 <sup>7</sup>			
							0 986 473 361		← 56,93	1 987 470 506 <sup>B</sup>			
							0 986 474 361		→ 56,93	1 987 470 005 <sup>7</sup>			
	05.99-12.99	85	PR-Code 1LB	326			0 986 473 259		← 57	1 987 470 005 <sup>7</sup>			
							0 986 474 259		→ 57	1 987 470 005 <sup>7</sup>			
	12.99-06.03	85					0 986 473 184		← 57				
							0 986 474 184		→ 57				
	06.00-06.03	85	Fg.-Nr. 70..1..000 955→,	1KX			0 986 473 184		← 57				
			PR-Code 1LB				0 986 474 184		→ 57				
2.5 TDI	01.95-06.03	75					0 986 473 177		← 53,94	1 987 474 496 <sup>B</sup>			
							0 986 474 177		→ 53,94	1 987 474 496 <sup>B</sup>			
		05.98-05.00	111	Fg.-Nr. →70..1..000 954,	326			0 986 473 259		← 57	1 987 470 005 <sup>7</sup>		
				PR-Code 1LB				0 986 474 259		→ 57	1 987 470 005 <sup>7</sup>		
		05.98-06.03	65		281			0 986 473 177		← 53,94	1 987 474 496 <sup>B</sup>		
								0 986 474 177		→ 53,94	1 987 474 496 <sup>B</sup>		
				PR-Code 1LE	284	LUC		0 986 473 806		← 54			
								0 986 473 807		→ 54			
				PR-Code 1LU	284	ATE		0 986 473 361		← 56,93	1 987 470 005 <sup>7</sup>		
								0 986 473 361		← 56,93	1 987 470 506 <sup>B</sup>		
								0 986 474 361		→ 56,93	1 987 470 005 <sup>7</sup>		
			111	PR-Code 1LE	284	LUC		0 986 473 806		← 54			
								0 986 473 807		→ 54			
				PR-Code 1LU	284	ATE		0 986 473 361		← 56,93	1 987 470 005 <sup>7</sup>		
								0 986 473 361		← 56,93	1 987 470 506 <sup>B</sup>		
								0 986 474 361		→ 56,93	1 987 470 005 <sup>7</sup>		
		06.00-09.00	111	Fg.-Nr. 70..1..000 955→,	1KX			0 986 473 184		← 57			
				PR-Code 1LB				0 986 474 184		→ 57			
	09.00-06.03	111	PR-Code 1LB	1KX			0 986 473 184		← 57				
							0 986 474 184		→ 57				
2.5 TDI Syncro	03.98-06.03	75	PR-Code 1LB	1KX			0 986 473 184		← 57				
							0 986 474 184		→ 57				
			PR-Code 1LP	281						1 987 474 496 <sup>B</sup>			
2.5 TDI	01.95-06.03	75	PR-Code 1LE	284	LUC		0 986 473 806		← 54				
2.5 TDI Syncro							0 986 473 807		→ 54				
			PR-Code 1LU	284	ATE		0 986 473 361		← 56,93	1 987 470 005 <sup>7</sup>			
							0 986 473 361		← 56,93	1 987 470 506 <sup>B</sup>			
							0 986 474 361		→ 56,93	1 987 470 005 <sup>7</sup>			
2.8	01.96-05.00	103	PR-Code 1LB	326			0 986 473 259		← 57	1 987 470 005 <sup>7</sup>			
							0 986 474 259		→ 57	1 987 470 005 <sup>7</sup>			



<b>◀ VW Multivan T4 [70, 7D]</b>										
	<b>2.8</b>	01.96-05.00	103	PR-Code 1LE	284	LUC	0986 473 806	← 54		
				PR-Code 1LU	284	ATE	0986 473 807	→ 54		
								0986 473 361	← 56,93	1987 470 005 <sup>7</sup>
								0986 473 361	← 56,93	1987 470 506 <sup>8</sup>
								0986 474 361	→ 56,93	1987 470 005 <sup>7</sup>
		05.00-06.03	150					0986 473 184	← 57	
							0986 474 184	→ 57		
	<b>1.9 D</b>	09.90-04.97	45				0986 475 935	↔ 20,64		
	<b>1.9 D Turbo</b>	10.92-12.95	50	Fg.-Nr. →70..T..199 000			0986 475 935	↔ 20,64		
	<b>2.0</b>	09.90-12.95	62	Fg.-Nr. →70..T..199 000			0986 475 935	↔ 20,64		
	<b>2.4 D</b>	05.97-06.03	55				0986 475 935	↔ 20,64		
	<b>2.4 D, D Syncro</b>	09.90-12.95	57	Fg.-Nr. →70..T..199 000			0986 475 935	↔ 20,64		
	<b>2.5</b>	11.90-08.94	81				0986 475 935	↔ 20,64		
		07.94-12.95	81	Fg.-Nr. →70..T..199 000			0986 475 935	↔ 20,64		
		09.95-12.95	81				0986 475 935	↔ 20,64		
	<b>2.5 Syncro</b>	01.94-12.95	81	Fg.-Nr. →70..T..199 000			0986 475 935	↔ 20,64		
	<b>2.5 TDI</b>	01.95-12.95	75	Fg.-Nr. →70..T..199 000			0986 475 935	↔ 20,64		
		<b>1.9 D Turbo</b>	01.96-06.03	50	Fg.-Nr. 70..T..200 001→			0986 473 073	← 38	1987 470 040 <sup>7</sup>
							0986 473 073	← 38	1987 474 496 <sup>8</sup>	
							0986 474 073	→ 38	1987 470 040 <sup>7</sup>	
<b>2.0</b>		01.96-06.03	62	Fg.-Nr. 70..T..200 001→			0986 473 073	← 38	1987 470 040 <sup>7</sup>	
							0986 473 073	← 38	1987 474 496 <sup>8</sup>	
							0986 474 073	→ 38	1987 470 040 <sup>7</sup>	
<b>2.4 D</b>		01.96-05.98	57	Fg.-Nr. 70..T..200 001→			0986 473 073	← 38	1987 470 040 <sup>7</sup>	
							0986 473 073	← 38	1987 474 496 <sup>8</sup>	
		05.97-06.03	55			0986 473 073	← 38	1987 470 040 <sup>7</sup>		
						0986 473 073	← 38	1987 474 496 <sup>8</sup>		
						0986 474 073	→ 38	1987 470 040 <sup>7</sup>		
<b>2.4 D Syncro</b>		01.96-09.98	57	Fg.-Nr. 70..T..200 001→			0986 473 073	← 38	1987 474 496 <sup>8</sup>	
							0986 474 073	→ 38	1987 470 040 <sup>7</sup>	
<b>2.4 D, D Syncro</b>		01.96-09.98	57	Fg.-Nr. 70..T..200 001→			0986 474 073	→ 38	1987 474 496 <sup>8</sup>	
<b>2.5</b>		01.96-10.96	81	Fg.-Nr. 70..T..200 001→			0986 473 073	← 38	1987 470 040 <sup>7</sup>	
							0986 474 073	→ 38	1987 474 496 <sup>8</sup>	
		08.96-06.03	81				0986 473 073	← 38	1987 470 040 <sup>7</sup>	
							0986 474 073	→ 38	1987 474 496 <sup>8</sup>	
<b>2.5</b>		01.96-10.96	81	Fg.-Nr. 70..T..200 001→			0986 474 073	→ 38	1987 470 040 <sup>7</sup>	
<b>2.5 Syncro</b>		08.96-06.03	81				0986 474 073	→ 38	1987 470 040 <sup>7</sup>	
<b>2.5</b>		08.96-06.03	85/111				0986 473 073	← 38	1987 470 040 <sup>7</sup>	
<b>2.5 Syncro</b>							0986 473 073	← 38	1987 474 496 <sup>8</sup>	
<b>2.5 TDI</b>							0986 474 073	→ 38	1987 470 040 <sup>7</sup>	
<b>2.5 Syncro</b>		01.96-10.96	81	Fg.-Nr. 70..T..200 001→			0986 473 073	← 38	1987 470 040 <sup>7</sup>	
							0986 473 073	← 38	1987 474 496 <sup>8</sup>	
							0986 473 073	← 38	1987 470 040 <sup>7</sup>	
							0986 473 073	← 38	1987 474 496 <sup>8</sup>	
							0986 474 073	→ 38	1987 470 040 <sup>7</sup>	
<b>2.5 TDI</b>		01.96-06.03	75	Fg.-Nr. 70..T..200 001→			0986 473 073	← 38	1987 470 040 <sup>7</sup>	
							0986 473 073	← 38	1987 474 496 <sup>8</sup>	
							0986 474 073	→ 38	1987 470 040 <sup>7</sup>	
						0986 473 073	← 38	1987 470 040 <sup>7</sup>		
						0986 474 073	→ 38	1987 474 496 <sup>8</sup>		
	05.98-06.03	65				0986 473 073	← 38	1987 470 040 <sup>7</sup>		
						0986 473 073	← 38	1987 474 496 <sup>8</sup>		
						0986 474 073	→ 38	1987 470 040 <sup>7</sup>		
	05.99-06.03	75				0986 473 073	← 38	1987 470 040 <sup>7</sup>		
						0986 473 073	← 38	1987 474 496 <sup>8</sup>		
						0986 474 073	→ 38	1987 470 040 <sup>7</sup>		
<b>2.5 TDI Syncro</b>	03.98-06.03	75				0986 473 073	← 38	1987 470 040 <sup>7</sup>		
						0986 473 073	← 38	1987 474 496 <sup>8</sup>		
						0986 474 073	→ 38	1987 470 040 <sup>7</sup>		
<b>2.8</b>	01.96-06.03	103/150				0986 473 073	← 38	1987 470 040 <sup>7</sup>		
						0986 473 073	← 38	1987 474 496 <sup>8</sup>		
						0986 474 073	→ 38	1987 470 040 <sup>7</sup>		

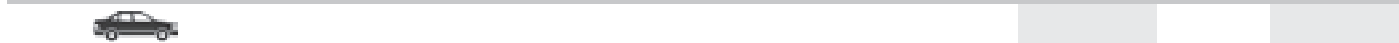

	<b>1.9D</b>	09.90-04.97	45			1 987 477 171	↔ 844
	<b>1.9D Turbo</b>	10.92-12.95	50	Fg.-Nr. →70..T..199 000	TBR	1 987 477 171	↔ 844
		01.96-02.97	50	Fg.-Nr. →70..T..200 001→ 70..V..120 000	SBR	1 987 477 706	↔ 949
		03.97-06.03	50	Fg.-Nr. 70..V..120 001→	SBR	1 987 477 707	↔ 953
	<b>2.0</b>	09.90-12.95	62	Fg.-Nr. →70..T..199 000	TBR	1 987 477 171	↔ 844
		01.96-02.97	62	Fg.-Nr. →70..T..200 001→ 70..V..120 000	SBR	1 987 477 706	↔ 949
		03.97-06.03	62	Fg.-Nr. 70..V..120 001→	SBR	1 987 477 707	↔ 953
	<b>2.4D</b>	09.90-12.95	57	Fg.-Nr. →70..T..199 000	TBR	1 987 477 171	↔ 844
		01.96-02.97	57	Fg.-Nr. →70..T..200 001→ 70..V..120 000	SBR	1 987 477 706	↔ 949
		03.97-05.98	57	Fg.-Nr. 70..V..120 001→	SBR	1 987 477 707	↔ 953
		05.97-06.03	55			1 987 477 707	↔ 953
	<b>2.4D Syncro</b>	11.92-12.95	57	Fg.-Nr. →70..T..199 000	TBR	1 987 477 171	↔ 844
		01.96-09.98	57	Fg.-Nr. →70..T..200 001→	SBR	1 987 477 706	↔ 949
	<b>2.5</b>	11.90-08.94	81			1 987 477 171	↔ 844
		07.94-12.95	81	Fg.-Nr. →70..T..199 000	TBR	1 987 477 171	↔ 844
		09.95-12.95	81			1 987 477 171	↔ 844
		01.96-10.96	81	Fg.-Nr. →70..T..200 001→	SBR	1 987 477 706	↔ 949
		08.96-02.97	81	Fg.-Nr. →70..V..120 000		1 987 477 706	↔ 949
			85	Fg.-Nr. →70..V..120 000	SBR	1 987 477 706	↔ 949
		03.97-06.03	81	Fg.-Nr. 70..V..120 001→		1 987 477 707	↔ 953
			85	Fg.-Nr. 70..V..120 001→	SBR	1 987 477 707	↔ 953
		05.99-12.99	85			1 987 477 707	↔ 953
		12.99-06.03	85		SBR	1 987 477 707	↔ 953
					TBR	1 987 477 171	↔ 844
	<b>2.5 Syncro</b>	01.94-12.95	81	Fg.-Nr. →70..T..199 000	TBR	1 987 477 171	↔ 844
		01.96-10.96	81	Fg.-Nr. →70..T..200 001→	SBR	1 987 477 706	↔ 949
		08.96-02.97	85	Fg.-Nr. →70..V..120 000		1 987 477 706	↔ 949
		03.97-06.03	85	Fg.-Nr. 70..V..120 001→		1 987 477 707	↔ 953
		06.97-11.01	81			1 987 477 706	↔ 949
		05.99-06.03	85			1 987 477 707	↔ 953
	<b>2.5 TDI</b>	01.95-02.97	75	Fg.-Nr. →70..V..120 000	SBR	1 987 477 706	↔ 949
		01.95-06.03	75		TBR	1 987 477 171	↔ 844
		03.97-06.03	75	Fg.-Nr. →70..V..120 001→	SBR	1 987 477 707	↔ 953
		05.98-06.03	65		SBR	1 987 477 707	↔ 953
					TBR	1 987 477 171	↔ 844
			111		SBR	1 987 477 707	↔ 953
					TBR	1 987 477 171	↔ 844
		05.99-06.03	75		SBR	1 987 477 707	↔ 953
	<b>2.5 TDI Syncro</b>	03.98-06.03	75			1 987 477 707	↔ 953
	<b>2.8</b>	01.96-02.97	103	Fg.-Nr. →70..V..120 000	SBR	1 987 477 706	↔ 949
		01.96-05.00	103		TBR	1 987 477 171	↔ 844
		03.97-05.00	103	Fg.-Nr. →70..V..120 001→	SBR	1 987 477 707	↔ 953
		05.00-06.03	150			1 987 477 707	↔ 953

































	<b>1.9D</b>	09.90-12.95	45/50	Fg.-Nr. →70..T..199 000	<b>MVB</b>	0 986 594 013 <sup>4</sup>	
	<b>1.9D Turbo</b>	09.90-06.03	45/50			0 265 006 407 <sup>3</sup>	
					LAB,MVB	0 265 006 508 <sup>4</sup>	
					MVB,RAB	0 265 006 510 <sup>4</sup>	
		01.96-06.03	45/50	Fg.-Nr. →70..T..200 001→	LAB, <b>MVB</b>	0 265 006 408 <sup>4</sup>	
					<b>MVB</b> ,RAB	0 265 006 409 <sup>4</sup>	
	<b>2.0</b>	09.90-12.95	62	Fg.-Nr. →70..T..199 000	<b>MVB</b>	0 986 594 013 <sup>4</sup>	
		09.90-06.03	62			0 265 006 407 <sup>3</sup>	
					LAB,MVB	0 265 006 508 <sup>4</sup>	
					MVB,RAB	0 265 006 510 <sup>4</sup>	
		01.96-06.03	62	Fg.-Nr. →70..T..200 001→	LAB, <b>MVB</b>	0 265 006 408 <sup>4</sup>	
					<b>MVB</b> ,RAB	0 265 006 409 <sup>4</sup>	



			S							
<b>VW Multivan T4 [70, 7D]</b>										
2.4D	05.97-06.03	55						0 265 006 407 <sup>3</sup>		
								LAB,MVB	0 265 006 508 <sup>4</sup>	
								LAB,MVB	0 265 006 408 <sup>4</sup>	
								MVB,RAB	0 265 006 510 <sup>4</sup>	
								MVB,RAB	0 265 006 409 <sup>4</sup>	
2.4D	09.90-12.95	57		Fg.-Nr. →70..T..199 000				MVB	0 986 594 013 <sup>4</sup>	
2.4D Syncro	09.90-09.98	57							0 265 006 407 <sup>3</sup>	
								LAB,MVB	0 265 006 508 <sup>4</sup>	
								MVB,RAB	0 265 006 510 <sup>4</sup>	
	01.96-09.98	57		Fg.-Nr. 70..T..200 001→				LAB,MVB	0 265 006 408 <sup>4</sup>	
								MVB,RAB	0 265 006 409 <sup>4</sup>	
2.5	11.90-08.94	81						MVB	0 986 594 013 <sup>4</sup>	
	07.94-12.95	81		Fg.-Nr. →70..T..199 000				MVB	0 986 594 013 <sup>4</sup>	
	09.95-12.95	81						MVB	0 986 594 013 <sup>4</sup>	
2.5	11.90-06.03	81							0 265 006 407 <sup>3</sup>	
2.5 Syncro								LAB,MVB	0 265 006 508 <sup>4</sup>	
								MVB,RAB	0 265 006 510 <sup>4</sup>	
	01.96-10.96	81		Fg.-Nr. 70..T..200 001→				LAB,MVB	0 265 006 408 <sup>4</sup>	
								MVB,RAB	0 265 006 409 <sup>4</sup>	
	08.96-06.03	81						LAB,MVB	0 265 006 408 <sup>4</sup>	
								MVB,RAB	0 265 006 409 <sup>4</sup>	
2.5	08.96-06.03	85/111							0 265 006 407 <sup>3</sup>	
2.5 Syncro								LAB,MVB	0 265 006 508 <sup>4</sup>	
2.5 TDI								LAB,MVB	0 265 006 408 <sup>4</sup>	
								MVB,RAB	0 265 006 510 <sup>4</sup>	
								MVB,RAB	0 265 006 409 <sup>4</sup>	
2.5 Syncro	01.94-12.95	81		Fg.-Nr. →70..T..199 000				MVB	0 986 594 013 <sup>4</sup>	
2.5 TDI	01.95-12.95	75		Fg.-Nr. →70..T..199 000				MVB	0 986 594 013 <sup>4</sup>	
	01.96-06.03	75		Fg.-Nr. 70..T..200 001→				LAB,MVB	0 265 006 408 <sup>4</sup>	
								MVB,RAB	0 265 006 409 <sup>4</sup>	
	05.98-06.03	65							0 265 006 407 <sup>3</sup>	
								LAB,MVB	0 265 006 508 <sup>4</sup>	
								LAB,MVB	0 265 006 408 <sup>4</sup>	
								MVB,RAB	0 265 006 510 <sup>4</sup>	
								MVB,RAB	0 265 006 409 <sup>4</sup>	
	05.99-06.03	75						LAB,MVB	0 265 006 408 <sup>4</sup>	
								MVB,RAB	0 265 006 409 <sup>4</sup>	
2.5 TDI Syncro	03.98-06.03	75						LAB,MVB	0 265 006 408 <sup>4</sup>	
								MVB,RAB	0 265 006 409 <sup>4</sup>	
2.5 TDI	01.95-06.03	75							0 265 006 407 <sup>3</sup>	
2.5 TDI Syncro								LAB,MVB	0 265 006 508 <sup>4</sup>	
								MVB,RAB	0 265 006 510 <sup>4</sup>	
2.8	01.96-06.03	103/150							0 265 006 407 <sup>3</sup>	
								LAB,MVB	0 265 006 508 <sup>4</sup>	
								LAB,MVB	0 265 006 408 <sup>4</sup>	
								MVB,RAB	0 265 006 510 <sup>4</sup>	
								MVB,RAB	0 265 006 409 <sup>4</sup>	

**Multivan T5 [7E]**

	2.0, TDI, TDI 4Motion, TSI, TSI 4Motion	09.09→	62/75/84/85/100/ 103/110/132/150					0 986 134 004		← 41
								0 986 135 004		→ 41
	2.0	09.09→	62/75/84/85					1 987 477 260		↔ 1303
	2.0 TDI	09.09→	62/75/84/85					1 987 477 260		↔ 1303
			100/103					1 987 477 260		↔ 1303
			132/150					1 987 477 260		↔ 1303
	2.0 TDI 4Motion	09.09→	100/103			FKR		1 987 482 376		↔ 1631
						FLR		1 987 482 017		↔ 2015

		S							
2.0 TDI 4Motion	09.09→	132/150				FKR	1 987 482 376	↔ 1631	
						FLR	1 987 482 017	↔ 2015	
2.0 TSI	05.11→	132/150					1 987 477 260	↔ 1303	
	07.12→	110					1 987 477 260	↔ 1303	
2.0 TSI 4Motion	07.11→	132/150				FKR	1 987 482 376	↔ 1631	
						FLR	1 987 482 017	↔ 2015	
 2.0, TDI, TDI 4Motion, TSI, TSI 4Motion	09.09→	62/75/84/85/100/ 103/110/132/150				LAB	0 986 594 504		
						RAB	0 986 594 505		
<b>Multivan T5 [7H]</b>									
									
 1.9 TDI	04.03-11.09	62/63/75/ 77				294	0 986 134 004	 ← 41	
							0 986 135 004	 → 41	
						322	0 986 473 188	 ← 44	1 987 470 506 <sup>B</sup>
2.0	06.03-11.09	85				294	0 986 134 004	 ← 41	
							0 986 135 004	 → 41	
						322	0 986 473 188	 ← 44	1 987 470 506 <sup>B</sup>
2.5 TDI 2.5 TDI 4Motion	02.03-11.09	96/120/ 128				294	0 986 134 004	 ← 41	
							0 986 135 004	 → 41	
						322	0 986 473 188	 ← 44	1 987 470 506 <sup>B</sup>
3.2	02.03-06.04	170				294	0 986 134 004	 ← 41	
							0 986 135 004	 → 41	
						322	0 986 473 188	 ← 44	1 987 470 506 <sup>B</sup>
3.2 3.2 4Motion 3.2 4Motion	05.03-11.09	173				294	0 986 134 004	 ← 41	
							0 986 135 004	 → 41	
						322	0 986 473 188	 ← 44	1 987 470 506 <sup>B</sup>
3.2 3.2 4Motion 3.2 4Motion	05.03-11.09	173				294	0 986 134 004	 ← 41	
							0 986 135 004	 → 41	
						322	0 986 473 188	 ← 44	1 987 470 506 <sup>B</sup>
3.2 3.2 4Motion 3.2 4Motion	07.04-11.09	173				294	0 986 134 004	 ← 41	
							0 986 135 004	 → 41	
						322	0 986 473 188	 ← 44	1 987 470 506 <sup>B</sup>
 1.9 TDI	04.03-11.09	62/63/75/ 77					1 987 477 260	↔ 1303	
							1 987 482 014	↔ 1270	
							1 987 477 260	↔ 1303	
2.0	06.03-11.09	85					1 987 477 260	↔ 1303	
							1 987 482 014	↔ 1270	
							1 987 477 260	↔ 1303	
2.5 TDI	02.03-11.09	96					1 987 477 260	↔ 1303	
							1 987 482 014	↔ 1270	
							1 987 477 260	↔ 1303	
2.5 TDI 4Motion	07.04-11.09	96				FKR	1 987 482 016	↔ 1650	
						FLR	1 987 482 017	↔ 2015	
							1 987 482 016	↔ 1650	
3.2	02.03-06.04	170					1 987 477 260	↔ 1303	
							1 987 482 014	↔ 1270	
							1 987 477 260	↔ 1303	







































































	◀ VW Multivan T5 [7H]									
	3.2	05.03-11.09	173	PR-Code OWN, PR-Code OWP, PR-Code OWQ, PR-Code OWL, PR-Code OWM PR-Code OWR			1987 477 260	↔ 1303		
	3.2 4Motion	07.04-11.09	173		FKR FLR		1987 482 014 1987 482 016 1987 482 017	↔ 1270 ↔ 1650 ↔ 2015		
	1.9 TDI	04.03-11.09	62/63/75/ 77		LAB RAB		0986 594 504 <sup>3</sup> 0986 594 504 <sup>4</sup> 0986 594 505 <sup>3</sup> 0986 594 505 <sup>4</sup>			
	2.0	06.03-11.09	85		LAB RAB		0986 594 504 <sup>3</sup> 0986 594 504 <sup>4</sup> 0986 594 505 <sup>3</sup> 0986 594 505 <sup>4</sup>			
	2.5 TDI	02.03-11.09	96		LAB RAB		0986 594 504 <sup>3</sup> 0986 594 504 <sup>4</sup> 0986 594 505 <sup>3</sup> 0986 594 505 <sup>4</sup>			
			128		LAB RAB		0986 594 504 <sup>3</sup> 0986 594 504 <sup>4</sup> 0986 594 505 <sup>3</sup> 0986 594 505 <sup>4</sup>			
		11.03-11.09	120		LAB RAB		0986 594 504 <sup>3</sup> 0986 594 504 <sup>4</sup> 0986 594 505 <sup>3</sup> 0986 594 505 <sup>4</sup>			
	2.5 TDI 4Motion	07.04-11.09	96		LAB RAB		0986 594 504 0986 594 505			
			128		LAB RAB		0986 594 504 0986 594 505			
	3.2	02.03-06.04	170		LAB RAB		0986 594 504 <sup>3</sup> 0986 594 504 <sup>4</sup> 0986 594 505 <sup>3</sup> 0986 594 505 <sup>4</sup>			
		05.03-11.09	173		LAB RAB		0986 594 504 <sup>3</sup> 0986 594 504 <sup>4</sup> 0986 594 505 <sup>3</sup> 0986 594 505 <sup>4</sup>			
	3.2 4Motion	07.04-11.09	173		LAB RAB		0986 594 504 0986 594 505			

**Multivan T6 [SG]**

	2.0 TDI, TDI 4Motion, TFSI, TFSI 4Motion	04.15→	62/75/103/110/ 132/150				0986 134 004 0986 135 004	← 41 → 41	
	2.0 TDI	04.15→	62/75/103/110/132/150				1987 477 260	↔ 1303	
	2.0 TFSI	04.15→	62/75/103/110/132/150				1987 477 260	↔ 1303	
	2.0 TDI, TDI 4Motion, TFSI, TFSI 4Motion	04.15→	62/75/103/110/132/150		LAB RAB		0986 594 504 0986 594 505		



































**Multivan T6 [SSG]**

	2.0 TDI 4Motion	04.15→	103				0986 134 004 0986 135 004	← 41 → 41	

		S							
									
 <b>2.0 TDI 4Motion</b>	04.15→	103				LAB	0 986 594 504		
						RAB	0 986 594 505		
<b>New Beetle Cabriolet [1Y7]</b>									
									
 <b>1.4</b>	01.03-09.10	55				228	0 986 473 071	 ← 54	1 987 470 506 <sup>B</sup>
							0 986 474 071	 → 54	1 987 470 506 <sup>B</sup>
						288	0 986 471 923	 ← 54	1 987 470 506 <sup>B</sup>
							0 986 473 923		
							0 986 471 924	 → 54	1 987 470 506 <sup>B</sup>
							0 986 473 924		
<b>1.6</b>	01.03-09.10	75				228	0 986 473 071	 ← 54	1 987 470 506 <sup>B</sup>
							0 986 474 071	 → 54	1 987 470 506 <sup>B</sup>
						288	0 986 471 923	 ← 54	1 987 470 506 <sup>B</sup>
							0 986 473 923		
							0 986 471 924	 → 54	1 987 470 506 <sup>B</sup>
							0 986 473 924		
<b>1.8 T</b>	01.03-06.04	110	PR-Code 1ZD, PR-Code 1ZE			288	0 986 471 923	 ← 54	1 987 470 506 <sup>B</sup>
							0 986 473 923		
							0 986 471 924	 → 54	1 987 470 506 <sup>B</sup>
							0 986 473 924		
			PR-Code 1ZP, PR-Code 1ZM			228	0 986 473 071	 ← 54	1 987 470 506 <sup>B</sup>
							0 986 474 071	 → 54	1 987 470 506 <sup>B</sup>
	12.03-09.10	110				228	0 986 473 071	 ← 54	1 987 470 506 <sup>B</sup>
							0 986 474 071	 → 54	1 987 470 506 <sup>B</sup>
						288	0 986 471 923	 ← 54	1 987 470 506 <sup>B</sup>
							0 986 473 923		
							0 986 471 924	 → 54	1 987 470 506 <sup>B</sup>
							0 986 473 924		
<b>1.9 TDI</b>	06.03-06.06	74				228	0 986 473 071	 ← 54	1 987 470 506 <sup>B</sup>
							0 986 474 071	 → 54	1 987 470 506 <sup>B</sup>
						288	0 986 471 923	 ← 54	1 987 470 506 <sup>B</sup>
							0 986 473 923		
							0 986 471 924	 → 54	1 987 470 506 <sup>B</sup>
							0 986 473 924		
	07.05-09.10	77	PR-Code 1ZD, PR-Code 1ZE			288	0 986 471 923	 ← 54	1 987 470 506 <sup>B</sup>
							0 986 473 923		
							0 986 471 924	 → 54	1 987 470 506 <sup>B</sup>
							0 986 473 924		
			PR-Code 1ZP, PR-Code 1ZM, PR-Code 1ZF			228	0 986 473 071	 ← 54	1 987 470 506 <sup>B</sup>
							0 986 474 071	 → 54	1 987 470 506 <sup>B</sup>
<b>2.0</b>	01.03-10.10	85				228	0 986 473 071	 ← 54	1 987 470 506 <sup>B</sup>
							0 986 474 071	 → 54	1 987 470 506 <sup>B</sup>
						288	0 986 471 923	 ← 54	1 987 470 506 <sup>B</sup>
							0 986 473 923		
							0 986 471 924	 → 54	1 987 470 506 <sup>B</sup>
							0 986 473 924		
<b>2.5</b>	07.05-09.10	110				228	0 986 473 071	 ← 54	1 987 470 506 <sup>B</sup>
							0 986 474 071	 → 54	1 987 470 506 <sup>B</sup>
						288	0 986 471 923	 ← 54	1 987 470 506 <sup>B</sup>
							0 986 473 923		
							0 986 471 924	 → 54	1 987 470 506 <sup>B</sup>
							0 986 473 924		
									
 <b>1.4</b>	01.03-09.10	55					0 986 473 099	 ← 38,1	1 987 470 040 <sup>7</sup>
							0 986 473 099	 ← 38,1	1 987 474 496 <sup>B</sup>
							0 986 474 099	 → 38,1	1 987 470 040 <sup>7</sup>



		S									
<b>VW New Beetle Cabriolet [1Y7]</b>											
1.6	01.03-09.10	75					0986 473 099	← 38,1	1987 470 040 <sup>7</sup>		
							0986 473 099	← 38,1	1987 474 496 <sup>8</sup>		
							0986 474 099	→ 38,1	1987 470 040 <sup>7</sup>		
1.8 T	01.03-09.10	110					0986 473 099	← 38,1	1987 470 040 <sup>7</sup>		
							0986 473 099	← 38,1	1987 474 496 <sup>8</sup>		
							0986 474 099	→ 38,1	1987 470 040 <sup>7</sup>		
1.9 TDI	06.03-09.10	74/77					0986 473 099	← 38,1	1987 470 040 <sup>7</sup>		
							0986 473 099	← 38,1	1987 474 496 <sup>8</sup>		
							0986 474 099	→ 38,1	1987 470 040 <sup>7</sup>		
2.0	01.03-10.10	85					0986 473 099	← 38,1	1987 470 040 <sup>7</sup>		
							0986 473 099	← 38,1	1987 474 496 <sup>8</sup>		
							0986 474 099	→ 38,1	1987 470 040 <sup>7</sup>		
2.5	07.05-09.10	110					0986 473 099	← 38,1	1987 470 040 <sup>7</sup>		
							0986 473 099	← 38,1	1987 474 496 <sup>8</sup>		
							0986 474 099	→ 38,1	1987 470 040 <sup>7</sup>		
U	01.03-09.10	55					1987 477 698	↔ 1693			
							1987 477 698	↔ 1693			
							1987 477 698	↔ 1693			
							1987 477 698	↔ 1693			
							1987 477 698	↔ 1693			
							1987 477 698	↔ 1693			
T	01.03-09.10	55					0986 594 004 <sup>4</sup>				
							LAB	0986 594 001 <sup>3</sup>			
							RAB	0986 594 000 <sup>3</sup>			
	01.03-09.10	75						0986 594 004 <sup>4</sup>			
								LAB	0986 594 001 <sup>3</sup>		
								RAB	0986 594 000 <sup>3</sup>		
	01.03-09.10	110						0986 594 004 <sup>4</sup>			
								LAB	0986 594 001 <sup>3</sup>		
								RAB	0986 594 000 <sup>3</sup>		
	06.03-09.10	74/77						0986 594 004 <sup>4</sup>			
								LAB	0986 594 001 <sup>3</sup>		
								RAB	0986 594 000 <sup>3</sup>		
	01.03-10.10	85						0986 594 004 <sup>4</sup>			
								LAB	0986 594 001 <sup>3</sup>		
								RAB	0986 594 000 <sup>3</sup>		
	07.05-09.10	110						0986 594 004 <sup>4</sup>			
								LAB	0986 594 001 <sup>3</sup>		
								RAB	0986 594 000 <sup>3</sup>		
<b>New Beetle [1C1/9C1]</b>											
S	11.01-09.10	55				228	0986 473 071	← 54	1987 470 506 <sup>8</sup>		
							0986 474 071	→ 54	1987 470 506 <sup>8</sup>		
							288,312	0986 471 923	← 54	1987 470 506 <sup>8</sup>	
							0986 473 923				
							0986 471 924	→ 54	1987 470 506 <sup>8</sup>		
	10.99-10.00	74					228	0986 473 071	← 54	1987 470 506 <sup>8</sup>	
								0986 474 071	→ 54	1987 470 506 <sup>8</sup>	
		06.00-06.05	75						0986 473 071	← 54	1987 470 506 <sup>8</sup>
									0986 474 071	→ 54	1987 470 506 <sup>8</sup>
									0986 471 923	← 54	1987 470 506 <sup>8</sup>
06.02-12.10	75					288,312	0986 471 923	← 54	1987 470 506 <sup>8</sup>		
							0986 473 923				
							0986 471 924	→ 54	1987 470 506 <sup>8</sup>		
							0986 473 924				
							PR-Code 1ZM, PR-Code 1ZF	228	0986 473 071	← 54	1987 470 506 <sup>8</sup>
PR-Code 1ZD, PR-Code 1ZE, PR-Code 1LJ	288,312	0986 474 071	→ 54	1987 470 506 <sup>8</sup>							
<b>V</b>											

		S								
1.8 T	01.98-07.05	110/132	PR-Code 1ZD, PR-Code 1ZE	288	0 986 471 923	← 54	1 987 470 506 <sup>B</sup>			
					0 986 473 923					
					0 986 471 924	→ 54				
	01.98-12.10	110/132			228	0 986 473 071	 ← 54	1 987 470 506 <sup>B</sup>		
						0 986 474 071	 → 54			
						0 986 473 924				
	10.00-12.10	110/132			288,312	0 986 471 923	← 54	1 987 470 506 <sup>B</sup>		
						0 986 473 923				
						0 986 471 924	→ 54			
1.9 TDI	01.98-06.04	66		228	0 986 473 071	 ← 54	1 987 470 506 <sup>B</sup>			
					0 986 474 071	 → 54				
					PR-Code 1ZD, PR-Code 1ZE	288		0 986 471 923	← 54	1 987 470 506 <sup>B</sup>
			0 986 473 923							
			0 986 471 924	→ 54						
	10.00-12.10	74			228	0 986 473 071	 ← 54	1 987 470 506 <sup>B</sup>		
						0 986 474 071	 → 54			
						288,312	0 986 471 923		← 54	1 987 470 506 <sup>B</sup>
				0 986 473 923						
				0 986 471 924	→ 54					
		06.03-12.06	74	PR-Code 1ZD, PR-Code 1ZE	288	0 986 471 923	← 54	1 987 470 506 <sup>B</sup>		
	0 986 473 923									
	0 986 471 924					→ 54				
	07.05-12.10	77			228	0 986 473 071	 ← 54	1 987 470 506 <sup>B</sup>		
						0 986 474 071	 → 54			
						288,312	0 986 471 923		← 54	1 987 470 506 <sup>B</sup>
				0 986 473 923						
				0 986 471 924	→ 54					
2.0		01.98-06.07	85	PR-Code 1ZD, PR-Code 1ZE	288	0 986 471 923	← 54	1 987 470 506 <sup>B</sup>		
	0 986 473 923									
	0 986 471 924					→ 54				
	01.98-09.10	85			228	0 986 473 071	 ← 54	1 987 470 506 <sup>B</sup>		
						0 986 474 071	 → 54			
	11.98-06.05	85				0 986 473 071	 ← 54	1 987 470 506 <sup>B</sup>		
						0 986 474 071	 → 54			
	06.01-09.10	85			288,312	0 986 471 923	← 54	1 987 470 506 <sup>B</sup>		
						0 986 473 923				
						0 986 471 924	→ 54			
	2.3	10.00-06.05	125		288,312	0 986 471 923	← 54	1 987 470 506 <sup>B</sup>		
						0 986 473 923				
0 986 471 924						→ 54				
2.5	07.05-09.10	110		228	0 986 473 071	 ← 54	1 987 470 506 <sup>B</sup>			
					0 986 474 071	 → 54				
					288,312	0 986 471 923		← 54	1 987 470 506 <sup>B</sup>	
			0 986 473 923							
			0 986 471 924	→ 54						
	3.2 RSI 4x4	10.00-05.01	165			0 986 471 923	← 54	1 987 470 506 <sup>B</sup>		
0 986 473 923										
0 986 471 924						→ 54				
0 986 473 924										



◀ VW New Beetle [1C1/9C1]									
	1.4	11.01-09.10	55			0986 473 099	← 38,1	1987 470 040 <sup>7</sup>	
				0986 473 099	← 38,1	1987 474 496 <sup>8</sup>			
				0986 474 099	→ 38,1	1987 470 040 <sup>7</sup>			
1.6	10.99-10.00	74			0986 473 099	← 38,1	1987 470 040 <sup>7</sup>		
			0986 473 099	← 38,1	1987 474 496 <sup>8</sup>				
			0986 474 099	→ 38,1	1987 470 040 <sup>7</sup>				
	06.00-06.05	75	PR-Code 1KV, PR-Code 1KS	232	0986 473 099	← 38,1	1987 470 040 <sup>7</sup>		
					0986 473 099	← 38,1	1987 474 496 <sup>8</sup>		
					0986 474 099	→ 38,1	1987 470 040 <sup>7</sup>		
			PR-Code 1KY	252	0986 473 139	← 38,1	1987 470 040 <sup>7</sup>		
					0986 473 139	← 38,1	1987 474 496 <sup>8</sup>		
					0986 474 139	→ 38,1	1987 470 040 <sup>7</sup>		
	06.02-12.10	75			0986 473 099	← 38,1	1987 470 040 <sup>7</sup>		
0986 473 099			← 38,1	1987 474 496 <sup>8</sup>					
0986 474 099			→ 38,1	1987 470 040 <sup>7</sup>					
1.8 T	01.98-07.99	110	Fg.-Nr. →1C..Y..414 262, →9C..Y..607 008, PR-Code 1KS, PR-Code 1KV		0986 473 072	← 38	1987 470 040 <sup>7</sup>		
					0986 473 072	← 38	1987 474 496 <sup>8</sup>		
					0986 474 072	→ 38	1987 470 040 <sup>7</sup>		
	08.99-05.01	110	Fg.-Nr. 1C..Y..414 263→, 9C..Y..607 009→, PR-Code 1KV, PR-Code 1KS		0986 473 099	← 38,1	1987 470 040 <sup>7</sup>		
					0986 473 099	← 38,1	1987 474 496 <sup>8</sup>		
					0986 474 099	→ 38,1	1987 470 040 <sup>7</sup>		
	06.00-12.10	110			0986 473 099	← 38,1	1987 470 040 <sup>7</sup>		
			0986 473 099	← 38,1	1987 474 496 <sup>8</sup>				
			0986 474 099	→ 38,1	1987 470 040 <sup>7</sup>				
	06.01-07.05	132			0986 473 099	← 38,1	1987 470 040 <sup>7</sup>		
			0986 473 099	← 38,1	1987 474 496 <sup>8</sup>				
			0986 474 099	→ 38,1	1987 470 040 <sup>7</sup>				
1.9 TDI	01.98-07.99	66	Fg.-Nr. →1C..Y..414 262, →9C..Y..607 008, PR-Code 1KS, PR-Code 1KV		0986 473 072	← 38	1987 470 040 <sup>7</sup>		
					0986 473 072	← 38	1987 474 496 <sup>8</sup>		
					0986 474 072	→ 38	1987 470 040 <sup>7</sup>		
	08.99-06.04	66	Fg.-Nr. 1C..Y..414 263→, 9C..Y..607 009→, PR-Code 1KV, PR-Code 1KS		0986 473 099	← 38,1	1987 470 040 <sup>7</sup>		
					0986 473 099	← 38,1	1987 474 496 <sup>8</sup>		
					0986 474 099	→ 38,1	1987 470 040 <sup>7</sup>		
10.00-12.10	74/77			0986 473 099	← 38,1	1987 470 040 <sup>7</sup>			
		0986 473 099	← 38,1	1987 474 496 <sup>8</sup>					
		0986 474 099	→ 38,1	1987 470 040 <sup>7</sup>					
2.0	01.98-07.99	85	Fg.-Nr. →1C..Y..414 262, →9C..Y..607 008, PR-Code 1KS, PR-Code 1KV		0986 473 072	← 38	1987 470 040 <sup>7</sup>		
					0986 473 072	← 38	1987 474 496 <sup>8</sup>		
					0986 474 072	→ 38	1987 470 040 <sup>7</sup>		
	11.98-06.05	85	PR-Code 1KY	252	0986 473 139	← 38,1	1987 470 040 <sup>7</sup>		
					0986 473 139	← 38,1	1987 474 496 <sup>8</sup>		
					0986 474 139	→ 38,1	1987 470 040 <sup>7</sup>		
	08.99-10.01	85	Fg.-Nr. 1C..Y..414 263→, 9C..Y..607 009→, PR-Code 1KV, PR-Code 1KS		0986 473 099	← 38,1	1987 470 040 <sup>7</sup>		
					0986 473 099	← 38,1	1987 474 496 <sup>8</sup>		
					0986 474 099	→ 38,1	1987 470 040 <sup>7</sup>		
	08.99-06.05	85	Fg.-Nr. 1C..Y..414 263→, 9C..Y..607 009→, PR-Code 1KV, PR-Code 1KS		0986 473 099	← 38,1	1987 470 040 <sup>7</sup>		
					0986 473 099	← 38,1	1987 474 496 <sup>8</sup>		
					0986 474 099	→ 38,1	1987 470 040 <sup>7</sup>		
	06.00-09.10	85			0986 473 099	← 38,1	1987 470 040 <sup>7</sup>		
			0986 473 099	← 38,1	1987 474 496 <sup>8</sup>				
			0986 474 099	→ 38,1	1987 470 040 <sup>7</sup>				
09.00-06.05	85	PR-Code 1KV, PR-Code 1KS	232	0986 473 099	← 38,1	1987 470 040 <sup>7</sup>			
				0986 473 099	← 38,1	1987 474 496 <sup>8</sup>			
				0986 474 099	→ 38,1	1987 470 040 <sup>7</sup>			
2.3	10.00-06.05	125			0986 473 099	← 38,1	1987 470 040 <sup>7</sup>		
			0986 473 099	← 38,1	1987 474 496 <sup>8</sup>				
			0986 474 099	→ 38,1	1987 470 040 <sup>7</sup>				
2.5	07.05-09.10	110			0986 473 099	← 38,1	1987 470 040 <sup>7</sup>		
			0986 473 099	← 38,1	1987 474 496 <sup>8</sup>				
			0986 474 099	→ 38,1	1987 470 040 <sup>7</sup>				





3.2 RSI 4x4	10.00-05.01	165			0 986 473 139	← 38,1	1 987 470 040 <sup>7</sup>
					0 986 473 139	← 38,1	1 987 474 496 <sup>8</sup>
					0 986 474 139	→ 38,1	1 987 470 040 <sup>7</sup>



	1.4	11.01-09.10	55				1 987 477 698 ↔ 1693	
	1.6	10.99-12.10	74/75				1 987 477 698 ↔ 1693	
	1.8 T	01.98-07.99	110	Fg.-Nr. →1C..Y..414 262, →9C..Y..607 008				1 987 477 696 ↔ 1688
		08.99-05.01	110	Fg.-Nr. 1C..Y..414 263→, 9C..Y..607 009→				1 987 477 698 ↔ 1693
		06.00-12.10	110					1 987 477 698 ↔ 1693
		06.01-07.05	132					1 987 477 698 ↔ 1693
	1.9 TDI	01.98-07.99	66	Fg.-Nr. →1C..Y..414 262, →9C..Y..607 008				1 987 477 696 ↔ 1688
		08.99-06.04	66	Fg.-Nr. 1C..Y..414 263→, 9C..Y..607 009→				1 987 477 698 ↔ 1693
		10.00-12.10	74/77					1 987 477 698 ↔ 1693
	2.0	01.98-07.99	85	Fg.-Nr. →1C..Y..414 262, →9C..Y..607 008				1 987 477 696 ↔ 1688
08.99-06.05		85	Fg.-Nr. 1C..Y..414 263→, 9C..Y..607 009→				1 987 477 698 ↔ 1693	
06.00-09.10		85					1 987 477 698 ↔ 1693	
2.3	10.00-06.05	125				1 987 477 698 ↔ 1693		
2.5	07.05-09.10	110				1 987 477 698 ↔ 1693		
3.2 RSI 4x4	10.00-05.01	165				1 987 477 686 ↔ 1723		

	1.4	11.01-09.10	55		0 986 594 004 <sup>4</sup>		
				LAB	0 986 594 001 <sup>3</sup>		
				RAB	0 986 594 000 <sup>3</sup>		
1.6	10.99-12.10	74/75		0 986 594 004 <sup>4</sup>			
			LAB	0 986 594 001 <sup>3</sup>			
				RAB	0 986 594 000 <sup>3</sup>		
1.8 T	01.98-12.10	110/132		0 986 594 004 <sup>4</sup>			
			LAB	0 986 594 001 <sup>3</sup>			
				RAB	0 986 594 000 <sup>3</sup>		
1.9 TDI	01.98-12.10	66/74/77		0 986 594 004 <sup>4</sup>			
			LAB	0 986 594 001 <sup>3</sup>			
				RAB	0 986 594 000 <sup>3</sup>		
2.0	01.98-09.10	85		0 986 594 004 <sup>4</sup>			
			LAB	0 986 594 001 <sup>3</sup>			
				RAB	0 986 594 000 <sup>3</sup>		
2.3	10.00-06.05	125		0 986 594 004 <sup>4</sup>			
			LAB	0 986 594 001 <sup>3</sup>			
				RAB	0 986 594 000 <sup>3</sup>		
2.5	07.05-09.10	110		0 986 594 004 <sup>4</sup>			
			LAB	0 986 594 001 <sup>3</sup>			
				RAB	0 986 594 000 <sup>3</sup>		
3.2 RSI 4x4	10.00-05.01	165		0 986 594 004 <sup>4</sup>			
			LAB	0 986 594 001 <sup>3</sup>			
				RAB	0 986 594 000 <sup>3</sup>		

**Pasat [3G2]**



	2.0 TDI 4Motion	05.15→	110		0 986 594 500 <sup>3</sup>		
					0 986 594 524 <sup>4</sup>		
				RAB	0 986 594 501 <sup>3</sup>		
					0 986 594 525 <sup>4</sup>		

**Passat Alltrack [3G5]**



	1.4 TSI 4Motion	05.15→	110		0 986 594 500 <sup>3</sup>		
					0 986 594 524 <sup>4</sup>		
				RAB	0 986 594 501 <sup>3</sup>		
					0 986 594 525 <sup>4</sup>		



		S							
	◀ VW Passat Alltrack [3G5]								
	2.0 TDI 4Motion	05.15→	110/135/			LAB	0986 594 500 <sup>3</sup>		
	2.0 TFSI 4Motion		140/162/			RAB	0986 594 524 <sup>4</sup>		
			176				0986 594 501 <sup>3</sup>		
							0986 594 525 <sup>4</sup>		
<b>Passat Alltrack [365]</b>									
	1.8 TFSI	01.12→	112/118	PR-Code 1ZM, PR-Code 1ZG	312		0986 473 384	← 53,94	F 026 A06 106 <sup>7</sup>
							0986 473 384	← 53,94	1987 470 506 <sup>8</sup>
							0986 474 384	→ 53,94	F 026 A06 106 <sup>7</sup>
	2.0 TDI	01.12→	103/125/	PR-Code 1ZM, PR-Code 1ZG	312		0986 473 384	← 53,94	F 026 A06 106 <sup>7</sup>
	2.0 TDI 4Motion		130/155				0986 473 384	← 53,94	1987 470 506 <sup>8</sup>
	2.0 TSI 4Motion						0986 474 384	→ 53,94	F 026 A06 106 <sup>7</sup>
	1.8 TFSI	01.12→	112/118	PR-Code 2EA	B31				1987 474 496 <sup>8</sup>
	2.0 TDI, TDI 4Motion, TSI 4Motion	01.12→	103/125/	PR-Code 2EA	B31				1987 474 496 <sup>8</sup>
			130/155						
	1.8 TFSI	01.12→	112/118			LAB	0986 594 504 <sup>3</sup>		
						RAB	0986 594 561 <sup>4</sup>		
							0986 594 505 <sup>3</sup>		
							0986 594 560 <sup>4</sup>		
	2.0 TDI	01.12→	103			LAB	0986 594 561 <sup>4</sup>		
						RAB	0986 594 505 <sup>3</sup>		
							0986 594 560 <sup>4</sup>		
	2.0 TDI, TDI 4Motion	01.12→	103			LAB	0986 594 504 <sup>3</sup>		
	2.0 TDI 4Motion	01.12→	103			LAB	0986 594 524 <sup>4</sup>		
						RAB	0986 594 505 <sup>3</sup>		
							0986 594 525 <sup>4</sup>		
	2.0 TDI 4Motion	01.12→	125/130/			LAB	0986 594 504 <sup>3</sup>		
	2.0 TSI 4Motion		155			RAB	0986 594 524 <sup>4</sup>		
							0986 594 505 <sup>3</sup>		
							0986 594 525 <sup>4</sup>		
<b>Passat [A32]</b>									
	2.0 TDI	09.11→					0986 134 323	← 57	1987 470 506 <sup>8</sup>
							0986 135 323	→ 57	1987 470 506 <sup>8</sup>
	2.0 TDI	09.11→					0986 134 203	← 38	
							0986 135 203	→ 38	
	2.0 TDI	09.11→				LAB	0986 594 504 <sup>3</sup>		
						RAB	0986 594 506 <sup>4</sup>		
							0986 594 505 <sup>3</sup>		
							0986 594 507 <sup>4</sup>		
<b>Passat [B5]</b>									
	1.8 i	01.98-06.00	92				0986 473 070	← 56,93	1987 470 005 <sup>7</sup>
							0986 474 070	→ 56,93	1987 470 005 <sup>7</sup>
		07.00-04.04	92						1987 470 005 <sup>7</sup>



1.8i	01.98-04.04	92				0 986 472 830	← 38	1 987 470 040 <sup>7</sup>
						0 986 474 830		1 987 474 496 <sup>8</sup>
						0 986 472 831	→ 38	1 987 470 040 <sup>7</sup>
						0 986 474 831		
1.8i	01.98-04.04	92				0 986 594 002 <sup>3</sup>		
<b>Passat CC [357]</b>								
1.4 TSI	01.11-05.12	118	PR-Code 1LJ, PR-Code 1ZM, PR-Code 1ZG	312		0 986 473 384	← 53,94	F 026 A06 106 <sup>7</sup>
						0 986 473 384	← 53,94	1 987 470 506 <sup>8</sup>
						0 986 474 384	→ 53,94	F 026 A06 106 <sup>7</sup>
			PR-Code 1LK			0 986 134 257	←	F 026 A03 545 <sup>7</sup>
						0 986 134 257	←	1 987 470 506 <sup>8</sup>
						0 986 135 257	→	F 026 A03 545 <sup>7</sup>
1.8 TSI	05.08-05.10	112/118				0 986 134 257	←	F 026 A03 545 <sup>7</sup>
						0 986 134 257	←	1 987 470 506 <sup>8</sup>
						0 986 135 257	→	F 026 A03 545 <sup>7</sup>
				312		0 986 473 384	← 53,94	F 026 A06 106 <sup>7</sup>
						0 986 473 384	← 53,94	1 987 470 506 <sup>8</sup>
						0 986 474 384	→ 53,94	F 026 A06 106 <sup>7</sup>
	11.08-05.12	112/118	PR-Code 1LJ, PR-Code 1ZM, PR-Code 1ZG	312		0 986 473 384	← 53,94	F 026 A06 106 <sup>7</sup>
						0 986 473 384	← 53,94	1 987 470 506 <sup>8</sup>
						0 986 474 384	→ 53,94	F 026 A06 106 <sup>7</sup>
			PR-Code 1LK			0 986 134 257	←	F 026 A03 545 <sup>7</sup>
						0 986 134 257	←	1 987 470 506 <sup>8</sup>
						0 986 135 257	→	F 026 A03 545 <sup>7</sup>
2.0 TDI	05.08-11.10	100	PR-Code 1LK			0 986 135 257	→	1 987 470 506 <sup>8</sup>
	05.08-05.12	100	PR-Code 1LJ, PR-Code 1ZM, PR-Code 1ZG	312		0 986 473 384	← 53,94	F 026 A06 106 <sup>7</sup>
						0 986 473 384	← 53,94	1 987 470 506 <sup>8</sup>
						0 986 474 384	→ 53,94	F 026 A06 106 <sup>7</sup>
			PR-Code 1LK			0 986 134 257	←	F 026 A03 545 <sup>7</sup>
						0 986 134 257	←	1 987 470 506 <sup>8</sup>
						0 986 135 257	→	F 026 A03 545 <sup>7</sup>
2.0 TDI	05.08-05.12	103	PR-Code 1LJ, PR-Code 1ZM, PR-Code 1ZG	312		0 986 473 384	← 53,94	F 026 A06 106 <sup>7</sup>
2.0 TDI 4Motion						0 986 473 384	← 53,94	1 987 470 506 <sup>8</sup>
						0 986 474 384	→ 53,94	1 987 470 506 <sup>8</sup>
			PR-Code 1LK			0 986 134 257	←	F 026 A03 545 <sup>7</sup>
						0 986 134 257	←	1 987 470 506 <sup>8</sup>
						0 986 135 257	→	F 026 A03 545 <sup>7</sup>
2.0 TDI	05.08-05.12	105/125/147/155	PR-Code 1LJ, PR-Code 1ZM, PR-Code 1ZG	312		0 986 473 384	← 53,94	F 026 A06 106 <sup>7</sup>
2.0 TDI 4Motion						0 986 473 384	← 53,94	1 987 470 506 <sup>8</sup>
2.0 TSI						0 986 474 384	→ 53,94	F 026 A06 106 <sup>7</sup>
			PR-Code 1LK			0 986 134 257	←	F 026 A03 545 <sup>7</sup>
						0 986 134 257	←	1 987 470 506 <sup>8</sup>
						0 986 135 257	→	F 026 A03 545 <sup>7</sup>
3.6 FSI	05.08-05.12	206/220	PR-Code 1LJ, PR-Code 1ZM, PR-Code 1ZG	312		0 986 473 384	← 53,94	F 026 A06 106 <sup>7</sup>
3.6 FSI 4Motion						0 986 473 384	← 53,94	1 987 470 506 <sup>8</sup>
						0 986 474 384	→ 53,94	F 026 A06 106 <sup>7</sup>
			PR-Code 1LK			0 986 134 257	←	F 026 A03 545 <sup>7</sup>
						0 986 134 257	←	1 987 470 506 <sup>8</sup>
						0 986 135 257	→	F 026 A03 545 <sup>7</sup>
1.4 TSI	01.11-05.12	118	PR-Code 1KU					1 987 470 040 <sup>7</sup>
								1 987 474 496 <sup>8</sup>
			PR-Code 2EA	B31				1 987 474 496 <sup>8</sup>







VW Passat CC [357]

1.8 TSI	05.08-11.08	112/118			1987 470 040 <sup>7</sup>
					1987 474 496 <sup>8</sup>
	05.08-05.10	112/118		B31	1987 474 496 <sup>8</sup>
	11.08-05.12	112/118	PR-Code 1KU		1987 470 040 <sup>7</sup>
			PR-Code 2EA	B31	1987 474 496 <sup>8</sup>
2.0 TDI	05.08-05.12	100/103/	PR-Code 1KU		1987 470 040 <sup>7</sup>
2.0 TDI 4Motion		105/125/			1987 474 496 <sup>8</sup>
2.0 TSI		147/155	PR-Code 2EA	B31	1987 474 496 <sup>8</sup>
3.6 FSI	05.08-05.12	206/220	PR-Code 1KU		1987 470 040 <sup>7</sup>
3.6 FSI 4Motion			PR-Code 2EA	B31	1987 474 496 <sup>8</sup>



1.4 TSI	01.11-05.12	118	LAB	0986 594 504 <sup>3</sup>
			RAB	0986 594 561 <sup>4</sup>
1.8 TSI	05.08-10.10	112/118	LAB	0986 594 506 <sup>4</sup>
			RAB	0986 594 507 <sup>4</sup>
	05.08-05.12	112/118	LAB	0986 594 504 <sup>3</sup>
			RAB	0986 594 505 <sup>3</sup>
11.10-05.12	112/118	LAB	0986 594 561 <sup>4</sup>	
		RAB	0986 594 560 <sup>4</sup>	
2.0 TDI	05.08-10.10	100	LAB	0986 594 506 <sup>4</sup>
			RAB	0986 594 507 <sup>4</sup>
		103	LAB	0986 594 506 <sup>4</sup>
			RAB	0986 594 507 <sup>4</sup>
	05.08-05.12	100	LAB	0986 594 504 <sup>3</sup>
			RAB	0986 594 505 <sup>3</sup>
		103	LAB	0986 594 504 <sup>3</sup>
			RAB	0986 594 505 <sup>3</sup>
	08.08-10.10	125	LAB	0986 594 506 <sup>4</sup>
			RAB	0986 594 507 <sup>4</sup>
	08.08-05.12	125	LAB	0986 594 504 <sup>3</sup>
			RAB	0986 594 505 <sup>3</sup>
	05.09-10.10	105	LAB	0986 594 506 <sup>4</sup>
			RAB	0986 594 507 <sup>4</sup>
	05.09-11.10	105	LAB	0986 594 504 <sup>3</sup>
			RAB	0986 594 505 <sup>3</sup>
	11.10-11.10	105	LAB	0986 594 561 <sup>4</sup>
			RAB	0986 594 560 <sup>4</sup>
	11.10-05.12	100	LAB	0986 594 561 <sup>4</sup>
			RAB	0986 594 560 <sup>4</sup>
103		LAB	0986 594 561 <sup>4</sup>	
		RAB	0986 594 560 <sup>4</sup>	
125		LAB	0986 594 561 <sup>4</sup>	
		RAB	0986 594 560 <sup>4</sup>	
2.0 TDI 4Motion	11.09-05.12	103	LAB	0986 594 504
			RAB	0986 594 505
	125	LAB	0986 594 504	
		RAB	0986 594 505	
2.0 TSI	05.08-10.10	147	LAB	0986 594 506 <sup>4</sup>
			RAB	0986 594 507 <sup>4</sup>
	05.08-05.12	147	LAB	0986 594 504 <sup>3</sup>
			RAB	0986 594 505 <sup>3</sup>
	11.10-05.12	147	LAB	0986 594 561 <sup>4</sup>
			RAB	0986 594 560 <sup>4</sup>
		155	LAB	0986 594 504 <sup>3</sup>
			RAB	0986 594 505 <sup>3</sup>

		S												
3.6 FSI	05.08-10.10	206						LAB	0 986 594 506 <sup>4</sup>					
								RAB	0 986 594 507 <sup>4</sup>					
	05.08-11.10	206							LAB	0 986 594 504 <sup>3</sup>				
									RAB	0 986 594 505 <sup>3</sup>				
	11.10-11.10	206							LAB	0 986 594 561 <sup>4</sup>				
									RAB	0 986 594 560 <sup>4</sup>				
3.6 FSI 4Motion	05.08-11.10	206						LAB	0 986 594 504					
								RAB	0 986 594 505					
	08.08-05.12	220							LAB	0 986 594 504				
									RAB	0 986 594 505				
<b>Passat Variant [3B5]</b>														
	1.6	01.97-11.00	74						228	0 986 474 897		← 54	1 987 470 287 <sup>7</sup>	
										0 986 474 897		← 54	1 987 474 496 <sup>8</sup>	
										0 986 474 898		→ 54	1 987 470 287 <sup>7</sup>	
									288	0 986 473 070		← 56,93	1 987 470 005 <sup>7</sup>	
										0 986 473 070		← 56,93	1 987 470 506 <sup>8</sup>	
										0 986 474 070		→ 56,93	1 987 470 005 <sup>7</sup>	
	1.8	05.97-11.00	85/92/110							228	0 986 474 897		← 54	1 987 470 287 <sup>7</sup>
											0 986 474 897		← 54	1 987 474 496 <sup>8</sup>
											0 986 474 898		→ 54	1 987 470 287 <sup>7</sup>
										288	0 986 473 070		← 56,93	1 987 470 005 <sup>7</sup>
											0 986 473 070		← 56,93	1 987 470 506 <sup>8</sup>
											0 986 474 070		→ 56,93	1 987 470 005 <sup>7</sup>
1.8, Turbo	05.97-11.00	85/92/110						288	0 986 473 070		← 56,93	1 987 470 506 <sup>8</sup>		
1.9 TDI	05.97-11.00	66/74						228	0 986 474 897		← 54	1 987 470 287 <sup>7</sup>		
									0 986 474 897		← 54	1 987 474 496 <sup>8</sup>		
									0 986 474 898		→ 54	1 987 470 287 <sup>7</sup>		
								288	0 986 473 070		← 56,93	1 987 470 506 <sup>8</sup>		
									0 986 474 070		→ 56,93	1 987 470 005 <sup>7</sup>		
									0 986 474 070		→ 56,93	1 987 470 506 <sup>8</sup>		
		81/85						228	0 986 474 897		← 54	1 987 470 287 <sup>7</sup>		
								288	0 986 473 070		← 56,93	1 987 470 506 <sup>8</sup>		
									0 986 474 070		→ 56,93	1 987 470 005 <sup>7</sup>		
									0 986 474 070		→ 56,93	1 987 470 506 <sup>8</sup>		
1.9 TDI syncro	06.97-08.00	81/85						228	0 986 474 897		← 54	1 987 470 287 <sup>7</sup>		
								288	0 986 473 070		← 56,93	1 987 470 005 <sup>7</sup>		
									0 986 474 070		→ 56,93	1 987 470 005 <sup>7</sup>		
1.9 TDI	05.97-11.00	81/85						228	0 986 474 897		← 54	1 987 474 496 <sup>8</sup>		
1.9 TDI syncro	05.97-11.00	81/85							0 986 474 898		→ 54	1 987 470 287 <sup>7</sup>		
2.3	09.97-11.00	110						228	0 986 474 897		← 54	1 987 470 287 <sup>7</sup>		
									0 986 474 897		← 54	1 987 474 496 <sup>8</sup>		
									0 986 474 898		→ 54	1 987 470 287 <sup>7</sup>		
								288	0 986 473 070		← 56,93	1 987 470 506 <sup>8</sup>		
									0 986 474 070		→ 56,93	1 987 470 005 <sup>7</sup>		
									0 986 474 070		→ 56,93	1 987 470 506 <sup>8</sup>		
2.3 syncro	09.97-08.00	110						228	0 986 474 897		← 54	1 987 474 496 <sup>8</sup>		
									0 986 474 898		→ 54	1 987 470 287 <sup>7</sup>		
									0 986 474 898		→ 54	1 987 474 496 <sup>8</sup>		
								288	0 986 473 070		← 56,93	1 987 470 005 <sup>7</sup>		
									0 986 474 070		→ 56,93	1 987 470 005 <sup>7</sup>		
									0 986 474 070		→ 56,93	1 987 470 506 <sup>8</sup>		
2.5 TDI	08.98-11.00	110						228	0 986 474 897		← 54	1 987 470 287 <sup>7</sup>		
								288	0 986 473 070		← 56,93	1 987 470 506 <sup>8</sup>		
									0 986 474 070		→ 56,93	1 987 470 005 <sup>7</sup>		
									0 986 474 070		→ 56,93	1 987 470 506 <sup>8</sup>		
2.5 TDI syncro	02.99-08.00	110						228	0 986 474 897		← 54	1 987 470 287 <sup>7</sup>		
								288	0 986 473 070		← 56,93	1 987 470 005 <sup>7</sup>		
									0 986 474 070		→ 56,93	1 987 470 005 <sup>7</sup>		
									0 986 474 070		→ 56,93	1 987 470 506 <sup>8</sup>		
2.5 TDI	08.98-11.00	110						228	0 986 474 897		← 54	1 987 474 496 <sup>8</sup>		
2.5 TDI syncro	08.98-11.00	110							0 986 474 898		→ 54	1 987 470 287 <sup>7</sup>		



		S							
	◀ VW Passat Variant [3B5]								
<b>2.8</b>	06.97-11.00	142	228	0986 474 897		← 54	1987 470 287 <sup>7</sup>		
				0986 474 897		← 54	1987 474 496 <sup>8</sup>		
				0986 474 898		→ 54	1987 470 287 <sup>7</sup>		
				288	0986 473 070		← 56,93	1987 470 506 <sup>8</sup>	
				0986 474 070		→ 56,93	1987 470 005 <sup>7</sup>		
				0986 474 070		→ 56,93	1987 470 506 <sup>8</sup>		
	10.99-11.00	140	228	0986 474 897		← 54	1987 470 287 <sup>7</sup>		
				0986 474 897		← 54	1987 474 496 <sup>8</sup>		
				0986 474 898		→ 54	1987 470 287 <sup>7</sup>		
				288	0986 473 070		← 56,93	1987 470 005 <sup>7</sup>	
				0986 473 070		← 56,93	1987 470 506 <sup>8</sup>		
				0986 474 070		→ 56,93	1987 470 005 <sup>7</sup>		
<b>2.8 syncro</b>	01.97-08.00	142	228	0986 474 897		← 54	1987 474 496 <sup>8</sup>		
				0986 474 898		→ 54	1987 470 287 <sup>7</sup>		
				0986 474 898		→ 54	1987 474 496 <sup>8</sup>		
				288	0986 473 070		← 56,93	1987 470 005 <sup>7</sup>	
				0986 474 070		→ 56,93	1987 470 005 <sup>7</sup>		
	<b>1.6</b>	05.98-11.00	74	245	0986 472 830		← 38	1987 470 040 <sup>7</sup>	
					0986 474 830			1987 474 496 <sup>8</sup>	
					0986 472 831		→ 38	1987 470 040 <sup>7</sup>	
					0986 474 831				
	<b>1.8</b>	05.98-11.00	85	245	0986 472 830		← 38	1987 470 040 <sup>7</sup>	
					0986 474 830			1987 474 496 <sup>8</sup>	
					0986 472 831		→ 38	1987 470 040 <sup>7</sup>	
					0986 474 831				
			92	245	0986 472 830		← 38	1987 470 040 <sup>7</sup>	
					0986 474 830			1987 474 496 <sup>8</sup>	
					0986 472 831		→ 38	1987 470 040 <sup>7</sup>	
					0986 474 831				
<b>1.8 syncro</b>	05.98-08.00	92	245	0986 473 225		← 38,1	1987 470 040 <sup>7</sup>		
				0986 473 225		← 38,1	1987 474 496 <sup>8</sup>		
				0986 474 225		→ 38,1	1987 470 040 <sup>7</sup>		
<b>1.8 Turbo</b>	05.98-11.00	110	245	0986 472 830		← 38	1987 470 040 <sup>7</sup>		
				0986 474 830			1987 474 496 <sup>8</sup>		
				0986 472 831		→ 38	1987 470 040 <sup>7</sup>		
				0986 474 831					
<b>1.9 TDI</b>	05.97-11.00	81	245	0986 472 830		← 38	1987 470 040 <sup>7</sup>		
				0986 474 830			1987 474 496 <sup>8</sup>		
				0986 472 831		→ 38	1987 470 040 <sup>7</sup>		
				0986 474 831					
	05.98-11.00	66	245	0986 472 830		← 38	1987 470 040 <sup>7</sup>		
				0986 474 830			1987 474 496 <sup>8</sup>		
				0986 472 831		→ 38	1987 470 040 <sup>7</sup>		
				0986 474 831					
	01.99-11.00	85	245	0986 472 830		← 38	1987 470 040 <sup>7</sup>		
				0986 474 830			1987 474 496 <sup>8</sup>		
				0986 472 831		→ 38	1987 470 040 <sup>7</sup>		
				0986 474 831					
08.99-11.00	81	245	0986 472 830		← 38	1987 470 040 <sup>7</sup>			
			0986 474 830			1987 474 496 <sup>8</sup>			
			0986 472 831		→ 38	1987 470 040 <sup>7</sup>			
			0986 474 831						
02.00-11.00	74	245	0986 472 830		← 38	1987 470 040 <sup>7</sup>			
			0986 474 830			1987 474 496 <sup>8</sup>			
			0986 472 831		→ 38	1987 470 040 <sup>7</sup>			
			0986 474 831						
<b>1.9 TDI syncro</b>	06.97-08.00	81	245	0986 473 225		← 38,1	1987 470 040 <sup>7</sup>		
				0986 473 225		← 38,1	1987 474 496 <sup>8</sup>		
				0986 474 225		→ 38,1	1987 470 040 <sup>7</sup>		



	S								
1.9 TDI syncro	08.99-08.00	81		245		0 986 473 225	← 38,1	1 987 470 040 <sup>7</sup>	
						0 986 473 225	← 38,1	1 987 474 496 <sup>8</sup>	
						0 986 474 225	→ 38,1	1 987 470 040 <sup>7</sup>	
	01.00-08.00	85		245		0 986 473 225	← 38,1	1 987 470 040 <sup>7</sup>	
						0 986 473 225	← 38,1	1 987 474 496 <sup>8</sup>	
						0 986 474 225	→ 38,1	1 987 470 040 <sup>7</sup>	
2.3	05.98-11.00	110		245		0 986 472 830	← 38	1 987 470 040 <sup>7</sup>	
						0 986 474 830		1 987 474 496 <sup>8</sup>	
						0 986 472 831	→ 38	1 987 470 040 <sup>7</sup>	
						0 986 474 831			
2.3 syncro	05.98-08.00	110		245		0 986 473 225	← 38,1	1 987 470 040 <sup>7</sup>	
						0 986 473 225	← 38,1	1 987 474 496 <sup>8</sup>	
						0 986 474 225	→ 38,1	1 987 470 040 <sup>7</sup>	
2.5 TDI	08.98-11.00	110		245		0 986 472 830	← 38	1 987 470 040 <sup>7</sup>	
						0 986 474 830		1 987 474 496 <sup>8</sup>	
						0 986 472 831	→ 38	1 987 470 040 <sup>7</sup>	
						0 986 474 831			
2.5 TDI syncro	02.99-08.00	110		245		0 986 473 225	← 38,1	1 987 470 040 <sup>7</sup>	
						0 986 473 225	← 38,1	1 987 474 496 <sup>8</sup>	
						0 986 474 225	→ 38,1	1 987 470 040 <sup>7</sup>	
2.8	05.98-11.00	142		245		0 986 472 830	← 38	1 987 470 040 <sup>7</sup>	
						0 986 474 830		1 987 474 496 <sup>8</sup>	
						0 986 472 831	→ 38	1 987 470 040 <sup>7</sup>	
	10.99-11.00	140		245		0 986 472 830	← 38	1 987 470 040 <sup>7</sup>	
						0 986 474 830		1 987 474 496 <sup>8</sup>	
						0 986 472 831	→ 38	1 987 470 040 <sup>7</sup>	
2.8 syncro	05.98-08.00	142		245		0 986 473 225	← 38,1	1 987 470 040 <sup>7</sup>	
						0 986 473 225	← 38,1	1 987 474 496 <sup>8</sup>	
						0 986 474 225	→ 38,1	1 987 470 040 <sup>7</sup>	
	1.6	01.97-11.00	74			1 987 477 803	← 1890		
						1 987 477 804	→ 1890		
	1.8	05.97-11.00	85/92/110				1 987 477 803	← 1890	
							1 987 477 804	→ 1890	
	1.8 Turbo						1 987 477 804	→ 1890	
	1.9 TDI	05.97-11.00	66/74/81/ 85				1 987 477 803	← 1890	
							1 987 477 804	→ 1890	
	2.3	09.97-11.00	110				1 987 477 803	← 1890	
							1 987 477 804	→ 1890	
	2.5 TDI	08.98-11.00	110				1 987 477 803	← 1890	
							1 987 477 804	→ 1890	
	2.8	06.97-11.00	140/142				1 987 477 803	← 1890	
							1 987 477 804	→ 1890	
		1.6	01.97-11.00	74		MVB	0 986 594 014 <sup>3</sup>		
05.98-11.00			74		MVB	0 986 594 002 <sup>3</sup>			
1.8		05.97-11.00	85		MVB	0 986 594 014 <sup>3</sup>			
			92		MVB	0 986 594 014 <sup>3</sup>			
		05.98-11.00	85		MVB	0 986 594 002 <sup>3</sup>			
			92		MVB	0 986 594 002 <sup>3</sup>			
1.8 syncro		08.97-01.99	92				0 986 594 014 <sup>3</sup>		
		11.98-01.99	92	Fg.-Nr. 3B..X..338 107→	ALR,LAB	0 265 006 575 <sup>4</sup>			
					ALR,RAB	0 265 006 573 <sup>4</sup>			
					ALR	0 265 006 573 <sup>4</sup>			
		01.99-04.99	92	Fg.-Nr. →3B..X..600 000			0 986 594 014 <sup>3</sup>		
		01.99-08.00	92		ALR,LAB	0 265 006 575 <sup>4</sup>			
ALR,RAB					0 265 006 573 <sup>4</sup>				
ALR					0 265 006 573 <sup>4</sup>				
05.99-08.00		92	Fg.-Nr. 3B..Y..000 001→			0 986 594 002 <sup>3</sup>			
1.8 Turbo		05.97-11.00	110		MVB	0 986 594 014 <sup>3</sup>			

























































































 ◀ VW Passat Variant [3B5]

1.8 Turbo	05.98-11.00	110		MVB	0986 594 002 <sup>3</sup>	
1.9 TDI	05.97-11.00	66/74		MVB	0986 594 014 <sup>3</sup>	
		81		MVB	0986 594 014 <sup>3</sup>	
	05.98-11.00	66/74		MVB	0986 594 002 <sup>3</sup>	
		81		MVB	0986 594 002 <sup>3</sup>	
	01.99-11.00	85		MVB	0986 594 002 <sup>3</sup>	
				MVB	0986 594 014 <sup>3</sup>	
1.9 TDI syncro	06.97-04.99	81	Fg.-Nr. →3B..X..600 000		0986 594 014 <sup>3</sup>	
					0986 594 014 <sup>3</sup>	
	11.98-08.00	81	Fg.-Nr. 3B..X..338 107→	ALR,LAB	0265 006 575 <sup>4</sup>	
				ALR,RAB	0265 006 573 <sup>4</sup>	
				ALR	0265 006 573 <sup>4</sup>	
	05.99-08.00	81	Fg.-Nr. 3B..Y..000 001→		0986 594 002 <sup>3</sup>	
					0986 594 002 <sup>3</sup>	
	08.99-08.00	81			0986 594 002 <sup>3</sup>	
				ALR,LAB	0265 006 575 <sup>4</sup>	
				ALR,RAB	0265 006 573 <sup>4</sup>	
			ALR	0265 006 573 <sup>4</sup>		
				0986 594 002 <sup>3</sup>		
	01.00-08.00	85			0986 594 002 <sup>3</sup>	
				ALR,LAB	0265 006 575 <sup>4</sup>	
				ALR,RAB	0265 006 573 <sup>4</sup>	
				ALR	0265 006 573 <sup>4</sup>	
2.3	09.97-11.00	110		MVB	0986 594 014 <sup>3</sup>	
	05.98-11.00	110		MVB	0986 594 002 <sup>3</sup>	
2.3 syncro	09.97-04.99	110	Fg.-Nr. →3B..X..600 000		0986 594 014 <sup>3</sup>	
					0986 594 014 <sup>3</sup>	
	11.98-08.00	110	Fg.-Nr. 3B..X..338 107→	ALR,LAB	0265 006 575 <sup>4</sup>	
				ALR,RAB	0265 006 573 <sup>4</sup>	
				ALR	0265 006 573 <sup>4</sup>	
05.99-08.00	110	Fg.-Nr. 3B..Y..000 001→		0986 594 002 <sup>3</sup>		
2.5 TDI	08.98-11.00	110		MVB	0986 594 002 <sup>3</sup>	
				MVB	0986 594 014 <sup>3</sup>	
2.5 TDI syncro	02.99-04.99	110	Fg.-Nr. →3B..X..600 000		0986 594 014 <sup>3</sup>	
					0986 594 014 <sup>3</sup>	
	02.99-08.00	110		ALR,LAB	0265 006 575 <sup>4</sup>	
				ALR,RAB	0265 006 573 <sup>4</sup>	
				ALR	0265 006 573 <sup>4</sup>	
05.99-08.00	110			0986 594 002 <sup>3</sup>		
2.8	06.97-11.00	142		MVB	0986 594 014 <sup>3</sup>	
	05.98-11.00	142		MVB	0986 594 002 <sup>3</sup>	
	10.99-11.00	140		MVB	0986 594 002 <sup>3</sup>	
				MVB	0986 594 014 <sup>3</sup>	
2.8 syncro	01.97-04.99	142	Fg.-Nr. →3B..X..600 000		0986 594 014 <sup>3</sup>	
					0986 594 014 <sup>3</sup>	
	11.98-08.00	142	Fg.-Nr. 3B..X..338 107→	ALR,LAB	0265 006 575 <sup>4</sup>	
				ALR,RAB	0265 006 573 <sup>4</sup>	
				ALR	0265 006 573 <sup>4</sup>	
	01.99-08.00	142		ALR,LAB	0265 006 575 <sup>4</sup>	
				ALR,RAB	0265 006 573 <sup>4</sup>	
				ALR	0265 006 573 <sup>4</sup>	
	05.99-08.00	142	Fg.-Nr. 3B..Y..000 001→		0986 594 002 <sup>3</sup>	
	10.99-08.00	142			0986 594 002 <sup>3</sup>	

Passat Variant [3B6]



	1.6	10.00-05.05	75	288	0986 473 070	 ← 56,93	1987 470 005 <sup>7</sup>				
					0986 474 070	 → 56,93	1987 470 005 <sup>7</sup>				
					312	0986 473 070	 ← 56,93	1987 470 005 <sup>7</sup>			
						0986 473 070	 ← 56,93	1987 470 506 <sup>8</sup>			
						0986 474 070	 → 56,93	1987 470 005 <sup>7</sup>			
					321	0986 134 074	 ← 43	1987 470 005 <sup>7</sup>			
						0986 135 074	 → 43	1987 470 005 <sup>7</sup>			
					1.8	10.00-05.05	110/125	288	0986 473 070	 ← 56,93	1987 470 005 <sup>7</sup>
									0986 474 070	 → 56,93	1987 470 005 <sup>7</sup>
312	0986 473 070	 ← 56,93	1987 470 005 <sup>7</sup>								
	0986 473 070	 ← 56,93	1987 470 506 <sup>8</sup>								
	0986 474 070	 → 56,93	1987 470 005 <sup>7</sup>								

		S							
<b>1.8</b>	10.00-05.05	110/125				321	0 986 134 074	 43	1 987 470 005 <sup>7</sup>
							0 986 135 074	 43	1 987 470 005 <sup>7</sup>
<b>1.9 TDI</b>	10.00-05.05	74				288	0 986 473 070	 56,93	1 987 470 005 <sup>7</sup>
							0 986 474 070	 56,93	1 987 470 005 <sup>7</sup>
						312	0 986 473 070	 56,93	1 987 470 005 <sup>7</sup>
							0 986 473 070	 56,93	1 987 470 506 <sup>B</sup>
							0 986 474 070	 56,93	1 987 470 005 <sup>7</sup>
						321	0 986 134 074	 43	1 987 470 005 <sup>7</sup>
							0 986 135 074	 43	1 987 470 005 <sup>7</sup>
		96				288	0 986 473 070	 56,93	1 987 470 005 <sup>7</sup>
							0 986 474 070	 56,93	1 987 470 005 <sup>7</sup>
						312	0 986 473 070	 56,93	1 987 470 005 <sup>7</sup>
							0 986 473 070	 56,93	1 987 470 506 <sup>B</sup>
							0 986 474 070	 56,93	1 987 470 005 <sup>7</sup>
						321	0 986 134 074	 43	1 987 470 005 <sup>7</sup>
							0 986 135 074	 43	1 987 470 005 <sup>7</sup>
<b>1.9 TDI 4Motion</b>	10.00-05.05	96				288	0 986 473 070	 56,93	1 987 470 005 <sup>7</sup>
							0 986 474 070	 56,93	1 987 470 005 <sup>7</sup>
							0 986 474 070	 56,93	1 987 470 506 <sup>B</sup>
						312	0 986 473 070	 56,93	1 987 470 005 <sup>7</sup>
							0 986 474 070	 56,93	1 987 470 005 <sup>7</sup>
							0 986 474 070	 56,93	1 987 470 506 <sup>B</sup>
						321	0 986 134 074	 43	
							0 986 135 074	 43	
<b>2.0</b>	10.00-05.05	85				288	0 986 473 070	 56,93	1 987 470 005 <sup>7</sup>
							0 986 474 070	 56,93	1 987 470 005 <sup>7</sup>
						312	0 986 473 070	 56,93	1 987 470 005 <sup>7</sup>
							0 986 473 070	 56,93	1 987 470 506 <sup>B</sup>
							0 986 474 070	 56,93	1 987 470 005 <sup>7</sup>
						321	0 986 134 074	 43	1 987 470 005 <sup>7</sup>
							0 986 135 074	 43	1 987 470 005 <sup>7</sup>
<b>2.0</b>	11.01-05.05	96/100				288	0 986 473 070	 56,93	1 987 470 005 <sup>7</sup>
<b>2.0 TDI</b>							0 986 474 070	 56,93	1 987 470 005 <sup>7</sup>
						312	0 986 473 070	 56,93	1 987 470 005 <sup>7</sup>
							0 986 473 070	 56,93	1 987 470 506 <sup>B</sup>
							0 986 474 070	 56,93	1 987 470 005 <sup>7</sup>
						321	0 986 134 074	 43	1 987 470 005 <sup>7</sup>
							0 986 135 074	 43	1 987 470 005 <sup>7</sup>
<b>2.0 4Motion</b>	10.00-05.05	85				288	0 986 473 070	 56,93	1 987 470 005 <sup>7</sup>
							0 986 474 070	 56,93	1 987 470 005 <sup>7</sup>
							0 986 474 070	 56,93	1 987 470 506 <sup>B</sup>
						312	0 986 473 070	 56,93	1 987 470 005 <sup>7</sup>
							0 986 474 070	 56,93	1 987 470 005 <sup>7</sup>
							0 986 474 070	 56,93	1 987 470 506 <sup>B</sup>
						321	0 986 134 074	 43	
							0 986 135 074	 43	
<b>2.3</b>	10.00-05.05	125				288	0 986 473 070	 56,93	1 987 470 005 <sup>7</sup>
							0 986 474 070	 56,93	1 987 470 005 <sup>7</sup>
						312	0 986 473 070	 56,93	1 987 470 005 <sup>7</sup>
							0 986 473 070	 56,93	1 987 470 506 <sup>B</sup>
							0 986 474 070	 56,93	1 987 470 005 <sup>7</sup>
						321	0 986 134 074	 43	1 987 470 005 <sup>7</sup>
							0 986 135 074	 43	1 987 470 005 <sup>7</sup>
<b>2.3 4Motion</b>	01.01-05.05	125				288	0 986 473 070	 56,93	1 987 470 005 <sup>7</sup>
							0 986 474 070	 56,93	1 987 470 005 <sup>7</sup>
							0 986 474 070	 56,93	1 987 470 506 <sup>B</sup>
						312	0 986 473 070	 56,93	1 987 470 005 <sup>7</sup>
							0 986 474 070	 56,93	1 987 470 005 <sup>7</sup>
							0 986 474 070	 56,93	1 987 470 506 <sup>B</sup>
						321	0 986 134 074	 43	
							0 986 135 074	 43	
<b>2.5 TDI</b>	10.00-05.03	110				288	0 986 473 070	 56,93	1 987 470 005 <sup>7</sup>
							0 986 474 070	 56,93	1 987 470 005 <sup>7</sup>



			S							
◀ VW Passat Variant [3B6]										
2.5 TDI	10.00-05.03	110	312	0986 473 070		56,93	1987 470 005 <sup>7</sup>			
				0986 473 070		56,93	1987 470 506 <sup>8</sup>			
				0986 474 070		56,93	1987 470 005 <sup>7</sup>			
		05.03-05.05	120	288	0986 134 074		43	1987 470 005 <sup>7</sup>		
					0986 135 074		43	1987 470 005 <sup>7</sup>		
					0986 473 070		56,93	1987 470 005 <sup>7</sup>		
	2.5 TDI 4Motion	10.00-01.03	110	288	0986 474 070		56,93	1987 470 005 <sup>7</sup>		
					0986 473 070		56,93	1987 470 506 <sup>8</sup>		
					0986 474 070		56,93	1987 470 005 <sup>7</sup>		
			01.03-05.05	132	288	0986 134 074		43	1987 470 005 <sup>7</sup>	
						0986 135 074		43	1987 470 005 <sup>7</sup>	
						0986 473 070		56,93	1987 470 005 <sup>7</sup>	
2.8		10.00-05.05	140/142	288	0986 473 070		56,93	1987 470 005 <sup>7</sup>		
					0986 474 070		56,93	1987 470 005 <sup>7</sup>		
					0986 473 070		56,93	1987 470 005 <sup>7</sup>		
			01.03-05.05	142	312	0986 473 070		56,93	1987 470 506 <sup>8</sup>	
						0986 474 070		56,93	1987 470 005 <sup>7</sup>	
						0986 134 074		43	1987 470 005 <sup>7</sup>	
	2.8 4Motion	10.00-05.05	140/142	288	0986 135 074		43	1987 470 005 <sup>7</sup>		
					0986 473 070		56,93	1987 470 005 <sup>7</sup>		
					0986 474 070		56,93	1987 470 005 <sup>7</sup>		
			01.03-05.05	142	312	0986 473 070		56,93	1987 470 005 <sup>7</sup>	
						0986 474 070		56,93	1987 470 005 <sup>7</sup>	
						0986 474 070		56,93	1987 470 506 <sup>8</sup>	
4.0		05.02-09.04	202	288	0986 134 074		43	1987 470 005 <sup>7</sup>		
					0986 135 074		43	1987 470 005 <sup>7</sup>		
					0986 473 070		56,93	1987 470 005 <sup>7</sup>		
			09.01-09.04	202	288	0986 474 070		56,93	1987 470 005 <sup>7</sup>	
						0986 474 070		56,93	1987 470 506 <sup>8</sup>	
						0986 473 070		56,93	1987 470 005 <sup>7</sup>	
	4.0 4Motion	09.01-09.04	202	288	0986 474 070		56,93	1987 470 005 <sup>7</sup>		
					0986 474 070		56,93	1987 470 506 <sup>8</sup>		
					0986 473 070		56,93	1987 470 005 <sup>7</sup>		
			09.01-09.04	202	312	0986 474 070		56,93	1987 470 005 <sup>7</sup>	
						0986 474 070		56,93	1987 470 506 <sup>8</sup>	
						0986 134 074		43	1987 470 005 <sup>7</sup>	
4.0 4Motion		09.01-09.04	202	288	0986 135 074		43	1987 470 005 <sup>7</sup>		
					0986 473 070		56,93	1987 470 005 <sup>7</sup>		
					0986 474 070		56,93	1987 470 506 <sup>8</sup>		
			09.01-09.04	202	312	0986 473 070		56,93	1987 470 005 <sup>7</sup>	
						0986 474 070		56,93	1987 470 005 <sup>7</sup>	
						0986 474 070		56,93	1987 470 506 <sup>8</sup>	
	4.0 4Motion	09.01-09.04	202	312	0986 134 074		43	1987 470 005 <sup>7</sup>		
					0986 135 074		43	1987 470 005 <sup>7</sup>		
					0986 473 070		56,93	1987 470 005 <sup>7</sup>		
			09.01-09.04	202	312	0986 474 070		56,93	1987 470 005 <sup>7</sup>	
						0986 474 070		56,93	1987 470 506 <sup>8</sup>	
						0986 473 070		56,93	1987 470 005 <sup>7</sup>	



		S								
	<b>1.6</b>	10.00-05.05	75						0 986 472 830 ← 38	1 987 470 040 <sup>7</sup>
									0 986 474 830	1 987 474 496 <sup>8</sup>
									0 986 472 831 → 38	1 987 470 040 <sup>7</sup>
									0 986 474 831	
	<b>1.8</b>	10.00-05.05	110/125						0 986 472 830 ← 38	1 987 470 040 <sup>7</sup>
									0 986 474 830	1 987 474 496 <sup>8</sup>
									0 986 472 831 → 38	1 987 470 040 <sup>7</sup>
									0 986 474 831	
	<b>1.9 TDI</b>	10.00-05.05	74						0 986 472 830 ← 38	1 987 470 040 <sup>7</sup>
									0 986 474 830	1 987 474 496 <sup>8</sup>
									0 986 472 831 → 38	1 987 470 040 <sup>7</sup>
									0 986 474 831	
			96						0 986 472 830 ← 38	1 987 470 040 <sup>7</sup>
									0 986 474 830	1 987 474 496 <sup>8</sup>
									0 986 472 831 → 38	1 987 470 040 <sup>7</sup>
									0 986 474 831	
	<b>1.9 TDI 4Motion</b>	10.00-05.05	96		245				0 986 473 225  ← 38,1	1 987 470 040 <sup>7</sup>
									0 986 473 225  ← 38,1	1 987 474 496 <sup>8</sup>
									0 986 474 225  → 38,1	1 987 470 040 <sup>7</sup>
					252				0 986 473 185  ← 43	F 026 A06 121 <sup>7</sup>
									0 986 473 185  ← 43	1 987 474 496 <sup>8</sup>
									0 986 474 185  → 43	F 026 A06 121 <sup>7</sup>
	<b>2.0</b>	10.00-05.05	85						0 986 472 830 ← 38	1 987 470 040 <sup>7</sup>
									0 986 474 830	1 987 474 496 <sup>8</sup>
									0 986 472 831 → 38	1 987 470 040 <sup>7</sup>
									0 986 474 831	
	<b>2.0</b>	11.01-05.05	96/100						0 986 472 830 ← 38	1 987 470 040 <sup>7</sup>
	<b>2.0 TDI</b>								0 986 474 830	1 987 474 496 <sup>8</sup>
									0 986 472 831 → 38	1 987 470 040 <sup>7</sup>
									0 986 474 831	
	<b>2.0 4Motion</b>	10.00-05.05	85		245				0 986 473 225  ← 38,1	1 987 470 040 <sup>7</sup>
									0 986 473 225  ← 38,1	1 987 474 496 <sup>8</sup>
									0 986 474 225  → 38,1	1 987 470 040 <sup>7</sup>
					252				0 986 473 185  ← 43	F 026 A06 121 <sup>7</sup>
									0 986 473 185  ← 43	1 987 474 496 <sup>8</sup>
									0 986 474 185  → 43	F 026 A06 121 <sup>7</sup>
	<b>2.3</b>	10.00-05.05	125						0 986 472 830 ← 38	1 987 470 040 <sup>7</sup>
									0 986 474 830	1 987 474 496 <sup>8</sup>
									0 986 472 831 → 38	1 987 470 040 <sup>7</sup>
									0 986 474 831	
	<b>2.3 4Motion</b>	01.01-05.05	125		245				0 986 473 225  ← 38,1	1 987 470 040 <sup>7</sup>
									0 986 473 225  ← 38,1	1 987 474 496 <sup>8</sup>
									0 986 474 225  → 38,1	1 987 470 040 <sup>7</sup>
					252				0 986 473 185  ← 43	F 026 A06 121 <sup>7</sup>
									0 986 473 185  ← 43	1 987 474 496 <sup>8</sup>
									0 986 474 185  → 43	F 026 A06 121 <sup>7</sup>
	<b>2.5 TDI</b>	10.00-05.03	110						0 986 472 830 ← 38	1 987 470 040 <sup>7</sup>
									0 986 474 830	1 987 474 496 <sup>8</sup>
									0 986 472 831 → 38	1 987 470 040 <sup>7</sup>
									0 986 474 831	
		05.03-05.05	120						0 986 472 830 ← 38	1 987 470 040 <sup>7</sup>
									0 986 474 830	1 987 474 496 <sup>8</sup>
									0 986 472 831 → 38	1 987 470 040 <sup>7</sup>
									0 986 474 831	
	<b>2.5 TDI 4Motion</b>	10.00-01.03	110		245				0 986 473 225  ← 38,1	1 987 470 040 <sup>7</sup>
									0 986 473 225  ← 38,1	1 987 474 496 <sup>8</sup>
									0 986 474 225  → 38,1	1 987 470 040 <sup>7</sup>
					252				0 986 473 185  ← 43	F 026 A06 121 <sup>7</sup>
									0 986 473 185  ← 43	1 987 474 496 <sup>8</sup>
									0 986 474 185  → 43	F 026 A06 121 <sup>7</sup>





		S								
	◀ VW Passat Variant [3B6]									
2.5 TDI 4Motion		01.03-05.05	132	245		0986 473 225		← 38,1	1987 470 040 <sup>7</sup>	
						0986 473 225		← 38,1	1987 474 496 <sup>8</sup>	
						0986 474 225		→ 38,1	1987 470 040 <sup>7</sup>	
						252	0986 473 185		← 43	F 026 A06 121 <sup>7</sup>
						0986 473 185		← 43	1987 474 496 <sup>8</sup>	
						0986 474 185		→ 43	F 026 A06 121 <sup>7</sup>	
2.8		10.00-05.05	140/142			0986 472 830		← 38	1987 470 040 <sup>7</sup>	
						0986 474 830			1987 474 496 <sup>8</sup>	
						0986 472 831		→ 38	1987 470 040 <sup>7</sup>	
						0986 474 831				
2.8 4Motion		10.00-05.05	140/142	245		0986 473 225		← 38,1	1987 470 040 <sup>7</sup>	
						0986 473 225		← 38,1	1987 474 496 <sup>8</sup>	
						0986 474 225		→ 38,1	1987 470 040 <sup>7</sup>	
						252	0986 473 185		← 43	F 026 A06 121 <sup>7</sup>
						0986 473 185		← 43	1987 474 496 <sup>8</sup>	
						0986 474 185		→ 43	F 026 A06 121 <sup>7</sup>	
4.0		05.02-09.04	202			0986 472 830		← 38	1987 470 040 <sup>7</sup>	
						0986 474 830			1987 474 496 <sup>8</sup>	
						0986 472 831		→ 38	1987 470 040 <sup>7</sup>	
						0986 474 831				
4.0 4Motion		09.01-09.04	202	245		0986 473 225		← 38,1	1987 470 040 <sup>7</sup>	
						0986 473 225		← 38,1	1987 474 496 <sup>8</sup>	
						0986 474 225		→ 38,1	1987 470 040 <sup>7</sup>	
						252	0986 473 185		← 43	F 026 A06 121 <sup>7</sup>
						0986 473 185		← 43	1987 474 496 <sup>8</sup>	
						0986 474 185		→ 43	F 026 A06 121 <sup>7</sup>	
		10.00-05.05	75			1987 477 803		← 1890		
						1987 477 804		→ 1890		
			1.8			110/125	1987 477 803		← 1890	
							1987 477 804		→ 1890	
			1.9 TDI			74/96	1987 477 803		← 1890	
							1987 477 804		→ 1890	
			2.0			85/96/100	1987 477 803		← 1890	
							1987 477 804		→ 1890	
			2.3			125	1987 477 803		← 1890	
							1987 477 804		→ 1890	
			2.5 TDI			110/120	1987 477 803		← 1890	
							1987 477 804		→ 1890	
			2.8			140/142	1987 477 803		← 1890	
							1987 477 804		→ 1890	
			4.0			202	1987 477 803		← 1890	
							1987 477 804		→ 1890	
		10.00-05.05	75			ALR,LAB		0 265 006 575 <sup>4</sup>		
						ALR,RAB		0 265 006 573 <sup>4</sup>		
			1.8			110/125	FMS		0 265 006 578 <sup>3</sup>	
							FMS		0 986 594 002 <sup>3</sup>	
			1.9 TDI			74	ALR,LAB		0 265 006 575 <sup>4</sup>	
							ALR,RAB		0 265 006 573 <sup>4</sup>	
			96				FMS		0 265 006 578 <sup>3</sup>	
							FMS		0 986 594 002 <sup>3</sup>	
			1.9 TDI, TDI 4Motion			96	ALR,LAB		0 265 006 575 <sup>4</sup>	
							ALR,RAB		0 265 006 573 <sup>4</sup>	
							FMS		0 265 006 578 <sup>3</sup>	
							FMS		0 986 594 002 <sup>3</sup>	

	S							
1.9 TDI 4Motion	10.00-05.05	96				0 265 006 573 <sup>4</sup>		
					FMS	0 265 006 578 <sup>3</sup>		
2.0	10.00-05.05	85				ALR,LAB 0 265 006 575 <sup>4</sup>		
						ALR,RAB 0 265 006 573 <sup>4</sup>		
					FMS	0 265 006 578 <sup>3</sup>		
2.0	11.01-05.05	96/100				ALR,LAB 0 265 006 575 <sup>4</sup>		
2.0 TDI						ALR,RAB 0 265 006 573 <sup>4</sup>		
					FMS	0 265 006 578 <sup>3</sup>		
					FMS	0 986 594 002 <sup>3</sup>		
2.0, 4Motion	10.00-05.05	85			FMS	0 986 594 002 <sup>3</sup>		
2.0 4Motion	10.00-05.05	85				0 265 006 573 <sup>4</sup>		
					FMS	0 265 006 578 <sup>3</sup>		
2.3	10.00-05.05	125				ALR,LAB 0 265 006 575 <sup>4</sup>		
						ALR,RAB 0 265 006 573 <sup>4</sup>		
					FMS	0 265 006 578 <sup>3</sup>		
2.3, 4Motion	10.00-05.05	125			FMS	0 986 594 002 <sup>3</sup>		
2.3 4Motion	01.01-05.05	125				0 265 006 573 <sup>4</sup>		
					FMS	0 265 006 578 <sup>3</sup>		
2.5 TDI	10.00-05.03	110				ALR,LAB 0 265 006 575 <sup>4</sup>		
						ALR,RAB 0 265 006 573 <sup>4</sup>		
					FMS	0 265 006 578 <sup>3</sup>		
	05.03-05.05	120				ALR,LAB 0 265 006 575 <sup>4</sup>		
						ALR,RAB 0 265 006 573 <sup>4</sup>		
					FMS	0 265 006 578 <sup>3</sup>		
					FMS	0 986 594 002 <sup>3</sup>		
2.5 TDI, TDI 4Motion	10.00-05.03	110			FMS	0 986 594 002 <sup>3</sup>		
2.5 TDI 4Motion	10.00-01.03	110				0 265 006 573 <sup>4</sup>		
					FMS	0 265 006 578 <sup>3</sup>		
	01.03-05.05	132				0 265 006 573 <sup>4</sup>		
					FMS	0 265 006 578 <sup>3</sup>		
					FMS	0 986 594 002 <sup>3</sup>		
2.8	10.00-05.05	140/142				ALR,LAB 0 265 006 575 <sup>4</sup>		
						ALR,RAB 0 265 006 573 <sup>4</sup>		
					FMS	0 265 006 578 <sup>3</sup>		
2.8, 4Motion	10.00-05.05	140/142			FMS	0 986 594 002 <sup>3</sup>		
2.8 4Motion	10.00-05.05	140/142				0 265 006 573 <sup>4</sup>		
					FMS	0 265 006 578 <sup>3</sup>		
4.0	05.02-09.04	202				ALR,LAB 0 265 006 575 <sup>4</sup>		
						ALR,RAB 0 265 006 573 <sup>4</sup>		
					FMS	0 265 006 578 <sup>3</sup>		
4.0, 4Motion	09.01-09.04	202			FMS	0 986 594 002 <sup>3</sup>		
4.0 4Motion	09.01-09.04	202				0 265 006 573 <sup>4</sup>		
					FMS	0 265 006 578 <sup>3</sup>		

**Passat Variant [3C5]**

	1.4 TSI	05.07-11.10	90/110	PR-Code 1LH, PR-Code 1ZG,	312	0 986 473 384		← 53,94	F 026 A06 106 <sup>7</sup>
	1.4 TSI EcoFuel			PR-Code 1ZM		0 986 473 384		← 53,94	1 987 470 506 <sup>8</sup>
						0 986 474 384		→ 53,94	F 026 A06 106 <sup>7</sup>
				PR-Code 1LK	NOR	0 986 134 257		←	F 026 A03 545 <sup>7</sup>
						0 986 134 257		←	1 987 470 506 <sup>8</sup>
						0 986 135 257		→	F 026 A03 545 <sup>7</sup>
				PR-Code 1LM	KZB	0 986 134 257		←	F 026 A03 545 <sup>7</sup>
						0 986 134 257		←	1 987 470 506 <sup>8</sup>
						0 986 135 257		→	F 026 A03 545 <sup>7</sup>
	1.6	08.05-11.10	75/77	PR-Code 1LH, PR-Code 1ZG,	312	0 986 473 384		← 53,94	F 026 A06 106 <sup>7</sup>
	1.6 TDI			PR-Code 1ZM		0 986 473 384		← 53,94	1 987 470 506 <sup>8</sup>
						0 986 474 384		→ 53,94	F 026 A06 106 <sup>7</sup>
				PR-Code 1LK	NOR	0 986 134 257		←	F 026 A03 545 <sup>7</sup>
						0 986 134 257		←	1 987 470 506 <sup>8</sup>
						0 986 135 257		→	F 026 A03 545 <sup>7</sup>



		S							
◀ VW Passat Variant [3C5]									
<b>1.6</b> <b>1.6 TDI</b>	08.05-11.10	75/77	PR-Code 1LM	KZB	0986 134 257		F 026 A03 545 <sup>7</sup>		
					0986 134 257		1 987 470 506 <sup>8</sup>		
					0986 135 257		F 026 A03 545 <sup>7</sup>		
<b>1.6 FSI</b>	08.05-06.08	85			0986 473 384	53,94	F 026 A06 106 <sup>7</sup>		
					0986 473 384	53,94	1 987 470 506 <sup>8</sup>		
					0986 474 384	53,94	F 026 A06 106 <sup>7</sup>		
<b>1.8 TSI</b>	05.07-11.10	112/118	PR-Code 1LH, PR-Code 1ZG, PR-Code 1ZM	312	0986 473 384	53,94	F 026 A06 106 <sup>7</sup>		
					0986 473 384	53,94	1 987 470 506 <sup>8</sup>		
					0986 474 384	53,94	F 026 A06 106 <sup>7</sup>		
			PR-Code 1LK	NOR	0986 134 257		F 026 A03 545 <sup>7</sup>		
					0986 134 257		1 987 470 506 <sup>8</sup>		
					0986 135 257		F 026 A03 545 <sup>7</sup>		
			PR-Code 1LM	KZB	0986 134 257		F 026 A03 545 <sup>7</sup>		
					0986 134 257		1 987 470 506 <sup>8</sup>		
					0986 135 257		F 026 A03 545 <sup>7</sup>		
<b>1.9 TDI</b>	08.05-11.08	77			0986 473 384	53,94	F 026 A06 106 <sup>7</sup>		
					0986 473 384	53,94	1 987 470 506 <sup>8</sup>		
					0986 474 384	53,94	F 026 A06 106 <sup>7</sup>		
<b>2.0 FSI</b>	08.05-11.05	110	PR-Code 1LH, PR-Code 1ZG, PR-Code 1ZM	312	0986 473 384	53,94	F 026 A06 106 <sup>7</sup>		
					0986 473 384	53,94	F 026 A06 106 <sup>7</sup>		
	11.05-11.10	110			0986 135 257		1 987 470 506 <sup>8</sup>		
					0986 135 257		1 987 470 506 <sup>8</sup>		
<b>2.0 FSI</b> <b>2.0 FSI 4Motion</b>	08.05-11.05	110	PR-Code 1LH, PR-Code 1ZG, PR-Code 1ZM	312	0986 473 384	53,94	1 987 470 506 <sup>8</sup>		
					0986 474 384	53,94	F 026 A06 106 <sup>7</sup>		
					0986 473 384	53,94	1 987 470 506 <sup>8</sup>		
	11.05-11.10	110			0986 474 384	53,94	F 026 A06 106 <sup>7</sup>		
					0986 134 257		1 987 470 506 <sup>8</sup>		
					0986 135 257		F 026 A03 545 <sup>7</sup>		
	PR-Code 1LK	NOR			0986 134 257		1 987 470 506 <sup>8</sup>		
					0986 135 257		F 026 A03 545 <sup>7</sup>		
					0986 134 257		1 987 470 506 <sup>8</sup>		
PR-Code 1LM	KZB	0986 134 257		1 987 470 506 <sup>8</sup>					
		0986 135 257		F 026 A03 545 <sup>7</sup>					
		0986 134 257		1 987 470 506 <sup>8</sup>					
<b>2.0 FSI 4Motion</b>	09.05-11.05	110	PR-Code 1LH, PR-Code 1ZG, PR-Code 1ZM	312	0986 473 384	53,94	F 026 A06 106 <sup>7</sup>		
					0986 473 384	53,94	F 026 A06 106 <sup>7</sup>		
	11.05-11.10	110			0986 473 384	53,94	F 026 A06 106 <sup>7</sup>		
					0986 474 384	53,94	F 026 A06 106 <sup>7</sup>		
					0986 134 257		1 987 470 506 <sup>8</sup>		
	PR-Code 1LK	NOR			0986 134 257		1 987 470 506 <sup>8</sup>		
					0986 135 257		F 026 A03 545 <sup>7</sup>		
					0986 134 257		1 987 470 506 <sup>8</sup>		
	PR-Code 1LM	KZB			0986 134 257		1 987 470 506 <sup>8</sup>		
0986 135 257				F 026 A03 545 <sup>7</sup>					
0986 134 257				1 987 470 506 <sup>8</sup>					
<b>2.0 TDI</b>	08.05-05.06	88/90	PR-Code 1LH, PR-Code 1ZG, PR-Code 1ZM	312	0986 473 384	53,94	F 026 A06 106 <sup>7</sup>		
					0986 473 384	53,94	1 987 470 506 <sup>8</sup>		
					0986 474 384	53,94	F 026 A06 106 <sup>7</sup>		
	08.05-06.08	100			0986 473 384	53,94	F 026 A06 106 <sup>7</sup>		
					0986 473 384	53,94	1 987 470 506 <sup>8</sup>		
					0986 474 384	53,94	F 026 A06 106 <sup>7</sup>		
					0986 473 384	53,94	F 026 A06 106 <sup>7</sup>		
					0986 473 384	53,94	1 987 470 506 <sup>8</sup>		
					0986 474 384	53,94	F 026 A06 106 <sup>7</sup>		
	103				0986 473 384	53,94	F 026 A06 106 <sup>7</sup>		
					0986 473 384	53,94	1 987 470 506 <sup>8</sup>		
					0986 474 384	53,94	F 026 A06 106 <sup>7</sup>		
	120				0986 473 384	53,94	F 026 A06 106 <sup>7</sup>		
					0986 473 384	53,94	1 987 470 506 <sup>8</sup>		
					0986 474 384	53,94	F 026 A06 106 <sup>7</sup>		
	125				0986 473 384	53,94	F 026 A06 106 <sup>7</sup>		
					0986 473 384	53,94	1 987 470 506 <sup>8</sup>		
					0986 474 384	53,94	F 026 A06 106 <sup>7</sup>		
	01.08-11.09	100			PR-Code 1LH, PR-Code 1ZG, PR-Code 1ZM	0986 473 384	53,94	F 026 A06 106 <sup>7</sup>	
						0986 473 384	53,94	1 987 470 506 <sup>8</sup>	
						0986 474 384	53,94	F 026 A06 106 <sup>7</sup>	
PR-Code 1LK			NOR	0986 134 257			F 026 A03 545 <sup>7</sup>		
				0986 134 257			1 987 470 506 <sup>8</sup>		
				0986 135 257			F 026 A03 545 <sup>7</sup>		
PR-Code 1LM			KZB	0986 134 257			F 026 A03 545 <sup>7</sup>		
				0986 134 257			1 987 470 506 <sup>8</sup>		
				0986 135 257			F 026 A03 545 <sup>7</sup>		
01.08-11.10	103	PR-Code 1LH, PR-Code 1ZG, PR-Code 1ZM	0986 473 384	53,94	F 026 A06 106 <sup>7</sup>				
			0986 134 257		1 987 470 506 <sup>8</sup>				
			0986 135 257		1 987 470 506 <sup>8</sup>				

























		S											
<b>2.0 TDI</b>	01.08-11.10	103	PR-Code 1LM	KZB			0 986 134 257		1 987 470 506 <sup>B</sup>				
							0 986 135 257		1 987 470 506 <sup>B</sup>				
	05.08-11.10	125	PR-Code 1LH, PR-Code 1ZG, PR-Code 1ZM	312				0 986 473 384		53,94 F 026 A06 106 <sup>7</sup>			
								0 986 473 384		53,94 1 987 470 506 <sup>B</sup>			
								0 986 474 384		53,94 F 026 A06 106 <sup>7</sup>			
								0 986 474 384		53,94 F 026 A06 106 <sup>7</sup>			
	11.08-11.10	81	PR-Code 1LH, PR-Code 1ZG, PR-Code 1ZM	312				0 986 473 384		53,94 F 026 A06 106 <sup>7</sup>			
								0 986 473 384		53,94 1 987 470 506 <sup>B</sup>			
								0 986 474 384		53,94 F 026 A06 106 <sup>7</sup>			
								0 986 474 384		53,94 F 026 A06 106 <sup>7</sup>			
						PR-Code 1LK	NOR				0 986 134 257		F 026 A03 545 <sup>7</sup>
											0 986 134 257		1 987 470 506 <sup>B</sup>
											0 986 135 257		F 026 A03 545 <sup>7</sup>
											0 986 135 257		F 026 A03 545 <sup>7</sup>
			PR-Code 1LM	KZB				0 986 134 257		F 026 A03 545 <sup>7</sup>			
								0 986 134 257		1 987 470 506 <sup>B</sup>			
0 986 135 257									F 026 A03 545 <sup>7</sup>				
0 986 135 257									F 026 A03 545 <sup>7</sup>				
					PR-Code 1LH, PR-Code 1ZG, PR-Code 1ZM	312				0 986 473 384		53,94 F 026 A06 106 <sup>7</sup>	
										0 986 473 384		53,94 1 987 470 506 <sup>B</sup>	
										0 986 474 384		53,94 F 026 A06 106 <sup>7</sup>	
										0 986 474 384		53,94 F 026 A06 106 <sup>7</sup>	
		PR-Code 1LK	NOR				0 986 134 257		F 026 A03 545 <sup>7</sup>				
							0 986 134 257		1 987 470 506 <sup>B</sup>				
							0 986 135 257		F 026 A03 545 <sup>7</sup>				
							0 986 135 257		F 026 A03 545 <sup>7</sup>				
					PR-Code 1LM	KZB				0 986 134 257		F 026 A03 545 <sup>7</sup>	
										0 986 134 257		1 987 470 506 <sup>B</sup>	
										0 986 135 257		F 026 A03 545 <sup>7</sup>	
										0 986 135 257		F 026 A03 545 <sup>7</sup>	
<b>2.0 TDI</b>	08.05-06.08	103					0 986 473 384		53,94 1 987 470 506 <sup>B</sup>				
<b>2.0 TDI 4Motion</b>	01.08-11.10	103	PR-Code 1LH, PR-Code 1ZG, PR-Code 1ZM	312			0 986 473 384		53,94 1 987 470 506 <sup>B</sup>				
<b>2.0 TDI 4Motion</b>							0 986 474 384		53,94 1 987 470 506 <sup>B</sup>				
<b>2.0 TDI</b>	05.08-11.10	125	PR-Code 1LK	NOR			0 986 134 257		F 026 A03 545 <sup>7</sup>				
							<b>2.0 TDI 4Motion</b>	0 986 134 257		1 987 470 506 <sup>B</sup>			
<b>2.0 TSI</b>			PR-Code 1LM	KZB			0 986 134 257		F 026 A03 545 <sup>7</sup>				
							0 986 134 257		1 987 470 506 <sup>B</sup>				
<b>2.0 TDI 4Motion</b>	08.05-06.08	103					0 986 473 384		53,94 F 026 A06 106 <sup>7</sup>				
	05.08-11.10	103	PR-Code 1LH, PR-Code 1ZG, PR-Code 1ZM	312			0 986 473 384		53,94 F 026 A06 106 <sup>7</sup>				
							0 986 473 384		53,94 F 026 A06 106 <sup>7</sup>				
							0 986 134 257		1 987 470 506 <sup>B</sup>				
							0 986 135 257		F 026 A03 545 <sup>7</sup>				
			PR-Code 1LM	KZB			0 986 134 257		1 987 470 506 <sup>B</sup>				
							0 986 135 257		F 026 A03 545 <sup>7</sup>				
	05.09-11.10	125	PR-Code 1LH, PR-Code 1ZG, PR-Code 1ZM	312			0 986 474 384		53,94 1 987 470 506 <sup>B</sup>				
							0 986 474 384		53,94 1 987 470 506 <sup>B</sup>				
							0 986 474 384		53,94 F 026 A06 106 <sup>7</sup>				
							0 986 474 384		53,94 F 026 A06 106 <sup>7</sup>				
<b>2.0 TDI 4Motion</b>	05.08-11.10	125	PR-Code 1LH, PR-Code 1ZG, PR-Code 1ZM	312			0 986 473 384		53,94 F 026 A06 106 <sup>7</sup>				
<b>2.0 TSI</b>							0 986 474 384		53,94 F 026 A06 106 <sup>7</sup>				
			PR-Code 1LK	NOR			0 986 135 257		F 026 A03 545 <sup>7</sup>				
			PR-Code 1LM	KZB			0 986 135 257		F 026 A03 545 <sup>7</sup>				
<b>2.0 TSI</b>	08.05-11.05	147	PR-Code 1LJ, PR-Code 1LH, PR-Code 1ZG	312			0 986 473 384		53,94 F 026 A06 106 <sup>7</sup>				
							0 986 473 384		53,94 1 987 470 506 <sup>B</sup>				
							0 986 474 384		53,94 F 026 A06 106 <sup>7</sup>				
							0 986 474 384		53,94 F 026 A06 106 <sup>7</sup>				
				PR-Code 1LK				0 986 134 257		F 026 A03 545 <sup>7</sup>			
								0 986 134 257		1 987 470 506 <sup>B</sup>			
								0 986 135 257		F 026 A03 545 <sup>7</sup>			
								0 986 135 257		F 026 A03 545 <sup>7</sup>			
	08.05-11.10	147	PR-Code 1LK	NOR			0 986 134 257		F 026 A03 545 <sup>7</sup>				
							0 986 134 257		1 987 470 506 <sup>B</sup>				
							0 986 135 257		F 026 A03 545 <sup>7</sup>				
							0 986 135 257		F 026 A03 545 <sup>7</sup>				
				PR-Code 1LM	KZB			0 986 134 257		F 026 A03 545 <sup>7</sup>			
								0 986 134 257		1 987 470 506 <sup>B</sup>			
								0 986 135 257		F 026 A03 545 <sup>7</sup>			
								0 986 135 257		F 026 A03 545 <sup>7</sup>			
	11.07-11.10	147	PR-Code 1LH, PR-Code 1ZG, PR-Code 1ZM	312			0 986 473 384		53,94 F 026 A06 106 <sup>7</sup>				
							0 986 473 384		53,94 1 987 470 506 <sup>B</sup>				
							0 986 474 384		53,94 F 026 A06 106 <sup>7</sup>				



<b>◀ VW Passat Variant [3C5]</b>												
<b>2.0 TSI</b>	05.08-11.10	125	PR-Code 1LH, PR-Code 1ZG, PR-Code 1ZM	312	0986 473 384		← 53,94	1987 470 506 <sup>8</sup>				
<b>3.2 FSI 4Motion</b>	11.05-11.10	184	PR-Code 1LH, PR-Code 1ZG, PR-Code 1ZM	312	0986 473 384		← 53,94	F 026 A06 106 <sup>7</sup>				
					0986 473 384		← 53,94	1987 470 506 <sup>8</sup>				
					0986 474 384		→ 53,94	F 026 A06 106 <sup>7</sup>				
					PR-Code 1LK	NOR	0986 134 257		←	F 026 A03 545 <sup>7</sup>		
					0986 134 257		←	1987 470 506 <sup>8</sup>				
					0986 135 257		→	F 026 A03 545 <sup>7</sup>				
<b>3.6 FSI</b>	09.05-11.10	206	PR-Code 1LH, PR-Code 1ZG, PR-Code 1ZM	312	0986 473 384		← 53,94	F 026 A06 106 <sup>7</sup>				
					PR-Code 1LK	NOR	0986 135 257		→	1987 470 506 <sup>8</sup>		
					PR-Code 1LM	KZB	0986 135 257		→	1987 470 506 <sup>8</sup>		
					PR-Code 1LH, PR-Code 1ZG, PR-Code 1ZM	312	0986 473 384		← 53,94	F 026 A06 106 <sup>7</sup>		
					0986 474 384		→ 53,94	F 026 A06 106 <sup>7</sup>				
					PR-Code 1LK	NOR	0986 134 257		←	F 026 A03 545 <sup>7</sup>		
<b>3.6 FSI R36 4Motion</b>	04.07-11.10	220	PR-Code 1LH, PR-Code 1ZG, PR-Code 1ZM	312	0986 473 384		← 53,94	F 026 A06 106 <sup>7</sup>				
					0986 474 384		→ 53,94	F 026 A06 106 <sup>7</sup>				
					PR-Code 1LK	NOR	0986 134 257		←	F 026 A03 545 <sup>7</sup>		
					0986 134 257		←	1987 470 506 <sup>8</sup>				
					0986 135 257		→	F 026 A03 545 <sup>7</sup>				
					PR-Code 1LM	KZB	0986 134 257		←	F 026 A03 545 <sup>7</sup>		
<b>3.6 FSI</b>	09.05-11.10	206	PR-Code 1LH, PR-Code 1ZG, PR-Code 1ZM	312	0986 473 384		← 53,94	1987 470 506 <sup>8</sup>				
					PR-Code 1LK	NOR	0986 135 257		→	1987 470 506 <sup>8</sup>		
					PR-Code 1LM	KZB	0986 135 257		→	F 026 A03 545 <sup>7</sup>		
					PR-Code 1LH, PR-Code 1ZG, PR-Code 1ZM	312	0986 474 384		← 53,94	F 026 A06 106 <sup>7</sup>		
					PR-Code 1LK	NOR	0986 134 257		←	1987 470 506 <sup>8</sup>		
					PR-Code 1LM	KZB	0986 135 257		→	F 026 A03 545 <sup>7</sup>		
<b>3.6 FSI 4Motion</b>	09.05-11.10	206	PR-Code 1LH, PR-Code 1ZG, PR-Code 1ZM	312	0986 473 384		← 53,94	F 026 A06 106 <sup>7</sup>				
					PR-Code 1LK	NOR	0986 134 257		←	1987 470 506 <sup>8</sup>		
					PR-Code 1LM	KZB	0986 135 257		→	F 026 A03 545 <sup>7</sup>		
					PR-Code 1LH, PR-Code 1ZG, PR-Code 1ZM	312	0986 473 384		← 53,94	F 026 A06 106 <sup>7</sup>		
					PR-Code 1LK	NOR	0986 134 257		←	F 026 A03 545 <sup>7</sup>		
					PR-Code 1LM	KZB	0986 134 257		←	F 026 A03 545 <sup>7</sup>		
<b>1.4 TSI</b>	05.07-05.07	90			0986 473 455		← 38	1987 470 040 <sup>7</sup>				
					0986 474 455		→ 38	1987 470 040 <sup>7</sup>				
					PR-Code 2EA	B31,NOR			1987 474 496 <sup>8</sup>			
<b>1.4 TSI EcoFuel</b>	11.08-11.10	110	PR-Code 1KU					1987 474 496 <sup>8</sup>				
								PR-Code 2EA	B31,NOR			1987 474 496 <sup>8</sup>
								PR-Code 2EL	B31,KZB			1987 474 496 <sup>8</sup>
<b>1.6</b>	08.05-05.07	75						0986 473 455		← 38	1987 470 040 <sup>7</sup>	
								0986 474 455		→ 38	1987 470 040 <sup>7</sup>	
								PR-Code 2EA	B31,NOR			1987 474 496 <sup>8</sup>
								PR-Code 2EL	B31,KZB			1987 474 496 <sup>8</sup>
								PR-Code 1KU				1987 470 040 <sup>7</sup>
												1987 474 496 <sup>8</sup>
<b>1.6 FSI</b>	08.05-04.07	85						0986 473 455		← 38	1987 470 040 <sup>7</sup>	
								0986 474 455		→ 38	1987 470 040 <sup>7</sup>	
								Fg.-Nr. →3C..9P060 099, →3C..9E096 939				1987 470 040 <sup>7</sup>
<b>1.6 TDI</b>	08.09-11.10	77	PR-Code 1KU					1987 474 496 <sup>8</sup>				
								PR-Code 2EA	B31,NOR			1987 474 496 <sup>8</sup>
								PR-Code 2EL	B31,KZB			1987 474 496 <sup>8</sup>
<b>1.8 TSI</b>	05.07-05.07	118						0986 473 455		← 38	1987 470 040 <sup>7</sup>	
								0986 474 455		→ 38	1987 470 040 <sup>7</sup>	



		S								
<b>1.8 TSI</b>	05.07-11.10	118	PR-Code 2EA	B31,NOR					1 987 474 496 <sup>B</sup>	
			PR-Code 2EL	B31,KZB					1 987 474 496 <sup>B</sup>	
	06.07-11.10	118	PR-Code 1KU						1 987 470 040 <sup>7</sup>	
									1 987 474 496 <sup>B</sup>	
									1 987 470 040 <sup>7</sup>	
11.08-11.10	112	PR-Code 1KU						1 987 470 040 <sup>7</sup>		
								1 987 474 496 <sup>B</sup>		
		PR-Code 2EA	B31,NOR					1 987 474 496 <sup>B</sup>		
			PR-Code 2EL	B31,KZB				1 987 474 496 <sup>B</sup>		
<b>1.9 TDI</b>	08.05-04.07	77				0 986 473 455	 ← 38		1 987 470 040 <sup>7</sup>	
						0 986 474 455	 → 38		1 987 470 040 <sup>7</sup>	
	05.07-11.08	77							1 987 470 040 <sup>7</sup>	
									1 987 474 496 <sup>B</sup>	
<b>2.0 FSI</b> <b>2.0 FSI 4Motion</b>	08.05-05.07	110				0 986 473 455	 ← 38		1 987 470 040 <sup>7</sup>	
						0 986 474 455	 → 38		1 987 470 040 <sup>7</sup>	
	11.05-11.10	110	PR-Code 2EA	B31,NOR					1 987 474 496 <sup>B</sup>	
			PR-Code 2EL	B31,KZB					1 987 474 496 <sup>B</sup>	
06.07-11.10	110	PR-Code 1KU						1 987 470 040 <sup>7</sup>		
								1 987 474 496 <sup>B</sup>		
<b>2.0 TDI</b>	08.05-05.06	88/90				0 986 473 455	 ← 38		1 987 470 040 <sup>7</sup>	
						0 986 474 455	 → 38		1 987 470 040 <sup>7</sup>	
	08.05-04.07	120					0 986 473 455	 ← 38	1 987 470 040 <sup>7</sup>	
							0 986 474 455	 → 38	1 987 470 040 <sup>7</sup>	
		125					0 986 473 455	 ← 38	1 987 470 040 <sup>7</sup>	
							0 986 474 455	 → 38	1 987 470 040 <sup>7</sup>	
	05.07-06.08	120							1 987 470 040 <sup>7</sup>	
									1 987 474 496 <sup>B</sup>	
									1 987 470 040 <sup>7</sup>	
									1 987 474 496 <sup>B</sup>	
	05.08-11.10	125	PR-Code 1KU							1 987 470 040 <sup>7</sup>
										1 987 474 496 <sup>B</sup>
			PR-Code 2EA	B31,NOR					1 987 474 496 <sup>B</sup>	
			PR-Code 2EL	B31,KZB					1 987 474 496 <sup>B</sup>	
			PR-Code 1KU						1 987 470 040 <sup>7</sup>	
								1 987 474 496 <sup>B</sup>		
11.08-11.10	81	PR-Code 1KU							1 987 470 040 <sup>7</sup>	
									1 987 474 496 <sup>B</sup>	
		PR-Code 2EA	B31,NOR					1 987 474 496 <sup>B</sup>		
		PR-Code 2EL	B31,KZB					1 987 474 496 <sup>B</sup>		
		PR-Code 1KU						1 987 470 040 <sup>7</sup>		
								1 987 474 496 <sup>B</sup>		
105								1 987 474 496 <sup>B</sup>		
								1 987 474 496 <sup>B</sup>		
<b>2.0 TDI</b> <b>2.0 TDI 4Motion</b>	08.05-04.07	100/103				0 986 473 455	 ← 38		1 987 470 040 <sup>7</sup>	
						0 986 474 455	 → 38		1 987 470 040 <sup>7</sup>	
05.07-06.08	100/103							1 987 470 040 <sup>7</sup>		
								1 987 474 496 <sup>B</sup>		
								1 987 470 040 <sup>7</sup>		
01.08-11.10	100/103	PR-Code 1KU						1 987 470 040 <sup>7</sup>		
								1 987 474 496 <sup>B</sup>		
		PR-Code 2EA	B31,NOR					1 987 474 496 <sup>B</sup>		
			PR-Code 2EL	B31,KZB				1 987 474 496 <sup>B</sup>		
<b>2.0 TDI 4Motion</b> <b>2.0 TSI</b>	05.08-11.10	125	PR-Code 1KU						1 987 470 040 <sup>7</sup>	
									1 987 474 496 <sup>B</sup>	
			PR-Code 2EA	B31,NOR				1 987 474 496 <sup>B</sup>		
			PR-Code 2EL	B31,KZB				1 987 474 496 <sup>B</sup>		
<b>2.0 TSI</b>	08.05-11.05	147	PR-Code 1KU			0 986 473 455	 ← 38		1 987 470 040 <sup>7</sup>	
						0 986 474 455	 → 38		1 987 470 040 <sup>7</sup>	
				PR-Code 2EA	B31				1 987 474 496 <sup>B</sup>	
	08.05-04.07	147							1 987 474 496 <sup>B</sup>	
	05.07-02.08	147	PR-Code 2EA	NOR					1 987 474 496 <sup>B</sup>	
			PR-Code 2EL	KZB					1 987 474 496 <sup>B</sup>	
	11.07-11.10	147	PR-Code 1KU						1 987 470 040 <sup>7</sup>	
								1 987 474 496 <sup>B</sup>		
PR-Code 2EA			B31,NOR					1 987 474 496 <sup>B</sup>		
			PR-Code 2EL	B31,KZB				1 987 474 496 <sup>B</sup>		

			S								
	◀ VW Passat Variant [3C5]										
3.2 FSI 4Motion	11.05-05.07	184						0986 473 455		38	1987 470 040 <sup>7</sup>
								0986 474 455		38	1987 470 040 <sup>7</sup>
	11.05-11.10	184	PR-Code 2EA	B31,NOR							1987 474 496 <sup>8</sup>
			PR-Code 2EL	B31,KZB							1987 474 496 <sup>8</sup>
	06.07-11.10	184	PR-Code 1KU								1987 470 040 <sup>7</sup>
											1987 474 496 <sup>8</sup>
3.6 FSI	09.05-05.07	206/220						0986 473 455		38	1987 470 040 <sup>7</sup>
3.6 FSI R36 4Motion								0986 474 455		38	1987 470 040 <sup>7</sup>
3.6 FSI 4Motion	09.05-11.10	206/220	PR-Code 2EA	B31,NOR							1987 474 496 <sup>8</sup>
			PR-Code 2EL	B31,KZB							1987 474 496 <sup>8</sup>
	06.07-11.10	206/220	PR-Code 1KU								1987 470 040 <sup>7</sup>
											1987 474 496 <sup>8</sup>
<hr/>											
	1.4 TSI	05.07-11.10	90/110		LAB			0986 594 504 <sup>3</sup>			
	1.4 TSI EcoFuel				RAB			0986 594 506 <sup>4</sup>			
								0986 594 505 <sup>3</sup>			
								0986 594 507 <sup>4</sup>			
1.6	08.05-11.10	75/77/85			LAB			0986 594 504 <sup>3</sup>			
					RAB			0986 594 506 <sup>4</sup>			
1.6 FSI								0986 594 505 <sup>3</sup>			
1.6 TDI								0986 594 507 <sup>4</sup>			
1.8 TSI	05.07-11.10	112/118			LAB			0986 594 504 <sup>3</sup>			
					RAB			0986 594 506 <sup>4</sup>			
								0986 594 505 <sup>3</sup>			
								0986 594 507 <sup>4</sup>			
1.9 TDI	08.05-11.08	77			LAB			0986 594 504 <sup>3</sup>			
					RAB			0986 594 506 <sup>4</sup>			
								0986 594 505 <sup>3</sup>			
								0986 594 507 <sup>4</sup>			
2.0 FSI	08.05-11.10	110			LAB			0986 594 504 <sup>3</sup>			
					RAB			0986 594 506 <sup>4</sup>			
								0986 594 505 <sup>3</sup>			
								0986 594 507 <sup>4</sup>			
2.0 FSI 4Motion	09.05-11.10	110			LAB			0986 594 504			
					RAB			0986 594 505			
2.0 TDI	08.05-06.08	120			LAB			0986 594 504 <sup>3</sup>			
					RAB			0986 594 506 <sup>4</sup>			
								0986 594 505 <sup>3</sup>			
								0986 594 507 <sup>4</sup>			
	08.05-11.10	81/88/90/100			LAB			0986 594 504 <sup>3</sup>			
					RAB			0986 594 506 <sup>4</sup>			
								0986 594 505 <sup>3</sup>			
								0986 594 507 <sup>4</sup>			
		103			LAB			0986 594 504 <sup>3</sup>			
					RAB			0986 594 505 <sup>3</sup>			
	11.08-11.10	105			LAB			0986 594 504 <sup>3</sup>			
					RAB			0986 594 506 <sup>4</sup>			
								0986 594 505 <sup>3</sup>			
								0986 594 507 <sup>4</sup>			
2.0 TDI	08.05-11.10	103			LAB			0986 594 506 <sup>4</sup>			
2.0 TDI 4Motion					RAB			0986 594 507 <sup>4</sup>			
2.0 TDI	08.05-11.10	125			LAB			0986 594 504 <sup>3</sup>			
2.0 TSI								0986 594 506 <sup>4</sup>			
					RAB			0986 594 505 <sup>3</sup>			
								0986 594 507 <sup>4</sup>			
2.0 TDI 4Motion	08.05-06.08	103			LAB			0986 594 504 <sup>3</sup>			
					RAB			0986 594 505 <sup>3</sup>			
	05.08-11.10	103			LAB			0986 594 504			
					RAB			0986 594 505			
	05.09-11.10	125			LAB			0986 594 504			
					RAB			0986 594 505			

2.0 TSI	08.05-11.10	147			LAB	0 986 594 504 <sup>3</sup>		
					RAB	0 986 594 506 <sup>4</sup>		
					RAB	0 986 594 505 <sup>3</sup>		
						0 986 594 507 <sup>4</sup>		
3.2 FSI 4Motion	11.05-11.10	184			LAB	0 986 594 504		
					RAB	0 986 594 505		
3.6 FSI	09.05-11.10	206			LAB	0 986 594 504 <sup>3</sup>		
						0 986 594 506 <sup>4</sup>		
					RAB	0 986 594 505 <sup>3</sup>		
						0 986 594 507 <sup>4</sup>		
3.6 FSI R36 4Motion	04.07-11.10	220			LAB	0 986 594 504		
					RAB	0 986 594 505		
3.6 FSI 4Motion	09.05-11.10	206			LAB	0 986 594 504		
					RAB	0 986 594 505		

**Passat Variant [3G5]**

	1.4 GTE Hybrid	05.15→	115		LAB	0 986 594 500 <sup>3</sup>		
					RAB	0 986 594 501 <sup>3</sup>		
	1.4 TSI	08.14→	110		RAB	0 986 594 501 <sup>3</sup>		
		11.14→	92		LAB	0 986 594 500 <sup>3</sup>		
					RAB	0 986 594 501 <sup>3</sup>		
	1.4 TSI, TSI 4Motion	08.14→	110		LAB	0 986 594 500 <sup>3</sup>		
	1.4 TSI 4Motion	02.15→	110		LAB	0 986 594 524 <sup>4</sup>		
					RAB	0 986 594 501 <sup>3</sup>		
						0 986 594 525 <sup>4</sup>		
	1.6 TDI	11.14→	88		LAB	0 986 594 500 <sup>3</sup>		
				RAB	0 986 594 501 <sup>3</sup>			
	1.8 TFSI	02.15→	132		LAB	0 986 594 500 <sup>3</sup>		
				RAB	0 986 594 501 <sup>3</sup>			
	2.0 TDI	11.14→	110		RAB	0 986 594 501 <sup>3</sup>		
			140		RAB	0 986 594 501 <sup>3</sup>		
		05.15→	135		LAB	0 986 594 500 <sup>3</sup>		
					RAB	0 986 594 501 <sup>3</sup>		
	2.0 TDI	11.14→	110		LAB	0 986 594 500 <sup>3</sup>		
	2.0 TDI 4Motion		140		LAB	0 986 594 500 <sup>3</sup>		
	2.0 TDI 4Motion	11.14→	140		LAB	0 986 594 524 <sup>4</sup>		
					RAB	0 986 594 501 <sup>3</sup>		
						0 986 594 525 <sup>4</sup>		
					02.15→	110		LAB
					RAB	0 986 594 501 <sup>3</sup>		
						0 986 594 525 <sup>4</sup>		
	2.0 TDI 4Motion	08.14→	176/206		LAB	0 986 594 500 <sup>3</sup>		
	2.0 TFSI 4Motion					0 986 594 524 <sup>4</sup>		
					RAB	0 986 594 501 <sup>3</sup>		
						0 986 594 525 <sup>4</sup>		
	2.0 TFSI	11.14→	162		LAB	0 986 594 500 <sup>3</sup>		
					RAB	0 986 594 501 <sup>3</sup>		

**Passat Variant [315/35I/3A5]**

	1.6	10.94-03.97	74	11Y		0 986 471 669	← 54	1 987 470 287 <sup>7</sup>	
						0 986 473 669		1 987 474 496 <sup>8</sup>	
						0 986 472 669	→ 54	1 987 470 287 <sup>7</sup>	
						0 986 474 669			
						256	0 986 471 669	← 54	1 987 470 287 <sup>7</sup>
							0 986 473 669		1 987 474 496 <sup>8</sup>
							0 986 472 669	→ 54	1 987 470 287 <sup>7</sup>
							0 986 474 669		













<b>◀ VW Passat Variant [315/35I/3A5]</b>											
	<b>1.8</b>	08.90-03.97	55/66		1LY	0986 471 669	← 54	1987 470 287 <sup>7</sup>			
						0986 473 669		1987 474 496 <sup>8</sup>			
						0986 472 669	→ 54	1987 470 287 <sup>7</sup>			
						0986 474 669					
	256	0986 471 669	← 54	1987 470 287 <sup>7</sup>							
		0986 473 669		1987 474 496 <sup>8</sup>							
		0986 472 669	→ 54	1987 470 287 <sup>7</sup>							
		0986 474 669									
<b>1.9 TD</b>	03.91-03.97	55/66		1LY	0986 471 669	← 54	1987 470 287 <sup>7</sup>				
					0986 473 669		1987 474 496 <sup>8</sup>				
					0986 472 669	→ 54	1987 470 287 <sup>7</sup>				
					0986 474 669						
1.9 TDI	03.91-03.97	55/66		256	0986 471 669	← 54	1987 470 287 <sup>7</sup>				
					0986 473 669		1987 474 496 <sup>8</sup>				
					0986 472 669	→ 54	1987 470 287 <sup>7</sup>				
					0986 474 669						
<b>1.9 TDI</b>	03.96-03.97	81			0986 473 687		← 54	1987 470 287 <sup>7</sup>			
					0986 473 687		← 54	1987 474 496 <sup>8</sup>			
					0986 474 687		→ 54	1987 470 287 <sup>7</sup>			
<b>2.0</b>	01.94-03.97	110			0986 471 923	← 54	1987 470 506 <sup>8</sup>				
					0986 473 923						
					0986 471 924	→ 54	1987 470 506 <sup>8</sup>				
<b>2.0</b>	03.90-03.97	79/85		1LY	0986 471 669	← 54	1987 470 287 <sup>7</sup>				
					0986 473 669		1987 474 496 <sup>8</sup>				
					0986 472 669	→ 54	1987 470 287 <sup>7</sup>				
					0986 474 669						
<b>2.8</b>	06.91-03.97	128			0986 471 923	← 54	1987 470 506 <sup>8</sup>				
					0986 473 923						
					0986 471 924	→ 54	1987 470 506 <sup>8</sup>				
<b>2.8 syncro</b>	10.94-12.95	142		228	0986 474 897		← 54	1987 470 287 <sup>7</sup>			
					0986 474 897		← 54	1987 474 496 <sup>8</sup>			
					0986 474 898		→ 54	1987 470 287 <sup>7</sup>			
					0986 473 070		← 56,93	1987 470 005 <sup>7</sup>			
2.8 syncro	10.94-12.95	142		288	0986 473 070		← 56,93	1987 470 506 <sup>8</sup>			
					0986 474 070		→ 56,93	1987 470 005 <sup>7</sup>			
					0986 471 923	← 54	1987 470 506 <sup>8</sup>				
					0986 473 923						
2.8 syncro	01.94-03.97	135			0986 471 924	→ 54	1987 470 506 <sup>8</sup>				
					0986 473 924						
					0986 473 924						
<hr/>											
	<b>1.6</b>	10.94-03.97	74			0986 475 039	↔ 20,64				
	<b>1.8</b>	08.90-03.97	55/66			0986 475 039	↔ 20,64				
	<b>1.9 TD, TDI</b>	03.91-03.97	55/66			0986 475 039	↔ 20,64				
	<b>1.6</b>	12.95-03.97	74			0986 474 875		← 38			
						0986 474 876		→ 38			
	<b>1.9 TDI</b>	10.93-03.97	66/81				0986 474 875		← 38		
							0986 474 876		→ 38		
	<b>2.0</b>	09.92-09.94	85			Fg.-Nr. 31..P..080 001→	0986 474 875		← 38		
							0986 474 876		→ 38		
		01.94-03.97	110					0986 474 875		← 38	
								0986 474 876		→ 38	
		10.94-03.97	79					0986 474 875		← 38	
								0986 474 876		→ 38	
		85					0986 474 875		← 38		
		85					0986 474 876		→ 38		
	<b>2.0 syncro</b>	09.92-03.97	85			Fg.-Nr. 31-P-080 001→	1LA	0986 474 875		← 38	1987 470 040 <sup>7</sup>
							0986 474 875		← 38	1987 474 496 <sup>8</sup>	
0986 474 876								→ 38	1987 470 040 <sup>7</sup>		

		S									
2.8		09.92-03.97	128	Fg.-Nr. 31..P..080 001→			0 986 474 875		← 38		
							0 986 474 876		→ 38		
2.8 syncro		10.94-12.95	142				0 986 472 830		← 38	1 987 470 040 <sup>7</sup>	
							0 986 474 830			1 987 474 496 <sup>8</sup>	
							0 986 472 831		→ 38	1 987 470 040 <sup>7</sup>	
							0 986 474 831				
2.9 syncro		01.94-03.97	135				0 986 474 875		← 38	1 987 470 040 <sup>7</sup>	
							0 986 474 875		← 38	1 987 474 496 <sup>8</sup>	
							0 986 474 876		→ 38	1 987 470 040 <sup>7</sup>	
	1.6	10.94-12.95	74				1 987 477 407		↔	1624	
		12.95-03.97	74				1 987 477 406		↔	1721	
1.8	09.93-03.97	66				1 987 477 407		↔	1624		
	11.93-03.97	55				1 987 477 407		↔	1624		
1.9 TD	11.93-03.97	55				1 987 477 407		↔	1624		
1.9 TDI	10.93-09.96	66				SBR	1 987 477 406		↔	1721	
						TBR	1 987 477 407		↔	1624	
						03.96-03.97	81			1 987 477 406	
	08.96-03.97	66				1 987 477 406		↔	1721		
2.0	10.93-03.97	79/85/110				1 987 477 406		↔	1721		
2.8	10.93-08.94	128		Fg.-Nr. →3A..S..032 001			1 987 477 406		↔	1721	
2.8 syncro	10.94-12.95	142					1 987 477 803		←	1890	
							1 987 477 804		→	1890	
	1.6	10.94-03.97	74				LAB	0 986 594 001 <sup>3</sup>			
							RAB	0 986 594 000 <sup>3</sup>			
1.8	10.93-03.97	55/66					LAB	0 986 594 001 <sup>3</sup>			
							RAB	0 986 594 000 <sup>3</sup>			
1.9 TD	10.93-03.97	55/66/81					LAB	0 986 594 001 <sup>3</sup>			
1.9 TDI	10.93-03.97	79/85/110					RAB	0 986 594 000 <sup>3</sup>			
2.0	10.93-03.97	79/85/110					LAB	0 986 594 001 <sup>3</sup>			
							RAB	0 986 594 000 <sup>3</sup>			
2.8	10.93-03.97	128					LAB	0 986 594 001 <sup>3</sup>			
							RAB	0 986 594 000 <sup>3</sup>			
2.8 syncro	10.94-12.95	142					MVB	0 986 594 002 <sup>3</sup>			
							MVB	0 986 594 014 <sup>3</sup>			
<b>Passat Variant [365]</b>											
	1.4 TSI	08.10→	90/110/118	PR-Code 1ZM, PR-Code 1ZG	312		0 986 473 384		←	53,94	F 026 A06 106 <sup>7</sup>
							0 986 473 384		←	53,94	1 987 470 506 <sup>8</sup>
	1.4 TSI EcoFuel						0 986 474 384		→	53,94	F 026 A06 106 <sup>7</sup>
1.6 TDI	08.10→	77	PR-Code 1ZM, PR-Code 1ZG	312			0 986 473 384		←	53,94	F 026 A06 106 <sup>7</sup>
							0 986 473 384		←	53,94	1 987 470 506 <sup>8</sup>
							0 986 474 384		→	53,94	F 026 A06 106 <sup>7</sup>
1.8 TSI	08.10→	112/118	PR-Code 1ZM, PR-Code 1ZG	312			0 986 473 384		←	53,94	F 026 A06 106 <sup>7</sup>
							0 986 473 384		←	53,94	1 987 470 506 <sup>8</sup>
							0 986 474 384		→	53,94	F 026 A06 106 <sup>7</sup>
2.0 TDI	08.10→	100/103/125/130/	PR-Code 1ZM, PR-Code 1ZG	312			0 986 473 384		←	53,94	F 026 A06 106 <sup>7</sup>
							0 986 473 384		←	53,94	1 987 470 506 <sup>8</sup>
2.0 TSI	08.10→	155					0 986 474 384		→	53,94	F 026 A06 106 <sup>7</sup>
3.6 V6 4Motion	01.11→	220	PR-Code 1ZM, PR-Code 1ZG	312			0 986 473 384		←	53,94	F 026 A06 106 <sup>7</sup>
							0 986 473 384		←	53,94	1 987 470 506 <sup>8</sup>
							0 986 474 384		→	53,94	F 026 A06 106 <sup>7</sup>
	1.4 TSI	08.10→	90/110/118	PR-Code 2EA	B31						1 987 474 496 <sup>8</sup>
							1.4 TSI EcoFuel				
1.6 TDI	08.10→	77	PR-Code 2EA	B31						1 987 474 496 <sup>8</sup>	
1.8 TSI	08.10→	112/118	PR-Code 2EA	B31						1 987 474 496 <sup>8</sup>	



		S								
	<b>◀ VW Passat Variant [365]</b>									
	2.0 TDI	08.10→	100/103/	PR-Code 2EA	B31				1987 474 496 <sup>8</sup>	
	2.0 TDI 4Motion		125/130/							
	2.0 TSI		155							
	3.6 V6 4Motion	01.11→	220	PR-Code 2EA	B31				1987 474 496 <sup>8</sup>	
	1.4 TSI	08.10→	90/110/		LAB		0986 594 504 <sup>3</sup>			
	1.4 TSI EcoFuel		118		RAB		0986 594 561 <sup>4</sup>			
							0986 594 505 <sup>3</sup>			
							0986 594 560 <sup>4</sup>			
	1.6 TDI	08.10→	77		LAB		0986 594 504 <sup>3</sup>			
					RAB		0986 594 561 <sup>4</sup>			
							0986 594 505 <sup>3</sup>			
							0986 594 560 <sup>4</sup>			
	1.8 TSI	08.10→	112/118		LAB		0986 594 504 <sup>3</sup>			
					RAB		0986 594 561 <sup>4</sup>			
							0986 594 505 <sup>3</sup>			
							0986 594 560 <sup>4</sup>			
	2.0 TDI	08.10→	100		LAB		0986 594 504 <sup>3</sup>			
					RAB		0986 594 561 <sup>4</sup>			
							0986 594 505 <sup>3</sup>			
							0986 594 560 <sup>4</sup>			
			103/125/		LAB		0986 594 561 <sup>4</sup>			
			130		RAB		0986 594 505 <sup>3</sup>			
							0986 594 560 <sup>4</sup>			
	2.0 TDI, TDI 4Motion	08.10→	103/125/130		LAB		0986 594 504 <sup>3</sup>			
	2.0 TDI 4Motion	08.10→	103/125/		LAB		0986 594 524 <sup>4</sup>			
			130		RAB		0986 594 505 <sup>3</sup>			
							0986 594 525 <sup>4</sup>			
	2.0 TSI	11.10→	155		LAB		0986 594 504 <sup>3</sup>			
					RAB		0986 594 561 <sup>4</sup>			
							0986 594 505 <sup>3</sup>			
							0986 594 560 <sup>4</sup>			
	3.6 V6 4Motion	01.11→	220		LAB		0986 594 504 <sup>3</sup>			
					RAB		0986 594 524 <sup>4</sup>			
							0986 594 505 <sup>3</sup>			
							0986 594 525 <sup>4</sup>			
	<b>Passat [3B2]</b>									
	1.6	10.96-11.00	74		228		0986 474 897		54	1987 470 287 <sup>7</sup>
							0986 474 897		54	1987 474 496 <sup>8</sup>
							0986 474 898		54	1987 470 287 <sup>7</sup>
					288		0986 473 070		56,93	1987 470 005 <sup>7</sup>
							0986 473 070		56,93	1987 470 506 <sup>8</sup>
							0986 474 070		56,93	1987 470 005 <sup>7</sup>
	1.8	10.96-11.00	85-110		228		0986 474 897		54	1987 470 287 <sup>7</sup>
	1.8 syncro						0986 474 897		54	1987 474 496 <sup>8</sup>
	1.8 Turbo						0986 474 898		54	1987 470 287 <sup>7</sup>
					288		0986 473 070		56,93	1987 470 005 <sup>7</sup>
							0986 474 070		56,93	1987 470 005 <sup>7</sup>
	1.8, Turbo	10.96-11.00	85-110		288		0986 473 070		56,93	1987 470 506 <sup>8</sup>
	1.9 TDI	10.96-11.00	66/74		228		0986 474 897		54	1987 470 287 <sup>7</sup>
							0986 474 897		54	1987 474 496 <sup>8</sup>
							0986 474 898		54	1987 470 287 <sup>7</sup>
					288		0986 473 070		56,93	1987 470 506 <sup>8</sup>
							0986 474 070		56,93	1987 470 005 <sup>7</sup>
							0986 474 070		56,93	1987 470 506 <sup>8</sup>
			81/85		228		0986 474 897		54	1987 470 287 <sup>7</sup>

		S							
1.9 TDI	10.96-11.00	81/85				288	0 986 473 070	← 56,93	1 987 470 506 <sup>B</sup>
							0 986 474 070	→ 56,93	1 987 470 005 <sup>7</sup>
							0 986 474 070	→ 56,93	1 987 470 506 <sup>B</sup>
1.9 TDI syncro	06.97-11.00	81/85				228	0 986 474 897	← 54	1 987 470 287 <sup>7</sup>
						288	0 986 473 070	← 56,93	1 987 470 005 <sup>7</sup>
							0 986 474 070	→ 56,93	1 987 470 005 <sup>7</sup>
1.9 TDI	10.96-11.00	81/85				228	0 986 474 897	← 54	1 987 474 496 <sup>B</sup>
1.9 TDI syncro							0 986 474 898	→ 54	1 987 470 287 <sup>7</sup>
2.0	01.00-08.00	88				228	0 986 474 897	← 54	1 987 470 287 <sup>7</sup>
							0 986 474 897	← 54	1 987 474 496 <sup>B</sup>
							0 986 474 898	→ 54	1 987 470 287 <sup>7</sup>
						288	0 986 473 070	← 56,93	1 987 470 005 <sup>7</sup>
							0 986 473 070	← 56,93	1 987 470 506 <sup>B</sup>
							0 986 474 070	→ 56,93	1 987 470 005 <sup>7</sup>
2.3	10.96-11.00	110				228	0 986 474 897	← 54	1 987 470 287 <sup>7</sup>
							0 986 474 897	← 54	1 987 474 496 <sup>B</sup>
							0 986 474 898	→ 54	1 987 470 287 <sup>7</sup>
						288	0 986 473 070	← 56,93	1 987 470 506 <sup>B</sup>
							0 986 474 070	→ 56,93	1 987 470 005 <sup>7</sup>
							0 986 474 070	→ 56,93	1 987 470 506 <sup>B</sup>
2.3 syncro	06.97-11.00	110				228	0 986 474 897	← 54	1 987 474 496 <sup>B</sup>
							0 986 474 898	→ 54	1 987 470 287 <sup>7</sup>
							0 986 474 898	→ 54	1 987 474 496 <sup>B</sup>
						288	0 986 473 070	← 56,93	1 987 470 005 <sup>7</sup>
							0 986 474 070	→ 56,93	1 987 470 005 <sup>7</sup>
2.5 TDI	08.98-11.00	110				228	0 986 474 897	← 54	1 987 470 287 <sup>7</sup>
						288	0 986 473 070	← 56,93	1 987 470 506 <sup>B</sup>
							0 986 474 070	→ 56,93	1 987 470 005 <sup>7</sup>
							0 986 474 070	→ 56,93	1 987 470 506 <sup>B</sup>
2.5 TDI syncro	08.98-11.00	110				228	0 986 474 897	← 54	1 987 470 287 <sup>7</sup>
						288	0 986 473 070	← 56,93	1 987 470 005 <sup>7</sup>
							0 986 474 070	→ 56,93	1 987 470 005 <sup>7</sup>
2.5 TDI	08.98-11.00	110				228	0 986 474 897	← 54	1 987 474 496 <sup>B</sup>
2.5 TDI syncro							0 986 474 898	→ 54	1 987 470 287 <sup>7</sup>
2.8	01.97-11.00	132		PR-Code 1LB, PR-Code 1LE, PR-Code 1ZC		288	0 986 473 070	← 56,93	1 987 470 005 <sup>7</sup>
							0 986 473 070	← 56,93	1 987 470 506 <sup>B</sup>
							0 986 474 070	→ 56,93	1 987 470 005 <sup>7</sup>
				PR-Code 1LZ, PR-Code 1LJ		228	0 986 474 897	← 54	1 987 470 287 <sup>7</sup>
							0 986 474 897	← 54	1 987 474 496 <sup>B</sup>
							0 986 474 898	→ 54	1 987 470 287 <sup>7</sup>
		142				228	0 986 474 897	← 54	1 987 470 287 <sup>7</sup>
							0 986 474 897	← 54	1 987 474 496 <sup>B</sup>
							0 986 474 898	→ 54	1 987 470 287 <sup>7</sup>
						288	0 986 473 070	← 56,93	1 987 470 506 <sup>B</sup>
							0 986 474 070	→ 56,93	1 987 470 005 <sup>7</sup>
							0 986 474 070	→ 56,93	1 987 470 506 <sup>B</sup>
							0 986 474 070	→ 56,93	1 987 470 005 <sup>7</sup>
	10.97-08.00					228	0 986 474 897	← 54	1 987 470 287 <sup>7</sup>
							0 986 474 897	← 54	1 987 474 496 <sup>B</sup>
							0 986 474 898	→ 54	1 987 470 287 <sup>7</sup>
						288	0 986 473 070	← 56,93	1 987 470 005 <sup>7</sup>
							0 986 473 070	← 56,93	1 987 470 506 <sup>B</sup>
							0 986 474 070	→ 56,93	1 987 470 005 <sup>7</sup>
							0 986 474 070	→ 56,93	1 987 470 005 <sup>7</sup>
	10.99-11.00	140				228	0 986 474 897	← 54	1 987 470 287 <sup>7</sup>
							0 986 474 897	← 54	1 987 474 496 <sup>B</sup>
							0 986 474 898	→ 54	1 987 470 287 <sup>7</sup>
						288	0 986 473 070	← 56,93	1 987 470 005 <sup>7</sup>
							0 986 473 070	← 56,93	1 987 470 506 <sup>B</sup>
							0 986 474 070	→ 56,93	1 987 470 005 <sup>7</sup>
2.8 syncro	01.97-11.00	142				228	0 986 474 897	← 54	1 987 474 496 <sup>B</sup>
							0 986 474 898	→ 54	1 987 470 287 <sup>7</sup>
							0 986 474 898	→ 54	1 987 474 496 <sup>B</sup>
						288	0 986 473 070	← 56,93	1 987 470 005 <sup>7</sup>
							0 986 474 070	→ 56,93	1 987 470 005 <sup>7</sup>











		S								
◀ VW Passat [3B2]										
	1.6	10.96-11.00	74				0986 472 830	← 38	1987 470 040 <sup>7</sup>	
							0986 474 830		1987 474 496 <sup>8</sup>	
							0986 472 831	→ 38	1987 470 040 <sup>7</sup>	
							0986 474 831			
1.8	12.96-11.00	92					0986 472 830	← 38	1987 470 040 <sup>7</sup>	
							0986 474 830		1987 474 496 <sup>8</sup>	
							0986 472 831	→ 38	1987 470 040 <sup>7</sup>	
							0986 474 831			
1.8 1.8 Turbo	10.96-11.00	85-110					0986 472 830	← 38	1987 470 040 <sup>7</sup>	
							0986 474 830		1987 474 496 <sup>8</sup>	
							0986 472 831	→ 38	1987 470 040 <sup>7</sup>	
							0986 474 831			
1.8 syncro	05.98-11.00	92			245		0986 473 225	← 38,1	1987 470 040 <sup>7</sup>	
							0986 473 225	← 38,1	1987 474 496 <sup>8</sup>	
							0986 474 225	→ 38,1	1987 470 040 <sup>7</sup>	
1.8 Turbo	08.98-11.00	110					0986 472 830	← 38	1987 470 040 <sup>7</sup>	
							0986 474 830		1987 474 496 <sup>8</sup>	
							0986 472 831	→ 38	1987 470 040 <sup>7</sup>	
							0986 474 831			
1.9 TDI	10.96-11.00	66/74					0986 472 830	← 38	1987 470 040 <sup>7</sup>	
							0986 474 830		1987 474 496 <sup>8</sup>	
							0986 472 831	→ 38	1987 470 040 <sup>7</sup>	
							0986 474 831			
			81					0986 472 830	← 38	1987 470 040 <sup>7</sup>
								0986 474 830		1987 474 496 <sup>8</sup>
								0986 472 831	→ 38	1987 470 040 <sup>7</sup>
								0986 474 831		
	01.98-11.00	85					0986 472 830	← 38	1987 470 040 <sup>7</sup>	
							0986 474 830		1987 474 496 <sup>8</sup>	
							0986 472 831	→ 38	1987 470 040 <sup>7</sup>	
							0986 474 831			
1.9 TDI syncro	06.97-11.00	81					0986 473 225	← 38,1	1987 470 040 <sup>7</sup>	
							0986 473 225	← 38,1	1987 474 496 <sup>8</sup>	
							0986 474 225	→ 38,1	1987 470 040 <sup>7</sup>	
		08.99-08.00	81			245		0986 473 225	← 38,1	1987 470 040 <sup>7</sup>
								0986 473 225	← 38,1	1987 474 496 <sup>8</sup>
								0986 474 225	→ 38,1	1987 470 040 <sup>7</sup>
	01.00-08.00	85			245		0986 473 225	← 38,1	1987 470 040 <sup>7</sup>	
							0986 473 225	← 38,1	1987 474 496 <sup>8</sup>	
							0986 474 225	→ 38,1	1987 470 040 <sup>7</sup>	
2.0	01.00-08.00	88					0986 472 830	← 38	1987 470 040 <sup>7</sup>	
							0986 474 830		1987 474 496 <sup>8</sup>	
							0986 472 831	→ 38	1987 470 040 <sup>7</sup>	
							0986 474 831			
2.3	10.96-11.00	110					0986 472 830	← 38	1987 470 040 <sup>7</sup>	
							0986 474 830		1987 474 496 <sup>8</sup>	
							0986 472 831	→ 38	1987 470 040 <sup>7</sup>	
							0986 474 831			
2.3 syncro	05.98-11.00	110			245		0986 473 225	← 38,1	1987 470 040 <sup>7</sup>	
							0986 473 225	← 38,1	1987 474 496 <sup>8</sup>	
							0986 474 225	→ 38,1	1987 470 040 <sup>7</sup>	
2.5 TDI	08.98-11.00	110					0986 472 830	← 38	1987 470 040 <sup>7</sup>	
							0986 474 830		1987 474 496 <sup>8</sup>	
							0986 472 831	→ 38	1987 470 040 <sup>7</sup>	
							0986 474 831			
2.5 TDI syncro	08.98-11.00	110			245		0986 473 225	← 38,1	1987 470 040 <sup>7</sup>	
							0986 473 225	← 38,1	1987 474 496 <sup>8</sup>	
							0986 474 225	→ 38,1	1987 470 040 <sup>7</sup>	



2.8	01.97-11.00	132/140				0 986 472 830	← 38	1 987 470 040 <sup>7</sup>	
						0 986 474 830		1 987 474 496 <sup>8</sup>	
						0 986 472 831	→ 38	1 987 470 040 <sup>7</sup>	
						0 986 474 831			
						142			
						0 986 472 830	← 38	1 987 470 040 <sup>7</sup>	
2.8 syncro	05.98-11.00	142			245	0 986 473 225	← 38,1	1 987 470 040 <sup>7</sup>	
						0 986 473 225	← 38,1	1 987 474 496 <sup>8</sup>	
						0 986 474 225	→ 38,1	1 987 470 040 <sup>7</sup>	
						0 986 474 225			
	1.6	10.96-11.00	74			1 987 477 803	← 1890		
						1 987 477 804	→ 1890		
	1.8	10.96-11.00	85-110				1 987 477 803	← 1890	
							1 987 477 804	→ 1890	
	1.8 Turbo						1 987 477 804	→ 1890	
	1.9 TDI	10.96-11.00	66/74/81/ 85				1 987 477 803	← 1890	
							1 987 477 804	→ 1890	
	2.0	01.00-08.00	88				1 987 477 803	← 1890	
							1 987 477 804	→ 1890	
	2.3	10.96-11.00	110				1 987 477 803	← 1890	
							1 987 477 804	→ 1890	
	2.5 TDI	08.98-11.00	110				1 987 477 803	← 1890	
							1 987 477 804	→ 1890	
	2.8	01.97-11.00	132/140/ 142				1 987 477 803	← 1890	
							1 987 477 804	→ 1890	
		1.6	10.96-11.00	74			MVB	0 986 594 002 <sup>3</sup>	
							MVB	0 986 594 014 <sup>3</sup>	
		1.8	12.96-11.00	92				MVB	0 986 594 002 <sup>3</sup>
MVB								0 986 594 014 <sup>3</sup>	
1.8		10.96-11.00	85-110				MVB	0 986 594 002 <sup>3</sup>	
							MVB	0 986 594 014 <sup>3</sup>	
1.8 syncro		06.97-01.99	92				0 986 594 014 <sup>3</sup>		
							11.98-01.99	92	Fg.-Nr. 3B..X..338 107→
							ALR,RAB	0 265 006 573 <sup>4</sup>	
							ALR	0 265 006 573 <sup>4</sup>	
		01.99-04.99	92		Fg.-Nr. →3B..X..600 000		0 986 594 014 <sup>3</sup>		
		01.99-11.00	92			ALR,LAB	0 265 006 575 <sup>4</sup>		
						ALR,RAB	0 265 006 573 <sup>4</sup>		
						ALR	0 265 006 573 <sup>4</sup>		
		05.99-11.00	92		Fg.-Nr. 3B..Y..000 001→		0 986 594 002 <sup>3</sup>		
1.8 Turbo		08.98-11.00	110				MVB	0 986 594 002 <sup>3</sup>	
							MVB	0 986 594 014 <sup>3</sup>	
1.9 TDI		10.96-11.00	66/74				MVB	0 986 594 002 <sup>3</sup>	
							MVB	0 986 594 014 <sup>3</sup>	
			81				MVB	0 986 594 002 <sup>3</sup>	
			MVB				0 986 594 014 <sup>3</sup>		
		01.98-11.00	85			MVB	0 986 594 002 <sup>3</sup>		
						MVB	0 986 594 014 <sup>3</sup>		
1.9 TDI syncro	06.97-04.99	81				0 986 594 014 <sup>3</sup>			
						11.98-11.00	81	Fg.-Nr. 3B..X..338 107→	ALR,LAB
							ALR,RAB	0 265 006 573 <sup>4</sup>	
							ALR	0 265 006 573 <sup>4</sup>	
		05.99-11.00	81		Fg.-Nr. 3B..Y..000 001→		0 986 594 002 <sup>3</sup>		
		08.99-08.00	81				0 986 594 002 <sup>3</sup>		
						ALR,LAB	0 265 006 575 <sup>4</sup>		
						ALR,RAB	0 265 006 573 <sup>4</sup>		
						ALR	0 265 006 573 <sup>4</sup>		
	01.00-08.00	85				0 986 594 002 <sup>3</sup>			
						ALR,LAB	0 265 006 575 <sup>4</sup>		



<b>◀ VW Passat [3B2]</b>											
<b>1.9 TDI syncro</b>	01.00-08.00	85				ALR,RAB	0 265 006 573 <sup>4</sup>				
						ALR	0 265 006 573 <sup>4</sup>				
<b>2.0</b>	01.00-08.00	88				MVB	0 986 594 002 <sup>3</sup>				
						MVB	0 986 594 014 <sup>3</sup>				
<b>2.3</b>	10.96-11.00	110				MVB	0 986 594 002 <sup>3</sup>				
						MVB	0 986 594 014 <sup>3</sup>				
<b>2.3 syncro</b>	06.97-04.99	110		Fg.-Nr. →3B..X..600 000			0 986 594 014 <sup>3</sup>				
							0 986 594 014 <sup>3</sup>				
	11.98-11.00	110		Fg.-Nr. 3B..X..338 107→			ALR,LAB	0 265 006 575 <sup>4</sup>			
							ALR,RAB	0 265 006 573 <sup>4</sup>			
						ALR	0 265 006 573 <sup>4</sup>				
	05.99-11.00	110		Fg.-Nr. 3B..Y..000 001→			0 986 594 002 <sup>3</sup>				
<b>2.5 TDI</b>	08.98-11.00	110				MVB	0 986 594 002 <sup>3</sup>				
						MVB	0 986 594 014 <sup>3</sup>				
<b>2.5 TDI syncro</b>	08.98-04.99	110		Fg.-Nr. →3B..X..600 000			0 986 594 014 <sup>3</sup>				
							0 986 594 014 <sup>3</sup>				
	11.98-11.00	110		Fg.-Nr. 3B..X..338 107→			ALR,LAB	0 265 006 575 <sup>4</sup>			
							ALR,RAB	0 265 006 573 <sup>4</sup>			
						ALR	0 265 006 573 <sup>4</sup>				
	05.99-11.00	110		Fg.-Nr. 3B..Y..000 001→			0 986 594 002 <sup>3</sup>				
<b>2.8</b>	01.97-11.00	132/140				MVB	0 986 594 002 <sup>3</sup>				
						MVB	0 986 594 014 <sup>3</sup>				
			142				MVB	0 986 594 002 <sup>3</sup>			
							MVB	0 986 594 014 <sup>3</sup>			
<b>2.8 syncro</b>	01.97-04.99	142		Fg.-Nr. →3B..X..600 000			0 986 594 014 <sup>3</sup>				
							0 986 594 014 <sup>3</sup>				
	11.98-11.00	142		Fg.-Nr. 3B..X..338 107→			ALR,LAB	0 265 006 575 <sup>4</sup>			
							ALR,RAB	0 265 006 573 <sup>4</sup>			
						ALR	0 265 006 573 <sup>4</sup>				
	01.99-11.00	142				ALR,LAB	0 265 006 575 <sup>4</sup>				
						ALR,RAB	0 265 006 573 <sup>4</sup>				
						ALR	0 265 006 573 <sup>4</sup>				
	05.99-11.00	142		Fg.-Nr. 3B..Y..000 001→			0 986 594 002 <sup>3</sup>				
	10.99-11.00	142					0 986 594 002 <sup>3</sup>				
<b>Passat [3B3]</b>											
	<b>1.6</b>	10.00-05.05	75			288	0 986 473 070		← 56,93	1 987 470 005 <sup>7</sup>	
							0 986 474 070		→ 56,93	1 987 470 005 <sup>7</sup>	
							312	0 986 473 070		← 56,93	1 987 470 005 <sup>7</sup>
								0 986 473 070		← 56,93	1 987 470 506 <sup>8</sup>
								0 986 474 070		→ 56,93	1 987 470 005 <sup>7</sup>
								0 986 474 070		→ 56,93	1 987 470 005 <sup>7</sup>
	<b>1.8</b>	10.00-05.05	110/125			288	0 986 473 070		← 56,93	1 987 470 005 <sup>7</sup>	
							0 986 474 070		→ 56,93	1 987 470 005 <sup>7</sup>	
							312	0 986 473 070		← 56,93	1 987 470 005 <sup>7</sup>
								0 986 473 070		← 56,93	1 987 470 506 <sup>8</sup>
								0 986 474 070		→ 56,93	1 987 470 005 <sup>7</sup>
								0 986 474 070		→ 56,93	1 987 470 005 <sup>7</sup>
<b>1.9 TDI</b>	10.00-05.05	74			288	0 986 473 070		← 56,93	1 987 470 005 <sup>7</sup>		
						0 986 474 070		→ 56,93	1 987 470 005 <sup>7</sup>		
						312	0 986 473 070		← 56,93	1 987 470 005 <sup>7</sup>	
						0 986 473 070		← 56,93	1 987 470 506 <sup>8</sup>		
						0 986 474 070		→ 56,93	1 987 470 005 <sup>7</sup>		
							96			288	0 986 474 070
					312	0 986 473 070		← 56,93	1 987 470 506 <sup>8</sup>		
						0 986 474 070		→ 56,93	1 987 470 506 <sup>8</sup>		
<b>1.9 TDI</b>	10.00-05.05	96			288	0 986 473 070		← 56,93	1 987 470 005 <sup>7</sup>		
<b>1.9 TDI 4Motion</b>					312	0 986 473 070		← 56,93	1 987 470 005 <sup>7</sup>		
<b>1.9 TDI 4Motion</b>	10.00-05.05	96			288	0 986 473 070		← 56,93	1 987 470 506 <sup>8</sup>		
						0 986 474 070		→ 56,93	1 987 470 005 <sup>7</sup>		
						312	0 986 473 070		← 56,93	1 987 470 506 <sup>8</sup>	
							0 986 474 070		→ 56,93	1 987 470 005 <sup>7</sup>	
					321	0 986 134 074		← 43			
						0 986 135 074		→ 43			
<b>2.0</b>	10.00-05.05	85		PR-Code 1LE, PR-Code 1ZC	288	0 986 473 070		← 56,93	1 987 470 005 <sup>7</sup>		
						0 986 474 070		→ 56,93	1 987 470 005 <sup>7</sup>		























































		<b>S</b>										
<b>2.0</b>		10.00-05.05	85	PR-Code 1LT	312		0 986 473 070	← 56,93	1 987 470 005 <sup>7</sup>			
							0 986 473 070	← 56,93	1 987 470 506 <sup>B</sup>			
							0 986 474 070	→ 56,93	1 987 470 005 <sup>7</sup>			
				PR-Code 1ZF, PR-Code 1ZG	321		0 986 134 074	← 43	1 987 470 005 <sup>7</sup>			
							0 986 135 074	→ 43	1 987 470 005 <sup>7</sup>			
<b>2.0</b> <b>2.0 TDI</b>		11.01-05.05	96/100		288		0 986 473 070	← 56,93	1 987 470 005 <sup>7</sup>			
							0 986 474 070	→ 56,93	1 987 470 005 <sup>7</sup>			
							0 986 473 070	← 56,93	1 987 470 005 <sup>7</sup>			
					312		0 986 473 070	← 56,93	1 987 470 005 <sup>7</sup>			
							0 986 473 070	← 56,93	1 987 470 506 <sup>B</sup>			
							0 986 474 070	→ 56,93	1 987 470 005 <sup>7</sup>			
<b>2.0 4Motion</b>		10.00-05.05	85		288		0 986 473 070	← 56,93	1 987 470 005 <sup>7</sup>			
							0 986 473 070	← 56,93	1 987 470 506 <sup>B</sup>			
							0 986 474 070	→ 56,93	1 987 470 005 <sup>7</sup>			
					312		0 986 473 070	← 56,93	1 987 470 005 <sup>7</sup>			
							0 986 473 070	← 56,93	1 987 470 506 <sup>B</sup>			
							0 986 474 070	→ 56,93	1 987 470 005 <sup>7</sup>			
					321		0 986 134 074	← 43				
							0 986 135 074	→ 43				
<b>2.3</b>		10.00-05.05	125		288		0 986 474 070	→ 56,93	1 987 470 005 <sup>7</sup>			
							0 986 473 070	← 56,93	1 987 470 506 <sup>B</sup>			
							0 986 474 070	→ 56,93	1 987 470 506 <sup>B</sup>			
<b>2.3</b> <b>2.3 4Motion</b>		10.00-05.05	125		288		0 986 473 070	← 56,93	1 987 470 005 <sup>7</sup>			
							0 986 473 070	← 56,93	1 987 470 005 <sup>7</sup>			
							0 986 474 070	→ 56,93	1 987 470 506 <sup>B</sup>			
<b>2.3 4Motion</b>		01.01-05.05	125		288		0 986 473 070	← 56,93	1 987 470 506 <sup>B</sup>			
							0 986 474 070	→ 56,93	1 987 470 005 <sup>7</sup>			
							0 986 473 070	← 56,93	1 987 470 506 <sup>B</sup>			
					312		0 986 474 070	→ 56,93	1 987 470 005 <sup>7</sup>			
					321		0 986 134 074	← 43				
							0 986 135 074	→ 43				
<b>2.5 TDI</b>		10.00-05.03	110		288		0 986 474 070	→ 56,93	1 987 470 005 <sup>7</sup>			
							0 986 473 070	← 56,93	1 987 470 506 <sup>B</sup>			
							0 986 474 070	→ 56,93	1 987 470 506 <sup>B</sup>			
		05.03-05.05	120		288		0 986 473 070	← 56,93	1 987 470 005 <sup>7</sup>			
	0 986 474 070					→ 56,93	1 987 470 005 <sup>7</sup>					
	0 986 473 070					← 56,93	1 987 470 005 <sup>7</sup>					
					312		0 986 473 070	← 56,93	1 987 470 506 <sup>B</sup>			
							0 986 473 070	← 56,93	1 987 470 506 <sup>B</sup>			
							0 986 474 070	→ 56,93	1 987 470 005 <sup>7</sup>			
<b>2.5 TDI</b> <b>2.5 TDI 4Motion</b> <b>2.5 TDI 4Motion</b>		10.00-05.03	110		288		0 986 473 070	← 56,93	1 987 470 005 <sup>7</sup>			
							0 986 473 070	← 56,93	1 987 470 005 <sup>7</sup>			
							0 986 474 070	→ 56,93	1 987 470 506 <sup>B</sup>			
					312		0 986 473 070	← 56,93	1 987 470 506 <sup>B</sup>			
							0 986 474 070	→ 56,93	1 987 470 005 <sup>7</sup>			
					321		0 986 134 074	← 43				
							0 986 135 074	→ 43				
		01.03-05.05	132		288		0 986 473 070	← 56,93	1 987 470 005 <sup>7</sup>			
	0 986 473 070					← 56,93	1 987 470 506 <sup>B</sup>					
	0 986 474 070					→ 56,93	1 987 470 005 <sup>7</sup>					
					312		0 986 473 070	← 56,93	1 987 470 005 <sup>7</sup>			
							0 986 473 070	← 56,93	1 987 470 506 <sup>B</sup>			
							0 986 474 070	→ 56,93	1 987 470 005 <sup>7</sup>			
					321		0 986 134 074	← 43				
							0 986 135 074	→ 43				
<b>2.8</b>		10.00-05.05	140	PR-Code 1LE, PR-Code 1ZC	288		0 986 473 070	← 56,93	1 987 470 005 <sup>7</sup>			
							0 986 474 070	→ 56,93	1 987 470 005 <sup>7</sup>			
							0 986 473 070	← 56,93	1 987 470 005 <sup>7</sup>			
				PR-Code 1LT	312		0 986 473 070	← 56,93	1 987 470 005 <sup>7</sup>			
							0 986 473 070	← 56,93	1 987 470 506 <sup>B</sup>			
							0 986 474 070	→ 56,93	1 987 470 005 <sup>7</sup>			
				PR-Code 1ZF, PR-Code 1ZG	321		0 986 134 074	← 43	1 987 470 005 <sup>7</sup>			
							0 986 135 074	→ 43	1 987 470 005 <sup>7</sup>			
			142		312		0 986 473 070	← 56,93	1 987 470 005 <sup>7</sup>			
										0 986 473 070	← 56,93	1 987 470 506 <sup>B</sup>
										0 986 474 070	→ 56,93	1 987 470 005 <sup>7</sup>





		S							
	◀ VW Passat [3B3]								
<b>2.8</b>		10.00-05.05	142		321	0986 134 074		← 43	1987 470 005 <sup>7</sup>
						0986 135 074		→ 43	1987 470 005 <sup>7</sup>
<b>2.8 4Motion</b>		10.00-05.05	140		288	0986 473 070		← 56,93	1987 470 005 <sup>7</sup>
						0986 473 070		← 56,93	1987 470 506 <sup>8</sup>
						0986 474 070		→ 56,93	1987 470 005 <sup>7</sup>
					312	0986 473 070		← 56,93	1987 470 005 <sup>7</sup>
						0986 473 070		← 56,93	1987 470 506 <sup>8</sup>
						0986 474 070		→ 56,93	1987 470 005 <sup>7</sup>
					321	0986 134 074		← 43	
						0986 135 074		→ 43	
			142		288	0986 473 070		← 56,93	1987 470 005 <sup>7</sup>
						0986 473 070		← 56,93	1987 470 506 <sup>8</sup>
						0986 474 070		→ 56,93	1987 470 005 <sup>7</sup>
					312	0986 473 070		← 56,93	1987 470 005 <sup>7</sup>
						0986 473 070		← 56,93	1987 470 506 <sup>8</sup>
						0986 474 070		→ 56,93	1987 470 005 <sup>7</sup>
					321	0986 134 074		← 43	
						0986 135 074		→ 43	
<b>4.0</b>		05.02-09.04	202		321	0986 134 074		← 43	1987 470 005 <sup>7</sup>
						0986 135 074		→ 43	1987 470 005 <sup>7</sup>
<b>4.0 4Motion</b>		09.01-09.04	202		288	0986 473 070		← 56,93	1987 470 005 <sup>7</sup>
						0986 473 070		← 56,93	1987 470 506 <sup>8</sup>
						0986 474 070		→ 56,93	1987 470 005 <sup>7</sup>
					312	0986 473 070		← 56,93	1987 470 005 <sup>7</sup>
						0986 473 070		← 56,93	1987 470 506 <sup>8</sup>
						0986 474 070		→ 56,93	1987 470 005 <sup>7</sup>
					321	0986 134 074		← 43	
						0986 135 074		→ 43	
<hr/>									
	<b>1.6</b>	10.00-05.05	75			0986 472 830		← 38	1987 470 040 <sup>7</sup>
						0986 474 830			1987 474 496 <sup>8</sup>
						0986 472 831		→ 38	1987 470 040 <sup>7</sup>
						0986 474 831			
	<b>1.8</b>	10.00-05.05	110/125			0986 472 830		← 38	1987 470 040 <sup>7</sup>
						0986 474 830			1987 474 496 <sup>8</sup>
						0986 472 831		→ 38	1987 470 040 <sup>7</sup>
						0986 474 831			
	<b>1.9 TDI</b>	10.00-05.05	74			0986 472 830		← 38	1987 470 040 <sup>7</sup>
						0986 474 830			1987 474 496 <sup>8</sup>
						0986 472 831		→ 38	1987 470 040 <sup>7</sup>
						0986 474 831			
			96			0986 472 830		← 38	1987 470 040 <sup>7</sup>
						0986 474 830			1987 474 496 <sup>8</sup>
						0986 472 831		→ 38	1987 470 040 <sup>7</sup>
						0986 474 831			
	<b>1.9 TDI 4Motion</b>	10.00-05.05	96		245	0986 473 225		← 38,1	1987 470 040 <sup>7</sup>
						0986 473 225		← 38,1	1987 474 496 <sup>8</sup>
						0986 474 225		→ 38,1	1987 470 040 <sup>7</sup>
					252	0986 473 185		← 43	F 026 A06 121 <sup>7</sup>
						0986 473 185		← 43	1987 474 496 <sup>8</sup>
						0986 474 185		→ 43	F 026 A06 121 <sup>7</sup>
	<b>2.0</b>	10.00-05.05	85			0986 472 830		← 38	1987 470 040 <sup>7</sup>
						0986 474 830			1987 474 496 <sup>8</sup>
						0986 472 831		→ 38	1987 470 040 <sup>7</sup>
						0986 474 831			
	<b>2.0</b>	11.01-05.05	96/100			0986 472 830		← 38	1987 470 040 <sup>7</sup>
	<b>2.0 TDI</b>					0986 474 830			1987 474 496 <sup>8</sup>
						0986 472 831		→ 38	1987 470 040 <sup>7</sup>
						0986 474 831			



	<b>S</b>											
<b>2.0 4Motion</b>	10.00-05.05	85			245	0 986 473 225	 ← 38,1	1 987 470 040 <sup>7</sup>				
						0 986 473 225	 ← 38,1	1 987 474 496 <sup>8</sup>				
						0 986 474 225	 → 38,1	1 987 470 040 <sup>7</sup>				
					252	0 986 473 185	 ← 43	F 026 A06 121 <sup>7</sup>				
						0 986 473 185	 ← 43	1 987 474 496 <sup>8</sup>				
						0 986 474 185	 → 43	F 026 A06 121 <sup>7</sup>				
<b>2.3</b>	10.00-05.05	125				0 986 472 830	← 38	1 987 470 040 <sup>7</sup>				
						0 986 474 830		1 987 474 496 <sup>8</sup>				
						0 986 472 831	→ 38	1 987 470 040 <sup>7</sup>				
						0 986 474 831						
						<b>2.3 4Motion</b>	01.01-05.05	125	245	0 986 473 225	 ← 38,1	1 987 470 040 <sup>7</sup>
										0 986 473 225	 ← 38,1	1 987 474 496 <sup>8</sup>
0 986 474 225	 → 38,1	1 987 470 040 <sup>7</sup>										
				252	0 986 473 185	 ← 43	F 026 A06 121 <sup>7</sup>					
					0 986 473 185	 ← 43	1 987 474 496 <sup>8</sup>					
					0 986 474 185	 → 43	F 026 A06 121 <sup>7</sup>					
<b>2.5 TDI</b>	10.00-05.03	110				0 986 472 830	← 38	1 987 470 040 <sup>7</sup>				
						0 986 474 830		1 987 474 496 <sup>8</sup>				
						0 986 472 831	→ 38	1 987 470 040 <sup>7</sup>				
		05.03-05.05	120				0 986 472 830	← 38	1 987 470 040 <sup>7</sup>			
							0 986 474 830		1 987 474 496 <sup>8</sup>			
							0 986 472 831	→ 38	1 987 470 040 <sup>7</sup>			
						0 986 474 831						
						<b>2.5 TDI 4Motion</b>	10.00-01.03	110	245	0 986 473 225	 ← 38,1	1 987 470 040 <sup>7</sup>
										0 986 473 225	 ← 38,1	1 987 474 496 <sup>8</sup>
0 986 474 225	 → 38,1	1 987 470 040 <sup>7</sup>										
				252	0 986 473 185		 ← 43	F 026 A06 121 <sup>7</sup>				
					0 986 473 185		 ← 43	1 987 474 496 <sup>8</sup>				
					0 986 474 185		 → 43	F 026 A06 121 <sup>7</sup>				
	01.03-05.05	132		245	0 986 473 225	 ← 38,1	1 987 470 040 <sup>7</sup>					
					0 986 473 225	 ← 38,1	1 987 474 496 <sup>8</sup>					
					0 986 474 225	 → 38,1	1 987 470 040 <sup>7</sup>					
				252	0 986 473 185	 ← 43	F 026 A06 121 <sup>7</sup>					
					0 986 473 185	 ← 43	1 987 474 496 <sup>8</sup>					
					0 986 474 185	 → 43	F 026 A06 121 <sup>7</sup>					
<b>2.8</b>	10.00-05.05	140/142				0 986 472 830	← 38	1 987 470 040 <sup>7</sup>				
						0 986 474 830		1 987 474 496 <sup>8</sup>				
						0 986 472 831	→ 38	1 987 470 040 <sup>7</sup>				
						0 986 474 831						
						<b>2.8 4Motion</b>	10.00-05.05	140/142	245	0 986 473 225	 ← 38,1	1 987 470 040 <sup>7</sup>
										0 986 473 225	 ← 38,1	1 987 474 496 <sup>8</sup>
0 986 474 225	 → 38,1	1 987 470 040 <sup>7</sup>										
				252	0 986 473 185		 ← 43	F 026 A06 121 <sup>7</sup>				
					0 986 473 185		 ← 43	1 987 474 496 <sup>8</sup>				
					0 986 474 185		 → 43	F 026 A06 121 <sup>7</sup>				
<b>4.0</b>	05.02-09.04	202				0 986 472 830	← 38	1 987 470 040 <sup>7</sup>				
						0 986 474 830		1 987 474 496 <sup>8</sup>				
						0 986 472 831	→ 38	1 987 470 040 <sup>7</sup>				
						0 986 474 831						
						<b>4.0 4Motion</b>	09.01-09.04	202	245	0 986 473 225	 ← 38,1	1 987 470 040 <sup>7</sup>
										0 986 473 225	 ← 38,1	1 987 474 496 <sup>8</sup>
0 986 474 225	 → 38,1	1 987 470 040 <sup>7</sup>										
				252	0 986 473 185		 ← 43	F 026 A06 121 <sup>7</sup>				
					0 986 473 185		 ← 43	1 987 474 496 <sup>8</sup>				
					0 986 474 185		 → 43	F 026 A06 121 <sup>7</sup>				
		1.6	10.00-05.05	75		1 987 477 803	← 1890					
							1 987 477 804	→ 1890				
		1.8	10.00-05.05	110/125		1 987 477 803	← 1890					
						1 987 477 804	→ 1890					



		S							
◀ VW Passat [3B3]									
1.9 TDI		10.00-05.05	74/96				1987 477 803	← 1890	
							1987 477 804	→ 1890	
2.0		10.00-05.05	85/96/100				1987 477 803	← 1890	
2.0 TDI							1987 477 804	→ 1890	
2.3		10.00-05.05	125				1987 477 803	← 1890	
							1987 477 804	→ 1890	
2.5 TDI		10.00-05.05	110/120				1987 477 803	← 1890	
							1987 477 804	→ 1890	
2.8		10.00-05.05	140/142				1987 477 803	← 1890	
							1987 477 804	→ 1890	
4.0		05.02-09.04	202				1987 477 803	← 1890	
							1987 477 804	→ 1890	
1.6		10.00-05.05	75			ALR,LAB	0 265 006 575 <sup>4</sup>		
						ALR,RAB	0 265 006 573 <sup>4</sup>		
						FMS	0 265 006 578 <sup>3</sup>		
						FMS	0 986 594 002 <sup>3</sup>		
1.8		10.00-05.05	110/125			ALR,LAB	0 265 006 575 <sup>4</sup>		
						ALR,RAB	0 265 006 573 <sup>4</sup>		
						FMS	0 265 006 578 <sup>3</sup>		
						FMS	0 986 594 002 <sup>3</sup>		
1.9 TDI		10.00-05.05	74			ALR,LAB	0 265 006 575 <sup>4</sup>		
						ALR,RAB	0 265 006 573 <sup>4</sup>		
						FMS	0 265 006 578 <sup>3</sup>		
						FMS	0 986 594 002 <sup>3</sup>		
			96			ALR,LAB	0 265 006 575 <sup>4</sup>		
						ALR,RAB	0 265 006 573 <sup>4</sup>		
						FMS	0 265 006 578 <sup>3</sup>		
1.9 TDI, TDI 4Motion		10.00-05.05	96			FMS	0 986 594 002 <sup>3</sup>		
1.9 TDI 4Motion		10.00-05.05	96				0 265 006 573 <sup>4</sup>		
						FMS	0 265 006 578 <sup>3</sup>		
2.0		10.00-05.05	85			ALR,LAB	0 265 006 575 <sup>4</sup>		
						ALR,RAB	0 265 006 573 <sup>4</sup>		
						FMS	0 265 006 578 <sup>3</sup>		
2.0		11.01-05.05	96/100			ALR,LAB	0 265 006 575 <sup>4</sup>		
2.0 TDI						ALR,RAB	0 265 006 573 <sup>4</sup>		
						FMS	0 265 006 578 <sup>3</sup>		
						FMS	0 986 594 002 <sup>3</sup>		
2.0, 4Motion		10.00-05.05	85			FMS	0 986 594 002 <sup>3</sup>		
2.0 4Motion		10.00-05.05	85				0 265 006 573 <sup>4</sup>		
						FMS	0 265 006 578 <sup>3</sup>		
2.3		10.00-05.05	125			ALR,LAB	0 265 006 575 <sup>4</sup>		
						ALR,RAB	0 265 006 573 <sup>4</sup>		
						FMS	0 265 006 578 <sup>3</sup>		
2.3, 4Motion		10.00-05.05	125			FMS	0 986 594 002 <sup>3</sup>		
2.3 4Motion		01.01-05.05	125				0 265 006 573 <sup>4</sup>		
						FMS	0 265 006 578 <sup>3</sup>		
2.5 TDI		10.00-05.03	110			ALR,LAB	0 265 006 575 <sup>4</sup>		
						ALR,RAB	0 265 006 573 <sup>4</sup>		
						FMS	0 265 006 578 <sup>3</sup>		
		05.03-05.05	120			ALR,LAB	0 265 006 575 <sup>4</sup>		
						ALR,RAB	0 265 006 573 <sup>4</sup>		
						FMS	0 265 006 578 <sup>3</sup>		
						FMS	0 986 594 002 <sup>3</sup>		
2.5 TDI, TDI 4Motion		10.00-05.03	110			FMS	0 986 594 002 <sup>3</sup>		
2.5 TDI 4Motion		10.00-01.03	110				0 265 006 573 <sup>4</sup>		
						FMS	0 265 006 578 <sup>3</sup>		
		01.03-05.05	132				0 265 006 573 <sup>4</sup>		
						FMS	0 265 006 578 <sup>3</sup>		
						FMS	0 986 594 002 <sup>3</sup>		
2.8		10.00-05.05	140/142			ALR,LAB	0 265 006 575 <sup>4</sup>		
						ALR,RAB	0 265 006 573 <sup>4</sup>		
						FMS	0 265 006 578 <sup>3</sup>		



	<b>S</b>							
2.8, 4Motion	10.00-05.05	140/142		FMS	0 986 594 002 <sup>3</sup>			
2.8 4Motion	10.00-05.05	140/142			0 265 006 573 <sup>4</sup>			
				FMS	0 265 006 578 <sup>3</sup>			
4.0	05.02-09.04	202		ALR,LAB	0 265 006 575 <sup>4</sup>			
				ALR,RAB	0 265 006 573 <sup>4</sup>			
				FMS	0 265 006 578 <sup>3</sup>			
4.0, 4Motion	09.01-09.04	202		FMS	0 986 594 002 <sup>3</sup>			
4.0 4Motion	09.01-09.04	202			0 265 006 573 <sup>4</sup>			
				FMS	0 265 006 578 <sup>3</sup>			









**Passat [3C2]**

	1.4 TSI 1.4 TSI EcoFuel	05.07-07.10	90/110	PR-Code 1LH, PR-Code 1ZG, PR-Code 1ZM	312	0 986 473 384		← 53,94	F 026 A06 106 <sup>7</sup>
						0 986 473 384		← 53,94	1 987 470 506 <sup>8</sup>
						0 986 474 384		→ 53,94	F 026 A06 106 <sup>7</sup>
				PR-Code 1LK	NOR	0 986 134 257		←	F 026 A03 545 <sup>7</sup>
						0 986 134 257		←	1 987 470 506 <sup>8</sup>
						0 986 135 257		→	F 026 A03 545 <sup>7</sup>
				PR-Code 1LM	KZB	0 986 134 257		←	F 026 A03 545 <sup>7</sup>
						0 986 134 257		←	1 987 470 506 <sup>8</sup>
						0 986 135 257		→	F 026 A03 545 <sup>7</sup>
	1.6 1.6 TDI	03.05-07.10	75/77	PR-Code 1LH, PR-Code 1ZG, PR-Code 1ZM	312	0 986 473 384		← 53,94	F 026 A06 106 <sup>7</sup>
						0 986 473 384		← 53,94	1 987 470 506 <sup>8</sup>
						0 986 474 384		→ 53,94	F 026 A06 106 <sup>7</sup>
				PR-Code 1LK	NOR	0 986 134 257		←	F 026 A03 545 <sup>7</sup>
						0 986 134 257		←	1 987 470 506 <sup>8</sup>
						0 986 135 257		→	F 026 A03 545 <sup>7</sup>
				PR-Code 1LM	KZB	0 986 134 257		←	F 026 A03 545 <sup>7</sup>
						0 986 134 257		←	1 987 470 506 <sup>8</sup>
						0 986 135 257		→	F 026 A03 545 <sup>7</sup>
	1.6 FSI	03.05-06.08	85			0 986 473 384		← 53,94	F 026 A06 106 <sup>7</sup>
						0 986 473 384		← 53,94	1 987 470 506 <sup>8</sup>
						0 986 474 384		→ 53,94	F 026 A06 106 <sup>7</sup>
	1.8 TSI	05.08-07.10	118	PR-Code 1LJ, PR-Code 1LH, PR-Code 1ZG, PR-Code 1ZM	312	0 986 473 384		← 53,94	F 026 A06 106 <sup>7</sup>
						0 986 473 384		← 53,94	1 987 470 506 <sup>8</sup>
						0 986 474 384		→ 53,94	F 026 A06 106 <sup>7</sup>
				PR-Code 1LK	NOR	0 986 134 257		←	F 026 A03 545 <sup>7</sup>
						0 986 134 257		←	1 987 470 506 <sup>8</sup>
						0 986 135 257		→	F 026 A03 545 <sup>7</sup>
				PR-Code 1LM	KZB	0 986 134 257		←	F 026 A03 545 <sup>7</sup>
						0 986 134 257		←	1 987 470 506 <sup>8</sup>
						0 986 135 257		→	F 026 A03 545 <sup>7</sup>
		11.08-07.10	112	PR-Code 1LH, PR-Code 1ZG, PR-Code 1ZM	312	0 986 473 384		← 53,94	F 026 A06 106 <sup>7</sup>
						0 986 473 384		← 53,94	1 987 470 506 <sup>8</sup>
						0 986 474 384		→ 53,94	F 026 A06 106 <sup>7</sup>
				PR-Code 1LK	NOR	0 986 134 257		←	F 026 A03 545 <sup>7</sup>
						0 986 134 257		←	1 987 470 506 <sup>8</sup>
						0 986 135 257		→	F 026 A03 545 <sup>7</sup>
				PR-Code 1LM	KZB	0 986 134 257		←	F 026 A03 545 <sup>7</sup>
						0 986 134 257		←	1 987 470 506 <sup>8</sup>
						0 986 135 257		→	F 026 A03 545 <sup>7</sup>
	1.9 TDI	03.05-11.08	77			0 986 473 384		← 53,94	F 026 A06 106 <sup>7</sup>
						0 986 473 384		← 53,94	1 987 470 506 <sup>8</sup>
						0 986 474 384		→ 53,94	F 026 A06 106 <sup>7</sup>
	2.0 FSI	03.05-11.05	110			0 986 473 384		← 53,94	F 026 A06 106 <sup>7</sup>
						0 986 473 384		← 53,94	1 987 470 506 <sup>8</sup>
						0 986 474 384		→ 53,94	F 026 A06 106 <sup>7</sup>
		11.05-07.10	110	PR-Code 1LH, PR-Code 1ZG, PR-Code 1ZM	312	0 986 473 384		← 53,94	F 026 A06 106 <sup>7</sup>
						0 986 473 384		← 53,94	1 987 470 506 <sup>8</sup>
						0 986 474 384		→ 53,94	F 026 A06 106 <sup>7</sup>



<b>◀ VW Passat [3C2]</b>									
<b>2.0 FSI</b>	11.05-07.10	110	PR-Code 1LJ, PR-Code 1LH, PR-Code 1ZG, PR-Code 1ZM	312	0986 <b>473 384</b>		← 53,94	F 026 <b>A06 106</b> <sup>7</sup>	
					0986 <b>473 384</b>		← 53,94	1 987 <b>470 506</b> <sup>8</sup>	
					0986 <b>474 384</b>		→ 53,94	F 026 <b>A06 106</b> <sup>7</sup>	
<b>2.0 FSI</b>	11.05-07.10	110	PR-Code 1LK	NOR	0986 <b>134 257</b>		←	F 026 <b>A03 545</b> <sup>7</sup>	
					<b>2.0 FSI 4Motion</b>	0986 <b>134 257</b>		←	1 987 <b>470 506</b> <sup>8</sup>
			PR-Code 1LM	KZB	0986 <b>134 257</b>		←	F 026 <b>A03 545</b> <sup>7</sup>	
					0986 <b>134 257</b>		←	1 987 <b>470 506</b> <sup>8</sup>	
					0986 <b>135 257</b>		→	F 026 <b>A03 545</b> <sup>7</sup>	
<b>2.0 FSI 4Motion</b>	09.05-11.05	110			0986 <b>473 384</b>		← 53,94	F 026 <b>A06 106</b> <sup>7</sup>	
					0986 <b>473 384</b>		← 53,94	1 987 <b>470 506</b> <sup>8</sup>	
					0986 <b>474 384</b>		→ 53,94	F 026 <b>A06 106</b> <sup>7</sup>	
	11.05-07.10	110	PR-Code 1LH, PR-Code 1ZG, PR-Code 1ZM	312	0986 <b>473 384</b>		← 53,94	F 026 <b>A06 106</b> <sup>7</sup>	
					0986 <b>473 384</b>		← 53,94	1 987 <b>470 506</b> <sup>8</sup>	
					0986 <b>474 384</b>		→ 53,94	F 026 <b>A06 106</b> <sup>7</sup>	
<b>2.0 TDI</b>	03.05-06.08	125			0986 <b>473 384</b>		← 53,94	F 026 <b>A06 106</b> <sup>7</sup>	
					0986 <b>473 384</b>		← 53,94	1 987 <b>470 506</b> <sup>8</sup>	
					0986 <b>474 384</b>		→ 53,94	F 026 <b>A06 106</b> <sup>7</sup>	
	06.05-05.06	88/90			0986 <b>473 384</b>		← 53,94	F 026 <b>A06 106</b> <sup>7</sup>	
					0986 <b>473 384</b>		← 53,94	1 987 <b>470 506</b> <sup>8</sup>	
					0986 <b>474 384</b>		→ 53,94	F 026 <b>A06 106</b> <sup>7</sup>	
	08.05-06.08	120			0986 <b>473 384</b>		← 53,94	F 026 <b>A06 106</b> <sup>7</sup>	
					0986 <b>473 384</b>		← 53,94	1 987 <b>470 506</b> <sup>8</sup>	
					0986 <b>474 384</b>		→ 53,94	F 026 <b>A06 106</b> <sup>7</sup>	
	05.08-07.10	125	PR-Code 1LH, PR-Code 1ZG, PR-Code 1ZM	312	0986 <b>473 384</b>		← 53,94	F 026 <b>A06 106</b> <sup>7</sup>	
					0986 <b>473 384</b>		← 53,94	1 987 <b>470 506</b> <sup>8</sup>	
					0986 <b>474 384</b>		→ 53,94	F 026 <b>A06 106</b> <sup>7</sup>	
	11.08-07.10	81	PR-Code 1LH, PR-Code 1ZG, PR-Code 1ZM	312	0986 <b>473 384</b>		← 53,94	F 026 <b>A06 106</b> <sup>7</sup>	
					0986 <b>473 384</b>		← 53,94	1 987 <b>470 506</b> <sup>8</sup>	
					0986 <b>474 384</b>		→ 53,94	F 026 <b>A06 106</b> <sup>7</sup>	
			PR-Code 1LK	NOR	0986 <b>134 257</b>		←	F 026 <b>A03 545</b> <sup>7</sup>	
					0986 <b>134 257</b>		←	1 987 <b>470 506</b> <sup>8</sup>	
					0986 <b>135 257</b>		→	F 026 <b>A03 545</b> <sup>7</sup>	
			PR-Code 1LM	KZB	0986 <b>134 257</b>		←	F 026 <b>A03 545</b> <sup>7</sup>	
					0986 <b>134 257</b>		←	1 987 <b>470 506</b> <sup>8</sup>	
					0986 <b>135 257</b>		→	F 026 <b>A03 545</b> <sup>7</sup>	
	11.08-11.10	105	PR-Code 1LH, PR-Code 1ZG, PR-Code 1ZM	312	0986 <b>473 384</b>		← 53,94	F 026 <b>A06 106</b> <sup>7</sup>	
					0986 <b>473 384</b>		← 53,94	1 987 <b>470 506</b> <sup>8</sup>	
					0986 <b>474 384</b>		→ 53,94	F 026 <b>A06 106</b> <sup>7</sup>	
			PR-Code 1LK	NOR	0986 <b>134 257</b>		←	F 026 <b>A03 545</b> <sup>7</sup>	
					0986 <b>134 257</b>		←	1 987 <b>470 506</b> <sup>8</sup>	
					0986 <b>135 257</b>		→	F 026 <b>A03 545</b> <sup>7</sup>	
			PR-Code 1LM	KZB	0986 <b>134 257</b>		←	F 026 <b>A03 545</b> <sup>7</sup>	
					0986 <b>134 257</b>		←	1 987 <b>470 506</b> <sup>8</sup>	
					0986 <b>135 257</b>		→	F 026 <b>A03 545</b> <sup>7</sup>	
<b>2.0 TDI</b>	03.05-06.08	100/103			0986 <b>473 384</b>		← 53,94	F 026 <b>A06 106</b> <sup>7</sup>	
					<b>2.0 TDI 4Motion</b>	0986 <b>473 384</b>		← 53,94	1 987 <b>470 506</b> <sup>8</sup>
						0986 <b>474 384</b>		→ 53,94	F 026 <b>A06 106</b> <sup>7</sup>
	05.08-07.10	125	PR-Code 1LK	NOR	0986 <b>135 257</b>		→	1 987 <b>470 506</b> <sup>8</sup>	
					0986 <b>135 257</b>		→	1 987 <b>470 506</b> <sup>8</sup>	
					0986 <b>135 257</b>		→	F 026 <b>A03 545</b> <sup>7</sup>	
	05.08-08.10	100/103	PR-Code 1LH, PR-Code 1ZG, PR-Code 1ZM	312	0986 <b>473 384</b>		← 53,94	F 026 <b>A06 106</b> <sup>7</sup>	
					0986 <b>473 384</b>		← 53,94	1 987 <b>470 506</b> <sup>8</sup>	
					0986 <b>474 384</b>		→ 53,94	F 026 <b>A06 106</b> <sup>7</sup>	
			PR-Code 1LK	NOR	0986 <b>134 257</b>		←	F 026 <b>A03 545</b> <sup>7</sup>	
					0986 <b>134 257</b>		←	1 987 <b>470 506</b> <sup>8</sup>	
					0986 <b>135 257</b>		→	F 026 <b>A03 545</b> <sup>7</sup>	
			PR-Code 1LM	KZB	0986 <b>134 257</b>		←	F 026 <b>A03 545</b> <sup>7</sup>	
					0986 <b>134 257</b>		←	1 987 <b>470 506</b> <sup>8</sup>	
					0986 <b>135 257</b>		→	F 026 <b>A03 545</b> <sup>7</sup>	
<b>2.0 TDI</b>	05.08-07.10	125	PR-Code 1LK	NOR	0986 <b>134 257</b>		←	1 987 <b>470 506</b> <sup>8</sup>	
					<b>2.0 TDI 4Motion</b>	0986 <b>135 257</b>		→	F 026 <b>A03 545</b> <sup>7</sup>
<b>2.0 TSI</b>			PR-Code 1LM	KZB	0986 <b>134 257</b>		←	1 987 <b>470 506</b> <sup>8</sup>	
					0986 <b>135 257</b>		→	F 026 <b>A03 545</b> <sup>7</sup>	



















	<b>S</b>							
<b>2.0 TDI 4Motion</b>	05.09-07.10	125	PR-Code 1LH, PR-Code 1ZG, PR-Code 1ZM	312	0 986 474 384	↔ 53,94	1 987 470 506 <sup>B</sup>	
<b>2.0 TDI 4Motion</b>	05.08-07.10	125	PR-Code 1LH, PR-Code 1ZG, PR-Code 1ZM	312	0 986 473 384	↔ 53,94	F 026 A06 106 <sup>7</sup>	
<b>2.0 TSI</b>					0 986 474 384	↔ 53,94	F 026 A06 106 <sup>7</sup>	
<b>2.0 TSI</b>	03.05-02.08	147	PR-Code 1LK	NOR	0 986 134 257	↔	F 026 A03 545 <sup>7</sup>	
					0 986 134 257	↔	1 987 470 506 <sup>B</sup>	
			PR-Code 1LM	KZB	0 986 135 257	↔	F 026 A03 545 <sup>7</sup>	
					0 986 134 257	↔	F 026 A03 545 <sup>7</sup>	
					0 986 134 257	↔	1 987 470 506 <sup>B</sup>	
					0 986 135 257	↔	F 026 A03 545 <sup>7</sup>	
	11.05-02.08	147	PR-Code 1LJ, PR-Code 1LH, PR-Code 1ZG, PR-Code 1ZM	312	0 986 473 384	↔ 53,94	F 026 A06 106 <sup>7</sup>	
					0 986 473 384	↔ 53,94	1 987 470 506 <sup>B</sup>	
					0 986 474 384	↔ 53,94	F 026 A06 106 <sup>7</sup>	
	05.08-07.10	125	PR-Code 1LH, PR-Code 1ZG, PR-Code 1ZM	312	0 986 473 384	↔ 53,94	1 987 470 506 <sup>B</sup>	
			PR-Code 1LK	NOR	0 986 134 257	↔	F 026 A03 545 <sup>7</sup>	
			PR-Code 1LM	KZB	0 986 134 257	↔	F 026 A03 545 <sup>7</sup>	
		147	PR-Code 1LH, PR-Code 1ZG, PR-Code 1ZM	312	0 986 474 384	↔ 53,94	1 987 470 506 <sup>B</sup>	
			PR-Code 1LJ, PR-Code 1LH, PR-Code 1ZG, PR-Code 1ZM	312	0 986 473 384	↔ 53,94	F 026 A06 106 <sup>7</sup>	
					0 986 473 384	↔ 53,94	1 987 470 506 <sup>B</sup>	
					0 986 474 384	↔ 53,94	F 026 A06 106 <sup>7</sup>	
	05.08-11.10	147	PR-Code 1LH, PR-Code 1ZG, PR-Code 1ZM	312	0 986 473 384	↔ 53,94	F 026 A06 106 <sup>7</sup>	
					0 986 473 384	↔ 53,94	1 987 470 506 <sup>B</sup>	
					0 986 474 384	↔ 53,94	F 026 A06 106 <sup>7</sup>	
			PR-Code 1LK	NOR	0 986 134 257	↔	F 026 A03 545 <sup>7</sup>	
					0 986 134 257	↔	1 987 470 506 <sup>B</sup>	
			PR-Code 1LM	KZB	0 986 135 257	↔	F 026 A03 545 <sup>7</sup>	
					0 986 134 257	↔	F 026 A03 545 <sup>7</sup>	
					0 986 134 257	↔	1 987 470 506 <sup>B</sup>	
					0 986 135 257	↔	F 026 A03 545 <sup>7</sup>	
<b>3.2 FSI 4Motion</b>	09.05-07.10	184	PR-Code 1LJ, PR-Code 1LH, PR-Code 1ZG, PR-Code 1ZM	312	0 986 473 384	↔ 53,94	F 026 A06 106 <sup>7</sup>	
					0 986 473 384	↔ 53,94	1 987 470 506 <sup>B</sup>	
					0 986 474 384	↔ 53,94	F 026 A06 106 <sup>7</sup>	
			PR-Code 1LK	NOR	0 986 134 257	↔	F 026 A03 545 <sup>7</sup>	
					0 986 134 257	↔	1 987 470 506 <sup>B</sup>	
					0 986 135 257	↔	F 026 A03 545 <sup>7</sup>	
			PR-Code 1LM	KZB	0 986 134 257	↔	F 026 A03 545 <sup>7</sup>	
					0 986 134 257	↔	1 987 470 506 <sup>B</sup>	
					0 986 135 257	↔	F 026 A03 545 <sup>7</sup>	
<b>3.6 FSI</b>	09.05-07.10	206	PR-Code 1LH, PR-Code 1ZG, PR-Code 1ZM	312	0 986 473 384	↔ 53,94	F 026 A06 106 <sup>7</sup>	
			PR-Code 1LK	NOR	0 986 135 257	↔	1 987 470 506 <sup>B</sup>	
			PR-Code 1LM	KZB	0 986 135 257	↔	1 987 470 506 <sup>B</sup>	
<b>3.6 FSI R36 4Motion</b>	04.07-07.10	220	PR-Code 1LJ, PR-Code 1LH, PR-Code 1ZG, PR-Code 1ZM	312	0 986 473 384	↔ 53,94	F 026 A06 106 <sup>7</sup>	
					0 986 473 384	↔ 53,94	1 987 470 506 <sup>B</sup>	
					0 986 474 384	↔ 53,94	F 026 A06 106 <sup>7</sup>	
			PR-Code 1LK	NOR	0 986 134 257	↔	F 026 A03 545 <sup>7</sup>	
					0 986 134 257	↔	1 987 470 506 <sup>B</sup>	
					0 986 135 257	↔	F 026 A03 545 <sup>7</sup>	
			PR-Code 1LM	KZB	0 986 134 257	↔	F 026 A03 545 <sup>7</sup>	
					0 986 134 257	↔	1 987 470 506 <sup>B</sup>	
					0 986 135 257	↔	F 026 A03 545 <sup>7</sup>	
<b>3.6 FSI</b>	09.05-07.10	206	PR-Code 1LH, PR-Code 1ZG, PR-Code 1ZM	312	0 986 473 384	↔ 53,94	1 987 470 506 <sup>B</sup>	
<b>3.6 FSI 4Motion</b>			PR-Code 1LK	NOR	0 986 134 257	↔	1 987 470 506 <sup>B</sup>	
					0 986 135 257	↔	F 026 A03 545 <sup>7</sup>	
			PR-Code 1LM	KZB	0 986 134 257	↔	1 987 470 506 <sup>B</sup>	
					0 986 135 257	↔	F 026 A03 545 <sup>7</sup>	
<b>3.6 FSI 4Motion</b>	09.05-07.10	206	PR-Code 1LH, PR-Code 1ZG, PR-Code 1ZM	312	0 986 473 384	↔ 53,94	F 026 A06 106 <sup>7</sup>	
			PR-Code 1LK	NOR	0 986 134 257	↔	F 026 A03 545 <sup>7</sup>	
			PR-Code 1LM	KZB	0 986 134 257	↔	F 026 A03 545 <sup>7</sup>	



◀ VW Passat [3C2]									
	1.4 TSI	05.07-07.10	90/110	PR-Code 2EA	B31,NOR				1987 474 496 <sup>8</sup>
	1.4 TSI EcoFuel			PR-Code 2EL	B31,KZB				1987 474 496 <sup>8</sup>
		06.07-07.10	90/110	PR-Code 1KU					1987 470 040 <sup>7</sup>
									1987 474 496 <sup>8</sup>
1.6		03.05-05.07	75			0986 473 455	38		1987 470 040 <sup>7</sup>
						0986 474 455	38		1987 470 040 <sup>7</sup>
		03.05-07.10	75	PR-Code 2EA	B31,NOR				1987 474 496 <sup>8</sup>
				PR-Code 2EL	B31,KZB				1987 474 496 <sup>8</sup>
		06.07-07.10	75	PR-Code 1KU					1987 470 040 <sup>7</sup>
									1987 474 496 <sup>8</sup>
1.6 FSI		03.05-04.07	85			0986 473 455	38		1987 470 040 <sup>7</sup>
						0986 474 455	38		1987 470 040 <sup>7</sup>
		05.07-06.08	85	Fg.-Nr. →3C..9P060 099, →3C..9E096 939					1987 470 040 <sup>7</sup>
									1987 474 496 <sup>8</sup>
1.6 TDI		08.09-07.10	77	PR-Code 1KU					1987 470 040 <sup>7</sup>
				PR-Code 2EA	B31,NOR				1987 474 496 <sup>8</sup>
				PR-Code 2EL	B31,KZB				1987 474 496 <sup>8</sup>
1.8 TSI		05.08-07.10	112/118	PR-Code 1KU					1987 470 040 <sup>7</sup>
				PR-Code 2EA	B31,NOR				1987 474 496 <sup>8</sup>
				PR-Code 2EL	B31,KZB				1987 474 496 <sup>8</sup>
1.9 TDI		03.05-04.07	77			0986 473 455	38		1987 470 040 <sup>7</sup>
						0986 474 455	38		1987 470 040 <sup>7</sup>
		05.07-11.08	77						1987 470 040 <sup>7</sup>
									1987 474 496 <sup>8</sup>
2.0 FSI		03.05-05.07	110			0986 473 455	38		1987 470 040 <sup>7</sup>
						0986 474 455	38		1987 470 040 <sup>7</sup>
2.0 FSI	2.0 FSI	11.05-07.10	110	PR-Code 2EA	B31,NOR				1987 474 496 <sup>8</sup>
	2.0 FSI 4Motion			PR-Code 2EL	B31,KZB				1987 474 496 <sup>8</sup>
		06.07-07.10	110	PR-Code 1KU					1987 470 040 <sup>7</sup>
									1987 474 496 <sup>8</sup>
2.0 FSI 4Motion		09.05-05.07	110			0986 473 455	38		1987 470 040 <sup>7</sup>
						0986 474 455	38		1987 470 040 <sup>7</sup>
2.0 TDI		03.05-04.07	125			0986 473 455	38		1987 470 040 <sup>7</sup>
						0986 474 455	38		1987 470 040 <sup>7</sup>
		06.05-05.06	88/90			0986 473 455	38		1987 470 040 <sup>7</sup>
						0986 474 455	38		1987 470 040 <sup>7</sup>
		08.05-04.07	120			0986 473 455	38		1987 470 040 <sup>7</sup>
						0986 474 455	38		1987 470 040 <sup>7</sup>
		05.07-06.08	120						1987 470 040 <sup>7</sup>
									1987 474 496 <sup>8</sup>
			125						1987 470 040 <sup>7</sup>
									1987 474 496 <sup>8</sup>
		05.08-07.10	125	PR-Code 1KU					1987 470 040 <sup>7</sup>
				PR-Code 2EA	B31,NOR				1987 474 496 <sup>8</sup>
				PR-Code 2EL	B31,KZB				1987 474 496 <sup>8</sup>
		11.08-07.10	81	PR-Code 1KU					1987 470 040 <sup>7</sup>
				PR-Code 2EA	B31,NOR				1987 474 496 <sup>8</sup>
				PR-Code 2EL	B31,KZB				1987 474 496 <sup>8</sup>
		11.08-11.10	105	PR-Code 1KU					1987 470 040 <sup>7</sup>
				PR-Code 2EA	B31,NOR				1987 474 496 <sup>8</sup>
				PR-Code 2EL	B31,KZB				1987 474 496 <sup>8</sup>
2.0 TDI		03.05-04.07	100/103			0986 473 455	38		1987 470 040 <sup>7</sup>
						0986 474 455	38		1987 470 040 <sup>7</sup>
2.0 TDI 4Motion		05.07-06.08	100/103						1987 470 040 <sup>7</sup>
									1987 474 496 <sup>8</sup>



	<b>S</b>								
<b>2.0 TDI</b> <b>2.0 TDI 4Motion</b>	05.08-08.10	100/103	PR-Code 1KU					1 987 470 040 <sup>7</sup>	
			PR-Code 2EA B31,NOR				1 987 474 496 <sup>8</sup>		
				PR-Code 2EL B31,KZB				1 987 474 496 <sup>8</sup>	
<b>2.0 TDI 4Motion</b> <b>2.0 TSI</b>	05.08-07.10	125	PR-Code 1KU					1 987 470 040 <sup>7</sup>	
			PR-Code 2EA B31,NOR				1 987 474 496 <sup>8</sup>		
				PR-Code 2EL B31,KZB				1 987 474 496 <sup>8</sup>	
<b>2.0 TSI</b>	03.05-04.07	147						1 987 474 496 <sup>8</sup>	
	11.05-05.07	147	PR-Code 1KU		0 986 473 455		38	1 987 470 040 <sup>7</sup>	
					0 986 474 455		38	1 987 470 040 <sup>7</sup>	
	11.05-02.08	147	PR-Code 2EA B31,NOR					1 987 474 496 <sup>8</sup>	
			PR-Code 2EL B31,KZB				1 987 474 496 <sup>8</sup>		
	05.07-12.07	147	PR-Code 2EA NOR					1 987 474 496 <sup>8</sup>	
			PR-Code 2EL KZB				1 987 474 496 <sup>8</sup>		
	06.07-02.08	147	PR-Code 1KU					1 987 470 040 <sup>7</sup>	
								1 987 474 496 <sup>8</sup>	
	05.08-11.10	147	PR-Code 1KU					1 987 470 040 <sup>7</sup>	
			PR-Code 2EA B31,NOR				1 987 474 496 <sup>8</sup>		
PR-Code 2EL B31,KZB					1 987 474 496 <sup>8</sup>				
<b>3.2 FSI 4Motion</b>	09.05-05.07	184	PR-Code 1KU		0 986 473 455		38	1 987 470 040 <sup>7</sup>	
					0 986 474 455		38	1 987 470 040 <sup>7</sup>	
	09.05-07.10	184	PR-Code 2EA B31,NOR					1 987 474 496 <sup>8</sup>	
			PR-Code 2EL B31,KZB				1 987 474 496 <sup>8</sup>		
06.07-07.10	184	PR-Code 1KU					1 987 470 040 <sup>7</sup>		
							1 987 474 496 <sup>8</sup>		
<b>3.6 FSI R36 4Motion</b>	04.07-05.07	220	PR-Code 1KU		0 986 473 455		38	1 987 470 040 <sup>7</sup>	
					0 986 474 455		38	1 987 470 040 <sup>7</sup>	
	04.07-07.10	220	PR-Code 2EA B31,NOR					1 987 474 496 <sup>8</sup>	
			PR-Code 2EL B31,KZB				1 987 474 496 <sup>8</sup>		
06.07-07.10	220	PR-Code 1KU					1 987 470 040 <sup>7</sup>		
							1 987 474 496 <sup>8</sup>		
<b>3.6 FSI</b> <b>3.6 FSI 4Motion</b>	09.05-05.07	206			0 986 473 455		38	1 987 470 040 <sup>7</sup>	
					0 986 474 455		38	1 987 470 040 <sup>7</sup>	
	09.05-07.10	206	PR-Code 2EA B31,NOR					1 987 474 496 <sup>8</sup>	
			PR-Code 2EL B31,KZB				1 987 474 496 <sup>8</sup>		
06.07-07.10	206	PR-Code 1KU					1 987 470 040 <sup>7</sup>		
							1 987 474 496 <sup>8</sup>		
	<b>1.4 TSI</b> <b>1.4 TSI EcoFuel</b>	05.07-07.10	90/110		LAB			0 986 594 504 <sup>3</sup>	
								0 986 594 506 <sup>4</sup>	
					RAB			0 986 594 505 <sup>3</sup>	
								0 986 594 507 <sup>4</sup>	
	<b>1.6</b> <b>1.6 FSI</b> <b>1.6 TDI</b>	03.05-07.10	75/77/85			LAB			0 986 594 504 <sup>3</sup>
									0 986 594 506 <sup>4</sup>
					RAB			0 986 594 505 <sup>3</sup>	
								0 986 594 507 <sup>4</sup>	
	<b>1.8 TSI</b>	05.08-07.10	112/118			LAB			0 986 594 504 <sup>3</sup>
									0 986 594 506 <sup>4</sup>
									0 986 594 505 <sup>3</sup>
				RAB			0 986 594 507 <sup>4</sup>		
<b>1.9 TDI</b>	03.05-11.08	77			LAB			0 986 594 504 <sup>3</sup>	
								0 986 594 506 <sup>4</sup>	
								0 986 594 505 <sup>3</sup>	
				RAB			0 986 594 507 <sup>4</sup>		
<b>2.0 FSI</b>	03.05-07.10	110			LAB			0 986 594 504 <sup>3</sup>	
								0 986 594 506 <sup>4</sup>	
								0 986 594 505 <sup>3</sup>	
				RAB			0 986 594 507 <sup>4</sup>		





		S							
	<b>◀ VW Passat [3C2]</b>								
<b>2.0 FSI 4Motion</b>		09.05-07.10	110			LAB	0 986 594 504		
						RAB	0 986 594 505		
<b>2.0 TDI</b>		03.05-07.10	81/88/90/ 100			LAB	0 986 594 504 <sup>3</sup>		
						RAB	0 986 594 506 <sup>4</sup>		
							0 986 594 505 <sup>3</sup>		
							0 986 594 507 <sup>4</sup>		
			103			LAB	0 986 594 504 <sup>3</sup>		
						RAB	0 986 594 505 <sup>3</sup>		
		08.05-06.08	120			LAB	0 986 594 504 <sup>3</sup>		
							0 986 594 506 <sup>4</sup>		
						RAB	0 986 594 505 <sup>3</sup>		
							0 986 594 507 <sup>4</sup>		
		11.08-11.10	105			LAB	0 986 594 504 <sup>3</sup>		
							0 986 594 506 <sup>4</sup>		
						RAB	0 986 594 505 <sup>3</sup>		
							0 986 594 507 <sup>4</sup>		
<b>2.0 TDI</b>		03.05-07.10	103			LAB	0 986 594 506 <sup>4</sup>		
<b>2.0 TDI 4Motion</b>						RAB	0 986 594 507 <sup>4</sup>		
<b>2.0 TDI</b>		03.05-07.10	125			LAB	0 986 594 504 <sup>3</sup>		
<b>2.0 TSI</b>							0 986 594 506 <sup>4</sup>		
						RAB	0 986 594 505 <sup>3</sup>		
							0 986 594 507 <sup>4</sup>		
<b>2.0 TDI 4Motion</b>		03.05-06.08	103			LAB	0 986 594 504 <sup>3</sup>		
						RAB	0 986 594 505 <sup>3</sup>		
		05.08-08.10	103			LAB	0 986 594 504		
						RAB	0 986 594 505		
		05.09-07.10	125			LAB	0 986 594 504		
						RAB	0 986 594 505		
<b>2.0 TSI</b>		03.05-02.08	147			LAB	0 986 594 504 <sup>3</sup>		
							0 986 594 506 <sup>4</sup>		
						RAB	0 986 594 505 <sup>3</sup>		
							0 986 594 507 <sup>4</sup>		
		05.08-11.10	147			LAB	0 986 594 504 <sup>3</sup>		
							0 986 594 506 <sup>4</sup>		
						RAB	0 986 594 505 <sup>3</sup>		
							0 986 594 507 <sup>4</sup>		
<b>3.2 FSI 4Motion</b>		09.05-07.10	184			LAB	0 986 594 504		
						RAB	0 986 594 505		
<b>3.6 FSI</b>		09.05-07.10	206			LAB	0 986 594 504 <sup>3</sup>		
							0 986 594 506 <sup>4</sup>		
						RAB	0 986 594 505 <sup>3</sup>		
							0 986 594 507 <sup>4</sup>		
<b>3.6 FSI R36 4Motion</b>		04.07-07.10	220			LAB	0 986 594 504		
						RAB	0 986 594 505		
<b>3.6 FSI 4Motion</b>		09.05-07.10	206			LAB	0 986 594 504		
						RAB	0 986 594 505		

**Passat [3G2]**

<b>1.4 GTE Hybrid</b>		05.15→	115			LAB	0 986 594 500 <sup>3</sup>		
						RAB	0 986 594 501 <sup>3</sup>		
<b>1.4 TSI</b>		08.14→	110			RAB	0 986 594 501 <sup>3</sup>		
		11.14→	92			LAB	0 986 594 500 <sup>3</sup>		
						RAB	0 986 594 501 <sup>3</sup>		
<b>1.4 TSI, TSI 4Motion</b>		08.14→	110			LAB	0 986 594 500 <sup>3</sup>		
<b>1.4 TSI 4Motion</b>		02.15→	110			LAB	0 986 594 524 <sup>4</sup>		
						RAB	0 986 594 501 <sup>3</sup>		
							0 986 594 525 <sup>4</sup>		
<b>1.6 TDI</b>		08.14→	88			LAB	0 986 594 500 <sup>3</sup>		
						RAB	0 986 594 501 <sup>3</sup>		
<b>1.8 TFSI</b>		02.15→	132			LAB	0 986 594 500 <sup>3</sup>		
						RAB	0 986 594 501 <sup>3</sup>		

	S							
2.0 TDI	08.14→	110			RAB	0 986 594 501 <sup>3</sup>		
	11.14→	140			RAB	0 986 594 501 <sup>3</sup>		
	05.15→	135			LAB	0 986 594 500 <sup>3</sup>		
					RAB	0 986 594 501 <sup>3</sup>		
2.0 TDI	08.14→	110			LAB	0 986 594 500 <sup>3</sup>		
2.0 TDI 4Motion	11.14→	140			LAB	0 986 594 500 <sup>3</sup>		
2.0 TDI 4Motion	11.14→	140			LAB	0 986 594 524 <sup>4</sup>		
					RAB	0 986 594 501 <sup>3</sup>		
	02.15→	110			LAB	0 986 594 524 <sup>4</sup>		
					RAB	0 986 594 501 <sup>3</sup>		
2.0 TDI 4Motion	08.14→	176/206			LAB	0 986 594 500 <sup>3</sup>		
2.0 TFSI 4Motion						0 986 594 524 <sup>4</sup>		
					RAB	0 986 594 501 <sup>3</sup>		
						0 986 594 525 <sup>4</sup>		
2.0 TFSI	11.14→	162			LAB	0 986 594 500 <sup>3</sup>		
					RAB	0 986 594 501 <sup>3</sup>		

**Passat [312/35I/3A2]**

	1.6	10.94-03.97	74			0 986 471 669	← 54	1 987 470 287 <sup>7</sup>
						0 986 473 669		1 987 474 496 <sup>8</sup>
						0 986 472 669	→ 54	1 987 470 287 <sup>7</sup>
						0 986 474 669		
1.8	08.90-03.97	55/66			0 986 471 669	← 54	1 987 470 287 <sup>7</sup>	
					0 986 473 669		1 987 474 496 <sup>8</sup>	
					0 986 472 669	→ 54	1 987 470 287 <sup>7</sup>	
					0 986 474 669			
1.8 G60	09.89-08.94	118			0 986 473 687	← 54	1 987 470 287 <sup>7</sup>	
					0 986 473 687	← 54	1 987 474 496 <sup>8</sup>	
					0 986 474 687	→ 54	1 987 470 287 <sup>7</sup>	
1.9 TD	03.91-03.97	55		1LY	0 986 471 669	← 54	1 987 470 287 <sup>7</sup>	
					0 986 473 669		1 987 474 496 <sup>8</sup>	
					0 986 472 669	→ 54	1 987 470 287 <sup>7</sup>	
					0 986 474 669			
	256					0 986 471 669	← 54	1 987 470 287 <sup>7</sup>
						0 986 473 669		1 987 474 496 <sup>8</sup>
						0 986 472 669	→ 54	1 987 470 287 <sup>7</sup>
						0 986 474 669		
1.9 TDI	10.93-12.96	66			0 986 471 669	← 54	1 987 470 287 <sup>7</sup>	
					0 986 473 669		1 987 474 496 <sup>8</sup>	
					0 986 472 669	→ 54	1 987 470 287 <sup>7</sup>	
					0 986 474 669			
	03.96-03.97	81		1LY	0 986 471 669	← 54	1 987 470 287 <sup>7</sup>	
					0 986 473 669		1 987 474 496 <sup>8</sup>	
					0 986 472 669	→ 54	1 987 470 287 <sup>7</sup>	
					0 986 474 669			
256					0 986 471 669	← 54	1 987 470 287 <sup>7</sup>	
					0 986 473 669		1 987 474 496 <sup>8</sup>	
					0 986 472 669	→ 54	1 987 470 287 <sup>7</sup>	
					0 986 474 669			
Fg.-Nr. MW..720 001→, MB..180 001→				228	0 986 473 687	← 54	1 987 470 287 <sup>7</sup>	
					0 986 473 687	← 54	1 987 474 496 <sup>8</sup>	
					0 986 474 687	→ 54	1 987 470 287 <sup>7</sup>	
2.0	03.90-09.94	85		256	0 986 471 669	← 54	1 987 470 287 <sup>7</sup>	
					0 986 473 669		1 987 474 496 <sup>8</sup>	
					0 986 472 669	→ 54	1 987 470 287 <sup>7</sup>	
					0 986 474 669			



<b>◀ VW Passat [312/35I/3A2]</b>								
	2.0	03.90-08.97	85	1LY	0986 471 669	← 54	1987 470 287 <sup>7</sup>	
					0986 473 669		1987 474 496 <sup>8</sup>	
					0986 472 669	→ 54	1987 470 287 <sup>7</sup>	
					0986 474 669			
		01.94-03.97	110	1LY	0986 471 669	← 54	1987 470 287 <sup>7</sup>	
					0986 473 669		1987 474 496 <sup>8</sup>	
					0986 472 669	→ 54	1987 470 287 <sup>7</sup>	
					0986 474 669			
		256			0986 471 669	← 54	1987 470 287 <sup>7</sup>	
					0986 473 669		1987 474 496 <sup>8</sup>	
					0986 472 669	→ 54	1987 470 287 <sup>7</sup>	
					0986 474 669			
		288			0986 471 923	← 54	1987 470 506 <sup>8</sup>	
					0986 473 923			
					0986 471 924	→ 54	1987 470 506 <sup>8</sup>	
					0986 473 924			
		09.94-08.97	85		0986 473 687	← 54	1987 470 287 <sup>7</sup>	
					0986 473 687	← 54	1987 474 496 <sup>8</sup>	
					0986 474 687	→ 54	1987 470 287 <sup>7</sup>	
10.94-03.97	79	1LY	0986 471 669	← 54	1987 470 287 <sup>7</sup>			
			0986 473 669		1987 474 496 <sup>8</sup>			
			0986 472 669	→ 54	1987 470 287 <sup>7</sup>			
			0986 474 669					
256			0986 471 669	← 54	1987 470 287 <sup>7</sup>			
			0986 473 669		1987 474 496 <sup>8</sup>			
			0986 472 669	→ 54	1987 470 287 <sup>7</sup>			
			0986 474 669					
85			0986 471 669	← 54	1987 470 287 <sup>7</sup>			
			0986 473 669		1987 474 496 <sup>8</sup>			
			0986 472 669	→ 54	1987 470 287 <sup>7</sup>			
			0986 474 669					
2.0 syncro	10.90-09.94	85	1LY	0986 471 669	← 54	1987 470 287 <sup>7</sup>		
				0986 473 669		1987 474 496 <sup>8</sup>		
				0986 472 669	→ 54	1987 470 287 <sup>7</sup>		
				0986 474 669				
2.8	06.91-03.97	128		0986 471 923	← 54	1987 470 506 <sup>8</sup>		
				0986 473 923				
				0986 471 924	→ 54	1987 470 506 <sup>8</sup>		
				0986 473 924				
	1.6	10.94-03.97	74		0986 475 039	↔ 20,64		
	1.8	08.90-03.97	55/66		0986 475 039	↔ 20,64		
	1.9 TD, TDI	03.91-03.97	55/66		0986 475 039	↔ 20,64		
	1.6	12.95-03.97	74		0986 474 875	← 38		
					0986 474 876	→ 38		
	1.8 G60	09.92-08.94	118	Fg.-Nr. 31-P-080 001→	1LA	0986 474 875	← 38	1987 470 040 <sup>7</sup>
						0986 474 875	← 38	1987 474 496 <sup>8</sup>
						0986 474 876	→ 38	1987 470 040 <sup>7</sup>
						0986 474 875	← 38	
	1.9 TDI	10.93-03.97	66/81			0986 474 876	→ 38	
						0986 474 875	← 38	
	2.0	05.93-09.94	85	Fg.-Nr. 31..P..080 001→		0986 474 875	← 38	
						0986 474 876	→ 38	
	01.94-03.97	110			0986 474 875	← 38		
					0986 474 876	→ 38		
	09.94-08.97	85			0986 474 875	← 38		
					0986 474 876	→ 38		
	10.94-03.97	79			0986 474 875	← 38		
					0986 474 876	→ 38		

	S							
<b>2.0 syncro</b>	09.92-09.94	85	Fg.-Nr. 31-P-080 001→	1LA	0 986 474 875		← 38	1 987 470 040 <sup>7</sup>
					0 986 474 875		← 38	1 987 474 496 <sup>8</sup>
					0 986 474 876		→ 38	1 987 470 040 <sup>7</sup>
<b>2.8</b>	09.92-03.97	128	Fg.-Nr. 31..P..080 001→		0 986 474 875		← 38	
					0 986 474 876		→ 38	
<hr/>								
<b>1.6</b>	10.94-03.97	74			1 987 477 407		↔ 1624	
<b>1.8</b>	09.93-09.94	66			1 987 477 407		↔ 1624	
	09.93-03.97	55			1 987 477 407		↔ 1624	
	10.94-03.97	66			1 987 477 169		↔ 1628	
<b>1.9 TD</b>	09.93-03.97	55			1 987 477 407		↔ 1624	
<b>1.9 TDI</b>	10.93-12.96	66		SBR	1 987 477 406		↔ 1721	
				TBR	1 987 477 407		↔ 1624	
	03.96-03.97	81			1 987 477 406		↔ 1721	
	08.96-12.96	66			1 987 477 406		↔ 1721	
<b>2.0</b>	10.93-08.97	79/85/110			1 987 477 406		↔ 1721	
<b>2.8</b>	10.93-08.94	128	Fg.-Nr. →3A..S..032 001		1 987 477 406		↔ 1721	
<hr/>								
<b>1.6</b>	10.94-03.97	74		LAB	0 986 594 001 <sup>3</sup>			
				RAB	0 986 594 000 <sup>3</sup>			
<b>1.8</b>	10.93-03.97	55/66		LAB	0 986 594 001 <sup>3</sup>			
				RAB	0 986 594 000 <sup>3</sup>			
<b>1.9 TD</b>	10.93-03.97	55/66/81		LAB	0 986 594 001 <sup>3</sup>			
<b>1.9 TDI</b>				RAB	0 986 594 000 <sup>3</sup>			
<b>2.0</b>	10.93-03.97	79/85/110		LAB	0 986 594 001 <sup>3</sup>			
				RAB	0 986 594 000 <sup>3</sup>			
<b>2.8</b>	10.93-03.97	128		LAB	0 986 594 001 <sup>3</sup>			
				RAB	0 986 594 000 <sup>3</sup>			
<hr/>								
<b>Passat [362]</b>								
<hr/>								
<b>1.4 TSI</b>	08.10→	90/110/118	PR-Code 1ZM, PR-Code 1ZG	312	0 986 473 384		← 53,94	F 026 A06 106 <sup>7</sup>
<b>1.4 TSI EcoFuel</b>					0 986 473 384		← 53,94	1 987 470 506 <sup>8</sup>
					0 986 474 384		→ 53,94	F 026 A06 106 <sup>7</sup>
<b>1.6 TDI</b>	08.10→	77	PR-Code 1ZM, PR-Code 1ZG	312	0 986 473 384		← 53,94	F 026 A06 106 <sup>7</sup>
					0 986 473 384		← 53,94	1 987 470 506 <sup>8</sup>
					0 986 474 384		→ 53,94	F 026 A06 106 <sup>7</sup>
<b>1.8 TSI</b>	08.10→	112/118	PR-Code 1ZM, PR-Code 1ZG	312	0 986 473 384		← 53,94	F 026 A06 106 <sup>7</sup>
					0 986 473 384		← 53,94	1 987 470 506 <sup>8</sup>
					0 986 474 384		→ 53,94	F 026 A06 106 <sup>7</sup>
<b>2.0 TDI</b>	08.10→	100/103/125/130/155	PR-Code 1ZM, PR-Code 1ZG	312	0 986 473 384		← 53,94	F 026 A06 106 <sup>7</sup>
<b>2.0 TDI 4Motion</b>					0 986 473 384		← 53,94	1 987 470 506 <sup>8</sup>
<b>2.0 TSI</b>					0 986 474 384		→ 53,94	F 026 A06 106 <sup>7</sup>
<b>3.6 V6 4Motion</b>	01.11→	220	PR-Code 1ZM, PR-Code 1ZG	312	0 986 473 384		← 53,94	F 026 A06 106 <sup>7</sup>
					0 986 473 384		← 53,94	1 987 470 506 <sup>8</sup>
					0 986 474 384		→ 53,94	F 026 A06 106 <sup>7</sup>
<hr/>								
<b>1.4 TSI, TSI EcoFuel</b>	08.10→	90/110/118	PR-Code 2EA	B31				1 987 474 496 <sup>8</sup>
<b>1.6 TDI</b>	08.10→	77	PR-Code 2EA	B31				1 987 474 496 <sup>8</sup>
<b>1.8 TSI</b>	08.10→	112/118	PR-Code 2EA	B31				1 987 474 496 <sup>8</sup>
<b>2.0 TDI</b>	08.10→	100/103/125/130/155	PR-Code 2EA	B31				1 987 474 496 <sup>8</sup>
<b>2.0 TDI 4Motion</b>								
<b>2.0 TSI</b>								
<b>3.6 V6 4Motion</b>	01.11→	220	PR-Code 2EA	B31				1 987 474 496 <sup>8</sup>





◀ VW Passat [362]



	1.4 TSI	08.10→	90/110/	LAB	0986 594 504 <sup>3</sup>
	1.4 TSI EcoFuel		118	RAB	0986 594 561 <sup>4</sup>
					0986 594 505 <sup>3</sup>
					0986 594 560 <sup>4</sup>
	1.6 TDI	08.10→	77	LAB	0986 594 504 <sup>3</sup>
				RAB	0986 594 561 <sup>4</sup>
					0986 594 505 <sup>3</sup>
					0986 594 560 <sup>4</sup>
	1.8 TSI	08.10→	112/118	LAB	0986 594 504 <sup>3</sup>
				RAB	0986 594 561 <sup>4</sup>
					0986 594 505 <sup>3</sup>
					0986 594 560 <sup>4</sup>
	2.0 TDI	08.10→	100	LAB	0986 594 504 <sup>3</sup>
				RAB	0986 594 561 <sup>4</sup>
					0986 594 505 <sup>3</sup>
					0986 594 560 <sup>4</sup>
			103/125/	LAB	0986 594 561 <sup>4</sup>
			130	RAB	0986 594 505 <sup>3</sup>
					0986 594 560 <sup>4</sup>
	2.0 TDI, TDI 4Motion	08.10→	103/125/130	LAB	0986 594 504 <sup>3</sup>
	2.0 TDI 4Motion	08.10→	103/125/	LAB	0986 594 524 <sup>4</sup>
			130	RAB	0986 594 505 <sup>3</sup>
					0986 594 525 <sup>4</sup>
	2.0 TSI	11.10→	155	LAB	0986 594 504 <sup>3</sup>
				RAB	0986 594 561 <sup>4</sup>
					0986 594 505 <sup>3</sup>
					0986 594 560 <sup>4</sup>
	3.6 V6 4Motion	01.11→	220	LAB	0986 594 504 <sup>3</sup>
				RAB	0986 594 524 <sup>4</sup>
					0986 594 505 <sup>3</sup>
					0986 594 525 <sup>4</sup>

Phaeton [3D]







































	3.0 FSI 4Motion	11.11→	165/171/	LAB	0265 007 928 <sup>4</sup>
			176/180/		0265 007 930 <sup>3</sup>
			184	RAB	0265 007 928 <sup>3</sup>
					0265 007 930 <sup>4</sup>
	3.0 TDI 4Motion	09.04→	165/171/	LAB	0265 007 928 <sup>4</sup>
			176/180/		0265 007 930 <sup>3</sup>
			184	RAB	0265 007 928 <sup>3</sup>
					0265 007 930 <sup>4</sup>
	3.2	05.02-05.05	177	LAB	0265 007 928 <sup>4</sup>
					0265 007 930 <sup>3</sup>
				RAB	0265 007 928 <sup>3</sup>
					0265 007 930 <sup>4</sup>
	3.2 4Motion	02.04-10.08	177	LAB	0265 007 928 <sup>4</sup>
					0265 007 930 <sup>3</sup>
				RAB	0265 007 928 <sup>3</sup>
					0265 007 930 <sup>4</sup>
	3.6 4Motion	11.08→	206	LAB	0265 007 928 <sup>4</sup>
					0265 007 930 <sup>3</sup>
				RAB	0265 007 928 <sup>3</sup>
					0265 007 930 <sup>4</sup>
	4.2 4Motion	05.03→	246	LAB	0265 007 928 <sup>4</sup>
					0265 007 930 <sup>3</sup>
				RAB	0265 007 928 <sup>3</sup>
					0265 007 930 <sup>4</sup>

		S							
5.0 TDI 4Motion		11.02-10.06	230			LAB	0 265 007 928 <sup>4</sup>		
						RAB	0 265 007 930 <sup>3</sup>		
							0 265 007 928 <sup>3</sup>		
							0 265 007 930 <sup>4</sup>		
6.0 4Motion		05.02→	309/331			LAB	0 265 007 928 <sup>4</sup>		
						RAB	0 265 007 930 <sup>3</sup>		
							0 265 007 928 <sup>3</sup>		
							0 265 007 930 <sup>4</sup>		
<b>Pointer [55]</b>									
	1.8 i	05.94-12.96	72				0 986 AB8 443	←	
							0 986 AB8 444	→	
<b>Polo</b>									
	1.0 16V	07.02-05.05	43			STB	0 986 475 260	↔ 17,46	
	1.4 16V	09.02-02.05	55			STB	0 986 475 260	↔ 17,46	
	1.6	05.02-07.06	74			STB	0 986 475 260	↔ 17,46	
	1.0 16V	07.02-05.05	43			4SB	0 986 473 099	← 38,1	1 987 470 040 <sup>7</sup>
							0 986 473 099	← 38,1	1 987 474 496 <sup>8</sup>
							0 986 474 099	→ 38,1	1 987 470 040 <sup>7</sup>
	1.4 16V	09.02-02.05	55			4SB	0 986 473 099	← 38,1	1 987 470 040 <sup>7</sup>
							0 986 473 099	← 38,1	1 987 474 496 <sup>8</sup>
							0 986 474 099	→ 38,1	1 987 470 040 <sup>7</sup>
	1.6	05.02-07.06	74			4SB	0 986 473 099	← 38,1	1 987 470 040 <sup>7</sup>
							0 986 473 099	← 38,1	1 987 474 496 <sup>8</sup>
							0 986 474 099	→ 38,1	1 987 470 040 <sup>7</sup>
	1.0 16V	07.02-05.05	43			HTB	1 987 477 806	↔ 1580	
						4SB	1 987 477 807	↔ 1640	
	1.4 16V	09.02-02.05	55			HTB	1 987 477 806	↔ 1580	
						4SB	1 987 477 807	↔ 1640	
	1.6	05.02-07.06	74			HTB	1 987 477 806	↔ 1580	
						4SB	1 987 477 807	↔ 1640	
	1.0 16V	07.02-05.05	43			LAB	0 986 594 500 <sup>3</sup>		
							0 986 594 502 <sup>4</sup>		
						RAB	0 986 594 501 <sup>3</sup>		
							0 986 594 503 <sup>4</sup>		
	1.4 16V	09.02-02.05	55			LAB	0 986 594 500 <sup>3</sup>		
							0 986 594 502 <sup>4</sup>		
						RAB	0 986 594 501 <sup>3</sup>		
							0 986 594 503 <sup>4</sup>		
	1.6	05.02-07.06	74			LAB	0 986 594 500 <sup>3</sup>		
							0 986 594 502 <sup>4</sup>		
						RAB	0 986 594 501 <sup>3</sup>		
							0 986 594 503 <sup>4</sup>		
<b>Polo Classic</b>									
	1.8 Mi	07.96-05.98	73						0 204 104 144 <sup>7</sup>
		01.01-12.03	66						0 204 104 144 <sup>7</sup>
	1.9 SD	05.96-08.08	47			1LM,239			0 204 104 144 <sup>7</sup>



		S																			
	◀ VW Polo Classic																				
	1.9 SD	05.96-08.08	47	PR-Code 1ZE, PR-Code 1ZK	1LY	0986 471 669	← 54	1987 470 287 <sup>7</sup>													
						0986 473 669															
						0986 472 669	→ 54	1987 470 287 <sup>7</sup>													
	1.9 TDI	03.99-08.00	66	PR-Code 1ZE, PR-Code 1ZK	1LY	0986 471 669	← 54	1987 470 287 <sup>7</sup>													
						0986 473 669															
						0986 472 669	→ 54	1987 470 287 <sup>7</sup>													
						0986 474 669															
						09.00-08.08	66	239		0 204 104 144 <sup>7</sup>											
	2.0 Mi	02.01-04.02	85	PR-Code 1ZE, PR-Code 1ZK	1LY	0986 471 669	← 54	1987 470 287 <sup>7</sup>													
						0986 473 669															
						0986 472 669	→ 54	1987 470 287 <sup>7</sup>													
						0986 474 669															
	1.8 Mi	07.96-05.98	73			F 026 009 433	↔ 19,05														
		01.01-12.03	66			F 026 009 433	↔ 19,05														
	1.9 SD	05.96-08.08	47	PR-Code 1KB PR-Code 1KM			0986 BB3 035	↔													
							0986 475 433	↔ 19,05													
	1.9 TDI	03.99-08.00	66	PR-Code 1KB PR-Code 1KM			0986 475 433	↔ 19,05													
							09.00-08.08	66			0986 BB3 035	↔									
	2.0 Mi	02.01-04.02	85				0986 475 433	↔ 19,05													
								F 026 009 433	↔ 19,05												
	1.8 Mi	07.96-05.98	73						1987 477 284	1511											
									1.9 SD	05.96-08.00	47/66			KZS	1987 477 284	↔ 1511					
														RSA	1987 477 695	↔ 1514					
									1.9 TDI	03.99-08.00	47/66			KZS	1987 477 284	↔ 1511					
														RSA	1987 477 695	↔ 1514					
	1.8 Mi	07.96-05.98	73						0986 594 009 <sup>4</sup>												
									1.9 SD	05.96-08.08	47/66			LAB	0986 594 001 <sup>3</sup>						
														RAB	0986 594 000 <sup>3</sup>						
									1.9 TDI						0986 594 009 <sup>4</sup>						
														LAB	0986 594 001 <sup>3</sup>						
						RAB	0986 594 000 <sup>3</sup>														
<b>Polo Classic [6V2]</b>																					
	1.4	05.96-08.99	44						1LA	0 204 102 373	← 48	0 204 104 144 <sup>7</sup>									
										0 204 103 373											
										0 204 102 374	→ 48	0 204 104 144 <sup>7</sup>									
										0 204 103 374											
										1LM,239		0 204 104 144 <sup>7</sup>									
									1LY	0986 471 669	← 54	1987 470 287 <sup>7</sup>									
										0986 473 669		1987 474 496 <sup>8</sup>									
										0986 472 669	→ 54	1987 470 287 <sup>7</sup>									
										0986 474 669											
									10.99-09.01	44								1LA	0 204 102 373	← 48	0 204 104 144 <sup>7</sup>
																			0 204 103 373		
																			0 204 102 374	→ 48	0 204 104 144 <sup>7</sup>
																			0 204 103 374		
	1LM,239		0 204 104 144 <sup>7</sup>																		
1LY	0986 471 669	← 54	1987 470 287 <sup>7</sup>																		
	0986 473 669		1987 474 496 <sup>8</sup>																		
	0986 472 669	→ 54	1987 470 287 <sup>7</sup>																		
	0986 474 669																				

		<b>S</b>							
<b>1.4</b>		10.99-09.01	55	1LA	0 204 102 373	← 48	0 204 104 144 <sup>7</sup>		
					0 204 103 373				
					0 204 102 374	→ 48	0 204 104 144 <sup>7</sup>		
					0 204 103 374				
					1LM,239		0 204 104 144 <sup>7</sup>		
					1LY	0 986 471 669	← 54	1 987 470 287 <sup>7</sup>	
					0 986 473 669		1 987 474 496 <sup>B</sup>		
					0 986 472 669	→ 54	1 987 470 287 <sup>7</sup>		
0 986 474 669									
<b>1.6</b>		11.95-09.01	55/74	1LA	0 204 102 373	← 48	0 204 104 144 <sup>7</sup>		
					0 204 103 373				
					0 204 102 374	→ 48	0 204 104 144 <sup>7</sup>		
					0 204 103 374				
					1LM,239		0 204 104 144 <sup>7</sup>		
					1LY	0 986 471 669	← 54	1 987 470 287 <sup>7</sup>	
					0 986 473 669		1 987 474 496 <sup>B</sup>		
					0 986 472 669	→ 54	1 987 470 287 <sup>7</sup>		
0 986 474 669									
<b>1.7SDI</b>		11.97-08.99	44	1LA	0 204 102 373	← 48	0 204 104 144 <sup>7</sup>		
					0 204 103 373				
					0 204 102 374	→ 48	0 204 104 144 <sup>7</sup>		
					0 204 103 374				
					1LM,239		0 204 104 144 <sup>7</sup>		
					1LY	0 986 471 669	← 54	1 987 470 287 <sup>7</sup>	
					0 986 473 669		1 987 474 496 <sup>B</sup>		
					0 986 472 669	→ 54	1 987 470 287 <sup>7</sup>		
0 986 474 669									
<b>1.8</b>		03.98-09.01	66	1LA	0 204 102 373	← 48	0 204 104 144 <sup>7</sup>		
					0 204 103 373				
					0 204 102 374	→ 48	0 204 104 144 <sup>7</sup>		
					0 204 103 374				
					1LM,239		0 204 104 144 <sup>7</sup>		
					1LY	0 986 471 669	← 54	1 987 470 287 <sup>7</sup>	
					0 986 473 669		1 987 474 496 <sup>B</sup>		
					0 986 472 669	→ 54	1 987 470 287 <sup>7</sup>		
0 986 474 669									
<b>1.9D</b>		01.96-04.96	47	1LY	0 986 471 669	← 54	1 987 474 496 <sup>B</sup>		
					0 986 473 669				
					0 986 472 669	→ 54	1 987 474 496 <sup>B</sup>		
					0 986 474 669				
<b>1.9D</b> <b>1.9SDI</b>		12.95-08.99	47	1LA	0 204 102 373	← 48	0 204 104 144 <sup>7</sup>		
					0 204 103 373				
					0 204 102 374	→ 48	0 204 104 144 <sup>7</sup>		
					0 204 103 374				
					1LM,239		0 204 104 144 <sup>7</sup>		
					1LY	0 986 471 669	← 54	1 987 470 287 <sup>7</sup>	
					0 986 473 669				
					0 986 472 669	→ 54	1 987 470 287 <sup>7</sup>		
0 986 474 669									
<b>1.9SDI</b>		12.95-08.99	47	1LY	0 986 471 669	← 54	1 987 474 496 <sup>B</sup>		
					0 986 473 669				
					0 986 472 669	→ 54	1 987 470 287 <sup>7</sup>		
					0 986 474 669				
		10.99-09.01	50	1LA	0 204 102 373	← 48	0 204 104 144 <sup>7</sup>		
					0 204 103 373				
					0 204 102 374	→ 48	0 204 104 144 <sup>7</sup>		
					0 204 103 374				
1LM,239		0 204 104 144 <sup>7</sup>							
1LY	0 986 471 669	← 54	1 987 470 287 <sup>7</sup>						
0 986 473 669		1 987 474 496 <sup>B</sup>							
0 986 472 669	→ 54	1 987 470 287 <sup>7</sup>							
0 986 474 669									













		S							
	◀ VW Polo Classic [6V2]								
	1.9 TDI	07.96-08.99	66	1LA	0 204 102 373	← 48	0 204 104 144 <sup>7</sup>		
					0 204 103 373				
					0 204 102 374	→ 48	0 204 104 144 <sup>7</sup>		
					0 204 103 374				
		1LM,239					0 204 104 144 <sup>7</sup>		
	1LY	0 986 471 669	← 54	1 987 470 287 <sup>7</sup>					
		0 986 473 669		1 987 474 496 <sup>8</sup>					
		0 986 472 669	→ 54	1 987 470 287 <sup>7</sup>					
		0 986 474 669							
		11.97-08.99	66	1LY	0 986 472 669	→ 54	1 987 474 496 <sup>8</sup>		
					0 986 474 669				
		08.98-08.99	81	1LA	0 204 102 373	← 48	0 204 104 144 <sup>7</sup>		
0 204 103 373									
0 204 102 374					→ 48	0 204 104 144 <sup>7</sup>			
0 204 103 374									
		1LM,239					0 204 104 144 <sup>7</sup>		
1LY		0 986 471 669	← 54	1 987 470 287 <sup>7</sup>					
		0 986 473 669		1 987 474 496 <sup>8</sup>					
		0 986 472 669	→ 54	1 987 470 287 <sup>7</sup>					
		0 986 474 669							
		10.99-09.01	66	1LA	0 204 102 373	← 48	0 204 104 144 <sup>7</sup>		
					0 204 103 373				
					0 204 102 374	→ 48	0 204 104 144 <sup>7</sup>		
				0 204 103 374					
				1LM,239		0 204 104 144 <sup>7</sup>			
1LY	0 986 471 669	← 54	1 987 470 287 <sup>7</sup>						
	0 986 473 669		1 987 474 496 <sup>8</sup>						
	0 986 472 669	→ 54	1 987 470 287 <sup>7</sup>						
	0 986 474 669								
		81	1LA	0 204 102 373	← 48	0 204 104 144 <sup>7</sup>			
				0 204 103 373					
				0 204 102 374	→ 48	0 204 104 144 <sup>7</sup>			
				0 204 103 374					
				1LM,239		0 204 104 144 <sup>7</sup>			
1LY	0 986 471 669	← 54	1 987 470 287 <sup>7</sup>						
	0 986 473 669		1 987 474 496 <sup>8</sup>						
	0 986 472 669	→ 54	1 987 470 287 <sup>7</sup>						
	0 986 474 669								
2.0	08.99-09.01	85	1LA	0 204 102 373	← 48	0 204 104 144 <sup>7</sup>			
				0 204 103 373					
				0 204 102 374	→ 48	0 204 104 144 <sup>7</sup>			
				0 204 103 374					
	1LM,239					0 204 104 144 <sup>7</sup>			
1LY	0 986 471 669	← 54	1 987 470 287 <sup>7</sup>						
	0 986 473 669		1 987 474 496 <sup>8</sup>						
	0 986 472 669	→ 54	1 987 470 287 <sup>7</sup>						
	0 986 474 669								
	1.4	05.96-08.99	44	0 986 475 260	↔ 17,46				
				0 986 475 433	↔ 19,05				
				10.99-09.01	44	0 986 475 260	↔ 17,46		
						0 986 475 433	↔ 19,05		
			55	0 986 475 260	↔ 17,46				
				0 986 475 433	↔ 19,05				
	1.6	11.95-09.01	55/74	0 986 475 260	↔ 17,46				
				0 986 475 433	↔ 19,05				
	1.7 SDI	11.97-08.99	44	0 986 475 260	↔ 17,46				
				0 986 475 433	↔ 19,05				
	1.8	03.98-09.01	66	0 986 475 260	↔ 17,46				
				0 986 475 433	↔ 19,05				

		S							
<b>1.9 D</b>		12.95-08.99	47				0 986 475 260	↔ 17,46	
<b>1.9 SDI</b>							0 986 475 433	↔ 19,05	
<b>1.9 SDI</b>		10.99-09.01	50				0 986 475 260	↔ 17,46	
							0 986 475 433	↔ 19,05	
<b>1.9 TDI</b>		07.96-08.99	66				0 986 475 260	↔ 17,46	
							0 986 475 433	↔ 19,05	
		08.98-08.99	81				0 986 475 260	↔ 17,46	
							0 986 475 433	↔ 19,05	
		10.99-09.01	66				0 986 475 260	↔ 17,46	
							0 986 475 433	↔ 19,05	
			81				0 986 475 260	↔ 17,46	
							0 986 475 433	↔ 19,05	
<b>2.0</b>		08.99-09.01	85				0 986 475 260	↔ 17,46	
							0 986 475 433	↔ 19,05	
<b>1.4</b>		05.96-08.99	44		232,B34		0 986 473 352	↔ 33,9	1 987 474 496 <sup>B</sup>
							0 986 474 352	↔ 33,9	1 987 474 496 <sup>B</sup>
					232,B38		0 986 473 072	↔ 38	1 987 470 040 <sup>7</sup>
							0 986 473 072	↔ 38	1 987 474 496 <sup>B</sup>
							0 986 474 072	↔ 38	1 987 470 040 <sup>7</sup>
		10.99-09.01	44		232,B34		0 986 473 352	↔ 33,9	1 987 474 496 <sup>B</sup>
							0 986 474 352	↔ 33,9	1 987 474 496 <sup>B</sup>
					232,B38		0 986 473 072	↔ 38	1 987 470 040 <sup>7</sup>
							0 986 473 072	↔ 38	1 987 474 496 <sup>B</sup>
							0 986 474 072	↔ 38	1 987 470 040 <sup>7</sup>
			55		232,B34		0 986 473 352	↔ 33,9	1 987 474 496 <sup>B</sup>
							0 986 474 352	↔ 33,9	1 987 474 496 <sup>B</sup>
					232,B38		0 986 473 072	↔ 38	1 987 470 040 <sup>7</sup>
							0 986 473 072	↔ 38	1 987 474 496 <sup>B</sup>
							0 986 474 072	↔ 38	1 987 470 040 <sup>7</sup>
	ABO	05.96-08.99	44		226		0 986 473 150	↔ 38,1	1 987 470 040 <sup>7</sup>
							0 986 473 150	↔ 38,1	1 987 474 496 <sup>B</sup>
							0 986 474 150	↔ 38,1	1 987 470 040 <sup>7</sup>
		10.99-09.01	44		226		0 986 473 150	↔ 38,1	1 987 470 040 <sup>7</sup>
							0 986 473 150	↔ 38,1	1 987 474 496 <sup>B</sup>
							0 986 474 150	↔ 38,1	1 987 470 040 <sup>7</sup>
			55		226		0 986 473 150	↔ 38,1	1 987 470 040 <sup>7</sup>
							0 986 473 150	↔ 38,1	1 987 474 496 <sup>B</sup>
							0 986 474 150	↔ 38,1	1 987 470 040 <sup>7</sup>
	ABS	05.96-08.99	44		226		0 986 473 150	↔ 38,1	1 987 470 040 <sup>7</sup>
							0 986 473 150	↔ 38,1	1 987 474 496 <sup>B</sup>
							0 986 474 150	↔ 38,1	1 987 470 040 <sup>7</sup>
		10.99-09.01	44		226		0 986 473 150	↔ 38,1	1 987 470 040 <sup>7</sup>
							0 986 473 150	↔ 38,1	1 987 474 496 <sup>B</sup>
							0 986 474 150	↔ 38,1	1 987 470 040 <sup>7</sup>
			55		226		0 986 473 150	↔ 38,1	1 987 470 040 <sup>7</sup>
							0 986 473 150	↔ 38,1	1 987 474 496 <sup>B</sup>
							0 986 474 150	↔ 38,1	1 987 470 040 <sup>7</sup>
<b>1.6</b>		11.95-09.01	55/74		232,B34		0 986 473 352	↔ 33,9	1 987 474 496 <sup>B</sup>
							0 986 474 352	↔ 33,9	1 987 474 496 <sup>B</sup>
					232,B38		0 986 473 072	↔ 38	1 987 470 040 <sup>7</sup>
							0 986 473 072	↔ 38	1 987 474 496 <sup>B</sup>
							0 986 474 072	↔ 38	1 987 470 040 <sup>7</sup>
	ABO	11.95-09.01	55		226		0 986 473 150	↔ 38,1	1 987 470 040 <sup>7</sup>
							0 986 473 150	↔ 38,1	1 987 474 496 <sup>B</sup>
							0 986 474 150	↔ 38,1	1 987 470 040 <sup>7</sup>
		12.95-08.99	74		226		0 986 473 150	↔ 38,1	1 987 470 040 <sup>7</sup>
							0 986 473 150	↔ 38,1	1 987 474 496 <sup>B</sup>
							0 986 474 150	↔ 38,1	1 987 470 040 <sup>7</sup>
		10.99-09.01	74		226		0 986 473 150	↔ 38,1	1 987 470 040 <sup>7</sup>
							0 986 473 150	↔ 38,1	1 987 474 496 <sup>B</sup>
							0 986 474 150	↔ 38,1	1 987 470 040 <sup>7</sup>



		S							
◀ VW Polo Classic [6V2]									
1.6	ABS	11.95-09.01	55	226	0986 473 150		← 38,1	1987 470 040 <sup>7</sup>	
					0986 473 150		← 38,1	1987 474 496 <sup>8</sup>	
					0986 474 150		→ 38,1	1987 470 040 <sup>7</sup>	
		12.95-08.99	74	226	0986 473 150		← 38,1	1987 470 040 <sup>7</sup>	
					0986 473 150		← 38,1	1987 474 496 <sup>8</sup>	
					0986 474 150		→ 38,1	1987 470 040 <sup>7</sup>	
		10.99-09.01	74	226	0986 473 150		← 38,1	1987 470 040 <sup>7</sup>	
					0986 473 150		← 38,1	1987 474 496 <sup>8</sup>	
					0986 474 150		→ 38,1	1987 470 040 <sup>7</sup>	
1.7 SDI		11.97-08.99	44	232,B34	0986 473 352		← 33,9	1987 474 496 <sup>8</sup>	
					0986 474 352		→ 33,9	1987 474 496 <sup>8</sup>	
					0986 473 072		← 38	1987 470 040 <sup>7</sup>	
					232,B38	0986 473 072		← 38	1987 474 496 <sup>8</sup>
						0986 473 072		← 38	1987 470 040 <sup>7</sup>
						0986 474 072		→ 38	1987 470 040 <sup>7</sup>
	ABO	11.97-08.99	44	226	0986 473 150		← 38,1	1987 470 040 <sup>7</sup>	
					0986 473 150		← 38,1	1987 474 496 <sup>8</sup>	
					0986 474 150		→ 38,1	1987 470 040 <sup>7</sup>	
ABS	11.97-08.99	44	226	0986 473 150		← 38,1	1987 470 040 <sup>7</sup>		
				0986 473 150		← 38,1	1987 474 496 <sup>8</sup>		
				0986 474 150		→ 38,1	1987 470 040 <sup>7</sup>		
1.8		03.98-09.01	66	232,B34	0986 473 352		← 33,9	1987 474 496 <sup>8</sup>	
					0986 474 352		→ 33,9	1987 474 496 <sup>8</sup>	
					0986 473 072		← 38	1987 470 040 <sup>7</sup>	
					232,B38	0986 473 072		← 38	1987 474 496 <sup>8</sup>
						0986 473 072		← 38	1987 470 040 <sup>7</sup>
						0986 474 072		→ 38	1987 470 040 <sup>7</sup>
	ABO	03.98-09.01	66	226	0986 473 150		← 38,1	1987 470 040 <sup>7</sup>	
					0986 473 150		← 38,1	1987 474 496 <sup>8</sup>	
					0986 474 150		→ 38,1	1987 470 040 <sup>7</sup>	
ABS	03.98-09.01	66	226	0986 473 150		← 38,1	1987 470 040 <sup>7</sup>		
				0986 473 150		← 38,1	1987 474 496 <sup>8</sup>		
				0986 474 150		→ 38,1	1987 470 040 <sup>7</sup>		
1.9 D	ABO	01.96-04.96	47	226	0986 473 150		← 38,1	1987 470 040 <sup>7</sup>	
					0986 473 150		← 38,1	1987 474 496 <sup>8</sup>	
					0986 474 150		→ 38,1	1987 470 040 <sup>7</sup>	
ABS	01.96-04.96	47	226	0986 473 150		← 38,1	1987 470 040 <sup>7</sup>		
				0986 473 150		← 38,1	1987 474 496 <sup>8</sup>		
				0986 474 150		→ 38,1	1987 470 040 <sup>7</sup>		
1.9 D		12.95-08.99	47	232,B34	0986 473 352		← 33,9	1987 474 496 <sup>8</sup>	
					0986 474 352		→ 33,9	1987 474 496 <sup>8</sup>	
					0986 473 072		← 38	1987 470 040 <sup>7</sup>	
1.9 SDI				232,B38	0986 473 072		← 38	1987 474 496 <sup>8</sup>	
					0986 473 072		← 38	1987 474 496 <sup>8</sup>	
					0986 474 072		→ 38	1987 470 040 <sup>7</sup>	
1.9 SDI		10.99-09.01	50	232,B34	0986 473 352		← 33,9	1987 474 496 <sup>8</sup>	
					0986 474 352		→ 33,9	1987 474 496 <sup>8</sup>	
					0986 473 072		← 38	1987 470 040 <sup>7</sup>	
					232,B38	0986 473 072		← 38	1987 474 496 <sup>8</sup>
						0986 473 072		← 38	1987 474 496 <sup>8</sup>
						0986 474 072		→ 38	1987 470 040 <sup>7</sup>
	ABO	12.95-08.99	47	226	0986 473 150		← 38,1	1987 470 040 <sup>7</sup>	
					0986 473 150		← 38,1	1987 474 496 <sup>8</sup>	
					0986 474 150		→ 38,1	1987 470 040 <sup>7</sup>	
	10.99-09.01	50	226	0986 473 150		← 38,1	1987 470 040 <sup>7</sup>		
				0986 473 150		← 38,1	1987 474 496 <sup>8</sup>		
				0986 474 150		→ 38,1	1987 470 040 <sup>7</sup>		
ABS	12.95-08.99	47	226	0986 473 150		← 38,1	1987 470 040 <sup>7</sup>		
				0986 473 150		← 38,1	1987 474 496 <sup>8</sup>		
				0986 474 150		→ 38,1	1987 470 040 <sup>7</sup>		
	10.99-09.01	50	226	0986 473 150		← 38,1	1987 470 040 <sup>7</sup>		
				0986 473 150		← 38,1	1987 474 496 <sup>8</sup>		
				0986 474 150		→ 38,1	1987 470 040 <sup>7</sup>		
1.9 TDI	07.96-08.99	66	232,B34	0986 473 352		← 33,9	1987 474 496 <sup>8</sup>		
				0986 474 352		→ 33,9	1987 474 496 <sup>8</sup>		



		S										
<b>1.9 TDI</b>	07.96-08.99	66			232,B38		0 986 473 072	← 38	1 987 470 040 <sup>7</sup>			
							0 986 473 072	← 38	1 987 474 496 <sup>B</sup>			
							0 986 474 072	→ 38	1 987 470 040 <sup>7</sup>			
							0 986 473 352	← 33,9	1 987 474 496 <sup>B</sup>			
							0 986 474 352	→ 33,9	1 987 474 496 <sup>B</sup>			
							0 986 473 072	← 38	1 987 470 040 <sup>7</sup>			
	08.98-08.99	81			232,B34		0 986 473 352	← 33,9	1 987 474 496 <sup>B</sup>			
							0 986 474 352	→ 33,9	1 987 474 496 <sup>B</sup>			
							0 986 473 072	← 38	1 987 470 040 <sup>7</sup>			
							0 986 473 072	← 38	1 987 474 496 <sup>B</sup>			
							0 986 474 072	→ 38	1 987 470 040 <sup>7</sup>			
							0 986 473 072	← 38	1 987 474 496 <sup>B</sup>			
	10.99-09.01	66			232,B34		0 986 473 352	← 33,9	1 987 474 496 <sup>B</sup>			
							0 986 474 352	→ 33,9	1 987 474 496 <sup>B</sup>			
							0 986 473 072	← 38	1 987 470 040 <sup>7</sup>			
							0 986 473 072	← 38	1 987 474 496 <sup>B</sup>			
							0 986 474 072	→ 38	1 987 470 040 <sup>7</sup>			
							0 986 473 072	← 38	1 987 474 496 <sup>B</sup>			
		81			232,B34		0 986 473 352	← 33,9	1 987 474 496 <sup>B</sup>			
							0 986 474 352	→ 33,9	1 987 474 496 <sup>B</sup>			
							0 986 473 072	← 38	1 987 470 040 <sup>7</sup>			
							0 986 473 072	← 38	1 987 474 496 <sup>B</sup>			
							0 986 474 072	→ 38	1 987 470 040 <sup>7</sup>			
							0 986 473 072	← 38	1 987 474 496 <sup>B</sup>			
ABO	07.96-08.99	66		226		0 986 473 150	← 38,1	1 987 470 040 <sup>7</sup>				
						0 986 473 150	← 38,1	1 987 474 496 <sup>B</sup>				
						0 986 474 150	→ 38,1	1 987 470 040 <sup>7</sup>				
						0 986 473 150	← 38,1	1 987 470 040 <sup>7</sup>				
						0 986 473 150	← 38,1	1 987 474 496 <sup>B</sup>				
						0 986 474 150	→ 38,1	1 987 470 040 <sup>7</sup>				
	08.98-08.99	81		226		0 986 473 150	← 38,1	1 987 470 040 <sup>7</sup>				
						0 986 473 150	← 38,1	1 987 474 496 <sup>B</sup>				
						0 986 474 150	→ 38,1	1 987 470 040 <sup>7</sup>				
						0 986 473 150	← 38,1	1 987 470 040 <sup>7</sup>				
						0 986 473 150	← 38,1	1 987 474 496 <sup>B</sup>				
						0 986 474 150	→ 38,1	1 987 470 040 <sup>7</sup>				
	10.99-09.01	66		226		0 986 473 150	← 38,1	1 987 470 040 <sup>7</sup>				
						0 986 473 150	← 38,1	1 987 474 496 <sup>B</sup>				
						0 986 474 150	→ 38,1	1 987 470 040 <sup>7</sup>				
						0 986 473 150	← 38,1	1 987 470 040 <sup>7</sup>				
						0 986 473 150	← 38,1	1 987 474 496 <sup>B</sup>				
						0 986 474 150	→ 38,1	1 987 470 040 <sup>7</sup>				
	81			226		0 986 473 150	← 38,1	1 987 470 040 <sup>7</sup>				
						0 986 473 150	← 38,1	1 987 474 496 <sup>B</sup>				
						0 986 474 150	→ 38,1	1 987 470 040 <sup>7</sup>				
						0 986 473 150	← 38,1	1 987 470 040 <sup>7</sup>				
						0 986 473 150	← 38,1	1 987 474 496 <sup>B</sup>				
						0 986 474 150	→ 38,1	1 987 470 040 <sup>7</sup>				
ABS	07.96-08.99	66		226		0 986 473 150	← 38,1	1 987 470 040 <sup>7</sup>				
						0 986 473 150	← 38,1	1 987 474 496 <sup>B</sup>				
						0 986 474 150	→ 38,1	1 987 470 040 <sup>7</sup>				
						0 986 473 150	← 38,1	1 987 470 040 <sup>7</sup>				
						0 986 473 150	← 38,1	1 987 474 496 <sup>B</sup>				
						0 986 474 150	→ 38,1	1 987 470 040 <sup>7</sup>				
	08.98-08.99	81		226		0 986 473 150	← 38,1	1 987 470 040 <sup>7</sup>				
						0 986 473 150	← 38,1	1 987 474 496 <sup>B</sup>				
						0 986 474 150	→ 38,1	1 987 470 040 <sup>7</sup>				
						0 986 473 150	← 38,1	1 987 470 040 <sup>7</sup>				
						0 986 473 150	← 38,1	1 987 474 496 <sup>B</sup>				
						0 986 474 150	→ 38,1	1 987 470 040 <sup>7</sup>				
	10.99-09.01	66		226		0 986 473 150	← 38,1	1 987 470 040 <sup>7</sup>				
						0 986 473 150	← 38,1	1 987 474 496 <sup>B</sup>				
						0 986 474 150	→ 38,1	1 987 470 040 <sup>7</sup>				
						0 986 473 150	← 38,1	1 987 470 040 <sup>7</sup>				
						0 986 473 150	← 38,1	1 987 474 496 <sup>B</sup>				
						0 986 474 150	→ 38,1	1 987 470 040 <sup>7</sup>				
	81			226		0 986 473 150	← 38,1	1 987 470 040 <sup>7</sup>				
						0 986 473 150	← 38,1	1 987 474 496 <sup>B</sup>				
						0 986 474 150	→ 38,1	1 987 470 040 <sup>7</sup>				
						0 986 473 150	← 38,1	1 987 470 040 <sup>7</sup>				
						0 986 473 150	← 38,1	1 987 474 496 <sup>B</sup>				
						0 986 474 150	→ 38,1	1 987 470 040 <sup>7</sup>				
<b>2.0</b>	08.99-09.01	85			232,B34		0 986 473 352	← 33,9	1 987 474 496 <sup>B</sup>			
							0 986 474 352	→ 33,9	1 987 474 496 <sup>B</sup>			
							0 986 473 072	← 38	1 987 470 040 <sup>7</sup>			
							0 986 473 072	← 38	1 987 474 496 <sup>B</sup>			
							0 986 474 072	→ 38	1 987 470 040 <sup>7</sup>			
							0 986 473 072	← 38	1 987 474 496 <sup>B</sup>			
	ABO	08.99-09.01	85			226		0 986 473 150	← 38,1	1 987 470 040 <sup>7</sup>		
								0 986 473 150	← 38,1	1 987 474 496 <sup>B</sup>		
								0 986 474 150	→ 38,1	1 987 470 040 <sup>7</sup>		
								0 986 473 150	← 38,1	1 987 470 040 <sup>7</sup>		
								0 986 473 150	← 38,1	1 987 474 496 <sup>B</sup>		
								0 986 474 150	→ 38,1	1 987 470 040 <sup>7</sup>		
ABS	08.99-09.01	85			226		0 986 473 150	← 38,1	1 987 470 040 <sup>7</sup>			
							0 986 473 150	← 38,1	1 987 474 496 <sup>B</sup>			
							0 986 474 150	→ 38,1	1 987 470 040 <sup>7</sup>			
							0 986 473 150	← 38,1	1 987 470 040 <sup>7</sup>			
							0 986 473 150	← 38,1	1 987 474 496 <sup>B</sup>			
							0 986 474 150	→ 38,1	1 987 470 040 <sup>7</sup>			
<b>1.4</b>		05.96-12.97	44		TBR		1 987 477 284	1511				
							05.96-08.99	44	SBR	1 987 477 627	1641	
							12.97-08.99	44	Fg.-Nr. →6K..W..591 018	TBR	1 987 477 284	1511
							10.99-09.01	44		226,232	1 987 477 627	1641
								55		226,232	1 987 477 627	1641
							ABO	04.98-08.99	44	Fg.-Nr. 6K..W..591 019→	TBR	1 987 477 679
		10.99-09.01	44		TBR	1 987 477 679	1512					





 ◀ VW Polo Classic [6V2]

<b>1.4</b>	ABO	10.99-09.01	55		TBR	1987 477 679	1512	
	ABS	04.98-08.99	44	Fg.-Nr. 6K..W..591 019→	TBR	1987 477 695	↔ 1514	
		10.99-09.01	44		TBR	1987 477 695	↔ 1514	
			55		TBR	1987 477 695	↔ 1514	
<b>1.6</b>		11.95-09.97	55		TBR	1987 477 284	1511	
		11.95-12.98	55		SBR	1987 477 627	1641	
		12.95-03.98	74	Fg.-Nr. →6K..W..591 018	TBR	1987 477 284	1511	
		12.95-08.99	74		SBR	1987 477 627	1641	
		04.97-03.98	55	Fg.-Nr. →6K..W..591 018	TBR	1987 477 284	1511	
		07.98-09.01	55		226,232	1987 477 627	1641	
		10.99-09.01	74		226,232	1987 477 627	1641	
		ABO	04.98-08.99	55/74	Fg.-Nr. 6K..W..591 019→	TBR	1987 477 679	1512
			07.98-09.01	55/74		TBR	1987 477 679	1512
		ABS	04.98-08.99	55/74	Fg.-Nr. 6K..W..591 019→	TBR	1987 477 695	↔ 1514
	07.98-09.01		55/74		TBR	1987 477 695	↔ 1514	
<b>1.7 SDI</b>		11.97-08.99	44		SBR	1987 477 627	1641	
				Fg.-Nr. →6K..W..591 018	TBR	1987 477 284	1511	
		ABO	04.98-08.99	44	Fg.-Nr. 6K..W..591 019→	TBR	1987 477 679	1512
	ABS	04.98-08.99	44	Fg.-Nr. 6K..W..591 019→	TBR	1987 477 695	↔ 1514	
<b>1.8</b>		03.98-09.01	66		SBR	1987 477 627	1641	
				Fg.-Nr. →6K..W..591 018	TBR	1987 477 284	1511	
		ABO	04.98-09.01	66	Fg.-Nr. 6K..W..591 019→	TBR	1987 477 679	1512
	ABS	04.98-09.01	66	Fg.-Nr. 6K..W..591 019→	TBR	1987 477 695	↔ 1514	
<b>1.9 D</b>		01.96-04.96	47		TBR	1987 477 284	1511	
<b>1.9 D, SDI</b>		12.95-08.99	47		SBR	1987 477 627	1641	
<b>1.9 SDI</b>		12.95-03.98	47	Fg.-Nr. →6K..W..591 018	TBR	1987 477 284	1511	
		10.99-09.01	50		226,232	1987 477 627	1641	
		ABO	04.98-08.99	47	Fg.-Nr. 6K..W..591 019→	TBR	1987 477 679	1512
			10.99-09.01	50		TBR	1987 477 679	1512
		ABS	04.98-08.99	47	Fg.-Nr. 6K..W..591 019→	TBR	1987 477 695	↔ 1514
	10.99-09.01		50		TBR	1987 477 695	↔ 1514	
<b>1.9 TDI</b>		07.96-08.99	66		SBR	1987 477 627	1641	
				Fg.-Nr. →6K..W..591 018	TBR	1987 477 284	1511	
			08.98-08.99	81		226,232	1987 477 627	1641
			10.99-09.01	66		226,232	1987 477 627	1641
				81		226,232	1987 477 627	1641
		ABO	04.98-08.99	66	Fg.-Nr. 6K..W..591 019→	TBR	1987 477 679	1512
			08.98-08.99	81		TBR	1987 477 679	1512
			10.99-09.01	66		TBR	1987 477 679	1512
				81		TBR	1987 477 679	1512
		ABS	04.98-08.99	66	Fg.-Nr. 6K..W..591 019→	TBR	1987 477 695	↔ 1514
			08.98-08.99	81		TBR	1987 477 695	↔ 1514
			10.99-09.01	66		TBR	1987 477 695	↔ 1514
				81		TBR	1987 477 695	↔ 1514
	<b>2.0</b>		08.99-09.01	85		226,232	1987 477 627	1641
		ABO	08.99-09.01	85		TBR	1987 477 679	1512
	ABS	08.99-09.01	85		TBR	1987 477 695	↔ 1514	

	<b>1.4</b>	05.96-08.99	44		LAB	0986 594 001 <sup>3</sup>	
					RAB	0986 594 000 <sup>3</sup>	
						0986 594 009 <sup>4</sup>	
		10.99-09.01	44		LAB	0986 594 001 <sup>3</sup>	
				RAB	0986 594 000 <sup>3</sup>		
					0986 594 009 <sup>4</sup>		
			55		LAB	0986 594 001 <sup>3</sup>	
					RAB	0986 594 000 <sup>3</sup>	
<b>1.6</b>	11.95-09.01	55/74				0986 594 009 <sup>4</sup>	
				LAB	0986 594 001 <sup>3</sup>		
				RAB	0986 594 000 <sup>3</sup>		
<b>1.7 SDI</b>	11.97-08.99	44				0986 594 009 <sup>4</sup>	
				LAB	0986 594 001 <sup>3</sup>		
				RAB	0986 594 000 <sup>3</sup>		

		S										
1.8		03.98-09.01	66					0 986 594 009 <sup>4</sup>				
				LAB					0 986 594 001 <sup>3</sup>			
				RAB					0 986 594 000 <sup>3</sup>			
1.9D		12.95-08.99	47					0 986 594 009 <sup>4</sup>				
				LAB					0 986 594 001 <sup>3</sup>			
1.9SDI		10.99-09.01	50					0 986 594 009 <sup>4</sup>				
				LAB					0 986 594 001 <sup>3</sup>			
1.9SDI		10.99-09.01	50					0 986 594 009 <sup>4</sup>				
				LAB					0 986 594 001 <sup>3</sup>			
1.9TDI		07.96-08.99	66					0 986 594 009 <sup>4</sup>				
				LAB					0 986 594 001 <sup>3</sup>			
1.9TDI		08.98-08.99	81					0 986 594 009 <sup>4</sup>				
				LAB					0 986 594 001 <sup>3</sup>			
1.9TDI		10.99-09.01	66					0 986 594 009 <sup>4</sup>				
				LAB					0 986 594 001 <sup>3</sup>			
1.9TDI		10.99-09.01	81					0 986 594 009 <sup>4</sup>				
				LAB					0 986 594 001 <sup>3</sup>			
2.0		08.99-09.01	85					0 986 594 009 <sup>4</sup>				
				LAB					0 986 594 001 <sup>3</sup>			
2.0		08.99-09.01	85					0 986 594 009 <sup>4</sup>				
				RAB					0 986 594 000 <sup>3</sup>			

**Polo Classic [9V8]**







































	1.6i	12.94-10.03	74		256	0 986 471 669	← 54	1 987 470 287 <sup>7</sup>		
						0 986 473 669		1 987 474 496 <sup>8</sup>		
						0 986 472 669	→ 54	1 987 470 287 <sup>7</sup>		
						0 986 474 669				
	1.6i	12.94-10.03	74			0 986 475 260	↔ 17,46			
						0 986 475 433	↔ 19,05			
	1.6i	12.94-10.03	74			1 987 477 284	↔ 1511			

**Polo Classic [9V8 2C4]**

	1.4i	12.94-10.03	62					0 204 104 144 <sup>7</sup>		
	1.4i	12.94-10.03	62			0 986 475 260	↔ 17,46			
	1.4i	12.94-10.03	62			1 987 477 284	↔ 1511			



		S							
◀ VW									
<b>Polo Classic [80]</b>									
	1.0	10.90-09.94	33				0 204 102 373	← 48	
							0 204 103 373		
							0 204 102 374	→ 48	
							0 204 103 374		
	1.3	10.90-09.94	40/56-59				0 204 102 373	← 48	
							0 204 103 373		
							0 204 102 374	→ 48	
							0 204 103 374		
	1.4D	10.90-09.94	35				0 204 102 373	← 48	
							0 204 103 373		
							0 204 102 374	→ 48	
							0 204 103 374		
	1.0	10.90-09.94	33		BKR		0 986 475 433	↔ 19,05	
					BKR		0 986 475 438	↔ 15,87	
	1.3	10.90-09.94	40/56-59		BKR		0 986 475 433	↔ 19,05	
					BKR		0 986 475 438	↔ 15,87	
	1.4D	10.90-09.94	35		BKR		0 986 475 433	↔ 19,05	
					BKR		0 986 475 438	↔ 15,87	
	1.0	10.90-09.94	33				1 987 477 042	1594	
							1 987 477 043	633	
	1.3	10.90-09.94	40/56-59				1 987 477 042	1594	
							1 987 477 043	633	
	1.4D	10.90-09.94	35				1 987 477 042	1594	
							1 987 477 043	633	
<b>Polo Coupé [80]</b>									
	1.0	10.90-09.94	33				0 204 102 373	← 48	
							0 204 103 373		
							0 204 102 374	→ 48	
							0 204 103 374		
	1.3	10.90-09.94	40/56-59				0 204 102 373	← 48	
							0 204 103 373		
							0 204 102 374	→ 48	
							0 204 103 374		
	1.3 G40	10.90-09.94	85				0 986 473 663	← 48	
							0 986 474 663	→ 48	
	1.4D	10.90-09.94	35				0 204 102 373	← 48	
							0 204 103 373		
							0 204 102 374	→ 48	
							0 204 103 374		
	1.0	10.90-09.94	33		BKR		0 986 475 433	↔ 19,05	
					BKR		0 986 475 438	↔ 15,87	
	1.3	10.90-09.94	40/56-59/		BKR		0 986 475 433	↔ 19,05	
	1.3 G40		85		BKR		0 986 475 438	↔ 15,87	
	1.4D	10.90-09.94	35		BKR		0 986 475 433	↔ 19,05	
					BKR		0 986 475 438	↔ 15,87	

		S							
									
	1.0	10.90-09.94	33				1 987 477 042	1594	
							1 987 477 043	633	
	1.3	10.90-09.94	40/56-59/				1 987 477 042	1594	
	1.3 G40		85				1 987 477 043	633	
	1.4 D	10.90-09.94	35				1 987 477 042	1594	
							1 987 477 043	633	
<b>Polo Hatchback</b>									
									
	1.4 i	01.01-07.08	55		252		0 986 473 071	 ← 54	1 987 470 506 <sup>B</sup>
							0 986 474 071	 → 54	1 987 470 506 <sup>B</sup>
									
	1.4 i	01.01-07.08	55				0 986 473 180	 ← 34	1 987 474 496 <sup>B</sup>
							0 986 474 180	 → 34	1 987 474 496 <sup>B</sup>
									
	1.4 i	01.01-07.08	55			LAB	0 986 594 500 <sup>3</sup>		
							0 986 594 502 <sup>4</sup>		
						RAB	0 986 594 501 <sup>3</sup>		
							0 986 594 503 <sup>4</sup>		
<b>Polo Limousine [9N2]</b>									
									
	1.6	07.03-05.07	74	PR-Code 1ZG	252		0 986 473 071	 ← 54	1 987 470 506 <sup>B</sup>
							0 986 474 071	 → 54	1 987 470 506 <sup>B</sup>
									
	1.6	07.03-05.07	74	PR-Code 1KS			0 986 473 180	 ← 34	1 987 474 496 <sup>B</sup>
							0 986 474 180	 → 34	1 987 474 496 <sup>B</sup>
									
	1.6	07.03-05.07	74				1 987 482 191	↔ 1645	
									
	1.6	07.03-05.07	74			LAB	0 986 594 500 <sup>3</sup>		
							0 986 594 502 <sup>4</sup>		
						RAB	0 986 594 501 <sup>3</sup>		
							0 986 594 503 <sup>4</sup>		
<b>Polo Playa [9V4]</b>									
									
	1.4 i	10.98-10.02	62		1LM,239				0 204 104 144 <sup>7</sup>
	1.6 i	10.98-10.02	74		1LY		0 986 471 669	← 54	1 987 470 287 <sup>7</sup>
							0 986 473 669		1 987 474 496 <sup>B</sup>
							0 986 472 669	→ 54	1 987 470 287 <sup>7</sup>
							0 986 474 669		
	1.8 i	10.98-10.02	82		1LY		0 986 471 669	← 54	1 987 470 287 <sup>7</sup>
							0 986 473 669		1 987 474 496 <sup>B</sup>
							0 986 472 669	→ 54	1 987 470 287 <sup>7</sup>
							0 986 474 669		













		S				?			
◀ VW Polo Playa [9V4]									
	1.4i	10.98-10.02	62				0986 475 260	↔ 17,46	
	1.6i	10.98-10.02	74				0986 475 260	↔ 17,46	
	1.8i	10.98-10.02	82				0986 475 433	↔ 19,05	
							0986 475 260	↔ 17,46	
							0986 475 433	↔ 19,05	
	1.4i	10.98-10.02	62				1987 477 284	↔ 1511	
	1.6i	10.98-10.02	74				1987 477 284	↔ 1511	
<b>Polo Sedan</b>									
	1.4 16V	11.02-02.05	55		252		0986 473 071	↔ 54	1987 470 506 <sup>8</sup>
							0986 474 071	↔ 54	1987 470 506 <sup>8</sup>
	1.4 16V	11.02-02.05	55		STB		F 026 009 433	↔ 19,05	
							0986 475 260	↔ 17,46	
	1.4 16V	11.02-02.05	55		4SB,B34		0986 473 180	↔ 34	1987 474 496 <sup>8</sup>
							0986 474 180	↔ 34	1987 474 496 <sup>8</sup>
					4SB,B38		0986 473 099	↔ 38,1	1987 470 040 <sup>7</sup>
							0986 473 099	↔ 38,1	1987 474 496 <sup>8</sup>
							0986 474 099	↔ 38,1	1987 470 040 <sup>7</sup>
	1.9 TDI	11.02-07.06	74				0986 473 099	↔ 38,1	1987 470 040 <sup>7</sup>
							0986 473 099	↔ 38,1	1987 474 496 <sup>8</sup>
							0986 474 099	↔ 38,1	1987 470 040 <sup>7</sup>
	1.4 16V	11.02-02.05	55		HTB		1987 477 806	↔ 1580	
					4SB		1987 477 807	↔ 1640	
	1.4 16V	11.02-02.05	55		LAB		0986 594 500 <sup>3</sup>		
							0986 594 502 <sup>4</sup>		
					RAB		0986 594 501 <sup>3</sup>		
							0986 594 503 <sup>4</sup>		
	1.9 TDI	11.02-07.06	74		LAB		0986 594 500 <sup>3</sup>		
							0986 594 502 <sup>4</sup>		
					RAB		0986 594 501 <sup>3</sup>		
							0986 594 503 <sup>4</sup>		
<b>Polo Sedan [612]</b>									
	1.6	09.10→	63/77	PR-Code 1ZG			0986 473 071	↔ 54	1987 470 506 <sup>8</sup>
							0986 474 071	↔ 54	1987 470 506 <sup>8</sup>
	1.6	09.10→	63/77	PR-Code 1KC			0986 475 433	↔ 19,05	
	1.6	09.10→	63/77		LAB		0986 594 500 <sup>3</sup>		
							0986 594 501 <sup>3</sup>		
		09.11→	63/77		LAB		0986 594 502 <sup>4</sup>		
					RAB		0986 594 503 <sup>4</sup>		



		S							
<b>Polo Sedan [614]</b>									
	1.6	05.15→	63/77		LAB	0 986 594 500 <sup>3</sup>			
						0 986 594 502 <sup>4</sup>			
					RAB	0 986 594 501 <sup>3</sup>			
						0 986 594 503 <sup>4</sup>			
<b>Polo Variant [6V5]</b>									
	1.4	05.97-08.99	44		1LA	0 204 102 373	← 48		0 204 104 144 <sup>7</sup>
						0 204 103 373			
						0 204 102 374	→ 48		0 204 104 144 <sup>7</sup>
						0 204 103 374			
					1LM,239				0 204 104 144 <sup>7</sup>
					1LY	0 986 471 669	← 54		1 987 470 287 <sup>7</sup>
						0 986 473 669			1 987 474 496 <sup>8</sup>
						0 986 472 669	→ 54		1 987 470 287 <sup>7</sup>
						0 986 474 669			
		10.99-08.00	44		1LY	0 986 472 669	→ 54		1 987 474 496 <sup>8</sup>
						0 986 474 669			
		10.99-09.01	44		1LA	0 204 102 373	← 48		0 204 104 144 <sup>7</sup>
						0 204 103 373			
						0 204 102 374	→ 48		0 204 104 144 <sup>7</sup>
						0 204 103 374			
					1LM,239				0 204 104 144 <sup>7</sup>
					1LY	0 986 471 669	← 54		1 987 470 287 <sup>7</sup>
						0 986 473 669			1 987 474 496 <sup>8</sup>
						0 986 472 669	→ 54		1 987 470 287 <sup>7</sup>
						0 986 474 669			
			55		1LA	0 204 102 373	← 48		0 204 104 144 <sup>7</sup>
						0 204 103 373			
						0 204 102 374	→ 48		0 204 104 144 <sup>7</sup>
						0 204 103 374			
					1LM,239				0 204 104 144 <sup>7</sup>
					1LY	0 986 471 669	← 54		1 987 470 287 <sup>7</sup>
						0 986 473 669			1 987 474 496 <sup>8</sup>
						0 986 472 669	→ 54		1 987 470 287 <sup>7</sup>
						0 986 474 669			
	1.6	05.97-08.99	55/74		1LY	0 986 472 669	→ 54		1 987 474 496 <sup>8</sup>
						0 986 474 669			
		05.97-09.01	55/74		1LA	0 204 102 373	← 48		0 204 104 144 <sup>7</sup>
						0 204 103 373			
						0 204 102 374	→ 48		0 204 104 144 <sup>7</sup>
						0 204 103 374			
					1LM,239				0 204 104 144 <sup>7</sup>
					1LY	0 986 471 669	← 54		1 987 470 287 <sup>7</sup>
						0 986 473 669			1 987 474 496 <sup>8</sup>
						0 986 472 669	→ 54		1 987 470 287 <sup>7</sup>
						0 986 474 669			
		09.97-09.01	55/74		1LY	0 986 471 669	← 54		1 987 474 496 <sup>8</sup>
						0 986 473 669			
	1.7 SDI	11.97-08.99	44		1LA	0 204 102 373	← 48		0 204 104 144 <sup>7</sup>
						0 204 103 373			
						0 204 102 374	→ 48		0 204 104 144 <sup>7</sup>
						0 204 103 374			
					1LM,239				0 204 104 144 <sup>7</sup>
					1LY	0 986 471 669	← 54		1 987 470 287 <sup>7</sup>
						0 986 473 669			1 987 474 496 <sup>8</sup>
						0 986 472 669	→ 54		1 987 470 287 <sup>7</sup>
						0 986 474 669			















































	◀ VW Polo Variant [6V5]										
1.9 SDI	06.97-08.99	47	1LA	0 204 102 373	← 48	0 204 104 144 <sup>7</sup>					
				0 204 103 373							
				0 204 102 374	→ 48	0 204 104 144 <sup>7</sup>					
				0 204 103 374							
				1LM,239			0 204 104 144 <sup>7</sup>				
	10.99-09.01	50	1LA	0 204 102 373	← 48	0 204 104 144 <sup>7</sup>					
				0 204 103 373							
				0 204 102 374	→ 48	0 204 104 144 <sup>7</sup>					
				0 204 103 374							
				1LM,239			0 204 104 144 <sup>7</sup>				
	1LY	0 986 471 669	← 54	1 987 470 287 <sup>7</sup>							
		0 986 473 669		1 987 474 496 <sup>8</sup>							
0 986 472 669		→ 54	1 987 470 287 <sup>7</sup>								
0 986 474 669											
1.9 TDI	06.97-08.99	66	1LA	0 204 102 373	← 48	0 204 104 144 <sup>7</sup>					
				0 204 103 373							
				0 204 102 374	→ 48	0 204 104 144 <sup>7</sup>					
				0 204 103 374							
				1LM,239			0 204 104 144 <sup>7</sup>				
	06.98-08.99	81	1LA	0 204 102 373	← 48	0 204 104 144 <sup>7</sup>					
				0 204 103 373							
				0 204 102 374	→ 48	0 204 104 144 <sup>7</sup>					
				0 204 103 374							
				1LM,239			0 204 104 144 <sup>7</sup>				
	1LY	0 986 471 669	← 54	1 987 470 287 <sup>7</sup>							
		0 986 473 669		1 987 474 496 <sup>8</sup>							
0 986 472 669		→ 54	1 987 470 287 <sup>7</sup>								
0 986 474 669											
10.99-09.01	66	1LA	0 204 102 373	← 48	0 204 104 144 <sup>7</sup>						
			0 204 103 373								
			0 204 102 374	→ 48	0 204 104 144 <sup>7</sup>						
			0 204 103 374								
			1LM,239			0 204 104 144 <sup>7</sup>					
81	1LA	0 204 102 373	← 48	0 204 104 144 <sup>7</sup>							
		0 204 103 373									
		0 204 102 374	→ 48	0 204 104 144 <sup>7</sup>							
		0 204 103 374									
			1LM,239			0 204 104 144 <sup>7</sup>					
1LY	0 986 471 669	← 54	1 987 470 287 <sup>7</sup>								
	0 986 473 669		1 987 474 496 <sup>8</sup>								
	0 986 472 669	→ 54	1 987 470 287 <sup>7</sup>								
	0 986 474 669										
1.4	05.97-08.99	44		0 986 475 260	↔ 17,46						
				0 986 475 433	↔ 19,05						
							10.99-09.01	44	0 986 475 260	↔ 17,46	
								44	0 986 475 433	↔ 19,05	
				55	0 986 475 260	↔ 17,46					
					55	0 986 475 433	↔ 19,05				

		S											
1.6		05.97-09.01	55/74				0 986 475 260	↔ 17,46					
							0 986 475 433	↔ 19,05					
1.7 SDI		11.97-08.99	44				0 986 475 260	↔ 17,46					
							0 986 475 433	↔ 19,05					
1.9 SDI		06.97-08.99	47				0 986 475 260	↔ 17,46					
							0 986 475 433	↔ 19,05					
		10.99-09.01	50				0 986 475 260	↔ 17,46					
							0 986 475 433	↔ 19,05					
1.9 TDI		06.97-08.99	66				0 986 475 260	↔ 17,46					
							0 986 475 433	↔ 19,05					
		06.98-08.99	81				0 986 475 260	↔ 17,46					
							0 986 475 433	↔ 19,05					
		10.99-09.01	66				0 986 475 260	↔ 17,46					
							0 986 475 433	↔ 19,05					
	81	0 986 475 260	↔ 17,46										
		0 986 475 433	↔ 19,05										
	1.4	05.97-08.99	44				0 986 473 352	↔ 33,9	1 987 474 496 <sup>B</sup>				
							0 986 474 352	↔ 33,9	1 987 474 496 <sup>B</sup>				
									0 986 473 072	↔ 38	1 987 470 040 <sup>7</sup>		
									0 986 473 072	↔ 38	1 987 474 496 <sup>B</sup>		
									0 986 474 072	↔ 38	1 987 470 040 <sup>7</sup>		
							10.99-09.01	44	232,B34	0 986 473 352	↔ 33,9	1 987 474 496 <sup>B</sup>	
										0 986 474 352	↔ 33,9	1 987 474 496 <sup>B</sup>	
										0 986 473 072	↔ 38	1 987 470 040 <sup>7</sup>	
										0 986 473 072	↔ 38	1 987 474 496 <sup>B</sup>	
								55	232,B34	0 986 473 352	↔ 33,9	1 987 474 496 <sup>B</sup>	
										0 986 474 352	↔ 33,9	1 987 474 496 <sup>B</sup>	
										0 986 473 072	↔ 38	1 987 470 040 <sup>7</sup>	
										0 986 473 072	↔ 38	1 987 474 496 <sup>B</sup>	
							ABO	05.97-08.99	44	226	0 986 473 150	↔ 38,1	1 987 470 040 <sup>7</sup>
											0 986 473 150	↔ 38,1	1 987 474 496 <sup>B</sup>
											0 986 474 150	↔ 38,1	1 987 470 040 <sup>7</sup>
											0 986 473 150	↔ 38,1	1 987 474 496 <sup>B</sup>
							10.99-09.01	44	226	0 986 473 150	↔ 38,1	1 987 470 040 <sup>7</sup>	
										0 986 473 150	↔ 38,1	1 987 474 496 <sup>B</sup>	
										0 986 474 150	↔ 38,1	1 987 470 040 <sup>7</sup>	
										0 986 473 150	↔ 38,1	1 987 474 496 <sup>B</sup>	
								55	226	0 986 473 150	↔ 38,1	1 987 470 040 <sup>7</sup>	
										0 986 473 150	↔ 38,1	1 987 474 496 <sup>B</sup>	
										0 986 474 150	↔ 38,1	1 987 470 040 <sup>7</sup>	
0 986 473 150	↔ 38,1	1 987 474 496 <sup>B</sup>											
ABS	05.97-08.99	44	226	0 986 473 150	↔ 38,1	1 987 470 040 <sup>7</sup>							
				0 986 473 150	↔ 38,1	1 987 474 496 <sup>B</sup>							
				0 986 474 150	↔ 38,1	1 987 470 040 <sup>7</sup>							
				0 986 473 150	↔ 38,1	1 987 474 496 <sup>B</sup>							
10.99-09.01	44	226	0 986 473 150	↔ 38,1	1 987 470 040 <sup>7</sup>								
			0 986 473 150	↔ 38,1	1 987 474 496 <sup>B</sup>								
			0 986 474 150	↔ 38,1	1 987 470 040 <sup>7</sup>								
			0 986 473 150	↔ 38,1	1 987 474 496 <sup>B</sup>								
	55	226	0 986 473 150	↔ 38,1	1 987 470 040 <sup>7</sup>								
			0 986 473 150	↔ 38,1	1 987 474 496 <sup>B</sup>								
			0 986 474 150	↔ 38,1	1 987 470 040 <sup>7</sup>								
			0 986 473 150	↔ 38,1	1 987 474 496 <sup>B</sup>								
1.6		05.97-09.01	55/74				0 986 473 352	↔ 33,9	1 987 474 496 <sup>B</sup>				
							0 986 474 352	↔ 33,9	1 987 474 496 <sup>B</sup>				
							0 986 473 072	↔ 38	1 987 470 040 <sup>7</sup>				
							0 986 473 072	↔ 38	1 987 474 496 <sup>B</sup>				
							0 986 474 072	↔ 38	1 987 470 040 <sup>7</sup>				
							0 986 473 150	↔ 38,1	1 987 474 496 <sup>B</sup>				
ABO	05.97-08.99	74					0 986 473 150	↔ 38,1	1 987 470 040 <sup>7</sup>				
							0 986 473 150	↔ 38,1	1 987 474 496 <sup>B</sup>				
		09.97-09.01	55				0 986 473 150	↔ 38,1	1 987 470 040 <sup>7</sup>				
							0 986 473 150	↔ 38,1	1 987 474 496 <sup>B</sup>				
							0 986 474 150	↔ 38,1	1 987 470 040 <sup>7</sup>				



		S							
◀ VW Polo Variant [6V5]									
1.6	ABO	10.99-09.01	74	226	0986 473 150		← 38,1	1987 470 040 <sup>7</sup>	
					0986 473 150		← 38,1	1987 474 496 <sup>8</sup>	
					0986 474 150		→ 38,1	1987 470 040 <sup>7</sup>	
	ABS	05.97-08.99	74	226	0986 473 150		← 38,1	1987 470 040 <sup>7</sup>	
					0986 473 150		← 38,1	1987 474 496 <sup>8</sup>	
					0986 474 150		→ 38,1	1987 470 040 <sup>7</sup>	
		09.97-09.01	55	226	0986 473 150		← 38,1	1987 470 040 <sup>7</sup>	
					0986 473 150		← 38,1	1987 474 496 <sup>8</sup>	
					0986 474 150		→ 38,1	1987 470 040 <sup>7</sup>	
		10.99-09.01	74	226	0986 473 150		← 38,1	1987 470 040 <sup>7</sup>	
					0986 473 150		← 38,1	1987 474 496 <sup>8</sup>	
					0986 474 150		→ 38,1	1987 470 040 <sup>7</sup>	
1.7 SDI	ABO	11.97-08.99	44	232,B34	0986 473 352		← 33,9	1987 474 496 <sup>8</sup>	
					0986 474 352		→ 33,9	1987 474 496 <sup>8</sup>	
					0986 473 072		← 38	1987 470 040 <sup>7</sup>	
					0986 474 072		→ 38	1987 470 040 <sup>7</sup>	
	ABS	11.97-08.99	44	226	0986 473 150		← 38,1	1987 470 040 <sup>7</sup>	
					0986 473 150		← 38,1	1987 474 496 <sup>8</sup>	
					0986 474 150		→ 38,1	1987 470 040 <sup>7</sup>	
	1.9 SDI	ABO	06.97-08.99	47	232,B34	0986 473 352		← 33,9	1987 474 496 <sup>8</sup>
						0986 474 352		→ 33,9	1987 474 496 <sup>8</sup>
						0986 473 072		← 38	1987 470 040 <sup>7</sup>
						0986 474 072		→ 38	1987 470 040 <sup>7</sup>
			10.99-09.01	50	232,B34	0986 473 352		← 33,9	1987 474 496 <sup>8</sup>
0986 474 352							→ 33,9	1987 474 496 <sup>8</sup>	
0986 473 072							← 38	1987 470 040 <sup>7</sup>	
ABS		06.97-08.99	47	226	0986 473 150		← 38,1	1987 470 040 <sup>7</sup>	
					0986 473 150		← 38,1	1987 474 496 <sup>8</sup>	
					0986 474 150		→ 38,1	1987 470 040 <sup>7</sup>	
1.9 TDI		ABO	06.97-08.99	66	232,B34	0986 473 352		← 33,9	1987 474 496 <sup>8</sup>
						0986 474 352		→ 33,9	1987 474 496 <sup>8</sup>
	0986 473 072						← 38	1987 470 040 <sup>7</sup>	
	0986 474 072						→ 38	1987 470 040 <sup>7</sup>	
		06.98-08.99	81	232,B34	0986 473 352		← 33,9	1987 474 496 <sup>8</sup>	
					0986 474 352		→ 33,9	1987 474 496 <sup>8</sup>	
					0986 473 072		← 38	1987 470 040 <sup>7</sup>	
	ABS	06.97-08.99	47	226	0986 473 150		← 38,1	1987 470 040 <sup>7</sup>	
					0986 473 150		← 38,1	1987 474 496 <sup>8</sup>	
					0986 474 150		→ 38,1	1987 470 040 <sup>7</sup>	
		10.99-09.01	50	226	0986 473 150		← 38,1	1987 470 040 <sup>7</sup>	
					0986 473 150		← 38,1	1987 474 496 <sup>8</sup>	
0986 474 150						→ 38,1	1987 470 040 <sup>7</sup>		
	10.99-09.01	66	232,B34	0986 473 352		← 33,9	1987 474 496 <sup>8</sup>		
				0986 474 352		→ 33,9	1987 474 496 <sup>8</sup>		
				0986 473 072		← 38	1987 470 040 <sup>7</sup>		
		81	232,B34	0986 473 352		← 33,9	1987 474 496 <sup>8</sup>		
				0986 474 352		→ 33,9	1987 474 496 <sup>8</sup>		



		S								
<b>1.9 TDI</b>		10.99-09.01	81			232,B38	0 986 473 072	 ← 38	1 987 470 040 <sup>7</sup>	
							0 986 473 072	 ← 38	1 987 474 496 <sup>8</sup>	
								0 986 474 072	 → 38	1 987 470 040 <sup>7</sup>
	ABO	06.97-08.99	66			226	0 986 473 150	 ← 38,1	1 987 470 040 <sup>7</sup>	
								0 986 473 150	 ← 38,1	1 987 474 496 <sup>8</sup>
								0 986 474 150	 → 38,1	1 987 470 040 <sup>7</sup>
		06.98-08.99	81			226	0 986 473 150	 ← 38,1	1 987 470 040 <sup>7</sup>	
								0 986 473 150	 ← 38,1	1 987 474 496 <sup>8</sup>
								0 986 474 150	 → 38,1	1 987 470 040 <sup>7</sup>
		10.99-09.01	66			226	0 986 473 150	 ← 38,1	1 987 470 040 <sup>7</sup>	
								0 986 473 150	 ← 38,1	1 987 474 496 <sup>8</sup>
								0 986 474 150	 → 38,1	1 987 470 040 <sup>7</sup>
			81			226	0 986 473 150	 ← 38,1	1 987 470 040 <sup>7</sup>	
								0 986 473 150	 ← 38,1	1 987 474 496 <sup>8</sup>
								0 986 474 150	 → 38,1	1 987 470 040 <sup>7</sup>
	ABS	06.97-08.99	66			226	0 986 473 150	 ← 38,1	1 987 470 040 <sup>7</sup>	
								0 986 473 150	 ← 38,1	1 987 474 496 <sup>8</sup>
								0 986 474 150	 → 38,1	1 987 470 040 <sup>7</sup>
		06.98-08.99	81			226	0 986 473 150	 ← 38,1	1 987 470 040 <sup>7</sup>	
								0 986 473 150	 ← 38,1	1 987 474 496 <sup>8</sup>
								0 986 474 150	 → 38,1	1 987 470 040 <sup>7</sup>
		10.99-09.01	66			226	0 986 473 150	 ← 38,1	1 987 470 040 <sup>7</sup>	
								0 986 473 150	 ← 38,1	1 987 474 496 <sup>8</sup>
								0 986 474 150	 → 38,1	1 987 470 040 <sup>7</sup>
		81			226	0 986 473 150	 ← 38,1	1 987 470 040 <sup>7</sup>		
							0 986 473 150	 ← 38,1	1 987 474 496 <sup>8</sup>	
							0 986 474 150	 → 38,1	1 987 470 040 <sup>7</sup>	
 <b>1.4</b>		05.97-12.97	44			TBR	1 987 477 284		1511	
		05.97-08.99	44			SBR	1 987 477 627		1641	
		12.97-08.99	44	Fg.-Nr. →6K..W..591 018		TBR	1 987 477 284		1511	
		10.99-09.01	44			226,232	1 987 477 627		1641	
			55			226,232	1 987 477 627		1641	
	ABO	04.98-08.99	44	Fg.-Nr. 6K..W..591 019→		TBR	1 987 477 679		1512	
		10.99-09.01	44			TBR	1 987 477 679		1512	
			55			TBR	1 987 477 679		1512	
	ABS	04.98-08.99	44	Fg.-Nr. 6K..W..591 019→		TBR	1 987 477 695	 ↔ 1514		
		10.99-09.01	44			TBR	1 987 477 695	 ↔ 1514		
			55			TBR	1 987 477 695	 ↔ 1514		
	<b>1.6</b>		05.97-03.98	55/74	Fg.-Nr. →6K..W..591 018		TBR	1 987 477 284		1511
		05.97-08.99	55/74			SBR	1 987 477 627		1641	
		07.98-09.01	55/74			226,232	1 987 477 627		1641	
ABO		04.98-08.99	55/74	Fg.-Nr. 6K..W..591 019→		TBR	1 987 477 679		1512	
		07.98-09.01	55/74			TBR	1 987 477 679		1512	
ABS		04.98-08.99	55/74	Fg.-Nr. 6K..W..591 019→		TBR	1 987 477 695	 ↔ 1514		
	07.98-09.01	55/74			TBR	1 987 477 695	 ↔ 1514			
<b>1.7 SDI</b>		11.97-08.99	44			SBR	1 987 477 627		1641	
				Fg.-Nr. →6K..W..591 018		TBR	1 987 477 284		1511	
	ABO	04.98-08.99	44	Fg.-Nr. 6K..W..591 019→		TBR	1 987 477 679		1512	
ABS	04.98-08.99	44	Fg.-Nr. 6K..W..591 019→		TBR	1 987 477 695	 ↔ 1514			
<b>1.9 SDI</b>		06.97-03.98	47	Fg.-Nr. →6K..W..591 018		TBR	1 987 477 284		1511	
		06.97-08.99	47			SBR	1 987 477 627		1641	
		10.99-09.01	50			226,232	1 987 477 627		1641	
	ABO	04.98-08.99	47	Fg.-Nr. 6K..W..591 019→		TBR	1 987 477 679		1512	
		10.99-09.01	50			TBR	1 987 477 679		1512	
	ABS	04.98-08.99	47	Fg.-Nr. 6K..W..591 019→		TBR	1 987 477 695	 ↔ 1514		
	10.99-09.01	50			TBR	1 987 477 695	 ↔ 1514			
<b>1.9 TDI</b>		06.97-08.99	66			SBR	1 987 477 627		1641	
				Fg.-Nr. →6K..W..591 018		TBR	1 987 477 284		1511	
		06.98-08.99	81			226,232	1 987 477 627		1641	
		10.99-09.01	66			226,232	1 987 477 627		1641	





	◀ VW Polo Variant [6V5]									
<b>1.9 TDI</b>	10.99-09.01	81			226,232	1987 477 627	1641			
	ABO 04.98-08.99	66	Fg.-Nr. 6K..W..591 019→		TBR	1987 477 679	1512			
	06.98-08.99	81			TBR	1987 477 679	1512			
	10.99-09.01	66			TBR	1987 477 679	1512			
		81			TBR	1987 477 679	1512			
	ABS 04.98-08.99	66	Fg.-Nr. 6K..W..591 019→		TBR	1987 477 695	↔ 1514			
	06.98-08.99	81			TBR	1987 477 695	↔ 1514			
	10.99-09.01	66			TBR	1987 477 695	↔ 1514			
		81			TBR	1987 477 695	↔ 1514			
	<b>1.4</b>	05.97-08.99	44			0986 594 009 <sup>4</sup>				
					LAB	0986 594 001 <sup>3</sup>				
					RAB	0986 594 000 <sup>3</sup>				
		10.99-09.01	44			0986 594 009 <sup>4</sup>				
					LAB	0986 594 001 <sup>3</sup>				
					RAB	0986 594 000 <sup>3</sup>				
			55			0986 594 009 <sup>4</sup>				
					LAB	0986 594 001 <sup>3</sup>				
					RAB	0986 594 000 <sup>3</sup>				
	<b>1.6</b>	05.97-09.01	55/74			0986 594 009 <sup>4</sup>				
					LAB	0986 594 001 <sup>3</sup>				
					RAB	0986 594 000 <sup>3</sup>				
	<b>1.7 SDI</b>	11.97-08.99	44			0986 594 009 <sup>4</sup>				
					LAB	0986 594 001 <sup>3</sup>				
					RAB	0986 594 000 <sup>3</sup>				
	<b>1.9 SDI</b>	06.97-08.99	47			0986 594 009 <sup>4</sup>				
					LAB	0986 594 001 <sup>3</sup>				
					RAB	0986 594 000 <sup>3</sup>				
		10.99-09.01	50			0986 594 009 <sup>4</sup>				
					LAB	0986 594 001 <sup>3</sup>				
					RAB	0986 594 000 <sup>3</sup>				
	<b>1.9 TDI</b>	06.97-08.99	66			0986 594 009 <sup>4</sup>				
					LAB	0986 594 001 <sup>3</sup>				
					RAB	0986 594 000 <sup>3</sup>				
		06.98-08.99	81			0986 594 009 <sup>4</sup>				
					LAB	0986 594 001 <sup>3</sup>				
					RAB	0986 594 000 <sup>3</sup>				
		10.99-09.01	66			0986 594 009 <sup>4</sup>				
					LAB	0986 594 001 <sup>3</sup>				
					RAB	0986 594 000 <sup>3</sup>				
			81			0986 594 009 <sup>4</sup>				
					LAB	0986 594 001 <sup>3</sup>				
					RAB	0986 594 000 <sup>3</sup>				

<b>Polo Vivo [6S1]</b>									
	<b>1.4 i</b>	02.10→	55/63			0986 473 071	← 54	1987 470 506 <sup>8</sup>	
						0986 474 071	→ 54	1987 470 506 <sup>8</sup>	
	<b>1.4 i</b>	02.10→	55/63	PR-Code 1KB		0986 475 260	↔ 17,46		
				PR-Code 1KM		0986 475 433	↔ 19,05		
	<b>1.4 i</b>	02.10→	55/63			1987 482 446	↔ 1580		
	<b>1.4 i</b>	02.10→	55/63		LAB	0986 594 500 <sup>3</sup>			
						0986 594 502 <sup>4</sup>			



1.4i	02.10→	55/63	RAB	0 986 594 501 <sup>3</sup>	
				0 986 594 503 <sup>4</sup>	

**Polo [6C1]**



	<b>1.0</b>	02.14-05.15	44/55/70/81	PR-Code 1LR, PR-Code 1ZG, PR-Code 1ZJ	252	0 986 473 071	↔ 54	1 987 470 506 <sup>B</sup>
	<b>1.0 TSI</b>					0 986 474 071	↔ 54	1 987 470 506 <sup>B</sup>
		02.14→	44/55/70/81	PR-Code 1LN, PR-Code 1ZC	288	0 986 473 384	↔ 53,94	F 026 A06 106 <sup>7</sup>
						0 986 473 384	↔ 53,94	1 987 470 506 <sup>B</sup>
						0 986 474 384	↔ 53,94	F 026 A06 106 <sup>7</sup>
				PR-Code 1ZR		0 986 473 384	↔ 53,94	F 026 A06 106 <sup>7</sup>
						0 986 473 384	↔ 53,94	1 987 470 506 <sup>B</sup>
						0 986 474 384	↔ 53,94	F 026 A06 106 <sup>7</sup>
	<b>1.2</b>	02.14-05.15	66/81	PR-Code 1LR, PR-Code 1ZG, PR-Code 1ZJ	252	0 986 473 071	↔ 54	1 987 470 506 <sup>B</sup>
						0 986 474 071	↔ 54	1 987 470 506 <sup>B</sup>
		02.14→	66/81	PR-Code 1LN, PR-Code 1ZC	288	0 986 473 384	↔ 53,94	F 026 A06 106 <sup>7</sup>
						0 986 473 384	↔ 53,94	1 987 470 506 <sup>B</sup>
						0 986 474 384	↔ 53,94	F 026 A06 106 <sup>7</sup>
				PR-Code 1ZR		0 986 473 384	↔ 53,94	F 026 A06 106 <sup>7</sup>
						0 986 473 384	↔ 53,94	1 987 470 506 <sup>B</sup>
						0 986 474 384	↔ 53,94	F 026 A06 106 <sup>7</sup>
	<b>1.4 TDI</b>	02.14-05.15	55/66/77/110	PR-Code 1LR, PR-Code 1ZG, PR-Code 1ZJ	252	0 986 473 071	↔ 54	1 987 470 506 <sup>B</sup>
	<b>1.4 TSI ACT</b>					0 986 474 071	↔ 54	1 987 470 506 <sup>B</sup>
		02.14→	55/66/77/110	PR-Code 1LN, PR-Code 1ZC	288	0 986 473 384	↔ 53,94	F 026 A06 106 <sup>7</sup>
						0 986 473 384	↔ 53,94	1 987 470 506 <sup>B</sup>
						0 986 474 384	↔ 53,94	F 026 A06 106 <sup>7</sup>
				PR-Code 1ZR		0 986 473 384	↔ 53,94	F 026 A06 106 <sup>7</sup>
						0 986 473 384	↔ 53,94	1 987 470 506 <sup>B</sup>
						0 986 474 384	↔ 53,94	F 026 A06 106 <sup>7</sup>
	<b>1.8 GTI</b>	11.14-05.15	141	PR-Code 1LR, PR-Code 1ZG, PR-Code 1ZJ	252	0 986 473 071	↔ 54	1 987 470 506 <sup>B</sup>
						0 986 474 071	↔ 54	1 987 470 506 <sup>B</sup>
		11.14→	141	PR-Code 1LN, PR-Code 1ZC	288	0 986 473 384	↔ 53,94	F 026 A06 106 <sup>7</sup>
						0 986 473 384	↔ 53,94	1 987 470 506 <sup>B</sup>
						0 986 474 384	↔ 53,94	F 026 A06 106 <sup>7</sup>
				PR-Code 1ZR		0 986 473 384	↔ 53,94	F 026 A06 106 <sup>7</sup>
						0 986 473 384	↔ 53,94	1 987 470 506 <sup>B</sup>
						0 986 474 384	↔ 53,94	F 026 A06 106 <sup>7</sup>



	<b>1.0</b>	02.14→	44/55			0 986 475 433	↔ 19,05	
	<b>1.4 TDI</b>	02.14→	55			0 986 475 433	↔ 19,05	

	<b>1.0</b>	02.14→	44/55	PR-Code 1KK, PR-Code 1KT, PR-Code 2EJ				1 987 470 040 <sup>7</sup>
								1 987 474 496 <sup>B</sup>
	<b>1.0 TSI</b>	11.14→	70/81	PR-Code 1KK, PR-Code 1KT, PR-Code 2EJ, PR-Code 1KV				1 987 470 040 <sup>7</sup>
								1 987 474 496 <sup>B</sup>
	<b>1.2</b>	02.14→	66/81	PR-Code 1KK, PR-Code 1KT, PR-Code 2EJ, PR-Code 1KV				1 987 470 040 <sup>7</sup>
								1 987 474 496 <sup>B</sup>
	<b>1.4 TDI</b>	02.14→	55	PR-Code 1KK, PR-Code 1KT, PR-Code 2EJ				1 987 470 040 <sup>7</sup>
								1 987 474 496 <sup>B</sup>
	<b>1.4 TDI</b>	02.14→	66/77/110	PR-Code 1KK, PR-Code 1KT, PR-Code 2EJ, PR-Code 1KV				1 987 470 040 <sup>7</sup>
	<b>1.4 TSI ACT</b>							1 987 474 496 <sup>B</sup>
								1 987 470 040 <sup>7</sup>
								1 987 474 496 <sup>B</sup>
	<b>1.8 GTI</b>	11.14→	141	PR-Code 1KK, PR-Code 1KT, PR-Code 2EJ				1 987 470 040 <sup>7</sup>
								1 987 474 496 <sup>B</sup>





		S							
<b>VW Polo [6C1]</b>									
	1.8 GTI	11.14→	141	PR-Code 1KV					1987 470 040 <sup>7</sup> 1987 474 496 <sup>8</sup>
	1.0	02.14→	44/55				1987 482 266	↔ 1588	
	1.4 TDI	02.14→	55				1987 482 266	↔ 1588	
	1.0	02.14→	44/55/70/		LAB		0986 594 500 <sup>3</sup>		
	1.0 TSI		81		RAB		0986 594 502 <sup>4</sup>		
							0986 594 503 <sup>4</sup>		
	1.2	02.14→	66/81		LAB		0986 594 500 <sup>3</sup>		
					RAB		0986 594 502 <sup>4</sup>		
							0986 594 503 <sup>4</sup>		
	1.4 TDI	02.14→	55/66/77/		LAB		0986 594 500 <sup>3</sup>		
	1.4 TSI ACT		110		RAB		0986 594 502 <sup>4</sup>		
							0986 594 503 <sup>4</sup>		
	1.8 GTI	11.14→	141		LAB		0986 594 500 <sup>3</sup>		
					RAB		0986 594 502 <sup>4</sup>		
							0986 594 501 <sup>3</sup>		
							0986 594 503 <sup>4</sup>		
<b>Polo [6N1]</b>									
	1.0	10.94-02.96	33	Fg.-Nr. →6N..TY140 000, →6N..TW070 000			0204 103 375	← 48	0204 104 144 <sup>7</sup>
							0204 103 376	→ 48	0204 104 144 <sup>7</sup>
		10.94-12.99	33		1LA		0204 004 658	→ 48	0204 104 144 <sup>7</sup>
							0986 474 191		
							0986 473 191	← 48	0204 104 144 <sup>7</sup>
					1LY,BSC, S25		0986 473 149	← 54	1987 470 287 <sup>7</sup>
							0986 473 149	← 54	1987 474 496 <sup>8</sup>
							0986 474 149	→ 54	1987 470 287 <sup>7</sup>
					1LY,BSR, S25		0986 473 148	← 54	1987 470 287 <sup>7</sup>
							0986 473 148	← 54	1987 474 496 <sup>8</sup>
							0986 474 148	→ 54	1987 470 287 <sup>7</sup>
					1LY,NOR, S25		0986 473 149	← 54	1987 470 287 <sup>7</sup>
							0986 473 149	← 54	1987 474 496 <sup>8</sup>
							0986 474 149	→ 54	1987 470 287 <sup>7</sup>
		03.96-12.99	37				0204 102 580	← 48	0204 104 144 <sup>7</sup>
							0986 134 020		
							0204 102 581	→ 48	0204 104 144 <sup>7</sup>
							0204 103 581		
							0986 135 020		
					1LA		0204 004 658	→ 48	0204 104 144 <sup>7</sup>
							0986 474 191		
							0986 473 191	← 48	0204 104 144 <sup>7</sup>
					1LY,BSC, S25		0986 473 149	← 54	1987 470 287 <sup>7</sup>
							0986 473 149	← 54	1987 474 496 <sup>8</sup>
							0986 474 149	→ 54	1987 470 287 <sup>7</sup>
					1LY,BSR, S25		0986 473 148	← 54	1987 470 287 <sup>7</sup>
							0986 473 148	← 54	1987 474 496 <sup>8</sup>
							0986 474 148	→ 54	1987 470 287 <sup>7</sup>
					1LY,NOR, S25		0986 473 149	← 54	1987 470 287 <sup>7</sup>
							0986 473 149	← 54	1987 474 496 <sup>8</sup>
							0986 474 149	→ 54	1987 470 287 <sup>7</sup>



		S								
1.0	09.96-12.99	33	Fg.-Nr. 6N..TY140 000→, 6N..TW070 000→	0 204 102 580	← 48	0 204 104 144 <sup>7</sup>				
				0 986 134 020						
				0 204 102 581	→ 48	0 204 104 144 <sup>7</sup>				
				0 204 103 581						
1.3	10.94-07.95	40		0 204 103 375	← 48	0 204 104 144 <sup>7</sup>				
				0 204 103 376	→ 48	0 204 104 144 <sup>7</sup>				
				1LA	0 204 004 658	→ 48	0 204 104 144 <sup>7</sup>			
					0 986 474 191					
					0 986 473 191	← 48	0 204 104 144 <sup>7</sup>			
				1LY,BSC, S25	0 986 473 149	← 54	1 987 470 287 <sup>7</sup>			
					0 986 473 149	← 54	1 987 474 496 <sup>8</sup>			
					0 986 474 149	→ 54	1 987 470 287 <sup>7</sup>			
				1LY,BSR, S25	0 986 473 148	← 54	1 987 470 287 <sup>7</sup>			
					0 986 473 148	← 54	1 987 474 496 <sup>8</sup>			
					0 986 474 148	→ 54	1 987 470 287 <sup>7</sup>			
				1LY,NOR, S25	0 986 473 149	← 54	1 987 470 287 <sup>7</sup>			
					0 986 473 149	← 54	1 987 474 496 <sup>8</sup>			
					0 986 474 149	→ 54	1 987 470 287 <sup>7</sup>			
					07.96-12.99	40		0 204 102 580	← 48	0 204 104 144 <sup>7</sup>
								0 986 134 020		
0 204 102 581	→ 48	0 204 104 144 <sup>7</sup>								
0 204 103 581										
0 986 135 020										
1LA	0 204 004 658	→ 48	0 204 104 144 <sup>7</sup>							
	0 986 474 191									
	0 986 473 191	← 48	0 204 104 144 <sup>7</sup>							
1LY,BSC, S25	0 986 473 149	← 54	1 987 470 287 <sup>7</sup>							
	0 986 473 149	← 54	1 987 474 496 <sup>8</sup>							
	0 986 474 149	→ 54	1 987 470 287 <sup>7</sup>							
1LY,BSR, S25	0 986 473 148	← 54	1 987 470 287 <sup>7</sup>							
	0 986 473 148	← 54	1 987 474 496 <sup>8</sup>							
	0 986 474 148	→ 54	1 987 470 287 <sup>7</sup>							
1LY,NOR, S25	0 986 473 149	← 54	1 987 470 287 <sup>7</sup>							
	0 986 473 149	← 54	1 987 474 496 <sup>8</sup>							
	0 986 474 149	→ 54	1 987 470 287 <sup>7</sup>							
1.4	07.95-02.96	40-44	Fg.-Nr. →6N..TY140 000, →6N..TW070 000	0 204 103 375	← 48	0 204 104 144 <sup>7</sup>				
				0 204 103 376	→ 48	0 204 104 144 <sup>7</sup>				
				1LA	0 204 004 658	→ 48	0 204 104 144 <sup>7</sup>			
					0 986 474 191					
	07.95-12.99	40-44				0 986 473 191	← 48	0 204 104 144 <sup>7</sup>		
					1LA	0 204 004 658	→ 48	0 204 104 144 <sup>7</sup>		
						0 986 474 191				
						0 986 473 191	← 48	0 204 104 144 <sup>7</sup>		
					1LY,BSC, S25	0 986 473 149	← 54	1 987 470 287 <sup>7</sup>		
						0 986 473 149	← 54	1 987 474 496 <sup>8</sup>		
						0 986 474 149	→ 54	1 987 470 287 <sup>7</sup>		
					1LY,BSR, S25	0 986 473 148	← 54	1 987 470 287 <sup>7</sup>		
						0 986 473 148	← 54	1 987 474 496 <sup>8</sup>		
						0 986 474 148	→ 54	1 987 470 287 <sup>7</sup>		
					1LY,NOR, S25	0 986 473 149	← 54	1 987 470 287 <sup>7</sup>		
						0 986 473 149	← 54	1 987 474 496 <sup>8</sup>		
	0 986 474 149	→ 54	1 987 470 287 <sup>7</sup>							
09.96-12.99	40-44		Fg.-Nr. 6N..TY140 000→, 6N..TW070 000→	0 204 102 580	← 48	0 204 104 144 <sup>7</sup>				
				0 986 134 020						
				0 204 102 581	→ 48	0 204 104 144 <sup>7</sup>				
				0 204 103 581						
05.97-12.99	44			0 204 102 580	← 48	0 204 104 144 <sup>7</sup>				
				0 986 134 020						
				0 204 102 581	→ 48	0 204 104 144 <sup>7</sup>				
				0 204 103 581						
				0 986 135 020						



			S											
◀ VW Polo [6N1]														
1.4	05.97-12.99	44	1LA	0 204 004 658	→ 48	0 204 104 144 <sup>7</sup>								
				0 986 474 191										
				0 986 473 191	← 48	0 204 104 144 <sup>7</sup>								
				1LY,BSC, S25	0 986 473 149	← 54	1 987 470 287 <sup>7</sup>							
					0 986 473 149	← 54	1 987 474 496 <sup>8</sup>							
				1LY,BSR, S25	0 986 474 149	→ 54	1 987 470 287 <sup>7</sup>							
					0 986 473 148	← 54	1 987 470 287 <sup>7</sup>							
					0 986 473 148	← 54	1 987 474 496 <sup>8</sup>							
				1LY,NOR, S25	0 986 474 148	→ 54	1 987 470 287 <sup>7</sup>							
					0 986 473 149	← 54	1 987 470 287 <sup>7</sup>							
					0 986 473 149	← 54	1 987 474 496 <sup>8</sup>							
							0 986 474 149	→ 54	1 987 470 287 <sup>7</sup>					
				1.6	10.94-07.95	55	1LA	0 204 103 375	← 48	0 204 104 144 <sup>7</sup>				
								0 204 103 376	→ 48	0 204 104 144 <sup>7</sup>				
					10.94-12.99	55	1LA	0 204 004 658	→ 48	0 204 104 144 <sup>7</sup>				
0 986 474 191														
0 986 473 191	← 48	0 204 104 144 <sup>7</sup>												
1LY,BSC, S25	0 986 473 149	← 54	1 987 470 287 <sup>7</sup>											
	0 986 473 149	← 54	1 987 474 496 <sup>8</sup>											
1LY,BSR, S25	0 986 474 149	→ 54	1 987 470 287 <sup>7</sup>											
	0 986 473 148	← 54	1 987 470 287 <sup>7</sup>											
	0 986 473 148	← 54	1 987 474 496 <sup>8</sup>											
1LY,NOR, S25	0 986 474 148	→ 54	1 987 470 287 <sup>7</sup>											
	0 986 473 149	← 54	1 987 470 287 <sup>7</sup>											
	0 986 473 149	← 54	1 987 474 496 <sup>8</sup>											
			0 986 474 149					→ 54	1 987 470 287 <sup>7</sup>					
07.95-02.96	55							Fg.-Nr. →6N..TY140 000, →6N..TW070 000						
				0 204 103 375	← 48	0 204 104 144 <sup>7</sup>								
03.96-12.99	55			0 204 103 376	→ 48	0 204 104 144 <sup>7</sup>								
				0 204 102 580	← 48	0 204 104 144 <sup>7</sup>								
				0 986 134 020										
				0 204 102 581	→ 48	0 204 104 144 <sup>7</sup>								
				0 204 103 581										
04.98-12.99	88			0 986 135 020										
				0 204 102 580	← 48	0 204 104 144 <sup>7</sup>								
				0 986 134 020										
				0 204 102 581	→ 48	0 204 104 144 <sup>7</sup>								
				0 204 103 581										
				0 986 135 020										
				1LA	0 204 004 658	→ 48	0 204 104 144 <sup>7</sup>							
					0 986 474 191									
				1LY,BSC, S25	0 986 473 191	← 48	0 204 104 144 <sup>7</sup>							
					0 986 473 149	← 54	1 987 470 287 <sup>7</sup>							
1LY,BSR, S25	0 986 473 149	← 54	1 987 474 496 <sup>8</sup>											
	0 986 474 149	→ 54	1 987 470 287 <sup>7</sup>											
1LY,NOR, S25	0 986 473 148	← 54	1 987 470 287 <sup>7</sup>											
	0 986 473 148	← 54	1 987 474 496 <sup>8</sup>											
			0 986 474 148	→ 54	1 987 470 287 <sup>7</sup>									
			0 986 473 149	← 54	1 987 470 287 <sup>7</sup>									
			0 986 473 149	← 54	1 987 474 496 <sup>8</sup>									
			0 986 474 149	→ 54	1 987 470 287 <sup>7</sup>									
1.7 SDI	04.97-12.99	42/44	1LA	0 204 102 580	← 48	0 204 104 144 <sup>7</sup>								
				0 986 134 020										
				0 204 102 581	→ 48	0 204 104 144 <sup>7</sup>								
				0 204 103 581										
				0 986 135 020										
1LY,BSC, S25			1LA	0 204 004 658	→ 48	0 204 104 144 <sup>7</sup>								
				0 986 474 191										
				0 986 473 191	← 48	0 204 104 144 <sup>7</sup>								
				0 986 473 149	← 54	1 987 470 287 <sup>7</sup>								
				0 986 473 149	← 54	1 987 474 496 <sup>8</sup>								
1LY,BSR, S25			1LY,BSC, S25	0 986 474 149	→ 54	1 987 470 287 <sup>7</sup>								
				0 986 473 148	← 54	1 987 470 287 <sup>7</sup>								
				0 986 473 148	← 54	1 987 474 496 <sup>8</sup>								
				0 986 474 148	→ 54	1 987 470 287 <sup>7</sup>								
				0 986 473 149	← 54	1 987 470 287 <sup>7</sup>								
				0 986 473 149	← 54	1 987 474 496 <sup>8</sup>								
				0 986 474 149	→ 54	1 987 470 287 <sup>7</sup>								



	S											
1.7 SDI	04.97-12.99	42/44			1LY,BSR, S25	0 986 473 148	← 54	1 987 470 287 <sup>7</sup>				
						0 986 473 148	← 54	1 987 474 496 <sup>8</sup>				
						0 986 474 148	→ 54	1 987 470 287 <sup>7</sup>				
						1LY,NOR, S25	0 986 473 149	← 54	1 987 470 287 <sup>7</sup>			
						0 986 473 149	← 54	1 987 474 496 <sup>8</sup>				
						0 986 474 149	→ 54	1 987 470 287 <sup>7</sup>				
1.9 D	10.94-02.96	47		Fg.-Nr. →6N..TY140 000, →6N..TW070 000	1LA	0 204 103 375	← 48	0 204 104 144 <sup>7</sup>				
						0 204 103 376	→ 48	0 204 104 144 <sup>7</sup>				
						10.94-12.99	47	0 204 004 658	→ 48	0 204 104 144 <sup>7</sup>		
	07.96-12.99	47				1LY,BSR, S25	0 986 474 191					
							0 986 473 191	← 48	0 204 104 144 <sup>7</sup>			
							1LY,BSC, S25	0 986 473 149	← 54	1 987 470 287 <sup>7</sup>		
							0 986 473 149	← 54	1 987 474 496 <sup>8</sup>			
							0 986 474 149	→ 54	1 987 470 287 <sup>7</sup>			
							1LY,BSR, S25	0 986 473 148	← 54	1 987 470 287 <sup>7</sup>		
							0 986 473 148	← 54	1 987 474 496 <sup>8</sup>			
							0 986 474 148	→ 54	1 987 470 287 <sup>7</sup>			
							1LY,NOR, S25	0 986 473 149	← 54	1 987 470 287 <sup>7</sup>		
							0 986 473 149	← 54	1 987 474 496 <sup>8</sup>			
							0 986 474 149	→ 54	1 987 470 287 <sup>7</sup>			
							0 204 102 580	← 48	0 204 104 144 <sup>7</sup>			
0 986 134 020												
0 204 102 581	→ 48	0 204 104 144 <sup>7</sup>										
0 204 103 581												
0 986 135 020												
	1.0	10.94-12.99	33/37			0 986 475 260	↔ 17,46					
	1.3	10.94-07.95	40			0 986 475 260	↔ 17,46					
		07.96-12.99	40			0 986 475 260	↔ 17,46					
	1.4	07.95-12.99	40-44/74			0 986 475 260	↔ 17,46					
	1.6	10.94-12.99	55			0 986 475 260	↔ 17,46					
	1.7 SDI	04.97-12.99	42/44			0 986 475 260	↔ 17,46					
	1.9 D	10.94-12.99	47			0 986 475 260	↔ 17,46					
	1.4	04.96-12.99	74			0 986 473 150	← 38,1	1 987 470 040 <sup>7</sup>				
						0 986 473 150	← 38,1	1 987 474 496 <sup>8</sup>				
						0 986 474 150	→ 38,1	1 987 470 040 <sup>7</sup>				
	1.6	10.94-07.95	55				0 986 473 155	←	1 987 470 040 <sup>7</sup>			
							0 986 474 875	←				
							0 986 473 155	←	1 987 474 496 <sup>8</sup>			
							0 986 474 875	←				
							0 986 474 155	→	1 987 470 040 <sup>7</sup>			
							0 986 474 876	→				
							04.98-12.99	88	BSC	0 986 473 155	←	1 987 470 040 <sup>7</sup>
							0 986 474 875	←				
							0 986 473 155	←	1 987 474 496 <sup>8</sup>			
	0 986 474 875	←										
	0 986 474 155	→	1 987 470 040 <sup>7</sup>									
	0 986 474 876	→										
		BSR					1 987 470 040 <sup>7</sup>					
							1 987 474 496 <sup>8</sup>					
	1.0	10.94-01.98	33/37	Fg.-Nr. →WW130000/ WY220000	TBR	1 987 477 284	1511					
		ABO	02.98-12.99	33/37	Fg.-Nr. WW130001/ WY220001→	TBR	1 987 477 679	1512				
		ABS	02.98-12.99	33/37	Fg.-Nr. WW130001/ WY220001→	TBR	1 987 477 695	↔ 1514				



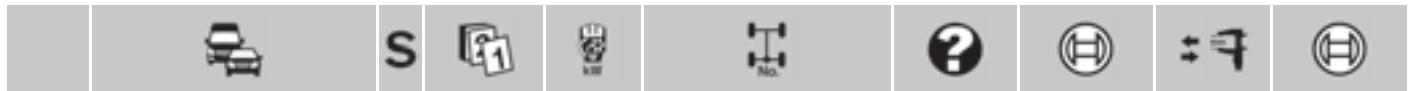

◀ VW Polo [6N1]

<b>1.3</b>	A	10.94-07.95	40	Fg.-Nr. →6N-T 300 000	TBR	1987 477 284	1511
		07.96-01.98	40	Fg.-Nr. 6N-V-000 001→ WW130000/WY220000	TBR	1987 477 284	1511
		02.98-12.99	40	Fg.-Nr. WW130001/ WY220001→	TBR	1987 477 679	1512
	ABS	10.94-07.95	40	Fg.-Nr. →WW130000/ WY220000	TBR	1987 477 284	1511
		07.96-01.98	40	Fg.-Nr. →WW130000/ WY220000	TBR	1987 477 284	1511
		02.98-12.99	40	Fg.-Nr. WW130001/ WY220001→	TBR	1987 477 695	↔ 1514
<b>1.4</b>		07.95-01.98	40-44	Fg.-Nr. →WW130000/ WY220000	TBR	1987 477 284	1511
		04.96-01.98	74	Fg.-Nr. →WW130000/ WY220000	TBR	1987 477 284	1511
		04.96-12.99	74		SBR	1987 477 627	1641
		05.97-01.98	44	Fg.-Nr. →WW130000/ WY220000	TBR	1987 477 284	1511
	A	02.98-12.99	40-44/74	Fg.-Nr. WW130001/ WY220001→	TBR	1987 477 679	1512
	ABS	01.98-01.98	44	Fg.-Nr. →WW130000/ WY220000	TBR	1987 477 284	1511
		02.98-12.99	40-44	Fg.-Nr. WW130001/ WY220001→	TBR	1987 477 695	↔ 1514
			44	Fg.-Nr. WW130001/ WY220001→	TBR	1987 477 695	↔ 1514
			74	Fg.-Nr. WW130001/ WY220001→	TBR	1987 477 695	↔ 1514
<b>1.6</b>		10.94-07.95	55			1987 477 284	↔ 1511
		07.95-01.98	55	Fg.-Nr. →WW130000/ WY220000	TBR	1987 477 284	1511
		04.98-12.99	88		SBR	1987 477 627	↔ 1641
	A	02.98-12.99	55	Fg.-Nr. WW130001/ WY220001→	TBR	1987 477 679	1512
	ABS	10.94-07.95	55	Fg.-Nr. →WW130000/ WY220000	TBR	1987 477 284	1511
		02.98-12.99	55	Fg.-Nr. WW130001/ WY220001→	TBR	1987 477 695	↔ 1514
<b>1.7 SDI</b>		04.97-01.98	42/44	Fg.-Nr. →WW130000/ WY220000	TBR	1987 477 284	1511
	A	02.98-12.99	42/44	Fg.-Nr. WW130001/ WY220001→	TBR	1987 477 679	1512
	ABS	02.98-12.99	42/44	Fg.-Nr. WW130001/ WY220001→	TBR	1987 477 695	↔ 1514
<b>1.9 D</b>		10.94-01.98	47	Fg.-Nr. →WW130000/ WY220000	TBR	1987 477 284	1511
	A	07.96-01.98	47	Fg.-Nr. 6N-V-000 001→ WW130000/WY220000	TBR	1987 477 284	1511
		02.98-12.99	47	Fg.-Nr. WW130001/ WY220001→	TBR	1987 477 679	1512
	ABS	07.96-01.98	47	Fg.-Nr. →WW130000/ WY220000	TBR	1987 477 284	1511
		02.98-12.99	47	Fg.-Nr. WW130001/ WY220001→	TBR	1987 477 695	↔ 1514
<b>1.0</b>		10.94-12.99	33/37		LAB	0986 594 001 <sup>3</sup>	
					RAB	0986 594 000 <sup>3</sup>	
		10.96-12.99	33/37	Fg.-Nr. 6N-VW 095 001→		0986 594 009 <sup>4</sup>	
<b>1.3</b>		10.94-07.95	40		LAB	0986 594 001 <sup>3</sup>	
					RAB	0986 594 000 <sup>3</sup>	
		07.96-12.99	40		LAB	0986 594 001 <sup>3</sup>	
					RAB	0986 594 000 <sup>3</sup>	
		10.96-12.99	40	Fg.-Nr. 6N-VW 095 001→		0986 594 009 <sup>4</sup>	

	S							
1.4	07.95-12.99	40-44/74		LAB		0 986 594 001 <sup>3</sup>		
				RAB		0 986 594 000 <sup>3</sup>		
	10.96-12.99	40-44/74	Fg.-Nr. 6N-VW 095 001→			0 986 594 009 <sup>4</sup>		
1.6	10.94-07.95	55				0 986 594 009 <sup>4</sup>		
				10.94-12.99	55			0 986 594 001 <sup>3</sup>
				LAB		0 986 594 001 <sup>3</sup>		
				RAB		0 986 594 000 <sup>3</sup>		
	10.96-12.99	55	Fg.-Nr. 6N-VW 095 001→			0 986 594 009 <sup>4</sup>		
	04.98-12.99	88		LAB		0 986 594 001 <sup>3</sup>		
				RAB		0 986 594 000 <sup>3</sup>		
			Fg.-Nr. 6N-VW 095 001→			0 986 594 009 <sup>4</sup>		
1.7 SDI	04.97-12.99	42/44		LAB		0 986 594 001 <sup>3</sup>		
				RAB		0 986 594 000 <sup>3</sup>		
						0 986 594 009 <sup>4</sup>		
1.9 D	10.94-12.99	47		LAB		0 986 594 001 <sup>3</sup>		
				RAB		0 986 594 000 <sup>3</sup>		
	10.96-12.99	47	Fg.-Nr. 6N-VW 095 001→			0 986 594 009 <sup>4</sup>		
<b>Polo [6N2]</b>								
	1.0	07.98-09.01	37			0 204 102 580	← 48	0 204 104 144 <sup>7</sup>
						0 986 134 020		
						0 204 102 581	→ 48	0 204 104 144 <sup>7</sup>
						0 204 103 581		
						0 986 135 020		
				1LY,S25		0 986 473 148	← 54	1 987 470 287 <sup>7</sup>
						0 986 473 148	← 54	1 987 474 496 <sup>8</sup>
						0 986 474 148	→ 54	1 987 470 287 <sup>7</sup>
1.4	09.98-09.01	40/44				0 204 102 580	← 48	0 204 104 144 <sup>7</sup>
						0 986 134 020		
						0 204 102 581	→ 48	0 204 104 144 <sup>7</sup>
						0 204 103 581		
						0 986 135 020		
				1LY,S25		0 986 473 148	← 54	1 987 470 287 <sup>7</sup>
						0 986 473 148	← 54	1 987 474 496 <sup>8</sup>
						0 986 474 148	→ 54	1 987 470 287 <sup>7</sup>
1.4 TDI	10.99-09.01	55			1LY,S25	0 986 473 148	← 54	1 987 470 287 <sup>7</sup>
						0 986 473 148	← 54	1 987 474 496 <sup>8</sup>
						0 986 474 148	→ 54	1 987 470 287 <sup>7</sup>
1.4 TDI	01.00-04.00	66				0 204 102 580	← 48	0 204 104 144 <sup>7</sup>
						0 986 134 020		
						0 204 102 581	→ 48	0 204 104 144 <sup>7</sup>
						0 204 103 581		
						0 986 135 020		
				1LY,S25		0 986 473 148	← 54	1 987 470 287 <sup>7</sup>
						0 986 473 148	← 54	1 987 474 496 <sup>8</sup>
						0 986 474 148	→ 54	1 987 470 287 <sup>7</sup>
1.4 TDI	01.99-09.01	55				0 204 102 580	← 48	0 204 104 144 <sup>7</sup>
						0 986 134 020		
1.4 16V						0 204 102 581	→ 48	0 204 104 144 <sup>7</sup>
						0 204 103 581		
						0 986 135 020		
1.4 16V	09.98-09.01	74				0 204 102 580	← 48	0 204 104 144 <sup>7</sup>
						0 986 134 020		
						0 204 102 581	→ 48	0 204 104 144 <sup>7</sup>
						0 204 103 581		
						0 986 135 020		
				1LY,S25		0 986 473 148	← 54	1 987 470 287 <sup>7</sup>
						0 986 473 148	← 54	1 987 474 496 <sup>8</sup>
						0 986 474 148	→ 54	1 987 470 287 <sup>7</sup>
	01.99-09.01	55			S25	0 986 473 148	← 54	1 987 470 287 <sup>7</sup>
						0 986 473 148	← 54	1 987 474 496 <sup>8</sup>
						0 986 474 148	→ 54	1 987 470 287 <sup>7</sup>



		S							
	◀ VW Polo [6N2]								
1.4 16V	01.99-09.01	55			1LY		0986 473 149	↻ ← 54	1987 470 287 <sup>7</sup>
							0986 473 149	↻ ← 54	1987 474 496 <sup>8</sup>
							0986 474 149	↻ → 54	1987 470 287 <sup>7</sup>
	07.99-09.01	74	PR-Code 1LW, PR-Code 1LX		S25		0986 473 148	↻ ← 54	1987 470 287 <sup>7</sup>
							0986 474 148	↻ ← 54	1987 474 496 <sup>8</sup>
			PR-Code 1ZK, PR-Code 1ZE, PR-Code 1ZJ		1LY		0986 473 149	↻ ← 54	1987 470 287 <sup>7</sup>
							0986 473 149	↻ ← 54	1987 474 496 <sup>8</sup>
							0986 474 149	↻ → 54	1987 470 287 <sup>7</sup>
1.6	11.99-09.01	92					0204 102 580	↻ ← 48	0204 104 144 <sup>7</sup>
1.6 16V							0986 134 020	↻	
							0204 102 581	↻ → 48	0204 104 144 <sup>7</sup>
							0204 103 581	↻	
							0986 135 020	↻	
					1LY,S25		0986 473 148	↻ ← 54	1987 470 287 <sup>7</sup>
							0986 473 148	↻ ← 54	1987 474 496 <sup>8</sup>
							0986 474 148	↻ → 54	1987 470 287 <sup>7</sup>
1.7 SDI	10.99-09.01	42/44					0204 102 580	↻ ← 48	0204 104 144 <sup>7</sup>
							0986 134 020	↻	
							0204 102 581	↻ → 48	0204 104 144 <sup>7</sup>
							0204 103 581	↻	
							0986 135 020	↻	
					1LY,S25		0986 473 148	↻ ← 54	1987 470 287 <sup>7</sup>
							0986 473 148	↻ ← 54	1987 474 496 <sup>8</sup>
							0986 474 148	↻ → 54	1987 470 287 <sup>7</sup>
1.9 D	10.99-09.01	47					0204 102 580	↻ ← 48	0204 104 144 <sup>7</sup>
1.9 SDI							0986 134 020	↻	
							0204 102 581	↻ → 48	0204 104 144 <sup>7</sup>
							0204 103 581	↻	
							0986 135 020	↻	
					1LY,S25		0986 473 148	↻ ← 54	1987 470 287 <sup>7</sup>
							0986 473 148	↻ ← 54	1987 474 496 <sup>8</sup>
							0986 474 148	↻ → 54	1987 470 287 <sup>7</sup>
							0986 474 148	↻ → 54	1987 470 287 <sup>7</sup>
	1.0	07.98-09.01	37				0986 475 260	↻ ↔ 17,46	
							0986 475 433	↻ ↔ 19,05	
	1.4, TDI, 16V	09.98-09.01	40/44/55/66				0986 475 260	↻ ↔ 17,46	
							0986 475 433	↻ ↔ 19,05	
	1.4 16V	09.98-09.01	74				0986 475 260	↻ ↔ 17,46	
							0986 475 433	↻ ↔ 19,05	
		07.99-09.01	74				0986 475 290	↻ ↔ 14,29	
	1.7 SDI	10.99-09.01	42/44				0986 475 260	↻ ↔ 17,46	
							0986 475 433	↻ ↔ 19,05	
	1.9 D	10.99-09.01	47				0986 475 260	↻ ↔ 17,46	
	1.9 SDI						0986 475 433	↻ ↔ 19,05	
	1.0	07.98-09.01	37				0986 473 352	↻ ← 33,9	1987 474 496 <sup>8</sup>
							0986 474 352	↻ → 33,9	1987 474 496 <sup>8</sup>
	1.4, TDI, 16V	09.98-09.01	40/44/55/66				0986 473 352	↻ ← 33,9	1987 474 496 <sup>8</sup>
							0986 474 352	↻ → 33,9	1987 474 496 <sup>8</sup>
	1.4 16V	09.98-09.01	74				0986 473 352	↻ ← 33,9	1987 474 496 <sup>8</sup>
							0986 474 352	↻ → 33,9	1987 474 496 <sup>8</sup>
	1.6	11.99-09.01	92				0986 473 352	↻ ← 33,9	1987 474 496 <sup>8</sup>
	1.6 16V						0986 474 352	↻ → 33,9	1987 474 496 <sup>8</sup>
	1.7 SDI	10.99-09.01	42/44				0986 473 352	↻ ← 33,9	1987 474 496 <sup>8</sup>
							0986 474 352	↻ → 33,9	1987 474 496 <sup>8</sup>
	1.9 D	10.99-09.01	47				0986 473 352	↻ ← 33,9	1987 474 496 <sup>8</sup>
	1.9 SDI						0986 474 352	↻ → 33,9	1987 474 496 <sup>8</sup>





	<b>1.0</b>	07.98-09.01	37		SBR	1 987 477 627	↔ 1641	
					TBR	1 987 477 695	↔ 1514	
	<b>1.4</b>	09.98-09.01	40/44/55/ 66		SBR	1 987 477 627	↔ 1641	
					TBR	1 987 477 695	↔ 1514	
	<b>1.4 TDI</b>	10.99-09.01	40/44/55/ 66		SBR	1 987 477 627	↔ 1641	
					TBR	1 987 477 695	↔ 1514	
	<b>1.4 16V</b>	09.98-09.01	74		SBR	1 987 477 627	↔ 1641	
					TBR	1 987 477 695	↔ 1514	
		01.99-09.01	40/44/55/ 66		SBR	1 987 477 627	↔ 1641	
					TBR	1 987 477 695	↔ 1514	
		07.99-09.01	74		STB	1 987 477 695	↔ 1514	
					4SB	1 987 477 627	↔ 1641	
	<b>1.6</b>	11.99-09.01	92			1 987 477 627	↔ 1641	
	<b>1.6 16V</b>	05.00-09.01	92			1 987 477 627	↔ 1641	

	<b>1.0</b>	07.98-09.01	37			0 986 594 009 <sup>4</sup>		
					LAB	0 986 594 001 <sup>3</sup>		
					RAB	0 986 594 000 <sup>3</sup>		
	<b>1.4</b>	09.98-09.01	40/44/55/ 74			0 986 594 009 <sup>4</sup>		
	<b>1.4 TDI</b>				LAB	0 986 594 001 <sup>3</sup>		
	<b>1.4 16V</b>				RAB	0 986 594 000 <sup>3</sup>		
	<b>1.6</b>	11.99-09.01	92			0 986 594 009 <sup>4</sup>		
					LAB	0 986 594 001 <sup>3</sup>		
					RAB	0 986 594 000 <sup>3</sup>		
	<b>1.7 SDI</b>	10.99-09.01	42/44			0 986 594 009 <sup>4</sup>		
					LAB	0 986 594 001 <sup>3</sup>		
					RAB	0 986 594 000 <sup>3</sup>		
	<b>1.9 D</b>	10.99-09.01	47			0 986 594 009 <sup>4</sup>		
	<b>1.9 SDI</b>	10.99-09.01	47		LAB	0 986 594 001 <sup>3</sup>		
					RAB	0 986 594 000 <sup>3</sup>		

**Polo [6R1]**



	<b>1.2</b>	06.09-02.14	44/51/55/ 63/66/77	PR-Code 1LN, PR-Code 1ZC	288	0 986 473 384	☞ ← 53,94	F 026 A06 106 <sup>7</sup>	
	<b>1.2 TDI</b>					0 986 473 384	☞ ← 53,94	1 987 470 506 <sup>8</sup>	
	<b>1.2 TSI</b>					0 986 474 384	☞ → 53,94	F 026 A06 106 <sup>7</sup>	
					PR-Code 1LR, PR-Code 1ZG, PR-Code 1ZJ	252	0 986 473 071	☞ ← 54	1 987 470 506 <sup>8</sup>
					PR-Code 1ZD	288	0 986 474 071	☞ → 54	1 987 470 506 <sup>8</sup>
							0 986 473 384	☞ ← 53,94	F 026 A06 106 <sup>7</sup>
							0 986 473 384	☞ ← 53,94	1 987 470 506 <sup>8</sup>
							0 986 474 384	☞ → 53,94	F 026 A06 106 <sup>7</sup>
	<b>1.4</b>	06.09→	60/63/103	PR-Code 1LN, PR-Code 1ZC	288	0 986 473 384	☞ ← 53,94	F 026 A06 106 <sup>7</sup>	
	<b>1.4 BiFuel</b>						0 986 473 384	☞ ← 53,94	1 987 470 506 <sup>8</sup>
	<b>1.4 TSI ACT</b>						0 986 474 384	☞ → 53,94	F 026 A06 106 <sup>7</sup>
					PR-Code 1LR, PR-Code 1ZG, PR-Code 1ZJ	252	0 986 473 071	☞ ← 54	1 987 470 506 <sup>8</sup>
					PR-Code 1ZD	288	0 986 474 071	☞ → 54	1 987 470 506 <sup>8</sup>
							0 986 473 384	☞ ← 53,94	F 026 A06 106 <sup>7</sup>
							0 986 473 384	☞ ← 53,94	1 987 470 506 <sup>8</sup>
<b>1.4 GTI</b>	05.10-09.12	132	PR-Code 1LN, PR-Code 1ZC			0 986 473 384	☞ ← 53,94	F 026 A06 106 <sup>7</sup>	
						0 986 473 384	☞ ← 53,94	1 987 470 506 <sup>8</sup>	
						0 986 474 384	☞ → 53,94	F 026 A06 106 <sup>7</sup>	





<b>◀ VW Polo [6R1]</b>									
1.4 GTI	05.10-09.12	132	PR-Code 1ZD		0986 473 384	↻ ← 53,94	F 026 A06 106 <sup>7</sup>		
					0986 473 384	↻ ← 53,94	1987 470 506 <sup>8</sup>		
1.4 GTI	09.12-02.14	132			0986 474 384	↻ → 53,94	F 026 A06 106 <sup>7</sup>		
					0986 473 384	↻ ← 53,94	F 026 A06 106 <sup>7</sup>		
1.6 BiFuel	06.09→	55/60/66/77	PR-Code 1LN, PR-Code 1ZC	288	0986 473 384	↻ ← 53,94	F 026 A06 106 <sup>7</sup>		
					0986 473 384	↻ ← 53,94	1987 470 506 <sup>8</sup>		
1.6 TDI			PR-Code 1LR, PR-Code 1ZG, PR-Code 1ZJ	252	0986 474 384	↻ → 53,94	F 026 A06 106 <sup>7</sup>		
					0986 473 071	↻ ← 54	1987 470 506 <sup>8</sup>		
1.6 TDI			PR-Code 1ZD	288	0986 474 071	↻ → 54	1987 470 506 <sup>8</sup>		
					0986 473 384	↻ ← 53,94	F 026 A06 106 <sup>7</sup>		
2.0 WRC	08.13-02.14	162	PR-Code 1ZP, PR-Code 1ZR	BSR	0986 473 384	↻ ← 53,94	F 026 A06 106 <sup>7</sup>		
					0986 473 384	↻ ← 53,94	1987 470 506 <sup>8</sup>		
					0986 474 384	↻ → 53,94	F 026 A06 106 <sup>7</sup>		
	1.2, TDI	06.09-02.14	44/51/55		0986 475 433	↔ 19,05			
	1.4	02.10→	63	PR-Code 1KM	0986 475 433	↔ 19,05			
	1.6 BiFuel, TDI	06.09-02.14	55/60		0986 475 433	↔ 19,05			
	1.6 TDI	02.10→	77	PR-Code 1KM	0986 475 433	↔ 19,05			
	1.2 TSI	06.09-02.14	63/66/77	PR-Code 1KK, PR-Code 1KT, PR-Code 2EJ, PR-Code 1KV			1987 470 040 <sup>7</sup>		
							1987 474 496 <sup>8</sup>		
							1987 470 040 <sup>7</sup>		
							1987 474 496 <sup>8</sup>		
	1.4	06.09→	60/63/103/132	PR-Code 1KK, PR-Code 1KT, PR-Code 2EJ, PR-Code 1KV			1987 470 040 <sup>7</sup>		
	1.4 BiFuel						1987 474 496 <sup>8</sup>		
	1.4 GTI						1987 470 040 <sup>7</sup>		
	1.4 TSI ACT						1987 474 496 <sup>8</sup>		
	1.6 BiFuel	06.09→	55/60/66/77	PR-Code 1KK, PR-Code 1KT, PR-Code 2EJ, PR-Code 1KV			1987 470 040 <sup>7</sup>		
	1.6 TDI						1987 474 496 <sup>8</sup>		
							1987 470 040 <sup>7</sup>		
2.0 WRC	08.13-02.14	162					1987 474 496 <sup>8</sup>		
							1987 470 040 <sup>7</sup>		
							1987 474 496 <sup>8</sup>		
	1.2	06.09-02.14	44/51/55		1987 482 266	↔ 1588			
	1.2 TDI	10.09-02.14	44/51/55		1987 482 266	↔ 1588			
	1.2 TSI	06.09-02.14	63/66/77		1987 482 267	↔ 1642			
	1.4	06.09-02.14	63		1987 482 267	↔ 1642			
		02.10→	63		STB	1987 482 266	↔ 1588		
					4SB	1987 482 267	↔ 1642		
	1.4 BiFuel	03.10-01.11	60		1987 482 267	↔ 1642			
	1.4 GTI	05.10-02.14	103/132		1987 482 267	↔ 1642			
	1.4 TSI ACT	10.12-02.14	103/132		1987 482 267	↔ 1642			
	1.6 BiFuel	01.11-02.14	55/60		STB	1987 482 266	↔ 1588		
					4SB	1987 482 267	↔ 1642		
	1.6 TDI	06.09-02.14	55/60		STB	1987 482 266	↔ 1588		
					4SB	1987 482 267	↔ 1642		
						1987 482 267	↔ 1642		
						1987 482 267	↔ 1642		
						1987 482 267	↔ 1642		
		02.10→	77		STB	1987 482 266	↔ 1588		
				4SB	1987 482 267	↔ 1642			
	1.2, TDI, TSI	06.09-02.14	44/51/55/63/66/77	LAB	0986 594 500 <sup>3</sup>				
					0986 594 502 <sup>4</sup>				

1.2, TDI, TSI	06.09-02.14	44/51/55/ 63/66/77			RAB	0 986 594 501 <sup>3</sup> 0 986 594 503 <sup>4</sup>		
1.4	06.09→	60/63/103/ 132			LAB	0 986 594 500 <sup>3</sup> 0 986 594 502 <sup>4</sup>		
1.4 BiFuel					RAB	0 986 594 501 <sup>3</sup> 0 986 594 503 <sup>4</sup>		
1.4 GTI								
1.4 TSI ACT								
1.6 BiFuel	06.09→	55/60/66/ 77			LAB	0 986 594 500 <sup>3</sup> 0 986 594 502 <sup>4</sup>		
1.6 TDI					RAB	0 986 594 501 <sup>3</sup> 0 986 594 503 <sup>4</sup>		
2.0 WRC	08.13-02.14	162			LAB	0 986 594 500 <sup>3</sup> 0 986 594 502 <sup>4</sup>		
					RAB	0 986 594 501 <sup>3</sup> 0 986 594 503 <sup>4</sup>		

**Polo [9N1]**

1.2	11.01-05.05	40/47				0 204 102 580 0 986 134 020	← 48	0 204 104 144 <sup>7</sup>
						0 204 102 581 0 204 103 581 0 986 135 020	→ 48	0 204 104 144 <sup>7</sup>
				252		0 986 473 071 0 986 474 071	← 54 → 54	1 987 470 506 <sup>8</sup> 1 987 470 506 <sup>8</sup>
1.4	09.01-05.05	55	PR-Code 1LM, PR-Code 1ZN			0 204 102 580 0 986 134 020	← 48	0 204 104 144 <sup>7</sup>
						0 204 102 581 0 204 103 581 0 986 135 020	→ 48	0 204 104 144 <sup>7</sup>
			PR-Code 1LN, PR-Code 1ZH	288		0 986 473 192 0 986 474 192	← 54 → 54	1 987 470 287 <sup>7</sup> 1 987 470 287 <sup>7</sup>
			PR-Code 1LR, PR-Code 1ZG, PR-Code 1ZJ, PR-Code 1LQ, PR-Code 1ZF	252		0 986 473 071 0 986 474 071	← 54 → 54	1 987 470 506 <sup>8</sup> 1 987 470 506 <sup>8</sup>
1.4	09.01-05.05	63/74				0 204 102 580 0 986 134 020	← 48	0 204 104 144 <sup>7</sup>
1.4 FSI						0 204 102 581 0 204 103 581 0 986 135 020	→ 48	0 204 104 144 <sup>7</sup>
				252		0 986 473 071 0 986 474 071	← 54 → 54	1 987 470 506 <sup>8</sup> 1 987 470 506 <sup>8</sup>
				288		0 986 473 192 0 986 474 192	← 54 → 54	1 987 470 287 <sup>7</sup> 1 987 470 287 <sup>7</sup>
1.4 TDI	09.01-06.05	55				0 204 102 580 0 986 134 020	← 48	0 204 104 144 <sup>7</sup>
						0 204 102 581 0 204 103 581 0 986 135 020	→ 48	0 204 104 144 <sup>7</sup>
				252		0 986 473 071 0 986 474 071	← 54 → 54	1 987 470 506 <sup>8</sup> 1 987 470 506 <sup>8</sup>
1.9 SDI	09.01-05.05	47				0 204 102 580 0 986 134 020	← 48	0 204 104 144 <sup>7</sup>
						0 204 102 581 0 204 103 581 0 986 135 020	→ 48	0 204 104 144 <sup>7</sup>
				252		0 986 473 071 0 986 474 071	← 54 → 54	1 987 470 506 <sup>8</sup> 1 987 470 506 <sup>8</sup>
1.9 TDI	09.01-05.05	74/96				0 986 473 071 0 986 474 071	← 54 → 54	1 987 470 506 <sup>8</sup> 1 987 470 506 <sup>8</sup>
				288		0 986 473 192 0 986 474 192	← 54 → 54	1 987 470 287 <sup>7</sup> 1 987 470 287 <sup>7</sup>



◀ VW Polo [9N1]									
	1.2	11.01-05.05	40/47			0986 475 260	↔ 17,46		
	1.4 FSI, TDI	09.01-06.05	55/63/74			0986 475 260	↔ 17,46		
	1.9 SDI, TDI	09.01-05.05	47/74/96			0986 475 260	↔ 17,46		
	1.2	11.01-05.04	47			0986 473 180	↔ 34	1987 474 496 <sup>8</sup>	
						0986 474 180	↔ 34	1987 474 496 <sup>8</sup>	
		11.04-05.05	47			0986 473 180	↔ 34	1987 474 496 <sup>8</sup>	
						0986 474 180	↔ 34	1987 474 496 <sup>8</sup>	
	1.4	09.01-01.02	55	PR-Code 1KK			0986 474 099	↔ 38,1	1987 474 496 <sup>8</sup>
		09.01-04.05	74				0986 473 180	↔ 34	1987 474 496 <sup>8</sup>
						0986 474 180	↔ 34	1987 474 496 <sup>8</sup>	
		09.01-05.05	55	PR-Code 1KD, PR-Code 1KS, PR-Code 2EJ PR-Code 1KK			0986 473 180	↔ 34	1987 474 496 <sup>8</sup>
						0986 474 180	↔ 34	1987 474 496 <sup>8</sup>	
						0986 473 099	↔ 38,1	1987 470 040 <sup>7</sup>	
						0986 473 099	↔ 38,1	1987 474 496 <sup>8</sup>	
						0986 474 099	↔ 38,1	1987 470 040 <sup>7</sup>	
	1.4 FSI	09.01-05.05	63		232		0986 473 180	↔ 34	1987 474 496 <sup>8</sup>
							0986 474 180	↔ 34	1987 474 496 <sup>8</sup>
	1.4 TDI	09.01-06.05	55				0986 473 180	↔ 34	1987 474 496 <sup>8</sup>
						0986 474 180	↔ 34	1987 474 496 <sup>8</sup>	
1.9 SDI	09.01-05.05	47/74/96				0986 473 180	↔ 34	1987 474 496 <sup>8</sup>	
1.9 TDI						0986 474 180	↔ 34	1987 474 496 <sup>8</sup>	
	1.2	11.01-05.05	40/47	SSZ,STB	1987 482 446	↔ 1580			
				SSZ,STB	1987 477 806	↔ 1580			
				4SB,SSZ	1987 482 191	↔ 1645			
				4SB,SSZ	1987 477 807	↔ 1640			
	1.4	09.01-05.05	55/63/74	SSZ,STB	1987 482 446	↔ 1580			
				SSZ,STB	1987 477 806	↔ 1580			
				4SB,SSZ	1987 482 191	↔ 1645			
					4SB,SSZ	1987 477 807	↔ 1640		
	1.4 FSI	09.01-05.05	55/63/74	SSZ,STB	1987 482 446	↔ 1580			
				SSZ,STB	1987 477 806	↔ 1580			
				4SB,SSZ	1987 482 191	↔ 1645			
					4SB,SSZ	1987 477 807	↔ 1640		
	1.4 TDI	09.01-06.05	55/63/74	SSZ,STB	1987 482 446	↔ 1580			
				SSZ,STB	1987 477 806	↔ 1580			
				4SB,SSZ	1987 482 191	↔ 1645			
					4SB,SSZ	1987 477 807	↔ 1640		
	1.9 SDI	09.01-05.05	47/74/96	SSZ,STB	1987 482 446	↔ 1580			
				SSZ,STB	1987 477 806	↔ 1580			
				4SB,SSZ	1987 482 191	↔ 1645			
					4SB,SSZ	1987 477 807	↔ 1640		
	1.9 TDI	09.01-05.05	47/74/96	SSZ,STB	1987 482 446	↔ 1580			
				SSZ,STB	1987 477 806	↔ 1580			
				4SB,SSZ	1987 482 191	↔ 1645			
				4SB,SSZ	1987 477 807	↔ 1640			
	1.2	11.01-05.05	40/47	LAB	0986 594 500 <sup>3</sup>				
					0986 594 502 <sup>4</sup>				
				RAB	0986 594 501 <sup>3</sup>				
					0986 594 503 <sup>4</sup>				
	1.4	09.01-06.05	55/63/74	LAB	0986 594 500 <sup>3</sup>				
					0986 594 502 <sup>4</sup>				
	1.4 FSI			RAB	0986 594 501 <sup>3</sup>				
	1.4 TDI				0986 594 503 <sup>4</sup>				
	1.9 SDI	09.01-05.05	47/74/96	LAB	0986 594 500 <sup>3</sup>				
					0986 594 502 <sup>4</sup>				
1.9 TDI									

		S							
1.9 SDI		09.01-05.05	47/74/96			RAB	0 986 594 501 <sup>3</sup>		
1.9 TDI							0 986 594 503 <sup>4</sup>		
<b>Polo [9N2]</b>									
	1.4	07.03-05.07	55/63/74	PR-Code 1ZG	252		0 986 473 071	← 54	1 987 470 506 <sup>8</sup>
	1.4 TDI						0 986 474 071	→ 54	1 987 470 506 <sup>8</sup>
	1.9 SDI	07.03-05.07	47/74	PR-Code 1ZG	252		0 986 473 071	← 54	1 987 470 506 <sup>8</sup>
	1.9 TDI						0 986 474 071	→ 54	1 987 470 506 <sup>8</sup>
	2.0	07.03-05.07	85	PR-Code 1LN, PR-Code 1ZH	288		0 986 473 192	← 54	1 987 470 287 <sup>7</sup>
							0 986 474 192	→ 54	1 987 470 287 <sup>7</sup>
	1.4	07.03-05.07	55				0 986 475 260	↔ 17,46	
	1.4 TDI						0 986 475 433	↔ 19,05	
	1.9 SDI	11.03-05.07	47				0 986 475 260	↔ 17,46	
	1.4	11.03-05.07	63/74	PR-Code 1KS			0 986 473 180	← 34	1 987 474 496 <sup>8</sup>
							0 986 474 180	→ 34	1 987 474 496 <sup>8</sup>
	1.9 TDI	07.03-05.07	74	PR-Code 1KS			0 986 473 180	← 34	1 987 474 496 <sup>8</sup>
							0 986 474 180	→ 34	1 987 474 496 <sup>8</sup>
	2.0	07.03-05.07	85	PR-Code 1KK, PR-Code 1KT			0 986 473 099	← 38,1	1 987 470 040 <sup>7</sup>
							0 986 473 099	← 38,1	1 987 474 496 <sup>8</sup>
							0 986 474 099	→ 38,1	1 987 470 040 <sup>7</sup>
	1.4	07.03-05.07	55				1 987 482 446	↔ 1580	
		11.03-05.07	63/74				1 987 482 191	↔ 1645	
	1.4 TDI	07.03-05.07	55				1 987 482 446	↔ 1580	
	1.9 SDI	11.03-05.07	47				1 987 482 446	↔ 1580	
	1.9 TDI	07.03-05.07	74				1 987 482 191	↔ 1645	
	2.0	07.03-05.07	85				1 987 482 191	↔ 1645	
	1.4	07.03-05.07	55/63/74			LAB	0 986 594 500 <sup>3</sup>		
	1.4 TDI						0 986 594 502 <sup>4</sup>		
						RAB	0 986 594 501 <sup>3</sup>		
							0 986 594 503 <sup>4</sup>		
	1.9 SDI	07.03-05.07	47/74			LAB	0 986 594 500 <sup>3</sup>		
	1.9 TDI						0 986 594 502 <sup>4</sup>		
						RAB	0 986 594 501 <sup>3</sup>		
							0 986 594 503 <sup>4</sup>		
	2.0	07.03-05.07	85			LAB	0 986 594 500 <sup>3</sup>		
							0 986 594 502 <sup>4</sup>		
						RAB	0 986 594 501 <sup>3</sup>		
							0 986 594 503 <sup>4</sup>		
<b>Polo [9N3]</b>									
	1.2	04.05-12.09	40/44/47/51				0 204 102 580	← 48	0 204 104 144 <sup>7</sup>
							0 986 134 020		
							0 204 102 581	→ 48	0 204 104 144 <sup>7</sup>
							0 204 103 581		
							0 986 135 020		
					252		0 986 473 071	← 54	1 987 470 506 <sup>8</sup>
							0 986 474 071	→ 54	1 987 470 506 <sup>8</sup>
	1.4	04.05-07.07	55				0 986 473 071	← 54	1 987 470 506 <sup>8</sup>
							0 986 474 071	→ 54	1 987 470 506 <sup>8</sup>
	1.4, FSI, i	04.05-04.10	62/63/74		252		0 986 473 071	← 54	1 987 470 506 <sup>8</sup>
							0 986 474 071	→ 54	1 987 470 506 <sup>8</sup>



		S							
	◀ VW Polo [9N3]								
1.4, FSI, i	04.05-04.10	62/63/74	PR-Code 1LN, PR-Code 1ZH	288,BSR	0986 473 192		← 54	1987 470 287 <sup>7</sup>	
			PR-Code 1ZD	288,BSR	0986 474 192		→ 54	1987 470 287 <sup>7</sup>	
1.4	04.05-12.09	58/59			0204 102 580		← 48	0204 104 144 <sup>7</sup>	
1.4 TDI					0986 134 020				
					0204 102 581		→ 48	0204 104 144 <sup>7</sup>	
					0204 103 581				
				252	0986 473 071		← 54	1987 470 506 <sup>8</sup>	
					0986 474 071		→ 54	1987 470 506 <sup>8</sup>	
1.4 TDI	04.05-12.09	51			0204 102 580		← 48	0204 104 144 <sup>7</sup>	
					0986 134 020				
					0204 102 581		→ 48	0204 104 144 <sup>7</sup>	
					0204 103 581				
				252	0986 473 071		← 54	1987 470 506 <sup>8</sup>	
					0986 474 071		→ 54	1987 470 506 <sup>8</sup>	
1.6	06.05→	74/77		252	0986 473 071		← 54	1987 470 506 <sup>8</sup>	
1.6 i					0986 474 071		→ 54	1987 470 506 <sup>8</sup>	
			PR-Code 1LN, PR-Code 1ZH	288,BSR	0986 473 192		← 54	1987 470 287 <sup>7</sup>	
			PR-Code 1ZD	288,BSR	0986 474 192		→ 54	1987 470 287 <sup>7</sup>	
1.8 GTI	09.05-11.09	110		BSR	0986 473 192		← 54	1987 470 287 <sup>7</sup>	
					0986 474 192		→ 54	1987 470 287 <sup>7</sup>	
								1987 470 287 <sup>7</sup>	
	07.06-11.09	132			0986 473 923		← 54	1987 470 506 <sup>8</sup>	
					0986 473 924		→ 54	1987 470 506 <sup>8</sup>	
1.9 SDI	04.05-12.09	47			0204 102 580		← 48	0204 104 144 <sup>7</sup>	
					0986 134 020				
					0204 102 581		→ 48	0204 104 144 <sup>7</sup>	
					0204 103 581				
				252	0986 473 071		← 54	1987 470 506 <sup>8</sup>	
					0986 474 071		→ 54	1987 470 506 <sup>8</sup>	
1.9 TDI	04.05-12.09	74/96		252	0986 473 071		← 54	1987 470 506 <sup>8</sup>	
					0986 474 071		→ 54	1987 470 506 <sup>8</sup>	
			PR-Code 1LN, PR-Code 1ZH	288,BSR	0986 473 192		← 54	1987 470 287 <sup>7</sup>	
			PR-Code 1ZD	288,BSR	0986 474 192		→ 54	1987 470 287 <sup>7</sup>	
								1987 470 287 <sup>7</sup>	
	1.2	04.05-12.09	40/44/47/51		0986 475 260		↔ 17,46		
	1.4	05.06-12.09	59	PR-Code 1KB	0986 475 260		↔ 17,46		
				PR-Code 1KM	0986 475 433		↔ 19,05		
	1.4, FSI, i	04.05-04.10	62/63/74		0986 475 260		↔ 17,46		
	1.4, TDI	04.05-12.09	51/55/58		0986 475 260		↔ 17,46		
	1.4 TDI	10.05-12.09	59		0986 475 260		↔ 17,46		
	1.6, i	06.05→	74/77		0986 475 260		↔ 17,46		
	1.9 SDI, TDI	04.05-12.09	47/74/96		0986 475 260		↔ 17,46		
	1.4	04.05-07.07	55	PR-Code 1KD, PR-Code 1KS, PR-Code 2EJ	0986 473 180		← 34	1987 474 496 <sup>8</sup>	
				PR-Code 1KK	0986 474 180		→ 34	1987 474 496 <sup>8</sup>	
					0986 473 099		← 38,1	1987 470 040 <sup>7</sup>	
					0986 473 099		← 38,1	1987 474 496 <sup>8</sup>	
					0986 474 099		→ 38,1	1987 470 040 <sup>7</sup>	
		05.06-12.09	59	PR-Code 1KD, PR-Code 1KK, PR-Code 1KS, PR-Code 2EJ	0986 473 180		← 34	1987 474 496 <sup>8</sup>	
				PR-Code 1KV	0986 474 180		→ 34	1987 474 496 <sup>8</sup>	
					0986 134 229		←	1987 474 496 <sup>8</sup>	
					0986 135 229		→	1987 474 496 <sup>8</sup>	
	1.4	04.05-05.07	63/74	BSR	0986 473 180		← 34	1987 474 496 <sup>8</sup>	
	1.4 FSI				0986 474 180		→ 34	1987 474 496 <sup>8</sup>	

		S							
<b>1.4</b>		04.05-05.07	63/74			BSR	0 986 134 229		1 987 474 496 <sup>B</sup>
<b>1.4 FSI</b>							0 986 135 229		1 987 474 496 <sup>B</sup>
<b>1.4i</b>		06.06-04.10	62			232	0 986 473 180		1 987 474 496 <sup>B</sup>
							0 986 474 180		1 987 474 496 <sup>B</sup>
<b>1.4 TDI</b>		10.05-12.09	59			BSR	0 986 473 180		1 987 474 496 <sup>B</sup>
							0 986 474 180		1 987 474 496 <sup>B</sup>
						BSR	0 986 134 229		1 987 474 496 <sup>B</sup>
							0 986 135 229		1 987 474 496 <sup>B</sup>
<b>1.6</b>		05.06-12.09	77			BSR	0 986 473 180		1 987 474 496 <sup>B</sup>
							0 986 474 180		1 987 474 496 <sup>B</sup>
						BSR	0 986 134 229		1 987 474 496 <sup>B</sup>
							0 986 135 229		1 987 474 496 <sup>B</sup>
<b>1.8 GTI</b>		09.05-11.09	110/132			BSR	0 986 473 180		1 987 474 496 <sup>B</sup>
							0 986 474 180		1 987 474 496 <sup>B</sup>
						BSR	0 986 134 229		1 987 474 496 <sup>B</sup>
							0 986 135 229		1 987 474 496 <sup>B</sup>
<b>1.9 SDI</b>		04.05-12.09	47/74/96			BSR	0 986 473 180		1 987 474 496 <sup>B</sup>
<b>1.9 TDI</b>							0 986 474 180		1 987 474 496 <sup>B</sup>
						BSR	0 986 134 229		1 987 474 496 <sup>B</sup>
							0 986 135 229		1 987 474 496 <sup>B</sup>
	<b>1.2</b>	04.05-12.09	40/44/47/ 51			SSZ	1 987 482 446		1580
						SSZ	1 987 477 806		1580
	<b>1.4</b>	04.05-05.07	63/74			SSZ	1 987 482 446		1580
						SSZ	1 987 477 806		1580
		04.05-07.07	51/55/58			SSZ	1 987 482 446		1580
						SSZ	1 987 477 806		1580
		05.06-12.09	59			SSZ	1 987 482 446		1580
						SSZ	1 987 477 806		1580
	<b>1.4 FSI</b>	04.05-07.06	63/74			SSZ	1 987 482 446		1580
						SSZ	1 987 477 806		1580
	<b>1.4i</b>	06.06-04.10	62			TW	1 987 477 806		1580
							1 987 477 807		1640
							1 987 482 191		1645
							1 987 482 446		1580
	<b>1.4 TDI</b>	04.05-12.09	51/55/58			SSZ	1 987 482 446		1580
						SSZ	1 987 477 806		1580
		10.05-12.09	59			SSZ,STB	1 987 482 446		1580
						SSZ,STB	1 987 477 806		1580
						4SB,SSZ	1 987 482 191		1645
						4SB,SSZ	1 987 477 807		1640
	<b>1.6</b>	05.06-12.09	77			SSZ,STB	1 987 482 446		1580
						SSZ,STB	1 987 477 806		1580
						4SB,SSZ	1 987 482 191		1645
						4SB,SSZ	1 987 477 807		1640
	<b>1.6i</b>	06.05→	74			TW	1 987 477 806		1580
							1 987 477 807		1640
							1 987 482 191		1645
							1 987 482 446		1580
	<b>1.8 GTI</b>	09.05-11.09	110/132			SSZ,STB	1 987 482 446		1580
						SSZ,STB	1 987 477 806		1580
						4SB,SSZ	1 987 482 191		1645
						4SB,SSZ	1 987 477 807		1640
	<b>1.9 SDI</b>	04.05-12.09	47/74/96			SSZ,STB	1 987 482 446		1580
						SSZ,STB	1 987 477 806		1580
						4SB,SSZ	1 987 482 191		1645
						4SB,SSZ	1 987 477 807		1640
	<b>1.9 TDI</b>	04.05-12.09	47/74/96			SSZ,STB	1 987 482 446		1580
						SSZ,STB	1 987 477 806		1580
						4SB,SSZ	1 987 482 191		1645
						4SB,SSZ	1 987 477 807		1640



		S				?			
◀ VW Polo [9N3]									
	1.2	04.05-12.09	40/44/47/51		LAB		0986 594 500 <sup>3</sup>		
							0986 594 502 <sup>4</sup>		
					RAB		0986 594 501 <sup>3</sup>		
							0986 594 503 <sup>4</sup>		
	1.4	04.05-04.10	51/55/58/		LAB		0986 594 500 <sup>3</sup>		
	1.4 FSI		59/62/63/				0986 594 502 <sup>4</sup>		
	1.4 i		74		RAB		0986 594 501 <sup>3</sup>		
	1.4 TDI						0986 594 503 <sup>4</sup>		
	1.6	06.05→	74/77		LAB		0986 594 500 <sup>3</sup>		
	1.6 i						0986 594 502 <sup>4</sup>		
					RAB		0986 594 501 <sup>3</sup>		
							0986 594 503 <sup>4</sup>		
	1.8 GTI	09.05-11.09	110/132		LAB		0986 594 500 <sup>3</sup>		
							0986 594 502 <sup>4</sup>		
					RAB		0986 594 501 <sup>3</sup>		
							0986 594 503 <sup>4</sup>		
	1.9 SDI	04.05-12.09	47/74/96		LAB		0986 594 500 <sup>3</sup>		
	1.9 TDI						0986 594 502 <sup>4</sup>		
					RAB		0986 594 501 <sup>3</sup>		
							0986 594 503 <sup>4</sup>		
Polo [9N4]									
	1.4 TDI	04.05→	58				0204 102 580	← 48	0204 104 144 <sup>7</sup>
							0986 134 020		
							0204 102 581	→ 48	0204 104 144 <sup>7</sup>
							0204 103 581		
							0986 135 020		
		06.05→	58	Fg.-Nr.9N.6.000 001 >>>	252		0986 473 071	← 54	1987 470 506 <sup>8</sup>
							0986 474 071	→ 54	1987 470 506 <sup>8</sup>
	1.4 TDI	04.05→	58			TW	0986 473 099	← 38,1	1987 470 040 <sup>7</sup>
							0986 473 099	← 38,1	1987 474 496 <sup>8</sup>
							0986 473 180	← 34	1987 474 496 <sup>8</sup>
							0986 474 099	→ 38,1	1987 470 040 <sup>7</sup>
							0986 474 180	→ 34	1987 474 496 <sup>8</sup>
	1.4 TDI	04.05→	58		LAB		0986 594 500 <sup>3</sup>		
							0986 594 502 <sup>4</sup>		
					RAB		0986 594 501 <sup>3</sup>		
							0986 594 503 <sup>4</sup>		
Polo [9V4]									
	1.4 TDI	10.02-12.03	55			252	0986 473 071	← 54	1987 470 506 <sup>8</sup>
							0986 474 071	→ 54	1987 470 506 <sup>8</sup>
	1.4 TDI	10.02-12.03	55			LAB	0986 594 500 <sup>3</sup>		
Polo [80]									
	1.0	10.90-09.94	33				0204 102 373	← 48	
							0204 103 373		























		S							
1.0		10.90-09.94	33				0 204 102 374	→ 48	
							0 204 103 374		
1.3		10.90-09.94	40/56-59				0 204 102 373	← 48	
							0 204 103 373		
							0 204 102 374	→ 48	
							0 204 103 374		
1.4D		10.90-09.94	35				0 204 102 373	← 48	
							0 204 103 373		
							0 204 102 374	→ 48	
							0 204 103 374		
	1.0	10.90-09.94	33		BKR		0 986 475 433	↔ 19,05	
					BKR		0 986 475 438	↔ 15,87	
	1.3	10.90-09.94	40/56-59		BKR		0 986 475 433	↔ 19,05	
					BKR		0 986 475 438	↔ 15,87	
	1.4D	10.90-09.94	35		BKR		0 986 475 433	↔ 19,05	
					BKR		0 986 475 438	↔ 15,87	
	1.0	10.90-09.94	33				1 987 477 042	1594	
							1 987 477 043	633	
	1.3	10.90-09.94	40/56-59				1 987 477 042	1594	
							1 987 477 043	633	
	1.4D	10.90-09.94	35				1 987 477 042	1594	
							1 987 477 043	633	
<b>Scirocco R [138]</b>									
	2.0 TSI	05.14→	188/206	PR-Code 1ZA, PR-Code 1ZE, PR-Code 1ZD, PR-Code 1ZP	288,312		0 986 473 384	← 53,94	F 026 A06 106 <sup>7</sup>
							0 986 473 384	← 53,94	1 987 470 506 <sup>8</sup>
							0 986 474 384	→ 53,94	F 026 A06 106 <sup>7</sup>
				PR-Code 1ZB	312		0 986 473 384	← 53,94	F 026 A06 106 <sup>7</sup>
							0 986 473 384	← 53,94	1 987 470 506 <sup>8</sup>
							0 986 474 384	→ 53,94	F 026 A06 106 <sup>7</sup>
				PR-Code 1ZK			0 986 134 287	←	F 026 A03 545 <sup>7</sup>
							0 986 134 287	←	1 987 470 506 <sup>8</sup>
							0 986 135 287	→	F 026 A03 545 <sup>7</sup>
	2.0 TSI	05.14→	188/206	PR-Code 1KD	D53		0 986 473 381	← 38,1	1 987 470 040 <sup>7</sup>
							0 986 473 381	← 38,1	1 987 474 496 <sup>8</sup>
							0 986 474 381	→ 38,1	1 987 470 040 <sup>7</sup>
				PR-Code 1KS			0 986 134 203	← 38	
							0 986 135 203	→ 38	
				PR-Code 1KW	B31				1 987 474 496 <sup>8</sup>
	2.0 TSI	05.14→	188/206				1 987 477 958	↔ 1447	
	2.0 TSI	05.14→	188/206		FPA,LAB		0 986 594 561 <sup>4</sup>		
					FPA,RAB		0 986 594 560 <sup>4</sup>		
					FPA,LAB		0 986 594 506 <sup>4</sup>		
					FPA,RAB		0 986 594 507 <sup>4</sup>		
					LAB		0 986 594 504 <sup>3</sup>		
					RAB		0 986 594 505 <sup>3</sup>		





◀ VW														
Scirocco [137]														
	1.4 TSI	08.08→	90/118	PR-Code 1ZE, PR-Code 1LJ, PR-Code 1ZP, PR-Code 1ZD	288,312	0986 473 384		53,94	F 026 A06 106 <sup>7</sup>					
						0986 473 384		53,94	1987 470 506 <sup>8</sup>					
						0986 474 384		53,94	F 026 A06 106 <sup>7</sup>					
						PR-Code 1ZK	0986 134 287			F 026 A03 545 <sup>7</sup>				
						0986 134 287			1987 470 506 <sup>8</sup>					
						0986 135 287			F 026 A03 545 <sup>7</sup>					
	2.0 TDI	10.08-11.10	103		PR-Code 1ZK		0986 135 287			1987 470 506 <sup>8</sup>				
							10.08→	103	PR-Code 1ZE, PR-Code 1LJ, PR-Code 1ZP, PR-Code 1ZD	288,312	0986 473 384		53,94	F 026 A06 106 <sup>7</sup>
											0986 473 384		53,94	1987 470 506 <sup>8</sup>
		0986 474 384		53,94	F 026 A06 106 <sup>7</sup>									
		PR-Code 1ZK				0986 134 287			F 026 A03 545 <sup>7</sup>					
						0986 134 287			1987 470 506 <sup>8</sup>					
0986 135 287								F 026 A03 545 <sup>7</sup>						
05.09-11.10		125		PR-Code 1ZE, PR-Code 1LJ, PR-Code 1ZP, PR-Code 1ZD	288,312	0986 474 384		53,94	1987 470 506 <sup>8</sup>					
						05.09-01.13	125	PR-Code 1ZE, PR-Code 1LJ, PR-Code 1ZP, PR-Code 1ZD	288,312	0986 473 384		53,94	F 026 A06 106 <sup>7</sup>	
										0986 474 384		53,94	F 026 A06 106 <sup>7</sup>	
0986 134 287				F 026 A03 545 <sup>7</sup>										
0986 135 287				1987 470 506 <sup>8</sup>										
11.10-01.13		125		PR-Code 1ZE, PR-Code 1LJ, PR-Code 1ZP, PR-Code 1ZD	288,312	0986 473 384		53,94	1987 470 506 <sup>8</sup>					
						11.10→	100	PR-Code 1ZE, PR-Code 1LJ, PR-Code 1ZP, PR-Code 1ZD	288,312	0986 473 384		53,94	F 026 A06 106 <sup>7</sup>	
										0986 473 384		53,94	1987 470 506 <sup>8</sup>	
0986 474 384			53,94	F 026 A06 106 <sup>7</sup>										
PR-Code 1ZK						0986 134 287			F 026 A03 545 <sup>7</sup>					
						0986 134 287			1987 470 506 <sup>8</sup>					
	0986 135 287							F 026 A03 545 <sup>7</sup>						
103			PR-Code 1ZK		0986 135 287			F 026 A03 545 <sup>7</sup>						
					01.13→	130	PR-Code 1ZE, PR-Code 1LJ, PR-Code 1ZP, PR-Code 1ZD	288,312	0986 473 384		53,94	F 026 A06 106 <sup>7</sup>		
									0986 473 384		53,94	1987 470 506 <sup>8</sup>		
0986 474 384		53,94	F 026 A06 106 <sup>7</sup>											
PR-Code 1ZK					0986 134 287			F 026 A03 545 <sup>7</sup>						
					0986 134 287			1987 470 506 <sup>8</sup>						
					0986 135 287			F 026 A03 545 <sup>7</sup>						
2.0 TSI	08.08→	147/155		PR-Code 1LJ, PR-Code 1ZA, PR-Code 1ZE, PR-Code 1ZD, PR-Code 1ZP	288,312	0986 473 384		53,94	F 026 A06 106 <sup>7</sup>					
						0986 473 384		53,94	1987 470 506 <sup>8</sup>					
						0986 474 384		53,94	F 026 A06 106 <sup>7</sup>					
						PR-Code 1ZB	312	0986 473 384		53,94	F 026 A06 106 <sup>7</sup>			
								0986 473 384		53,94	1987 470 506 <sup>8</sup>			
								0986 474 384		53,94	F 026 A06 106 <sup>7</sup>			
	PR-Code 1ZK		0986 134 287			F 026 A03 545 <sup>7</sup>								
			0986 134 287			1987 470 506 <sup>8</sup>								
			0986 135 287			F 026 A03 545 <sup>7</sup>								
	11.09→	188/195		PR-Code 1ZE, PR-Code 1LJ, PR-Code 1ZP, PR-Code 1ZD	288,312	0986 473 384		53,94	F 026 A06 106 <sup>7</sup>					
						0986 473 384		53,94	1987 470 506 <sup>8</sup>					
						0986 474 384		53,94	F 026 A06 106 <sup>7</sup>					
PR-Code 1ZK							0986 134 287			F 026 A03 545 <sup>7</sup>				
							0986 134 287			1987 470 506 <sup>8</sup>				
							0986 135 287			F 026 A03 545 <sup>7</sup>				



		S																
2.0 TDI		10.08→	100/103/125/130	PR-Code 1KD	D53		0 986 473 381	↺ ← 38,1	1 987 470 040 <sup>7</sup>									
							0 986 473 381	↻ ← 38,1	1 987 474 496 <sup>8</sup>									
							0 986 474 381	↻ → 38,1	1 987 470 040 <sup>7</sup>									
							PR-Code 1KE	256	0 986 473 448	↺ ← 41	1 987 474 496 <sup>8</sup>							
									0 986 474 448	↻ → 41	1 987 474 496 <sup>8</sup>							
									0 986 134 203	↺ ← 38								
							PR-Code 1KS		0 986 134 203	↺ ← 38								
									0 986 135 203	↻ → 38								
							PR-Code 1KW	B31			1 987 474 496 <sup>8</sup>							
							2.0 TSI		08.08→	147/155	PR-Code 1KD	D53		0 986 473 381	↺ ← 38,1	1 987 470 040 <sup>7</sup>		
0 986 473 381	↻ ← 38,1	1 987 474 496 <sup>8</sup>																
0 986 474 381	↻ → 38,1	1 987 470 040 <sup>7</sup>																
PR-Code 1KE	256	0 986 473 448	↺ ← 41	1 987 474 496 <sup>8</sup>														
		0 986 474 448	↻ → 41	1 987 474 496 <sup>8</sup>														
PR-Code 1KS, PR-Code 1KT		0 986 134 203	↺ ← 38															
		0 986 135 203	↻ → 38															
PR-Code 1KW	B31			1 987 474 496 <sup>8</sup>														
		11.09→	188/195	PR-Code 1KD	D53									0 986 473 381	↺ ← 38,1	1 987 470 040 <sup>7</sup>		
														0 986 473 381	↻ ← 38,1	1 987 474 496 <sup>8</sup>		
							0 986 474 381	↻ → 38,1	1 987 470 040 <sup>7</sup>									
							PR-Code 1KE	256	0 986 473 448	↺ ← 41	1 987 474 496 <sup>8</sup>							
									0 986 474 448	↻ → 41	1 987 474 496 <sup>8</sup>							
							PR-Code 1KS		0 986 134 203	↺ ← 38								
									0 986 135 203	↻ → 38								
							PR-Code 1KW	B31			1 987 474 496 <sup>8</sup>							
																		
									08.08→	90/118				1 987 477 958	↔ 1447			
2.0 TDI	10.08→	100/103/125/130/147/155/188/195	1 987 477 958	↔ 1447														
2.0 TSI	08.08→	100/103/125/130/147/155/188/195	1 987 477 958	↔ 1447														
		08.08→	90/118		LAB		0 986 594 504 <sup>3</sup>											
							0 986 594 506 <sup>4</sup>											
							RAB	0 986 594 505 <sup>3</sup>										
								0 986 594 507 <sup>4</sup>										
							2.0 TDI	08.08→	100/103/125/130/147/155/188/195	LAB		0 986 594 504 <sup>3</sup>						
												0 986 594 506 <sup>4</sup>						
2.0 TSI			RAB		0 986 594 505 <sup>3</sup>													
					0 986 594 507 <sup>4</sup>													
<b>Scirocco [138]</b>																		
																		
		05.14→	90/92/118	PR-Code 1ZA, PR-Code 1ZE, PR-Code 1ZD, PR-Code 1ZP	288,312		0 986 473 384	↺ ← 53,94	F 026 A06 106 <sup>7</sup>									
							0 986 473 384	↻ ← 53,94	1 987 470 506 <sup>8</sup>									
							0 986 474 384	↻ → 53,94	F 026 A06 106 <sup>7</sup>									
							PR-Code 1ZB	312	0 986 473 384	↺ ← 53,94	F 026 A06 106 <sup>7</sup>							
									0 986 473 384	↻ ← 53,94	1 987 470 506 <sup>8</sup>							
									0 986 474 384	↻ → 53,94	F 026 A06 106 <sup>7</sup>							
							PR-Code 1ZK		0 986 134 287	↺ ←	F 026 A03 545 <sup>7</sup>							
									0 986 134 287	↻ ←	1 987 470 506 <sup>8</sup>							
									0 986 135 287	↻ →	F 026 A03 545 <sup>7</sup>							
							2.0 TDI		05.14→	110	PR-Code 1ZA, PR-Code 1ZE, PR-Code 1ZD, PR-Code 1ZP	288,312		0 986 473 384	↺ ← 53,94	F 026 A06 106 <sup>7</sup>		
														0 986 473 384	↻ ← 53,94	1 987 470 506 <sup>8</sup>		
														0 986 474 384	↻ → 53,94	F 026 A06 106 <sup>7</sup>		
														PR-Code 1ZB	312	0 986 473 384	↺ ← 53,94	F 026 A06 106 <sup>7</sup>
																0 986 473 384	↻ ← 53,94	1 987 470 506 <sup>8</sup>
														0 986 474 384	↻ → 53,94	F 026 A06 106 <sup>7</sup>		
PR-Code 1ZK		0 986 134 287	↺ ←	F 026 A03 545 <sup>7</sup>														
		0 986 134 287	↻ ←	1 987 470 506 <sup>8</sup>														
		0 986 135 287	↻ →	F 026 A03 545 <sup>7</sup>														



		S												
◀ VW Scirocco [138]														
2.0 TDI	05.14→	132	PR-Code 1ZA, PR-Code 1ZE, PR-Code 1ZD, PR-Code 1ZP	288,312	0986 473 384		←	53,94	F 026 A06 106 <sup>7</sup>					
					0986 473 384		←	53,94	1 987 470 506 <sup>8</sup>					
					0986 474 384		→	53,94	F 026 A06 106 <sup>7</sup>					
					PR-Code 1ZB	312	0986 473 384		←	53,94	F 026 A06 106 <sup>7</sup>			
					0986 473 384		←	53,94	1 987 470 506 <sup>8</sup>					
					0986 474 384		→	53,94	F 026 A06 106 <sup>7</sup>					
					PR-Code 1ZK	0986 134 287		←		1 987 470 506 <sup>8</sup>				
					2.0 TDI	05.14→	132	PR-Code 1ZK	0986 134 287		←		F 026 A03 545 <sup>7</sup>	
					2.0 TSI				0986 135 287		→		1 987 470 506 <sup>8</sup>	
					135/155/ 162	PR-Code 1ZA, PR-Code 1ZE, PR-Code 1ZD, PR-Code 1ZP	288,312	0986 473 384		←	53,94	F 026 A06 106 <sup>7</sup>		
0986 473 384		←	53,94	1 987 470 506 <sup>8</sup>										
0986 474 384		→	53,94	F 026 A06 106 <sup>7</sup>										
PR-Code 1ZB	312	0986 473 384		←				53,94	F 026 A06 106 <sup>7</sup>					
0986 473 384		←	53,94	1 987 470 506 <sup>8</sup>										
0986 474 384		→	53,94	F 026 A06 106 <sup>7</sup>										
PR-Code 1ZK	0986 134 287		←					F 026 A03 545 <sup>7</sup>						
0986 134 287		←		1 987 470 506 <sup>8</sup>										
0986 135 287		→		F 026 A03 545 <sup>7</sup>										
2.0 TSI	05.14→	132	PR-Code 1ZA, PR-Code 1ZE, PR-Code 1ZD, PR-Code 1ZP	288,312				0986 473 384		←	53,94	1 987 470 506 <sup>8</sup>		
					0986 474 384		→	53,94	F 026 A06 106 <sup>7</sup>					
					0986 474 384		→	53,94	1 987 470 506 <sup>8</sup>					
					PR-Code 1ZB	312	0986 473 384		←	53,94	1 987 470 506 <sup>8</sup>			
					0986 474 384		→	53,94	F 026 A06 106 <sup>7</sup>					
					0986 474 384		→	53,94	1 987 470 506 <sup>8</sup>					
					PR-Code 1ZK	0986 135 287		→		F 026 A03 545 <sup>7</sup>				
					<hr/>									
					1.4 TSI	05.14→	90/92/118	PR-Code 1KD	D53	0986 473 381		←	38,1	1 987 470 040 <sup>7</sup>
										0986 473 381		←	38,1	1 987 474 496 <sup>8</sup>
0986 474 381		→	38,1	1 987 470 040 <sup>7</sup>										
PR-Code 1KS	0986 134 203		←	38										
0986 135 203		→	38											
PR-Code 1KW	B31									1 987 474 496 <sup>8</sup>				
2.0 TDI	05.14→	110/132/	PR-Code 1KD	D53						0986 473 381		←	38,1	1 987 470 040 <sup>7</sup>
2.0 TSI		135/155/ 162								0986 473 381		←	38,1	1 987 474 496 <sup>8</sup>
			PR-Code 1KS							0986 474 381		→	38,1	1 987 470 040 <sup>7</sup>
										0986 134 203		←	38	
					0986 135 203		→	38						
			PR-Code 1KW	B31					1 987 474 496 <sup>8</sup>					
<hr/>														
1.4 TSI	05.14→	90/92/118			1987 477 958		↔	1447						
			2.0 TDI	05.14→	110/132/135/155/162			1987 477 958		↔	1447			
			2.0 TSI	05.14→	110/132/135/155/162			1987 477 958		↔	1447			
1.4 TSI	05.14→	90/92/118			FPA,LAB	0986 594 561 <sup>4</sup>								
					FPA,RAB	0986 594 560 <sup>4</sup>								
					FPA,LAB	0986 594 506 <sup>4</sup>								
					FPA,RAB	0986 594 507 <sup>4</sup>								
					LAB	0986 594 504 <sup>3</sup>								
					RAB	0986 594 505 <sup>3</sup>								
			2.0 TDI	05.14→	110/132/			FPA,LAB	0986 594 561 <sup>4</sup>					
			2.0 TSI		135/155/ 162			FPA,RAB	0986 594 560 <sup>4</sup>					
								FPA,LAB	0986 594 506 <sup>4</sup>					
								FPA,RAB	0986 594 507 <sup>4</sup>					
					LAB	0986 594 504 <sup>3</sup>								
					RAB	0986 594 505 <sup>3</sup>								



**Sharan [7M8]**

	1.8 T	11.97-02.00	110			0 986 473 111	↻ ← 56,93	1 987 470 005 <sup>7</sup>
						0 986 473 111	↻ ← 56,93	1 987 470 506 <sup>8</sup>
						0 986 474 111	↻ → 56,93	1 987 470 005 <sup>7</sup>
	1.9 TDI	09.95-02.00	66/81			0 986 473 111	↻ ← 56,93	1 987 470 005 <sup>7</sup>
						0 986 473 111	↻ ← 56,93	1 987 470 506 <sup>8</sup>
						0 986 474 111	↻ → 56,93	1 987 470 005 <sup>7</sup>
	2.0	09.95-02.00	85			0 986 473 111	↻ ← 56,93	1 987 470 005 <sup>7</sup>
						0 986 473 111	↻ ← 56,93	1 987 470 506 <sup>8</sup>
						0 986 474 111	↻ → 56,93	1 987 470 005 <sup>7</sup>
	2.8	09.95-02.00	128			0 986 473 111	↻ ← 56,93	1 987 470 005 <sup>7</sup>
	2.8 syncro					0 986 473 111	↻ ← 56,93	1 987 470 506 <sup>8</sup>
						0 986 474 111	↻ → 56,93	1 987 470 005 <sup>7</sup>

	1.8 T	11.97-02.00	110			0 986 473 846	↻ ← 38	1 987 470 040 <sup>7</sup>
						0 986 473 847	↻ → 38	1 987 470 040 <sup>7</sup>
	1.9 TDI	09.95-02.00	66/81			0 986 473 846	↻ ← 38	1 987 470 040 <sup>7</sup>
						0 986 473 847	↻ → 38	1 987 470 040 <sup>7</sup>
	2.0	09.95-02.00	85			0 986 473 846	↻ ← 38	1 987 470 040 <sup>7</sup>
						0 986 473 847	↻ → 38	1 987 470 040 <sup>7</sup>
	2.8	09.95-02.00	128			0 986 473 846	↻ ← 38	1 987 470 040 <sup>7</sup>
	2.8 syncro					0 986 473 847	↻ → 38	1 987 470 040 <sup>7</sup>

	1.8 T	11.97-02.00	110			1 987 477 630	↔ 1293	
						1 987 477 833	654	
	1.9 TDI	09.95-02.00	66/81			1 987 477 630	↔ 1293	
						1 987 477 833	654	
	2.0	09.95-02.00	85			1 987 477 630	↔ 1293	
						1 987 477 833	654	
	2.8	09.95-02.00	128			1 987 477 630	↔ 1293	
	2.8	09.95-02.00	128			1 987 477 833	654	
	2.8 syncro							
	2.8 syncro	07.96-02.00	128			1 987 477 630	↔ 1293	

























	1.8 T	11.97-02.00	110			0 986 594 010 <sup>3</sup>		
						0 986 594 011 <sup>4</sup>		
	1.9 TDI	09.95-02.00	66/81			0 986 594 010 <sup>3</sup>		
						0 986 594 011 <sup>4</sup>		
	2.0	09.95-02.00	85			0 986 594 010 <sup>3</sup>		
						0 986 594 011 <sup>4</sup>		
	2.8	09.95-02.00	128			0 986 594 010 <sup>3</sup>		
	2.8 syncro					0 986 594 011 <sup>4</sup>		

**Sharan [7M9, 7M6]**

	1.8 T	05.00-03.10	110		1KX	0 986 473 184	↻ ← 57	
						0 986 474 184	↻ → 57	
					288	0 986 473 111	↻ ← 56,93	1 987 470 005 <sup>7</sup>
						0 986 473 111	↻ ← 56,93	1 987 470 506 <sup>8</sup>
						0 986 474 111	↻ → 56,93	1 987 470 005 <sup>7</sup>
					326	0 986 473 259	↻ ← 57	1 987 470 005 <sup>7</sup>
						0 986 474 259	↻ → 57	1 987 470 005 <sup>7</sup>
	1.9 TDI	11.02-03.10	96		1KX	0 986 473 184	↻ ← 57	
						0 986 474 184	↻ → 57	
					326	0 986 473 259	↻ ← 57	1 987 470 005 <sup>7</sup>
						0 986 474 259	↻ → 57	1 987 470 005 <sup>7</sup>



		S							
	◀ VW Sharan [7M9, 7M6]								
1.9 TDI		01.05-06.06	110				0986 473 184		57
							0986 474 184		57
1.9 TDI		04.00-03.10	66/85		1KX		0986 473 184		57
1.9 TDI 4Motion							0986 474 184		57
					288		0986 473 111		56,93
							0986 473 111		56,93
							0986 474 111		56,93
					326		0986 473 259		57
							0986 474 259		57
2.0		05.00-03.10	85		1KX		0986 473 184		57
							0986 474 184		57
					288		0986 473 111		56,93
							0986 473 111		56,93
							0986 474 111		56,93
					326		0986 473 259		57
							0986 474 259		57
2.0 TDI		11.05-03.10	100/103		1KX		0986 473 184		57
							0986 474 184		57
					326		0986 473 259		57
							0986 474 259		57
2.8		05.00-03.10	150		1KX		0986 473 184		57
2.8 4Motion							0986 474 184		57
					326		0986 473 259		57
							0986 474 259		57
	1.8 T	05.00-04.01	110	Fg.-Nr. →7M..1..070 000			0986 473 846		38
							0986 473 846		38
							0986 473 847		38
		05.01-03.10	110	Fg.-Nr. 7M..2..000 001→			0986 473 073		38
							0986 473 073		38
							0986 474 073		38
1.9 TDI		04.00-03.10	66				0986 473 846		38
							0986 473 846		38
							0986 473 847		38
		05.00-03.10	85				0986 473 846		38
							0986 473 846		38
							0986 473 847		38
		11.02-03.10	96				0986 473 846		38
							0986 473 846		38
							0986 473 847		38
		01.05-06.06	110				0986 473 073		38
							0986 473 073		38
							0986 474 073		38
1.9 TDI 4Motion		05.00-03.10	85				0986 473 073		38
							0986 473 073		38
							0986 474 073		38
2.0		05.00-03.10	85/100/				0986 473 846		38
2.0 TDI			103				0986 473 846		38
							0986 473 847		38
2.8		05.00-03.10	150				0986 474 073		38
2.8		05.00-03.10	150				0986 473 073		38
2.8 4Motion							0986 474 073		38
2.8 4Motion		05.00-03.10	150				0986 473 073		38
	1.8 T	05.00-04.01	110	Fg.-Nr. →7M..1..070 000			1987 477 630		1293
		05.00-03.10	110				1987 477 833		654
1.9 TDI		04.00-03.10	66/85/96				1987 477 630		1293
							1987 477 833		654
		01.05-06.06	110				1987 477 833		654
1.9 TDI 4Motion		05.00-03.10	66/85/96				1987 477 833		654

		S							
2.0		05.00-03.10	85/100/103				1 987 477 630	↔ 1293	
2.0, TDI		05.00-03.10	85/100/103				1 987 477 833	654	
2.0 TDI		11.05-03.10	85/100/103				1 987 477 630	↔ 1293	
2.8, 4Motion		05.00-03.10	150				1 987 477 833	654	
<b>Sharan [7N1]</b>									
									
	1.4 TSI	05.10→	110	PR-Code 1LJ	312		0 986 134 323	 ← 57	1 987 470 506 <sup>8</sup>
							0 986 135 323	 → 57	1 987 470 506 <sup>8</sup>
	2.0 TDI	05.10→	85/100/	PR-Code 1LJ	312		0 986 134 323	 ← 57	1 987 470 506 <sup>8</sup>
	2.0 TDI 4Motion		103/125/				0 986 135 323	 → 57	1 987 470 506 <sup>8</sup>
	2.0 TSI		130/147						
									
	1.4 TSI	05.10→	110			FPA,LAB	0 986 594 561 <sup>4</sup>		
						FPA,RAB	0 986 594 560 <sup>4</sup>		
						FPA,LAB	0 986 594 506 <sup>4</sup>		
						FPA,RAB	0 986 594 507 <sup>4</sup>		
						LAB	0 986 594 504 <sup>3</sup>		
						RAB	0 986 594 505 <sup>3</sup>		
	2.0 TDI	05.10→	85/100/			FPA,LAB	0 986 594 561 <sup>4</sup>		
	2.0 TDI 4Motion		103/125/			FPA,RAB	0 986 594 560 <sup>4</sup>		
	2.0 TSI		130/147			FPA,LAB	0 986 594 506 <sup>4</sup>		
						FPA,RAB	0 986 594 507 <sup>4</sup>		
						LAB	0 986 594 504 <sup>3</sup>		
						RAB	0 986 594 505 <sup>3</sup>		
<b>Sharan [7N2]</b>									
									
	1.4 TSI	05.15→	110			FPA,LAB	0 986 594 561 <sup>4</sup>		
						FPA,RAB	0 986 594 560 <sup>4</sup>		
						LAB	0 986 594 504 <sup>3</sup>		
						RAB	0 986 594 505 <sup>3</sup>		
				PR-Code 7Y0, PR-Code 7Y4		FPA,LAB	0 986 594 506 <sup>4</sup>		
						FPA,RAB	0 986 594 507 <sup>4</sup>		
				PR-Code 7Y8, PR-Code 7Y9		FPA,LAB	0 986 594 561 <sup>4</sup>		
						FPA,RAB	0 986 594 560 <sup>4</sup>		
	2.0 TDI	05.15→	85/110/			FPA,LAB	0 986 594 561 <sup>4</sup>		
	2.0 TDI 4Motion		135/162			FPA,RAB	0 986 594 560 <sup>4</sup>		
	2.0 TSI					LAB	0 986 594 504 <sup>3</sup>		
						RAB	0 986 594 505 <sup>3</sup>		
				PR-Code 7Y0, PR-Code 7Y4		FPA,LAB	0 986 594 506 <sup>4</sup>		
						FPA,RAB	0 986 594 507 <sup>4</sup>		
				PR-Code 7Y8, PR-Code 7Y9		FPA,LAB	0 986 594 561 <sup>4</sup>		
						FPA,RAB	0 986 594 560 <sup>4</sup>		
<b>Taro [7A]</b>									
									
	2.4 D 4x4	04.89-03.97	58-61				0 986 473 067	 ← 42,8	
							0 986 474 067	 → 42,8	
									
	1.8	04.89-09.94	61				0 986 475 876	↔ 22,2	
	2.2 4x4	06.89-07.94	69				0 986 475 876	↔ 22,2	
	2.4 D	04.89-03.97	58-61				0 986 475 876	↔ 22,2	





◀ VW

**Tiguan [5N1]**



	1.4 TSI	11.07-05.11	90/110		0986 134 323	← 57	1987 470 506 <sup>8</sup>
	1.4 TSI 4Motion				0986 135 323	→ 57	1987 470 506 <sup>8</sup>
	2.0 TDI, TDI 4Motion, TFSI 4Motion	11.07-05.11	81/100/103/		0986 134 323	← 57	1987 470 506 <sup>8</sup>
	TSI, TSI 4Motion		120/125/147		0986 135 323	→ 57	1987 470 506 <sup>8</sup>



	1.4 TSI	05.08-05.11	110	LAB	0986 594 504 <sup>3</sup>			
				RAB	0986 594 506 <sup>4</sup>			
					0986 594 505 <sup>3</sup>			
					0986 594 507 <sup>4</sup>			
		08.10-05.11	90	LAB	0986 594 504 <sup>3</sup>			
				RAB	0986 594 506 <sup>4</sup>			
					0986 594 505 <sup>3</sup>			
					0986 594 507 <sup>4</sup>			
	1.4 TSI 4Motion	11.07-11.08	110	LAB	0986 594 504 <sup>3</sup>			
				RAB	0986 594 505 <sup>3</sup>			
					0986 594 505 <sup>4</sup>			
		03.08-05.11	110	LAB	0986 594 504			
				RAB	0986 594 505			
	2.0 TDI	03.08-05.11	103	LAB	0986 594 504 <sup>3</sup>			
				RAB	0986 594 506 <sup>4</sup>			
					0986 594 505 <sup>3</sup>			
					0986 594 507 <sup>4</sup>			
		05.10-05.11	81	LAB	0986 594 504 <sup>3</sup>			
				RAB	0986 594 506 <sup>4</sup>			
					0986 594 505 <sup>3</sup>			
					0986 594 507 <sup>4</sup>			
	2.0 TDI 4Motion	11.07-05.11	100	LAB	0986 594 504			
				RAB	0986 594 505			
				103	LAB	0986 594 504		
					RAB	0986 594 505		
		03.08-05.11	120	LAB	0986 594 504			
				RAB	0986 594 505			
	2.0 TDI 4Motion, TFSI 4Motion, TSI	11.07-05.11	125/147	LAB	0986 594 504			
				RAB	0986 594 505			
	2.0 TSI 4Motion	11.07-11.09	125/147	LAB	0986 594 504 <sup>3</sup>			
					RAB	0986 594 505 <sup>3</sup>		
						0986 594 505 <sup>4</sup>		
						0986 594 507 <sup>4</sup>		
		11.09-05.11	125/147	LAB	0986 594 504			
				RAB	0986 594 505			

**Tiguan [5N2]**



	1.4 TSI	05.11→	90/110/		0986 134 323	← 57	1987 470 506 <sup>8</sup>
	1.4 TSI 4Motion		118		0986 135 323	→ 57	1987 470 506 <sup>8</sup>
	2.0 TDI, TDI 4Motion, TSI 4Motion	05.11→	81/100/103/125/		0986 134 323	← 57	1987 470 506 <sup>8</sup>
			130/132/147/155		0986 135 323	→ 57	1987 470 506 <sup>8</sup>



	1.4 TSI	05.11→	90	FPA,LAB	0986 594 561 <sup>4</sup>		
				FPA,RAB	0986 594 560 <sup>4</sup>		
				FPA,LAB	0986 594 506 <sup>4</sup>		
				FPA,RAB	0986 594 507 <sup>4</sup>		
				LAB	0986 594 504 <sup>3</sup>		
				RAB	0986 594 505 <sup>3</sup>		

	S								
1.4 TSI	05.11→	110/118	FPA,LAB	0 986 594 561 <sup>4</sup>					
			FPA,RAB	0 986 594 560 <sup>4</sup>					
			FPA,LAB	0 986 594 506 <sup>4</sup>					
			FPA,RAB	0 986 594 507 <sup>4</sup>					
			LAB	0 986 594 504 <sup>3</sup>					
			RAB	0 986 594 505 <sup>3</sup>					
1.4 TSI 4Motion	05.11→	110/118	FPA,LAB	0 986 594 524 <sup>4</sup>					
			FPA,RAB	0 986 594 525 <sup>4</sup>					
			FPA,LAB	0 986 594 504 <sup>4</sup>					
			FPA,RAB	0 986 594 505 <sup>4</sup>					
			LAB	0 986 594 504 <sup>3</sup>					
			RAB	0 986 594 505 <sup>3</sup>					
2.0 TDI	05.11→	81	FPA,LAB	0 986 594 561 <sup>4</sup>					
			FPA,RAB	0 986 594 560 <sup>4</sup>					
			FPA,LAB	0 986 594 506 <sup>4</sup>					
			FPA,RAB	0 986 594 507 <sup>4</sup>					
			LAB	0 986 594 504 <sup>3</sup>					
			RAB	0 986 594 505 <sup>3</sup>					
		103	FPA,LAB	0 986 594 561 <sup>4</sup>					
			FPA,RAB	0 986 594 560 <sup>4</sup>					
			FPA,LAB	0 986 594 506 <sup>4</sup>					
			FPA,RAB	0 986 594 507 <sup>4</sup>					
			LAB	0 986 594 504 <sup>3</sup>					
			RAB	0 986 594 505 <sup>3</sup>					
2.0 TDI 4Motion	05.11→	100	FPA,LAB	0 986 594 524 <sup>4</sup>					
			FPA,RAB	0 986 594 525 <sup>4</sup>					
			FPA,LAB	0 986 594 504 <sup>4</sup>					
			FPA,RAB	0 986 594 505 <sup>4</sup>					
			LAB	0 986 594 504 <sup>3</sup>					
			RAB	0 986 594 505 <sup>3</sup>					
		103	FPA,LAB	0 986 594 524 <sup>4</sup>					
			FPA,RAB	0 986 594 525 <sup>4</sup>					
			FPA,LAB	0 986 594 504 <sup>4</sup>					
			FPA,RAB	0 986 594 505 <sup>4</sup>					
			LAB	0 986 594 504 <sup>3</sup>					
			RAB	0 986 594 505 <sup>3</sup>					
125/130/ 132/147/ 155	FPA,LAB	0 986 594 504 <sup>4</sup>							
	FPA,RAB	0 986 594 505 <sup>4</sup>							
	LAB	0 986 594 504 <sup>3</sup>							
RAB	0 986 594 505 <sup>3</sup>								
2.0 TDI 4Motion	05.11→	125/130/132/	FPA,LAB	0 986 594 524 <sup>4</sup>					
2.0 TSI 4Motion		147/155	FPA,RAB	0 986 594 525 <sup>4</sup>					
2.0 TSI 4Motion	05.11→	125/130/ 132/147/ 155	FPA,LAB	0 986 594 504 <sup>4</sup>					
			FPA,RAB	0 986 594 505 <sup>4</sup>					
			LAB	0 986 594 504 <sup>3</sup>					
RAB	0 986 594 505 <sup>3</sup>								































**Touareg [7LA]**

	3.0 TDI	11.04-11.06	165		0 986 134 200	
					0 986 135 200	
	3.2	11.02-11.06	162	PR-Code 1LF	0 986 134 200	
					0 986 135 200	
	4.2	12.02-11.06	228	PR-Code 1LF	0 986 134 200	
					0 986 135 200	
	5.0 TDI	11.02-11.06	230		0 986 134 200	
					0 986 135 200	
	6.0	08.04-11.06	331	PR-Code 1LF	0 986 134 200	
						0 986 135 200





◀ VW Touareg [7LA]								
	2.5 TDI	01.03-11.06	120/128					1987 470 506 <sup>8</sup>
	3.2	11.02-11.06	162	PR-Code 1KE	322			1987 470 506 <sup>8</sup>
	4.2	12.02-11.06	228	PR-Code 1KE	322			1987 470 506 <sup>8</sup>
	6.0	08.04-11.06	331	PR-Code 1KE	322			1987 470 506 <sup>8</sup>
	2.5 TDI	01.03-11.06	120/128			1987 482 018	↔ 1750	
					LLE	1987 482 444	1890	
					RLE	1987 482 187	1630	
	3.0 TDI	11.04-11.06	155/165			1987 482 018	↔ 1750	
					LLE	1987 482 444	1890	
					RLE	1987 482 187	1630	
	3.2	11.02-11.06	162			1987 482 018	↔ 1750	
					LLE	1987 482 444	1890	
					RLE	1987 482 187	1630	
	3.6 FSI	08.05-11.06	206			1987 482 018	↔ 1750	
					LLE	1987 482 444	1890	
					RLE	1987 482 187	1630	
	4.2	12.02-11.06	228/257			1987 482 018	↔ 1750	
	4.2	12.02-11.06	228/257		LLE	1987 482 444	1890	
	4.2 FSI				RLE	1987 482 187	1630	
	4.2 FSI	06.06-11.06	228/257			1987 482 018	↔ 1750	
	5.0 TDI	11.02-11.06	230			1987 482 018	↔ 1750	
					LLE	1987 482 444	1890	
					RLE	1987 482 187	1630	
	6.0	08.04-11.06	331			1987 482 018	↔ 1750	
					LLE	1987 482 444	1890	
					RLE	1987 482 187	1630	
	2.5 TDI	01.03-11.06	120/128		LAB	0986 594 524		
					RAB	0986 594 525		
	3.0 TDI	11.04-11.06	155/165		LAB	0986 594 524		
					RAB	0986 594 525		
	3.2	11.02-11.06	162		LAB	0986 594 524		
					RAB	0986 594 525		
	3.6 FSI	08.05-11.06	206		LAB	0986 594 524		
					RAB	0986 594 525		
	4.2	12.02-11.06	228/257		LAB	0986 594 524		
	4.2 FSI				RAB	0986 594 525		
	5.0 TDI	11.02-11.06	230		LAB	0986 594 524		
					RAB	0986 594 525		
	6.0	08.04-11.06	331		LAB	0986 594 524		
					RAB	0986 594 525		
Touareg [7L6]								
	2.5 TDI	12.06-05.10	120/128			0986 134 200	←	
						0986 135 200	→	
	3.0 TDI	12.06-05.10	155/165/ 176			0986 134 200	←	
						0986 135 200	→	
	3.6 FSI	12.06-05.10	206	PR-Code 1LF		0986 134 200	←	
						0986 135 200	→	
	4.2 FSI	12.06-05.10	257	PR-Code 1LF		0986 134 200	←	
						0986 135 200	→	
	5.0 TDI	12.06-05.10	230/258			0986 134 200	←	
						0986 135 200	→	
	6.0	12.06-05.10	316/331			0986 134 200	←	
						0986 135 200	→	

		S							
									
	2.5 TDI	12.06-05.10	120/128			322			1 987 470 506 <sup>B</sup>
	3.0 TDI	11.07-05.10	155/165/176			322			1 987 470 506 <sup>B</sup>
	3.6 FSI	12.06-05.10	206	PR-Code 1KE		322			1 987 470 506 <sup>B</sup>
	4.2 FSI	12.06-05.10	257	PR-Code 1KE		322			1 987 470 506 <sup>B</sup>
	5.0 TDI	12.06-05.10	230/258			322			1 987 470 506 <sup>B</sup>
	6.0	12.06-05.10	316/331			322			1 987 470 506 <sup>B</sup>
									
	2.5 TDI	12.06-05.10	120/128				1 987 482 018	↔ 1750	
						LLE	1 987 482 444	1890	
						RLE	1 987 482 187	1630	
	3.0 TDI	12.06-05.10	155/165/176				1 987 482 018	↔ 1750	
						LLE	1 987 482 444	1890	
						RLE	1 987 482 187	1630	
	3.6 FSI	12.06-05.10	206				1 987 482 018	↔ 1750	
						LLE	1 987 482 444	1890	
						RLE	1 987 482 187	1630	
	4.2 FSI	12.06-05.10	257				1 987 482 018	↔ 1750	
						LLE	1 987 482 444	1890	
						RLE	1 987 482 187	1630	
	5.0 TDI	12.06-05.10	230/258				1 987 482 018	↔ 1750	
						LLE	1 987 482 444	1890	
						RLE	1 987 482 187	1630	
	6.0	12.06-05.10	316/331				1 987 482 018	↔ 1750	
						LLE	1 987 482 444	1890	
						RLE	1 987 482 187	1630	
	2.5 TDI	12.06-05.10	120/128			LAB	0 986 594 524		
						RAB	0 986 594 525		
	3.0 TDI	12.06-05.10	155/165/176			LAB	0 986 594 524		
						RAB	0 986 594 525		
	3.6 FSI	12.06-05.10	206			LAB	0 986 594 524		
						RAB	0 986 594 525		
	4.2 FSI	12.06-05.10	257			LAB	0 986 594 524		
						RAB	0 986 594 525		
	5.0 TDI	12.06-05.10	230/258			LAB	0 986 594 524		
						RAB	0 986 594 525		
	6.0	12.06-05.10	316/331			LAB	0 986 594 524		
						RAB	0 986 594 525		
<b>Touran [1T1]</b>									
									
	1.4 TSI	02.06-11.06	103				0 986 473 384	 ← 53,94	F 026 A06 106 <sup>7</sup>
							0 986 473 384	 ← 53,94	1 987 470 506 <sup>B</sup>
							0 986 474 384	 → 53,94	F 026 A06 106 <sup>7</sup>
	1.6	02.03-11.06	75/85				0 986 473 384	 ← 53,94	F 026 A06 106 <sup>7</sup>
	1.6 FSI						0 986 473 384	 ← 53,94	1 987 470 506 <sup>B</sup>
							0 986 474 384	 → 53,94	F 026 A06 106 <sup>7</sup>
	1.9 TDI	02.03-11.06	66/74/77				0 986 473 384	 ← 53,94	F 026 A06 106 <sup>7</sup>
							0 986 473 384	 ← 53,94	1 987 470 506 <sup>B</sup>
							0 986 474 384	 → 53,94	F 026 A06 106 <sup>7</sup>
	2.0 EcoFuel	02.03-11.06	80/100/				0 986 473 384	 ← 53,94	F 026 A06 106 <sup>7</sup>
	2.0 FSI		103/110/				0 986 473 384	 ← 53,94	1 987 470 506 <sup>B</sup>
	2.0 TDI		125				0 986 474 384	 → 53,94	F 026 A06 106 <sup>7</sup>
									
	1.4 TSI	02.06-11.06	103				0 986 473 448	 ← 41	1 987 474 496 <sup>B</sup>
							0 986 474 448	 → 41	1 987 474 496 <sup>B</sup>



		S								
	<b>◀ VW Touran [1T1]</b>									
<b>1.6</b>		02.03-11.06	75/85				0986 473 448		◀ 41	1987 474 496 <sup>8</sup>
<b>1.6 FSI</b>							0986 474 448		→ 41	1987 474 496 <sup>8</sup>
<b>1.9 TDI</b>		02.03-11.06	66/74/77				0986 473 448		◀ 41	1987 474 496 <sup>8</sup>
							0986 474 448		→ 41	1987 474 496 <sup>8</sup>
<b>2.0 EcoFuel, FSI, TDI</b>		02.03-11.06	80/100/103/ 110/125				0986 473 448		◀ 41	1987 474 496 <sup>8</sup>
							0986 474 448		→ 41	1987 474 496 <sup>8</sup>
	<b>1.4 TSI</b>	02.06-11.06	103				1987 482 264		↔ 1561	
	<b>1.6</b>	07.03-05.05	75/85				1987 477 942		↔ 1561	
		06.05-01.06	75/85	Fg.-Nr. →1T..6..120 000			1987 477 942		↔ 1561	
		02.06-11.06	75/85	Fg.-Nr. 1T..6..120 001→			1987 482 264		↔ 1561	
	<b>1.6 FSI</b>	02.03-05.05	75/85				1987 477 942		↔ 1561	
		02.05-01.06	75/85	Fg.-Nr. →1T..6..120 000			1987 477 942		↔ 1561	
		02.06-11.06	75/85	Fg.-Nr. 1T..6..120 001→			1987 482 264		↔ 1561	
	<b>1.9 TDI</b>	02.03-05.04	74				1987 477 942		↔ 1561	
		08.03-02.06	77				1987 477 942		↔ 1561	
		06.05-02.06	66				1987 477 942		↔ 1561	
		02.06-11.06	66				1987 482 264		↔ 1561	
			77				1987 482 264		↔ 1561	
	<b>2.0 EcoFuel</b>	02.06-11.06	80				1987 482 326		↔ 1610	
	<b>2.0 FSI</b>	10.03-11.05	110				1987 477 942		↔ 1561	
		11.05-01.06	110	Fg.-Nr. →1T..6..120 000			1987 477 942		↔ 1561	
		02.06-11.06	110	Fg.-Nr. 1T..6..120 001→			1987 482 264		↔ 1561	
	<b>2.0 TDI</b>	02.03-01.06	100/103	Fg.-Nr. →1T..6..120 000			1987 477 942		↔ 1561	
		11.05-01.06	125	Fg.-Nr. →1T..6..120 000			1987 477 942		↔ 1561	
		02.06-11.06	100/103	Fg.-Nr. 1T..6..120 001→			1987 482 264		↔ 1561	
			125	Fg.-Nr. 1T..6..120 001→			1987 482 264		↔ 1561	
		<b>1.4 TSI</b>	02.06-11.06	103		LAB	0986 594 504 <sup>3</sup>			
						RAB	0986 594 506 <sup>4</sup>			
							0986 594 505 <sup>3</sup>			
							0986 594 507 <sup>4</sup>			
	<b>1.6</b>	02.03-11.06	75/85			LAB	0986 594 504 <sup>3</sup>			
	<b>1.6 FSI</b>					RAB	0986 594 506 <sup>4</sup>			
							0986 594 505 <sup>3</sup>			
							0986 594 507 <sup>4</sup>			
	<b>1.9 TDI</b>	02.03-11.06	66/74/77			LAB	0986 594 504 <sup>3</sup>			
						RAB	0986 594 506 <sup>4</sup>			
							0986 594 505 <sup>3</sup>			
							0986 594 507 <sup>4</sup>			
	<b>2.0 EcoFuel</b>	02.03-11.06	80/100/			LAB	0986 594 504 <sup>3</sup>			
	<b>2.0 FSI</b>		103/110/				0986 594 506 <sup>4</sup>			
	<b>2.0 TDI</b>		125			RAB	0986 594 505 <sup>3</sup>			
							0986 594 507 <sup>4</sup>			
<b>Touran [1T2]</b>										
	<b>1.4 TSI</b>	11.06-05.10	103/110/				0986 473 384		◀ 53,94	F 026 A06 106 <sup>7</sup>
	<b>1.4 TSI EcoFuel</b>		125				0986 473 384		◀ 53,94	1987 470 506 <sup>8</sup>
							0986 474 384		→ 53,94	F 026 A06 106 <sup>7</sup>
	<b>1.6</b>	11.06-05.10	75/85				0986 473 384		◀ 53,94	F 026 A06 106 <sup>7</sup>
	<b>1.6 FSI</b>						0986 473 384		◀ 53,94	1987 470 506 <sup>8</sup>
							0986 474 384		→ 53,94	F 026 A06 106 <sup>7</sup>
	<b>1.9 TDI</b>	11.06-05.10	66/77				0986 473 384		◀ 53,94	F 026 A06 106 <sup>7</sup>
							0986 473 384		◀ 53,94	1987 470 506 <sup>8</sup>
							0986 474 384		→ 53,94	F 026 A06 106 <sup>7</sup>
	<b>2.0 EcoFuel</b>	11.06-05.10	80/100/							F 026 A06 106 <sup>7</sup>
	<b>2.0 FSI</b>		103/110/				0986 473 384		◀ 53,94	F 026 A06 106 <sup>7</sup>
	<b>2.0 TDI</b>		125				0986 473 384		◀ 53,94	1987 470 506 <sup>8</sup>
							0986 474 384		→ 53,94	F 026 A06 106 <sup>7</sup>

		S								
	1.4 TSI	11.06-05.10	103/110/				0 986 473 448		← 41	1 987 474 496 <sup>B</sup>
	1.4 TSI EcoFuel		125				0 986 474 448		→ 41	1 987 474 496 <sup>B</sup>
		11.09-05.10	103/110/				0 986 134 203		← 38	
			125				0 986 135 203		→ 38	
	1.6	11.06-05.10	75				0 986 473 448		← 41	1 987 474 496 <sup>B</sup>
							0 986 474 448		→ 41	1 987 474 496 <sup>B</sup>
		11.09-05.10	75				0 986 134 203		← 38	
							0 986 135 203		→ 38	
	1.6 FSI	11.06-01.07	85				0 986 473 448		← 41	1 987 474 496 <sup>B</sup>
							0 986 474 448		→ 41	1 987 474 496 <sup>B</sup>
	1.9 TDI	11.06-05.10	66/77				0 986 473 448		← 41	1 987 474 496 <sup>B</sup>
							0 986 474 448		→ 41	1 987 474 496 <sup>B</sup>
		11.09-05.10	66/77				0 986 134 203		← 38	
							0 986 135 203		→ 38	
	2.0 EcoFuel	11.06-05.10	80/100/				0 986 473 448		← 41	1 987 474 496 <sup>B</sup>
	2.0 TDI		103				0 986 474 448		→ 41	1 987 474 496 <sup>B</sup>
		11.09-05.10	80/100/				0 986 134 203		← 38	
			103				0 986 135 203		→ 38	
	2.0 FSI	11.06-01.07	110				0 986 473 448		← 41	1 987 474 496 <sup>B</sup>
							0 986 474 448		→ 41	1 987 474 496 <sup>B</sup>
	2.0 TDI	11.06-05.10	125				0 986 473 448		← 41	1 987 474 496 <sup>B</sup>
							0 986 474 448		→ 41	1 987 474 496 <sup>B</sup>
		11.09-05.10	125				0 986 134 203		← 38	
							0 986 135 203		→ 38	
	1.4 TSI	11.06-11.08	125	PR-Code 1SA, PR-Code 1SB, PR-Code 1SK, PR-Code 1SL			1 987 482 264		↔ 1561	
		11.06-12.08	103	PR-Code 1SA, PR-Code 1SB, PR-Code 1SK, PR-Code 1SL			1 987 482 264		↔ 1561	
		11.08-05.10	103				1 987 482 264		↔ 1561	
			125				1 987 482 264		↔ 1561	
	1.4 TSI EcoFuel	05.09-05.10	110				1 987 482 326		↔ 1610	
	1.6	11.06-05.10	75	PR-Code 1SA, PR-Code 1SB, PR-Code 1SK, PR-Code 1SL			1 987 482 264		↔ 1561	
	1.6 FSI	11.06-01.07	85				1 987 482 264		↔ 1561	
	1.9 TDI	11.06-05.10	66				1 987 482 264		↔ 1561	
			77	PR-Code 1SA, PR-Code 1SB, PR-Code 1SK, PR-Code 1SL			1 987 482 264		↔ 1561	
	2.0 EcoFuel	11.06-05.10	80				1 987 482 326		↔ 1610	
	2.0 FSI	11.06-01.07	100/103/110/125				1 987 482 264		↔ 1561	
	2.0 TDI	11.06-05.10	100/103/110/125				1 987 482 264		↔ 1561	
	1.4 TSI	11.06-05.10	103/110/		LAB		0 986 594 504 <sup>3</sup>			
	1.4 TSI EcoFuel		125				0 986 594 506 <sup>4</sup>			
					RAB		0 986 594 505 <sup>3</sup>			
							0 986 594 507 <sup>4</sup>			
	1.6	11.06-05.10	75/85		LAB		0 986 594 504 <sup>3</sup>			
	1.6 FSI						0 986 594 506 <sup>4</sup>			
					RAB		0 986 594 505 <sup>3</sup>			
							0 986 594 507 <sup>4</sup>			
	1.9 TDI	11.06-05.10	66/77		LAB		0 986 594 504 <sup>3</sup>			
							0 986 594 506 <sup>4</sup>			
					RAB		0 986 594 505 <sup>3</sup>			
							0 986 594 507 <sup>4</sup>			
	2.0 EcoFuel	11.06-05.10	80/100/		LAB		0 986 594 504 <sup>3</sup>			
	2.0 FSI		103/110/				0 986 594 506 <sup>4</sup>			
	2.0 TDI		125		RAB		0 986 594 505 <sup>3</sup>			
							0 986 594 507 <sup>4</sup>			



		S								
◀ VW										
<b>Touran [1T3]</b>										
	1.2 TSI	05.10→	77							
				0986 473 384		← 53,94	F 026 A06 106 <sup>7</sup>			
				0986 473 384		← 53,94	1987 470 506 <sup>8</sup>			
				0986 474 384		→ 53,94	F 026 A06 106 <sup>7</sup>			
	1.4 TSI	05.10→	103/110/							
	1.4 TSI EcoFuel		125							
				0986 473 384		← 53,94	F 026 A06 106 <sup>7</sup>			
				0986 473 384		← 53,94	1987 470 506 <sup>8</sup>			
				0986 474 384		→ 53,94	F 026 A06 106 <sup>7</sup>			
	1.6 TDI	05.10→	66/77							
				0986 473 384		← 53,94	F 026 A06 106 <sup>7</sup>			
				0986 473 384		← 53,94	1987 470 506 <sup>8</sup>			
				0986 474 384		→ 53,94	F 026 A06 106 <sup>7</sup>			
	2.0 TDI	05.10→	81/103/							
			125/130							
				0986 473 384		← 53,94	F 026 A06 106 <sup>7</sup>			
				0986 473 384		← 53,94	1987 470 506 <sup>8</sup>			
				0986 474 384		→ 53,94	F 026 A06 106 <sup>7</sup>			
	1.2 TSI	05.10→	77							
				0986 134 203		← 38				
				0986 135 203		→ 38				
	1.4 TSI	05.10→	103/110/							
	1.4 TSI EcoFuel		125							
				0986 134 203		← 38				
				0986 135 203		→ 38				
	1.6 TDI	05.10→	66/77							
				0986 134 203		← 38				
				0986 135 203		→ 38				
	2.0 TDI	05.10→	81/103/							
			125/130							
				0986 134 203		← 38				
				0986 135 203		→ 38				
	1.2 TSI	05.10→	77							
				1987 482 264		↔ 1561				
	1.4 TSI	05.10→	103	125						
					1987 482 264		↔ 1561			
		1.4 TSI EcoFuel	05.10→	110						
		1.6 TDI	05.10→	66/77						
	2.0 TDI	05.10→	81/103/125/130							
				1987 482 264		↔ 1561				
	1.2 TSI	05.10→	77	FPA,LAB			0986 594 561 <sup>4</sup>			
				FPA,RAB			0986 594 560 <sup>4</sup>			
				FPA,LAB			0986 594 506 <sup>4</sup>			
				FPA,RAB			0986 594 507 <sup>4</sup>			
				LAB			0986 594 504 <sup>3</sup>			
					RAB			0986 594 505 <sup>3</sup>		
	1.4 TSI	05.10→	103/110/	125	FPA,LAB			0986 594 561 <sup>4</sup>		
					FPA,RAB			0986 594 560 <sup>4</sup>		
					FPA,LAB			0986 594 506 <sup>4</sup>		
					FPA,RAB			0986 594 507 <sup>4</sup>		
					LAB			0986 594 504 <sup>3</sup>		
					RAB			0986 594 505 <sup>3</sup>		
	1.6 TDI	05.10→	66/77		FPA,LAB			0986 594 561 <sup>4</sup>		
					FPA,RAB			0986 594 560 <sup>4</sup>		
					FPA,LAB			0986 594 506 <sup>4</sup>		
					FPA,RAB			0986 594 507 <sup>4</sup>		
					LAB			0986 594 504 <sup>3</sup>		
					RAB			0986 594 505 <sup>3</sup>		
	2.0 TDI	05.10→	81/103/	125/130	FPA,LAB			0986 594 561 <sup>4</sup>		
					FPA,RAB			0986 594 560 <sup>4</sup>		
FPA,LAB							0986 594 506 <sup>4</sup>			
FPA,RAB							0986 594 507 <sup>4</sup>			
LAB							0986 594 504 <sup>3</sup>			
				RAB			0986 594 505 <sup>3</sup>			

			S							
<b>Touuran [1T3]</b>										
	2.0 TDI	04.13→	81					0 986 473 384		← 53,94 F 026 A06 106 <sup>7</sup>
								0 986 473 384		← 53,94 1 987 470 506 <sup>8</sup>
								0 986 474 384		→ 53,94 F 026 A06 106 <sup>7</sup>
	2.0 TDI	04.13→	81					0 986 134 203		← 38
								0 986 135 203		→ 38
	2.0 TDI	04.13→	81					1 987 482 264		↔ 1561
	2.0 TDI	04.13→	81				FPA,LAB	0 986 594 561 <sup>4</sup>		
							FPA,RAB	0 986 594 560 <sup>4</sup>		
							FPA,LAB	0 986 594 506 <sup>4</sup>		
							FPA,RAB	0 986 594 507 <sup>4</sup>		
							LAB	0 986 594 504 <sup>3</sup>		
							RAB	0 986 594 505 <sup>3</sup>		
<b>Transporter T4 [70, 7D]</b>										
	1.9 D	09.90-04.97	45				281	0 986 473 177		← 53,94 1 987 474 496 <sup>8</sup>
								0 986 474 177		→ 53,94 1 987 474 496 <sup>8</sup>
		01.96-04.97	45	Fg.-Nr. 70..T..200 001→, PR-Code LU			284 ATE	0 986 473 361		← 56,93 1 987 470 005 <sup>7</sup>
								0 986 473 361		← 56,93 1 987 470 506 <sup>8</sup>
								0 986 474 361		→ 56,93 1 987 470 005 <sup>7</sup>
				Fg.-Nr. 70..T..200 001→, PR-Code 1LE			284 LUC	0 986 473 806		← 54
								0 986 473 807		→ 54
	1.9 D Turbo	10.92-06.03	50	PR-Code 1LP			281	0 986 473 177		← 53,94 1 987 474 496 <sup>8</sup>
								0 986 474 177		→ 53,94 1 987 474 496 <sup>8</sup>
		01.96-06.03	50	Fg.-Nr. 70..T..200 001→, PR-Code LU			284 ATE	0 986 473 361		← 56,93 1 987 470 005 <sup>7</sup>
								0 986 473 361		← 56,93 1 987 470 506 <sup>8</sup>
								0 986 474 361		→ 56,93 1 987 470 005 <sup>7</sup>
				Fg.-Nr. 70..T..200 001→, PR-Code 1LE			284 LUC	0 986 473 806		← 54
								0 986 473 807		→ 54
	2.0	09.90-06.03	62				281	0 986 473 177		← 53,94 1 987 474 496 <sup>8</sup>
								0 986 474 177		→ 53,94 1 987 474 496 <sup>8</sup>
		01.96-06.03	62	Fg.-Nr. 70..T..200 001→, PR-Code LU			284 ATE	0 986 473 361		← 56,93 1 987 470 005 <sup>7</sup>
								0 986 473 361		← 56,93 1 987 470 506 <sup>8</sup>
								0 986 474 361		→ 56,93 1 987 470 005 <sup>7</sup>
				Fg.-Nr. 70..T..200 001→, PR-Code 1LE			284 LUC	0 986 473 806		← 54
								0 986 473 807		→ 54
	2.4 D	09.90-05.98	57				281	0 986 473 177		← 53,94 1 987 474 496 <sup>8</sup>
								0 986 474 177		→ 53,94 1 987 474 496 <sup>8</sup>
		01.96-05.98	57	Fg.-Nr. 70..T..200 001→, PR-Code LU			284 ATE	0 986 473 361		← 56,93 1 987 470 005 <sup>7</sup>
								0 986 473 361		← 56,93 1 987 470 506 <sup>8</sup>
								0 986 474 361		→ 56,93 1 987 470 005 <sup>7</sup>
				Fg.-Nr. 70..T..200 001→, PR-Code 1LE			284 LUC	0 986 473 806		← 54
								0 986 473 807		→ 54
		05.97-06.03	55	PR-Code 1LE			284 LUC	0 986 473 806		← 54
								0 986 473 807		→ 54
				PR-Code 1LP			281	0 986 473 177		← 53,94 1 987 474 496 <sup>8</sup>
								0 986 474 177		→ 53,94 1 987 474 496 <sup>8</sup>
				PR-Code 1LU			284 ATE	0 986 473 361		← 56,93 1 987 470 005 <sup>7</sup>
								0 986 473 361		← 56,93 1 987 470 506 <sup>8</sup>
								0 986 474 361		→ 56,93 1 987 470 005 <sup>7</sup>



◀ VW Transporter T4 [70, 7D]										
2.4 D Syncro	11.92-12.95	57	Fg.-Nr. →70..T..199 000				0986 473 177	← 53,94	1987 474 496 <sup>8</sup>	
							0986 474 177	→ 53,94	1987 474 496 <sup>8</sup>	
	01.96-09.98	57	Fg.-Nr. 70..T..200 001→						1987 474 496 <sup>8</sup>	
2.5	01.94-10.96	81					0986 473 806	← 54		
							0986 473 807	→ 54		
	08.96-06.03	81				281		0986 473 177	← 53,94	1987 474 496 <sup>8</sup>
								0986 474 177	→ 53,94	1987 474 496 <sup>8</sup>
				PR-Code 1LE	284	LUC		0986 473 806	← 54	
								0986 473 807	→ 54	
				PR-Code 1LU	284	ATE		0986 473 361	← 56,93	1987 470 005 <sup>7</sup>
								0986 473 361	← 56,93	1987 470 506 <sup>8</sup>
								0986 474 361	→ 56,93	1987 470 005 <sup>7</sup>
		85		PR-Code 1LB	1KX			0986 473 184	← 57	
						326		0986 474 184	→ 57	
								0986 473 259	← 57	1987 470 005 <sup>7</sup>
								0986 474 259	→ 57	1987 470 005 <sup>7</sup>
				PR-Code 1LE	284			0986 473 806	← 54	
								0986 473 807	→ 54	
			PR-Code 1LU	284			0986 473 361	← 56,93	1987 470 005 <sup>7</sup>	
							0986 473 361	← 56,93	1987 470 506 <sup>8</sup>	
							0986 474 361	→ 56,93	1987 470 005 <sup>7</sup>	
2.5	05.96-06.03	85	PR-Code 1LP	281					1987 474 496 <sup>8</sup>	
2.5 Syncro										
2.5 Syncro	01.94-12.95	81	Fg.-Nr. →70..T..199 000				0986 473 177	← 53,94	1987 474 496 <sup>8</sup>	
							0986 474 177	→ 53,94	1987 474 496 <sup>8</sup>	
	01.96-10.96	81	Fg.-Nr. 70..T..200 001→						1987 474 496 <sup>8</sup>	
	05.96-05.00	85	Fg.-Nr. →70..1..000 954, PR-Code 1LB		326		0986 473 259	← 57	1987 470 005 <sup>7</sup>	
0986 474 259							→ 57	1987 470 005 <sup>7</sup>		
	05.96-06.03	85	PR-Code 1LE		284	LUC	0986 473 806	← 54		
									0986 473 807	→ 54
			PR-Code 1LU	284	ATE		0986 473 361	← 56,93	1987 470 005 <sup>7</sup>	
							0986 473 361	← 56,93	1987 470 506 <sup>8</sup>	
							0986 474 361	→ 56,93	1987 470 005 <sup>7</sup>	
	06.97-11.01	81	PR-Code 1LE			LUC	0986 473 806	← 54		
									0986 473 807	→ 54
			PR-Code 1LU			ATE	0986 473 361	← 56,93	1987 470 005 <sup>7</sup>	
							0986 473 361	← 56,93	1987 470 506 <sup>8</sup>	
							0986 474 361	→ 56,93	1987 470 005 <sup>7</sup>	
	05.99-12.99	85	PR-Code 1LB		326		0986 473 259	← 57	1987 470 005 <sup>7</sup>	
									0986 474 259	→ 57
			PR-Code 1LU	284	ATE		0986 474 361	→ 56,93	1987 470 506 <sup>8</sup>	
	06.00-06.03	85	Fg.-Nr. 70..1..000 955→, PR-Code 1LB		1KX		0986 473 184	← 57		
									0986 474 184	→ 57
2.5 TDI	01.95-06.03	75					0986 473 177	← 53,94	1987 474 496 <sup>8</sup>	
							0986 474 177	→ 53,94	1987 474 496 <sup>8</sup>	
		05.98-05.00	111	Fg.-Nr. →70..1..000 954, PR-Code 1LB		326		0986 473 259	← 57	1987 470 005 <sup>7</sup>
	0986 474 259							→ 57	1987 470 005 <sup>7</sup>	
		05.98-06.03	65			281		0986 473 177	← 53,94	1987 474 496 <sup>8</sup>
	0986 474 177							→ 53,94	1987 474 496 <sup>8</sup>	
				PR-Code 1LE	284	LUC		0986 473 806	← 54	
								0986 473 807	→ 54	
				PR-Code 1LU	284	ATE		0986 473 361	← 56,93	1987 470 005 <sup>7</sup>
								0986 473 361	← 56,93	1987 470 506 <sup>8</sup>
								0986 474 361	→ 56,93	1987 470 005 <sup>7</sup>
			111	PR-Code 1LE	284	LUC		0986 473 806	← 54	
								0986 473 807	→ 54	
				PR-Code 1LU	284	ATE		0986 473 361	← 56,93	1987 470 005 <sup>7</sup>
								0986 473 361	← 56,93	1987 470 506 <sup>8</sup>
							0986 474 361	→ 56,93	1987 470 005 <sup>7</sup>	
	06.00-09.00	111	Fg.-Nr. 70..1..000 955→, PR-Code 1LB		1KX		0986 473 184	← 57		
									0986 474 184	→ 57
	09.00-06.03	111	PR-Code 1LB		1KX		0986 473 184	← 57		
									0986 474 184	→ 57



2.5 TDI Syncro	03.98-06.03	75	PR-Code 1LB	1KX		0 986 473 184	↔ 57	
						0 986 474 184	↔ 57	
			PR-Code 1LP	281				1 987 474 496 <sup>B</sup>
2.5 TDI	01.95-06.03	75	PR-Code 1LE	284	LUC	0 986 473 806	↔ 54	
2.5 TDI Syncro						0 986 473 807	↔ 54	
			PR-Code 1LU	284	ATE	0 986 473 361	↔ 56,93	1 987 470 005 <sup>7</sup>
						0 986 473 361	↔ 56,93	1 987 470 506 <sup>B</sup>
						0 986 474 361	↔ 56,93	1 987 470 005 <sup>7</sup>
2.8	01.96-05.00	103	PR-Code 1LB	326		0 986 473 259	↔ 57	1 987 470 005 <sup>7</sup>
						0 986 474 259	↔ 57	1 987 470 005 <sup>7</sup>
			PR-Code 1LE	284	LUC	0 986 473 806	↔ 54	
						0 986 473 807	↔ 54	
			PR-Code 1LU	284	ATE	0 986 473 361	↔ 56,93	1 987 470 005 <sup>7</sup>
						0 986 473 361	↔ 56,93	1 987 470 506 <sup>B</sup>
						0 986 474 361	↔ 56,93	1 987 470 005 <sup>7</sup>
	05.00-06.03	150				0 986 473 184	↔ 57	
						0 986 474 184	↔ 57	
	1.9 D	09.90-04.97	45			0 986 475 935	↔ 20,64	
	1.9 D Turbo	10.92-12.95	50	Fg.-Nr. →70..T..199 000		0 986 475 935	↔ 20,64	
	2.0	09.90-12.95	62	Fg.-Nr. →70..T..199 000		0 986 475 935	↔ 20,64	
	2.4 D	05.97-06.03	55			0 986 475 935	↔ 20,64	
	2.4 D, D Syncro	09.90-12.95	57	Fg.-Nr. →70..T..199 000		0 986 475 935	↔ 20,64	
	2.5	01.94-12.95	81	Fg.-Nr. →70..T..199 000		0 986 475 935	↔ 20,64	
		09.95-12.95	81			0 986 475 935	↔ 20,64	
	2.5 Syncro	01.94-12.95	81	Fg.-Nr. →70..T..199 000		0 986 475 935	↔ 20,64	
	2.5 TDI	01.95-12.95	75	Fg.-Nr. →70..T..199 000		0 986 475 935	↔ 20,64	
	1.9 D Turbo	01.96-06.03	50	Fg.-Nr. 70..T..200 001→		0 986 473 073	↔ 38	1 987 470 040 <sup>7</sup>
						0 986 473 073	↔ 38	1 987 474 496 <sup>B</sup>
						0 986 474 073	↔ 38	1 987 470 040 <sup>7</sup>
	2.0	01.96-06.03	62	Fg.-Nr. 70..T..200 001→		0 986 473 073	↔ 38	1 987 470 040 <sup>7</sup>
						0 986 473 073	↔ 38	1 987 474 496 <sup>B</sup>
						0 986 474 073	↔ 38	1 987 470 040 <sup>7</sup>
	2.4 D	05.97-06.03	55			0 986 473 073	↔ 38	1 987 470 040 <sup>7</sup>
						0 986 473 073	↔ 38	1 987 474 496 <sup>B</sup>
						0 986 474 073	↔ 38	1 987 470 040 <sup>7</sup>
	2.4 D	01.96-09.98	57	Fg.-Nr. 70..T..200 001→		0 986 473 073	↔ 38	1 987 470 040 <sup>7</sup>
	2.4 D Syncro					0 986 473 073	↔ 38	1 987 474 496 <sup>B</sup>
						0 986 474 073	↔ 38	1 987 470 040 <sup>7</sup>
	2.5	01.96-10.96	81	Fg.-Nr. 70..T..200 001→		0 986 473 073	↔ 38	1 987 470 040 <sup>7</sup>
		08.96-06.03	81			0 986 474 073	↔ 38	1 987 474 496 <sup>B</sup>
						0 986 473 073	↔ 38	1 987 470 040 <sup>7</sup>
						0 986 474 073	↔ 38	1 987 474 496 <sup>B</sup>
	2.5	01.96-10.96	81	Fg.-Nr. 70..T..200 001→		0 986 474 073	↔ 38	1 987 470 040 <sup>7</sup>
	2.5 Syncro	08.96-06.03	81			0 986 474 073	↔ 38	1 987 470 040 <sup>7</sup>
	2.5	05.96-06.03	85/111			0 986 473 073	↔ 38	1 987 470 040 <sup>7</sup>
	2.5 Syncro					0 986 473 073	↔ 38	1 987 474 496 <sup>B</sup>
	2.5 TDI					0 986 474 073	↔ 38	1 987 470 040 <sup>7</sup>
	2.5 Syncro	01.96-10.96	81	Fg.-Nr. 70..T..200 001→		0 986 473 073	↔ 38	1 987 470 040 <sup>7</sup>
						0 986 473 073	↔ 38	1 987 474 496 <sup>B</sup>
		06.97-11.01	81			0 986 473 073	↔ 38	1 987 470 040 <sup>7</sup>
						0 986 473 073	↔ 38	1 987 474 496 <sup>B</sup>
	2.5 TDI	01.96-06.03	75	Fg.-Nr. 70..T..200 001→		0 986 473 073	↔ 38	1 987 470 040 <sup>7</sup>
						0 986 473 073	↔ 38	1 987 474 496 <sup>B</sup>
						0 986 474 073	↔ 38	1 987 470 040 <sup>7</sup>
		05.98-06.03	65			0 986 473 073	↔ 38	1 987 470 040 <sup>7</sup>
						0 986 473 073	↔ 38	1 987 474 496 <sup>B</sup>
						0 986 474 073	↔ 38	1 987 470 040 <sup>7</sup>





		S								
◀ VW Transporter T4 [70, 7D]										
2.5 TDI		05.99-06.03	75				0986 473 073		◀ 38	1987 470 040 <sup>7</sup>
							0986 473 073		◀ 38	1987 474 496 <sup>8</sup>
							0986 474 073		→ 38	1987 470 040 <sup>7</sup>
2.5 TDI Syncro		03.98-06.03	75				0986 473 073		◀ 38	1987 470 040 <sup>7</sup>
							0986 473 073		◀ 38	1987 474 496 <sup>8</sup>
							0986 474 073		→ 38	1987 470 040 <sup>7</sup>
2.8		01.96-06.03	103/150				0986 473 073		◀ 38	1987 470 040 <sup>7</sup>
							0986 473 073		◀ 38	1987 474 496 <sup>8</sup>
							0986 474 073		→ 38	1987 470 040 <sup>7</sup>
	1.9 D	09.90-04.97	45				1987 477 171		↔ 844	
				1.9 D Turbo	10.92-12.95	50	Fg.-Nr. →70..T..199 000		1987 477 171	
		01.96-06.03	50	Fg.-Nr. 70..T..200 001→		1987 477 707		↔ 953		
2.0		09.90-12.95	62	Fg.-Nr. →70..T..199 000	TBR	1987 477 171		↔ 844		
				01.96-02.97	62	Fg.-Nr. 70..T..200 001→	SBR	1987 477 706		↔ 949
						70..V..120 000				
		03.97-06.03	62	Fg.-Nr. 70..V..120 001→	SBR	1987 477 707		↔ 953		
2.4 D		09.90-12.95	57	Fg.-Nr. →70..T..199 000	TBR	1987 477 171		↔ 844		
				01.96-02.97	57	Fg.-Nr. 70..T..200 001→	SBR	1987 477 706		↔ 949
						70..V..120 000				
		03.97-05.98	57	Fg.-Nr. 70..V..120 001→	SBR	1987 477 707		↔ 953		
		05.97-06.03	55			1987 477 707		↔ 953		
2.4 D Syncro		11.92-12.95	57	Fg.-Nr. →70..T..199 000	TBR	1987 477 171		↔ 844		
				01.96-09.98	57	Fg.-Nr. 70..T..200 001→	SBR	1987 477 706		↔ 949
2.5		01.94-12.95	81	Fg.-Nr. →70..T..199 000	TBR	1987 477 171		↔ 844		
				09.95-12.95	81			1987 477 171		↔ 844
				01.96-10.96	81	Fg.-Nr. 70..T..200 001→	SBR	1987 477 706		↔ 949
				08.96-02.97	81	Fg.-Nr. →70..V..120 000		1987 477 706		↔ 949
					85	Fg.-Nr. →70..V..120 000	SBR	1987 477 706		↔ 949
				03.97-06.03	81	Fg.-Nr. 70..V..120 001→		1987 477 707		↔ 953
					85	Fg.-Nr. 70..V..120 001→	SBR	1987 477 707		↔ 953
				05.99-12.99	85			1987 477 707		↔ 953
								1987 477 707		↔ 953
								TBR	1987 477 171	
2.5 Syncro		01.94-12.95	81	Fg.-Nr. →70..T..199 000	TBR	1987 477 171		↔ 844		
				01.96-10.96	81	Fg.-Nr. 70..T..200 001→	SBR	1987 477 706		↔ 949
				05.96-02.97	85	Fg.-Nr. →70..V..120 000		1987 477 706		↔ 949
				03.97-06.03	85	Fg.-Nr. 70..V..120 001→		1987 477 707		↔ 953
				06.97-11.01	81			1987 477 706		↔ 949
		05.99-06.03	85			1987 477 707		↔ 953		
2.5 TDI		01.95-02.97	75	Fg.-Nr. →70..V..120 000	SBR	1987 477 706		↔ 949		
				01.95-06.03	75		TBR	1987 477 171		↔ 844
				03.97-06.03	75	Fg.-Nr. 70..V..120 001→	SBR	1987 477 707		↔ 953
				05.98-06.03	65		SBR	1987 477 707		↔ 953
							TBR	1987 477 171		↔ 844
							111	SBR	1987 477 707	
				TBR	1987 477 171		↔ 844			
		05.99-06.03	75		SBR	1987 477 707		↔ 953		
2.5 TDI Syncro		03.98-06.03	75			1987 477 707		↔ 953		
2.8		01.96-02.97	103	Fg.-Nr. →70..V..120 000	SBR	1987 477 706		↔ 949		
				01.96-05.00	103		TBR	1987 477 171		↔ 844
				03.97-05.00	103	Fg.-Nr. 70..V..120 001→	SBR	1987 477 707		↔ 953
				05.00-06.03	150			1987 477 707		↔ 953
	1.9 D	09.90-12.95	45/50	Fg.-Nr. →70..T..199 000	MVB	0986 594 013 <sup>4</sup>				
				1.9 D Turbo	09.90-06.03	45/50			0265 006 407 <sup>3</sup>	
						LAB,MVB	0265 006 508 <sup>4</sup>			
						MVB,RAB	0265 006 510 <sup>4</sup>			
		01.96-06.03	45/50	Fg.-Nr. 70..T..200 001→	LAB,MVB	0265 006 408 <sup>4</sup>				
					MVB,RAB	0265 006 409 <sup>4</sup>				

	S							
2.0	09.90-12.95	62	Fg.-Nr. →70..T..199 000	MVB	0 986 594 013 <sup>4</sup>			
	09.90-06.03	62			0 265 006 407 <sup>3</sup>			
				LAB,MVB	0 265 006 508 <sup>4</sup>			
				MVB,RAB	0 265 006 510 <sup>4</sup>			
	01.96-06.03	62	Fg.-Nr. 70..T..200 001→	LAB,MVB	0 265 006 408 <sup>4</sup>			
				MVB,RAB	0 265 006 409 <sup>4</sup>			
2.4 D	05.97-06.03	55			0 265 006 407 <sup>3</sup>			
				LAB,MVB	0 265 006 508 <sup>4</sup>			
				LAB,MVB	0 265 006 408 <sup>4</sup>			
				MVB,RAB	0 265 006 510 <sup>4</sup>			
				MVB,RAB	0 265 006 409 <sup>4</sup>			
2.4 D	09.90-12.95	57	Fg.-Nr. →70..T..199 000	MVB	0 986 594 013 <sup>4</sup>			
	09.90-09.98	57			0 265 006 407 <sup>3</sup>			
				LAB,MVB	0 265 006 508 <sup>4</sup>			
				MVB,RAB	0 265 006 510 <sup>4</sup>			
2.4 D Syncro	01.96-09.98	57	Fg.-Nr. 70..T..200 001→	LAB,MVB	0 265 006 408 <sup>4</sup>			
				MVB,RAB	0 265 006 409 <sup>4</sup>			
2.5	01.94-12.95	81	Fg.-Nr. →70..T..199 000	MVB	0 986 594 013 <sup>4</sup>			
	09.95-12.95	81		MVB	0 986 594 013 <sup>4</sup>			
2.5 Syncro	01.94-06.03	81			0 265 006 407 <sup>3</sup>			
				LAB,MVB	0 265 006 508 <sup>4</sup>			
				MVB,RAB	0 265 006 510 <sup>4</sup>			
	01.96-10.96	81	Fg.-Nr. 70..T..200 001→	LAB,MVB	0 265 006 408 <sup>4</sup>			
				MVB,RAB	0 265 006 409 <sup>4</sup>			
	08.96-06.03	81		LAB,MVB	0 265 006 408 <sup>4</sup>			
				MVB,RAB	0 265 006 409 <sup>4</sup>			
2.5 Syncro	05.96-06.03	85/111			0 265 006 407 <sup>3</sup>			
				LAB,MVB	0 265 006 508 <sup>4</sup>			
				LAB,MVB	0 265 006 408 <sup>4</sup>			
				MVB,RAB	0 265 006 510 <sup>4</sup>			
				MVB,RAB	0 265 006 409 <sup>4</sup>			
2.5 TDI	01.94-12.95	81	Fg.-Nr. →70..T..199 000	MVB	0 986 594 013 <sup>4</sup>			
	01.95-12.95	75	Fg.-Nr. →70..T..199 000	MVB	0 986 594 013 <sup>4</sup>			
2.5 TDI Syncro	01.96-06.03	75	Fg.-Nr. 70..T..200 001→	LAB,MVB	0 265 006 408 <sup>4</sup>			
				MVB,RAB	0 265 006 409 <sup>4</sup>			
					0 265 006 407 <sup>3</sup>			
				LAB,MVB	0 265 006 508 <sup>4</sup>			
				LAB,MVB	0 265 006 408 <sup>4</sup>			
				MVB,RAB	0 265 006 510 <sup>4</sup>			
				MVB,RAB	0 265 006 409 <sup>4</sup>			
		05.98-06.03	65			0 265 006 407 <sup>3</sup>		
					LAB,MVB	0 265 006 508 <sup>4</sup>		
					LAB,MVB	0 265 006 408 <sup>4</sup>		
				MVB,RAB	0 265 006 510 <sup>4</sup>			
				MVB,RAB	0 265 006 409 <sup>4</sup>			
2.5 TDI Syncro	03.98-06.03	75		LAB,MVB	0 265 006 408 <sup>4</sup>			
				MVB,RAB	0 265 006 409 <sup>4</sup>			
2.5 TDI Syncro	01.95-06.03	75			0 265 006 407 <sup>3</sup>			
				LAB,MVB	0 265 006 508 <sup>4</sup>			
				MVB,RAB	0 265 006 510 <sup>4</sup>			
2.8	01.96-06.03	103/150			0 265 006 407 <sup>3</sup>			
				LAB,MVB	0 265 006 508 <sup>4</sup>			
				LAB,MVB	0 265 006 408 <sup>4</sup>			
				MVB,RAB	0 265 006 510 <sup>4</sup>			
				MVB,RAB	0 265 006 409 <sup>4</sup>			



Transporter T5 [7E]								
	2.0, TDI, TDI 4Motion, TSI, TSI 4Motion	09.09→	62/75/84/85/100/ 103/110/132/150		0 986 134 004		← 41	
					0 986 135 004		→ 41	
	2.0	09.09→	62/75/84/85		1 987 477 260		↔ 1303	

<b>◀ VW Transporter T5 [7E]</b>							
	2.0 TDI	09.09→	62/75/84/85		1987 477 260	↔	1303
			100/103		1987 477 260	↔	1303
			132/150		1987 477 260	↔	1303
	2.0 TDI 4Motion	09.09→	100/103	FKR	1987 482 376	↔	1631
				FLR	1987 482 017	↔	2015
			132/150	FKR	1987 482 376	↔	1631
				FLR	1987 482 017	↔	2015
	2.0 TSI	05.11→	132/150		1987 477 260	↔	1303
			07.12→	110		1987 477 260	↔
	2.0 TSI 4Motion	07.11→	132/150	FKR	1987 482 376	↔	1631
				FLR	1987 482 017	↔	2015
	2.0, TDI, TDI 4Motion, TSI, TSI 4Motion	09.09→	62/75/84/85/100/ 103/110/132/150	LAB	0986 594 504		
				RAB	0986 594 505		
<b>Transporter T5 [7F]</b>							
	2.0	09.09→	62/75/84/85/100/ 103/110/132		0986 134 004	↔	41
					0986 135 004	↔	41
	2.0	09.09-05.13	62/75/84/85		1987 477 260	↔	1303
			2.0 TDI	09.09→	62/75/84/85		1987 477 260
100/103		1987 477 260			↔	1303	
132		1987 477 260			↔	1303	
	2.0 TDI 4Motion	09.09→	100/103	FKR	1987 482 376	↔	1631
				FLR	1987 482 017	↔	2015
			132	FKR	1987 482 376	↔	1631
				FLR	1987 482 017	↔	2015
	2.0 TSI	07.12→	110		1987 477 260	↔	1303
	2.0, TDI, TDI 4Motion, TSI	09.09→	62/75/84/85/100/ 103/110/132	LAB	0986 594 504		
				RAB	0986 594 505		
<b>Transporter T5 [7H]</b>							
	1.9 TDI	04.03-11.09	62/63/75/ 77	294	0986 134 004	↔	41
					0986 135 004	↔	41
				322	0986 473 188	↔	44
	2.0	06.03-11.09	85	294	0986 134 004	↔	41
					0986 135 004	↔	41
				322	0986 473 188	↔	44
	2.5 TDI	02.03-11.09	96/120/ 128	294	0986 134 004	↔	41
					0986 135 004	↔	41
				322	0986 473 188	↔	44
	2.5 TDI 4Motion	02.03-11.09	96/120/ 128	294	0986 134 004	↔	41
					0986 135 004	↔	41
				322	0986 473 188	↔	44
	3.2	02.03-06.04	170	294	0986 134 004	↔	41
					0986 135 004	↔	41
				322	0986 473 188	↔	44
	3.2	05.03-11.09	173	294	0986 134 004	↔	41
					0986 135 004	↔	41
				322	0986 473 188	↔	44
	3.2 4Motion	05.03-11.09	173	322	0986 473 188	↔	44
					0986 474 188	↔	44
				294	0986 134 004	↔	41
	3.2 4Motion	07.04-11.09	173		0986 134 004	↔	41
					0986 135 004	↔	41



Engine	Year Range	Power (kW)	PR-Code	Accessories	Part Number	Equivalent	
	04.03-05.06	77	PR-Code OWR		1 987 482 014	↔ 1270	
			PR-Code OWN, PR-Code OWP, PR-Code OWQ, PR-Code OWL, PR-Code OWM		1 987 477 260	↔ 1303	
	04.03-11.09	62/63/75/77	PR-Code OWR		1 987 482 014	↔ 1270	
			PR-Code OWN, PR-Code OWP, PR-Code OWQ, PR-Code OWL, PR-Code OWM		1 987 477 260	↔ 1303	
	06.03-11.09	85	PR-Code OWR		1 987 482 014	↔ 1270	
			PR-Code OWN, PR-Code OWP, PR-Code OWQ, PR-Code OWL, PR-Code OWM		1 987 477 260	↔ 1303	
	02.03-11.09	96	PR-Code OWR		1 987 482 014	↔ 1270	
			PR-Code OWN, PR-Code OWP, PR-Code OWQ, PR-Code OWL, PR-Code OWM		1 987 477 260	↔ 1303	
		128	PR-Code OWR		1 987 482 014	↔ 1270	
			PR-Code OWN, PR-Code OWP, PR-Code OWQ, PR-Code OWL, PR-Code OWM		1 987 477 260	↔ 1303	
		11.03-11.09	120	PR-Code OWR		1 987 482 014	↔ 1270
				PR-Code OWN, PR-Code OWP, PR-Code OWQ, PR-Code OWL, PR-Code OWM		1 987 477 260	↔ 1303
07.04-11.09	96	FKR	PR-Code OWR		1 987 482 014	↔ 1270	
			PR-Code OWN, PR-Code OWP, PR-Code OWQ, PR-Code OWL, PR-Code OWM		1 987 477 260	↔ 1303	
		128	FKR		1 987 482 016	↔ 1650	
			FLR		1 987 482 017	↔ 2015	
02.03-06.04	170	FKR	PR-Code OWR		1 987 482 016	↔ 1650	
			FLR		1 987 482 017	↔ 2015	
	05.03-11.09	173	FKR	PR-Code OWR		1 987 482 016	↔ 1650
				FLR		1 987 482 017	↔ 2015
07.04-11.09	173	FKR	PR-Code OWR		1 987 482 016	↔ 1650	
			FLR		1 987 482 017	↔ 2015	
	04.03-11.09	62/63/75	LAB	0 986 594 504 <sup>3</sup>			
				0 986 594 504 <sup>4</sup>			
			RAB	0 986 594 505 <sup>3</sup>			
				0 986 594 505 <sup>4</sup>			
	77		LAB	0 986 594 524			
				0 986 594 505			
			RAB	0 986 594 505 <sup>3</sup>			
				0 986 594 505 <sup>4</sup>			
	06.03-11.09	85	LAB	0 986 594 504 <sup>3</sup>			
				0 986 594 504 <sup>4</sup>			
			RAB	0 986 594 505 <sup>3</sup>			
				0 986 594 505 <sup>4</sup>			
02.03-11.09	96	LAB	0 986 594 504 <sup>3</sup>				
			0 986 594 504 <sup>4</sup>				
		RAB	0 986 594 505 <sup>3</sup>				
			0 986 594 505 <sup>4</sup>				
	128	LAB	0 986 594 504 <sup>3</sup>				
			0 986 594 504 <sup>4</sup>				
		RAB	0 986 594 505 <sup>3</sup>				
			0 986 594 505 <sup>4</sup>				
11.03-11.09	120	LAB	0 986 594 504 <sup>3</sup>				
			0 986 594 504 <sup>4</sup>				
		RAB	0 986 594 505 <sup>3</sup>				
			0 986 594 505 <sup>4</sup>				
07.04-11.09	96	LAB	0 986 594 504				
			0 986 594 505				
		RAB	0 986 594 504				
			0 986 594 505				
02.03-06.04	170	LAB	0 986 594 504 <sup>3</sup>				
			0 986 594 504 <sup>4</sup>				
		RAB	0 986 594 505 <sup>3</sup>				
			0 986 594 505 <sup>4</sup>				
05.03-11.09	173	LAB	0 986 594 504 <sup>3</sup>				
			0 986 594 504 <sup>4</sup>				
		RAB	0 986 594 505 <sup>3</sup>				
			0 986 594 505 <sup>4</sup>				



		S							
	◀ VW Transporter T5 [7H]								
3.2		05.03-11.09	173			RAB	0986 594 505 <sup>3</sup>		
							0986 594 505 <sup>4</sup>		
3.2 4Motion		07.04-11.09	173			LAB	0986 594 504		
						RAB	0986 594 505		
<b>Transporter T5 [7J]</b>									
	1.9 TDI	04.03-11.09	62/63/75/ 77				0986 134 004		← 41
							0986 135 004		→ 41
	2.0	06.03-11.09	85				0986 134 004		← 41
							0986 135 004		→ 41
	2.5 TDI	04.03-11.09	96/128				0986 134 004		← 41
							0986 135 004		→ 41
	2.5 TDI 4Motion	07.04-11.09	96/128		294		0986 134 004		← 41
							0986 135 004		→ 41
					322		0986 473 188		← 44
							0986 474 188		→ 44
	3.2	02.04-11.09	170				0986 473 188		← 44
							0986 474 188		→ 44
	3.2 4Motion	07.04-11.09	170		294		0986 134 004		← 41
							0986 135 004		→ 41
					322		0986 473 188		← 44
							0986 474 188		→ 44
	1.9 TDI	04.03-05.06	63	PR-Code OE0, PR-Code OE9			1987 482 014		↔ 1270
			77	PR-Code OE0, PR-Code OE9			1987 482 014		↔ 1270
		04.03-11.09	63	PR-Code OE1, PR-Code OE2			1987 477 260		↔ 1303
			77	PR-Code OE1, PR-Code OE2			1987 477 260		↔ 1303
		06.06-11.09	62	PR-Code OE1, PR-Code OE2			1987 477 260		↔ 1303
			75	PR-Code OE1, PR-Code OE2			1987 477 260		↔ 1303
	2.0	06.03-05.06	85	PR-Code OE0, PR-Code OE9			1987 482 014		↔ 1270
		06.03-11.09	85	PR-Code OE1, PR-Code OE2			1987 477 260		↔ 1303
	2.5 TDI	04.03-05.06	96/128	PR-Code OE0, PR-Code OE9			1987 482 014		↔ 1270
		04.03-11.09	96/128	PR-Code OE1, PR-Code OE2			1987 477 260		↔ 1303
	2.5 TDI 4Motion	07.04-11.09	96/128		FKR		1987 482 016		↔ 1650
					FLR		1987 482 015		↔ 2015
	3.2	02.04-05.06	170	PR-Code OE0, PR-Code OE9			1987 482 014		↔ 1270
		02.04-11.09	170	PR-Code OE1, PR-Code OE2			1987 477 260		↔ 1303
	3.2 4Motion	07.04-11.09	170		FKR		1987 482 016		↔ 1650
					FLR		1987 482 015		↔ 2015
	1.9 TDI	04.03-11.09	62/63/75/ 77			LAB	0986 594 504		
						RAB	0986 594 505		
	2.0	06.03-11.09	85			LAB	0986 594 504		
						RAB	0986 594 505		
	2.5 TDI	04.03-11.09	96/128			LAB	0986 594 504		
	2.5 TDI 4Motion					RAB	0986 594 505		
	3.2	02.04-11.09	170			LAB	0986 594 504		
	3.2 4Motion					RAB	0986 594 505		
<b>Transporter T6 [SF]</b>									
	2.0 TDI, TDI 4Motion	04.15→	62/75/103/ 110/132				0986 134 004		← 41
							0986 135 004		→ 41
	2.0 TDI	04.15→	62/75/103/110/132				1987 477 260		↔ 1303
	2.0 TFSI	04.15→	62/75/103/110/132				1987 477 260		↔ 1303

		S								
<b>Transporter T6 [SG]</b>										
	2.0 TDI, TDI 4Motion, TFSI, TFSI 4Motion	04.15→	62/75/103/110/ 132/150					0 986 134 004		← 41
								0 986 135 004		→ 41
	2.0 TDI	04.15→	62/75/103/110/132/150					1 987 477 260		↔ 1303
	2.0 TFSI	04.15→	62/75/103/110/132/150					1 987 477 260		↔ 1303
	2.0 TDI, TDI 4Motion, TFSI, TFSI 4Motion	04.15→	62/75/103/110/ 132/150			LAB		0 986 594 504		
						RAB		0 986 594 505		
<b>up! [121]</b>										
	1.0	08.11→	44/50/55					0 986 473 071		← 54
								0 986 474 071		→ 54
	1.0	08.11→	44/50/55					0 986 475 260		↔ 17,46
	1.0	08.11→	44/50/55	PR-Code 1SA				1 987 482 375		↔ 1518
	1.0	08.11→	44/50/55			LAB		0 986 594 500 <sup>3</sup>		
								0 986 594 502 <sup>4</sup>		
						RAB		0 986 594 501 <sup>3</sup>		
								0 986 594 503 <sup>4</sup>		
<b>Vento</b>										
	2.0i	08.96-12.98	85			1LM				0 204 104 144 <sup>7</sup>
						1LY		0 986 471 669		← 54
								0 986 473 669		
								0 986 472 669		→ 54
								0 986 474 669		
	2.0i	08.96-12.98	85					0 986 474 875		← 38
								0 986 474 876		→ 38
	2.0i	08.96-12.98	85					1 987 477 393		↔ 1616
	2.0i	08.96-12.98	85					0 986 594 003 <sup>4</sup>		
						LAB		0 986 594 001 <sup>3</sup>		
						RAB		0 986 594 000 <sup>3</sup>		



			S							
◀ VW										
Vento [1H2]										
	1.4	11.91-12.97	44	1LM						0 204 104 144 <sup>7</sup>
				1LY	0986 471 669	← 54	1987 470 287 <sup>7</sup>			
					0986 473 669		1987 474 496 <sup>8</sup>			
					0986 472 669	→ 54	1987 470 287 <sup>7</sup>			
					0986 474 669					
				228	0986 473 687	← 54	1987 470 287 <sup>7</sup>			
					0986 473 687	← 54	1987 474 496 <sup>8</sup>			
					0986 474 687	→ 54	1987 470 287 <sup>7</sup>			
				239			0 204 104 144 <sup>7</sup>			
				256	0986 474 880	← 54	1987 470 287 <sup>7</sup>			
					0986 474 879	→ 54	1987 470 287 <sup>7</sup>			
					0986 474 879	→ 54	1987 474 496 <sup>8</sup>			
				288			1987 470 506 <sup>8</sup>			
				1.6	09.92-09.94	55	1LY	0986 472 669	→ 54	1987 474 496 <sup>8</sup>
								0986 474 669		
1LM			0 204 104 144 <sup>7</sup>							
09.92-12.97	55	1LY	0986 471 669		← 54	1987 470 287 <sup>7</sup>				
			0986 473 669			1987 474 496 <sup>8</sup>				
		228	0986 473 687		← 54	1987 470 287 <sup>7</sup>				
	0986 473 687	← 54	1987 474 496 <sup>8</sup>							
	0986 474 687	→ 54	1987 470 287 <sup>7</sup>							
239			0 204 104 144 <sup>7</sup>							
256	0986 474 880	← 54	1987 470 287 <sup>7</sup>							
	0986 474 879	→ 54	1987 470 287 <sup>7</sup>							
	0986 474 879	→ 54	1987 474 496 <sup>8</sup>							
288			1987 470 506 <sup>8</sup>							
10.94-12.97	55	1LY	0986 472 669		→ 54	1987 470 287 <sup>7</sup>				
			0986 474 669							
		1LM			0 204 104 144 <sup>7</sup>					
74	1LY	74	0986 471 669	← 54	1987 470 287 <sup>7</sup>					
			0986 473 669		1987 474 496 <sup>8</sup>					
			0986 472 669	→ 54	1987 470 287 <sup>7</sup>					
		0986 474 669								
	228	0986 473 687	← 54	1987 470 287 <sup>7</sup>						
		0986 473 687	← 54	1987 474 496 <sup>8</sup>						
		0986 474 687	→ 54	1987 470 287 <sup>7</sup>						
	239			0 204 104 144 <sup>7</sup>						
	256	0986 474 880	← 54	1987 470 287 <sup>7</sup>						
		0986 474 879	→ 54	1987 470 287 <sup>7</sup>						
		0986 474 879	→ 54	1987 474 496 <sup>8</sup>						
	288			1987 470 506 <sup>8</sup>						
	05.97-12.97	74	1LY	0986 472 669	→ 54	1987 474 496 <sup>8</sup>				
				0986 474 669						
			1LM			0 204 104 144 <sup>7</sup>				
1.8	11.91-12.97	55/66	1LM			0 204 104 144 <sup>7</sup>				
			1LY	0986 471 669	← 54	1987 470 287 <sup>7</sup>				
				0986 473 669		1987 474 496 <sup>8</sup>				
				0986 472 669	→ 54	1987 470 287 <sup>7</sup>				
				0986 474 669						
			228	0986 473 687	← 54	1987 470 287 <sup>7</sup>				
				0986 473 687	← 54	1987 474 496 <sup>8</sup>				
				0986 474 687	→ 54	1987 470 287 <sup>7</sup>				
			239			0 204 104 144 <sup>7</sup>				
			256	0986 474 880	← 54	1987 470 287 <sup>7</sup>				
				0986 474 879	→ 54	1987 470 287 <sup>7</sup>				
				0986 474 879	→ 54	1987 474 496 <sup>8</sup>				
			288			1987 470 506 <sup>8</sup>				
			1.9D	11.91-12.97	47	1LY	0986 472 669	→ 54	1987 474 496 <sup>8</sup>	
							0986 474 669			
256	0986 474 880	← 54				1987 470 287 <sup>7</sup>				

















		S							
<b>1.9 D</b>		11.91-12.97	47						0 204 104 144 <sup>7</sup>
<b>1.9 SDI</b>									1LM
									1LY
									0 986 471 669 ← 54
									0 986 473 669 ↻
									0 986 472 669 → 54
									0 986 474 669 ↻
									228
									0 986 473 687 ↻ ← 54
									0 986 473 687 ↻ ← 54
									0 986 474 687 ↻ → 54
									239
									0 204 104 144 <sup>7</sup>
									256
									0 986 474 879 ↻ → 54
									0 986 474 879 ↻ → 54
									288
									1 987 470 506 <sup>B</sup>
<b>1.9 SDI</b>		01.95-12.97	47						1LY
									0 986 471 669 ← 54
									0 986 473 669 ↻
									256
									0 986 474 880 ↻ ← 54
<b>1.9 TD</b>		11.91-12.97	55						1LM
									1LY
									0 986 471 669 ← 54
									0 986 473 669 ↻
									0 986 472 669 → 54
									0 986 474 669 ↻
									228
									0 986 473 687 ↻ ← 54
									0 986 473 687 ↻ ← 54
									0 986 474 687 ↻ → 54
									239
									0 204 104 144 <sup>7</sup>
									256
									0 986 474 880 ↻ ← 54
									0 986 474 879 ↻ → 54
									0 986 474 879 ↻ → 54
									288
									1 987 470 506 <sup>B</sup>
<b>1.9 TDI</b>		09.93-12.97	66						1LM
									1LY
									0 986 471 669 ← 54
									0 986 473 669 ↻
									0 986 472 669 → 54
									0 986 474 669 ↻
									228
									0 986 473 687 ↻ ← 54
									0 986 473 687 ↻ ← 54
									0 986 474 687 ↻ → 54
									239
									0 204 104 144 <sup>7</sup>
									256
									0 986 474 880 ↻ ← 54
									0 986 474 879 ↻ → 54
									0 986 474 879 ↻ → 54
									288
									1 987 470 506 <sup>B</sup>
		02.96-12.97	81						1LM
									1LY
									0 986 471 669 ← 54
									0 986 473 669 ↻
									0 986 472 669 → 54
									0 986 474 669 ↻
									228
									0 986 473 687 ↻ ← 54
									0 986 473 687 ↻ ← 54
									0 986 474 687 ↻ → 54
									239
									0 204 104 144 <sup>7</sup>
									256
									0 986 474 880 ↻ ← 54
									0 986 474 879 ↻ → 54
									0 986 474 879 ↻ → 54
									288
									1 987 470 506 <sup>B</sup>
<b>2.0</b>		11.91-09.94	85						1LY
									0 986 472 669 → 54
									0 986 474 669 ↻
		11.91-12.97	85						1LM
									1LY
									0 986 471 669 ← 54
									0 986 473 669 ↻
									228
									0 986 473 687 ↻ ← 54
									0 986 473 687 ↻ ← 54
									0 986 474 687 ↻ → 54
									239
									0 204 104 144 <sup>7</sup>





		S									
	◀ VW Vento [1H2]										
2.0		11.91-12.97	85	256	0986 474 880		← 54	1987 470 287 <sup>7</sup>			
					0986 474 879		→ 54	1987 470 287 <sup>7</sup>			
					0986 474 879		→ 54	1987 474 496 <sup>8</sup>			
		10.94-12.97	79	288	1LM	1LY	0986 471 669		← 54	1987 470 287 <sup>7</sup>	
							0986 473 669			1987 474 496 <sup>8</sup>	
							0986 472 669		→ 54	1987 470 287 <sup>7</sup>	
				228	0986 474 669			0986 473 687		← 54	1987 470 287 <sup>7</sup>
										← 54	1987 474 496 <sup>8</sup>
										→ 54	1987 470 287 <sup>7</sup>
				239	0986 474 687			0986 473 687		← 54	1987 470 287 <sup>7</sup>
										← 54	1987 474 496 <sup>8</sup>
										→ 54	1987 470 287 <sup>7</sup>
				256	0986 474 880		← 54	0986 474 879		→ 54	1987 470 287 <sup>7</sup>
										→ 54	1987 470 287 <sup>7</sup>
										→ 54	1987 474 496 <sup>8</sup>
288	0986 474 879			0986 474 879		→ 54	1987 470 287 <sup>7</sup>				
							1987 470 287 <sup>7</sup>				
							1987 470 287 <sup>7</sup>				
2.8		01.92-12.97	120/128	1LM	1LY	0986 472 669		→ 54	1987 470 287 <sup>7</sup>		
						0986 474 669					
						0204 104 144 <sup>7</sup>					
		228	0986 471 669		← 54	0986 473 669			1987 474 496 <sup>8</sup>		
								→ 54	1987 470 287 <sup>7</sup>		
		239	0986 473 687		← 54	0986 473 687		← 54	1987 470 287 <sup>7</sup>		
								← 54	1987 474 496 <sup>8</sup>		
								→ 54	1987 470 287 <sup>7</sup>		
		256	0986 474 687			0986 474 687		→ 54	1987 470 287 <sup>7</sup>		
									0204 104 144 <sup>7</sup>		
		288	0986 474 880		← 54	0986 474 879		→ 54	1987 470 287 <sup>7</sup>		
								→ 54	1987 470 287 <sup>7</sup>		
								→ 54	1987 474 496 <sup>8</sup>		
288	0986 474 879			0986 474 879		→ 54	1987 470 287 <sup>7</sup>				
							1987 470 287 <sup>7</sup>				
							1987 470 287 <sup>7</sup>				
		11.91-12.97	44	1.4	0986 475 260		↔ 17,46				
					0986 475 433		↔ 19,05				
					0986 475 260		↔ 17,46				
		09.92-12.97	55/74	1.6	0986 475 433		↔ 19,05				
					0986 475 260		↔ 17,46				
					0986 475 433		↔ 19,05				
		11.91-12.97	55/66	1.8	0986 475 260		↔ 17,46				
					0986 475 433		↔ 19,05				
					0986 475 260		↔ 17,46				
		11.91-12.97	47/55/66/ 81	1.9 D, SDI, TDI	0986 475 260		↔ 17,46				
					0986 475 433		↔ 19,05				
					0986 475 260		↔ 17,46				
		11.91-12.97	79/85	2.0	0986 475 433		↔ 19,05				
					0986 475 260		↔ 17,46				
					0986 475 433		↔ 19,05				
01.92-12.97	120/128	2.8	0986 475 260		↔ 17,46						
			0986 475 433		↔ 19,05						
			0986 475 260		↔ 17,46						
		11.91-12.97	44	1.4	0986 474 875		← 38	1987 470 040 <sup>7</sup>			
					0986 474 875		← 38	1987 474 496 <sup>8</sup>			
					0986 474 876		→ 38	1987 470 040 <sup>7</sup>			
		09.92-12.97	55/74	1.6	0986 474 875		← 38	1987 470 040 <sup>7</sup>			
					0986 474 875		← 38	1987 474 496 <sup>8</sup>			
					0986 474 876		→ 38	1987 470 040 <sup>7</sup>			
		11.91-12.97	55/66	1.8	0986 474 875		← 38	1987 470 040 <sup>7</sup>			
					0986 474 875		← 38	1987 474 496 <sup>8</sup>			
					0986 474 876		→ 38	1987 470 040 <sup>7</sup>			
		11.91-12.97	47/55/66/ 81	1.9 D, SDI, TD, TDI	0986 474 875		← 38	1987 470 040 <sup>7</sup>			
					0986 474 875		← 38	1987 474 496 <sup>8</sup>			
					0986 474 876		→ 38	1987 470 040 <sup>7</sup>			
		11.91-12.97	79/85	2.0	0986 474 875		← 38	1987 470 040 <sup>7</sup>			
					0986 474 875		← 38	1987 474 496 <sup>8</sup>			
					0986 474 876		→ 38	1987 470 040 <sup>7</sup>			

		S							
2.8		01.92-12.97	120/128				0 986 474 875	 38	1 987 470 040 <sup>7</sup>
							0 986 474 875	 38	1 987 474 496 <sup>8</sup>
							0 986 474 876	 38	1 987 470 040 <sup>7</sup>
									
	1.4	11.91-07.94	44	Fg.-Nr. →1H..S..037 527	SBR		1 987 477 162	↔ 1613	
					TBR		1 987 477 168	↔ 1500	
		08.94-07.95	44	Fg.-Nr. 1H..S..037 528→	SBR		1 987 477 393	↔ 1616	
					TBR		1 987 477 338	↔ 1498	
		07.95-12.97	44		SBR		1 987 477 393	↔ 1616	
					TBR		1 987 477 338	↔ 1498	
1.6		09.92-07.94	55	Fg.-Nr. →1H..S..037 527	SBR		1 987 477 162	↔ 1613	
					TBR		1 987 477 168	↔ 1500	
		08.94-09.94	55	Fg.-Nr. 1H..S..037 528→	SBR		1 987 477 393	↔ 1616	
					TBR		1 987 477 338	↔ 1498	
		10.94-12.97	55		SBR		1 987 477 393	↔ 1616	
					TBR		1 987 477 338	↔ 1498	
1.8		11.91-07.94	55	Fg.-Nr. →1H..S..037 527	SBR		1 987 477 162	↔ 1613	
					TBR		1 987 477 168	↔ 1500	
			66	Fg.-Nr. →1H..S..037 527	SBR		1 987 477 162	↔ 1613	
					TBR		1 987 477 168	↔ 1500	
		08.94-09.94	66	Fg.-Nr. 1H..S..037 528→	SBR		1 987 477 393	↔ 1616	
					TBR		1 987 477 338	↔ 1498	
1.9D		11.91-07.94	47	Fg.-Nr. →1H..S..037 527	SBR		1 987 477 162	↔ 1613	
					TBR		1 987 477 168	↔ 1500	
		08.94-12.97	47	Fg.-Nr. 1H..S..037 528→	SBR		1 987 477 393	↔ 1616	
					TBR		1 987 477 338	↔ 1498	
		08.94-12.97	55	Fg.-Nr. 1H..S..037 528→	SBR		1 987 477 393	↔ 1616	
					TBR		1 987 477 338	↔ 1498	
1.9SDI		01.95-12.97	47		SBR		1 987 477 393	↔ 1616	
					TBR		1 987 477 338	↔ 1498	
1.9TD		11.91-07.94	55	Fg.-Nr. →1H..S..037 527	SBR		1 987 477 162	↔ 1613	
					TBR		1 987 477 168	↔ 1500	
		08.94-12.97	55	Fg.-Nr. 1H..S..037 528→	SBR		1 987 477 393	↔ 1616	
			TBR		1 987 477 338	↔ 1498			
1.9TDI		09.93-07.94	66	Fg.-Nr. →1H..S..037 527	SBR		1 987 477 162	↔ 1613	
					TBR		1 987 477 168	↔ 1500	
		08.94-07.96	66	Fg.-Nr. 1H..S..037 528→	SBR		1 987 477 393	↔ 1616	
					TBR		1 987 477 338	↔ 1498	
		02.96-12.97	81		SBR		1 987 477 393	↔ 1616	
					TBR		1 987 477 338	↔ 1498	
2.0		08.96-12.97	66		SBR		1 987 477 393	↔ 1616	
					TBR		1 987 477 338	↔ 1498	
		11.91-07.94	85	Fg.-Nr. →1H..S..037 527	SBR		1 987 477 162	↔ 1613	
					TBR		1 987 477 168	↔ 1500	
		08.94-09.94	85	Fg.-Nr. 1H..S..037 528→	SBR		1 987 477 393	↔ 1616	
					TBR		1 987 477 338	↔ 1498	
2.8		10.94-12.97	79		SBR		1 987 477 393	↔ 1616	
					TBR		1 987 477 338	↔ 1498	
			85		SBR		1 987 477 393	↔ 1616	
					TBR		1 987 477 338	↔ 1498	
		01.92-07.94	120/128	Fg.-Nr. →1H..S..037 527	SBR		1 987 477 162	↔ 1613	
					TBR		1 987 477 168	↔ 1500	
1.4		11.91-12.97	44		LAB		0 986 594 001 <sup>3</sup>		
					RAB		0 986 594 000 <sup>3</sup>		

		S							
	<b>◀ VW Vento [1H2]</b>								
<b>1.4</b>		03.95-07.95	44	Fg.-Nr. 1H..SW385 335→, 1H..SW352 190→, 1H..SB088 705→			0986 594 003 <sup>4</sup>		
		07.95-12.97	44				0986 594 003 <sup>4</sup>		
<b>1.6</b>		09.92-12.97	55/74		LAB		0986 594 001 <sup>3</sup>		
					RAB		0986 594 000 <sup>3</sup>		
		03.95-12.95	55/74	Fg.-Nr. 1H..SW385 335→, 1H..SW352 190→, 1H..SB088 705→			0986 594 003 <sup>4</sup>		
		07.95-12.97	55/74				0986 594 003 <sup>4</sup>		
<b>1.8</b>		11.91-12.97	55/66		LAB		0986 594 001 <sup>3</sup>		
					RAB		0986 594 000 <sup>3</sup>		
		03.95-12.97	55/66	Fg.-Nr. 1H..SW385 335→, 1H..SW352 190→, 1H..SB088 705→			0986 594 003 <sup>4</sup>		
<b>1.9 D</b>		11.91-12.97	47/55		LAB		0986 594 001 <sup>3</sup>		
<b>1.9 SDI</b>					RAB		0986 594 000 <sup>3</sup>		
<b>1.9 TD</b>		03.95-12.97	47/55	Fg.-Nr. 1H..SW385 335→, 1H..SW352 190→, 1H..SB088 705→			0986 594 003 <sup>4</sup>		
<b>1.9 TDI</b>		09.93-12.97	66		LAB		0986 594 001 <sup>3</sup>		
					RAB		0986 594 000 <sup>3</sup>		
		03.95-07.96	66	Fg.-Nr. 1H..SW385 335→, 1H..SW352 190→, 1H..SB088 705→			0986 594 003 <sup>4</sup>		
		02.96-12.97	81				0986 594 003 <sup>4</sup>		
					LAB		0986 594 001 <sup>3</sup>		
					RAB		0986 594 000 <sup>3</sup>		
		08.96-12.97	66				0986 594 003 <sup>4</sup>		
<b>2.0</b>		11.91-12.97	85		LAB		0986 594 001 <sup>3</sup>		
					RAB		0986 594 000 <sup>3</sup>		
		10.94-12.97	79		LAB		0986 594 001 <sup>3</sup>		
					RAB		0986 594 000 <sup>3</sup>		
		03.95-05.96	85	Fg.-Nr. 1H..SW385 335→, 1H..SW352 190→, 1H..SB088 705→			0986 594 003 <sup>4</sup>		
		03.95-12.97	79	Fg.-Nr. 1H..SW385 335→, 1H..SW352 190→, 1H..SB088 705→			0986 594 003 <sup>4</sup>		
		07.95-12.97	85				0986 594 003 <sup>4</sup>		
<b>2.8</b>		01.92-12.97	120/128		LAB		0986 594 001 <sup>3</sup>		
					RAB		0986 594 000 <sup>3</sup>		
		03.95-12.97	120/128	Fg.-Nr. 1H..SW385 335→, 1H..SW352 190→, 1H..SB088 705→			0986 594 003 <sup>4</sup>		

**ZAZ**

**Sens [TF698]**

	<b>1.3 Si</b>	01.02→	51	Fg.-Nr. →447433 Fg.-Nr. 447434→			0986 475 032	↔ 17,46	
							0986 475 143	↔ 19,05	
	<b>1.3 Si</b>	01.02→	51				1987 477 717	→ 1587	
							1987 477 920	← 1655	

de

Gegenüberstellung  
online verfügbar

en

Cross-reference  
online available

fr

Tableaux de corres-  
pondance en ligne  
disponible

it

Comparazione  
disponibile online

es

Equivalencias  
disponible online

nl

Tegenoverstelling  
online beschikbaar

sv

Jämförelse finns  
online

pt

Confrontação  
disponível online

cs

Porovnání k dispozici  
online

ru

Сопоставление  
онлайн-сравнение



**1 Product search**  
**2 Show details**  
**3 Comparisons**

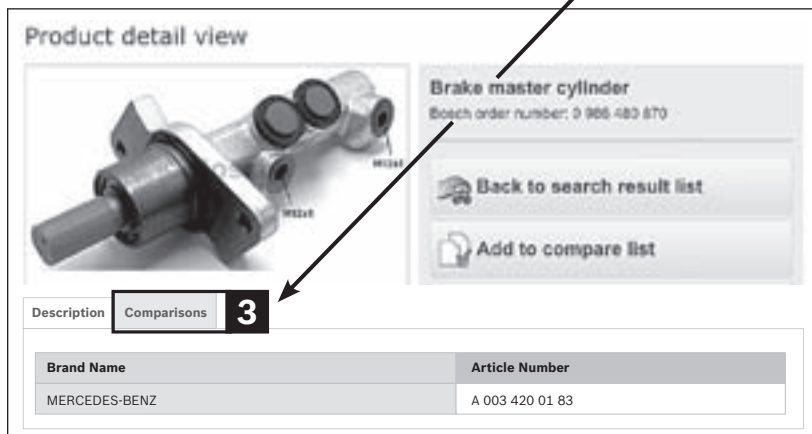
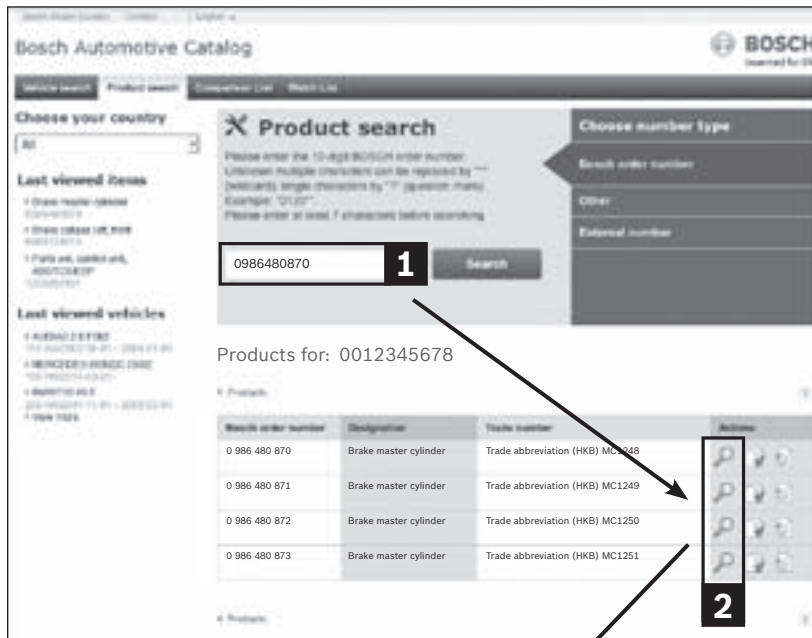

# www.bosch-automotive-catalog.com

Einfacher und schneller Zu-  
griff auf Bestellnummern von  
Herstellern anderer Marken,  
für die es einbaugleiche  
Bosch-Produkte gibt.

Easier and faster access to  
order numbers of manu-  
facturers of different brands  
for which Bosch products  
exist that have an equivalent  
design.

Accès rapide et simple aux  
références de commande  
des fabricants d'autres  
marques pour lesquels il  
existe des produits Bosch  
de montage identique.

Accesso rapido e semplice ai  
numeri d'ordine di produttori  
di altri marchi, per i quali  
esistono prodotti Bosch con  
uguale installazione.

Acceso sencillo y rápido  
a los números de pedido de  
fabricantes de otras marcas  
para las que hay productos  
Bosch de montaje similar.

Eenvoudiger en snelle  
toegang tot bestelnummers  
van fabrikanten van andere  
merken, waarvoor op  
dezelfde wijze inbouwbare  
Bosch-producten bestaan.

Enklare och snabbare  
åtkomst till beställnings-  
nummer från tillverkare  
av andra märken som har  
produkter som liknar Bosch  
monteringsmässigt.

Acesso simples e mais  
rápido aos números de  
encomenda dos fabricantes  
de outras marcas, para  
os quais existem produtos  
Bosch semelhantes.

Jednodušší a rychlejší  
přístup k objednacím číslům  
výrobců jiných značek,  
pro které existují produkty  
Bosch stejné vestavby.

Простой и быстрый  
доступ к номерам заказа  
изготовителей прочих  
марок, для которых  
существуют продукты  
Bosch с аналогичным  
способом установки.

<b>09Z</b>	Für Fahrzeuge mit 9 Zoll Bremsscheiben-Durchmesser	<b>4T0</b>	Für Fahrzeuge mit 4 Torsionsstäben	<b>BO</b>	Bosch, nur als Ersatz für Bosch-Ausrüstung
<b>10Z</b>	Für Fahrzeuge mit 10 Zoll Bremsscheiben-Durchmesser	<b>5L0</b>	5-Lochfelge	<b>BRB</b>	Für Brembo System
<b>14Z</b>	Felgendurchmesser 14 Zoll	<b>5SP</b>	Für Fahrzeuge mit 5 Sitzplätzen	<b>BSB</b>	Bremssattel mit Scheibenbremsbelägen
<b>15Z</b>	Für Felgendurchmesser 15 Zoll	<b>6L0</b>	6-Lochfelge	<b>BSB</b>	Bremssattel ohne Scheibenbremsbeläge
<b>165</b>	Für Felgendurchmesser 16,5 Zoll	<b>7SP</b>	Für Fahrzeuge mit 7 Sitzplätzen	<b>BSC</b>	Bremssattelgehäuse schwarz lackiert
<b>16R</b>	Bei 16 - 18 Zoll Räder	<b>82Z</b>	Durchmesser Bremsstrommel 228 mm	<b>BSR</b>	Bremssattelgehäuse rot lackiert
<b>16Z</b>	Für Felgendurchmesser 16 Zoll	<b>AA</b>	Allradantrieb	<b>BSR</b>	Bremssattelgehäuse nicht rot lackiert
<b>19D</b>	Durchmesser 190 mm	<b>AA</b>	Ohne Allradantrieb	<b>BSY</b>	Für Bosch Bremssystem
<b>1KD</b>	Bremsscheibe hinten 226 x 10 mm für 4-Lochfelge, mit nicht rotem Bremssattel	<b>ABM</b>	Abmessungen beachten	<b>BUS</b>	Für Bus
<b>1KP</b>	Bremsscheibe hinten 226 x 10 mm für 4-Lochfelge, mit rotem Bremssattel	<b>ABO</b>	Für Fahrzeuge ohne ABS	<b>CA</b>	Cabriolet
<b>1KX</b>	Bremsscheibe 313 x 26 mm	<b>ABS</b>	Für Fahrzeuge mit ABS	<b>CSA</b>	Erzeugnis auch online bestellbar "www.partbob.com"
<b>1LA</b>	Bremsscheibe 239 x 10 mm	<b>ADE</b>	Für Fahrzeuge mit Ausstattung: S, Active, Dynamic, Emotion, Class	<b>D53</b>	Durchmesser Bremsscheibe 253 mm
<b>1LM</b>	Bremsscheibe 239 x 12 mm	<b>AEL</b>	Für Fahrzeuge mit EL-Ausstattung	<b>D77</b>	Durchmesser 17,78 mm
<b>1LQ</b>	Bremsscheibe 268 x 10 mm	<b>AFS</b>	Für Fahrzeuge mit aktiver Seitenneigungsregelung	<b>D84</b>	Durchmesser Bremsscheibe 284 mm
<b>1LV</b>	Bremsscheibe 280 x 22 mm für 4-Lochfelge, mit nicht rotem Bremssattel	<b>AG</b>	Für Fahrzeuge mit automatischem Getriebe	<b>D85</b>	Durchmesser Bremsscheibe 285 mm
<b>1LW</b>	Bremsscheibe 280 x 22 mm für 4-Lochfelge, mit rotem Bremssattel	<b>AGH</b>	Für Aluminiumgehäuse	<b>DMO</b>	Für Delco Moraine System
<b>1LY</b>	Bremsscheibe 256 x 20 mm	<b>AGT</b>	GT-Ausführung	<b>DOP</b>	Doppelkabine
<b>20R</b>	Bei 20 Zoll Räder	<b>AIO</b>	Für Fahrzeuge ohne ABS und ohne innenbelüftete Bremsscheiben	<b>DRK</b>	Drehzahlfühler/Radlager-Kombination
<b>21Z</b>	Bremsscheibe 255 x 12 mm	<b>ALE</b>	Nicht für Fahrzeuge mit Allradlenkung	<b>EAL</b>	Für Fahrzeuge mit elektronischer Aktiv-Lenkung
<b>226</b>	Durchmesser Bremsscheibe 226 mm	<b>ALR</b>	Für Fahrzeuge mit automatischer Leuchtweitenregelung	<b>EAL</b>	Für Fahrzeuge ohne elektronische Aktiv-Lenkung
<b>228</b>	Bremsscheibe 280 x 22 mm	<b>ALR</b>	Für Fahrzeuge ohne automatische Leuchtweitenregelung	<b>EBR</b>	Einkreis-Bremsanlage
<b>232</b>	Bremsscheibe 232 x 9 mm	<b>AMI</b>	Für Fahrzeuge mit ABS und innenbelüfteten Bremsscheiben	<b>EDS</b>	Für Fahrzeuge mit EDS (elektronischer Differentialsperre)
<b>238</b>	Durchmesser Bremsscheibe 238 mm	<b>AMI</b>	Für Fahrzeuge mit ABS ohne innenbelüftete Bremsscheiben	<b>EFV</b>	Auch Ersatz für Vorgänger
<b>239</b>	Bremsscheibe 239 x 20 mm	<b>AMJ</b>	Für Ausführung Momo	<b>EIZ</b>	Bremssattel, 1 Kolben
<b>245</b>	Bremsscheibe 245 x 10 mm	<b>AMJ</b>	Nicht für Ausführung Momo	<b>EMA</b>	Einbaugleiches Bosch-Erzeugnis oder Teil für Mando
<b>252</b>	Bremsscheibe 256 x 22 mm	<b>AOA</b>	Für Fahrzeuge mit automatischem Getriebe, ohne ABS	<b>ERH</b>	Für Fahrzeuge mit erhöhter Nutzlast
<b>254</b>	Durchmesser 25,4 mm	<b>AOS</b>	Für Fahrzeuge mit ABS, ohne ASR	<b>ETG</b>	Für einteiligen Bremssattel
<b>256</b>	Bremsscheibe 256 x 12 mm	<b>APG</b>	Für AMG Performance Package	<b>EU4</b>	Für Fahrzeuge mit Abgasnorm Euro 4
<b>257</b>	Durchmesser Bremsscheibe 257 mm	<b>ASR</b>	Für Fahrzeuge mit ASR (Antriebsschlupfregelung)	<b>EU5</b>	Für Fahrzeuge mit Abgasnorm Euro 5
<b>268</b>	Durchmesser Bremsscheibe 268 mm	<b>ATE</b>	Für ATE System (Teves)	<b>EZK</b>	Für Fahrzeuge mit Einzelkabine
<b>278</b>	Durchmesser Bremsscheibe 278 mm	<b>ATJ</b>	Für Ausführung Trekking	<b>FAN</b>	Fahrwerk Standard Ausführung
<b>281</b>	Bremsscheibe 282 x 18 mm	<b>ATN</b>	Nicht für Ausführung Trekking	<b>FBD</b>	Einbaugleiches Bosch-Erzeugnis oder Teil für Bendix
<b>284</b>	Bremsscheibe 280 x 24 mm	<b>ATP</b>	Für Fahrzeuge mit AMG Technik-Paket	<b>FDO</b>	Für Ferodo System
<b>288</b>	Bremsscheibe 288 x 25 mm	<b>ATP</b>	Für Fahrzeuge ohne AMG Technik-Paket	<b>FEB</b>	Für elektronische Feststellbremse
<b>292</b>	Durchmesser Bremsscheibe 292 mm	<b>B17</b>	Für Felgendurchmesser 17 Zoll	<b>FEB</b>	Nicht für elektronische Feststellbremse
<b>294</b>	Durchmesser Bremsscheibe 294 mm	<b>B18</b>	Für Felgendurchmesser 18 Zoll	<b>FEN</b>	Für Fahrzeuge mit normaler Federung
<b>295</b>	Durchmesser Bremsstrommel 295 mm	<b>B25</b>	Bremsscheibe 259 x 12 mm	<b>FEV</b>	Für Fahrzeuge mit verstärkter Federung
<b>2T0</b>	Für Fahrzeuge mit 2 Torsionsstäben	<b>B34</b>	Für Bremssattel mit Kolbendurchmesser 34 mm	<b>FGS</b>	Für Fahrgestell
<b>302</b>	Durchmesser Bremsscheibe 302 mm	<b>B38</b>	Für Bremssattel mit 38 mm Kolbendurchmesser	<b>FGS</b>	Nicht für Fahrgestell
<b>305</b>	Durchmesser Bremsscheibe 305 mm	<b>B41</b>	Für Bremssattel mit 41 mm Kolbendurchmesser	<b>FHL</b>	Für Fahrzeuge mit HL-Ausstattung
<b>308</b>	Durchmesser Bremsscheibe 308 mm	<b>B59</b>	Bremsscheibe 259 x 20 mm	<b>FKR</b>	Für Fahrzeuge mit kurzem Radstand
<b>30R</b>	Für Fahrzeuge mit Radstand 3050 mm	<b>B80</b>	Bosch System 8.0	<b>FLR</b>	Für Fahrzeuge mit langem Radstand
<b>312</b>	Durchmesser Bremsscheibe 312 mm	<b>B81</b>	Bosch System 8.1	<b>FMR</b>	Für Fahrzeuge mit mittlerem Radstand
<b>31D</b>	Durchmesser Bremsscheibe 315 mm	<b>BAS</b>	Für Bosch System und Fahrzeuge mit ABS	<b>FMS</b>	Für Fahrzeuge mit Sonderschutz (gepanzert)
<b>321</b>	Bremsscheibe 321 x 30 mm	<b>BAS</b>	Für Bosch System und Fahrzeuge ohne ABS	<b>FMS</b>	Für Fahrzeuge ohne Sonderschutz (ungepanzert)
<b>322</b>	Bremsscheibe 314 x 22 mm	<b>BDE</b>	Für Bendix Spanien (BENDIBERICA)	<b>FMU</b>	Für Fahrzeuge mit Unterfahrschutz
<b>326</b>	Bremsscheibe 300 x 26 mm	<b>BDS</b>	Mit Drehsitz	<b>FMU</b>	Für Fahrzeuge ohne Unterfahrschutz
<b>332</b>	Durchmesser Bremsscheibe 332 mm	<b>BDS</b>	Ohne Drehsitz	<b>FPA</b>	Für Fahrzeuge mit Parkassistent
<b>336</b>	Durchmesser Bremsscheibe 336 mm	<b>BES</b>	Befestigung, 5-Loch	<b>FPA</b>	Für Fahrzeuge ohne Parkassistent
<b>347</b>	Bremsscheibe 347 x 30 mm	<b>BHO</b>	Für Behördenfahrzeuge	<b>FSB</b>	Faustsattelbremse
<b>3LO</b>	3-Lochfelge	<b>BHO</b>	Nicht für Behördenfahrzeug	<b>G10</b>	Anschlussgewinde M10 x 1
<b>3T5</b>	Für Fahrzeuge mit 3,5 t zulässigem Gesamtgewicht	<b>BKR</b>	Für Fahrzeuge mit Bremskraftregler	<b>GBM</b>	Für Fahrzeuge mit Abstandsregelung
<b>452</b>	Durchmesser Bremsstrommel 254 mm	<b>BKR</b>	Für Fahrzeuge ohne Bremskraftregler	<b>GBM</b>	Für Fahrzeuge ohne Abstandsregelung
<b>4DB</b>	Für 4-Lochfelge, Fahrzeuge ohne ABS, Bosch und Bendix System	<b>BKV</b>	Für Fahrzeuge mit Bremskraftverstärker	<b>GEM</b>	Metallgehäuse
<b>4-K</b>	Für 4-Kanalsystem	<b>BKV</b>	Für Fahrzeuge ohne Bremskraftverstärker	<b>GIM</b>	Für Lucas-Girling System, Fahrzeuge mit ABS
<b>4LO</b>	4-Lochfelge	<b>BLA</b>	Ausführung schwarz	<b>GIM</b>	Für Lucas-Girling System, Fahrzeuge ohne ABS
<b>4SB</b>	Für Fahrzeuge mit Scheibenbremsen hinten			<b>GIR</b>	Für Lucas-Girling System
				<b>GLA</b>	GL-Ausführung
				<b>GRF</b>	Grundausführung
				<b>GS</b>	Für Fahrzeuge mit Handschaltgetriebe
				<b>GSI</b>	GSi-Ausführung

<b>GSO</b>	Für Fahrzeuge ohne Notbremsassistent
<b>GXA</b>	Für Fahrzeuge mit GX-Ausstattung
<b>HO1</b>	Klemmhülse 2 261 024 304 mitbestellen und tauschen
<b>HAK</b>	Für Fahrzeuge mit Handschaltgetriebe, ohne ABS und ohne Klimaanlage
<b>HLI</b>	Hinten, Linksanbau
<b>HLS</b>	Für Fahrzeuge mit Scheibenbremse, hinten, Linksanbau
<b>HOA</b>	Für Fahrzeuge mit Handschaltgetriebe, ohne ABS
<b>HRE</b>	Hinten, Rechtsanbau
<b>HRS</b>	Für Fahrzeuge mit Scheibenbremse, hinten, Rechtsanbau
<b>HSA</b>	Für Fahrzeuge mit Handschaltgetriebe und ABS
<b>HTB</b>	Für Fahrzeuge mit Trommelbremsen hinten
<b>IBA</b>	Innenbelüftete Brems scheiben für Fahrzeuge ohne ABS
<b>INB</b>	Innenbelüftete Brems scheibe
<b>INB</b>	Brems scheibe ohne Innenbelüftung
<b>ITB</b>	Für ITT Bremssystem
<b>JUR</b>	Für Jurid System
<b>KL</b>	Für Fahrzeuge mit Klimaanlage
<b>KL</b>	Für Fahrzeuge ohne Klimaanlage
<b>KOB</b>	Für Kombiwagen
<b>KOM</b>	Kombiwagen mit Katalysator
<b>KW</b>	Für Kastenwagen
<b>KZB</b>	Kennzeichen: blau
<b>KZG</b>	Kennzeichen: grün
<b>KZR</b>	Kennzeichen: rot
<b>KZU</b>	Kennzeichen: grau
<b>L01</b>	Nutzlast 800 kg
<b>L02</b>	Nutzlast 1800 kg
<b>L03</b>	Nutzlast unter 1800 kg
<b>L06</b>	Nutzlast 1000 kg
<b>L07</b>	Nutzlast 1400 kg
<b>L10</b>	Länge: 1025 mm
<b>L13</b>	Länge: 1345 mm
<b>L65</b>	Länge: 650 mm
<b>LAB</b>	Linksanbau
<b>LAU</b>	Für Fahrzeuge mit L-Ausstattung
<b>LFS</b>	Faustsattelbremse Lucas
<b>LGM</b>	Für niederes Modell "grade"
<b>LGS</b>	Für Limousine mit Schaltgetriebe
<b>LIA</b>	Für Limousine mit ABS
<b>LIM</b>	Für Limousine
<b>LKR</b>	Für Linkslenker mit kurzem Radstand
<b>LLE</b>	Für Linkslenker
<b>LLT</b>	Für Linkslenker-Fahrzeuge mit Trommelbremse
<b>LOC</b>	Für Lockheed System
<b>LUC</b>	Einbaugleiches Bosch-Erzeugnis oder Teil für Lucas
<b>LUX</b>	Luxus-Ausführung
<b>LWG</b>	Für Lieferwagen
<b>LWG</b>	Nicht für Lieferwagen
<b>LWR</b>	Ohne Leuchtweitenregelung
<b>LXA</b>	Für Fahrzeuge mit LX-Ausstattung
<b>MB</b>	Mechanische Betätigung
<b>MBB</b>	Für Mercedes-Benz-Bremse/System
<b>MEH</b>	Mit einem Haltestift
<b>MET</b>	Für Fahrzeuge mit ETS und ASR
<b>MET</b>	Für Fahrzeuge ohne ETS und ASR
<b>MFD</b>	Für Fahrzeuge mit ESP (Elektronisches Stabilitätsprogramm)
<b>MI</b>	Mitte
<b>MIH</b>	Mit Halter
<b>MIH</b>	Ohne Halter
<b>MOJ</b>	Für Ausführung Monster
<b>MOJ</b>	Nicht für Ausführung Monster
<b>MTG</b>	Mit Tilgergewicht
<b>MTG</b>	Ohne Tilgergewicht
<b>MVB</b>	Für Fahrzeuge mit Bremsbelagverschleißanzeige
<b>MVB</b>	Für Fahrzeuge ohne Bremsbelagverschleißanzeige
<b>MZH</b>	Mit zwei Haltestiften
<b>NAA</b>	Nicht für Allradantrieb
<b>NFS</b>	Für Sondermodell Baccara/Initiale
<b>NFS</b>	Nicht für Sondermodell Baccara/Initiale
<b>NHV</b>	Ohne Niveauregelung
<b>NNC</b>	Für Fahrzeuge mit normaler Federung, nicht für Campingfahrzeug
<b>NON</b>	Für Fahrzeuge mit normaler Nutzlast
<b>NOR</b>	Normale Ausführung
<b>OAS</b>	Für Fahrzeuge ohne ASR (Antriebsschlupfregelung)
<b>OED</b>	Für Fahrzeuge ohne elektronische Differentialsperre
<b>OFD</b>	Für Fahrzeuge ohne ESP (Elektronisches Stabilitätsprogramm)
<b>OFS</b>	Für Fahrzeuge ohne aktive Seitenneigungsregelung
<b>OZB</b>	Für Fahrzeuge mit Einzelbereifung
<b>PAJ</b>	Für Ausführung mit Pandemonium Kit
<b>PAJ</b>	Nicht für Ausführung mit Pandemonium Kit
<b>PEO</b>	Für Perrot-Bremse/System
<b>PFN</b>	Nicht für BMW Performance Bremsanlage
<b>PW</b>	Für Pritschenwagen
<b>PW</b>	Nicht für Pritschenwagen
<b>R30</b>	Für Fahrzeuge mit Radstand 3000 mm
<b>R33</b>	Für Fahrzeuge mit Radstand 3350 mm
<b>R35</b>	Für Fahrzeuge mit Radstand 3550 mm
<b>R37</b>	Für Fahrzeuge mit Radstand 3700 mm
<b>R40</b>	Für Fahrzeuge mit Radstand 4025 mm
<b>RAB</b>	Rechtsanbau
<b>RBA</b>	Für Fahrzeuge mit Bosch-ABS
<b>RKR</b>	Für Rechtslenker mit kurzem Radstand
<b>RLE</b>	Für Rechtslenker
<b>RSB</b>	Rahmensattelbremse
<b>S25</b>	Brems scheibe 256 X 25mm
<b>S31</b>	Brems scheibe 314 x 25 mm
<b>SA</b>	Sonderausrüstung
<b>SAZ</b>	Satz
<b>SBE</b>	Schwere Beanspruchung
<b>SBJ</b>	Für Fahrzeuge mit Sportbremsanlage
<b>SBJ</b>	Nicht für Fahrzeuge mit Sportbremsanlage
<b>SBR</b>	Für Fahrzeuge mit Scheibenbremsen
<b>SCK</b>	Für Schraubanschluss
<b>SCR</b>	Schrägheck
<b>SDK</b>	Standardkabine
<b>SFZ</b>	Für Sonderfahrzeuge
<b>SLX</b>	Für Fahrzeuge mit SLX-Ausstattung
<b>SP</b>	Sport
<b>SPE</b>	Spezial (Combo)
<b>SPF</b>	Sportfederung
<b>SPN</b>	Nicht für Fahrzeuge mit Sportfederung
<b>SPT</b>	Ausstattungsvariante: SPORT
<b>SSB</b>	Schwimmsattelbremse
<b>SSZ</b>	Für schlechten Straßenzustand
<b>SSZ</b>	Nicht für schlechten Straßenzustand
<b>STB</b>	Für Fahrzeuge mit Scheibenbremsen vorne und Trommelbremsen hinten
<b>STK</b>	Für Steckanschluss
<b>STU</b>	Stufenheck
<b>SVN</b>	Spur nicht verbreitert
<b>SVN</b>	Spur verbreitert
<b>T06</b>	Für Trommelbremse 203 x 38 mm und Radbremszylinder mit Kolbendurchmesser 20,6 mm
<b>T26</b>	Durchmesser Bremsstrommel 260 mm
<b>TA</b>	Für Taxi
<b>TA</b>	Nicht für Taxi
<b>TBR</b>	Für Fahrzeuge mit Trommelbremsen
<b>TEF</b>	Für ATE (Teves) und Ferodo System
<b>TEJ</b>	Für ATE (Alfred Teves) und Jurid System
<b>TEX</b>	Für Textar System
<b>THJ</b>	Nicht für Fahrzeuge mit TI-Ausstattung
<b>TKO</b>	Für Fahrzeuge mit Traktionskontrolle
<b>TKO</b>	Für Fahrzeuge ohne Traktionskontrolle
<b>TLV</b>	Turbo-Look Version
<b>TLV</b>	Nicht für Turbo-Look Version
<b>TMA</b>	Für ATE (Teves) System, Fahrzeuge mit ABS
<b>TMA</b>	Für ATE (Teves) System, Fahrzeuge ohne ABS
<b>TNK</b>	Zur eindeutigen Identifikation der Bosch-Nummer muß die Datenkarte des Fahrzeuges vorliegen. Die beim Erzeugnis aufgeführten Komponenten müssen mit denen in der Datenkarte übereinstimmen.
<b>TR2</b>	Für Trommelbremse 200 x 40 mm und Radbremszylinder mit Kolbendurchmesser 17,5 mm
<b>TRØ</b>	Nicht für Tropen
<b>TRV</b>	Für Fahrzeuge mit Trommelbremse vorne und hinten
<b>TRW</b>	Hersteller = TRW
<b>TSE</b>	Für Fahrzeuge mit SE-Ausstattung
<b>TW</b>	Eingebautes Erzeugnis muss am Fahrzeug oder Motor ermittelt werden.
<b>VAN</b>	Für VAN
<b>VEA</b>	Verstärkte Ausführung
<b>VFC</b>	Für Fahrzeuge mit verstärkter Federung, für Campingfahrzeug
<b>VFG</b>	Für verstärktes Fahrgestell
<b>VLI</b>	Vorne, Linksanbau
<b>VRE</b>	Vorne, Rechtsanbau
<b>VSP</b>	Für Sporting-Ausführung
<b>VSP</b>	Nicht für Sporting-Ausführung
<b>WAB</b>	Einbaugleiches Bosch-Erzeugnis oder Teil für Wabco
<b>XLA</b>	Für Fahrzeuge mit XL-Ausstattung
<b>Y61</b>	Durchmesser Brems scheibe 340 mm
<b>Z15</b>	Durchmesser 15 Zoll
<b>ZBR</b>	Für Zweikreis-Bremsanlage
<b>ZE</b>	Zwei erforderlich
<b>ZTG</b>	Für zweiteiligen Bremsattel
<b>ZWB</b>	Für Fahrzeuge mit Zwillingbereifung
<b>ZWZ</b>	Bremsattel, 2 Kolben
<sup>3</sup>	Vorn
<sup>4</sup>	Hinten
<sup>6</sup>	Mit Kolben
<sup>7</sup>	Ohne Kolben
<sup>8</sup>	Teilesatz mit Führungshülsen
<sup>9</sup>	Ohne Kolben, mit Handbrems teilen
<sup>U</sup>	Mit integriertem Regler



de



Bestellnummer



Hinterachse



Sonderfälle



Pkw



Information / Erläuterung



Datum / Einbauzeitraum



Pkw / Kleintransporter



Serie



Fahrgestellnummer



Maße



Radbremszylinder



Motorleistung in kW



Bremssattel rechts



Bremssattel



Bosch-Austauschteil



Handbremsseil



Drehzahlsensor



Gegenüberstellung



Seitenverweis



Seitenverweis



Durchmesser



Vorderachse



<b>09Z</b>	For vehicles with 9 inch diameter brake discs
<b>10Z</b>	For vehicles with 10 inch diameter brake discs
<b>14Z</b>	For rim diameter 14 inch
<b>15Z</b>	For rim diameter 15 inch
<b>16S</b>	For rim diameter 16.5 inch
<b>16R</b>	For 16 - 18 inch wheels
<b>16Z</b>	For rim diameter 16 inch
<b>19D</b>	Diameter 190 mm
<b>1KD</b>	Rear brake disc 226 x 10 mm for 4-hole rim, with non-red brake caliper
<b>1KP</b>	Rear brake disc 226 x 10 mm for 4-hole rim, with red brake caliper
<b>1KX</b>	Brake disc 313 x 26 mm
<b>1LA</b>	Brake disc 239 x 10 mm
<b>1LM</b>	Brake disc 239 x 12 mm
<b>1LQ</b>	Brake disc 268 x 10 mm
<b>1LV</b>	Brake disc 280 x 22 mm for 4-hole rim, with non-red brake caliper
<b>1LW</b>	Brake disc 280 x 22 mm for 4-hole rim, with red brake caliper
<b>1LY</b>	Brake disc 256 x 20 mm
<b>20R</b>	For 20 inch wheels
<b>21Z</b>	Brake disc 255 x 12 mm
<b>226</b>	Brake disc diameter 226 mm
<b>228</b>	Brake disc 280 x 22 mm
<b>23Z</b>	Brake disc 232 x 9 mm
<b>238</b>	Brake disc diameter 238 mm
<b>239</b>	Brake disc 239 x 20 mm
<b>24S</b>	Brake disc 245 x 10 mm
<b>25Z</b>	Brake disc 256 x 22 mm
<b>254</b>	Diameter 25.4 mm
<b>256</b>	Brake disc 256 x 12 mm
<b>257</b>	Brake disc diameter 257 mm
<b>268</b>	Brake disc diameter 268 mm
<b>278</b>	Brake disc diameter 278 mm
<b>281</b>	Brake disc 282 x 18 mm
<b>284</b>	Brake disc 280 x 24 mm
<b>288</b>	Brake disc 288 x 25 mm
<b>29Z</b>	Brake disc diameter 292 mm
<b>294</b>	Brake disc diameter 294 mm
<b>29S</b>	Brake drum diameter 295 mm
<b>2T0</b>	For vehicles with 2 torsion bars
<b>30Z</b>	Brake disc diameter 302 mm
<b>30S</b>	Brake disc diameter 305 mm
<b>308</b>	Brake disc diameter 308 mm
<b>30R</b>	For vehicles with 3050 mm wheelbase
<b>31Z</b>	Brake disc diameter 312 mm
<b>31D</b>	Brake disc diameter 315 mm
<b>321</b>	Brake disc 321 x 30 mm
<b>32Z</b>	Brake disc 314 x 22 mm
<b>326</b>	Brake disc 300 x 26 mm
<b>33Z</b>	Brake disc diameter 332 mm
<b>336</b>	Brake disc diameter 336 mm
<b>34Z</b>	Brake disc 347 x 30 mm
<b>3LO</b>	3-lug rim
<b>3T5</b>	For vehicles with 3.5 t gross permissible weight
<b>45Z</b>	Brake drum diameter 254 mm
<b>4DB</b>	For 4-lug rim, vehicles without ABS, Bosch and Bendix system
<b>4-K</b>	For 4-channel system
<b>4LO</b>	4-lug rim
<b>4SB</b>	For vehicles with rear disc brakes
<b>4T0</b>	For vehicles with 4 torsion bars
<b>5LO</b>	5-lug rim
<b>5SP</b>	For vehicles with 5 seats
<b>6LO</b>	6-lug rim
<b>7SP</b>	For vehicles with 7 seats
<b>82Z</b>	Brake drum diameter 228 mm
<b>AA</b>	All-wheel drive
<b>AA</b>	Without all-wheel drive
<b>ABM</b>	Note dimensions
<b>ABO</b>	For vehicles without ABS
<b>ABS</b>	For vehicles with ABS
<b>ADE</b>	For vehicles with equipment: S, Active, Dynamic, Emotion, Class
<b>AEL</b>	For vehicles with EL equipment
<b>AFS</b>	For vehicles with active lateral inclination control
<b>AG</b>	For vehicles with automatic transmission
<b>AGH</b>	For aluminum housing
<b>AGT</b>	For GT submodel
<b>AIO</b>	For vehicles without ABS and without ventilated brake discs
<b>ALE</b>	Not for vehicles with all-wheel steering
<b>ALR</b>	For vehicles with automatic headlight range control
<b>ALR</b>	For vehicles without automatic headlight range control
<b>AMI</b>	For vehicles with ABS and ventilated brake discs
<b>AMJ</b>	For vehicles with ABS without ventilated brake discs
<b>AMJ</b>	For Momo version
<b>AMJ</b>	Not for Momo version
<b>AOA</b>	For vehicles with automatic transmission, without ABS
<b>AOS</b>	For vehicles with ABS, without TCS
<b>APG</b>	For AMG performance package
<b>ASR</b>	For vehicles with TCS (traction control system)
<b>ATE</b>	For ATE system (Teves)
<b>ATJ</b>	For Trekking version
<b>ATN</b>	Not for Trekking version
<b>ATP</b>	For vehicles with AMG technology package
<b>ATP</b>	For vehicles without AMG technology package
<b>B17</b>	For rim diameter 17 inch
<b>B18</b>	For rim diameter 18 inch
<b>B25</b>	Brake disc 259 x 12 mm
<b>B34</b>	For brake caliper with piston diameter 34 mm
<b>B38</b>	For brake caliper with 38 mm piston diameter
<b>B41</b>	For brake caliper with 41 mm piston diameter
<b>B59</b>	Brake disc 259 x 20 mm
<b>B80</b>	Bosch system 8.0
<b>B81</b>	Bosch system 8.1
<b>BAS</b>	For Bosch system and vehicles with ABS
<b>BAS</b>	For Bosch system and vehicles without ABS
<b>BDE</b>	For Bendix Spain (BENDIBERICA)
<b>BDS</b>	With rotary seat
<b>BDS</b>	Without swivel seat
<b>BEL</b>	Attachment, 5-hole
<b>BES</b>	Attachment with bolts
<b>BHO</b>	For official vehicles
<b>BHO</b>	Not for official vehicle
<b>BKR</b>	For vehicles with braking force regulator
<b>BKR</b>	For vehicles without braking force regulator
<b>BKV</b>	For vehicles with brake booster
<b>BKV</b>	For vehicles without brake booster
<b>BLA</b>	Black version
<b>BO</b>	Bosch, only as replacement for Bosch equipment
<b>BRB</b>	For Brembo system
<b>BSB</b>	Brake caliper with disc brake pads
<b>BSB</b>	Brake caliper without disc brake pads
<b>BSC</b>	Brake caliper housing painted black
<b>BSR</b>	Brake caliper housing painted red
<b>BSR</b>	Brake caliper housing not painted red
<b>BSY</b>	For Bosch brake system
<b>BUS</b>	For bus
<b>CA</b>	Convertible
<b>CSA</b>	Product can also be ordered online "www.partbob.com"
<b>D53</b>	Brake disc diameter 253 mm
<b>D77</b>	Diameter 17.78 mm
<b>D84</b>	Brake disc diameter 284 mm
<b>D85</b>	Brake disc diameter 285 mm
<b>DMO</b>	For Delco Moraine system
<b>DOP</b>	Double cab
<b>DRK</b>	Speed sensor/ wheel bearing combination
<b>EAL</b>	For vehicles with electronic active steering
<b>EAL</b>	For vehicles without electronic active steering
<b>EBR</b>	Single-circuit brake system
<b>EDS</b>	For vehicles with EDL (electronic differential lock)
<b>EFV</b>	Also replacement for predecessor
<b>EIZ</b>	Brake caliper, 1 piston
<b>EMA</b>	Interchangeable Bosch product or part for Mando
<b>ERH</b>	For vehicles with increased payload
<b>ETG</b>	For one-piece brake caliper
<b>EU4</b>	For vehicles with emission standard Euro 4
<b>EU5</b>	For vehicles with emission standard Euro 5
<b>EZK</b>	For vehicles with single cab
<b>FAN</b>	Running gear standard version
<b>FBD</b>	Interchangeable Bosch product or part for Bendix
<b>FDO</b>	For Ferodo system
<b>FEB</b>	For electronic parking brake
<b>FEB</b>	Not for electronic parking brake
<b>FEN</b>	For vehicles with standard suspension
<b>FEV</b>	For vehicles with heavy duty suspension
<b>FGS</b>	For stripped chassis
<b>FGS</b>	Not for chassis
<b>FHL</b>	For vehicles with HL equipment
<b>FKR</b>	For vehicles with short wheelbase
<b>FLR</b>	For vehicles with long wheelbase
<b>FMR</b>	For vehicles with medium wheelbase
<b>FMS</b>	For vehicles with special protection (armoured)
<b>FMS</b>	For vehicles without special protection (non-armoured)
<b>FMU</b>	For vehicles with underride guard
<b>FMU</b>	For vehicles without underride protector
<b>FPA</b>	For vehicles with parking assistant
<b>FPA</b>	For vehicles without parking assistant
<b>FSB</b>	Fist-type caliper brake
<b>G10</b>	Connecting thread M10 x 1
<b>GBM</b>	For vehicles with distance control
<b>GBM</b>	For vehicles without distance control
<b>GEM</b>	Metal housing
<b>GIM</b>	For Lucas-Girling system, vehicles with ABS
<b>GIM</b>	For Lucas-Girling system, vehicles without ABS
<b>GIR</b>	For Lucas-Girling system
<b>GLA</b>	For GL submodel
<b>GRF</b>	Basic version
<b>GS</b>	For vehicles with manual transmission
<b>GSI</b>	GSI version
<b>GSO</b>	For vehicles without low speed collision avoidance system
<b>GXA</b>	For vehicles with GX equipment
<b>H01</b>	Also order and replace clamping sleeve 2 261 024 304
<b>HAK</b>	For vehicles with manual transmission, without ABS and without air conditioner





<b>HLI</b>	Rear, left side mounting
<b>HLS</b>	For vehicles with disc brake, rear, left side mounting
<b>HOA</b>	For vehicles with manual transmission, without ABS
<b>HRE</b>	Rear, right side mounting
<b>HRS</b>	For vehicles with disc brake, rear, right side mounting
<b>HSA</b>	For vehicles with manual transmission and ABS
<b>HTB</b>	For vehicles with rear drum brakes
<b>IBA</b>	Ventilated brake discs for vehicles without ABS
<b>INB</b>	Ventilated brake disc
<b>INB</b>	Non-ventilated brake disc
<b>ITB</b>	For ITT brake system
<b>JUR</b>	For Jurid system
<b>KL</b>	For vehicles with air conditioner
<b>KL</b>	For vehicles without air conditioner
<b>KOB</b>	For station wagon
<b>KOM</b>	Station wagon with catalytic converter
<b>KW</b>	For box-type van
<b>KZB</b>	Identification: blue
<b>KZG</b>	Identification: green
<b>KZR</b>	Identification: red
<b>KZU</b>	Identification: grey
<b>L01</b>	Payload 800 kg
<b>L02</b>	Payload 1800 kg
<b>L03</b>	Payload under 1800 kg
<b>L06</b>	Payload 1000 kg
<b>L07</b>	Payload 1400 kg
<b>L10</b>	Length: 1025 mm
<b>L13</b>	Length: 1345 mm
<b>L65</b>	Length: 650 mm
<b>LAB</b>	Left side mounting
<b>LAU</b>	For vehicles with L equipment
<b>LFS</b>	Floating caliper brake, Lucas
<b>LGM</b>	For low model "grade"
<b>LGS</b>	For limousine with manual transmission
<b>LIA</b>	For limousines with ABS
<b>LIM</b>	For limousine
<b>LKR</b>	For LHD vehicles with short wheelbase
<b>LLE</b>	For LHD vehicles
<b>LLT</b>	For LHD vehicles with drum brakes
<b>LOC</b>	For Lockheed system
<b>LUC</b>	Interchangeable Bosch product or part for Lucas
<b>LUX</b>	De luxe version
<b>LWG</b>	For delivery van
<b>LWG</b>	Not for delivery van
<b>LWR</b>	Without headlight range control
<b>LXA</b>	For vehicles with LX equipment
<b>MB</b>	Mechanical actuation
<b>MBB</b>	For Mercedes-Benz brake/system
<b>MEH</b>	With one retaining pin
<b>MET</b>	For vehicles with ETS and TCS
<b>MET</b>	For vehicles without ETS and TCS
<b>MFD</b>	For vehicles with ESP (electronic stability program)
<b>MI</b>	Center
<b>MIH</b>	With holder
<b>MIH</b>	Without holder
<b>MOJ</b>	For Monster version
<b>MOJ</b>	Not for Monster version
<b>MTG</b>	With vibration damper
<b>MTG</b>	Without vibration damper
<b>MVB</b>	For vehicles with brake lining wear indicator
<b>MVB</b>	For vehicles without brake lining wear indicator
<b>MZH</b>	With two retaining pins
<b>NAA</b>	Not for all-wheel drive
<b>NFS</b>	For special model Baccara/Initiale
<b>NFS</b>	Not for special model Baccara/Initiale
<b>NHV</b>	Without level control
<b>NNC</b>	For vehicles with standard suspension, not for camper vehicle
<b>NON</b>	For vehicles with standard payload
<b>NOR</b>	Standard version
<b>OAS</b>	For vehicles without TCS (traction control system)
<b>OED</b>	For vehicles without electronic differential lock
<b>OFD</b>	For vehicles without ESP (electronic stability program)
<b>OFS</b>	For vehicles without active lateral inclination control
<b>OZB</b>	For vehicles with single rear wheels
<b>PAJ</b>	For version with Pandemonium kit
<b>PAJ</b>	Not for version with Pandemonium kit
<b>PEO</b>	For Perrot brake/system
<b>PFN</b>	Not for BMW performance brake system
<b>PW</b>	For flatbed truck
<b>PW</b>	Not for flatbed truck
<b>R30</b>	For vehicles with 3000 mm wheelbase
<b>R33</b>	For vehicles with 3350 mm wheelbase
<b>R35</b>	For vehicles with 3550 mm wheelbase
<b>R37</b>	For vehicles with 3700 mm wheelbase
<b>R40</b>	For vehicles with 4025 mm wheelbase
<b>RAB</b>	Right side mounting
<b>RBA</b>	For vehicles with Bosch ABS
<b>RKR</b>	For RHD vehicles with short wheelbase
<b>RLE</b>	For RHD vehicles
<b>RSB</b>	Frame-type caliper brake
<b>S25</b>	Brake disc 256 x 25 mm
<b>S31</b>	Brake disc 314 x 25 mm
<b>SA</b>	Special equipment
<b>SAZ</b>	Set
<b>SBE</b>	Heavy duty
<b>SBJ</b>	For vehicles with sports braking system
<b>SBJ</b>	Not for vehicles with sports braking system
<b>SBR</b>	For vehicles with disc brakes
<b>SCR</b>	For screw connection
<b>SCR</b>	Hatchback
<b>SDK</b>	Standard cab
<b>SFZ</b>	For special-purpose vehicles
<b>SLX</b>	For vehicles with SLX equipment
<b>SP</b>	Sport
<b>SPE</b>	Special (Combo)
<b>SPF</b>	Sports suspension
<b>SPN</b>	Not for vehicles with sports suspension
<b>SPT</b>	Equipment version: SPORT
<b>SSB</b>	Floating caliper brake
<b>SSZ</b>	For rough roads
<b>SSZ</b>	Not for rough roads
<b>STB</b>	For vehicles with front disc brakes and rear drum brakes
<b>STK</b>	For plug connection
<b>STU</b>	Notchback
<b>SVN</b>	Track not widened
<b>SVN</b>	Track widened
<b>T06</b>	For drum brake 203 x 38 mm and wheel brake cylinder with piston diameter 20.6 mm
<b>T26</b>	Brake drum diameter 260 mm
<b>TA</b>	For Taxi
<b>TA</b>	Except for taxi
<b>TBR</b>	For vehicles with drum brakes
<b>TEF</b>	For ATE (Teves) and Ferodo system
<b>TEJ</b>	For ATE (Alfred Teves) and Jurid system
<b>TEX</b>	For Textar system
<b>THJ</b>	Not for vehicles with TI-equipment
<b>TKO</b>	For vehicles with traction control
<b>TKO</b>	For vehicles without traction control
<b>TLV</b>	Turbo-look version
<b>TLV</b>	Not for Turbo-Look version
<b>TMA</b>	For ATE (Teves) system, vehicles with ABS
<b>TMA</b>	For ATE (Teves) system, vehicles without ABS
<b>TNK</b>	The vehicle data card is required for definite identification of the Bosch number. The components listed with the product must coincide with those on the data card.
<b>TR2</b>	For 200 x 40 mm drum brake and wheel brake cylinder with 17.5 mm piston diameter
<b>TR0</b>	Not for tropics
<b>TRV</b>	For vehicles with front and rear drum brakes
<b>TRW</b>	Manufacturer = TRW
<b>TSE</b>	For vehicles with SE equipment
<b>TW</b>	The product fitted must be identified on the vehicle or engine
<b>VAN</b>	For VAN
<b>VEA</b>	Heavy duty version
<b>VFC</b>	For vehicles with heavy duty suspension, for camper vehicle
<b>VFG</b>	For heavy duty chassis
<b>VLI</b>	Front, left side mounting
<b>VRE</b>	Front, right side mounting
<b>VSP</b>	For Sporting version
<b>VSP</b>	Not for Sporting version
<b>WAB</b>	Interchangeable Bosch product or part for Wabco
<b>XLA</b>	For vehicles with XL equipment
<b>Y61</b>	Brake disc diameter 340 mm
<b>Z15</b>	Diameter 15 inch
<b>ZBR</b>	For dual-circuit brake system
<b>ZE</b>	Two required
<b>ZTG</b>	For two-piece brake caliper
<b>ZWB</b>	For vehicles with double rear wheels
<b>ZWZ</b>	Brake caliper, 2 piston
<sup>3</sup>	Front
<sup>4</sup>	Rear
<sup>6</sup>	With piston
<sup>7</sup>	Without piston
<sup>8</sup>	Parts set with guide sleeves
<sup>9</sup>	Without piston, with handbrake components
<sup>U</sup>	With integrated controller



Part number



Rear axle



Special case



Passenger cars



Information/Explanations



Date/ Production period



Passenger cars/Small vans



Series



Chassis-No.



Dimensions



Wheel-brake cylinder



Engine power output in kW



Right brake caliper



Disc-brake caliper



Bosch exchange part



Hand-brake cable



Rotational-speed sensor



Cross-reference



Page reference



Page reference



Diameter



Front axle



<b>09Z</b>	Pour véhicules avec disques de frein de 9 pouces de diamètre	<b>5LO</b>	Jante 5 trous	<b>BO</b>	Bosch, uniquement comme remplacement pour équipement Bosch
<b>10Z</b>	Pour véhicules avec disques de frein de 10 pouces de diamètre	<b>5SP</b>	Pour véhicules à 5 places	<b>BRB</b>	Pour système Brembo
<b>14Z</b>	Diamètre de jante 14 pouces	<b>6LO</b>	Jante 6 trous	<b>BSB</b>	Etrier de frein avec garniture de frein à disque
<b>15Z</b>	Pour jantes de 15 pouces de diamètre	<b>7SP</b>	Pour véhicules à 7 places	<b>BSB</b>	Etrier de frein sans garniture de frein à disque
<b>165</b>	Pour jantes de 16,5 pouces de diamètre	<b>82Z</b>	Diamètre tambour de frein 228 mm	<b>BSC</b>	Corps d'étrier de frein peint en noir
<b>16R</b>	Pour des roues de 16 - 18 pouces	<b>AA</b>	Transmission intégrale	<b>BSR</b>	Corps d'étrier de frein peint en rouge
<b>16Z</b>	Pour jantes de 16 pouces de diamètre	<b>AA</b>	Sans transmission intégrale	<b>BSR</b>	Corps d'étrier de frein non peint en rouge
<b>19D</b>	Diamètre 190 mm	<b>ABM</b>	Tenir compte des dimensions	<b>BSY</b>	Pour système de freinage Bosch
<b>1KD</b>	Disque de frein arrière 226 x 10 mm pour jante 4 trous, avec étrier pas rouge	<b>ABO</b>	Pour véhicules sans ABS	<b>BUS</b>	Pour autobus
<b>1KP</b>	Disque de frein arrière 226 x 10 mm pour jante 4 trous, avec étrier rouge	<b>ABS</b>	Pour véhicules avec ABS	<b>CA</b>	Cabriolet
<b>1KX</b>	Disque de frein 313 x 26 mm	<b>ADE</b>	Pour véhicules avec équipement : S, Active, Dynamic, Emotion, Class	<b>CSA</b>	Produit disponible également en ligne "www.partbob.com"
<b>1LA</b>	Disque de frein 239 x 10 mm	<b>AEL</b>	Pour véhicules avec équipement EL	<b>D53</b>	Diamètre du disque de frein 253 mm
<b>1LM</b>	Disque de frein 239 x 12 mm	<b>AFS</b>	Pour véhicules avec régulation active d'inclinaison latérale	<b>D77</b>	Diamètre 17,78 mm
<b>1LQ</b>	Disque de frein 268 x 10 mm	<b>AG</b>	Pour véhicules avec boîte automatique	<b>D84</b>	Diamètre du disque de frein 284 mm
<b>1LV</b>	Disque de frein 280 x 22 mm pour jante 4 trous, avec étrier pas rouge	<b>AGH</b>	Pour boîtier en aluminium	<b>D85</b>	Diamètre disque de frein 285 mm
<b>1LW</b>	Disque de frein 280 x 22 mm pour jante 4 trous, avec étrier rouge	<b>AGT</b>	Version GT	<b>DMO</b>	Pour système Delco Moraine
<b>1LY</b>	Disque de frein 256 x 20 mm	<b>AIO</b>	Pour véhicules sans ABS ni disques de frein à ventilation interne	<b>DOP</b>	Cabine double
<b>20R</b>	Pour des roues de 20 pouces	<b>ALE</b>	Pas pour véhicules avec transmission intégrale	<b>DRK</b>	Ensemble capteur de vitesse/roulement de roue
<b>21Z</b>	Disque de frein 255 x 12 mm	<b>ALR</b>	Pour véhicules avec réglage automatique de la portée d'éclairage	<b>EAL</b>	Pour véhicules avec direction active électronique
<b>22Z</b>	Diamètre disque de frein 226 mm	<b>ALR</b>	Pour véhicules sans réglage automatique de la portée d'éclairage	<b>EAL</b>	Pour véhicules sans direction active électronique
<b>228</b>	Disque de frein 280 x 22 mm	<b>AMI</b>	Pour véhicules avec ABS et disques de freins à ventilation interne	<b>EBR</b>	Système de freinage à circuit unique
<b>23Z</b>	Disque de frein 232 x 9 mm	<b>AMI</b>	Pour véhicules avec ABS sans disques de freins à ventilation interne	<b>EDS</b>	Pour véhicules avec EDS (blocage électronique du différentiel)
<b>238</b>	Diamètre disque de frein 238 mm	<b>AMJ</b>	Pour la version Momo	<b>EFV</b>	Remplacement aussi pour ancien modèle
<b>239</b>	Disque de frein 239 x 20 mm	<b>AMJ</b>	Pas pour la version Momo	<b>EIZ</b>	Etrier de frein, 1 piston
<b>245</b>	Disque de frein 245 x 10 mm	<b>AOA</b>	Pour véhicules avec boîte automatique, sans ABS	<b>EMA</b>	Produit Bosch équivalent ou pièce pour Mando
<b>25Z</b>	Disque de frein 256 x 22 mm	<b>AOS</b>	Pour véhicules avec ABS, sans ASR	<b>ERH</b>	Pour véhicules à charge utile accrue
<b>254</b>	Diamètre 25,4 mm	<b>APG</b>	Pour AMG Performance Package	<b>ETG</b>	Pour étrier de frein monobloc
<b>256</b>	Disque de frein 256 x 12 mm	<b>ASR</b>	Pour véhicules avec ASR (régulation d'antipatinage à l'accélération)	<b>EU4</b>	Pour véhicules avec norme antipollution Euro 4
<b>257</b>	Diamètre du disque de frein 257 mm	<b>ATE</b>	Pour système ATE (Teves)	<b>EU5</b>	Pour véhicules avec norme antipollution Euro 5
<b>268</b>	Diamètre disque de frein 268 mm	<b>ATJ</b>	Pour version Trekking	<b>EZK</b>	Pour véhicules avec cabine individuelle
<b>278</b>	Diamètre disque de frein 278 mm	<b>ATN</b>	Pas pour version Trekking	<b>FAN</b>	Châssis version standard
<b>281</b>	Disque de frein 282 x 18 mm	<b>ATP</b>	Pour véhicules avec pack technique AMG	<b>FBD</b>	Produit Bosch équivalent ou pièce pour Bendix
<b>284</b>	Disque de frein 280 x 24 mm	<b>ATP</b>	Pour véhicules sans pack technique AMG	<b>FDO</b>	Pour système Ferodo
<b>288</b>	Disque de frein 288 x 25 mm	<b>B17</b>	Pour jantes de 17 pouces de diamètre	<b>FEB</b>	Pour frein à main électronique
<b>29Z</b>	Diamètre disque de frein 292 mm	<b>B18</b>	Pour jantes de 18 pouces de diamètre	<b>FEB</b>	Pas pour frein à main électronique
<b>294</b>	Diamètre disque de frein 294 mm	<b>B25</b>	Disque de frein 259 x 12 mm	<b>FEN</b>	Pour véhicules à suspension standard
<b>295</b>	Diamètre tambour de frein 295 mm	<b>B34</b>	Pour étrier de frein avec diamètre de piston 34 mm	<b>FEV</b>	Pour véhicules à suspension renforcée
<b>2TO</b>	Pour véhicules avec 2 barres de torsion	<b>B38</b>	Pour étrier de frein, diamètre de piston 38 mm	<b>FGS</b>	Pour châssis
<b>30Z</b>	Diamètre disque de frein 302 mm	<b>B41</b>	Pour étrier de frein, diamètre de piston 41 mm	<b>FGS</b>	Pas pour châssis
<b>305</b>	Diamètre disque de frein 305 mm	<b>B59</b>	Disque de frein 259 x 20 mm	<b>FHL</b>	Pour véhicules avec équipement HL
<b>308</b>	Diamètre du disque de frein 308 mm	<b>B80</b>	Bosch système 8.0	<b>FKR</b>	Pour véhicules à empattement court
<b>30R</b>	Pour véhicules avec empattement de 3050 mm	<b>B81</b>	Bosch système 8.1	<b>FLR</b>	Pour véhicules à empattement long
<b>31Z</b>	Diamètre disque de frein 312 mm	<b>BAS</b>	Pour système Bosch et véhicules avec ABS	<b>FMR</b>	Pour véhicules à empattement moyen
<b>31D</b>	Diamètre disque de frein 315 mm	<b>BAS</b>	Pour système Bosch et véhicules sans ABS	<b>FMS</b>	Pour véhicules avec disp. de protection spécial (blindage)
<b>321</b>	Disque de frein 321 x 30 mm	<b>BDE</b>	Pour Bendix Espagne (BENDIBERICA)	<b>FMS</b>	Pour véhicules sans disp. de protection spécial (blindage)
<b>32Z</b>	Disque de frein 314 x 22 mm	<b>BDS</b>	Avec siège rotatif	<b>FMU</b>	Pour véhicules avec dispositif anti-encrassement
<b>326</b>	Disque de frein 300 x 26 mm	<b>BDS</b>	Sans siège rotatif	<b>FMU</b>	Pour véhicules sans dispositif anti-encastrement
<b>33Z</b>	Diamètre disque de frein 332 mm	<b>BEL</b>	Fixation, 5 trous	<b>FPA</b>	Pour véhicules avec assistant de stationnement
<b>336</b>	Diamètre disque de frein 336 mm	<b>BES</b>	Fixation par vis	<b>FPA</b>	Pour véhicules sans assistant de stationnement
<b>34Z</b>	Disque de frein 347 x 30 mm	<b>BHO</b>	Pour véhicules des services publics	<b>FSB</b>	Frein à étrier flottant
<b>3LO</b>	Jante 3 trous	<b>BHO</b>	Pas pour véhicules administratifs	<b>G10</b>	Filetage M10 x 1
<b>3T5</b>	Pour les véhicules avec un PTAC de 3,5 t	<b>BKR</b>	Pour véhicules avec correcteur de freinage	<b>GBM</b>	Pour véhicules avec régulation de distance
<b>45Z</b>	Diamètre tambour de frein 254 mm	<b>BKR</b>	Pour véhicules sans correcteur de freinage	<b>GBM</b>	Pour véhicules sans régulation de distance
<b>4DB</b>	Pour jante 4 trous, véhicules sans ABS, système Bosch et Bendix	<b>BKV</b>	Pour véhicules avec servofrein	<b>GEM</b>	Boîtier métallique
<b>4-K</b>	Pour système à 4 canaux	<b>BKV</b>	Pour véhicules sans servofrein	<b>GIM</b>	Pour système Lucas-Girling, véhicules avec ABS
<b>4LO</b>	Jante 4 trous	<b>BLA</b>	Version noire	<b>GIM</b>	Pour système Lucas-Girling, véhicules sans ABS
<b>4SB</b>	Pour véhicules avec freins à disque à l'arrière			<b>GIR</b>	Pour système Lucas-Girling
<b>4TO</b>	Pour véhicules avec 4 barres de torsion			<b>GLA</b>	Version GL
				<b>GRF</b>	Version de base
				<b>GS</b>	Pour véhicules avec boîte manuelle

<b>GSI</b>	Version GSi
<b>GSO</b>	Pour véhicules sans ass. freinage d'urgence
<b>GXA</b>	Pour véhicules avec équipement GX
<b>H01</b>	Commander en même temps et remplacer la douille de serrage 2 261 024 304
<b>HAK</b>	Pour véhicules avec boîte manuelle, sans ABS ni climatiseur
<b>HLI</b>	Arrière, montage à gauche
<b>HLS</b>	Pour véhicules avec freins à disque, à l'arrière, montage à gauche
<b>HOA</b>	Pour véhicules avec boîte manuelle, sans ABS
<b>HRE</b>	Arrière, montage à droite
<b>HRS</b>	Pour véhicules avec freins à disque, à l'arrière, montage à droite
<b>HSA</b>	Pour véhicules avec boîte manuelle et ABS
<b>HTB</b>	Pour véhicules avec freins à tambour à l'arrière
<b>HBA</b>	Disques de frein à ventilation interne pour véhicules sans ABS
<b>INB</b>	Disque de frein à ventilation interne
<b>INB</b>	Disque de frein sans ventilation interne
<b>ITB</b>	Pour système de freinage ITT
<b>JUR</b>	Pour système Jurid
<b>KL</b>	Pour véhicules avec climatiseur
<b>KL</b>	Pour véhicules sans climatiseur
<b>KOB</b>	Pour break
<b>KOM</b>	Break avec catalyseur
<b>KW</b>	Pour fourgon
<b>KZB</b>	Identifiant : bleu
<b>KZG</b>	Identifiant : vert
<b>KZR</b>	Identifiant : rouge
<b>KZU</b>	Identifiant : gris
<b>L01</b>	Charge utile 800 kg
<b>L02</b>	Charge utile 1800 kg
<b>L03</b>	Charge utile inférieure à 1800 kg
<b>L06</b>	Charge utile 1000 kg
<b>L07</b>	Charge utile 1400 kg
<b>L10</b>	Longueur : 1025 mm
<b>L13</b>	Longueur : 1345 mm
<b>L65</b>	Longueur: 650 mm
<b>LAB</b>	Montage à gauche
<b>LAU</b>	Pour véhicules avec équipement L
<b>LFS</b>	Frein à étrier flottant Lucas
<b>LGM</b>	Pour modèle bas "grade"
<b>LGS</b>	Pour berline avec boîte manuelle
<b>LIA</b>	Pour berline avec ABS
<b>LIM</b>	Pour berline
<b>LKR</b>	Pour véhicules avec direction à gauche et empattement court
<b>LLE</b>	Pour véhicules avec direction à gauche
<b>LLT</b>	Pour véhicules avec direction à gauche et freins à tambour
<b>LOC</b>	Pour système Lockheed
<b>LUC</b>	Produit Bosch équivalent ou pièce pour Lucas
<b>LUX</b>	Version de luxe
<b>LWG</b>	Pour fourgonnette
<b>LWG</b>	Pas pour fourgonnette
<b>LWR</b>	Sans réglage de la portée d'éclairage
<b>LXA</b>	Pour véhicules avec équipement LX
<b>MB</b>	Commande mécanique
<b>MBB</b>	Pour frein/système Mercedes Benz
<b>MEH</b>	Avec un seul axe de liaison
<b>MET</b>	Pour véhicules avec ETS et ASR
<b>MEF</b>	Pour véhicules sans ETS et ASR
<b>MFD</b>	Pour véhicules avec ESP (régulation électronique du comportement dynamique)
<b>MI</b>	Au milieu
<b>MIH</b>	Avec support
<b>MIH</b>	Sans support
<b>MOJ</b>	Pour version Monster
<b>MOJ</b>	Pas pour version Monster
<b>MTG</b>	Avec poids amortisseur
<b>MTG</b>	Sans poids amortisseur
<b>MVB</b>	Pour véhicules avec témoin d'usure de garniture de frein
<b>MVB</b>	Pour véhicules sans témoin d'usure de garniture de frein
<b>MZH</b>	Avec deux broches de maintien
<b>NAA</b>	Pas pour transmission intégrale
<b>NFS</b>	Pour série spéciale Baccara/Initiale
<b>NFS</b>	Pas pour série spéciale Baccara/Initiale
<b>NWV</b>	Sans régulation de niveau
<b>NNC</b>	Pour véhicules à suspension renforcée, pas pour véhicules de camping
<b>NON</b>	Pour véhicules à charge utile normale
<b>NOR</b>	Version standard
<b>OAS</b>	Pour véhicules sans ASR (régulation d'antipatinage à l'accélération)
<b>OED</b>	Pour véhicules sans blocage électronique du différentiel
<b>OFD</b>	Pour véhicules sans ESP (régulation électronique du comportement dynamique)
<b>OFF</b>	Pour véhicules sans régulation active d'inclinaison latérale
<b>OZB</b>	Pour véhicules avec pneus simples
<b>PAJ</b>	Pour version avec kit Pandemonium
<b>PAJ</b>	Pas pour version avec kit Pandemonium
<b>PEO</b>	Pour système/freins Perrot
<b>PFN</b>	Pas pour système de freinage BMW Performance
<b>PW</b>	Pour camion-plateau
<b>PW</b>	Pas pour camion-plateau
<b>R30</b>	Pour véhicules avec empattement de 3000 mm
<b>R33</b>	Pour véhicules avec empattement de 3350 mm
<b>R35</b>	Pour véhicules avec empattement de 3550 mm
<b>R37</b>	Pour véhicules avec empattement de 3700 mm
<b>R40</b>	Pour véhicules avec empattement de 4025 mm
<b>RAB</b>	Montage à droite
<b>RBA</b>	Pour véhicules avec ABS Bosch
<b>RKR</b>	Pour véhicules avec direction à droite et empattement court
<b>RLE</b>	Pour véhicules avec direction à droite
<b>RSB</b>	Frein à cadre-étrier
<b>S25</b>	Disque de frein 256 x 25 mm
<b>S31</b>	Disque de frein 314 x 25 mm
<b>SA</b>	Equipement spécial
<b>SAZ</b>	Jeu
<b>SBE</b>	Haute sollicitation
<b>SBJ</b>	Pour véhicules avec système de freinage sport
<b>SBJ</b>	Pas pour véhicules avec système de freinage sport
<b>SBR</b>	Pour véhicules avec freins à disque
<b>SCK</b>	Pour raccord vissant
<b>SCR</b>	Arrière incliné
<b>SDK</b>	Cabine standard
<b>SFZ</b>	Pour véhicules spéciaux
<b>SLX</b>	Pour véhicules avec équipement SLX
<b>SP</b>	Sport
<b>SPE</b>	Spécial (Combo)
<b>SPF</b>	Suspension sport
<b>SPN</b>	Pas pour véhicules avec suspension sport
<b>SPT</b>	Variante d'équipement : SPORT
<b>SSB</b>	Frein à étrier flottant
<b>SSZ</b>	Pour routes en mauvais état
<b>SSZ</b>	Pas pour routes en mauvais état
<b>STB</b>	Pour véhicules avec freins à disque à l'avant et freins à tambour à l'arrière
<b>STK</b>	Pour connecteur mâle
<b>STU</b>	Véhicule 3 volumes
<b>SVN</b>	Voie pas élargie
<b>SVN</b>	Voie élargie
<b>T06</b>	Pour frein à tambour 203 x 38 mm et cyl. frein de roue av. diamètre piston de 20,6 mm
<b>T26</b>	Diamètre tambour de frein 260 mm
<b>TA</b>	Pour taxis
<b>TA</b>	Pas pour taxi
<b>TBR</b>	Pour véhicules avec freins à tambour
<b>TEF</b>	Pour ATE (Teves) et système Ferodo
<b>TEJ</b>	Pour ATE (Alfred Teves) et système Jurid
<b>TEX</b>	Pour système Textar
<b>THJ</b>	Pas pour véhicules avec équipement TI
<b>TKO</b>	Pour véhicules avec contrôle de traction
<b>TKO</b>	Pour véhicules sans contrôle de traction
<b>TLV</b>	Version turbo-look
<b>TLV</b>	Pas pour version turbo-look
<b>TMA</b>	Pour système ATE (Teves), véhicules avec ABS
<b>TMA</b>	Pour système ATE (Teves), véhicules sans ABS
<b>TNK</b>	Vous devez disposer de la carte signalétique du véhicule pour l'identification exacte de la référence Bosch. Les composants énumérés pour le produit doivent correspondre à ceux de la carte signalétique.
<b>TR2</b>	Pour frein à tambour 200 x 40 mm et cylindre de frein de roue avec diamètre de piston de 17,5 mm
<b>TRØ</b>	Pas pour climats tropicaux
<b>TRV</b>	Pour véhicules avec frein à tambour à l'avant et à l'arrière
<b>TRW</b>	Fabricant = TRW
<b>TSE</b>	Pour véhicules avec équipement SE
<b>TW</b>	Le produit monté doit être déterminé sur le véhicule ou le moteur.
<b>VAN</b>	Pour VAN
<b>VEA</b>	Version renforcée
<b>VFC</b>	Pour véhicules à suspension renforcée, pour véhicules de camping
<b>VFG</b>	Pour châssis renforcé
<b>VLI</b>	Avant, montage à gauche
<b>VRE</b>	Avant, montage à droite
<b>VSP</b>	Pour version Sporting
<b>VSP</b>	Pas pour version Sporting
<b>WAB</b>	Produit Bosch équivalent ou pièce pour Wabco
<b>XLA</b>	Pour véhicules avec équipement XL
<b>Y61</b>	Diamètre du disque de frein 340 mm
<b>Z15</b>	Diamètre 15 pouces
<b>ZBR</b>	Pour système de freinage à double circuit
<b>ZE</b>	2 nécessaires
<b>ZTG</b>	Pour étrier de frein bipartite
<b>ZWB</b>	Pour véhicules avec pneus jumelés
<b>ZWZ</b>	Etrier de frein, 2 pistons
<sup>3</sup>	Avant
<sup>4</sup>	Arrière
<sup>6</sup>	Avec piston
<sup>7</sup>	Sans piston
<sup>8</sup>	Jeu de pièces avec guides de butée d'embrayage
<sup>9</sup>	Sans piston, avec pièces de frein à main
<sup>U</sup>	Avec régulateur intégré



fr



Référence



Essieu arrière



Cas spécial



Voiture particulière



Information / explication



Date/période de montage



Voiture particulière / véhicule utilitaire léger



Série



Numéro de châssis



Dimensions



Cylindre de frein de roue



Puissance du moteur en kW



Etrier de frein droit



Etrier de frein



Pièce d'échange standard Bosch



Câble de frein à main



Capteur de vitesse de rotation



Comparaison



Renvoi à la page



Renvoi de page



Diamètre



Essieu avant



<b>09Z</b>	Per veicoli con disco freno diametro 9 pollici
<b>10Z</b>	Per veicoli con disco freno diametro 10 pollici
<b>14Z</b>	Diametro cerchione 14 pollici
<b>15Z</b>	Per diametro cerchio 15 pollici
<b>16S</b>	Per diametro cerchio 16,5 pollici
<b>16R</b>	Con ruote da 16 - 18 pollici
<b>16Z</b>	Per diametro cerchio 16 pollici
<b>19D</b>	Diametro 190 mm
<b>1KD</b>	Disco freno posteriore 226 x 10 mm per cerchio a 4 fori, con pinza freno non rossa
<b>1KP</b>	Disco freno posteriore 226 x 10 mm per cerchio a 4 fori, con pinza freno rossa
<b>1KX</b>	Disco freno 313 x 26 mm
<b>1LA</b>	Disco freno 239 x 10 mm
<b>1LM</b>	Disco freno 239 x 12 mm
<b>1LQ</b>	Disco freno 268 x 10 mm
<b>1LV</b>	Disco freno 280 x 22 mm per cerchio a 4 fori, con pinza freno non rossa
<b>1LW</b>	Disco freno 280 x 22 mm per cerchio a 4 fori, con pinza freno rossa
<b>1LY</b>	Disco freno 256 x 20 mm
<b>20R</b>	Con ruote da 20 pollici
<b>21Z</b>	Disco freno 255 x 12 mm
<b>226</b>	Diametro disco freno 226 mm
<b>228</b>	Disco freno 280 x 22 mm
<b>23Z</b>	Disco freno 232 x 9 mm
<b>238</b>	Diametro disco freno 238 mm
<b>239</b>	Disco freno 239 x 20 mm
<b>245</b>	Disco freno 245 x 10 mm
<b>25Z</b>	Disco freno 256 x 22 mm
<b>254</b>	Diametro 25,4 mm
<b>256</b>	Disco freno 256 x 12 mm
<b>257</b>	Diametro disco freno 257 mm
<b>268</b>	Diametro disco freno 268 mm
<b>278</b>	Diametro disco freno 278 mm
<b>281</b>	Disco freno 282 x 18 mm
<b>284</b>	Disco freno 280 x 24 mm
<b>288</b>	Disco freno 288 x 25 mm
<b>29Z</b>	Diametro disco freno 292 mm
<b>294</b>	Diametro disco freno 294 mm
<b>29S</b>	Diametro tamburo freno 295 mm
<b>2T0</b>	Per veicoli con 2 barre di torsione
<b>30Z</b>	Diametro disco freno 302 mm
<b>30S</b>	Diametro disco freno 305 mm
<b>308</b>	Diametro disco freno 308 mm
<b>30R</b>	Per veicoli con passo 3050 mm
<b>31Z</b>	Diametro disco freno 312 mm
<b>31D</b>	Diametro disco freno 315 mm
<b>321</b>	Disco freno 321 x 30 mm
<b>32Z</b>	Disco freno 314 x 22 mm
<b>326</b>	Disco freno 300 x 26 mm
<b>33Z</b>	Diam. disco freno 332 mm
<b>336</b>	Diametro disco freno 336 mm
<b>34Z</b>	Disco freno 347 x 30 mm
<b>3L0</b>	Cerchione a 3 fori
<b>3T5</b>	Per veicoli con peso massimo complessivo ammesso di 3,5 t
<b>45Z</b>	Diametro tamburo freno 254 mm
<b>4DB</b>	Per cerchione a 4 fori, veicoli senza ABS, sistema Bosch e Bendix
<b>4-K</b>	Per sistema 4 canali
<b>4L0</b>	Cerchione a 4 fori
<b>4SB</b>	Per veicoli con freni a disco posteriori
<b>4T0</b>	Per veicoli con 4 barre di torsione
<b>5L0</b>	Cerchione a 5 fori
<b>5SP</b>	Per veicoli a 5 posti
<b>6L0</b>	Cerchione a 6 fori
<b>7SP</b>	Per veicoli a 7 posti
<b>82Z</b>	Diametro tamburo freno 228 mm
<b>AA</b>	Trazione integrale
<b>AA</b>	Senza trazione integrale
<b>ABM</b>	Considerare le dimensioni esterne
<b>ABO</b>	Per veicoli senza ABS
<b>ABS</b>	Per veicoli con ABS
<b>ADE</b>	Per veicoli con equipaggiamento: S, Active, Dynamic, Emotion, Class
<b>AEL</b>	Per veicoli con equipaggiamento EL
<b>AFS</b>	Per veicoli con regolazione attiva inclinazione laterale
<b>AG</b>	Per veicoli con cambio automatico
<b>AGH</b>	Per alloggiamento in alluminio
<b>AGT</b>	Versione GT
<b>AIO</b>	Per veicoli senza ABS e senza dischi freno autoventilati
<b>ALE</b>	Non per veicoli con sterzo trazione integrale
<b>ALR</b>	Per veicoli con regolazione automatica profondità fascio luminoso
<b>ALR</b>	Per veicoli senza regolazione automatica incidenza fascio luminoso
<b>AMI</b>	Per veicoli con ABS e dischi freni autoventilati
<b>AMH</b>	Per veicoli con ABS senza dischi freni autoventilati
<b>AMJ</b>	Per esecuzione Momo
<b>AMJ</b>	Non per esecuzione Momo
<b>AOA</b>	Per veicoli con cambio automatico, senza ABS
<b>AOS</b>	Per veicoli con ABS, senza ASR
<b>APG</b>	Per AMG Performance Package
<b>ASR</b>	Per veicoli dotati di ASR (regolazione antipattinamento in accelerazione)
<b>ATE</b>	Per sistema ATE (Teves)
<b>ATJ</b>	Per esecuzione Trekking
<b>ATN</b>	Non per esecuzione Trekking
<b>ATP</b>	Per veicoli con pacchetto AMG Technik
<b>ATP</b>	Per veicoli senza pacchetto AMG Technik
<b>B17</b>	Per diametro cerchio 17 pollici
<b>B18</b>	Per diametro cerchio 18 pollici
<b>B2S</b>	Disco freno 259 x 12 mm
<b>B34</b>	Per pinza freno con diametro pistone 34 mm
<b>B38</b>	Per pinza freno con diametro pistone 38 mm
<b>B41</b>	Per pinza freno con diametro pistone 41 mm
<b>B59</b>	Disco freno 259 x 20 mm
<b>B80</b>	Sistema Bosch 8.0
<b>B81</b>	Sistema Bosch 8.1
<b>BAS</b>	Per sistema Bosch e veicoli con ABS
<b>BAS</b>	Per sistema Bosch e veicoli senza ABS
<b>BDE</b>	Per Bendix Spagna (BENDIBERICA)
<b>BDS</b>	Con sede girevole
<b>BDS</b>	Senza sede girevole
<b>BEL</b>	Fissaggio a 5 fori
<b>BES</b>	Fissaggio con viti
<b>BHO</b>	Per veicoli delle autorità
<b>BHO</b>	Non per i veicoli delle autorità
<b>BKR</b>	Per veicoli con correttore di frenata
<b>BKR</b>	Per veicoli senza correttore di frenata
<b>BKV</b>	Per veicoli con servofreno
<b>BKV</b>	Per veicoli senza servofreno
<b>BLA</b>	Versione in nero
<b>BO</b>	Solo come ricambio per l'equipaggiamento Bosch
<b>BRB</b>	Per sistema Brembo
<b>BSB</b>	Pinza freno con pastiglie freno a disco
<b>BSB</b>	Pinza freno senza guarnizioni freno a disco
<b>BSC</b>	Alloggiamento pinze freno verniciato in nero
<b>BSR</b>	Alloggiamento pinza freno verniciato in rosso
<b>BSR</b>	Alloggiamento pinza freno non verniciata in rosso
<b>BSY</b>	Per sistema frenante Bosch
<b>BUS</b>	Per autobus
<b>CA</b>	Cabriolet
<b>CSA</b>	Prodotto ordinabile anche online "www.partbob.com"
<b>D53</b>	Diametro disco freno 253 mm
<b>D77</b>	Diametro 17,78 mm
<b>D84</b>	Diametro disco freno 284 mm
<b>D8S</b>	Diametro disco freno 285 mm
<b>DMO</b>	Prodotto Bosch equivalente o pezzo per Delco Moraine
<b>DOP</b>	Cabina doppia
<b>DRK</b>	Combinazione sensore giri/cuscinetto ruota
<b>EAL</b>	Per veicoli con sterzo attivo elettronico
<b>EAL</b>	Per veicoli senza sterzo attivo elettronico
<b>EBR</b>	Impianto frenante a circuito semplice
<b>EDS</b>	Per veicoli con EDS (bloccaggio elettronico differenziale)
<b>EFV</b>	Ricambio anche per il modello precedente
<b>EIZ</b>	Pinza freno, 1 pistone
<b>EMA</b>	Prodotto Bosch identico o componente per Mando
<b>ERH</b>	Per veicoli con un carico utile superiore
<b>ETG</b>	Per pinza freno monopezzo
<b>EU4</b>	Per veicoli con norma sui gas di scarico Euro 4
<b>EU5</b>	Per veicoli con norma sui gas di scarico Euro 5
<b>EZK</b>	Per veicoli con cabina singola
<b>FAN</b>	Telaio versione standard
<b>FBD</b>	Prodotto Bosch equivalente o pezzo Bendix
<b>FDO</b>	Per sistema Ferodo
<b>FEB</b>	Per freno di stazionamento elettronico
<b>FEB</b>	Non per freno di stazionamento elettronico
<b>FEN</b>	Per veicoli con sospensioni normali
<b>FEV</b>	Per veicoli con sospensioni rinforzate
<b>FGS</b>	Per telaio
<b>FGS</b>	Non per autotelaio
<b>FHL</b>	Per veicoli con equipaggiamento HL
<b>FKR</b>	Per veicoli a passo corto
<b>FLR</b>	Per veicoli a passo lungo
<b>FMR</b>	Per veicoli a passo medio
<b>FMS</b>	Per veicoli con protezione speciale (blindati)
<b>FMS</b>	Per veicoli senza protezione speciale (non blindati)
<b>FMU</b>	Per veicoli con protezione sottostruttura
<b>FMU</b>	Per veicoli senza protezione sottostruttura
<b>FPA</b>	Per veicoli con assistente al parcheggio
<b>FPA</b>	Per veicoli senza assistente al parcheggio
<b>FSB</b>	Freno a pinza flottante
<b>G10</b>	Filettatura di raccordo M10 x 1
<b>GBM</b>	Per veicoli con regolazione della distanza
<b>GBM</b>	Per veicoli senza regolazione della distanza
<b>GEM</b>	Corpo metallico
<b>GIM</b>	Per sistema Lucas-Girling, veicoli con ABS
<b>GIM</b>	Per sistema Lucas-Girling, veicoli senza ABS
<b>GIR</b>	Per sistema Lucas-Girling
<b>GLA</b>	Versione GL
<b>GRF</b>	Versione base
<b>GS</b>	Per veicoli con cambio meccanico
<b>GSI</b>	Versione GSi
<b>GSO</b>	Per veicoli senza assistente freno di emergenza
<b>GXA</b>	Per veicoli con equipaggiamento GX



<b>HO1</b>	Ordinare anche la bussola di serraggio 2 261 024 304 e sostituirla
<b>HAK</b>	Per veicoli con cambio meccanico, senza ABS e climatizzatore
<b>HLI</b>	Posteriore, montaggio a sinistra
<b>HLS</b>	Per veicoli con freno a disco, posteriore, montaggio a sinistra
<b>HOA</b>	Per veicoli con cambio meccanico, senza ABS
<b>HRE</b>	Posteriore, montaggio a destra
<b>HRS</b>	Per veicoli con freno a disco, posteriore, montaggio a destra
<b>HSA</b>	Per veicoli con cambio meccanico e ABS
<b>HTB</b>	Per veicoli con freni a tamburo sull'assale posteriore
<b>HBA</b>	Dischi freni autoventilati per veicoli senza ABS
<b>INB</b>	Disco freno autoventilato
<b>INB</b>	Disco freno senza ventilazione interna
<b>ITB</b>	Per sistema frenante ITT
<b>JUR</b>	Per sistema Jurid
<b>KL</b>	Per veicoli con climatizzatore
<b>KL</b>	Per veicoli senza climatizzatore
<b>KOB</b>	Per station wagon
<b>KOM</b>	Station wagon con catalizzatore
<b>KW</b>	Per furgone
<b>KZB</b>	Contrassegno: blu
<b>KZG</b>	Contrassegno: verde
<b>KZR</b>	Contrassegno: rosso
<b>KZU</b>	Contrassegno: grigio
<b>L01</b>	Carico utile 800 kg
<b>L02</b>	Carico utile 1800 kg
<b>L03</b>	Carico utile inferiore a 1800 kg
<b>L06</b>	Carico utile 1000 kg
<b>L07</b>	Carico utile 1400 kg
<b>L10</b>	Lunghezza 1025 mm
<b>L13</b>	Lunghezza 1345 mm
<b>L65</b>	Lunghezza: 650 mm
<b>LAB</b>	Montaggio a sinistra
<b>LAU</b>	Per veicoli con equipaggiamento L
<b>LFS</b>	Freno a pinza flottante Lucas
<b>LGM</b>	Per modello basso "grade"
<b>LGS</b>	Per berlina con cambio meccanico
<b>LIA</b>	Per berlina con ABS
<b>LIM</b>	Per berlina
<b>LKR</b>	Per veicoli con guida a sinistra e passo corto
<b>LLE</b>	Per guida a sinistra
<b>LLT</b>	Per veicoli con guida a sinistra e freno a tamburo
<b>LOC</b>	Prodotto Bosch equivalente o pezzo per Lockheed
<b>LUC</b>	Prodotto o parte Bosch di dimensioni identiche per Lucas
<b>LUX</b>	Versione lusso
<b>LWG</b>	Per furgone per consegne
<b>LWG</b>	Non per furgone per consegne
<b>LWR</b>	Senza regolazione profondità fascio luminoso
<b>LXA</b>	Per veicoli con equipaggiamento LX
<b>MB</b>	Azionamento meccanico
<b>MBB</b>	Per freno/sistema Mercedes-Benz
<b>MEH</b>	Con un perno di fissaggio
<b>MET</b>	Per veicoli con ETS e ASR
<b>MET</b>	Per veicoli senza ETS e ASR
<b>MFD</b>	Per veicoli con ESP (programma elettronico di stabilità)
<b>MI</b>	Intermedio
<b>MIH</b>	Con supporto
<b>MIH</b>	Senza supporto
<b>MOJ</b>	Per esecuzione Monster
<b>MOJ</b>	Non per esecuzione Monster
<b>MTG</b>	Con peso compensatore
<b>MTG</b>	Senza peso compensatore
<b>MVB</b>	Per veicoli con indicazione di usura guarnizioni freni
<b>MVB</b>	Per veicoli senza indicatore usura guarnizioni freni
<b>MZH</b>	Con due perni di fissaggio
<b>NAA</b>	Non per trazione integrale
<b>NFS</b>	Per modello speciale Baccara/Iniziale
<b>NFS</b>	Non per modello speciale Baccara/Iniziale
<b>NWV</b>	Senza regolazione del livello
<b>NNC</b>	Per veicoli con sospensioni normali, non per camper
<b>NON</b>	Per veicoli con un carico utile normale
<b>NOR</b>	Versione normale
<b>OAS</b>	Per i veicoli senza ASR (regolazione antipattinamento in accelerazione)
<b>OED</b>	Per veicoli senza bloccaggio elettronico differenziale
<b>OFD</b>	Per veicoli senza controllo elettronico di stabilità (ESP)
<b>OFS</b>	Per veicoli senza regolazione attiva inclinazione laterale
<b>OZB</b>	Per veicoli con pneumatici singoli
<b>PAJ</b>	Per esecuzione con Pandemonium Kit
<b>PAJ</b>	Non per esecuzione con Pandemonium Kit
<b>PEO</b>	Per sistema Perrot-Bremse
<b>PFN</b>	Non per impianto frenante BMW Performance
<b>PW</b>	Per pick-up
<b>PW</b>	Non per pick-up
<b>R30</b>	Per veicoli con passo di 3000 mm
<b>R33</b>	Per veicoli con passo di 3350 mm
<b>R35</b>	Per veicoli con passo di 3550 mm
<b>R37</b>	Per veicoli con passo di 3700 mm
<b>R40</b>	Per veicoli con passo di 4025 mm
<b>RAB</b>	Montaggio a destra
<b>RBA</b>	Per veicolo con ABS Bosch
<b>RKR</b>	Per veicoli con guida a destra, a passo corto
<b>RLE</b>	Per guida a destra
<b>RSB</b>	Freno a pinza flottante
<b>S25</b>	Disco freno 256 X 25mm
<b>S31</b>	Disco freno 314 x 25 mm
<b>SA</b>	Equipaggiamento speciale
<b>SAZ</b>	Serie
<b>SBE</b>	Per forti sollecitazioni
<b>SBJ</b>	Per veicoli con impianto frenante sportivo
<b>SBJ</b>	Non per veicoli con impianto frenante sportivo
<b>SBR</b>	Per veicoli con freni a disco
<b>SCK</b>	Per collegamento a vite
<b>SCR</b>	A due volumi
<b>SDK</b>	Cabina standard
<b>SFZ</b>	Per veicoli speciali
<b>SLX</b>	Per veicoli con equipaggiamento SLX
<b>SP</b>	Equipaggiamento sportivo
<b>SPE</b>	Speciale (Combo)
<b>SPF</b>	Sospensioni sportive
<b>SPN</b>	Non per veicoli con sospensioni sportive
<b>SPT</b>	Variante di equipaggiamento: SPORT
<b>SSB</b>	Freno a pinza flottante
<b>SSZ</b>	Per manto stradale in cattive condizioni
<b>SSZ</b>	Non per manto stradale in cattive condizioni
<b>STB</b>	Per veicoli con freni a disco sull'assale anteriore e freni a tamburo sull'assale posteriore
<b>STK</b>	Per collegamento a spina
<b>STU</b>	A tre volumi
<b>SVN</b>	Carreggiata non allargata
<b>SVN</b>	Carreggiata allargata
<b>T06</b>	Per freno a tamburo 203 x 38 mm e cilindretto freno con diametro pistone 20,6 mm
<b>T26</b>	Diametro tamburo freno 260 mm
<b>TA</b>	Per taxi
<b>TA</b>	Non per taxi
<b>TBR</b>	Per veicoli con freni a tamburo
<b>TEF</b>	Per sistema ATE (Teves) e Ferodo
<b>TEJ</b>	Per sistema ATE (Alfred Teves) e Jurid
<b>TEX</b>	Per sistema Textar
<b>TIJ</b>	Non per veicoli con equipaggiamento TI
<b>TKO</b>	Per veicoli con controllo trazione
<b>TKO</b>	Per veicoli senza controllo trazione
<b>TLV</b>	Versione Turbo-Look
<b>TLV</b>	Non per versione Turbo-Look
<b>TMA</b>	Per sistema ATE (Teves), veicoli con ABS
<b>TMA</b>	Per sistema ATE (Teves), veicoli senza ABS
<b>TNK</b>	Per un'identificazione sicura del numero Bosch deve essere disponibile la scheda dati del veicolo. I componenti riportati sul prodotto devono coincidere con quelli nella scheda dati.
<b>TR2</b>	Per freno a tamburo 200 x 40 mm e cilindretto del freno con diametro pistone 17,5 mm
<b>TR0</b>	Non per climi tropicali
<b>TRV</b>	Per veicoli con freni a tamburo sull'assale anteriore e sull'assale posteriore
<b>TRW</b>	Produttore = TRW
<b>TSE</b>	Per veicoli con equipaggiamento SE
<b>TW</b>	Il prodotto montato deve essere rilevato sul veicolo o sul motore.
<b>VAN</b>	Per VAN
<b>VEA</b>	Versione rinforzata
<b>VFC</b>	Per veicoli con sospensioni rinforzate, per camper
<b>VFG</b>	Per un telaio rinforzato
<b>VLI</b>	Anteriore, montaggio a sinistra
<b>VRE</b>	Anteriore, montaggio a destra
<b>VSP</b>	Per versione Sporting
<b>VSP</b>	Non per versione Sporting
<b>WAB</b>	Prodotto Bosch equivalente o pezzo per Wabco
<b>XLA</b>	Per veicoli con equipaggiamento XL
<b>Y61</b>	Diametro disco freno 340 mm
<b>Z15</b>	Diametro 15 pollici
<b>ZBR</b>	Per impianto frenante a due circuiti
<b>ZE</b>	Sono necessari due pezzi
<b>ZTG</b>	Per pinza freno in due parti
<b>ZWB</b>	Per veicoli con ruote gemellate
<b>ZWZ</b>	Pinza freno, 2 pistoni
<sup>3</sup>	Anteriore
<sup>4</sup>	Posteriore
<sup>6</sup>	Con pistoni
<sup>7</sup>	Senza pistoni
<sup>8</sup>	Kit pezzi con boccole di scorrimento
<sup>9</sup>	Senza pistoni, con componenti freno a mano
<sup>U</sup>	Con regolatore integrato

it



Numero di ordinazione



Assale posteriore



Caso specifico



Autovettura



Informazione / dichiarazione



Data/Periodo di montaggio



Autovettura / furgone



Serie



N. di telaio



Dimensione



Cilindro freno ruota



Potenza motore in kW



Pinza freno lato destro



Pinza freno



Componente revisionato Bosch



Cavo freno a mano



Sensore giri



Confronto



Rimando ad un'altra pagina



Riferimento pag.



Diametro



Assale anteriore





<b>09Z</b>	Para vehículos con diámetro de discos de freno de 9 pulgadas
<b>10Z</b>	Para vehículos con diámetro de discos de freno de 10 pulgadas
<b>14Z</b>	Diámetro de llanta 14 pulgadas
<b>15Z</b>	Para diámetro de llanta de 15 pulgadas
<b>165</b>	Para diámetro de llanta de 16,5 pulgadas
<b>16R</b>	Con ruedas de 16 - 18 pulgadas
<b>16Z</b>	Para diámetro de llanta de 16 pulgadas
<b>19D</b>	Diámetro de 190 mm
<b>1KD</b>	Disco de freno trasero 226 x 10 mm para llanta de 4 orificios, con pinza de freno no roja
<b>1KP</b>	Disco de freno trasero 226 x 10 mm para llanta de 4 orificios, con pinza de freno roja
<b>1KX</b>	Disco de freno 313 x 26 mm
<b>1LA</b>	Disco de freno 239 x 10 mm
<b>1LM</b>	Disco de freno 239 x 12 mm
<b>1LQ</b>	Disco de freno 268 x 10 mm
<b>1LV</b>	Disco de freno 280 x 22 mm para llanta de 4 orificios, con pinza de freno no roja
<b>1LW</b>	Disco de freno 280 x 22 mm para llanta de 4 orificios, con pinza de freno roja
<b>1LY</b>	Disco de freno de 256 x 20 mm
<b>20R</b>	Con ruedas de 20 pulgadas
<b>21Z</b>	Disco de freno de 255 x 12 mm
<b>226</b>	Diámetro disco de freno 226 mm
<b>228</b>	Disco de freno 280 x 22 mm
<b>232</b>	Disco de freno 232 x 9 mm
<b>238</b>	Diámetro de disco de freno de 238 mm
<b>239</b>	Disco de freno 239 x 20 mm
<b>245</b>	Disco de freno 245 x 10 mm
<b>252</b>	Disco de freno 256 x 22 mm
<b>254</b>	Diámetro de 25,4 mm
<b>256</b>	Disco de freno de 256 x 12 mm
<b>257</b>	Diámetro de disco de freno de 257 mm
<b>268</b>	Diámetro de disco de freno de 268 mm
<b>278</b>	Diámetro disco de freno 278 mm
<b>281</b>	Disco de freno de 282 x 18 mm
<b>284</b>	Disco de freno de 280 x 24 mm
<b>288</b>	Disco de freno de 288 x 25 mm
<b>292</b>	Diámetro de disco de freno de 292 mm
<b>294</b>	Diámetro disco de freno 294 mm
<b>295</b>	Diámetro de tambor de freno de 295 mm
<b>2TO</b>	Para vehículos con dos barras de torsión
<b>302</b>	Diámetro del disco de freno 302 mm
<b>305</b>	Diámetro del disco de freno 305 mm
<b>308</b>	Diámetro de disco de freno de 308 mm
<b>30R</b>	Para vehículos con distancia entre ejes de 3050 mm
<b>312</b>	Diámetro de disco de freno de 312 mm
<b>31D</b>	Diámetro de disco de freno de 315 mm
<b>321</b>	Disco de freno 321 x 30 mm
<b>322</b>	Disco de freno 314 x 22 mm
<b>326</b>	Disco de freno 300 x 26 mm
<b>332</b>	Diámetro disco de freno 332 mm
<b>336</b>	Diámetro de disco de freno de 336 mm
<b>347</b>	Disco de freno de 347 x 30 mm
<b>3LO</b>	Llanta de tres orificios
<b>3T5</b>	Para vehículos con un peso total admisible de 3,5 t
<b>452</b>	Diámetro de tambor de freno de 254 mm
<b>4DB</b>	Para llanta de 4 orificios, vehículos sin ABS, Sistema Bosch y Bendix
<b>4-K</b>	Para sistema de 4 canales
<b>4LO</b>	Llanta de 4 orificios

<b>4SB</b>	Para vehículos con frenos de disco detrás
<b>4TO</b>	Para vehículos con 4 barras de torsión
<b>5LO</b>	Llanta de 5 orificios
<b>5SP</b>	Para vehículos con 5 asientos
<b>6LO</b>	Llanta de 6 orificios
<b>7SP</b>	Para vehículos con 7 asientos
<b>82Z</b>	Diámetro de tambor de freno de 228 mm
<b>AA</b>	Tracción total
<b>AA</b>	Sin tracción total
<b>ABM</b>	Observar las medidas
<b>ABO</b>	Para vehículos sin ABS
<b>ABS</b>	Para vehículos con ABS
<b>ADE</b>	Para vehículos con equipamiento: S, Active, Dynamic, Emotion, Class
<b>AEL</b>	Para vehículos con equipamiento EL
<b>AFS</b>	Para vehículos con regulación inclinación lateral activa
<b>AG</b>	Para vehículos con cambio automático
<b>AGH</b>	Para carcasa de aluminio
<b>AGT</b>	Modelo GT
<b>AIO</b>	Para vehículos sin ABS y sin discos de freno ventilados
<b>ALE</b>	No para vehículos con sistema de dirección en las cuatro ruedas
<b>ALR</b>	Para vehículos con regulación de alcance de alumbrado automática
<b>ALR</b>	Para vehículos sin regulación de alcance de luces automática
<b>AMI</b>	Para vehículos con ABS y discos de freno ventilados interiormente
<b>AMH</b>	Para vehículos con ABS sin discos de freno ventilados interiormente
<b>AMJ</b>	Para ejecución Momo
<b>AMJ</b>	No para ejecución Momo
<b>AOA</b>	Para vehículos con cambio automático, sin ABS
<b>AOS</b>	Para vehículos con ABS, sin ASR
<b>APG</b>	Para AMG Performance Package
<b>ASR</b>	Para los vehículos equipados con ASR (regulación de deslizamiento de aceleración)
<b>ATE</b>	Para sistema ATE (Teves)
<b>ATJ</b>	Para la versión Trekking
<b>ATN</b>	No para la versión Trekking
<b>ATP</b>	Para vehículos con paquete de técnica AMG
<b>ATP</b>	Para vehículos sin paquete de técnica AMG
<b>B17</b>	Para diámetro de llanta de 17 pulgadas
<b>B18</b>	Para diámetro de llanta de 18 pulgadas
<b>B25</b>	Disco de freno de 259 x 12 mm
<b>B34</b>	Para pinza de freno con diámetro del émbolo de 34 mm
<b>B38</b>	Para pinza de freno con un diámetro de pistón de 38 mm
<b>B41</b>	Para pinza de freno con un diámetro de pistón de 41 mm
<b>B59</b>	Disco de freno de 259 x 20 mm
<b>B80</b>	Bosch System 8.0
<b>B81</b>	Bosch System 8.1
<b>BAS</b>	Para sistema Bosch y vehículos con ABS
<b>BAS</b>	Para sistema Bosch y vehículos con ABS
<b>BDE</b>	Para Bendix España (BENDIBERICA)
<b>BDS</b>	Con asiento giratorio
<b>BDS</b>	Sin asiento giratorio
<b>BEL</b>	Fijación de cinco orificios
<b>BES</b>	Fijación con tornillos
<b>BHO</b>	Para vehículos oficiales
<b>BHO</b>	No para vehículo oficial

<b>BKR</b>	Para vehículos con regulador de la fuerza de frenado
<b>BKR</b>	Para vehículos sin amplificador de fuerza de frenado
<b>BKV</b>	Para vehículos con amplificador de fuerza de frenado
<b>BKV</b>	Para vehículos sin amplificador de fuerza de frenado
<b>BLA</b>	Ejecución en negro
<b>BO</b>	Bosch, sólo como producto de sustitución para el equipo Bosch
<b>BRB</b>	Para sistema Brembo
<b>BSB</b>	Pinza de freno con pastillas para los frenos de disco
<b>BSB</b>	Pinza de freno sin pastillas de freno de disco
<b>BSC</b>	Carcasa de pinza de freno pintada en negro
<b>BSR</b>	Carcasa de la pinza de freno pintada de rojo
<b>BSR</b>	Carcasa de la pinza portapastillas no pintada de rojo
<b>BSY</b>	Para sistema de frenos Bosch
<b>BUS</b>	Para autobus
<b>CA</b>	Cabriolet
<b>CSA</b>	Producto también por pedido online "www.partbob.com"
<b>D53</b>	Diámetro de disco de freno de 253 mm
<b>D77</b>	Diámetro de 17,78 mm
<b>D84</b>	Diámetro de disco de freno de 284 mm
<b>D85</b>	Diámetro del disco de freno 285 mm
<b>DMO</b>	Producto Bosch para sistema Delco Moraine
<b>DOP</b>	Cabina doble
<b>DRK</b>	Combinación de sensor de número de revoluciones y cojinete de rueda
<b>EAL</b>	Para vehículos con dirección activa electrónica
<b>EAL</b>	Para vehículos sin dirección activa electrónica
<b>EBR</b>	Para sistema de frenado de un circuito
<b>EDS</b>	Para vehículos con EDS (bloqueo diferencial electrónico)
<b>EFV</b>	También sustitución del anterior
<b>EIZ</b>	Pinza de freno, 1 émbolos
<b>EMA</b>	Producto Bosch de igual montaje o pieza para Mando
<b>ERH</b>	Para vehículos con carga útil elevada
<b>ETG</b>	Para pinza de freno de una pieza
<b>EU4</b>	Para vehículos con norma de gases de escape EURO 4
<b>EU5</b>	Para vehículos con norma de gases de escape EURO 5
<b>EZK</b>	Para vehículos con cabina individual
<b>FAN</b>	Chasis estándar de la versión
<b>FBD</b>	Producto Bosch de dimensiones idénticas para Bendix
<b>FDO</b>	Para sistema Ferodo
<b>FEB</b>	Para freno de estacionamiento electrónico
<b>FEB</b>	No para freno de estacionamiento electrónico
<b>FEN</b>	Para vehículos con suspensión normal
<b>FEV</b>	Para vehículos con suspensión reforzada
<b>FGS</b>	Para chasis
<b>FGS</b>	No para chasis
<b>FHL</b>	Para vehículos con equipamiento HL
<b>FKR</b>	Para vehículos con corta distancia entre ejes
<b>FLR</b>	Para vehículos con larga distancia entre ejes
<b>FMR</b>	Para vehículos con distancia media entre ejes
<b>FMS</b>	Para vehículos con protección especial (con blindaje)

<b>FMS</b>	Para vehículos sin protección especial (sin blindaje)	<b>LKR</b>	Para vehículos con volante a la izquierda con distancia corta entre ejes	<b>RBA</b>	Para sistema antibloqueo Bosch-ABS
<b>FMU</b>	Para vehículos con protección de submarcha	<b>LLE</b>	Para dirección a la izquierda	<b>RKR</b>	Para vehículos con volante a la derecha con distancia corta entre ejes
<b>FMU</b>	Para vehículos sin protección de submarcha	<b>LLT</b>	Para vehículos con volante a la izquierda con freno de tambor	<b>RLE</b>	Para vehículos de volante a la derecha
<b>FPA</b>	Para vehículos con avisador de distancia de aparcamiento	<b>LOC</b>	Producto o pieza Bosch para sistema Lockheed	<b>RSB</b>	Pinza de freno con bastidor
<b>FPA</b>	Para vehículos sin avisador de distancia de aparcamiento	<b>LUC</b>	Producto o pieza Bosch de dimensiones idénticas para Lucas	<b>S25</b>	Disco de freno 256 x 25 mm
<b>FSB</b>	Freno de pinza flotante	<b>LUX</b>	Modelo de lujo	<b>S31</b>	Disco de freno de 314 x 25 mm
<b>G10</b>	Rosca de conexión M10 x 1	<b>LWG</b>	Para vehículos de reparto	<b>SA</b>	Equipo especial
<b>GBM</b>	Para vehículos con regulación de distancia	<b>LWG</b>	No para vehículo de reparto	<b>SAZ</b>	Juego
<b>GBM</b>	Para vehículos sin regulación de distancia	<b>LWR</b>	Sin regulación del alcance de alumbrado	<b>SBE</b>	Fuerte esfuerzo
<b>GEM</b>	Carcasa de metal	<b>LXA</b>	Para vehículos con equipamiento LX	<b>SBJ</b>	Para vehículos con sistema deportivo de frenos
<b>GIM</b>	Para sistema Lucas-Girling, vehículos con ABS	<b>MB</b>	Accionamiento mecánico	<b>SBJ</b>	No para vehículos con sistema deportivo de frenos
<b>GIM</b>	Para sistema Lucas-Girling, vehículos con ABS	<b>MBB</b>	Para sistema/freno Mercedes-Benz	<b>SBR</b>	Para vehículos con frenos de disco
<b>GIR</b>	Producto Bosch para sistema Lucas-Girling	<b>MEH</b>	Con un pasador de retención	<b>SCK</b>	Para conexión roscada
<b>GLA</b>	Versión GL	<b>MET</b>	Para vehículos con ETS y ASR	<b>SCR</b>	popa inclinada
<b>GRF</b>	Modelo básico	<b>MEF</b>	Para vehículos sin ETS y ASR	<b>SDK</b>	Cabina standard
<b>GS</b>	Para vehículos con cambio manual	<b>MFD</b>	Para vehículos con programa de estabilidad electrónica (ESP)	<b>SFZ</b>	Para vehículos especiales
<b>GSI</b>	Versión GSi	<b>MI</b>	Medio	<b>SLX</b>	Para vehículos con equipamiento SLX
<b>GSO</b>	Para vehículos sin asistente de freno de emergencia	<b>MIH</b>	Con soporte	<b>SP</b>	Equipo deportivo
<b>GXA</b>	Para vehículos con equipamiento GX	<b>MIH</b>	Sin soporte	<b>SPE</b>	Especial (Combo)
<b>H01</b>	pedir conjuntamente manguito de apriete 2 261 024 304 y cambiarlo	<b>MOJ</b>	Para ejecución Monster	<b>SPF</b>	Suspensión deportiva
<b>HAK</b>	Para vehículos con cambio manual, sin ABS y sin acondicionador de aire	<b>MOJ</b>	No para ejecución Monster	<b>SPN</b>	No para vehículos con motor suspensión deportiva
<b>HLI</b>	Detrás, montaje a la izquierda	<b>MTG</b>	Con peso de amortiguación	<b>SPT</b>	Variante de equipamiento: SPORT
<b>HLS</b>	Para vehículos con frenos de disco, detrás, montaje a la izquierda	<b>MTG</b>	Sin peso de amortiguación	<b>SSB</b>	Freno de pinza flotante
<b>HOA</b>	Para vehículos con cambio manual, sin ABS	<b>MVB</b>	Para vehículos con indicación de desgaste del forro de freno	<b>SSZ</b>	Para calles en mal estado
<b>HRE</b>	Detrás, montaje a la derecha	<b>MVB</b>	Para vehículos sin indicación de desgaste del forro de freno	<b>SSZ</b>	No para calles en mal estado
<b>HRS</b>	Para vehículos con frenos de disco, detrás, montaje a la derecha	<b>MZH</b>	Con dos pasadores de retención	<b>STB</b>	Para vehículos con frenos de disco delante y frenos de tambor detrás
<b>HSA</b>	Para vehículos con cambio manual y ABS	<b>NAA</b>	No para tracción total	<b>STK</b>	Para conexión por enchufe
<b>HTB</b>	Para vehículos con frenos de tambor detrás	<b>NFS</b>	Para modelo especial Baccara/Iniciel	<b>STU</b>	popa escalonada
<b>IBA</b>	Discos de freno ventilados para vehículos sin ABS	<b>NFS</b>	No para modelo especial Baccara/Iniciel	<b>SVN</b>	Vía no ensanchada
<b>INB</b>	Disco de freno con ventilación interior	<b>NIV</b>	Sin regulación de nivel	<b>SVN</b>	Vía ensanchada
<b>INB</b>	Disco de freno sin ventilación interior	<b>NNC</b>	Para vehículos con suspensión normal, no para vehículo de camping	<b>T06</b>	Para freno de tambor 203 x 38 mm y cilindro de freno de rueda con diámetro de émbolos 20,6 mm
<b>ITB</b>	Para sistema de frenos ITT	<b>NON</b>	Para vehículos con carga útil normal	<b>T26</b>	Diámetro de tambor de freno de 260 mm
<b>JUR</b>	Producto Bosch Jurid	<b>NOR</b>	Versión normal	<b>TA</b>	Para taxi
<b>KL</b>	Para vehículos con acondicionador de aire	<b>OAS</b>	Para los vehículos equipados sin ASR (regulación de deslizamiento de aceleración)	<b>TA</b>	No para taxi
<b>KL</b>	Para vehículos sin acondicionador de aire	<b>OED</b>	Para vehículos sin bloqueo diferencial electrónico	<b>TBR</b>	Para vehículos con frenos de tambor
<b>KOB</b>	Para vehículos combinados	<b>OFD</b>	Para vehículos sin ESP (programa de estabilidad electrónico)	<b>TEF</b>	Para sistema ATE (Teves) y Ferodo
<b>KOM</b>	Vehículos combinados con catalizador	<b>OFS</b>	Para vehículos sin regulación inclinación lateral activa	<b>TEJ</b>	Para sistema ATE (Alfred Teves) y Jurid
<b>KW</b>	Para furgoneta	<b>OZB</b>	Para vehículos con neumáticos individuales	<b>TEX</b>	Para sistema Textar
<b>KZB</b>	Distintivo característico de color: azul	<b>PAJ</b>	Para ejecución con kit Pandemonium	<b>THJ</b>	No para vehículos con equipamiento TI
<b>KZG</b>	Distintivo característico: verde	<b>PAJ</b>	No para ejecución con kit Pandemonium	<b>TKO</b>	Para vehículos con control de tracción
<b>KZR</b>	Distintivo característico: rojo	<b>PEO</b>	Para sistema freno Perrot	<b>TKO</b>	Para vehículos sin control de tracción
<b>KZU</b>	Distintivo característico: gris	<b>PFN</b>	No para sistema de frenos BMW Performance	<b>TLV</b>	Versión turbo-look
<b>L01</b>	Carga útil de 800 kg	<b>PW</b>	Para vehículo con plataforma de carga	<b>TLV</b>	No para versión Turbo-Look
<b>L02</b>	Carga útil de 1800 kg	<b>PW</b>	No para camión con plataforma	<b>TMA</b>	Para sistema ATE (Teves), vehículos con ABS
<b>L03</b>	Carga útil inferior a 1800 kg	<b>R30</b>	Para vehículos con distancia entre ejes de 3000 mm	<b>TMA</b>	Para sistema ATE (Teves), vehículos sin ABS
<b>L06</b>	Carga útil de 1000 kg	<b>R33</b>	Para vehículos con distancia entre ejes de 3350 mm	<b>TNK</b>	Para identificación inequívoca del número Bosch se debe tener a la vista la tarjeta de datos del vehículo. Los componentes enumerados en el producto deben coincidir con los de la tarjeta de datos.
<b>L07</b>	Carga útil de 1400 kg	<b>R35</b>	Para vehículos con distancia entre ejes de 3550 mm	<b>TR2</b>	Para freno de tambor 200 x 40 mm y cilindro de freno de rueda con diámetro de pistón de 17,5 mm
<b>L10</b>	Longitud: 1025 mm	<b>R37</b>	Para vehículos con distancia entre ejes de 3700 mm	<b>TR0</b>	No para los trópicos
<b>L13</b>	Longitud: 1345 mm	<b>R40</b>	Para vehículos con distancia entre ejes de 4025 mm	<b>TRV</b>	Para vehículos con frenos de tambor delante y detrás
<b>L65</b>	Longitud: 650 mm	<b>RAB</b>	montaje a la derecha	<b>TRW</b>	Fabricante = TRW
<b>LAB</b>	Montaje a la izquierda			<b>TSE</b>	Para vehículos con equipamiento SE
<b>LAU</b>	Para vehículos con equipamiento L				
<b>LFS</b>	Freno de pinza flotante Lucas				
<b>LGM</b>	Para modelo bajo "recto"				
<b>LGS</b>	Para berlina con cambio manual				
<b>LIA</b>	Para berlina con ABS				
<b>LIM</b>	Para berlina				









<b>TW</b>	El producto montado se debe determinar en el vehículo o en el motor.
<b>VAN</b>	Para monovolumen
<b>VEA</b>	Versión reforzada
<b>VFC</b>	Para vehículos con suspensión reforzada, para vehículo de camping
<b>VFG</b>	Para chasis reforzado
<b>VLI</b>	Delante, montaje a la izquierda
<b>VRE</b>	Delante, montaje a la derecha
<b>VSP</b>	Para versión Sporting

<b>VSP</b>	No para versión Sporting
<b>WAB</b>	Producto o pieza Bosch de dimensiones idénticas para Wabco
<b>XLA</b>	Para vehículos con equipamiento XL
<b>Y61</b>	Diámetro de disco de freno de 340 mm
<b>Z15</b>	Diámetro de 15 pulgadas
<b>ZBR</b>	Para sistema de frenado de dos circuitos
<b>ZE</b>	2 necesarios
<b>ZTG</b>	Para pinza de freno de dos piezas
<b>ZWB</b>	Para vehículos con neumáticos gemelos

<b>ZWZ</b>	Pinza de freno, 2 émbolos
3	Delante
4	Atrás
6	Con pistón
7	Sin pistón
8	Juego de piezas con manguitos de guía
9	Sin pistón, con piezas de freno de mano
U	Con regulador integrado

	Número de referencia
	Caso especial
	Información / explicación
	Fecha/periodo de fabricación
	Turismo / furgoneta
	de serie
	Número de chasis
	Dimensiones
	Cilindro de rueda
	Potencia del motor en kW
	Pinza de freno derecha
	Pinza de freno de disco
	Pieza de intercambio Bosch
	Cable de freno de mano
	Sensor de revoluciones
	Confrontación

	Referencia de página
	Referencia de páginas
	Diámetro
	Eje delantero
	Eje trasero
	Turismo



<b>09Z</b>	Voor voertuigen met remschijven van 9 inch in diameter
<b>10Z</b>	Voor voertuigen met remschijven van 10 inch in diameter
<b>14Z</b>	Velgdiameter 14 inch
<b>15Z</b>	Voor velgdiameter 15 inch
<b>165</b>	Voor velgdiameter 16,5 inch
<b>16R</b>	Bij 16 - 18-inch velgen
<b>16Z</b>	Voor velgdiameter 16 inch
<b>19D</b>	Diameter 190 mm
<b>1KD</b>	Remschijf achter 226 x 10 mm voor velg met 4-gaten, met niet-rood remzadel
<b>1KP</b>	Remschijf achter 226 x 10 mm voor velg met 4-gaten, met rood remzadel
<b>1KX</b>	Remschijf 313 x 26 mm
<b>1LA</b>	Remschijf 239 x 10 mm
<b>1LM</b>	Remschijf 239 x 12 mm
<b>1LQ</b>	Remschijf 268 x 10 mm
<b>1LV</b>	Remschijf 280 x 22 mm voor velg met 4-gaten, met niet-rood remzadel
<b>1LW</b>	Remschijf 280 x 22 mm voor velg met 4-gaten, met rood remzadel
<b>1LY</b>	Remschijf 256 x 20 mm
<b>20R</b>	Bij 20-inch velgen
<b>21Z</b>	Remschijf 255 x 12 mm
<b>226</b>	Diameter remschijf 226 mm
<b>228</b>	Remschijf 280 x 22 mm
<b>232</b>	Remschijf 232 x 9 mm
<b>238</b>	Diameter remschijf 238 mm
<b>239</b>	Remschijf 239 x 20 mm
<b>245</b>	Remschijf 245 x 10 mm
<b>252</b>	Remschijf 256 x 22 mm
<b>254</b>	Diameter 25,4 mm
<b>256</b>	Remschijf 256 x 12 mm
<b>257</b>	Diameter remschijf 257 mm
<b>268</b>	Diameter remschijf 268 mm
<b>278</b>	diameter remschijf 278 mm
<b>281</b>	Remschijf 282 x 18 mm
<b>284</b>	Remschijf 280 x 24 mm
<b>288</b>	Remschijf 288 x 25 mm
<b>292</b>	Diameter remschijf 292 mm
<b>294</b>	diameter remschijf 294 mm
<b>295</b>	Diameter remtrommel 295 mm
<b>2TO</b>	Voor voertuigen met 2 torsiestaven
<b>302</b>	Diameter remschijf 302 mm
<b>305</b>	Diameter remschijf 305 mm
<b>308</b>	Diameter remschijf 308 mm
<b>30R</b>	Voor voertuigen met wielbasis 3050 mm
<b>312</b>	Diameter remschijf 312 mm
<b>31D</b>	Diameter remschijf 315 mm
<b>321</b>	Remschijf 321 x 30 mm
<b>322</b>	Remschijf 314 x 22 mm
<b>326</b>	Remschijf 300 x 26 mm
<b>332</b>	Diameter remschijf 332 mm
<b>336</b>	Diameter remschijf 336 mm
<b>347</b>	Remschijf 347 x 30 mm
<b>3LO</b>	Velg met 3 gaten
<b>3T5</b>	Voor voertuigen met toegest. totaalgew. v. 3,5 t
<b>452</b>	Diameter remtrommel 254 mm
<b>4DB</b>	Voor velg met 4 gaten, voertuigen zonder ABS, Bosch- en Bendix-systeem
<b>4-K</b>	Voor 4-kanalsysteem
<b>4LO</b>	Velg met 4 gaten
<b>45B</b>	Voor voertuigen met schijfremmen achter
<b>4TO</b>	Voor voertuigen met 4 torsiestaven
<b>5LO</b>	Velg met vijf gaten
<b>5SP</b>	Voor voertuigen met 5 zitplaatsen
<b>6LO</b>	Velg met 6 gaten
<b>7SP</b>	Voor voertuigen met 7 zitplaatsen
<b>82Z</b>	Diameter remtrommel 228 mm
<b>AA</b>	Vierwiel aandrijving
<b>AA</b>	Zonder vierwiel aandrijving
<b>ABM</b>	Afmetingen controleren
<b>ABO</b>	Voor voertuigen zonder ABS
<b>ABS</b>	Voor voertuigen met ABS
<b>ADE</b>	Voor voertuigen met uitrusting: S, Active, Dynamic, Emotion, Class
<b>AEL</b>	Voor voertuigen met EL-uitrusting
<b>AFS</b>	Voor voertuigen met actieve bochthellingsregeling
<b>AG</b>	Voor voertuigen met automatische transmissie
<b>AGH</b>	Voor aluminium behuizing
<b>AGT</b>	GT-uitvoering
<b>AIO</b>	Voor voertuigen zonder ABS en zonder intern geventileerde remschijven
<b>ALE</b>	Niet voor voertuigen met voor- en achterwielbesturing
<b>ALR</b>	Voor voertuigen met automatische koplampafstelling
<b>ALR</b>	Voor voertuigen zonder automatische koplampafstelling
<b>AMI</b>	Voor voertuigen met ABS en intern geventileerde remschijven
<b>AMI</b>	Voor voertuigen met ABS en zonder intern geventileerde remschijven
<b>AMJ</b>	Voor uitvoering Momo
<b>AMJ</b>	Niet voor uitvoering Momo
<b>AOA</b>	Voor voertuigen met automatische transmissie, zonder ABS
<b>AOS</b>	Voor voertuigen met ABS, zonder ASR
<b>APG</b>	Voor AMG Performance Package
<b>ASR</b>	Voor voertuigen met ASR (anti-doorslipregelsysteem)
<b>ATE</b>	Voor ATE systeem (Teves)
<b>ATJ</b>	Voor uitvoering Trekking
<b>ATN</b>	Niet voor uitvoering Trekking
<b>ATP</b>	Voor voertuigen met AMG Technik-pakket
<b>ATP</b>	Voor voertuigen zonder AMG-technikpakket
<b>B17</b>	Voor velgdiameter 17 inch
<b>B18</b>	Voor velgdiameter 18 inch
<b>B25</b>	Remschijf 259 x 12 mm
<b>B34</b>	Voor remzadel met zuigerdiameter 34 mm
<b>B38</b>	Voor remzadel met zuigerdiameter van 38 mm
<b>B41</b>	Voor remzadel met zuigerdiameter van 41 mm
<b>B59</b>	Remschijf 259 x 20 mm
<b>B80</b>	Bosch Systeem 8.0
<b>B81</b>	Bosch Systeem 8,1
<b>BAS</b>	Voor Bosch-systeem en voertuigen met ABS
<b>BAS</b>	Voor Bosch-systeem en voertuigen zonder ABS
<b>BDE</b>	Voor Bendix Spanje (BENDIBERICA)
<b>BDS</b>	Met draaistoel
<b>BDS</b>	Zonder draaistoel
<b>BEL</b>	Bevestiging, 5 gaten
<b>BES</b>	Bevestiging met schroeven
<b>BHO</b>	Voor overheidsvoertuigen
<b>BHO</b>	Niet voor overheidsvoertuigen
<b>BKR</b>	Voor voertuigen met remkrachtregelaar
<b>BKR</b>	Voor voertuigen zonder remkrachtregelaar
<b>BKV</b>	Voor voertuigen met rembekrachtiger
<b>BKV</b>	Voor voertuigen zonder rembekrachtiger
<b>BLA</b>	Uitvoering zwart
<b>BO</b>	Bosch, alleen als vervangend product voor Bosch-uitrusting
<b>BRB</b>	Voor Brembo-systeem
<b>BSB</b>	Remzadel met schijfremblokken
<b>BGB</b>	Remzadel zonder schijfremblokken
<b>BSC</b>	Remzadelhuis zwart gelakt
<b>BSR</b>	Remzadelhuis rood gespoten
<b>BSR</b>	Remzadelhuis niet rood gelakt
<b>BSY</b>	Voor Bosch-remstelsysteem
<b>BUS</b>	Voor bus
<b>CA</b>	Cabriolet
<b>CSA</b>	Artikel ook online te bestellen "www.partbob.com"
<b>D53</b>	Diameter remschijf 253 mm
<b>D77</b>	Diameter 17,78 mm
<b>D84</b>	Diameter remschijf 284 mm
<b>D85</b>	Diameter remschijf 285 mm
<b>DMO</b>	Bosch-product met identieke inbouw of onderdeel voor Delco Moraine
<b>DOP</b>	Dubbele cabine
<b>DRK</b>	Combinatie toerentalvoeler/wiellager
<b>EAL</b>	Voor voertuigen met elektronische actieve besturing
<b>EAL</b>	Voor voertuigen zonder elektronische actieve besturing
<b>EBR</b>	Eenkringsremstelsysteem
<b>EDS</b>	Voor voertuigen met EDS (elektronische differentieelgrendel)
<b>EFV</b>	Ook vervanging voor vorige versies
<b>EIZ</b>	Remzadel, 1 zuiger
<b>EMA</b>	Equivalent Bosch-product of onderdeel voor Mando
<b>ERH</b>	Voor voertuigen met verhoogd laadvermogen
<b>ETG</b>	Voor eendelig remzadel
<b>EU4</b>	Voor voertuigen met uitlaatgasemissienorm EURO 4
<b>EU5</b>	Voor voertuigen met uitlaatgasemissienorm EURO 5
<b>EZK</b>	Voor voertuigen met enkele cabine
<b>FAN</b>	Chassis standaard uitvoering
<b>FBD</b>	Bosch-product met identieke inbouw of onderdeel voor Bendix
<b>FDO</b>	Voor Ferodo-systeem
<b>FEB</b>	Voor elektronische handrem
<b>FEB</b>	Niet voor elektronische handrem
<b>FEN</b>	Voor voertuigen met een normale vering
<b>FEV</b>	Voor voertuigen met een versterkte vering
<b>FGS</b>	Voor chassis
<b>FGS</b>	Niet voor chassis
<b>FHL</b>	Voor voertuigen met HL-uitrusting
<b>FKR</b>	Voor voertuigen met korte wielbasis
<b>FLR</b>	Voor voertuigen met lange wielbasis
<b>FMR</b>	Voor voertuigen met gemiddelde wielbasis
<b>FMS</b>	Voor voertuigen met speciale bescherming (gepantserd)
<b>FMS</b>	Voor voertuigen zonder speciale bescherming (ongepantserd)
<b>FMU</b>	Voor voertuigen met bodembeschermplaat
<b>FMU</b>	Voor voertuigen zonder bodembeschermplaat
<b>FPA</b>	Voor voertuigen met parkeerassistent
<b>FPA</b>	Voor voertuigen zonder parkeerassistent
<b>FSB</b>	Rem met zwevend remzadel
<b>G10</b>	Aansluit Schroefdraad M10 x 1
<b>GBM</b>	Voor voertuigen met afstandsregeling



<b>GBM</b>	Voor voertuigen zonder afstandsregeling
<b>GEM</b>	Metalen behuizing
<b>GIM</b>	Voor Lucas-Girling-systeem, voertuigen met ABS
<b>GIM</b>	Voor Lucas-Girling-systeem, voertuigen zonder ABS
<b>GIR</b>	Voor Lucas-Girling-systeem
<b>GLA</b>	GL-uitvoering
<b>GRF</b>	Basismodel
<b>GS</b>	Voor voertuigen met handgeschakelde transmissie
<b>GSI</b>	GSI-uitvoering
<b>GSO</b>	Voor voertuigen zonder noodremassistent
<b>GXA</b>	Voor voertuigen met GX-uitrusting
<b>HO1</b>	Drukstuk 2 261 024 304 meebestellen en vervangen
<b>HAK</b>	Voor voertuigen met handgeschakelde transmissie, zonder ABS en zonder airconditioning
<b>HLI</b>	Achter, aanbouw links
<b>HLS</b>	Voor voertuigen met schijfrem, achter, aanbouw links
<b>HOA</b>	Voor voertuigen met handgeschakelde transmissie, zonder ABS
<b>HRE</b>	Achter, aanbouw rechts
<b>HRS</b>	Voor voertuigen met schijfrem, achter, aanbouw rechts
<b>HSA</b>	Voor voertuigen met handgeschakelde transmissie en ABS
<b>HTB</b>	Voor voertuigen met trommelremmen achter
<b>HBA</b>	Intern geventileerde remschijven voor voertuigen zonder ABS
<b>INB</b>	Aan binnenzijde geventileerde remschijf
<b>INB</b>	Remschijf niet intern geventileerd
<b>ITB</b>	Voor ITT-remstelsysteem
<b>JUR</b>	Voor Jurid-systeem
<b>KL</b>	Voor voertuigen met airconditioning
<b>KL</b>	Voor voertuigen zonder airconditioning
<b>KOB</b>	Voor stationwagens
<b>KOM</b>	Stationwagen met katalysator
<b>KW</b>	Voor bestelwagen
<b>KZB</b>	Identificatie: blauw
<b>KZG</b>	Identificatie: groen
<b>KZR</b>	Identificatie: rood
<b>KZU</b>	Identificatie: grijs
<b>L01</b>	Laadvermogen 800 kg
<b>L02</b>	Laadvermogen 1800 kg
<b>L03</b>	Laadvermogen kleiner dan 1800 kg
<b>L06</b>	Laadvermogen 1000 kg
<b>L07</b>	Laadvermogen 1400 kg
<b>L10</b>	Lengte 1025 mm
<b>L13</b>	Lengte 1345 mm
<b>L65</b>	Lengte: 650 mm
<b>LAB</b>	Montage links
<b>LAU</b>	Voor voertuigen met L-uitrusting
<b>LFS</b>	Rem met zwevend remzadel Lucas
<b>LGM</b>	Voor laag model "grade"
<b>LGS</b>	Voor sedan met handgeschakelde transmissie
<b>LIA</b>	Voor sedan met ABS
<b>LIM</b>	Voor sedan
<b>LKR</b>	Voor voertuigen met stuur links en korte wielbasis
<b>LLE</b>	Voor voertuigen met stuur links
<b>LLT</b>	Voor voertuigen met stuur links en trommelrem
<b>LOC</b>	Voor Lockheed-systeem
<b>LUC</b>	Bosch-product met identieke inbouw of onderdeel voor Lucas
<b>LUX</b>	Luxe model
<b>LWG</b>	Voor bestelwagens
<b>LWG</b>	Niet voor bestelwagens
<b>LWR</b>	Zonder koplampafstelling
<b>LXA</b>	Voor voertuigen met LX-uitrusting
<b>MB</b>	Mechanische bediening
<b>MBB</b>	Voor Mercedes Benz-rem/-systeem
<b>MEH</b>	Met één borgpen
<b>MET</b>	Voor voertuigen met ETS en ASR
<b>MET</b>	Voor voertuigen zonder ETS en ASR
<b>MFD</b>	Voor voertuigen met elektronisch stabiliteitsprogramma (ESP)
<b>MI</b>	Midden
<b>MIH</b>	Met houder
<b>MIH</b>	Zonder houder
<b>MOJ</b>	Voor uitvoering Monster
<b>MOJ</b>	Niet voor uitvoering Monster
<b>MTG</b>	Met tegengewicht
<b>MTG</b>	Zonder tegengewicht
<b>MVB</b>	Voor voertuigen met indicatie remvoeringslijtage
<b>MVB</b>	Voor voertuigen zonder indicatie remvoeringslijtage
<b>MZH</b>	Met twee verbindingssassen
<b>NAA</b>	Niet voor vierwielaandrijving
<b>NFS</b>	Voor speciale modellen Baccara/Initiale
<b>NFS</b>	Niet voor speciale modellen Baccara/Initiale
<b>NIV</b>	Zonder niveauregeling
<b>NNC</b>	Voor voertuigen met normale vering, niet voor campers
<b>NON</b>	Voor voertuigen met normaal laadvermogen
<b>NOR</b>	Standaardversie
<b>OAS</b>	Voor voertuigen zonder anti-doorslipregelsysteem (ASR)
<b>OED</b>	Voor voertuigen zonder elektronische differentieelgrendel
<b>OFD</b>	Voor voertuigen zonder rijdynamische regeling (ESP)
<b>OFS</b>	Voor voertuigen zonder actieve bochthellingsregeling
<b>OZB</b>	Voor voertuigen met één band per asuiteinde
<b>PAJ</b>	Voor uitvoering met Pandemonium Kit
<b>PAJ</b>	Niet voor uitvoering met Pandemonium Kit
<b>PEO</b>	Voor Perrot-remmen systeem
<b>PFN</b>	Niet voor BMW Performance remstelsysteem
<b>PW</b>	Voor platte vrachtauto
<b>PW</b>	Niet voor platte vrachtauto
<b>R30</b>	Voor voertuigen met wielbasis van 3000 mm
<b>R33</b>	Voor voertuigen met wielbasis 3350 mm
<b>R35</b>	Voor voertuigen met wielbasis van 3550 mm
<b>R37</b>	Voor voertuigen met wielbasis 3700 mm
<b>R40</b>	Voor voertuigen met wielbasis van 4025 mm
<b>RAB</b>	Aanbouw rechts
<b>RBA</b>	Voor voertuigen met Bosch-ABS
<b>RKR</b>	Voor voertuigen met stuur rechts en korte wielbasis
<b>RLE</b>	Voor voertuig met stuur rechts
<b>RSB</b>	Chassiszadelremmen
<b>S25</b>	Remschijf 256 x 25 mm
<b>S31</b>	Remschijf 314 x 25 mm
<b>SA</b>	Speciale uitrusting
<b>SAZ</b>	Set
<b>SBE</b>	Zware belasting
<b>SBJ</b>	Voor voertuigen met sportreminstallatie
<b>SBJ</b>	Niet voor voertuigen met sportreminstallatie
<b>SBR</b>	Voor voertuigen met schijfremmen
<b>SCK</b>	Voor schroefaansluiting
<b>SCR</b>	Fastback
<b>SDK</b>	Standaardcabine
<b>SFZ</b>	Voor speciale voertuigen
<b>SLX</b>	Voor voertuigen met SLX-uitrusting
<b>SP</b>	Sport
<b>SPE</b>	Speciaal (Combo)
<b>SPF</b>	Sportophanging
<b>SPN</b>	Niet voor voertuigen met sportophanging
<b>SPT</b>	Uitrustingsvariant: SPORT
<b>SSB</b>	Zwevend remzadel
<b>SSZ</b>	Voor slechte wegen
<b>SSZ</b>	Niet voor slechte wegen
<b>STB</b>	Voor voertuigen met schijfremmen voor en trommelremmen achter
<b>STK</b>	Voor stekeraansluiting
<b>STU</b>	Notch-back
<b>SVN</b>	Spoorbreedte niet vergroot
<b>SVN</b>	Spoorbreedte vergroot
<b>T06</b>	Voor trommelrem 203 x 38 mm en wielremcilinder met zuigerdiameter 20,6 mm
<b>T26</b>	Diameter remtrommel 260 mm
<b>TA</b>	Voor taxi
<b>TA</b>	Niet voor taxi
<b>TBR</b>	Voor voertuigen met trommelremmen
<b>TEF</b>	Voor ATE (Teves) en Ferodo systeem
<b>TEJ</b>	Voor ATE (Alfred Teves) en Jurid systeem
<b>TEX</b>	Por Textar systeem
<b>TIJ</b>	Niet voor voertuigen met TI-uitrusting
<b>TKO</b>	Voor wagen met tractiecontrole
<b>TKO</b>	Voor voertuigen zonder tractiecontrole
<b>TLV</b>	Versie turbo-look
<b>TLV</b>	Niet voor turbo-look versie
<b>TMA</b>	Voor ATE (Teves) systeem, voertuigen met ABS
<b>TMA</b>	Voor ATE (Teves) systeem, voertuigen zonder ABS
<b>TNK</b>	Voor de eenduidige identificatie van de Bosch-nummers moet de gegevenskaart van het voertuig aanwezig zijn. De bij de het product opgesomde componenten moeten met die op de gegevenskaart overeenstemmen.
<b>TR2</b>	Voor trommelrem 200 x 40 mm en wielremcilinder met zuigerdoorsnede 17,5 mm
<b>TRØ</b>	Niet voor de tropen
<b>TRV</b>	Voor voertuigen met trommelrem voor en achter
<b>TRW</b>	Fabrikant = TRW
<b>TSE</b>	Voor voertuigen met SE-uitrusting
<b>TW</b>	Ingebouwd product moet aan het voertuig of de motor gedetecteerd worden.
<b>VAN</b>	Voor VAN
<b>VEA</b>	Versterkte uitvoering
<b>VFC</b>	Voor voertuigen met versterkte vering, voor campers
<b>VFG</b>	Voor verstevigd chassis
<b>VLI</b>	Voor, aanbouw links
<b>VRE</b>	Voor, aanbouw rechts
<b>VSP</b>	Voor Sporting-uitvoering
<b>VSP</b>	Niet voor Sporting-uitvoering
<b>WAB</b>	Bosch-product met identieke inbouw of onderdeel voor Wabco
<b>XLA</b>	Voor voertuigen met XL-uitrusting
<b>Y61</b>	Diameter remschijf 340 mm
<b>Z15</b>	Diameter 15 inch
<b>ZBR</b>	Voor tweekringsreminrichting
<b>ZE</b>	Twee noodzakelijk

**ZTG** Voor tweedelig remzadel

**ZWB** Voor voertuigen met dubbele banden

**ZWZ** Remzadel, 2 zuigers

<sup>3</sup> Voor

<sup>4</sup> Achter

<sup>6</sup> Met zuiger

<sup>7</sup> Zonder zuiger

<sup>8</sup> Onderdelenset met geleidingshulzen

<sup>9</sup> Zonder zuiger, met handremonderdelen

<sup>U</sup> Met geïntegreerde regelaar



Artikelnummer



Diameter



Speciaal geval



Vooras



Informatie / toelichting



Achteras



Datum/ Ingebouwd van .. tot ..



Personenwagen



Personenwagen / bestelbus



Serie



Chassisnummer



Maten



Wielremcilinder



Motorvermogen in kW



Remzadel rechts



Remzadel



Bosch-ervangingsonderdeel



Handremkabel



Toerentalsensor



Tegenoverstelling



Paginaverwijzing



Paginaverwijzing



<b>09Z</b>	För fordon med 9 tums bromsskivediameter
<b>10Z</b>	För fordon med 10 tums bromsskivediameter
<b>14Z</b>	Fälgdiameter 14 tum
<b>15Z</b>	För fälgdiameter 15 tum
<b>165</b>	För fälgdiameter 16,5 tum
<b>16R</b>	Vid 16 - 18 tums hjul
<b>16Z</b>	För fälgdiameter 16 tum
<b>19D</b>	Diameter 190 mm
<b>1KD</b>	Bromsskiva bak 226 x 10 mm för 4-hålsfälg, ej rött bromsok
<b>1KP</b>	Bromsskiva bak 226 x 10 mm för 4-hålsfälg, med rött bromsok
<b>1KX</b>	Bromsskiva 313 x 26 mm
<b>1LA</b>	Bromsskiva 239 x 10 mm
<b>1LM</b>	Bromsskiva 239 x 12 mm
<b>1LQ</b>	Bromsskiva 268 x 10 mm
<b>1LV</b>	Bromsskiva 280 x 22 mm för 4-hålsfälg, ej rött bromsok
<b>1LW</b>	Bromsskiva 280 x 22 mm för 4-hålsfälg, med rött bromsok
<b>1LY</b>	Bromsskiva 256 x 20 mm
<b>20R</b>	Vid 20 tums hjul
<b>212</b>	Bromsskiva 255 x 12 mm
<b>226</b>	Diameter bromsskiva 226 mm
<b>228</b>	Bromsskiva 280 x 22 mm
<b>232</b>	Bromsskiva 232 x 9 mm
<b>238</b>	Bromsskivans diameter 238 mm
<b>239</b>	Bromsskiva 239 x 20 mm
<b>245</b>	Bromsskiva 245 x 10 mm
<b>252</b>	Bromsskiva 256 x 22 mm
<b>254</b>	Diameter 25,4 mm
<b>256</b>	Bromsskiva 256 x 12 mm
<b>257</b>	Bromsskivans diameter 257 mm
<b>268</b>	Bromsskivans diameter 268 mm
<b>278</b>	Diameter bromsskiva 278 mm
<b>281</b>	Bromsskiva 282 x 18 mm
<b>284</b>	Bromsskiva 280 x 24 mm
<b>288</b>	Bromsskiva 288 x 25 mm
<b>292</b>	Bromsskivans diameter 292 mm
<b>294</b>	Diameter bromsskiva 294 mm
<b>295</b>	Diameter bromstrumma 295 mm
<b>2T0</b>	För fordon med 2 torsionsstavar
<b>302</b>	Bromsskivans diameter 302 mm
<b>305</b>	Bromsskivans diameter 305 mm
<b>308</b>	Diameter bromsskiva 308 mm
<b>30R</b>	För fordon med hjulbas 3050 mm
<b>312</b>	Bromsskivans diameter 312 mm
<b>31D</b>	Bromsskivans diameter 315 mm
<b>321</b>	Bromsskiva 321 x 30 mm
<b>322</b>	Bromsskiva 314 x 22 mm
<b>326</b>	Bromsskiva 300 x 26 mm
<b>332</b>	Diameter bromsskiva 332 mm
<b>336</b>	Bromsskivans diameter 336 mm
<b>347</b>	Bromsskiva 347 x 30 mm
<b>3LO</b>	3-hålsfälg
<b>3T5</b>	För fordon med 3,5 t högsta tillåtna totalvikt
<b>452</b>	Diameter bromstrumma 254 mm
<b>4DB</b>	För 4-hålsfälg, bilar utan ABS, Bosch- och Bendix-system
<b>4-K</b>	För 4-kanalssystem
<b>4LO</b>	4-hålsfälg
<b>4SB</b>	För bilar med skivbromsar bak
<b>4T0</b>	För fordon med 4 torsionsstavar
<b>5LO</b>	5-hålsfälg
<b>5SP</b>	För bilar med 5 sittplatser
<b>6LO</b>	6-hålsfälg
<b>7SP</b>	För bilar med 7 sittplatser
<b>822</b>	Diameter bromstrumma 228 mm
<b>AA</b>	Fyrhjulsdrift
<b>AA</b>	Utan fyrhjulsdrift
<b>ABM</b>	Observera, måtten
<b>ABO</b>	För fordon utan ABS
<b>ABS</b>	För fordon med ABS
<b>ADE</b>	För bilar med utrustning: S, Active, Dynamic, Emotion, Class
<b>AEL</b>	För fordon med EL-utrustning
<b>AFS</b>	För bilar med aktiv kurvlutningsreglering
<b>AG</b>	För fordon med automatlåda
<b>AGH</b>	För aluminiumkåpa
<b>AGT</b>	GT-utförande
<b>AIO</b>	För fordon utan ABS och utan ventilerade bromsskivor
<b>ALE</b>	Ej för fordon med fyrhjulstyrning
<b>ALR</b>	För bilar med automatisk ljushöjdsreglering
<b>ALR</b>	För bilar utan automatisk ljushöjdsreglering
<b>AMI</b>	För fordon med ABS och ventilerade bromsskivor
<b>AMM</b>	För fordon med ABS utan ventilerade bromsskivor
<b>AMJ</b>	För utförande Momo
<b>AMJ</b>	Inte för utförandet Momo
<b>AOA</b>	För fordon med automatväxel, utan ABS
<b>AOS</b>	För bilar med ABS, utan ASR
<b>APG</b>	För AMG Performance Package
<b>ASR</b>	För fordon med ASR (antispinnreglering)
<b>ATE</b>	För ATE system (Teves)
<b>ATJ</b>	För utförande Trekking
<b>ATN</b>	Inte för utförande Trekking
<b>ATP</b>	För fordon med AMG teknikpaket
<b>ATP</b>	För fordon utan AMG teknikpaket
<b>B17</b>	För fälgdiameter 17 tum
<b>B18</b>	För fälgdiameter 18 tum
<b>B25</b>	Bromsskiva 259 x 12 mm
<b>B34</b>	För bromsok med kolv diameter 34 mm
<b>B38</b>	För bromsok med 38 mm kolv diameter
<b>B41</b>	För bromsok med 41 mm kolv diameter
<b>B59</b>	Bromsskiva 259 x 20 mm
<b>B80</b>	Boschsystem 8.0
<b>B81</b>	Boschsystem 8.1
<b>BAS</b>	För Bosch-system och bilar med ABS
<b>BAS</b>	För Bosch-system och bilar utan ABS
<b>BDE</b>	För Bendix Spanien (BENDIBERICA)
<b>BDS</b>	Med svängbart säte
<b>BDS</b>	Utan svängbart säte
<b>BEL</b>	5-hålsfastsättning
<b>BES</b>	Fastsättning med skruvar
<b>BHO</b>	För myndighetsfordon
<b>BHO</b>	Ej för myndighetsfordon
<b>BKR</b>	För bilar med bromskraftsregulator
<b>BKR</b>	För fordon utan bromskraftsregulator
<b>BKV</b>	För bilar med bromsservo
<b>BKV</b>	För bilar utan bromsservo
<b>BLA</b>	Utförande svart
<b>BO</b>	Bosch, endast som ersättning för Bosch-utrustning
<b>BRB</b>	För Brembo-system
<b>BSB</b>	Bromsok med skivbromsbelägg
<b>BSB</b>	Bromsok utan skivbromsbelägg
<b>BSC</b>	Bromsokskåpan svartlackerad
<b>BSR</b>	Bromsokhus rödlackerat
<b>BSR</b>	Bromsokhus ej rödlackerat
<b>BSY</b>	För Bosch bromssystem
<b>BUS</b>	För buss
<b>CA</b>	Kabriolet
<b>CSA</b>	Produkt kan beställas online "www.partbob.com"
<b>D53</b>	Diameter bromsskiva 253 mm
<b>D77</b>	Diameter 17,78 mm
<b>D84</b>	Bromsskivans diameter 284 mm
<b>D85</b>	Bromsskivans diameter 285 mm
<b>DMO</b>	För Delco Moraine system
<b>DOP</b>	Dubbelhytt
<b>DRK</b>	Hjulsensor/hjullager-kombination
<b>EAL</b>	För bilar med elektronisk aktivstyrning
<b>EAL</b>	För bilar utan elektronisk aktivstyrning
<b>EBR</b>	Enkrets bromssystem
<b>EDS</b>	För bilar med EDS (elektronisk differentialspär)
<b>EFV</b>	Även ersättning för föregångare
<b>EIZ</b>	Bromsok, 1 kolvar
<b>EMA</b>	Utbytbar Bosch-produkt eller del för Mando
<b>ERH</b>	För bilar med utökad lastkapacitet
<b>ETG</b>	För bromsok i en del
<b>EU4</b>	För bilar med avgasstandard Euro 4
<b>EU5</b>	För bilar med avgasstandard Euro 5
<b>EZK</b>	För bilar med enkelhytt
<b>FAN</b>	Chassi standardutförande
<b>FBD</b>	Monteringslik Bosch-produkt eller del för Bendix
<b>FDO</b>	För Ferodo system
<b>FEB</b>	För elektronisk parkeringsbroms
<b>FEB</b>	Ej för elektronisk parkeringsbroms
<b>FEN</b>	För bilar med normal fjädring
<b>FEV</b>	För bilar med förstärkt fjädring
<b>FGS</b>	För chassi
<b>FGS</b>	Ej för chassit
<b>FHL</b>	För fordon med HL-utrustning
<b>FKR</b>	För bil med kort hjulbas
<b>FLR</b>	För bil med lång hjulbas
<b>FMR</b>	För bilar med medellång hjulbas
<b>FMS</b>	För bilar med specialskydd (pansrade)
<b>FMS</b>	För bilar utan specialskydd (opansrade)
<b>FMU</b>	För fordon med underkörningsskydd
<b>FMU</b>	För fordon utan underkörningsskydd
<b>FPA</b>	För fordon med parkeringsassistent
<b>FPA</b>	För fordon utan parkeringsassistent
<b>FSB</b>	Gaffeloxsbroms
<b>G10</b>	Anslutningsgånga M10 x 1
<b>GBM</b>	För bilar med avståndsreglering
<b>GBM</b>	För bilar utan avståndsreglering
<b>GEM</b>	Metallhölje
<b>GIM</b>	För Lucas-Girling system, bilar med ABS.
<b>GIM</b>	För Lucas-Girling system, bilar utan ABS.
<b>GIR</b>	För Lucas-Girling system
<b>GLA</b>	GL-utförande
<b>GRF</b>	Grundutförande
<b>GS</b>	För fordon med manuell växellåda
<b>GSI</b>	GSI-utförande
<b>GSO</b>	För fordon utan nödbromsassistent
<b>GXA</b>	För fordon med GX-utrustning
<b>H01</b>	Beställ klämhylsan 2 261 024 304 och byt ut
<b>HAK</b>	För fordon med manuell växellåda, utan ABS och utan AC
<b>HLI</b>	Bak, vänstermontering
<b>HLS</b>	För fordon med skivbromsar, bak vänstermontering
<b>HOA</b>	För fordon med manuell växellåda, utan ABS
<b>HRE</b>	Bak, högermontering

<b>HRS</b>	För fordon med skivbromsar, bak, högermontering	<b>MVB</b>	För bilar med slitagevarnare bromsbelägg	<b>STU</b>	Saloon
<b>HSA</b>	För fordon med manell växellåda och ABS	<b>MVB</b>	För fordon utan slitagevarnare för bromsbelägg	<b>SVN</b>	Spårvidd inte breddad
<b>HTB</b>	För fordon med trumbromsar bak	<b>MZH</b>	Med två hållstift	<b>SVN</b>	Spårvidd breddad
<b>IBA</b>	Ventilerade bromsskivor för fordon utan ABS	<b>NAA</b>	Ej för fyrhjulsdrift	<b>T06</b>	För trumbromsar 203 x 38 mm och hjulbromscylinder med koldiameter 20,6 mm
<b>INB</b>	Invändigt ventilerade bromsar	<b>NFS</b>	För specialmodell Baccara/Initiale	<b>T26</b>	Diameter bromstrumma 260 mm
<b>INB</b>	Bromsskiva ej ventilerad	<b>NFS</b>	Ej för specialmodell Baccara/Initiale	<b>TA</b>	För taxi
<b>ITB</b>	För ITT bromssystem	<b>NHV</b>	Utan nivåreglering	<b>TA</b>	Ej för taxi
<b>JUR</b>	För Jurid system	<b>NNC</b>	För bilar med normal fjädring, inte för campingbilar	<b>TBR</b>	För fordon med trumbromsar
<b>KL</b>	För fordon med AC-anläggning	<b>NON</b>	För bilar med normal lastkapacitet	<b>TEF</b>	För ATE (Teves) system och Ferodo system
<b>KL</b>	För bilar utan AC-anläggning	<b>NOR</b>	Normalt utförande	<b>TEJ</b>	För ATE (Alfred Teves) och Jurid system
<b>KOB</b>	För kombibil	<b>OAS</b>	För bilar utan ASR (antispinnreglering)	<b>TEX</b>	För Textar system
<b>KOM</b>	Kombi med katalysator	<b>OED</b>	För bilar utan elektronisk differentialsjärr	<b>THJ</b>	Icke för bilar med TI-utrustning
<b>KW</b>	För skåpbil	<b>OFD</b>	För fordon utan ESP (elektroniskt antisladdsystem)	<b>TKO</b>	För fordon med dragkraftskontroll
<b>KZB</b>	Märkning: blå	<b>OFS</b>	För bilar som saknar aktiv kurvlutningsreglering	<b>TKO</b>	För fordon utan dragkraftskontroll
<b>KZG</b>	Märkning: grön	<b>OZB</b>	För fordon med separatmonterade däck	<b>TLV</b>	Turbo-look version
<b>KZR</b>	Märkning: röd	<b>PAJ</b>	För utförande med Pandemonium-set	<b>TLV</b>	Ej för Turbo-Look-version
<b>KZU</b>	Märkning: grå	<b>PAJ</b>	Inte för utförande med Pandemonium-set	<b>TMA</b>	För ATE (Teves) system, bilar med ABS
<b>L01</b>	Lastkapacitet 800 kg	<b>PEO</b>	För Perrot bromsar/system	<b>TMA</b>	För ATE (Teves) system, bilar utan ABS
<b>L02</b>	Lastkapacitet 1800 kg	<b>PFN</b>	Inte för BMW Performance bromssystem	<b>TNK</b>	För entydig identifiering av Bosch-numret måste bilens datakort föreligga. De vid produkten angivna komponenterna måste stämma överens med de på datakortet.
<b>L03</b>	Lastkapacitet under 1800 kg	<b>PW</b>	För flakvagnar	<b>TR2</b>	För trumbromsar 200 x 40 mm och hjulbromscylinder med koldiameter 17,5 mm
<b>L06</b>	Lastkapacitet 1000 kg	<b>PW</b>	Ej för flakvagnar	<b>TR0</b>	Ej för topikerna
<b>L07</b>	Lastkapacitet 1400 kg	<b>R30</b>	För fordon med hjulbas 3000 mm	<b>TRV</b>	För fordon med trumbromsar fram och bak
<b>L10</b>	Längd 1025 mm	<b>R33</b>	För fordon med hjulbas 3350 mm	<b>TRW</b>	Tillverkare = TRW
<b>L13</b>	Längd 1345 mm	<b>R35</b>	För fordon med hjulbas 3550 mm	<b>TSE</b>	För fordon med SE-utrustning
<b>L65</b>	Längd: 650 mm	<b>R37</b>	För fordon med hjulbas 3700 mm	<b>TW</b>	Monterad produkt måste identifieras på bilen eller motorn.
<b>LAB</b>	Vänstermontering	<b>R40</b>	För fordon med hjulbas 4025 mm	<b>VAN</b>	För VAN
<b>LAU</b>	För fordon med L-utrustning	<b>RAB</b>	Högermontering	<b>VEA</b>	Förstärkt utförande
<b>LFS</b>	Gaffeloxbroms Lucas	<b>RBA</b>	För fordon med Bosch-ABS	<b>VFC</b>	För bilar med förstärkt fjädring, för campingbilar
<b>LGM</b>	För låg modell "grade"	<b>RKR</b>	För högerstyrda fordon med kort hjulbas	<b>VFG</b>	För förstärkt chassi
<b>LGS</b>	För limousine med manuell växellåda	<b>RLE</b>	För högerstyrda fordon	<b>VLI</b>	Främre, vänstermontering
<b>LIA</b>	För limousine med ABS	<b>RSB</b>	Ramoxbroms	<b>VRE</b>	Främre, högermontering
<b>LIM</b>	För limousine	<b>S25</b>	Bromsskiva 256 x 25 mm	<b>VSP</b>	För sportutförande
<b>LKR</b>	För vänsterstyrda bilar med kort hjulbas	<b>S31</b>	Bromsskiva 314 x 25 mm	<b>VSP</b>	Ej för sportutförande
<b>LLE</b>	För vänsterstyrda fordon	<b>SA</b>	Specialutrustning	<b>WAB</b>	Monteringslik Bosch-produkt eller del för Wabco
<b>LLT</b>	För vänsterstyrda fordon med trumbromsar	<b>SAZ</b>	Sats	<b>XLA</b>	För fordon med XL-utrustning
<b>LOC</b>	För Lockheed system	<b>SBE</b>	Stor belastning	<b>Y61</b>	Diameter bromsskiva 340 mm
<b>LUC</b>	Monteringslik Bosch-produkt eller del för Lucas	<b>SBJ</b>	För bilar med sportbromssystem	<b>Z15</b>	Diameter 15 tum
<b>LUX</b>	Lyxutförande	<b>SBJ</b>	Ej för bilar med sportbromssystem	<b>ZBR</b>	Tvårets bromssystem
<b>LWG</b>	För distributionsbil	<b>SBR</b>	För fordon med skivbromsar	<b>ZE</b>	2 erfodras
<b>LWG</b>	Ej för distributionsbil	<b>SCK</b>	För skruvanslutning	<b>ZTG</b>	För bromsok i två delar
<b>LWR</b>	Utan ljushöjdsreglering	<b>SCR</b>	Hatchback	<b>ZWB</b>	För fordon med tvillingmonterade däck
<b>LXA</b>	För fordon med LX-utrustning	<b>SDK</b>	Standardhytt	<b>ZWZ</b>	Bromsok, 2 kolvar
<b>MB</b>	Mekanisk manövrering	<b>SFZ</b>	För specialfordon	<sup>3</sup>	Fram
<b>MBB</b>	För Mercedes-Benz bromsar/system	<b>SLX</b>	För fordon med SLX-utrustning	<sup>4</sup>	Bak
<b>MEH</b>	Med ett hållstift	<b>SP</b>	Sport	<sup>6</sup>	Med kolv
<b>MET</b>	Fordon med ETS och ASR	<b>SP</b>	Special (Combo)	<sup>7</sup>	Utan kolv
<b>MEF</b>	För fordon utan ETS och ASR	<b>SPF</b>	Sportfjädring	<sup>8</sup>	Reservdelssats med styrhylsor
<b>MFD</b>	För fordon med ESP (elektroniskt antisladdsystem)	<b>SPN</b>	Ej för fordon med sportfjädring	<sup>9</sup>	Utan kolv, med handbromsdelar
<b>MI</b>	Mitten	<b>SPT</b>	Utrustningsvariant: SPORT	<sup>U</sup>	Med integrerad regulator
<b>MIH</b>	Med hållare	<b>SSB</b>	Glidoxbroms		
<b>MIH</b>	Utan hållare	<b>SSZ</b>	För dåliga vägförhållanden		
<b>MOJ</b>	För utförande Monster	<b>SSZ</b>	Ej för dåliga vägförhållanden		
<b>MOJ</b>	Inte för utförande Monster	<b>STB</b>	För fordon med skivbromsar fram och trumbromsar bak		
<b>MTG</b>	Med utjämningsvikt	<b>STK</b>	För stickanslutning		
<b>MTG</b>	Utan utjämningsvikt				



Artikelnummer



Speciellt fall



Information/förklaring







Datum/monteringstidpunkt



Höger bromsok



Sidhänvisning



Personbil/lätt lastbil



Bromsok



Diameter



Serie



Bosch-bytesdel



Framaxel



Chassinummer



Handbromsvajer



Bakaxel



Mått



Varvtalssensor



Personbilar



Hjulbromscylinder



Jämförelse



Motoreffekt i kW



Sidhänvisning

<b>09Z</b>	Para veículos com discos do freio de 9 polegadas de diâmetro
<b>10Z</b>	Para veículos com discos do freio de 10 polegadas de diâmetro
<b>14Z</b>	Diâmetro da roda 14 polegadas
<b>15Z</b>	Para diâmetro da roda 15 polegadas
<b>165</b>	Para diâmetro da roda 16,5 polegadas
<b>16R</b>	No caso de rodas de 16 - 18 polegadas
<b>16Z</b>	Para diâmetro da roda 16 polegadas
<b>19D</b>	Diâmetro 190 mm
<b>1KD</b>	Disco do freio traseiro 226 x 10 mm para roda de 4 furos, com pinça do freio não vermelha
<b>1KP</b>	Disco do freio traseiro 226 x 10 mm para roda de 4 furos, com pinça do freio vermelha
<b>1KX</b>	Disco do freio 313 x 26 mm
<b>1LA</b>	Disco do freio 239 x 10 mm
<b>1LM</b>	Disco do freio 239 x 12 mm
<b>1LQ</b>	Disco do freio 268 x 10 mm
<b>1LV</b>	Disco do freio 280 x 22 mm para roda de 4 furos, com pinça do freio não vermelha
<b>1LW</b>	Disco do freio 280 x 22 mm para roda de 4 furos, com pinça do freio vermelha
<b>1LY</b>	Disco de freio 256 x 20 mm
<b>20R</b>	No caso de rodas de 20 polegadas
<b>21Z</b>	Disco de freio 255 x 12 mm
<b>226</b>	Diâmetro disco freio 226 mm
<b>228</b>	Disco do freio 280 x 22 mm
<b>23Z</b>	Disco do freio 232 x 9 mm
<b>238</b>	Diâmetro disco do freio 238 mm
<b>239</b>	Disco do freio 239 x 20 mm
<b>245</b>	Disco do freio 245 x 10 mm
<b>25Z</b>	Disco do freio 256 x 22 mm
<b>254</b>	Diâmetro 25,4 mm
<b>256</b>	Disco do freio 256x12 mm
<b>257</b>	Diâmetro disco do freio 257 mm
<b>268</b>	Diâmetro do disco de freio 268 mm
<b>278</b>	Diâmetro disco do freio 278 mm
<b>281</b>	Disco do freio 282 x 18 mm
<b>284</b>	Disco do freio 280 x 24 mm
<b>288</b>	Disco do freio 288 x 25 mm
<b>29Z</b>	Diâmetro disco do freio 292 mm
<b>294</b>	Diâmetro disco do freio 294 mm
<b>295</b>	Diâmetro do tambor de freio 295 mm
<b>2TO</b>	Para veículos com duas barras de torção
<b>30Z</b>	Diâmetro do disco de freio 302 mm
<b>305</b>	Diâmetro do disco de freio 305 mm
<b>308</b>	Diâmetro do disco de freio 308 mm
<b>30R</b>	Para veículos com distância entre eixos de 3050 mm
<b>31Z</b>	Diâmetro do disco de freio 312 mm
<b>31D</b>	Diâmetro do disco de freio 315 mm
<b>321</b>	Disco do freio 321 x 30 mm
<b>32Z</b>	Disco do freio 314 x 22 mm
<b>326</b>	Disco do freio 300 x 26 mm
<b>33Z</b>	Diâmetro disco do freio 332 mm
<b>336</b>	Diâmetro disco do freio 336 mm
<b>34Z</b>	Disco de freio 347 x 30 mm
<b>3LO</b>	Roda de três furos
<b>3T5</b>	Para veículos com 3,5 t de peso máximo admissível
<b>45Z</b>	Diâmetro do tambor de freio 254 mm
<b>4DB</b>	Para roda de 4 furos, veículos sem ABS, sistemas Bosch e Bendix
<b>4-K</b>	Para sistema de 4 canais
<b>4LO</b>	Roda de 4 furos
<b>4SB</b>	Para veículos com freios a disco, atrás
<b>4TO</b>	Para veículos com 4 barras de torção
<b>5LO</b>	Roda de 5 furos
<b>5SP</b>	Para veículos de 5 lugares
<b>6LO</b>	Roda de 6 furos
<b>7SP</b>	Para veículos com 7 lugares
<b>82Z</b>	Diâmetro do tambor de freio 228 mm
<b>AA</b>	Tração integral
<b>AA</b>	Sem tração integral
<b>ABM</b>	Observar medidas
<b>ABO</b>	Para veículos sem ABS
<b>ABS</b>	Para veículos com ABS
<b>ADE</b>	Para veículos com nível de equipamento: S, Active, Dynamic, Emotion, Class
<b>AEL</b>	Para veículos com nível de equipamento EL
<b>AFS</b>	Para veículos com regulagem ativa da inclinação lateral
<b>AG</b>	Para veículos com caixa de câmbio automática
<b>AGH</b>	Para caixa em alumínio
<b>AGT</b>	Nível de equipamento GT
<b>AIO</b>	Para veículos sem ABS e sem discos do freio ventilados
<b>ALE</b>	Não se destina a veículos com direção integral
<b>ALR</b>	Para veículos com regulagem automática do alcance dos faróis
<b>ALR</b>	Para veículos sem regulagem automática do alcance dos faróis
<b>AMI</b>	Para veículos com ABS e discos do freio ventilados
<b>AMH</b>	Para veículos com ABS sem discos do freio ventilados
<b>AMJ</b>	Para versão Momo
<b>AMJ</b>	Não para versão Momo
<b>AOA</b>	Para veículos com caixa de câmbio automática, sem ABS
<b>AOS</b>	Para veículos com ABS, sem ASR
<b>APG</b>	Para AMG Performance Package
<b>ASR</b>	Para veículos com ASR (sistema de controle de tração)
<b>ATE</b>	Para o sistema ATE (Teves)
<b>ATJ</b>	Para versão Trekking
<b>ATN</b>	Não para versão Trekking
<b>ATP</b>	Para veículos com pacote tecnológico AMG
<b>ATP</b>	Para veículos sem pacote tecnológico AMG
<b>B17</b>	Para diâmetro da roda 17 polegadas
<b>B18</b>	Para diâmetro da roda 18 polegadas
<b>B25</b>	Disco de freio 259 x 12 mm
<b>B34</b>	Para pinça de freio com diâmetro do pistão de 34 mm
<b>B38</b>	Para pinça do freio com diâmetro do êmbolo de 38 mm
<b>B41</b>	Para pinça do freio com diâmetro do êmbolo de 41 mm
<b>B59</b>	Disco de freio 259 x 20 mm
<b>B80</b>	Sistema Bosch 8.0
<b>B81</b>	Sistema Bosch 8.1
<b>BAS</b>	Para sistema Bosch e veículos com ABS
<b>BAS</b>	Para sistema Bosch e veículos sem ABS
<b>BDE</b>	Para Bendix Espanha (BENDIBERICA)
<b>BDS</b>	Com banco rotativo
<b>BDS</b>	Sem banco rotativo
<b>BEL</b>	Fixação, 5 furos
<b>BES</b>	Fixação com parafusos
<b>BHO</b>	Para veículos de entidades públicas
<b>BHO</b>	Não para veículo de entidades públicas
<b>BKR</b>	Para veículos com regulador da pressão do freio
<b>BKR</b>	Para veículos sem regulador da pressão do freio
<b>BKV</b>	Para veículos com servofreio
<b>BKV</b>	Para veículos sem servofreio
<b>BLA</b>	Versão preta
<b>BO</b>	Bosch, somente como peça de reposição para equipamento Bosch
<b>BRB</b>	Para sistema Brembo
<b>BSB</b>	Pinça do freio com pastilhas de freio a disco
<b>BSB</b>	Pinça do freio sem pastilhas
<b>BSC</b>	Carcaça da pinça do freio pintada a preto
<b>BSR</b>	Carcaça da pinça do freio pintada de vermelho
<b>BSR</b>	Carcaça da pinça do freio não está pintada de vermelho
<b>BSY</b>	Para sistema de freio Bosch
<b>BU</b>	Para bus
<b>CA</b>	Conversível
<b>CSA</b>	O produto também pode ser pedido online em "www.partbob.com"
<b>D53</b>	Diâmetro do disco de freio 253 mm
<b>D77</b>	Diâmetro 17,78 mm
<b>D84</b>	Diâmetro disco do freio 284 mm
<b>D85</b>	Diâmetro disco do freio 285 mm
<b>DMO</b>	Para sistema Delco Moraine
<b>DOP</b>	Cabine dupla
<b>DRK</b>	Combinação de sensor de rotações/mancal da roda
<b>EAL</b>	Para veículos com direção eletrônica ativa
<b>EAL</b>	Para veículos sem direção eletrônica ativa
<b>EBR</b>	Sistema de frenagem de circuito simples
<b>EDS</b>	Para veículos com EDS (bloqueio eletrônico do diferencial)
<b>EFV</b>	Também como peça de reposição da peça anterior
<b>EIZ</b>	Pinça de freio, 1 êmbolo
<b>EMA</b>	Produto Bosch de montagem idêntica ou peça para Mando
<b>ERH</b>	Para veículos com carga útil aumentada
<b>ETG</b>	Para pinça do freio de uma só peça
<b>EU4</b>	Para veículos com norma relativa aos gases de escape Euro 4
<b>EU5</b>	Para veículos com norma relativa aos gases de escape Euro 5
<b>EZK</b>	Para veículos com cabine individual
<b>FAN</b>	Chassi versão standard
<b>FBD</b>	Produto ou peça Bosch equivalente para Bendix
<b>FDO</b>	Para sistema Ferodo
<b>FEB</b>	Para freio de mão eletrônico
<b>FEB</b>	Não para freio de mão eletrônico
<b>FEN</b>	Para veículos com suspensão normal
<b>FEV</b>	Para veículos com suspensão reforçada
<b>FGS</b>	Para chassis
<b>FGS</b>	Não para chassis
<b>FHL</b>	Para veículos com nível de equipamento HL
<b>FKR</b>	Para veículos com distância entre eixos curta
<b>FLR</b>	Para veículos com distância entre eixos longa
<b>FMR</b>	Para veículos com distância entre eixos média
<b>FMS</b>	Para veículos com proteção especial (blindados)
<b>FMS</b>	Para veículos sem proteção especial (não blindados)
<b>FMU</b>	Para veículos com resguardo inferior
<b>FMU</b>	Para veículos sem resguardo inferior
<b>FPA</b>	Para veículos com assistente de estacionamento
<b>FPA</b>	Para veículos sem assistente de estacionamento
<b>FSB</b>	Freio de pinça flutuante



<b>G10</b>	Rosca de ligação M10 x 1	<b>LWG</b>	Não para furgonetas	<b>SBE</b>	Solicitação pesada
<b>GBM</b>	Para veículos com regulagem da distância	<b>LWR</b>	Sem regulagem do alcance dos faróis	<b>SBJ</b>	Para veículos com sistema de freios esportivos
<b>GBM</b>	Para veículos sem regulagem da distância	<b>LXA</b>	Para veículos com nível de equipamento LX	<b>SBJ</b>	Não se destina a veículos com sistema de freios esportivos
<b>GEM</b>	Carcaça de metal	<b>MB</b>	Acionamento mecânico	<b>SBR</b>	Para veículos com freios a disco
<b>GIM</b>	Para sistema Lucas-Girling, veículos com ABS	<b>MBB</b>	Para freio/sistema Mercedes Benz	<b>SCK</b>	Para conexão roscada
<b>GIM</b>	Para sistema Lucas-Girling, veículos sem ABS	<b>MEH</b>	Com um pino de retenção	<b>SCR</b>	Hatch
<b>GIR</b>	Para sistema Lucas-Girling	<b>MET</b>	Para veículos com ETS e ASR	<b>SDK</b>	Cabine standard
<b>GLA</b>	Nível de equipamento GL	<b>MEF</b>	Para veículos sem ETS e ASR	<b>SFZ</b>	Para veículos especiais
<b>GRF</b>	Versão básica	<b>MFD</b>	Para veículos com ESP (programa eletrônico de estabilidade)	<b>SLX</b>	Para veículos com nível de equipamento SLX
<b>GS</b>	Para veículos com caixa de câmbio manual	<b>MI</b>	Centro	<b>SP</b>	Esporte
<b>GSI</b>	Nível de equipamento GSi	<b>MIH</b>	Com suporte	<b>SPE</b>	Especial (Combo)
<b>GSO</b>	Para veículos sem assistente de frenagem de emergência	<b>MIH</b>	Sem suporte	<b>SPF</b>	Suspensão esportiva
<b>GXA</b>	Para veículos com nível de equipamento GX	<b>MOJ</b>	Para versão Monster	<b>SPN</b>	Não para veículos com suspensão esportiva
<b>H01</b>	Pedir e trocar a luva de aperto 2 261 024 304	<b>MOJ</b>	Não para versão Monster	<b>SPT</b>	Variante de equipamento: SPORT
<b>HAK</b>	Para veículos com caixa de câmbio manual, sem ABS e sem ar condicionado	<b>MTG</b>	Com amortecedor de massa	<b>SSB</b>	Freio a disco de pinça flutuante
<b>HLI</b>	Atrás, montagem à esquerda	<b>MTG</b>	Sem amortecedor de massa	<b>SSZ</b>	Para piso em mau estado
<b>HLS</b>	Para veículos com freio a disco, atrás, montagem à esquerda	<b>MVB</b>	Para veículos com indicador do desgaste das pastilhas dos freios	<b>SSZ</b>	Não para estradas com pavimento em mau estado
<b>HOA</b>	Para veículos com caixa de câmbio manual, sem ABS	<b>MVB</b>	Para veículos sem indicador do desgaste das pastilhas dos freios	<b>STB</b>	Para veículos com freios a disco à frente e freios a tambor atrás
<b>HRE</b>	Atrás, montagem à direita	<b>MZH</b>	Com dois pinos de retenção	<b>STK</b>	Para conector de encaixe
<b>HRS</b>	Para veículos com freio a disco, atrás, montagem à direita	<b>NAA</b>	Não para tração integral	<b>STU</b>	Sedã
<b>HSA</b>	Para veículos com caixa de câmbio manual e ABS	<b>NFS</b>	Para o modelo especial Baccara/Initiale	<b>SVN</b>	Pista não alargada
<b>HTB</b>	Para veículos com freios a tambor atrás	<b>NFS</b>	Não para o modelo especial Baccara/Initiale	<b>SVN</b>	Pista alargada
<b>HBA</b>	Discos do freio ventilados para veículos sem ABS	<b>NW</b>	Sem regulagem de nível	<b>T06</b>	Para freio a tambor 203 x 38 mm e cilindro do freio com um êmbolo de 20,6 mm de diâmetro
<b>INB</b>	Disco do freio ventilado	<b>NNC</b>	Para veículos com suspensão normal, não para veículo de campismo	<b>T26</b>	Diâmetro do tambor do freio 260 mm
<b>INB</b>	Disco do freio sem ventilação interna	<b>NON</b>	Para veículos com carga útil normal	<b>TA</b>	Para táxi
<b>ITB</b>	Para sistema de freio ITT	<b>NOR</b>	Versão normal	<b>TA</b>	Não para táxi
<b>JUR</b>	Para sistema Jurid	<b>OAS</b>	Para veículos sem ASR (sistema de controle de tração)	<b>TBR</b>	Para veículos com freios a tambor
<b>KL</b>	Para veículos com ar condicionado	<b>OED</b>	Para veículos sem bloqueio eletrônico do diferencial	<b>TEF</b>	Para sistemas ATE (Teves) e Ferodo
<b>KL</b>	Para veículos sem ar condicionado	<b>OFD</b>	Para veículos sem ESP (programa eletrônico de estabilidade)	<b>TEJ</b>	Para ATE (Alfred Teves) e sistema Jurid
<b>KOB</b>	Para perua	<b>OFS</b>	Para veículos sem regulagem ativa da inclinação lateral	<b>TEX</b>	Para sistema Textar
<b>KOM</b>	Peruas com catalisador	<b>OZB</b>	Para veículos com rodado simples	<b>THJ</b>	Não para veículos com equipamento TI
<b>KW</b>	Para furgão	<b>PAJ</b>	Para versão com kit Pandemonium	<b>TKO</b>	Para veículos com controle de tração
<b>KZB</b>	Identificação: azul	<b>PAJ</b>	Não indicado para versão com kit Pandemonium	<b>TKO</b>	Para veículos sem controle de tração
<b>KZG</b>	Identificação: verde	<b>PEO</b>	Para sistema/freio Perrot	<b>TLV</b>	Versão Turbo-Look
<b>KZR</b>	Identificação: vermelho	<b>PFN</b>	Não para sistema de frenagem BMW Performance	<b>TLV</b>	Não para a versão Turbo-Look
<b>KZU</b>	Identificação : cinza	<b>PW</b>	Para veículo com plataforma	<b>TMA</b>	Para sistema ATE (Teves), veículos com ABS
<b>L01</b>	Carga útil 800 kg	<b>PW</b>	Não para veículo com plataforma	<b>TMA</b>	Para sistema ATE (Teves), veículos sem ABS
<b>L02</b>	Carga útil 1800 kg	<b>R30</b>	Para veículos com distância entre eixos de 3000 mm	<b>TNK</b>	A ficha de dados do veículo deve estar à disposição para a identificação inequívoca do número Bosch. Os componentes especificados para o produto devem coincidir com aqueles da ficha de dados.
<b>L03</b>	Carga útil abaixo de 1800 kg	<b>R33</b>	Para veículos com distância entre eixos de 3350 mm	<b>TR2</b>	Para freio a tambor de 200 x 40 mm e cilindro do freio da roda com diâmetro do êmbolo de 17,5 mm
<b>L06</b>	Carga útil 1000 kg	<b>R35</b>	Para veículos com distância entre eixos de 3550 mm	<b>TR0</b>	Não para climas tropicais
<b>L07</b>	Carga útil 1400 kg	<b>R37</b>	Para veículos com distância entre eixos de 3700 mm	<b>TRV</b>	Para veículos com freio de tambor, à frente e atrás
<b>L10</b>	Comprimento: 1025 mm	<b>R40</b>	Para veículos com distância entre eixos de 4025 mm	<b>TRW</b>	Fabricante = TRW
<b>L13</b>	Comprimento: 1345 mm	<b>RAB</b>	Montagem à direita	<b>TSE</b>	Para veículos com nível de equipamento SE
<b>L65</b>	Comprimento: 650 mm	<b>RBA</b>	Para veículos com ABS da Bosch	<b>TW</b>	Produto montado tem que ser averiguado no veículo ou no motor.
<b>LAB</b>	Montagem à esquerda	<b>RKR</b>	Para volante à direita com distância entre eixos longa	<b>VAN</b>	Para VAN
<b>LAU</b>	Para veículos com nível de equipamento L	<b>RLE</b>	Para volante à direita	<b>VEA</b>	Versão reforçada
<b>LFS</b>	Freio de pinça flutuante Lucas	<b>RSB</b>	Freio de pinça	<b>VFC</b>	Para veículos com suspensão reforçada, para veículo de campismo
<b>LGM</b>	Para modelo inferior "grade"	<b>S25</b>	Disco do freio 256 X 25mm	<b>VFG</b>	Para chassis reforçado
<b>LGS</b>	Para limusine com caixa de câmbio manual	<b>S31</b>	Disco de freio 314 x 25 mm	<b>VLI</b>	Dianteiro, montagem à esquerda
<b>LIA</b>	Para limusine com ABS	<b>SA</b>	Equipamento especial	<b>VRE</b>	Dianteiro, montagem à direita
<b>LIM</b>	Para limusine	<b>SAZ</b>	Kit	<b>VSP</b>	Para nível de equipamento Sporting
<b>LKR</b>	Para veículos com volante à esquerda com distância entre eixos curta			<b>VSP</b>	Não para nível de equipamento Sporting
<b>LLE</b>	Para volante à esquerda			<b>WAB</b>	Produto ou peça Bosch equivalente para Wabco
<b>LLT</b>	Para veículos com volante à esquerda com freio a tambor				
<b>LOC</b>	Para sistema Lockheed				
<b>LUC</b>	Produto ou peça Bosch equivalente para Lucas				
<b>LUX</b>	Modelo de luxo				
<b>LWG</b>	Para furgonetas				

<b>XLA</b>	Para veículos com nível de equipamento XL
<b>Y61</b>	Diâmetro do disco de freio 340 mm
<b>Z15</b>	Diâmetro 15 polegadas
<b>ZBR</b>	Para sistema de freios de circuito duplo
<b>ZE</b>	Necessários dois

<b>ZTG</b>	Para pinça do freio de duas peças
<b>ZWB</b>	Para veículos com rodado duplo
<b>ZWZ</b>	Pinça de freio, 2 êmbolos
<sup>3</sup>	À frente
<sup>4</sup>	Atrás

<sup>6</sup>	Com êmbolo
<sup>7</sup>	Sem êmbolo
<sup>8</sup>	Jogo de peças com casquilhos de guia
<sup>9</sup>	Sem êmbolo, com partes do freio de mão
U	Com regulador integrado



Número de pedido



Referência para páginas



Caso especial



Diâmetro



Informação / explicação



Eixo dianteiro



Data/Período de instalação



Eixo traseiro



Veículo ligeiro / Furgão



Veículo ligeiro



Série



Nº de chassis



Medidas



Cilindro de travão da roda



Potência do motor em kW



Pinça de freio direita



Pinça do travão



Peça de substituição Bosch



Cabo do travão de mão



Sensor de velocidade



Confrontação



Referência do lado



<b>09Z</b>	Pro vozidla s průměrem brzdových kotoučů 9 palců	<b>5LO</b>	Ráfek s 5 otvory	<b>BSB</b>	Třmen brzdy s brzdovým obložím
<b>10Z</b>	Pro vozidla s průměrem brzdových kotoučů 10 palců	<b>5SP</b>	Pro vozidla s 5 místy k sezení	<b>BSB</b>	Třmen kotoučové brzdy bez obložení
<b>14Z</b>	Průměr ráfku 14 palců	<b>6LO</b>	6děrový ráfek	<b>BSC</b>	Skříň třmenu brzdy s černým nátěrem
<b>15Z</b>	Pro průměr ráfku 15"	<b>7SP</b>	Pro vozidla se 7 místy k sezení	<b>BSR</b>	Skříň třmenu brzdy má červený nátěr
<b>165</b>	Pro průměr ráfku 16,5"	<b>82Z</b>	Průměr brzdového bubnu 228 mm	<b>BSR</b>	Skříň třmenu brzdy nemá červený nátěr
<b>16R</b>	U 16 - 18" kol	<b>AA</b>	Pohon všech kol	<b>BSY</b>	Pro brzdový systém Bosch
<b>16Z</b>	Pro průměr ráfku 16"	<b>AA</b>	Bez pohonu na všechna kola	<b>BUS</b>	Pro autobus
<b>19D</b>	Průměr 190 mm	<b>ABM</b>	Dbejte na rozměry	<b>CA</b>	Kabriolet
<b>1KD</b>	Brzdový kotouč zadní 226 x 10 mm pro ráfek se 4 otvory, s jiným než červeným třmenem brzdy	<b>ABO</b>	Pro vozidla bez ABS	<b>CSA</b>	Výrobek lze objednat také online na adrese "www.partbob.com"
<b>1KP</b>	Brzdový kotouč zadní 226 x 10 mm pro ráfek se 4 otvory, s červeným třmenem brzdy	<b>ABS</b>	Pro vozidla s ABS	<b>D53</b>	Průměr brzdového kotouče 253 mm
<b>1KX</b>	Brzdový kotouč 313 x 26 mm	<b>ADE</b>	Pro vozidla s výbavou: S, Active, Dynamic, Emotion, Class	<b>D77</b>	Průměr 17,78 mm
<b>1LA</b>	Brzdový kotouč 239 x 10 mm	<b>AEL</b>	Pro vozidla s výbavou EL	<b>D84</b>	Průměr brzdového kotouče 284 mm
<b>1LM</b>	Brzdový kotouč 239 x 12 mm	<b>AFS</b>	Pro vozidla s akt. regulací boč. náklonu	<b>D85</b>	Průměr brzdového kotouče 285 mm
<b>1LQ</b>	Brzdový kotouč 268 x 10 mm	<b>AG</b>	Pro vozidla s automatickou převodovkou	<b>DMO</b>	Výrobek nebo díl Bosch zaměnitelný za výrobek nebo díl Delco Moraine
<b>1LV</b>	Brzdový kotouč 280 x 22 mm pro disk se 4 otvory, s jiným než červeným brzdovým třmenem	<b>AGH</b>	Pro hliníkovou skříň	<b>DOP</b>	Dvojitá kabina
<b>1LW</b>	Brzdový kotouč 280 x 22 mm pro disk se 4 otvory, s červeným brzdovým třmenem	<b>AGT</b>	Provedení GT	<b>DRK</b>	Kombinace snímače otáček a ložiska kola
<b>1LY</b>	Brzd. kotouč 256 x 20 mm	<b>AIO</b>	Pro vozidla bez ABS a bez brzdových kotoučů s vnitřním chlazením	<b>EAL</b>	Pro vozidla s elektronickým aktivním řízením
<b>20R</b>	U 20" kol	<b>AL</b>	Ne pro vozidla s řízením všech kol	<b>EAL</b>	Pro vozidla bez elektronického aktivního řízení
<b>212</b>	Brzd. kotouč 255 x 12 mm	<b>ALR</b>	Pro vozidla s automatickým nastavením sklonu světel	<b>EBR</b>	Jednookruhová brzdová soustava
<b>226</b>	Průměr brzdového kotouče 226 mm	<b>ALR</b>	Pro vozidla bez automatické regulace sklonu světel	<b>EDS</b>	Pro vozidla s EDS (elektronická uzávěrka diferenciálu)
<b>228</b>	Brzdový kotouč 280 x 22 mm	<b>AMI</b>	Pro vozidla s ABS a brzdovým kotoučem s vnitřním chlazením	<b>EFV</b>	Také jako náhrada za předchozí typ
<b>232</b>	Brzdový kotouč 232 x 9 mm	<b>AMI</b>	Pro vozidla s ABS a brzdovým kotoučem s vnitřním chlazením	<b>EIZ</b>	Brzdový třmen, 1 píst
<b>238</b>	Průměr brzdového kotouče 238 mm	<b>AMJ</b>	Pro provedení Momo	<b>EMA</b>	Montážně shodný výrobek Bosch nebo díl pro Mando
<b>239</b>	Brzdový kotouč 239 x 20 mm	<b>AMJ</b>	Ne pro provedení Momo	<b>ERH</b>	Pro vozidla se zvýšeným využitelným zatížením
<b>245</b>	Brzdový kotouč 245 x 10 mm	<b>AOA</b>	Pro vozidla s automatickou převodovkou, bez ABS	<b>ETG</b>	Pro jednodílný třmen brzdy
<b>252</b>	Brzdový kotouč 256 x 22 mm	<b>AOS</b>	Pro vozidla s ABS, bez ASR	<b>EU4</b>	Pro vozidla s emisní normou Euro 4
<b>254</b>	Průměr 25,4 mm	<b>APG</b>	Pro vozidla s AMG Performance Package	<b>EU5</b>	Pro vozidla s emisní normou Euro 5
<b>256</b>	Brzdový kotouč 256 x 12 mm	<b>ASR</b>	Pro vozidla s ASR (protipokluzová regulace)	<b>EZK</b>	Pro vozidla s jednotlivou kabinou
<b>257</b>	Průměr brzdového kotouče 257 mm	<b>ATE</b>	Pro systém ATE (Teves)	<b>FAN</b>	Podvozek, standardní provedení
<b>268</b>	Průměr brzdového kotouče 268 mm	<b>ATJ</b>	Pro provedení Trekking	<b>FBD</b>	Montážně rovnocenný výrobek Bosch nebo díl pro Bendix
<b>278</b>	Průměr brzdového kotouče 278 mm	<b>ATN</b>	Ne pro provedení Trekking	<b>FDO</b>	Výrobek nebo díl Bosch zaměnitelný za výrobek nebo díl Ferodo
<b>281</b>	Brzdový kotouč 282 x 18 mm	<b>ATP</b>	Pro vozidla se soupravou AMG Technik-Paket	<b>FEB</b>	Pro elektronickou parkovací brzdu
<b>284</b>	Brzdový kotouč 280 x 24 mm	<b>ATP</b>	Pro vozidla bez soupravy AMG Technik-Paket	<b>FEB</b>	Ne pro systém elektronické parkovací brzdy
<b>288</b>	Brzdový kotouč 288 x 25 mm	<b>B17</b>	Pro průměr ráfku 17"	<b>FEN</b>	Pro vozidla s normálním pérováním
<b>292</b>	Průměr brzdového kotouče 292 mm	<b>B18</b>	Pro průměr ráfku 18"	<b>FEV</b>	Pro vozidla se zesíleným pérováním
<b>294</b>	Průměr brzdového kotouče 294 mm	<b>B25</b>	Brz. kotouč 259 x 12 mm	<b>FGS</b>	Pro podvozek
<b>295</b>	Průměr brzdového bubnu 295 mm	<b>B34</b>	Pro brz. třmen s průměrem pístu 34 mm	<b>FGS</b>	Ne pro podvozek
<b>2T0</b>	Pro vozidla s 2 zkrutnými tyčemi	<b>B38</b>	Pro třmen brzdy s průměrem pístu 38 mm	<b>FHL</b>	Pro vozidla s výbavou HL
<b>302</b>	Průměr brzd. kotouče 302 mm	<b>B41</b>	Pro brzdový třmen s průměrem pístu 41 mm	<b>FKR</b>	Pro vozidla s malým rozchodem kol
<b>305</b>	Průměr brzd. kotouče 305 mm	<b>B59</b>	Brzd. kotouč 259 x 20 mm	<b>FLR</b>	Pro vozidla s velkým rozchodem kol
<b>308</b>	Průměr brzdového kotouče 308 mm	<b>B80</b>	Bosch systém 8.0	<b>FMR</b>	Pro vozidla se středním rozchodem kol
<b>30R</b>	Pro vozidla s rozchodem kol 3050 mm	<b>B81</b>	Bosch systém 8.1	<b>FMS</b>	Pro vozidla se speciální ochranou (pancéřovaná)
<b>312</b>	Průměr brzd. kotouče 312 mm	<b>BAS</b>	Pro systém Bosch a vozidla s ABS	<b>FMS</b>	Pro vozidla bez speciální ochrany (nepancéřovaná)
<b>31D</b>	Průměr brzdového kotouče 315 mm	<b>BAS</b>	Pro systém Bosch a vozidla bez ABS	<b>FMU</b>	Pro vozidla s ochranou proti podjetí
<b>321</b>	Brzdový kotouč 321 x 30 mm	<b>BDE</b>	Pro Bendix Španělsko (BENDIBERICA)	<b>FMU</b>	Pro vozidla bez ochrany proti podjetí
<b>322</b>	Brzdový kotouč 314 x 22 mm	<b>BDS</b>	S otoč. sed.	<b>FPA</b>	Pro vozidla s usnadněním parkování
<b>326</b>	Brzdový kotouč 300 x 26 mm	<b>BDS</b>	Bez otoč. sed.	<b>FPA</b>	Pro vozidla bez usnadnění parkování
<b>332</b>	Průměr brzdového kotouče 332 mm	<b>BEL</b>	Upevnění, 5 otvorů	<b>FSB</b>	Brzda s kompaktním třmenem
<b>336</b>	Průměr brzdového kotouče 336 mm	<b>BES</b>	Upevnění pomocí šroubů	<b>G10</b>	Spojovací závit M10 x 1
<b>347</b>	Brzd. kotouč 347 x 30 mm	<b>BHO</b>	Pro vozidla úřadů	<b>GBM</b>	Pro vozidla s regulací odstupu
<b>3LO</b>	Ráfek se 3 otvory	<b>BHO</b>	Nikoli pro úřední vozidla	<b>GBM</b>	Pro vozidla bez regulace odstupu
<b>3T5</b>	Pro vozidla s povolenou celkovou hmotností 3,5 t	<b>BKR</b>	Pro vozidla s regulátorem brzdění síly	<b>GEM</b>	Kovový kryt
<b>452</b>	Průměr brzdového bubnu 254 mm	<b>BKR</b>	Pro vozidla bez regulátoru brzdění síly	<b>GIM</b>	Výrobek nebo díl Bosch zaměnitelný za výrobek nebo díl Lucas-Girling, vozidla s ABS.
<b>4DB</b>	Pro 4děrový ráfek, vozidla bez ABS, systém Bosch a Bendix	<b>BKV</b>	Pro vozidla s posilovačem brzd	<b>GIM</b>	Výrobek nebo díl Bosch zaměnitelný za výrobek nebo díl Lucas-Girling, vozidla bez ABS.
<b>4-K</b>	Pro systém se 4 kanály	<b>BKV</b>	Pro vozidla bez posilovače brzd	<b>GIR</b>	Výrobek nebo díl Bosch zaměnitelný za výrobek nebo díl Lucas-Girling
<b>4LO</b>	Ráfek se 4 otvory	<b>BLA</b>	Provedení černé		
<b>45B</b>	Pro vozidla s kotoučovými brzdami vzadu	<b>BO</b>	Bosch, pouze jako náhrada za výbavu Bosch		
<b>4T0</b>	Pro vozidla se 4 zkrutnými tyčemi	<b>BRB</b>	Pro systém Brembo		

<b>GLA</b>	Provedení GL	<b>MEH</b>	S přídržným kolíkem	<b>SSB</b>	Brzda s plovoucím třmenem
<b>GRF</b>	Základní provedení	<b>MET</b>	Pro vozidla s ETS a ASR	<b>SSZ</b>	Pro špatný stav silnic
<b>GS</b>	Pro vozidla s manuální převodovkou	<b>MET</b>	Pro vozidla bez ETS a ASR	<b>SSZ</b>	Ne pro špatný stav silnic
<b>GSi</b>	Provedení GSi	<b>MFD</b>	Pro vozidla se systémem regulace dynamiky jízdy (FDR)	<b>STB</b>	Pro vozidla s kotoučovými brzdami vpředu a bubnovými brzdami vzadu
<b>GSO</b>	Pro vozidla bez asistenta nouzové brzdy	<b>MI</b>	Střed	<b>STK</b>	Pro konektorovou přípojku
<b>GXA</b>	Pro vozidla s výbavou GX	<b>MIH</b>	S držákem	<b>STU</b>	Vozidlo se stupňovitou zádí
<b>H01</b>	Objednat a vyměnit svěrací objímku 2 261 024 304	<b>MH</b>	Bez držáku	<b>SVN</b>	Nerozšířená sbíhavost
<b>HAK</b>	Pro vozidla s manuální převodovkou, bez ABS a klimatizace	<b>MOJ</b>	Pro provedení Monster	<b>SVN</b>	Rozšířená sbíhavost
<b>HLI</b>	Zadní, montáž vlevo	<b>MOJ</b>	Ne pro provedení Monster	<b>T06</b>	Pro bubnové brzdy 203 x 38 mm a brzdové válce kol o průměru pístu 20,6 mm
<b>HLS</b>	Pro vozidla s kotoučovými brzdami, vzadu, montáž vlevo	<b>MTG</b>	S tlumícím závažím	<b>T26</b>	Průměr brzdového bubnu 260 mm
<b>HOA</b>	Pro vozidla s manuální převodovkou, bez ABS	<b>MTG</b>	Bez tlumícího závaží	<b>TA</b>	Pro taxislужbu
<b>HRE</b>	Zadní, montáž vpravo	<b>MVB</b>	Pro vozidla s ukazatelem opotřeby brzdového obložení	<b>TA</b>	Ne pro taxi
<b>HRS</b>	Pro vozidla s kotoučovými brzdami, vzadu, montáž vpravo	<b>MVB</b>	Pro vozidla bez ukazatele opotřeby brzdového obložení	<b>TBR</b>	Pro vozidla s bubnovými brzdami
<b>HSA</b>	Pro vozidla s manuální převodovkou a ABS	<b>MZH</b>	Se dvěma přídržnými kolíky	<b>TEF</b>	Pro systém ATE (Alfred Teves) a Ferodo
<b>HTB</b>	Pro vozidla s bubnovými brzdami vzadu	<b>NAA</b>	Ne pro pohon všech kol	<b>TEJ</b>	Pro systém ATE (Alfred Teves) a Jurid
<b>HBA</b>	Brzdový kotouč s vnitřním chlazením pro vozidla bez ABS	<b>NFS</b>	Pro zvláštní model Baccara/Initiale	<b>TEX</b>	Výrobek nebo díl Bosch zaměnitelný za výrobek nebo díl Textar
<b>INB</b>	Brzdový kotouč s vnitřním chlazením	<b>NFS</b>	Ne pro speciální model Baccara/Initiale	<b>THJ</b>	Ne pro vozidla s výbavou TI
<b>INB</b>	Brzdový kotouč bez vnitřního chlazení	<b>NHV</b>	Bez regulace výšky	<b>TKO</b>	Pro vozidla se systémem ovládání pohonu
<b>ITB</b>	Pro brzdový systém ITT	<b>NNC</b>	Pro vozidla s normálním pérováním, ne pro campingové vozidlo	<b>TKO</b>	Pro vozidla bez protipokluzového systému
<b>JUR</b>	Výrobek nebo díl Bosch zaměnitelný za výrobek nebo díl Jurid	<b>NON</b>	Pro vozidla s normálním využitelným zatížením	<b>TLV</b>	Verze Turbo-Look
<b>KL</b>	Pro vozidla s klimatizací	<b>NOR</b>	Normální provedení	<b>TLV</b>	Ne pro verzi Turbo-Look
<b>KL</b>	Pro vozidla bez klimatizace	<b>OAS</b>	Pro vozidla bez ASR (protipokluzová regulace)	<b>TMA</b>	Pro systém ATE (Alfred Teves), vozidla s ABS
<b>KOB</b>	Pro vůz kombi	<b>OAS</b>	Pro vozidla bez ASR (protipokluzová regulace)	<b>TMA</b>	Pro systém ATE (Alfred Teves), vozidla bez ABS
<b>KOM</b>	Vozidlo v provedení kombi s katalyzátorem	<b>OED</b>	Pro vozidla bez elektronické uzávěrky diferenciálu	<b>TNK</b>	Pro jednoznačnou identifikaci čísla Bosch je nutné předložit kartu s údaji vozidla. Komponenty uváděné u výrobku musí být shodné s těmi, které jsou uvedeny na kartě s údaji.
<b>KW</b>	Pro skříňová vozidla	<b>OFD</b>	Pro vozidla bez systému dynamické regulace stability jízdy (FDR)	<b>TR2</b>	Pro bubnové brzdy 200 x 40 mm a brzdovým válcem kola o průměru pístu 17,5 mm
<b>KZB</b>	Státní poznávací značka: modrá	<b>OFS</b>	Pro vozidla bez akt. regulace boč. náklonu	<b>TR0</b>	Ne pro trojpy
<b>KZG</b>	Státní poznávací značka: zelená	<b>OZB</b>	Pro vozidla s jednoduchou montáží pneumatik	<b>TRV</b>	Pro vozidla s bubnovými brzdami vpředu a vzadu
<b>KZR</b>	Státní poznávací značka: červená	<b>PAJ</b>	Pro provedení se soupr. Pandemonium	<b>TRW</b>	Výrobce = TRW
<b>KZU</b>	Státní poznávací značka: šedivá	<b>PAJ</b>	Ne pro provedení se soupr. Pandemonium	<b>TSE</b>	Pro vozidla s výbavou SE
<b>L01</b>	Využitelné zatížení 800 kg	<b>PEO</b>	Pro systém brzd Perrot	<b>TW</b>	Namontovaný výrobek musí být uveden na vozidle nebo na motoru.
<b>L02</b>	Využitelné zatížení 1800 kg	<b>PFN</b>	Ne pro brzdovou soustavu BMW Performance	<b>VAN</b>	Pro VAN
<b>L03</b>	Využitelné zatížení do 1800 kg	<b>PW</b>	Pro valníkový vůz	<b>VEA</b>	Zesílené provedení
<b>L06</b>	Využitelné zatížení 1000 kg	<b>PW</b>	Ne pro valníkový vůz	<b>VFC</b>	Pro vozidla s posíleným pérováním, pro campingové vozidlo
<b>L07</b>	Využitelné zatížení 1400 kg	<b>R30</b>	Pro vozidla s rozchodem kol 3000 mm	<b>VFG</b>	Pro vyztužený podvozek
<b>L10</b>	Délka: 1025 mm	<b>R33</b>	Pro vozidla s rozchodem kol 3350 mm	<b>VLI</b>	Přední, řízení montáž vlevo
<b>L13</b>	Délka: 1345 mm	<b>R35</b>	Pro vozidla s rozchodem kol 3550 mm	<b>VRE</b>	Přední, montáž vpravo
<b>L65</b>	Délka: 650 mm	<b>R37</b>	Pro vozidla s rozchodem kol 3700 mm	<b>VSP</b>	Pro sportovní provedení
<b>LAB</b>	Montáž vlevo	<b>R40</b>	Pro vozidla s rozchodem kol 4025 mm	<b>VSP</b>	Ne pro sportovní provedení
<b>LAU</b>	Pro vozidla s výbavou L	<b>RAB</b>	Montáž vpravo	<b>WAB</b>	Výrobek nebo díl Bosch zaměnitelný za výrobek nebo díl Wabco
<b>LFS</b>	Brzda s kompaktním třmenem Lucas	<b>RBA</b>	Pro vozidla se systémem Bosch-ABS	<b>XLA</b>	Pro vozidla s výbavou XL
<b>LGM</b>	Pro nízký model „grade“	<b>RKR</b>	Pro řízení vpravo s krátkým rozchodem kol	<b>Y61</b>	Průměr brzdového kotouče 340 mm
<b>LGS</b>	Pro limuzínu s mechanickou převodovkou	<b>RLE</b>	Pro řízení na pravé straně	<b>Z15</b>	Průměr 15 palců
<b>LIA</b>	Pro limuzínu s ABS	<b>RSB</b>	Kotoučová brzda s pevným třmenem	<b>ZBR</b>	Pro dvouokruhový brzdový systém
<b>LIM</b>	Pro limuzínu	<b>R25</b>	Brzdový kotouč 256 x 25mm	<b>ZE</b>	Jsou nutné dva
<b>LKR</b>	Pro řízení vlevo s krátkým rozchodem kol	<b>S31</b>	Brzd. kotouč 314 x 25 mm	<b>ZTG</b>	Pro dvoudílný brzdový třmen
<b>LLE</b>	Pro řízení na levé straně	<b>SA</b>	Speciální výbava	<b>ZWB</b>	Pro vozidla s dvojitou montáží kol
<b>LLT</b>	Pro vozidla s levostranným řízením s bubnovými brzdami	<b>SAZ</b>	Sada	<b>ZWZ</b>	Brzdový třmen, 2 písty
<b>LOC</b>	Výrobek nebo díl Bosch zaměnitelný za výrobek nebo díl Lockheed	<b>SBE</b>	Vysoké nároky	<sup>3</sup>	Vpředu
<b>LUC</b>	Výrobek nebo díl Bosch zaměnitelný za výrobek nebo díl Lucas	<b>SBJ</b>	Pro vozidla se sportovními brzdami	<sup>4</sup>	Vzadu
<b>LUX</b>	Luxusní provedení	<b>SBJ</b>	Pro vozidla se sportovními brzdami	<sup>6</sup>	S pístem
<b>LWG</b>	Pro dodávkový vůz	<b>SBJ</b>	Pro vozidla bez sportovních brzd	<sup>7</sup>	Bez pístu
<b>LWG</b>	Ne pro dodávkové vozy	<b>SBR</b>	Pro vozidla s kotoučovými brzdami	<sup>8</sup>	Sada dílů s vodicím pouzdem
<b>LWR</b>	Bez regulace sklonu světel	<b>SCK</b>	Pro závitové připojení	<sup>9</sup>	Bez pístu, s díly ruční brzdy
<b>LXA</b>	Pro vozidla s výbavou LX	<b>SCR</b>	Vozidlo se splyňavou zádí	<sup>U</sup>	S integrovaným regulátorem
<b>MB</b>	Mechanické ovládání	<b>SDK</b>	Standardní kabina		
<b>MBB</b>	Pro brzdový systém Mercedes-Benz	<b>SFZ</b>	Pro speciální vozidla		
		<b>SLX</b>	Pro vozidla s výbavou SLX		
		<b>SP</b>	Sport		
		<b>SPE</b>	Speciální (Combo)		
		<b>SPF</b>	Sportovní pérování		
		<b>SPN</b>	Ne pro vozidla se sportovním pérováním		
		<b>SPT</b>	Varianta výbavy: SPORT		





Objednací číslo



Zadní náprava



Zvláštní případ



Osobní vozidlo



Informace/vysvětlení



Datum/období montáže



Osobní vozidlo/malá dodávka



Série



Číslo podvozku



Rozměry



Brzdový válec kola



Výkon motoru v kW



Třmen kotoučové brzdy vpravo



Brzdový třmen



Výměnný díl Bosch



Lano ruční brzdy



Snímač otáček



Porovnání



Odkaz na stránky



Odkaz na stránku



Průměr



Přední náprava



<b>09Z</b>	Для автомобилей с диаметром тормозного диска 9 дюймов	<b>4DB</b>	Для дисков с 4 отверстиями, автомобили без ABS, системы Bosch и Bendix	<b>B38</b>	Для скобы тормозного механизма с поршнем диаметром 38 мм
<b>10Z</b>	Для автомобилей с диаметром тормозного диска 10 дюймов	<b>4-K</b>	для 4-х канальной системы	<b>B41</b>	Для скобы тормозного механизма с поршнем диаметром 41 мм
<b>14Z</b>	диаметр обода 14 дюймов	<b>4LO</b>	четырёхдырочный обод	<b>B59</b>	Тормозной диск 259 x 20 мм
<b>15Z</b>	Для диаметра диска 15 дюймов	<b>4SB</b>	Для автомобилей с дисковыми тормозными механизмами сзади	<b>B80</b>	Система Bosch 8.0
<b>165</b>	Для диаметра диска 16,5 дюймов	<b>4TO</b>	для автомобилей с 4-мя сплошными торсионами	<b>B81</b>	Система Bosch 8.1
<b>16R</b>	В случае 16 - 18-дюймовых колес	<b>5LO</b>	пятидырочный обод	<b>BAS</b>	Для системы Bosch и автомобилей с ABS
<b>16Z</b>	Для диаметра диска 16 дюймов	<b>5SP</b>	Для автомобилей с 5 посадочными местами	<b>BAS</b>	Для системы Bosch и автомобилей без ABS
<b>19D</b>	Диаметр 190 мм	<b>6LO</b>	Диск с 6 отверстиями	<b>BDE</b>	Для Bendix Испания (BENDIBERICA)
<b>1KD</b>	Диск тормозного механизма, задний 226 x 10 мм для четырехдырочного обода, не с красной скобой тормозного механизма	<b>7SP</b>	Для автомобилей с 7 посадочными местами	<b>BDS</b>	С поворотным сиденьем
<b>1KP</b>	Диск тормозного механизма, задний 226 x 10 мм для четырехдырочного обода, с красной скобой тормозного механизма	<b>82Z</b>	Диаметр тормозного барабана 228 мм	<b>BDS</b>	Без поворотного сидения
<b>1KX</b>	Тормозной диск 313 x 26 мм	<b>AA</b>	Привод на все колеса	<b>BEL</b>	Крепление пятидырочное
<b>1LA</b>	Диск тормозного механизма 239 x 10 мм	<b>AA</b>	без привода на все колеса	<b>BES</b>	Крепление с болтами
<b>1LM</b>	Диск тормозного механизма 239 x 12 мм	<b>ABM</b>	соблюдать размеры	<b>BHO</b>	для автомобилей официальных учреждений
<b>1LQ</b>	Диск тормозного механизма 268 x 10 мм	<b>ABO</b>	для автомобилей без антиблокировочного устройства	<b>BHO</b>	Не для ведомственных автомобилей
<b>1LV</b>	Диск тормозного механизма 280 x 22 мм для обода с 4-мя отверстиями, с не красным суппортом	<b>ABS</b>	для автомобилей с антиблокировочным устройством	<b>BKR</b>	для автомобилей с регулятором тормозного усилия
<b>1LW</b>	Диск тормозного механизма 280 x 22 мм для обода с 4-мя отверстиями, с красным суппортом	<b>ADE</b>	Для автомобилей с оснащением: S, Active, Dynamic, Emotion, Class	<b>BKR</b>	для автомобилей без регулятора тормозного усилия
<b>1LY</b>	Диск тормозного механизма 256 x 20 мм	<b>AEL</b>	Для автомобилей с EL-комплектацией	<b>BKV</b>	для автомобилей с усилителем тормозного усилия
<b>20R</b>	В случае 20-дюймовых колес	<b>AFS</b>	Для автомобилей с активным регулированием поперечного крена	<b>BKV</b>	для автомобилей без усилителя тормозного усилия
<b>21Z</b>	Тормозной диск 255 x 12 мм	<b>AG</b>	для автомобилей с автоматической коробкой скоростей	<b>BLA</b>	Исполнение черного цвета
<b>226</b>	Диаметр тормозного диска 226 мм	<b>AGH</b>	Для алюминиевого корпуса	<b>BO</b>	Bosch, только в качестве замены оснащения фирмы Bosch
<b>228</b>	Тормозной диск 280 x 22 мм	<b>AGT</b>	Исполнение GT	<b>BRB</b>	Для системы Brembo
<b>23Z</b>	Тормозной диск 232 x 9 мм	<b>AIO</b>	для автомобилей без антиблокировочного устройства и без внутренне вентилируемых дисковых тормозов	<b>BSB</b>	Суппорты с тормозными колодками
<b>238</b>	Диаметр тормозного диска 238 мм	<b>ALE</b>	Не для автомобилей с рулевым управлением со всеми направляющими колёсами	<b>BSB</b>	Суппорт дискового колесного тормозного механизма без накладок дискового тормоза
<b>239</b>	Диск тормозного механизма 239 x 20 мм	<b>ALR</b>	Для автомобилей с автоматической регулировкой угла наклона фар	<b>BSC</b>	Корпус скобы тормозного механизма, окрашенный в черный цвет
<b>245</b>	Тормозной диск 245 x 10 мм	<b>ALR</b>	Для автомобилей без автоматической коррекции угла наклона фар	<b>BSR</b>	Корпус суппорта тормоза лакирован в красный цвет
<b>25Z</b>	Тормозной диск 256 x 22 мм	<b>AMI</b>	Для транспортных средств с противоблокировочным устройством и вентилируемым диском	<b>BSR</b>	Корпус суппорта тормоза не лакирован в красный цвет
<b>254</b>	диаметр 25,4 мм	<b>AMI</b>	для автомобилей с антиблокировочным устройством без внутреннего вентилирования тормозных дисков	<b>BSY</b>	Для тормозной системы Bosch
<b>256</b>	Диск тормозного механизма 256 x 12 мм	<b>AMJ</b>	Для исполнения Мото	<b>BUS</b>	для автобуса / магистрали
<b>257</b>	Диаметр тормозного диска 257 мм	<b>AMJ</b>	Не для исполнения Мото	<b>CA</b>	Кабриолет
<b>268</b>	Диаметр тормозного диска 268 мм	<b>AOA</b>	для автомобилей с автоматической коробкой скоростей, без антиблокировочного устройства	<b>CSA</b>	Изделие можно также заказать он-лайн "www.partbob.com"
<b>278</b>	Диаметр тормозного диска 278 мм	<b>AOS</b>	для автомобилей с антиблокировочным устройством, без регулирования привода ведущих колес	<b>D53</b>	Диаметр тормозного диска 253 мм
<b>281</b>	Тормозной диск 282 x 18 мм	<b>APG</b>	Для AMG Performance Package	<b>D77</b>	Диаметр 17,78 мм
<b>284</b>	Тормозной диск 280 x 24 мм	<b>ASR</b>	Для автомобилей с ASR (системой предотвращения буксования ведущих колес)	<b>D84</b>	Диаметр тормозного диска 284 мм
<b>288</b>	Тормозной диск 288 x 25 мм	<b>ATE</b>	Для системы ATE (Teves)	<b>D85</b>	Диаметр тормозного диска 285 мм
<b>29Z</b>	Диаметр тормозного диска: 292 мм	<b>ATJ</b>	Для осуществления буксировки	<b>DMO</b>	взаимозаменяемый продукт фирмы Bosch или деталь для фирмы Delco Moraine
<b>294</b>	Диаметр тормозного диска 294 мм	<b>ATN</b>	Не для осуществления буксировки	<b>DOP</b>	Двухместная кабина
<b>295</b>	Диаметр тормозного барабана 295 мм	<b>ATP</b>	Для автомобилей с техническим пакетом AMG	<b>DRK</b>	Датчик числа оборотов/подшипник колеса-комбинация
<b>2TO</b>	для автомобилей с 2-мя сплошными торсионами	<b>ATP</b>	Для автомобилей без технического пакета AMG	<b>EAL</b>	Для автомобилей, оснащенных электронным активным рулевым управлением
<b>30Z</b>	Диаметр диска тормозного механизма 302 мм	<b>B17</b>	Для диаметра диска 17 дюймов	<b>EAL</b>	Для автомобилей, не имеющих электронного активного рулевого управления
<b>305</b>	Диаметр диска тормозного механизма 305 мм	<b>B18</b>	Для диаметра диска 18 дюймов	<b>EBR</b>	одноконтурная тормозная система
<b>308</b>	Диаметр тормозного диска 308 мм	<b>B25</b>	Тормозной диск 259 x 12 мм	<b>EDS</b>	Для автомобилей с системой EDS (электронная блокировка дифференциала)
<b>30R</b>	Для автомобилей с базой 3050 мм	<b>B34</b>	Для суппорта дискового тормоза с диаметром поршня 34 мм	<b>EFV</b>	Также замена для предшественника
<b>31Z</b>	Диаметр торм.диска 312 мм			<b>EIZ</b>	Суппорт тормозного механизма, 1 поршень
<b>31D</b>	Диаметр тормозного диска 315 мм			<b>EMA</b>	Идентичное изделие Bosch или деталь для Mando
<b>321</b>	Тормозной диск 321 x 30 мм			<b>ERH</b>	Для автомобилей с повышенной полезной нагрузкой
<b>32Z</b>	Тормозной диск 314 x 22 мм				
<b>326</b>	Тормозной диск 300 x 26 мм				
<b>33Z</b>	Диаметр тормозного диска 332 мм				
<b>336</b>	Диаметр тормозного диска 336 мм				
<b>34Z</b>	Тормозной диск 347 x 30 мм				
<b>3LO</b>	трехдырочный обод				
<b>375</b>	Для автомобилей с допустимой полной массой 3,5 т				
<b>45Z</b>	Диаметр тормозного барабана 254 мм				





<b>ETG</b>	для цельного суппорта дискового колесного тормозного механизма	<b>HRS</b>	Для автомобилей с дисковым тормозным механизмом, сзади, справа	<b>MFD</b>	для автомобилей с регулировкой динамики движения (РДД)
<b>EU4</b>	Для автомобилей с нормой токсичности OГ Euro 4	<b>HSA</b>	Для автомобилей с коробкой передач с ручным управлением и ABS	<b>MI</b>	середина
<b>EU5</b>	Для автомобилей с нормой токсичности OГ Euro 5	<b>HTB</b>	Для автомобилей с барабанным тормозом сзади	<b>MIH</b>	с держателем
<b>EZK</b>	Для автомобилей с одиночной кабиной	<b>IBA</b>	внутривентилируемый тормозной диск для автомобилей без ABS	<b>MIH</b>	без держателя
<b>FAN</b>	Ходовая часть, стандартное исполнение	<b>INB</b>	внутривентилируемый тормозной диск	<b>MOJ</b>	Для модели Monster
<b>FBD</b>	Эквивалентное изделие Bosch или деталь для Bendix	<b>INB</b>	Тормозной диск без внутренней вентиляции	<b>MOJ</b>	Не для модели Monster
<b>FDO</b>	взаимозаменяемый продукт фирмы Bosch или деталь для фирмы Ferodo	<b>ITB</b>	Для тормозной системы ИТТ	<b>MTG</b>	С демпфирующим грузом
<b>FEB</b>	Для электронного стояночного тормоза	<b>JUR</b>	взаимозаменяемый продукт фирмы Bosch или деталь для фирмы Jurid	<b>MTG</b>	Без демпфирующего груза
<b>FEB</b>	Не для электронного стояночного тормоза	<b>KL</b>	для автомобилей с кондиционером	<b>MVB</b>	Для автомобилей с индикатором износа накладок тормозных колодок
<b>FEN</b>	Для автомобилей с обычным подрессориванием	<b>KL</b>	для автомобилей без кондиционера	<b>MVB</b>	Для автомобилей без индикатора износа накладок тормозных колодок
<b>FEV</b>	Для автомобилей с усиленным подрессориванием	<b>KOB</b>	для автомобиля комби	<b>MZH</b>	с двумя фиксаторами
<b>FGS</b>	Для шасси	<b>KOM</b>	автомобиль с кузовом универсал с катализатором	<b>NAA</b>	Не для привода на все колеса
<b>FGS</b>	Не для шасси	<b>KW</b>	для автомобилей-фургонов	<b>NFS</b>	Для специальной модели Vaccara/Initiale
<b>FHL</b>	Для автомобилей с оснащением HL	<b>KZB</b>	номерной знак: синий	<b>NFS</b>	не для специальной модели Vaccara/Initiale
<b>FKR</b>	для автомобилей с короткой базой	<b>KZG</b>	номерной знак: зеленый	<b>NHV</b>	без регулирования дорожного просвета
<b>FLR</b>	для автомобилей с длинной базой	<b>KZR</b>	номерной знак: красный	<b>NNC</b>	Для автомобилей с обычным подрессориванием, не для автомобилей для туризма
<b>FMR</b>	Для автомобилей со средней базой	<b>KZU</b>	номерной знак: серый	<b>NON</b>	Для автомобилей с обычной полезной нагрузкой
<b>FMS</b>	Для автомобилей со специальной защитой (бронированный)	<b>L01</b>	полезная нагрузка 800 кг	<b>NOR</b>	Обычное исполнение
<b>FMS</b>	Для автомобилей без специальной защиты (небронированный)	<b>L02</b>	полезная нагрузка 1800 кг	<b>OAS</b>	Для автомобилей без ASR (система предотвращения буксования ведущих колес)
<b>FMU</b>	Для автомобилей с защитным брусом	<b>L03</b>	полезная нагрузка менее 1800 кг	<b>OED</b>	Для автомобилей без электронной блокировки дифференциала
<b>FMU</b>	Для автомобилей без защитного бруса	<b>L06</b>	полезная нагрузка 1000 кг	<b>OFD</b>	для автомобилей без регулировки динамики движения (РДД)
<b>FPA</b>	Для автомобилей с парковочным ассистентом	<b>L07</b>	Полезная нагрузка 1400 кг	<b>OFS</b>	Для автомобилей без активного регулирования поперечного крена
<b>FPA</b>	Для автомобилей без парковочного ассистента	<b>L10</b>	Длина: 1025 мм	<b>OZB</b>	Для автомобилей с индивидуальными шинами
<b>FSB</b>	тормозной механизм с плавающей скобой	<b>L13</b>	Длина: 1345 мм	<b>PAJ</b>	Для модели с Pandemonium Kit
<b>G10</b>	Соединительная резьба M10 x 1	<b>L65</b>	Длина: 650 мм	<b>PAJ</b>	Не для модели с Pandemonium Kit
<b>GBM</b>	Для автомобилей с регулировкой дистанции	<b>LAB</b>	встроенная слева	<b>PEO</b>	Для тормозной системы Perrot
<b>GBM</b>	Для автомобилей без регулировки дистанции	<b>LAU</b>	Для автомобилей с оборудованием L	<b>PFN</b>	Не для тормозной системы BMW Performance
<b>GEM</b>	Металлический корпус	<b>LFS</b>	тормозной механизм с плавающей скобой марки Lucas	<b>PW</b>	для грузового автомобиля с бортовой платформой
<b>GIM</b>	взаимозаменяемый продукт фирмы Bosch или деталь для фирмы Lucas-Girling, автомобили с антиблокировочным устройством	<b>LGM</b>	Для низкой модели "grade"	<b>PW</b>	Не для грузовых автомобилей с открытой платформой
<b>GIM</b>	взаимозаменяемый продукт фирмы Bosch или деталь для фирмы Lucas-Girling, автомобили без антиблокировочного устройства	<b>LGS</b>	для лимузинов со ступенчатой коробкой передач	<b>R30</b>	для автомобилей с базой 3000 mm
<b>GIR</b>	взаимозаменяемый продукт фирмы Bosch или деталь для фирмы Lucas-Girling	<b>LIA</b>	для лимузинов с антиблокировочным устройством	<b>R33</b>	Для автомобилей с базой 3350 мм
<b>GLA</b>	исполнение GL	<b>LIM</b>	Для лимузинов	<b>R35</b>	для автомобилей с базой 3550 mm
<b>GRF</b>	базовое исполнение	<b>LKR</b>	Для автомобилей с левым рулем с короткой базой	<b>R37</b>	Для автомобилей с базой 3700 мм
<b>GS</b>	для автомобилей с коробкой передач с ручным управлением	<b>LLE</b>	для автомобилей с левосторонним расположением рулевого колеса	<b>R40</b>	для автомобилей с базой 4025 mm
<b>GSI</b>	исполнение GSi	<b>LLT</b>	Для автомобилей с левосторонним расположением рулевого управления и барабанным тормозным механизмом	<b>RAB</b>	встроенная справа
<b>GSO</b>	Для автомобилей без вспомогательной системы аварийного торможения	<b>LOC</b>	взаимозаменяемый продукт фирмы Bosch или деталь для фирмы Lockheed	<b>RBA</b>	для автомобилей с антиблокировочным устройством Bosch
<b>GXA</b>	Для автомобилей с пакетом оснащения GX	<b>LUC</b>	взаимозаменяемый продукт фирмы Bosch или деталь для фирмы Lucas	<b>RKR</b>	Для автомобилей с правым рулем с короткой базой
<b>HO1</b>	Закрепит. втулка 2 261 024 304 доставлена и обменена	<b>LUX</b>	исполнение "люкс"	<b>RLE</b>	для автомобилей с правосторонним расположением рулевого колеса
<b>HAК</b>	для автомобилей с коробкой передач с ручным управлением, без антиблокировочного устройства и кондиционера	<b>LWG</b>	для автомобилей для перевозки мелкопартийных грузов	<b>RSB</b>	рамный опорный тормоз
<b>HLI</b>	Задний, встроенный слева	<b>LWG</b>	не для автомобилей для перевозки мелкопартийных грузов	<b>S25</b>	Диск тормозного механизма 256 X 25мм
<b>HLS</b>	Для автомобилей с дисковым тормозным механизмом, сзади, слева	<b>LWR</b>	Без электрической регулировки дальности освещения	<b>S31</b>	Тормозной диск 314 x 25 мм
<b>HOA</b>	для автомобилей с коробкой передач с ручным управлением, без антиблокировочного устройства	<b>LXA</b>	Для автомобилей с пакетом оснащения LX	<b>SA</b>	специальное оборудование
<b>HRE</b>	Задний, встроенный справа	<b>MB</b>	механическое приведение в действие	<b>SAZ</b>	комплект
		<b>MBB</b>	Для тормозной системы Mercedes-Benz	<b>SBE</b>	большая нагрузка
		<b>MEH</b>	с фиксатором	<b>SBJ</b>	Для автомобилей со спортивной тормозной системой
		<b>MET</b>	Для автомобилей с ETS и ASR	<b>SBJ</b>	Для автомобилей без спортивной тормозной системы
		<b>MEF</b>	Для автомобилей без ETS и ASR	<b>SBR</b>	Для автомобилей с дисковым тормозом
				<b>SCK</b>	Для винтового присоединения



<b>SCR</b>	наклонная задняя часть кузова
<b>SDK</b>	стандартная кабина
<b>SFZ</b>	для специальных автомобилей
<b>SLX</b>	Для автомобилей с пакетом оснащения SLX
<b>SP</b>	спорт
<b>SPE</b>	специальный (комбо)
<b>SPF</b>	спортивная рессорная подвеска
<b>SPN</b>	не для автомобилей с спортивным поддрессориванием
<b>SPT</b>	Вариант исполнения: SPORT
<b>SSB</b>	Плавающая скоба тормоза
<b>SSZ</b>	Для плохого состояния дорог
<b>SSZ</b>	Не для плохого состояния дорог
<b>STB</b>	Для автомобилей с дисковым тормозом спереди и барабанным тормозом сзади
<b>STK</b>	Для разъема
<b>STU</b>	форма задней части кузова
<b>SVN</b>	Полоса движения не расширяется
<b>SVN</b>	Полоса движения расширяется
<b>T06</b>	Для барабанного тормозного механизма 203 x 38 мм и колесного тормозного цилиндра с диаметром поршня 20,6 мм
<b>T26</b>	Диаметр тормозного барабана 260 мм
<b>TA</b>	Для такси
<b>FA</b>	Не для такси
<b>TBR</b>	Для автомобилей с барабанным тормозом
<b>TEF</b>	Для систем ATE (Alfred Teves) и Ferodo

<b>TEJ</b>	Для систем ATE (Alfred Teves) и Jurid
<b>TEX</b>	взаимозаменяемый продукт фирмы Bosch или деталь для фирмы Textar
<b>THJ</b>	Не для автомобилей с оснащением TI
<b>TKO</b>	для автомобилей с контролем силы тяги
<b>TKO</b>	Для автомобилей без контроля тягового усилия
<b>TLV</b>	турболодобенная версия
<b>TLV</b>	Не для версии Turbo-Look
<b>TMA</b>	Для системы ATE (Teves), а/м с ABS
<b>TMA</b>	Для системы ATE (Teves), а/м без ABS
<b>TNK</b>	Для однозначной идентификации № Bosch требуется карта данных автомобиля. Компоненты, установленные в изделия, должны совпадать с компонентами карты данных.
<b>TR2</b>	Для барабанных тормозов 200 x 40 мм и цилиндра гидравлического тормозного привода колеса с диаметром плунжера 17,5 мм
<b>TRR</b>	Не для тропического климата
<b>TRV</b>	Для автомобилей с барабанным тормозом спереди и сзади
<b>TRW</b>	Производитель = TRW
<b>TSE</b>	Для автомобилей с оборудованием приемопередатчи
<b>TW</b>	Встроенное издание должно определяться в автомобиле или двигателе.
<b>VAN</b>	Для VAN
<b>VEA</b>	усиленное исполнение

<b>VFC</b>	Для автомобилей с усиленным поддрессориванием, для автомобилей для туризма
<b>VFG</b>	для усиленного шасси
<b>VLI</b>	Передний, встроенный слева
<b>VRE</b>	Передний, встроенный справа
<b>VSP</b>	Для спортивной конструкции
<b>VSP</b>	Не для спортивных конструкций
<b>WAB</b>	взаимозаменяемый продукт фирмы Bosch или деталь для фирмы Wabco
<b>XLA</b>	Для автомобилей с оборудованием XL
<b>Y61</b>	Диаметр тормозного диска 340 мм
<b>Z15</b>	диаметр 15 дюймов
<b>ZBR</b>	для двухконтурного тормозного устройства
<b>ZE</b>	необходимо два
<b>ZTG</b>	для суппорта дискового колесного тормозного механизма из двух частей
<b>ZWB</b>	Для автомобилей со сдвоенными шинами
<b>ZWZ</b>	Суппорт тормозного механизма, 2 поршня
<sup>3</sup>	Вперед
<sup>4</sup>	Сзади
<sup>6</sup>	С поршнем
<sup>7</sup>	Без поршня
<sup>8</sup>	Комплект запчастей с направляющими гильзами
<sup>9</sup>	Без поршня, с деталями ручного тормоза
<sup>U</sup>	С интегрированным регулятором

	Номер для заказа
	Особый случай
	Информация / Пояснение
	Дата / Период сборки
	Легковой автомобиль / малый автомобиль-фургон
	Серия
	Номер шасси
	Масса
	Колесный тормозной цилиндр
	Мощность двигателя в кВт

	Суппорт тормоза правый
	Суппорт дискового колесного тормозного механизма
	Восстановленная деталь Bosch
	Трос ручного тормоза
	Датчик числа оборотов
	Сравнение
	Сторонняя ссылка
	Ссылка на страницу
	Диаметр
	Передняя ось

	Задняя ось
	Легковой автомобиль





**de**

Bosch bietet ein innovatives Bremsen-Komplettprogramm.

Beste Voraussetzungen für Handel und Werkstatt gewährleisten:

- ▶ Hohe Marktabdeckung mit über 10.000 Produkten
- ▶ Abgestimmte Diagnose- und Prüftechnik
- ▶ Umfassende Verkaufsunterstützung

**en**

Bosch offers a complete program of innovative brake systems.

Aftermarket resellers and service centers are able to enjoy maximum benefits based on:

- ▶ high levels of market coverage, with over 10,000 products
- ▶ coordinated diagnostic and testing technology
- ▶ comprehensive sales support

**fr**

Bosch propose une gamme de freins complète et innovante.

Pour le revendeur et le garagiste, les meilleures conditions sont remplies grâce à:

- ▶ une couverture élevée du marché assurée par plus de 10.000 produits
- ▶ un matériel de diagnostic et de contrôle adapté
- ▶ une assistance commerciale complète

**it**

Bosch offre un innovativo programma completo per freni.

I migliori presupposti per l'aftermarket e l'officina sono garantiti da:

- ▶ Elevata copertura del mercato con oltre 10.000 prodotti
- ▶ Tecnica di prova e di diagnosi su misura
- ▶ Ampio supporto alla vendita

**es**

Bosch ofrece un innovador programa completo de frenos.

Garantía de las mejores condiciones para el distribuidor y el taller:

- ▶ Alta cobertura de mercado con más de 10.000 referencias.
- ▶ Técnica coordinada de diagnóstico y comprobación
- ▶ Amplio apoyo comercial

**nl**

Bosch biedt een innovatief en compleet remprogramma.

De beste voorwaarden voor handel en garages garanderen:

- ▶ Een hoge marktdekking met meer dan 10.000 producten
- ▶ Een hierop afgestemde diagnose- en testtechniek
- ▶ Een uitgebreide verkoopondersteuning

**sv**

Bosch erbjuder ett innovativt bromskomplettprogram.

De bästa förutsättningarna för handel och verkstad garanterar:

- ▶ Hög marknadstäckning med över 10.000 produkter
- ▶ Avstämde diagnos- och testteknik
- ▶ Omfattande säljstöd

**pt**

A inovadora gama de travões da Bosch.

Garantia dos melhores requisitos para o comércio e oficinas:

- ▶ Elevada cobertura do mercado com mais de 10.000 produtos
- ▶ Tecnologia de diagnóstico e de teste comprovada
- ▶ Suporte de vendas abrangente

**cs**

Bosch nabízí inovativní kompletní brzdový program.

Jsou zaručeny nejlepší předpoklady pro obchod a servis:

- ▶ Vysoké pokrytí trhu více než 10000 produkty
- ▶ Přizpůsobená diagnostika a zkušební technika
- ▶ Rozsáhlá podporaprodaje

**ru**

Bosch предлагает инновационную полную программу тормозных систем.

Наилучшие условия для торговых партнеров и станций техобслуживания обеспечиваются за счет:

- ▶ высокой степени удовлетворения спроса на рынке благодаря наличию более 10.000 изделий
- ▶ согласованного диагностического и испытательного оборудования
- ▶ всесторонней поддержке продаж

**nl**

**Veilige diagnose. Tijdbesparende reparatie. Bosch-Diagnostics en reserveonderdelen.**

**sv**

**Säker diagnos. Tidsbesparande reparation. Bosch Diagnostics och reservdelar.**

**pt**

**Diagnóstico seguro. Reparação rápida. Bosch Diagnostics e peças sobressalentes.**

**cs**

**Bezpečná diagnostika. Časově úsporná oprava. Bosch Diagnostics a náhradní díly.**

**ru**

**Надежная диагностика. Ремонт с выигрышем во времени. Диагностика и запасные части Bosch.**



Alles uit één hand. Bosch biedt de werkplaats een volledig programma voor verbetering van de efficiëntie en kwaliteit in het dagelijkse werk. Van de wereldwijd actieve ontwikkelaar en toonaangevende fabrikant van systeemtechniek voor voertuigen komen de reserve onderdelen in bekende originele kwaliteit. Competentie en kwaliteit – voor de toekomst van uw werkplaats.

Allt från samma ställe. Bosch kan erbjuda verkstaden ett komplett program som ökar arbetets effektivitet och kvalitet. Reservdelarna i originalkvalitet kommer från globalt aktiva utvecklare och ledande tillverkare av fordonssystemteknik. Kompetens och kvalitet – för er verkstads framtid.

Tudo do mesmo fornecedor. A Bosch oferece às oficinas um programa completo para aumentar a eficiência e a qualidade do trabalho diário. As peças sobressalentes são fornecidas, com a reconhecida qualidade original, pelo principal fabricante de tecnologia automóvel, que desenvolve os seus projectos em todo o mundo. Competência e qualidade – para o futuro da sua oficina.

Vše z jedné ruky. Bosch nabízí servisu kompletní program pro zvýšení účinnosti a kvality při každodenní práci. Celosvětově aktivní firma v oblasti vývoje a výroby systémové techniky pro vozidla dodává náhradní díly ve známe originální kvalitě. Kompetence a kvalita pro budoucnost vašeho servisu.

Все из одних рук. Bosch предлагает автосервисам полную программу для повышения эффективности и качества ежедневной работы. Действующий по всему миру разработчик и ведущий производитель автомобильного оборудования поставляет запасные части оригинального качества. Компетентность и качество – для будущего Вашего автосервиса.